

UT 6-TMC M 5A - Thermomagnetic device circuit breaker

0916607

<https://www.phoenixcontact.com/pc/products/0916607>

Please be informed that the data shown in this PDF document is generated from our online catalog. Please find the complete data in the user documentation. Our general terms of use for downloads are valid.

Thermal-magnetic circuit breaker, 1-pos., for DIN rail mounting



Your advantages

- Simple feed-in due to bridging capability using CLIPLINE complete accessories
- High system availability, thanks to easy resetting
- Quick and easy identification with large-area marking options
- The right device for every application, thanks to a nominal current range of 0.5 to 16 A
- Space savings of 30 % compared to miniature circuit breakers owing to the compact width of 12.3 mm

Commercial data

Item number	0916607
Packing unit	6 pc
Minimum order quantity	1 pc
Product key	CLA122
Catalog page	Page 394 (C-4-2019)
GTIN	4046356449038
Weight per piece (including packing)	63.6 g
Weight per piece (excluding packing)	63.6 g
Customs tariff number	85362010
Country of origin	CZ

UT 6-TMC M 5A - Thermomagnetic device circuit breaker



0916607

<https://www.phoenixcontact.com/pc/products/0916607>

Technical data

Product properties

Product type	Thermomagnetic device circuit breakers
Product family	UT 6-TMC
Type	DIN rail module, one-piece
Number of positions	1
Number of connections	2
Number of rows	1
No. of channels	1
Potentials	1

Insulation characteristics

Overvoltage category	II
Degree of pollution	2

Electrical properties

Fuse type	Automatic device
Maximum power dissipation for nominal condition	≤ 1.4 VA

General

Operating voltage	50 V AC ... 264 V AC (48 - 62 Hz)
	5 V DC ... 30.8 V DC
Rated voltage	240 V AC (50/60 Hz)
	28 V DC
	240 V AC (50/60 Hz)
	28 V DC
Rated insulation voltage U_i	440 V AC
Rated current I_N	5 A
Rated surge voltage	2.8 kV
Insulation resistance R_{iso}	> 100 M Ω (main contact)
Type of actuation	S type
Tripping method	TM (thermomagnetic)
Tripping level	Trip-free mechanism (positive)
Device resistance	55.8 m Ω
Required backup fuse	20 A
Rated short-circuit switching capacity I_{cn}	200 A (240 V AC)
	400 A (28 V DC)
Dielectric strength	2000 V
Switching cycles, max.	6000 (at $1 \times I_n$)
	50 (at $1.5 \times I_n$)
	40 (at $6 \times I_n$)
Fuse	M1 (normal blow)
Power dissipation	≤ 1.4 VA

UT 6-TMC M 5A - Thermomagnetic device circuit breaker



0916607

<https://www.phoenixcontact.com/pc/products/0916607>

Temperature derating	3.85 A DC (at -30 °C)
	4.05 A DC (at -20 °C)
	4.2 A DC (at -10 °C)
	4.35 A DC (at 0 °C)
	4.5 A DC (at 10 °C)
	5 A DC (at 23 °C)
	5.15 A DC (at 30 °C)
	5.4 A DC (at 40 °C)
	5.75 A DC (at 50 °C)
	6.25 A DC (at 60 °C)

Indicator/remote signaling

Connection name	Auxiliary contact
-----------------	-------------------

Connection data

Nominal cross section	6.00 mm ²
Rated cross section AWG	8
Connection method	Screw connection

Level 1 above 1 below 1

Screw thread	M4
Tightening torque	1.5 ... 1.8 Nm
Stripping length	12 mm
Conductor cross section rigid	0.2 mm ² ... 10 mm ²
Cross section AWG	24 ... 8 (converted acc. to IEC)
Conductor cross section flexible	0.2 mm ² ... 10 mm ²
Conductor cross section, flexible [AWG]	24 ... 8 (converted acc. to IEC)
Conductor cross-section flexible (ferrule without plastic sleeve)	0.25 mm ² ... 6 mm ²
Flexible conductor cross section (ferrule with plastic sleeve)	0.25 mm ² ... 6 mm ²
2 conductors with same cross section, solid	0.2 mm ² ... 2.5 mm ²
2 conductors with same cross section, flexible	0.2 mm ² ... 2.5 mm ²
2 conductors with same cross section, flexible, with ferrule without plastic sleeve	0.25 mm ² ... 1.5 mm ²
2 conductors with the same cross section, flexible, with TWIN ferrule with plastic sleeve	0.5 mm ² ... 4 mm ²
Nominal current	5 A
Nominal voltage	240 V AC
	28 V DC
Nominal cross section	6 mm ²

Main contact

Connection method	Screw connection
Screw thread	M4
Tightening torque	1.5 Nm ... 1.8 Nm
Stripping length	12 mm
Conductor cross section flexible	0.2 mm ² ... 10 mm ²

UT 6-TMC M 5A - Thermomagnetic device circuit breaker



0916607

<https://www.phoenixcontact.com/pc/products/0916607>

Conductor cross section rigid	0.2 mm ² ... 10 mm ²
Conductor cross section AWG	24 ... 8
Conductor cross section, flexible, with ferrule, with plastic sleeve	0.25 mm ² ... 6 mm ²
Conductor cross section flexible, with ferrule without plastic sleeve	0.25 mm ² ... 6 mm ²

Dimensions

Width	12.3 mm
Height	85.5 mm
Depth	89.5 mm

Material specifications

Color	gray (RAL 7042)
Flammability rating according to UL 94	V-0
Insulating material	PA66

Mechanical properties

Mechanical data

Open side panel	No
-----------------	----

Environmental and real-life conditions

Ambient conditions

Degree of protection	IP40 (Actuation area) IP20 (Connection area)
Ambient temperature (operation)	-30 °C ... 60 °C
Altitude	2000 m (acc. to EN 60934)

Standards and regulations

Standards/specifications	EN 60934
Standards/specifications	UL 1077
Standards/specifications	CSA 22.2
Note	No. 235
Standards/specifications	EAC

Mounting

Mounting type	DIN rail: 35 mm
---------------	-----------------

UT 6-TMC M 5A - Thermomagnetic device circuit breaker

0916607

<https://www.phoenixcontact.com/pc/products/0916607>

Drawings

Diagram

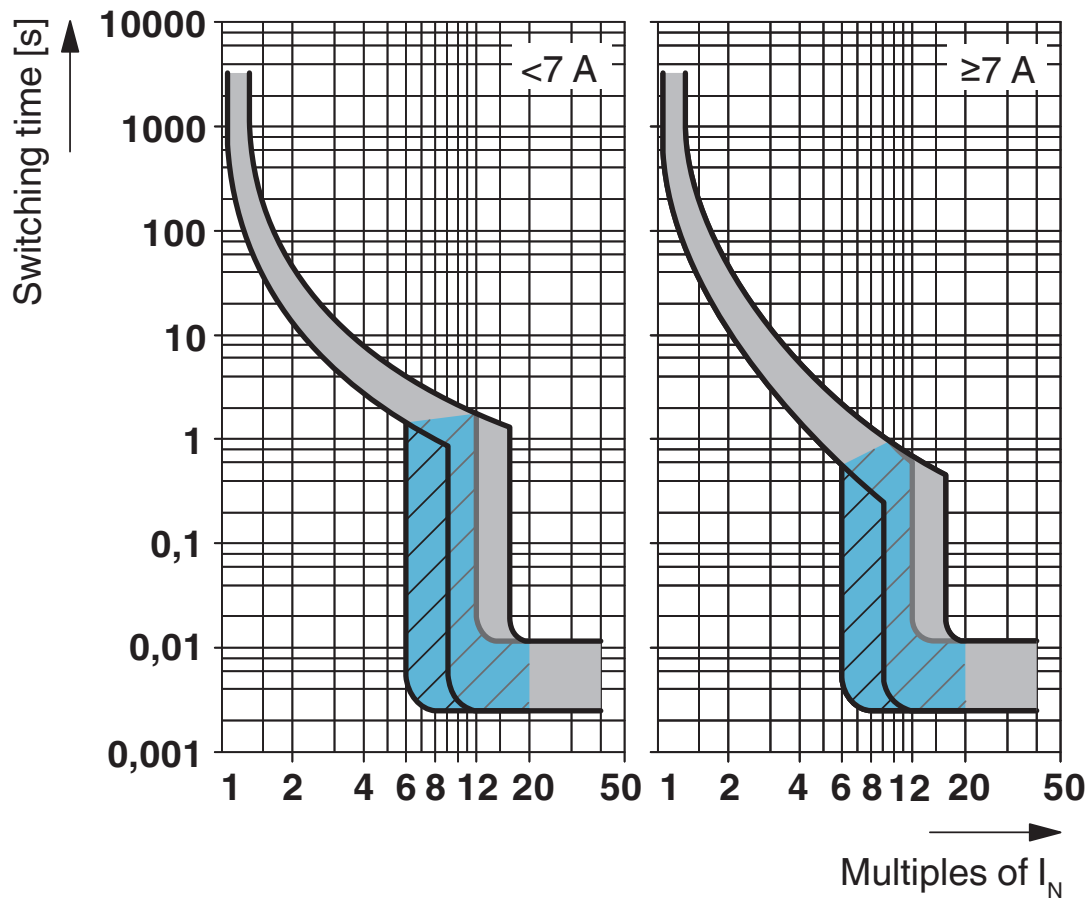

Trigger characteristic

UT 6-TMC M 5A - Thermomagnetic device circuit breaker

0916607

<https://www.phoenixcontact.com/pc/products/0916607>

Block diagram

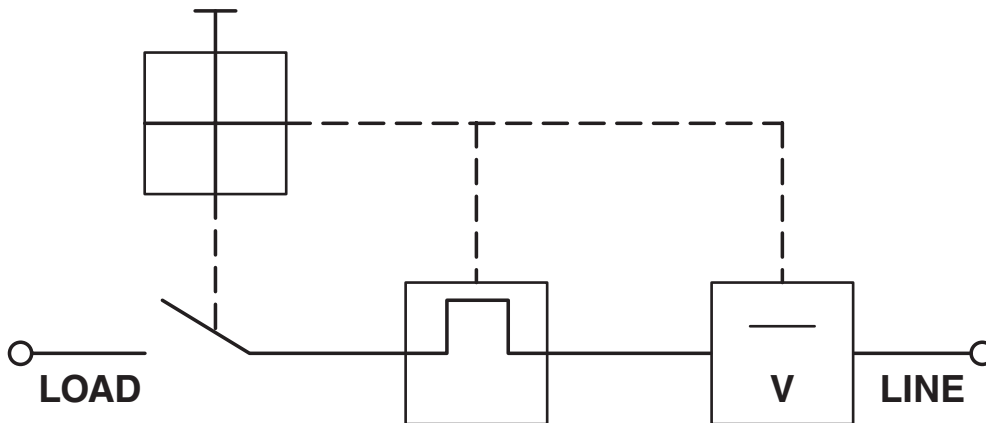

Application drawing

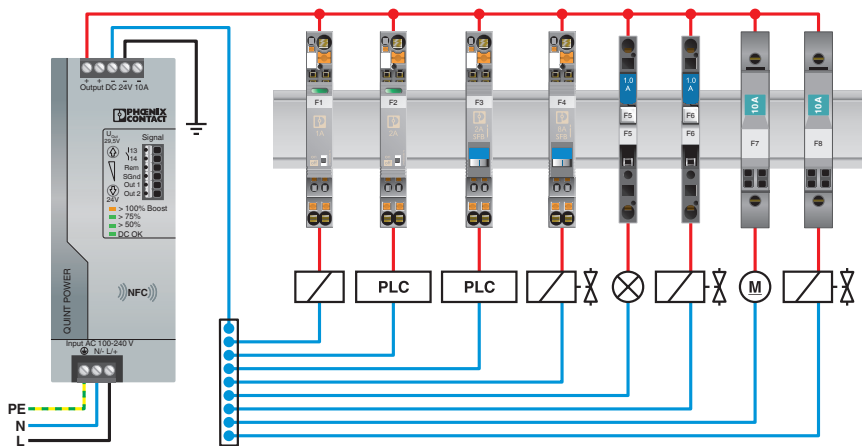

UT 6-TMC M 5A - Thermomagnetic device circuit breaker

0916607

<https://www.phoenixcontact.com/pc/products/0916607>

Application drawing

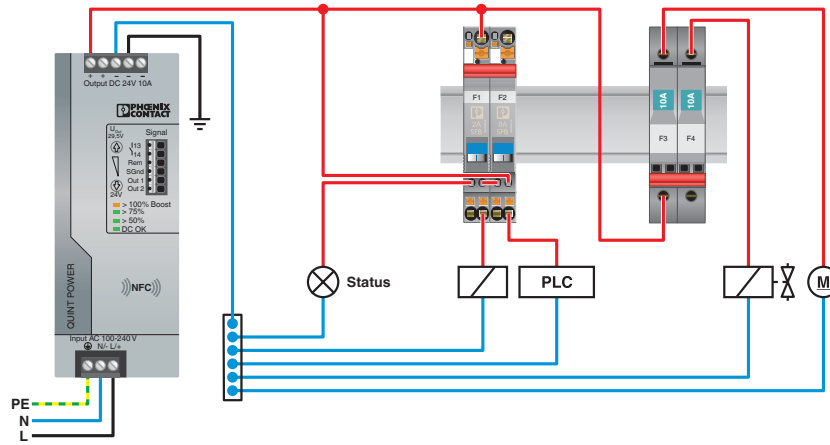

UT 6-TMC M 5A - Thermomagnetic device circuit breaker



0916607

<https://www.phoenixcontact.com/pc/products/0916607>

Approvals

To download certificates, visit the product detail page: <https://www.phoenixcontact.com/pc/products/0916607>



cUL Recognized
Approval ID: FILE E 140459



UL Recognized
Approval ID: FILE E 140459



EAC
Approval ID: EAC-Zulassung



EAC
Approval ID: RU C-DE.A*30.B01546



VDE Zeichengenehmigung
Approval ID: 40028127



CSA
Approval ID: 250505



KC
Approval ID: SW05013-15001

cULus Recognized

UT 6-TMC M 5A - Thermomagnetic device circuit breaker



0916607

<https://www.phoenixcontact.com/pc/products/0916607>

Classifications

ECLASS

ECLASS-11.0	27141116
ECLASS-12.0	27141116
ECLASS-13.0	27140401

ETIM

ETIM 9.0	EC000899
----------	----------

UNSPSC

UNSPSC 21.0	39121400
-------------	----------

UT 6-TMC M 5A - Thermomagnetic device circuit breaker



0916607

<https://www.phoenixcontact.com/pc/products/0916607>

Environmental product compliance

EU RoHS

Fulfills EU RoHS substance requirements	Yes
Exemption	6(c)

China RoHS

Environment friendly use period (EFUP)	EFUP-50
	An article-related China RoHS declaration table can be found in the download area for the respective article under "Manufacturer declaration". For all articles with EFUP-E, no China RoHS declaration table issued and required.

EU REACH SVHC

REACH candidate substance (CAS No.)	Lead(CAS: 7439-92-1)
-------------------------------------	----------------------

Phoenix Contact 2024 © - all rights reserved

<https://www.phoenixcontact.com>

PHOENIX CONTACT GmbH & Co. KG

Flachsmarktstraße 8

D-32825 Blomberg

+49 (0) 5235-3 00

info@phoenixcontact.com