

SAC-4P-M12MS/20,0-547/M12FS BK - Sensor/actuator cable



1425121

<https://www.phoenixcontact.com/us/products/1425121>

Please be informed that the data shown in this PDF document is generated from our online catalog. Please find the complete data in the user documentation. Our general terms of use for downloads are valid.



Sensor/actuator cable, 4-position, PVC, yellow, Plug straight M12, coding: A, on Socket straight M12, coding: A, cable length: 20 m

Commercial data

Item number	1425121
Packing unit	1 pc
Minimum order quantity	1 pc
Note	Made to order (non-returnable)
Sales key	BF13
Product key	BF11FB
GTIN	4055626402499
Weight per piece (including packing)	1,250 g
Weight per piece (excluding packing)	1,313 g
Customs tariff number	85444290
Country of origin	US

SAC-4P-M12MS/20,0-547/M12FS BK - Sensor/actuator cable



1425121

<https://www.phoenixcontact.com/us/products/1425121>

Technical data

Product properties

Product type	Sensor/actuator cable
Number of positions	4
Application	Standard, U.S. cables
No. of cable outlets	1
Shielded	no
Coding	A

Insulation characteristics

Overvoltage category	II
Degree of pollution	3

Material specifications

Flammability rating according to UL 94	HB
Seal material	NBR
Material of grip body	TPU, hardly inflammable, self-extinguishing
Contact material	CuSn
Contact surface material	Ni/Au
Contact carrier material	TPU GF
Material for screw connection	Zinc die-cast, nickel-plated
Outer sheath, material	PVC

Electrical properties

Insulation resistance	$\geq 10 \text{ M}\Omega$
Nominal voltage U_N	250 V AC
	250 V DC
Nominal current I_N	4 A
Protective circuit	unwired

Signaling

Status display	No
Status display present	No

Connection data

Conductor connection

Tightening torque	0.4 Nm (M12 connector)
-------------------	------------------------

Connector

Connection 1

Type	Plug straight M12
Number of positions	4

SAC-4P-M12MS/20,0-547/M12FS BK - Sensor/actuator cable



1425121

<https://www.phoenixcontact.com/us/products/1425121>

Coding type	A
-------------	---

Connection 2

Type	Socket straight M12
Number of positions	4
Coding type	A

Cable/line

Cable length	20 m
--------------	------

PVC AWG 18 yellow 105°C [547]

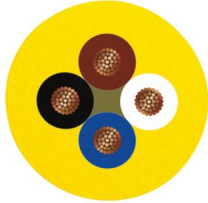
Dimensional drawing	
UL AWM Style	2517 (105 °C / 300 V)
Number of positions	4
Shielded	no
Cable type	PVC AWG 18 yellow 105°C [547]
Conductor structure signal line	41x 0.16 mm
AWG signal line	18
Wire diameter incl. insulation	1.7 mm ±0.03 mm
External cable diameter	6.00 mm ±0.2 mm
Outer sheath, material	PVC
External sheath, color	yellow
Conductor material	Tin-plated Cu litz wires
Material wire insulation	PVC
Single wire, color	brown, white, blue, black
Overall twist	4 wires, twisted
Nominal voltage, cable	300 V
Minimum bending radius, fixed installation	8 x D
Smallest bending radius, fixed installation	48 mm
Flame resistance	FT4
Special properties	C(UL) CMX OUTDOOR-CMG 105 °C UL ITC/PLTC 105 °C CSA AWM I/II A/B FT4 105 °C / 300 V
Ambient temperature (operation)	-30 °C ... 105 °C (cable, fixed installation)

Environmental and real-life conditions

Ambient conditions

SAC-4P-M12MS/20,0-547/M12FS BK - Sensor/actuator cable



1425121

<https://www.phoenixcontact.com/us/products/1425121>

Degree of protection	IP65
	IP67
	IP68
Ambient temperature (operation)	-25 °C ... 90 °C (Plug / socket)

Standards and regulations

Standard designation	M12 connector
Standards/specifications	IEC 61076-2-101

SAC-4P-M12MS/20,0-547/M12FS BK - Sensor/actuator cable



1425121

<https://www.phoenixcontact.com/us/products/1425121>

Drawings

Schematic diagram

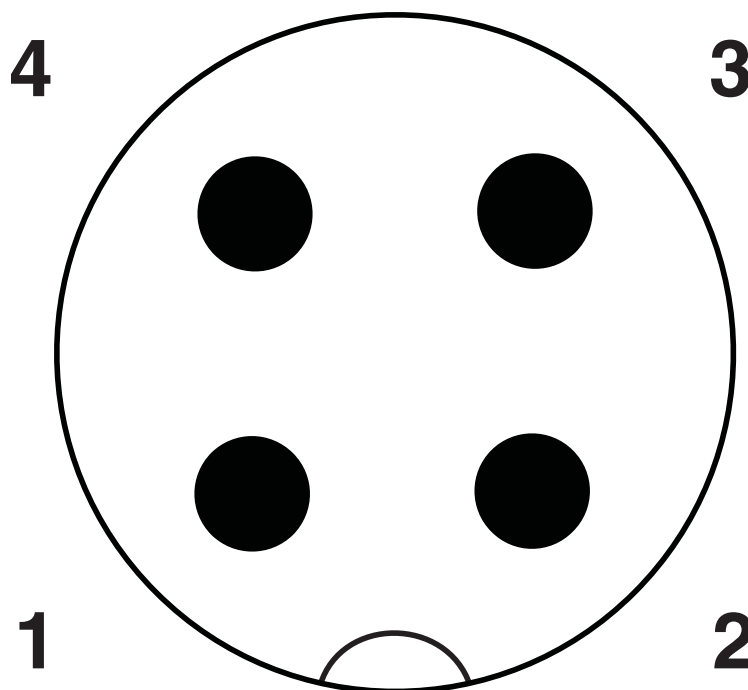

Pin assignment M12 plug, 4-pos., A-coded, view plug side

SAC-4P-M12MS/20,0-547/M12FS BK - Sensor/actuator cable



1425121

<https://www.phoenixcontact.com/us/products/1425121>

Dimensional drawing

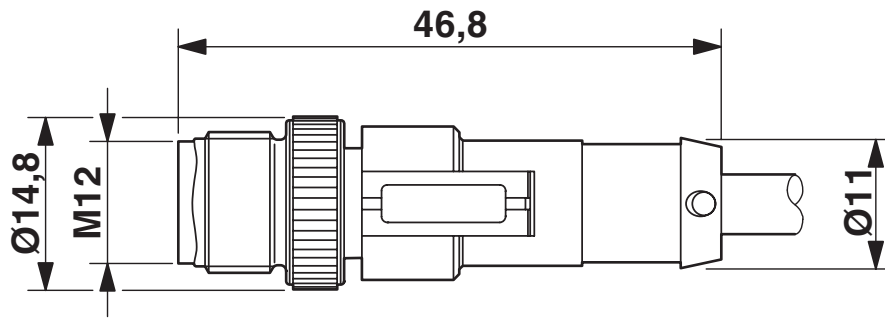

Plug, M12 x 1, straight, shielded

Circuit diagram

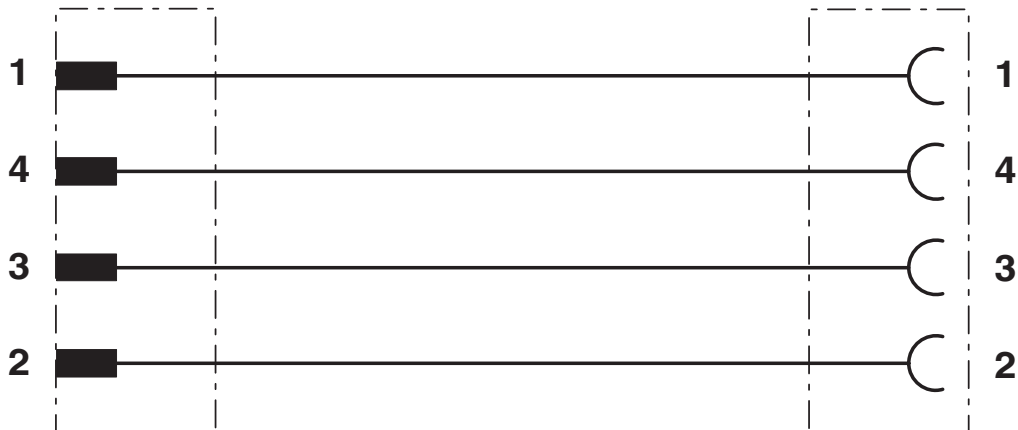

SAC-4P-M12MS/20,0-547/M12FS BK - Sensor/actuator cable

1425121

<https://www.phoenixcontact.com/us/products/1425121>

Dimensional drawing

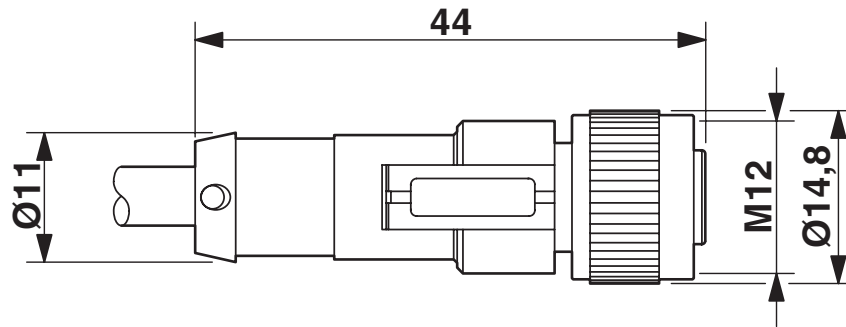

M12 x 1 socket, straight

Schematic diagram

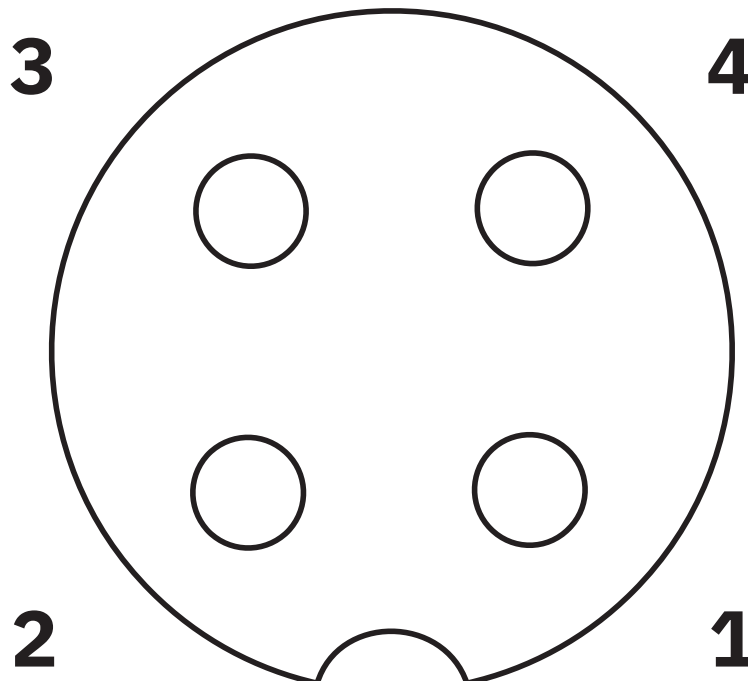

Pin assignment M12 socket, 4-pos., A-coded, view female side

SAC-4P-M12MS/20,0-547/M12FS BK - Sensor/actuator cable





1425121

<https://www.phoenixcontact.com/us/products/1425121>

Approvals

To download certificates, visit the product detail page: <https://www.phoenixcontact.com/us/products/1425121>

 UL Listed Approval ID: FILE E 221474				
	Nominal voltage U_N	Nominal current I_N	Cross section AWG	Cross section mm^2
	300 V	4 A	-	-

 cUL Listed Approval ID: FILE E 221474				
	Nominal voltage U_N	Nominal current I_N	Cross section AWG	Cross section mm^2
	300 V	4 A	-	-

 EAC-RoHS Approval ID: RU D-DE.HB35.B.00387	
---	--

cULus Listed

SAC-4P-M12MS/20,0-547/M12FS BK - Sensor/actuator cable



1425121

<https://www.phoenixcontact.com/us/products/1425121>

Classifications

ECLASS

ECLASS-11.0	27060311
ECLASS-12.0	27060311
ECLASS-13.0	27060311

ETIM

ETIM 8.0	EC001855
----------	----------

UNSPSC

UNSPSC 21.0	26121600
-------------	----------

SAC-4P-M12MS/20,0-547/M12FS BK - Sensor/actuator cable



1425121

<https://www.phoenixcontact.com/us/products/1425121>

Environmental product compliance

China RoHS	Environmentally Friendly Use Period = 50 years For information on hazardous substances, refer to the manufacturer's declaration available under "Downloads"
------------	--

Phoenix Contact 2024 © - all rights reserved
<https://www.phoenixcontact.com>

Phoenix Contact USA
586 Fulling Mill Road
Middletown, PA 17057, United States
(+717) 944-1300
info@phoenixcon.com