

ST-17P1N8A8004 - Cable connector



1607626

<https://www.phoenixcontact.com/us/products/1607626>

Please be informed that the data shown in this PDF document is generated from our online catalog. Please find the complete data in the user documentation. Our general terms of use for downloads are valid.



Cable connector, straight, Screw locking mechanism, M17, number of positions: 17, contact connection type: Pin, shielded: yes, degree of protection: IP67, cable diameter range: 8 mm ... 10 mm, number of positions: 17, connection method: Crimp connection, series: ST, Alternative product in accordance with RoHS II without Exemption 6c (Pb < 0.1 %) item no.: 1242318

Your advantages

- Consistent EMC protection for reliable connection solutions in the industrial environment
- Crimping connection: vibration- and temperature-resistant assembly
- Flexible use: reliably connect various cable diameters
- Molded designs with preassembled cables on one or both sides

Commercial data

Item number	1607626
Packing unit	1 pc
Minimum order quantity	1 pc
Sales key	AB31
Product key	ABRACA
Catalog page	Page 66 (C-2-2019)
GTIN	4046356273374
Weight per piece (including packing)	64.647 g
Weight per piece (excluding packing)	28.41 g
Customs tariff number	85366990
Country of origin	DE

Technical data

Notes

Order information:	Order crimp contacts Ø 0.6 mm separately
--------------------	--

Safety note

Safety note	<p>WARNING: The connectors may not be plugged in or disconnected under load. Ignoring the warning or improper use may damage persons and/or property.</p>
	<ul style="list-style-type: none"> • WARNING: Commission properly functioning products only. The products must be regularly inspected for damage. Decommission defective products immediately. Replace damaged products. Repairs are not possible.
	<ul style="list-style-type: none"> • WARNING: Only electrically qualified personnel may install and operate the product. They must observe the following safety notes. The qualified personnel must be familiar with the basics of electrical engineering. They must be able to recognize and prevent danger. The relevant symbol on the packaging indicates that only personnel familiar with electrical engineering are allowed to install and operate the product.
	<ul style="list-style-type: none"> • The products are suitable for applications in plant, controller, and electrical device engineering.
	<ul style="list-style-type: none"> • When operating the connectors in outdoor applications, they must be separately protected against environmental influences.
	<ul style="list-style-type: none"> • Assembled products may not be manipulated or improperly opened.
	<ul style="list-style-type: none"> • Only use mating connectors that are specified in the technical data of the standards listed (e.g. the ones listed in the product accessories online at phoenixcontact.com/products).
	<ul style="list-style-type: none"> • When using the product in direct connection with third-party manufacturers, the user is responsible.
	<ul style="list-style-type: none"> • For operating voltages > 50 V AC, conductive connector housings must be grounded
	<ul style="list-style-type: none"> • Ensure that the protective or functional ground has been properly connected.
	<ul style="list-style-type: none"> • VDE 0100/1.97 § 411.1.3.2 and DIN EN 60 204/11.98 § 14.1.3 are applicable when combining several circuits in a cable and/or connector
	<ul style="list-style-type: none"> • Only use tools recommended by Phoenix Contact
	<ul style="list-style-type: none"> • The installation notes/Design In documents online on the download page at phoenixcontact.com/products must be observed for this product.
	<ul style="list-style-type: none"> • Operate the connector only when it is fully plugged in and interlocked.
<ul style="list-style-type: none"> • Ensure that when laying the cable, the tensile load on the connectors does not exceed the upper limit specified in the standards. 	
<ul style="list-style-type: none"> • Observe the minimum bending radius of the cable. Lay the cable without twisting it. 	
<ul style="list-style-type: none"> • The connector warms up in normal operation. Depending on the ambient conditions, the surface of the connector can continue to warm up. In this case, the user is responsible for posting 	

ST-17P1N8A8004 - Cable connector



1607626

<https://www.phoenixcontact.com/us/products/1607626>

warnings (e.g. DIN EN ISO 13732-1:2008-12).

Product properties

Product type	Circular connector (cable-side)
Series	ST
Application	Feedback, signal Signal
Number of positions	17
Connection profile	17
Shielded	yes
Coding	N
Thread type	M17

Data management status

Article revision	07
------------------	----

Material specifications

Seal material	FPM
Housing material	Metal
Housing material	Turned parts: copper zinc alloy (CuZn), die-cast parts: zinc (GD-Zn)
Insulator material	PA 6.6
Gasket and O-ring material	FPM

Connection data

Conductor connection

Connection method	Crimp connection
-------------------	------------------

Electrical properties

Contact

Contact diameter	0.6 mm
Max. current	3.6 A
Nominal voltage U_N	48 V AC 74 V DC
Overvoltage category	III
Degree of pollution	3
Rated surge voltage	1.5 kV

Connector

Type	straight
Direction of rotation	Standard

Cable/line

External cable diameter	8 mm ... 10 mm
-------------------------	----------------

Environmental and real-life conditions

ST-17P1N8A8004 - Cable connector



1607626

<https://www.phoenixcontact.com/us/products/1607626>

Ambient conditions

Degree of protection	IP67
Ambient temperature (operation)	-40 °C ... 125 °C
Ambient temperature (storage/transport)	15 °C ... 25 °C
Altitude	3000 m
Permissible humidity (storage/transport)	50 % ... 65 %

ST-17P1N8A8004 - Cable connector



1607626

<https://www.phoenixcontact.com/us/products/1607626>

Drawings

Diagram

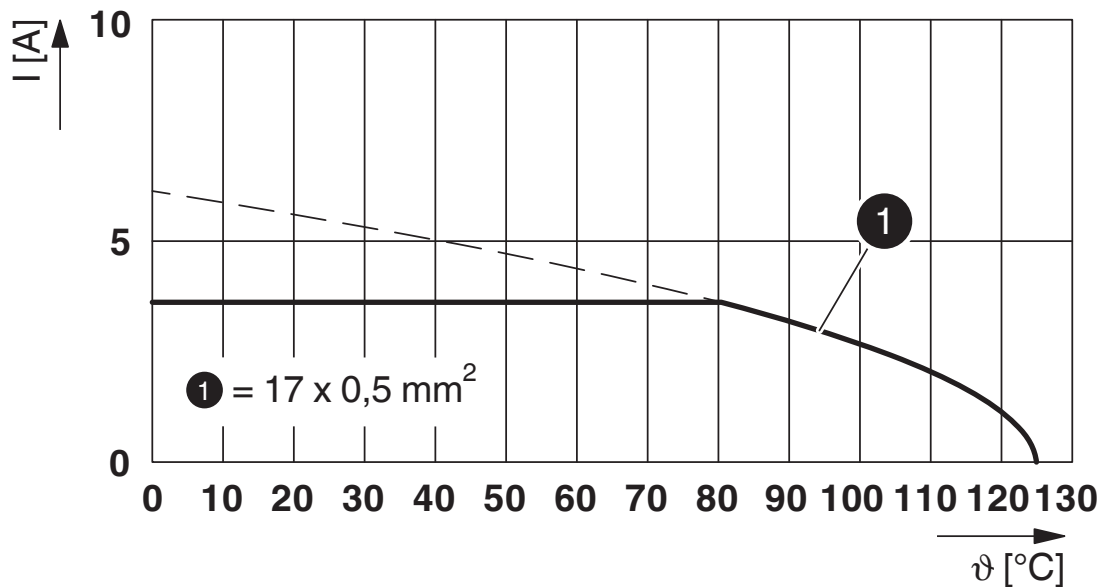

I = current strength, ϑ = ambient temperature, 17x 3.6 A

Schematic diagram

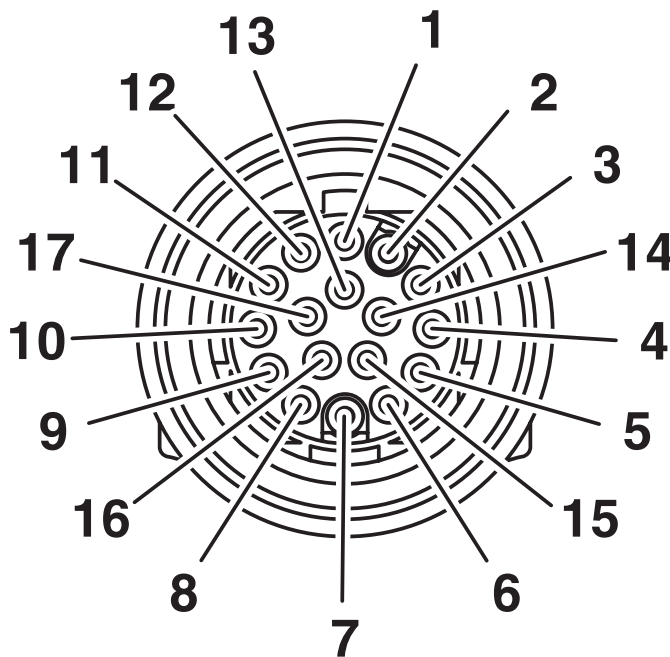

Connector pin assignment

ST-17P1N8A8004 - Cable connector

1607626

<https://www.phoenixcontact.com/us/products/1607626>



Dimensional drawing

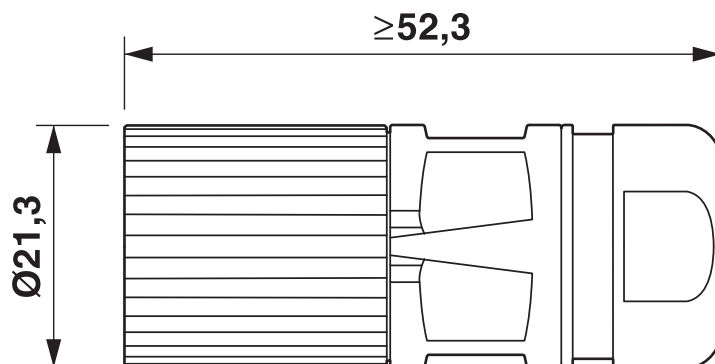

Technical drawings can be found under Downloads

ST-17P1N8A8004 - Cable connector





1607626

<https://www.phoenixcontact.com/us/products/1607626>

Approvals

To download certificates, visit the product detail page: <https://www.phoenixcontact.com/us/products/1607626>

 cUL Recognized Approval ID: E335019-20111129				
	Nominal voltage U_N	Nominal current I_N	Cross section AWG	Cross section mm^2
	48 V	1 A	- 26	-

 UL Recognized Approval ID: E335019-20111129				
	Nominal voltage U_N	Nominal current I_N	Cross section AWG	Cross section mm^2
	48 V	1 A	- 26	-

 UL Recognized Approval ID: E153698-20140124				
	Nominal voltage U_N	Nominal current I_N	Cross section AWG	Cross section mm^2
	48 V	1 A	-	-

 cUL Recognized Approval ID: E153698-20140124				
	Nominal voltage U_N	Nominal current I_N	Cross section AWG	Cross section mm^2
	48 V	1 A	-	-

ST-17P1N8A8004 - Cable connector



1607626

<https://www.phoenixcontact.com/us/products/1607626>

Classifications

ECLASS

ECLASS-11.0	27440102
ECLASS-12.0	27440116
ECLASS-13.0	27440116

ETIM

ETIM 9.0	EC002635
----------	----------

UNSPSC

UNSPSC 21.0	39121400
-------------	----------

ST-17P1N8A8004 - Cable connector



1607626

<https://www.phoenixcontact.com/us/products/1607626>

Environmental product compliance

EU RoHS

Fulfills EU RoHS substance requirements	Yes
Exemption	6(c)

China RoHS

Environment friendly use period (EFUP)	EFUP-50
	An article-related China RoHS declaration table can be found in the download area for the respective article under "Manufacturer declaration". For all articles with EFUP-E, no China RoHS declaration table issued and required.

EU REACH SVHC

REACH candidate substance (CAS No.)	Lead(CAS: 7439-92-1)
SCIP	f258ffe7-a674-426b-a34d-3eda91a51cb4

ST-17P1N8A8004 - Cable connector



1607626

<https://www.phoenixcontact.com/us/products/1607626>

Accessories

ST-06KP010 - Crimp contact

1607577

<https://www.phoenixcontact.com/us/products/1607577>



Crimp contact, Pin, turned, contact diameter: 0.6 mm, crimp range: 0.06 mm² ... 0.25 mm², Alternative product in accordance with RoHS II without Exemption 6c (Pb < 0.1 %) item no.: 1242311

ST-06KP020 - Crimp contact

1607578

<https://www.phoenixcontact.com/us/products/1607578>



Crimp contact, Pin, turned, contact diameter: 0.6 mm, crimp range: 0.14 mm² ... 0.34 mm², Alternative product in accordance with RoHS II without Exemption 6c (Pb < 0.1 %) item no.: 1242311

ST-17P1N8A8004 - Cable connector

1607626

<https://www.phoenixcontact.com/us/products/1607626>



ST-06KP030 - Crimp contact

1607579

<https://www.phoenixcontact.com/us/products/1607579>



Crimp contact, Pin, turned, contact diameter: 0.6 mm, crimp range: 0.34 mm² ... 0.5 mm², Alternative product in accordance with RoHS II without Exemption 6c (Pb < 0.1 %) item no.: 1242312

ST-Z0016 - Color coding

1617993

<https://www.phoenixcontact.com/us/products/1617993>

Color coding, color: green



ST-17P1N8A8004 - Cable connector

1607626

<https://www.phoenixcontact.com/us/products/1607626>



ST-Z0017 - Color coding

1618049

<https://www.phoenixcontact.com/us/products/1618049>

Color coding, color: orange

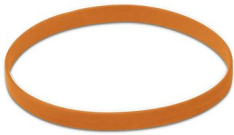

ST-Z0018 - Color coding

1618050

<https://www.phoenixcontact.com/us/products/1618050>

Color coding, color: black



ST-17P1N8A8004 - Cable connector

1607626

<https://www.phoenixcontact.com/us/products/1607626>



ST-Z0002 - Square mounting flange with O-ring

1607771

<https://www.phoenixcontact.com/us/products/1607771>



Square mounting flange with O-ring, Axial O-ring, 4x Ø2,7, series: ST

ST-Z0077 - Metal protective cap

1627217

<https://www.phoenixcontact.com/us/products/1627217>



Metal protective cap, degree of protection: IP67, series: ST, Alternative product in accordance with RoHS II without Exemption 6c (Pb < 0.1 %) item no.: 1245441

ST-17P1N8A8004 - Cable connector

1607626

<https://www.phoenixcontact.com/us/products/1607626>



ST-Z0003 - Square mounting flange with O-ring

1607772

<https://www.phoenixcontact.com/us/products/1607772>



Square mounting flange with O-ring, Axial O-ring, 4xM3, series: ST

ST-Z0004 - Square mounting flange

1607773

<https://www.phoenixcontact.com/us/products/1607773>



Square mounting flange, 4x Ø2,7, series: ST

ST-17P1N8A8004 - Cable connector

1607626

<https://www.phoenixcontact.com/us/products/1607626>



ST-Z0005 - Square mounting flange

1607775

<https://www.phoenixcontact.com/us/products/1607775>

Square mounting flange, 4xM3, series: ST



PROT-M17PRO-IT-IP20 - Plastic protective cap

1055709

<https://www.phoenixcontact.com/us/products/1055709>

Plastic protective cap, M17, degree of protection: IP20, series: M17 PRO



Phoenix Contact 2024 © - all rights reserved
<https://www.phoenixcontact.com>

Phoenix Contact USA
586 Fulling Mill Road
Middletown, PA 17057, United States
(+717) 944-1300
info@phoenixcon.com