

SAC-3P-M12Y/2X3,0-PUR/M 8FS - Sensor/actuator cable



1671360

<https://www.phoenixcontact.com/in/products/1671360>

Please be informed that the data shown in this PDF document is generated from our online catalog. Please find the complete data in the user documentation. Our general terms of use for downloads are valid.



Sensor/actuator cable, 3-position, PUR halogen-free, black-gray RAL 7021, Plug straight M12, coding: A, on Socket straight M8, coding: A and Socket straight M8, coding: A, cable length: 3 m

Commercial data

Item number	1671360
Packing unit	1 pc
Minimum order quantity	1 pc
Sales key	BF1
Product key	BF1COA
Catalog page	Page 250 (C-2-2019)
GTIN	4017918135195
Weight per piece (including packing)	129.12 g
Weight per piece (excluding packing)	123.6 g
Customs tariff number	85444290
Country of origin	PL

SAC-3P-M12Y/2X3,0-PUR/M 8FS - Sensor/actuator cable



1671360

<https://www.phoenixcontact.com/in/products/1671360>

Technical data

Product properties

Product type	Distributor with cable
Number of positions	3
Application	Standard
No. of cable outlets	2
Shielded	no
Coding	A

Insulation characteristics

Overvoltage category	II
Degree of pollution	3

Connection data

Tightening torque	0.4 Nm (M12 connector)
	0.2 Nm (M8 connectors)

Material specifications

Flammability rating according to UL 94	HB
Contact material	CuSn
Contact surface material	Ni/Au
Contact carrier material	TPU
Material for screw connection	Zinc die-cast, nickel-plated

Electrical properties

Contact resistance	$\leq 5 \text{ m}\Omega$
Insulation resistance	$\geq 100 \text{ M}\Omega$
Nominal voltage U_N	48 V AC
	60 V DC
Nominal current I_N	4 A

Mechanical properties

Mechanical data

Insertion/withdrawal cycles	≥ 100
-----------------------------	------------

Signaling

Status display	No
Status display present	No

Connector

Connection 1

Type	Plug straight M12
------	-------------------

SAC-3P-M12Y/2X3,0-PUR/M 8FS - Sensor/actuator cable



1671360

<https://www.phoenixcontact.com/in/products/1671360>

Coding type	A
-------------	---

Connection 2

Type	Socket straight M8
Coding type	A

Connection 3

Type	Socket straight M8
Coding type	A

Cable/line

Cable length	3 m
--------------	-----

PUR halogen-free black [PUR]

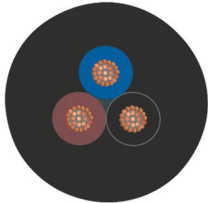
Dimensional drawing	
Cable weight	18 kg/km
UL AWM Style	20549 / 10493 (80°C/300 V)
Number of positions	3
Shielded	no
Cable type	PUR halogen-free black [PUR]
Conductor structure signal line	32x 0.10 mm
AWG signal line	24
Conductor cross section	3x 0.25 mm ² (Signal line)
Wire diameter incl. insulation	1.17 mm ±0.02 mm
External cable diameter	3.60 mm ±0.15 mm
Outer sheath, material	PUR
External sheath, color	black-gray RAL 7021
Conductor material	Bare Cu litz wires
Material wire insulation	PP
Single wire, color	brown, blue, black
Thickness, insulation	≥ 0.21 mm (Core insulation)
Thickness, outer sheath	approx. 0.50 mm
Overall twist	3 wires, twisted
Length of twist, overall twist	40 mm
Max. conductor resistance	≤ 78 Ω/km (at 20 °C)
Insulation resistance	≥ 100 GΩ*km (at 20 °C)
Nominal voltage, cable	≤ 300 V
Test voltage	≥ 3000 V

SAC-3P-M12Y/2X3,0-PUR/M 8FS - Sensor/actuator cable



1671360

<https://www.phoenixcontact.com/in/products/1671360>

Smallest bending radius, fixed installation	18 mm
Smallest bending radius, movable installation	36 mm
Max. bending cycles	10000000
Halogen-free	in accordance with DIN VDE 0472 part 815
Flame resistance	in accordance with UL 758/1581 FT2 DIN EN 60332-2-2 (20 s)
Resistance to oil	in accordance with DIN EN 60811-2-1
Other resistance	hydrolysis and microbe resistant Highly resistant to acids, alkaline solutions and solvents Resistant to salt water partly UV-resistant (in accordance with DIN EN ISO 4892-2-A)
Special properties	Flexible cable conduit capable Silicone-free Free of substances which would hinder coating with paint or varnish
Ambient temperature (operation)	-40 °C ... 80 °C (cable, fixed installation) -25 °C ... 80 °C (Cable, flexible installation)

Environmental and real-life conditions

Ambient conditions

Degree of protection	IP65 IP67 IP68
Ambient temperature (operation)	-25 °C ... 90 °C (Plug / socket) -40 °C ... 80 °C (cable, fixed installation) -5 °C ... 80 °C (Cable, flexible installation)

Standards and regulations

Standard designation	M12 connector
Standards/specifications	IEC 61076-2-101
Standard designation	M8 connector
Standards/specifications	IEC 61076-2-104

SAC-3P-M12Y/2X3,0-PUR/M 8FS - Sensor/actuator cable

1671360

<https://www.phoenixcontact.com/in/products/1671360>

Drawings

Dimensional drawing



Plug M12 x 1, Y distributor

SAC-3P-M12Y/2X3,0-PUR/M 8FS - Sensor/actuator cable

1671360

<https://www.phoenixcontact.com/in/products/1671360>

Schematic diagram



Pin assignment M12 Y plug, 4-pos., A-coded, view plug side

SAC-3P-M12Y/2X3,0-PUR/M 8FS - Sensor/actuator cable

1671360

<https://www.phoenixcontact.com/in/products/1671360>

Schematic diagram

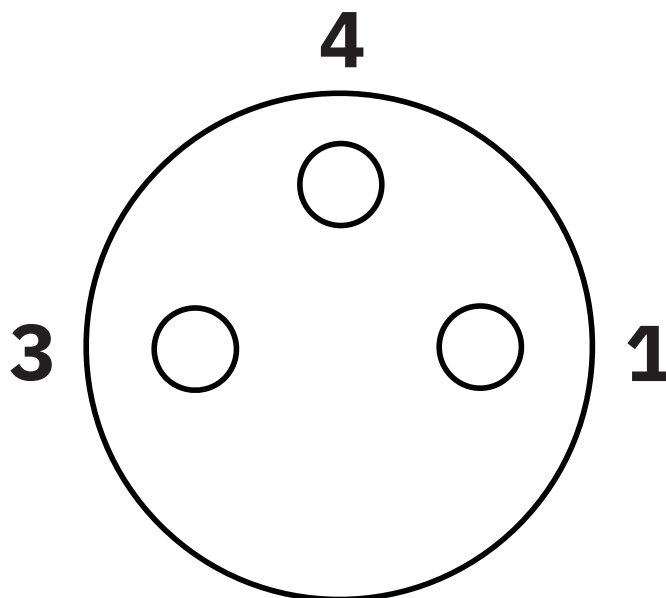

Pin assignment M8 socket, 3-pos., view female side

Dimensional drawing

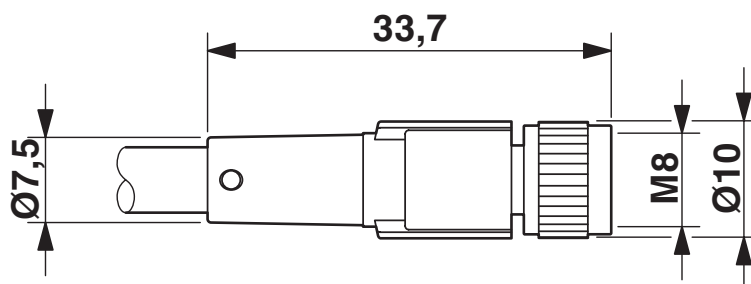

Socket M8 x 1, straight

SAC-3P-M12Y/2X3,0-PUR/M 8FS - Sensor/actuator cable



1671360

<https://www.phoenixcontact.com/in/products/1671360>

Circuit diagram

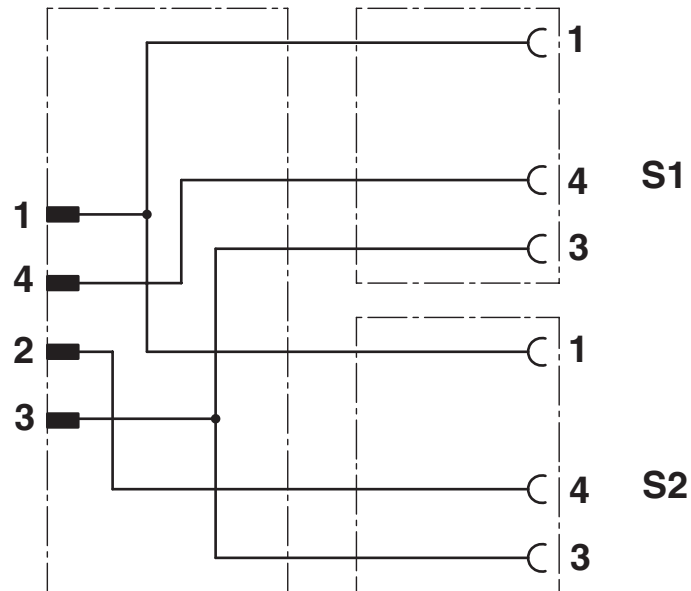

SAC-3P-M12Y/2X3,0-PUR/M 8FS - Sensor/actuator cable





1671360

<https://www.phoenixcontact.com/in/products/1671360>

Approvals

To download certificates, visit the product detail page: <https://www.phoenixcontact.com/in/products/1671360>

 UL Listed Approval ID: FILE E 221474				
	Nominal voltage U_N	Nominal current I_N	Cross section AWG	Cross section mm^2
	60 V	4 A	-	-

 cUL Listed Approval ID: FILE E 221474				
	Nominal voltage U_N	Nominal current I_N	Cross section AWG	Cross section mm^2
	60 V	4 A	-	-

 EAC-RoHS Approval ID: RU D-DE.HB35.B.00387	
---	--

cULus Listed

SAC-3P-M12Y/2X3,0-PUR/M 8FS - Sensor/actuator cable



1671360

<https://www.phoenixcontact.com/in/products/1671360>

Classifications

ECLASS

ECLASS-11.0	27060313
ECLASS-12.0	27060313
ECLASS-13.0	27060313

ETIM

ETIM 9.0	EC001855
----------	----------

UNSPSC

UNSPSC 21.0	26121600
-------------	----------

SAC-3P-M12Y/2X3,0-PUR/M 8FS - Sensor/actuator cable



1671360

<https://www.phoenixcontact.com/in/products/1671360>

Environmental product compliance

China RoHS	Environmentally friendly use period: unlimited = EFUP-e
	No hazardous substances above threshold values

Phoenix Contact 2024 © - all rights reserved
<https://www.phoenixcontact.com>

PHOENIX CONTACT (I) Pvt. Ltd.
A-58/2, Okhla Industrial Area, Phase - II, New Delhi-110 020

+91.1275.71420
info@phoenixcontact.co.in