

SAC-3P-M 8MS/0,3-PUR/M12FR - Sensor/actuator cable



1682346

<https://www.phoenixcontact.com/sg/products/1682346>

Please be informed that the data shown in this PDF document is generated from our online catalog. Please find the complete data in the user documentation. Our general terms of use for downloads are valid.



Sensor/actuator cable, 3-position, PUR halogen-free, black-gray RAL 7021, Plug straight M8, coding: A, on Socket angled M12, coding: A, cable length: 0.3 m

Your advantages

- Easy and safe: 100 % electrically tested plug-in components

Commercial data

Item number	1682346
Packing unit	1 pc
Minimum order quantity	1 pc
Note	Made to order (non-returnable)
Sales key	0213*
Product key	BF1CBA
Catalog page	Page 188 (C-2-2019)
GTIN	4017918159009
Weight per piece (including packing)	20.8 g
Weight per piece (excluding packing)	20.39 g
Customs tariff number	85444290
Country of origin	CN

SAC-3P-M 8MS/0,3-PUR/M12FR - Sensor/actuator cable



1682346

<https://www.phoenixcontact.com/sg/products/1682346>

Technical data

Product properties

Product type	Sensor/actuator cable
Application	Standard
Number of positions	3
No. of cable outlets	1
Shielded	no
Coding	A

Insulation characteristics

Overvoltage category	II
Degree of pollution	3

Material specifications

Flammability rating according to UL 94	HB
Seal material	NBR
Material of grip body	TPU, hardly inflammable, self-extinguishing
Contact material	CuSn
Contact surface material	Ni/Au
Contact carrier material	TPU GF
Material for screw connection	Zinc die-cast, nickel-plated

Electrical properties

Insulation resistance	$\geq 100 \text{ M}\Omega$
Nominal voltage U_N	48 V AC
	60 V DC
Nominal current I_N	4 A

Mechanical properties

Mechanical data

Insertion/withdrawal cycles	≥ 100
-----------------------------	------------

Signaling

Status display	No
Status display present	No

Connection data

Conductor connection

Tightening torque	0.4 Nm (M12 connector)
	0.2 Nm (M8 connectors)

Connector

SAC-3P-M 8MS/0,3-PUR/M12FR - Sensor/actuator cable

1682346

<https://www.phoenixcontact.com/sg/products/1682346>

Connection 1

Type	Plug straight M8
Number of positions	3
Coding type	A

Connection 2

Type	Socket angled M12
Number of positions	3
Coding type	A

Cable/line

Cable length	0.3 m
--------------	-------

PUR halogen-free black [PUR]

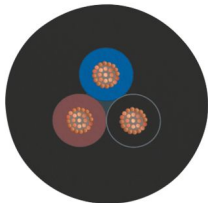
Dimensional drawing	
Cable weight	18 kg/km
UL AWM Style	20549 / 10493 (80°C/300 V)
Number of positions	3
Shielded	no
Cable type	PUR halogen-free black [PUR]
Conductor structure signal line	32x 0.10 mm
AWG signal line	24
Conductor cross section	3x 0.25 mm ² (Signal line)
Wire diameter incl. insulation	1.17 mm ±0.02 mm
External cable diameter	3.60 mm ±0.15 mm
Outer sheath, material	PUR
External sheath, color	black-gray RAL 7021
Conductor material	Bare Cu litz wires
Material wire insulation	PP
Single wire, color	brown, blue, black
Thickness, insulation	≥ 0.21 mm (Core insulation)
Thickness, outer sheath	approx. 0.50 mm
Overall twist	3 wires, twisted
Length of twist, overall twist	40 mm
Max. conductor resistance	≤ 78 Ω/km (at 20 °C)
Insulation resistance	≥ 100 GΩ*km (at 20 °C)
Nominal voltage, cable	≤ 300 V

SAC-3P-M 8MS/0,3-PUR/M12FR - Sensor/actuator cable



1682346

<https://www.phoenixcontact.com/sg/products/1682346>

Test voltage	≥ 3000 V
Smallest bending radius, fixed installation	18 mm
Smallest bending radius, movable installation	36 mm
Max. bending cycles	10000000
Bending radius	44 mm
Traversing path	10 m
Traversing rate	3 m/s
Acceleration	10 m/s ²
Halogen-free	in accordance with DIN VDE 0472 part 815
Flame resistance	in accordance with UL 758/1581 FT2 DIN EN 60332-2-2 (20 s)
Resistance to oil	in accordance with DIN EN 60811-2-1
Other resistance	hydrolysis and microbe resistant Highly resistant to acids, alkaline solutions and solvents Resistant to salt water partly UV-resistant (in accordance with DIN EN ISO 4892-2-A)
Special properties	Flexible cable conduit capable Silicone-free Free of substances which would hinder coating with paint or varnish
Ambient temperature (operation)	-40 °C ... 80 °C (cable, fixed installation) -25 °C ... 80 °C (Cable, flexible installation)

Environmental and real-life conditions

Ambient conditions

Degree of protection	IP65 IP67 IP68
Ambient temperature (operation)	-25 °C ... 90 °C (Plug / socket)

Standards and regulations

Standard designation	M12 connector
Standards/specifications	IEC 61076-2-101
Standard designation	M8 connector
Standards/specifications	IEC 61076-2-104

SAC-3P-M 8MS/0,3-PUR/M12FR - Sensor/actuator cable



1682346

<https://www.phoenixcontact.com/sg/products/1682346>

Drawings

Schematic diagram

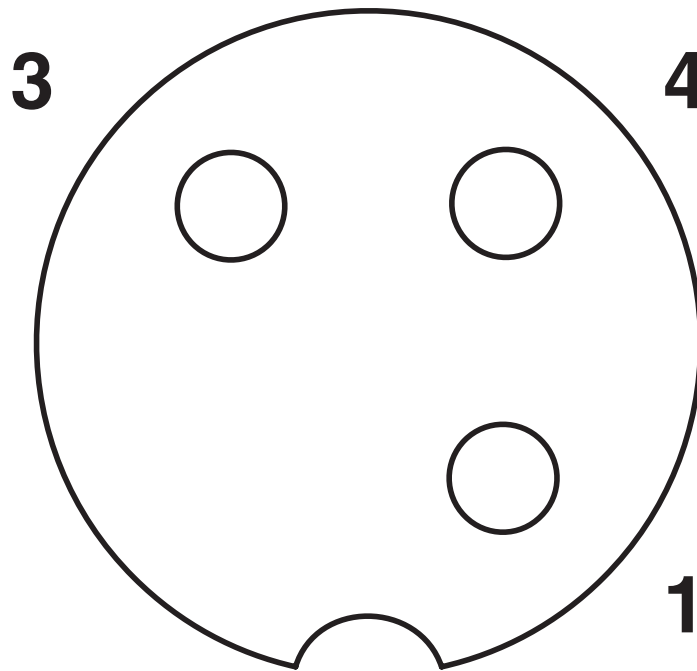

Pin assignment M12 socket, 3-pos., A-coded, view female side

Circuit diagram

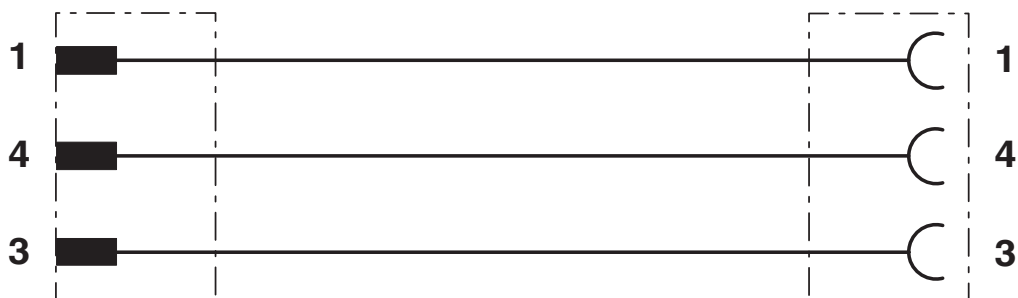

SAC-3P-M 8MS/0,3-PUR/M12FR - Sensor/actuator cable

1682346

<https://www.phoenixcontact.com/sg/products/1682346>

Schematic diagram

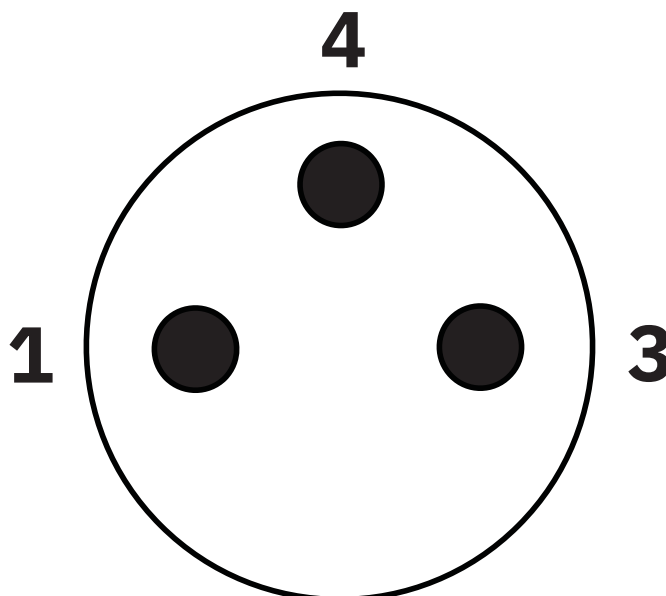

Pin assignment M8 plug, 3-pos., view male side

Dimensional drawing

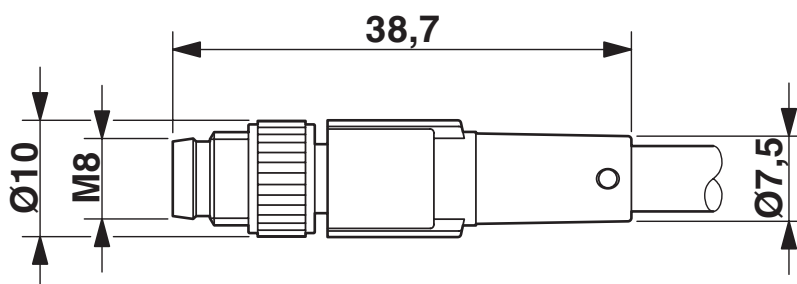

M8 x 1 male plug, straight version

SAC-3P-M 8MS/0,3-PUR/M12FR - Sensor/actuator cable

1682346

<https://www.phoenixcontact.com/sg/products/1682346>

Dimensional drawing

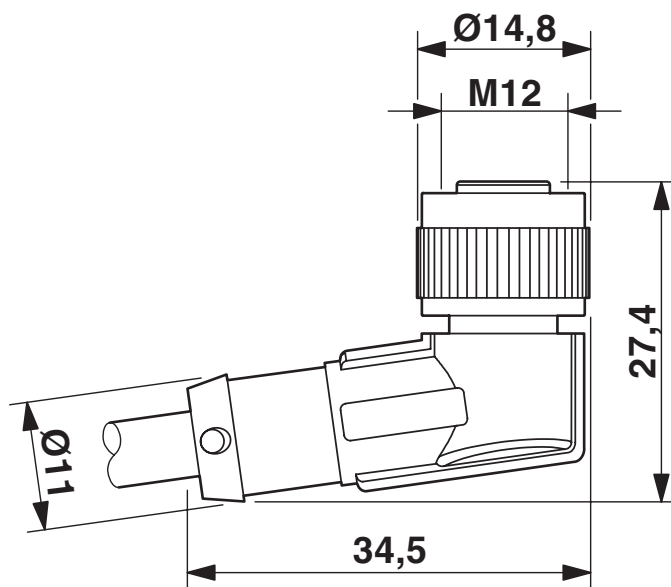

M12 x 1 socket, angled

SAC-3P-M 8MS/0,3-PUR/M12FR - Sensor/actuator cable





1682346

<https://www.phoenixcontact.com/sg/products/1682346>

Approvals

To download certificates, visit the product detail page: <https://www.phoenixcontact.com/sg/products/1682346>

 UL Listed Approval ID: FILE E 221474				
	Nominal voltage U_N	Nominal current I_N	Cross section AWG	Cross section mm^2
	60 V	4 A	-	-

 cUL Listed Approval ID: FILE E 221474				
	Nominal voltage U_N	Nominal current I_N	Cross section AWG	Cross section mm^2
	60 V	4 A	-	-

 EAC-RoHS Approval ID: RU D-DE.HB35.B.00387	
---	--

cULus Listed	
---------------------	--

SAC-3P-M 8MS/0,3-PUR/M12FR - Sensor/actuator cable



1682346

<https://www.phoenixcontact.com/sg/products/1682346>

Classifications

ECLASS

ECLASS-11.0	27060311
ECLASS-12.0	27060311
ECLASS-13.0	27060311

ETIM

ETIM 9.0	EC001855
----------	----------

UNSPSC

UNSPSC 21.0	26121600
-------------	----------

SAC-3P-M 8MS/0,3-PUR/M12FR - Sensor/actuator cable



1682346

<https://www.phoenixcontact.com/sg/products/1682346>

Environmental product compliance

EU RoHS

Fulfills EU RoHS substance requirements	Yes, No exemptions
---	--------------------

China RoHS

Environment friendly use period (EFUP)	EFUP-E
	No hazardous substances above the limits

EU REACH SVHC

REACH candidate substance (CAS No.)	No substance above 0.1 wt%
-------------------------------------	----------------------------

Phoenix Contact 2024 © - all rights reserved
<https://www.phoenixcontact.com>

PHOENIX CONTACT SEA Pte. Ltd.
105 Eunos Avenue 3, #04-00
Singapore 409836
+65 6228 4900
marketing@phoenixcontact.com.sg