

SAC-4P- 1,5-PUR/M12FR SH - Sensor/actuator cable



1682906

<https://www.phoenixcontact.com/us/products/1682906>

Please be informed that the data shown in this PDF document is generated from our online catalog. Please find the complete data in the user documentation. Our general terms of use for downloads are valid.



Sensor/actuator cable, 4-position, PUR halogen-free, black-gray RAL 7021, shielded (Advanced Shielding Technology), free cable end, on Socket angled M12, coding: A, cable length: 1.5 m

Your advantages

- Easy and safe: 100 % electrically tested plug-in components
- Reliable signal transmission – 360° shielding in environments with electromagnetic interference

Commercial data

Item number	1682906
Packing unit	1 pc
Minimum order quantity	1 pc
Sales key	BF03
Product key	BF1CJA
Catalog page	Page 199 (C-2-2019)
GTIN	4017918169183
Weight per piece (including packing)	77 g
Weight per piece (excluding packing)	72 g
Customs tariff number	85444290
Country of origin	PL

SAC-4P- 1,5-PUR/M12FR SH - Sensor/actuator cable



1682906

<https://www.phoenixcontact.com/us/products/1682906>

Technical data

Product properties

Product type	Sensor/actuator cable
Application	Standard
Number of positions	4
No. of cable outlets	1
Shielded	yes
Coding	A

Data management status

Article revision	13
------------------	----

Insulation characteristics

Overvoltage category	II
Degree of pollution	3

Material specifications

Flammability rating according to UL 94	HB
Seal material	NBR
Material of grip body	TPU, hardly inflammable, self-extinguishing
Contact material	CuSn
Contact surface material	Ni/Au
Contact carrier material	TPU GF
Material for screw connection	Zinc die-cast, nickel-plated

Electrical properties

Insulation resistance	$\geq 100 \text{ M}\Omega$
Nominal voltage U_N	48 V AC
	60 V DC
Nominal current I_N	4 A

Mechanical properties

Mechanical data

Insertion/withdrawal cycles	≥ 100
-----------------------------	------------

Signaling

Status display	no
Status display present	No

Connection data

Conductor connection

Tightening torque	0.4 Nm (M12 connector)
-------------------	------------------------

SAC-4P- 1,5-PUR/M12FR SH - Sensor/actuator cable



1682906

<https://www.phoenixcontact.com/us/products/1682906>

Connector

Connection 1

Type	free cable end
------	----------------

Connection 2

Type	Socket angled M12
Number of positions	4
Coding type	A

Cable/line

Cable length	1.5 m
--------------	-------

PUR halogen-free black [PUR]

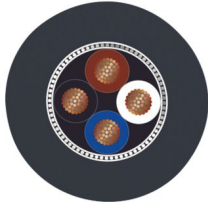
Dimensional drawing	
Cable weight	36 kg/km
UL AWM Style	20549 / 10493 (80°C/300 V)
Number of positions	4
Shielded	yes
Cable type	PUR halogen-free black [PUR]
Conductor structure signal line	42x 0.10 mm
AWG signal line	22
Conductor cross section	4x 0.34 mm ² (Signal line)
Wire diameter incl. insulation	1.27 mm ±0.02 mm (Signal line)
External cable diameter	4.95 mm ±0.2 mm
Outer sheath, material	PUR
External sheath, color	black-gray RAL 7021
Conductor material	Bare Cu litz wires
Material wire insulation	PP
Single wire, color	brown, white, blue, black
Thickness, insulation	≥ 0.21 mm
Thickness, outer sheath	approx. 0.50 mm
Overall twist	4 wires, twisted
Optical shield covering	80 %
Max. conductor resistance	max. 58 Ω/km (at 20 °C)
Insulation resistance	≥ 100 GΩ*km (at 20 °C)
Wave impedance	≥ 62 Ω (f = 10 MHz)

SAC-4P- 1,5-PUR/M12FR SH - Sensor/actuator cable



1682906

<https://www.phoenixcontact.com/us/products/1682906>

Cable capacity	≤ 80 pF/m (Conductor-Conductor)
	≤ 135 pF/m (Wire/shield)
Nominal voltage, cable	≤ 300 V
Test voltage	≥ 3000 V
Minimum bending radius, fixed installation	5 x D
Minimum bending radius, flexible installation	10 x D
Smallest bending radius, fixed installation	25 mm
Smallest bending radius, movable installation	50 mm
Dynamic load capacity (bending)	Max. bending cycles: 10000000, Bending radius: 10 x D, Traversing path: 10 m, Traversing rate: 3 m/s, Acceleration: 10 m/s ²
Halogen-free	in accordance with DIN VDE 0472 part 815
	in accordance with DIN EN 50267-2-1
Flame resistance	in accordance with UL 758/1581 FT2
	DIN EN 60332-2-2 (20 s)
Resistance to oil	in accordance with DIN EN 60811-2-1
Other resistance	Highly resistant to acids, alkaline solutions and solvents
	hydrolysis and microbe resistant
	Resistant to salt water
	partly UV-resistant (in accordance with DIN EN ISO 4892-2-A)
	abrasion-resistant
Special properties	Flexible cable conduit capable
	Silicone-free
	Free of substances which would hinder coating with paint or varnish
	Low adhesion surface
Ambient temperature (operation)	-40 °C ... 80 °C (cable, fixed installation)
	-25 °C ... 80 °C (Cable, flexible installation)

Environmental and real-life conditions

Ambient conditions

Degree of protection	IP65
	IP67
Ambient temperature (operation)	-25 °C ... 90 °C (Plug / socket)
	-25 °C ... 80 °C (cable, fixed installation)
	-5 °C ... 80 °C (Cable, flexible installation)

Standards and regulations

Standard designation	M12 connector
Standards/specifications	IEC 61076-2-101

Drawings

Schematic diagram

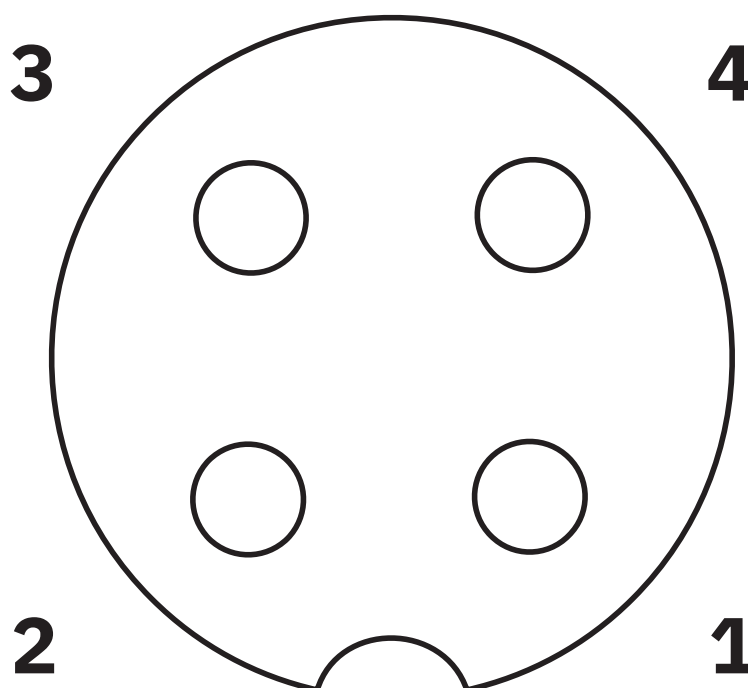

Pin assignment M12 socket, 4-pos., A-coded, view female side

SAC-4P- 1,5-PUR/M12FR SH - Sensor/actuator cable

1682906

<https://www.phoenixcontact.com/us/products/1682906>



Dimensional drawing

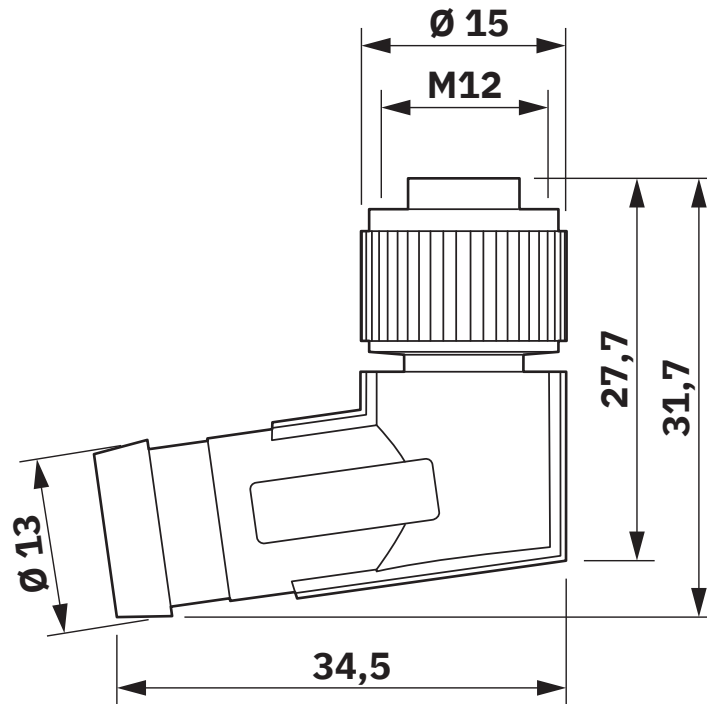

M12 x 1 socket, angled, shielded

Diagram

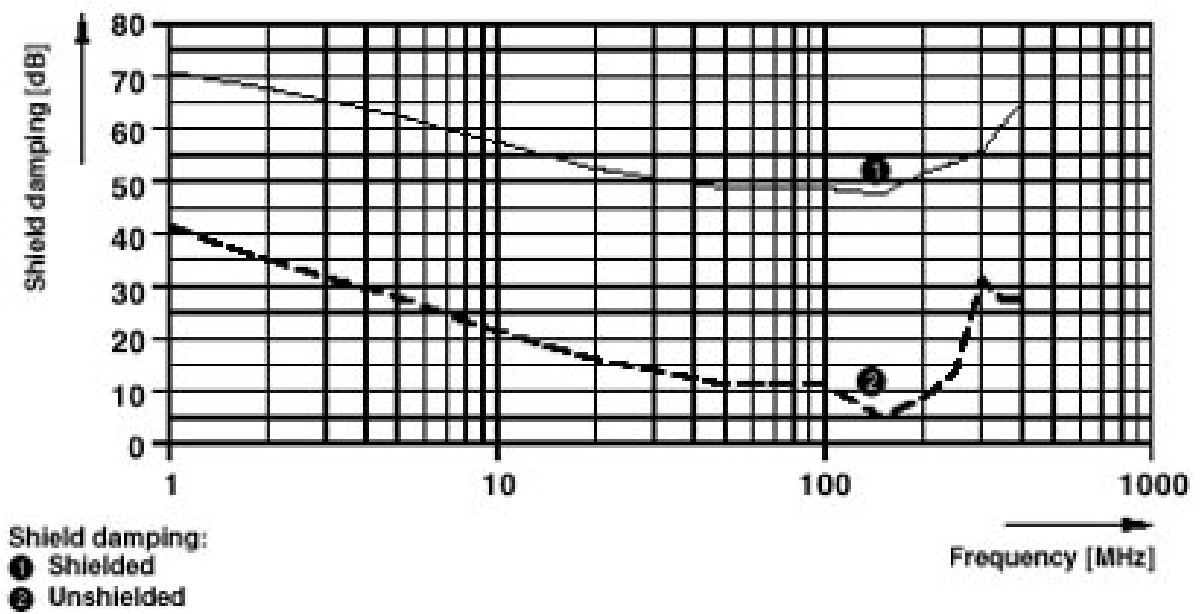

SAC-4P- 1,5-PUR/M12FR SH - Sensor/actuator cable



1682906

<https://www.phoenixcontact.com/us/products/1682906>

Circuit diagram

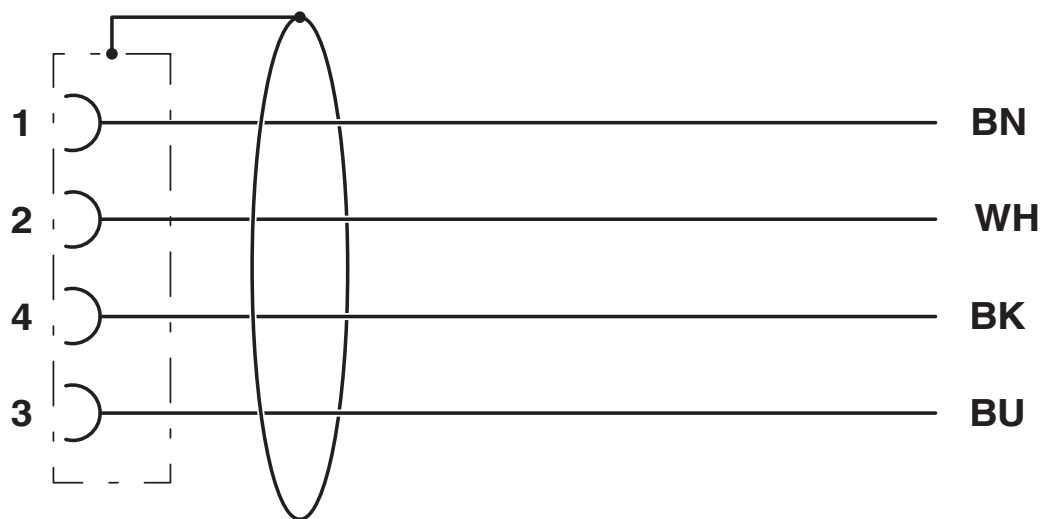

SAC-4P- 1,5-PUR/M12FR SH - Sensor/actuator cable





1682906

<https://www.phoenixcontact.com/us/products/1682906>

Approvals

To download certificates, visit the product detail page: <https://www.phoenixcontact.com/us/products/1682906>

 UL Listed Approval ID: FILE E 221474				
	Nominal voltage U_N	Nominal current I_N	Cross section AWG	Cross section mm^2
	300 V	4 A	-	-

 cUL Listed Approval ID: FILE E 221474				
	Nominal voltage U_N	Nominal current I_N	Cross section AWG	Cross section mm^2
	300 V	4 A	-	-

 EAC-RoHS Approval ID: RU D-DE.HB35.B.00387	
---	--

cULus Listed

SAC-4P- 1,5-PUR/M12FR SH - Sensor/actuator cable



1682906

<https://www.phoenixcontact.com/us/products/1682906>

Classifications

ECLASS

ECLASS-11.0	27060311
ECLASS-12.0	27060311
ECLASS-13.0	27060311

ETIM

ETIM 9.0	EC001855
----------	----------

UNSPSC

UNSPSC 21.0	26121600
-------------	----------

SAC-4P- 1,5-PUR/M12FR SH - Sensor/actuator cable



1682906

<https://www.phoenixcontact.com/us/products/1682906>

Environmental product compliance

EU RoHS

Fulfills EU RoHS substance requirements	Yes, No exemptions
---	--------------------

China RoHS

Environment friendly use period (EFUP)	EFUP-E
	No hazardous substances above the limits

EU REACH SVHC

REACH candidate substance (CAS No.)	No substance above 0.1 wt%
-------------------------------------	----------------------------

EF3.0 Climate Change

CO2e kg	0.368 kg CO2e
---------	---------------

Phoenix Contact 2024 © - all rights reserved
<https://www.phoenixcontact.com>

Phoenix Contact USA
586 Fulling Mill Road
Middletown, PA 17057, United States
(+717) 944-1300
info@phoenixcon.com