

MK3DS 1/ 4-3,81 - PCB terminal block

1727751

<https://www.phoenixcontact.com/us/products/1727751>

Please be informed that the data shown in this PDF document is generated from our online catalog. Please find the complete data in the user documentation. Our general terms of use for downloads are valid.



PCB terminal block, nominal current: 8 A, rated voltage (III/2): 160 V, nominal cross section: 1 mm², number of potentials: 12, number of rows: 3, number of positions per row: 4, product range: MK3DS 1, pitch: 3.81 mm, connection method: Screw connection with tension sleeve, screw head form: L Slotted, mounting: Wave soldering, conductor/PCB connection direction: 0 °, color: green, Pin layout: Linear pinning, Solder pin [P]: 3.5 mm, number of solder pins per potential: 1, type of packaging: packed in cardboard

Your advantages

- Well-known connection principle allows worldwide use
- Low temperature rise, thanks to maximum contact force
- Allows connection of two conductors
- Extremely small design for the respective conductor cross section
- Conductor connection on several levels enables higher contact density

Commercial data

Item number	1727751
Packing unit	50 pc
Minimum order quantity	50 pc
Sales key	AA12
Product key	AALFIA
Catalog page	Page 87 (C-1-2013)
GTIN	4017918116385
Weight per piece (including packing)	8.99 g
Weight per piece (excluding packing)	8.317 g
Customs tariff number	85369010
Country of origin	DE

MK3DS 1/ 4-3,81 - PCB terminal block



1727751

<https://www.phoenixcontact.com/us/products/1727751>

Technical data

Product properties

Product type	Printed circuit board terminal
Product family	MK3DS 1
Product line	COMBICON Terminals S
Type	PC termination block
Number of positions	4
Pitch	3.81 mm
Number of connections	12
Number of rows	3
Number of potentials	12
Pin layout	Linear pinning
Solder pins per potential	1

Electrical properties

Nominal current I_N	8 A
Nominal voltage U_N	160 V
Degree of pollution	3
Rated voltage (III/3)	160 V
Rated surge voltage (III/3)	2.5 kV
Rated voltage (III/2)	160 V
Rated surge voltage (III/2)	2.5 kV
Rated voltage (II/2)	320 V
Rated surge voltage (II/2)	2.5 kV

Connection data

Connection technology

Type	PC termination block
Nominal cross section	1 mm ²

Conductor connection

Connection method	Screw connection with tension sleeve
Conductor cross section rigid	0.14 mm ² ... 1.5 mm ²
Conductor cross section flexible	0.14 mm ² ... 1 mm ²
Conductor cross section AWG	26 ... 16
Conductor cross section flexible, with ferrule without plastic sleeve	0.25 mm ² ... 0.5 mm ²
Conductor cross section, flexible, with ferrule, with plastic sleeve	0.25 mm ² ... 0.5 mm ²
2 conductors with same cross section, solid	0.14 mm ² ... 0.5 mm ²
2 conductors with same cross section, flexible	0.14 mm ² ... 0.2 mm ²
Stripping length	5 mm
Tightening torque	0.22 Nm ... 0.25 Nm

MK3DS 1/ 4-3,81 - PCB terminal block



1727751

<https://www.phoenixcontact.com/us/products/1727751>

Mounting

Mounting type	Wave soldering
Pin layout	Linear pinning
Drive form screw head	Slotted (L)

Material specifications

Material data - contact

Note	WEEE/RoHS-compliant, free of whiskers according to IEC 60068-2-82/JEDEC JESD 201
Contact material	Cu alloy
Surface characteristics	Tin-plated
Metal surface terminal point (top layer)	Tin (5 - 7 μm Sn)
Metal surface terminal point (middle layer)	Nickel (2 - 3 μm Ni)
Metal surface soldering area (top layer)	Tin (5 - 7 μm Sn)
Metal surface soldering area (middle layer)	Nickel (2 - 3 μm Ni)

Material data - housing

Color (Housing)	green (6021)
Insulating material	PA
Insulating material group	I
CTI according to IEC 60112	600
Flammability rating according to UL 94	V0
Glow wire flammability index GWFI according to EN 60695-2-12	850
Glow wire ignition temperature GWIT according to EN 60695-2-13	775
Temperature for the ball pressure test according to EN 60695-10-2	125 °C

Dimensions

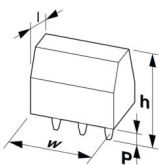
Dimensional drawing	
Pitch	3.81 mm
Width [w]	17.14 mm
Height [h]	27.4 mm
Length [l]	25 mm
Installed height	23.9 mm
Solder pin length [P]	3.5 mm
Pin dimensions	0.5 x 0.9 mm

PCB design

Hole diameter	1.1 mm
---------------	--------

Mechanical tests

Test for conductor damage and slackening

Specification	IEC 60999-1:1999-11
Result	Test passed

Pull-out test

Specification	IEC 60999-1:1999-11
Conductor cross section/conductor type/tractive force setpoint/actual value	0.14 mm ² / solid / > 10 N
	0.14 mm ² / flexible / > 10 N
	1.5 mm ² / solid / > 40 N
	1 mm ² / flexible / > 35 N

Electrical tests

Temperature-rise test

Specification	IEC 60947-7-4:2019-01
Requirement temperature-rise test	The sum of ambient temperature and temperature rise of the PCB terminal block shall not exceed the upper limiting temperature.

Short-time withstand current

Specification	IEC 60947-7-4:2019-01
---------------	-----------------------

Insulation resistance

Specification	IEC 60512-3-1:2002-02
Insulation resistance, neighboring positions	> 5 MΩ

Air clearances and creepage distances |

Specification	IEC 60947-1:2007-06 + A1:2010-12 + A2:2014-09
Insulating material group	I
Comparative tracking index (IEC 60112)	CTI 600
Rated insulation voltage (III/3)	160 V
Rated surge voltage (III/3)	2.5 kV
minimum clearance value - non-homogenous field (III/3)	1.5 mm
minimum creepage distance (III/3)	2 mm
Rated insulation voltage (III/2)	160 V
Rated surge voltage (III/2)	2.5 kV
minimum clearance value - non-homogenous field (III/2)	1.5 mm
minimum creepage distance (III/2)	1.5 mm
Rated insulation voltage (II/2)	320 V
Rated surge voltage (II/2)	2.5 kV
minimum clearance value - non-homogenous field (II/2)	1.5 mm
minimum creepage distance (II/2)	1.6 mm

Environmental and real-life conditions

MK3DS 1/ 4-3,81 - PCB terminal block



1727751

<https://www.phoenixcontact.com/us/products/1727751>

Vibration test

Specification	IEC 60068-2-6:2007-12
Frequency	10 - 150 - 10 Hz
Sweep speed	1 octave/min
Amplitude	0.35 mm (10 Hz ... 60.1 Hz)
Acceleration	5g (60.1 Hz ... 150 Hz)
Test duration per axis	2.5 h

Glow-wire test

Specification	IEC 60695-2-10:2013-04
Temperature	850 °C
Time of exposure	5 s

Aging

Specification	IEC 60947-7-4:2019-01
---------------	-----------------------

Ambient conditions

Ambient temperature (operation)	-40 °C ... 105 °C (Depending on the current carrying capacity/derating curve)
Ambient temperature (storage/transport)	-40 °C ... 70 °C
Relative humidity (storage/transport)	30 % ... 70 %
Ambient temperature (assembly)	-5 °C ... 100 °C

Packaging specifications

Type of packaging	packed in cardboard
-------------------	---------------------

MK3DS 1/ 4-3,81 - PCB terminal block

1727751

<https://www.phoenixcontact.com/us/products/1727751>

Drawings

Drilling plan/solder pad geometry

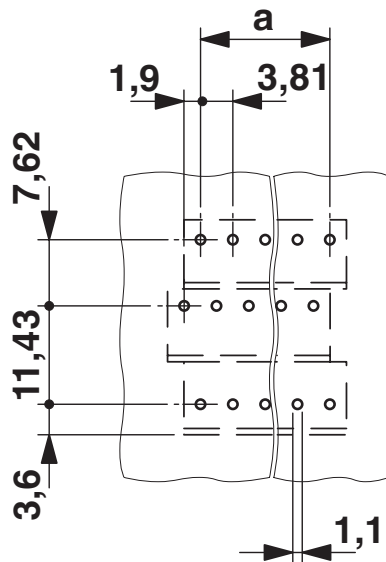

Diagram

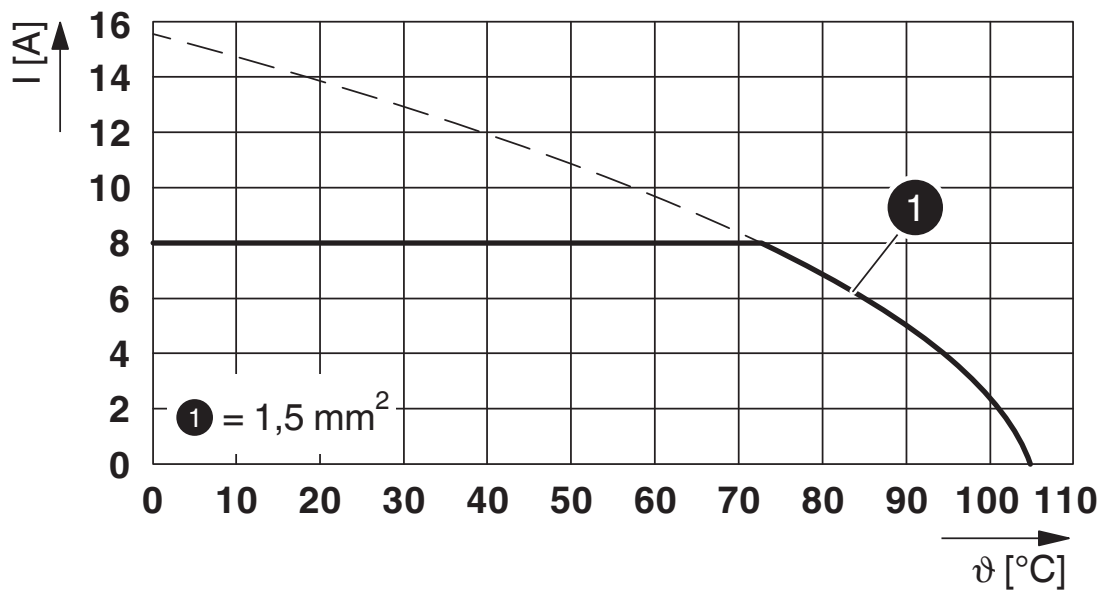

Type: MK3DS 1/...-3,81

MK3DS 1/ 4-3,81 - PCB terminal block



1727751

<https://www.phoenixcontact.com/us/products/1727751>

Dimensional drawing

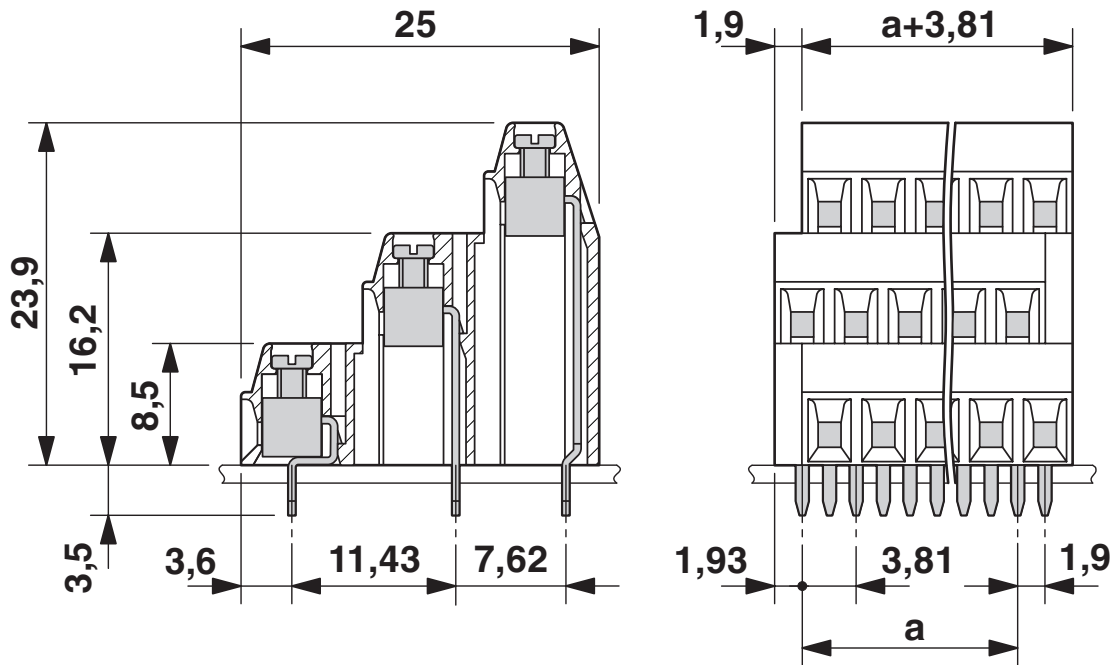

MK3DS 1/ 4-3,81 - PCB terminal block





1727751

<https://www.phoenixcontact.com/us/products/1727751>

Approvals

To download certificates, visit the product detail page: <https://www.phoenixcontact.com/us/products/1727751>

 CSA Approval ID: 13631				
	Nominal voltage U_N	Nominal current I_N	Cross section AWG	Cross section mm^2
Use group B	150 V	10 A	28 - 16	-
Use group D	300 V	10 A	28 - 16	-

 cULus Recognized Approval ID: E60425-19770427				
	Nominal voltage U_N	Nominal current I_N	Cross section AWG	Cross section mm^2
Use group B	300 V	10 A	30 - 16	-
Use group D	300 V	10 A	30 - 16	-

 VDE Zeichengenehmigung Approval ID: 40055535				
	Nominal voltage U_N	Nominal current I_N	Cross section AWG	Cross section mm^2
	160 V	8 A	-	0.2 - 1.5

MK3DS 1/ 4-3,81 - PCB terminal block



1727751

<https://www.phoenixcontact.com/us/products/1727751>

Classifications

ECLASS

ECLASS-11.0	27460101
ECLASS-12.0	27460101
ECLASS-13.0	27460101

ETIM

ETIM 9.0	EC002643
----------	----------

UNSPSC

UNSPSC 21.0	39121400
-------------	----------

MK3DS 1/ 4-3,81 - PCB terminal block



1727751

<https://www.phoenixcontact.com/us/products/1727751>

Environmental product compliance

EU RoHS

Fulfills EU RoHS substance requirements	Yes, No exemptions
---	--------------------

China RoHS

Environment friendly use period (EFUP)	EFUP-E
	No hazardous substances above the limits

EU REACH SVHC

REACH candidate substance (CAS No.)	No substance above 0.1 wt%
-------------------------------------	----------------------------

MK3DS 1/ 4-3,81 - PCB terminal block



1727751

<https://www.phoenixcontact.com/us/products/1727751>

Accessories

SK 3,81/2,8:FORTL.ZAHLEN - Marker card

0804109

<https://www.phoenixcontact.com/us/products/0804109>

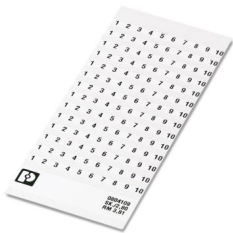

Marker card, Sheet, white, labeled, horizontal: consecutive numbers 1 ... 10, 11 .. 20, etc. up to 91 ... (99)100, mounting type: adhesive, for terminal block width: 3.81 mm, lettering field size: 3.81 x 2.8 mm, Number of individual labels: 14

SZS 0,4X2,5 VDE - Screwdriver

1205037

<https://www.phoenixcontact.com/us/products/1205037>



Screwdriver, slot-headed, VDE insulated, size: 0.4 x 2.5 x 80 mm, 2-component grip, with non-slip grip

Phoenix Contact 2024 © - all rights reserved

<https://www.phoenixcontact.com>

Phoenix Contact USA

586 Fulling Mill Road

Middletown, PA 17057, United States

(+717) 944-1300

info@phoenixcon.com