

# MSTB 2,5/14-G-5,08-LA - PCB header



1770834

<https://www.phoenixcontact.com/pc/products/1770834>

Please be informed that the data shown in this PDF document is generated from our online catalog. Please find the complete data in the user documentation. Our general terms of use for downloads are valid.

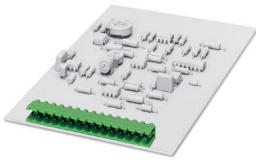

PCB headers, color: green, contact surface: Tin, number of positions: 14, product range: MSTB 2,5/..-G-LA, pitch: 5.08 mm, pin layout: Linear pinning, solder pin [P]: 3.2 mm, type of packaging: packed in cardboard

## Commercial data

Item number	1770834
Packing unit	50 pc
Minimum order quantity	1 pc
Note	Made to order (non-returnable)
Product key	AAC1GF
GTIN	4017918035570
Weight per piece (including packing)	5.2 g
Weight per piece (excluding packing)	4.534 g
Customs tariff number	85366930
Country of origin	DE

# MSTB 2,5/14-G-5,08-LA - PCB header

1770834

<https://www.phoenixcontact.com/pc/products/1770834>

## Technical data

### Product properties

Product type	PCB headers
Product family	MSTB 2,5/..-G-LA
Type	Header for light indicator element
Number of positions	14
Pitch	5.08 mm
Mounting flange	without
Pin layout	Linear pinning

### Electrical properties

Maximum load current	12 A
Rated voltage (II/2)	400 V
Rated voltage (III/2)	320 V
Rated surge voltage (II/2)	4 kV
Rated surge voltage (III/2)	4 kV
Rated surge voltage (III/3)	4 kV

### Mounting

Mounting type	Wave soldering
Pin layout	Linear pinning

### Material specifications

Color	green
Flammability rating according to UL 94	V0
Insulating material group	I
Insulating material	PBT
Contact surface	Tin Sn
Contact surface material	Sn

### Dimensions

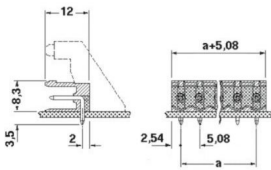
Dimensional drawing	
Width	71.12 mm
Height	11.5 mm
Installed height	8.3 mm

# MSTB 2,5/14-G-5,08-LA - PCB header



1770834

<https://www.phoenixcontact.com/pc/products/1770834>

Length of the solder pin	3.2 mm
Length	12 mm
Length of the solder pin	3.2 mm
Hole diameter	1.4 mm
Pitch	5.08 mm

## Packaging specifications

Type of packaging	packed in cardboard
-------------------	---------------------

# MSTB 2,5/14-G-5,08-LA - PCB header

1770834

<https://www.phoenixcontact.com/pc/products/1770834>

## Drawings

### Dimensional drawing

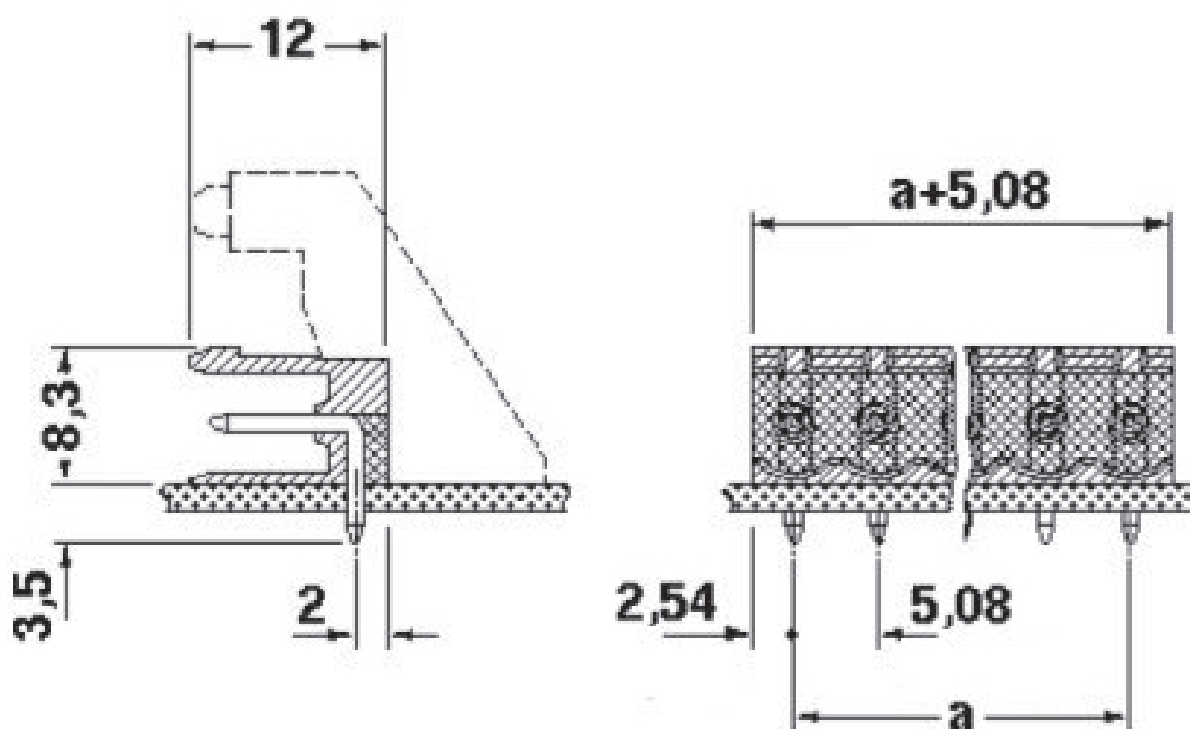

1770834

<https://www.phoenixcontact.com/pc/products/1770834>

## Environmental product compliance

### EU RoHS

Fulfills EU RoHS substance requirements	Yes, No exemptions
---	--------------------

### China RoHS

Environment friendly use period (EFUP)	EFUP-E
	No hazardous substances above the limits

### EU REACH SVHC

REACH candidate substance (CAS No.)	No substance above 0.1 wt%
-------------------------------------	----------------------------

# MSTB 2,5/14-G-5,08-LA - PCB header

1770834

<https://www.phoenixcontact.com/pc/products/1770834>

## Accessories

### MSTB-BL - Accessories

1755477

<https://www.phoenixcontact.com/pc/products/1755477>



Keying cap, for forming sections, plugs onto header pin, green insulating material

---

### MSTB-BF - Accessories

1759981

<https://www.phoenixcontact.com/pc/products/1759981>



Mounting flange, for fixing both ends of the header onto the PCB, green insulating material, with M 2 x 14 screws and nuts.

# MSTB 2,5/14-G-5,08-LA - PCB header



1770834

<https://www.phoenixcontact.com/pc/products/1770834>

## SK 5,08/3,8:FORTL.ZAHLEN - Marker card

0804293

<https://www.phoenixcontact.com/pc/products/0804293>

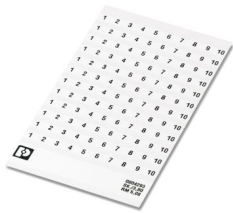

Marker card, white, labeled, horizontal: consecutive numbers 1 ... 10, 11 ... 20, etc. up to 91 ... (99)100, mounting type: adhesive, for terminal block width: 5.08 mm, lettering field size: 5.08 x 3.8 mm

---

## CR-MSTB - Coding section

1734401

<https://www.phoenixcontact.com/pc/products/1734401>



Coding section, inserted into the recess in the header or the inverted plug, red insulating material

# MSTB 2,5/14-G-5,08-LA - PCB header

1770834

<https://www.phoenixcontact.com/pc/products/1770834>

## FRONT-MSTB 2,5/14-ST-5,08 - PCB connector

1777400

<https://www.phoenixcontact.com/pc/products/1777400>

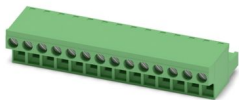

PCB connector, nominal cross section: 2.5 mm<sup>2</sup>, color: green, nominal current: 12 A, rated voltage (III/2): 320 V, contact surface: Tin, contact connection type: Socket, number of potentials: 14, number of rows: 1, number of positions: 14, number of connections: 14, product range: FRONT-MSTB 2,5/...-ST, pitch: 5.08 mm, connection method: Front screw connection, screw head form: L Slotted, conductor/PCB connection direction: 0 °, locking clip: - Locking clip, plug-in system: COMBICON MSTB 2,5, locking: without, mounting: without, type of packaging: packed in cardboard

## MSTBC 2,5/14-ST-5,08 - PCB connector

1808939

<https://www.phoenixcontact.com/pc/products/1808939>



PCB connector, nominal cross section: 2.5 mm<sup>2</sup>, color: green, nominal current: 12 A, rated voltage (III/2): 320 V, contact connection type: Socket, number of potentials: 14, number of rows: 1, number of positions: 14, number of connections: 14, product range: MSTBC 2,5/...-ST, pitch: 5.08 mm, connection method: Crimp connection, conductor/PCB connection direction: 0 °, locking clip: - Locking clip, plug-in system: COMBICON MSTB 2,5, locking: without, mounting: without, type of packaging: packed in cardboard, Corresponding female crimp contacts with current [A] and conductor cross section range [mm<sup>2</sup>] data: 10A/MSTBC-MT 0,5-1,0 (3190564); 10A/MSTBC-MT 0,5-1,0 BA (3190645); 12A/MSTBC-MT 1,5-2,5 (3190551); 12A/MSTBC-MT 1,5-2,5 BA (3190658). BA = Bandkontakte

# MSTB 2,5/14-G-5,08-LA - PCB header

1770834

<https://www.phoenixcontact.com/pc/products/1770834>

## FKCT 2,5/14-ST-5,08 - PCB connector

1902233

<https://www.phoenixcontact.com/pc/products/1902233>

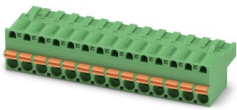

PCB connector, nominal cross section: 2.5 mm<sup>2</sup>, color: green, nominal current: 12 A, rated voltage (III/2): 320 V, contact surface: Tin, contact connection type: Socket, number of potentials: 14, number of rows: 1, number of positions: 14, number of connections: 14, product range: FKCT 2,5/..-ST, pitch: 5.08 mm, connection method: Push-in spring connection, conductor/PCB connection direction: 0 °, locking clip: - Locking clip, plug-in system: COMBICON MSTB 2,5, locking: without, mounting: without, type of packaging: packed in cardboard

---

## QC 1/14-ST-5,08 - PCB connector

1883828

<https://www.phoenixcontact.com/pc/products/1883828>

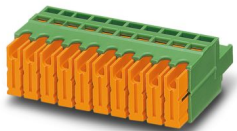

PCB connector, nominal cross section: 1 mm<sup>2</sup>, color: green, nominal current: 10 A, rated voltage (III/2): 630 V, contact surface: Tin, contact connection type: Socket, number of potentials: 14, number of rows: 1, number of positions: 14, number of connections: 14, product range: QC 1/..-ST, pitch: 5.08 mm, connection method: Displacement connection, conductor/PCB connection direction: 0 °, locking clip: - Locking clip, plug-in system: COMBICON MSTB 2,5, locking: without, mounting: without, type of packaging: packed in cardboard

# MSTB 2,5/14-G-5,08-LA - PCB header

1770834

<https://www.phoenixcontact.com/pc/products/1770834>



## FKCVR 2,5/14-ST-5,08 - PCB connector

1874073

<https://www.phoenixcontact.com/pc/products/1874073>

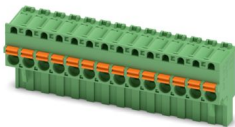

PCB connector, nominal cross section: 2.5 mm<sup>2</sup>, color: green, nominal current: 12 A, rated voltage (III/2): 320 V, contact surface: Tin, contact connection type: Socket, number of potentials: 14, number of rows: 1, number of positions: 14, number of connections: 14, product range: FKCVR 2,5/...-ST, pitch: 5.08 mm, connection method: Push-in spring connection, conductor/PCB connection direction: 90 °, locking clip: - Locking clip, plug-in system: COMBICON MSTB 2,5, locking: without, mounting: without, type of packaging: packed in cardboard

---

## FKCVW 2,5/14-ST-5,08 - PCB connector

1873773

<https://www.phoenixcontact.com/pc/products/1873773>

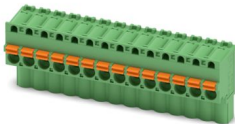

PCB connector, nominal cross section: 2.5 mm<sup>2</sup>, color: green, nominal current: 12 A, rated voltage (III/2): 320 V, contact surface: Tin, contact connection type: Socket, number of potentials: 14, number of rows: 1, number of positions: 14, number of connections: 14, product range: FKCVW 2,5/...-ST, pitch: 5.08 mm, connection method: Push-in spring connection, conductor/PCB connection direction: -90 °, locking clip: - Locking clip, plug-in system: COMBICON MSTB 2,5, locking: without, mounting: without, type of packaging: packed in cardboard

# MSTB 2,5/14-G-5,08-LA - PCB header

1770834

<https://www.phoenixcontact.com/pc/products/1770834>

## FKC 2,5/14-ST-5,08 - PCB connector

1873171

<https://www.phoenixcontact.com/pc/products/1873171>

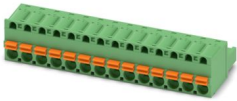

PCB connector, nominal cross section: 2.5 mm<sup>2</sup>, color: green, nominal current: 12 A, rated voltage (III/2): 320 V, contact surface: Tin, contact connection type: Socket, number of potentials: 14, number of rows: 1, number of positions: 14, number of connections: 14, product range: FKC 2,5/...-ST, pitch: 5.08 mm, connection method: Push-in spring connection, conductor/PCB connection direction: 0 °, locking clip: - Locking clip, plug-in system: COMBICON MSTB 2,5, locking: without, mounting: without, type of packaging: packed in cardboard

---

## MSTBC 2,5/14-STZ-5,08 - PCB connector

1809624

<https://www.phoenixcontact.com/pc/products/1809624>



PCB connector, nominal cross section: 2.5 mm<sup>2</sup>, color: green, nominal current: 12 A, rated voltage (III/2): 320 V, contact connection type: Socket, number of potentials: 14, number of rows: 1, number of positions: 14, number of connections: 14, product range: MSTBC 2,5/...-STZ, pitch: 5.08 mm, connection method: Crimp connection, conductor/PCB connection direction: 0 °, locking clip: - Locking clip, plug-in system: COMBICON MSTB 2,5, locking: without, mounting: without, type of packaging: packed in cardboard, Corresponding female crimp contacts with current [A] and conductor cross section range [mm<sup>2</sup>] data: 10A/MSTBC-MT 0,5-1,0 (3190564); 10A/MSTBC-MT 0,5-1,0 BA (3190645); 12A/MSTBC-MT 1,5-2,5 (3190551); 12A/MSTBC-MT 1,5-2,5 BA (3190658). BA = Bandkontakte

# MSTB 2,5/14-G-5,08-LA - PCB header

1770834

<https://www.phoenixcontact.com/pc/products/1770834>

## MVSTBW 2,5/14-ST-5,08 - PCB connector

1792870

<https://www.phoenixcontact.com/pc/products/1792870>

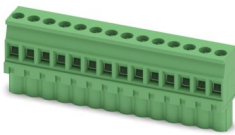

PCB connector, nominal cross section: 2.5 mm<sup>2</sup>, color: green, nominal current: 12 A, rated voltage (III/2): 320 V, contact surface: Tin, contact connection type: Socket, number of potentials: 14, number of rows: 1, number of positions: 14, number of connections: 14, product range: MVSTBW 2,5/..-ST, pitch: 5.08 mm, connection method: Screw connection with tension sleeve, screw head form: L Slotted, conductor/PCB connection direction: -90 °, locking clip: - Locking clip, plug-in system: COMBICON MSTB 2,5, locking: without, mounting: without, type of packaging: packed in cardboard

---

## MVSTBR 2,5/14-ST-5,08 - PCB connector

1792362

<https://www.phoenixcontact.com/pc/products/1792362>

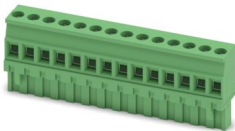

PCB connector, nominal cross section: 2.5 mm<sup>2</sup>, color: green, nominal current: 12 A, rated voltage (III/2): 320 V, contact surface: Tin, contact connection type: Socket, number of potentials: 14, number of rows: 1, number of positions: 14, number of connections: 14, product range: MVSTBR 2,5/..-ST, pitch: 5.08 mm, connection method: Screw connection with tension sleeve, screw head form: L Slotted, conductor/PCB connection direction: 90 °, locking clip: - Locking clip, plug-in system: COMBICON MSTB 2,5, locking: without, mounting: without, type of packaging: packed in cardboard

# MSTB 2,5/14-G-5,08-LA - PCB header

1770834

<https://www.phoenixcontact.com/pc/products/1770834>

## IC 2,5/14-G-5,08 - PCB header

1786527

<https://www.phoenixcontact.com/pc/products/1786527>



PCB headers, nominal cross section: 2.5 mm<sup>2</sup>, color: green, nominal current: 12 A, rated voltage (III/2): 320 V, contact surface: Tin, contact connection type: Socket, number of potentials: 14, number of rows: 1, number of positions: 14, number of connections: 14, product range: IC 2,5/..-G, pitch: 5.08 mm, mounting: Wave soldering, pin layout: Linear pinning, solder pin [P]: 3.5 mm, number of solder pins per potential: 2, plug-in system: COMBICON MSTB 2,5, Pin connector pattern alignment: Standard, locking: without, mounting: without, type of packaging: packed in cardboard

## ICV 2,5/14-G-5,08 - PCB header

1786064

<https://www.phoenixcontact.com/pc/products/1786064>

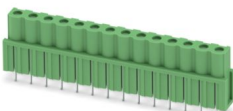

PCB headers, nominal cross section: 2.5 mm<sup>2</sup>, color: green, nominal current: 12 A, rated voltage (III/2): 320 V, contact surface: Tin, contact connection type: Socket, number of potentials: 14, number of rows: 1, number of positions: 14, number of connections: 14, product range: ICV 2,5/..-G, pitch: 5.08 mm, mounting: Wave soldering, pin layout: Linear pinning, solder pin [P]: 3.6 mm, number of solder pins per potential: 2, plug-in system: COMBICON MSTB 2,5, Pin connector pattern alignment: Standard, locking: without, mounting: without, type of packaging: packed in cardboard

# MSTB 2,5/14-G-5,08-LA - PCB header

1770834

<https://www.phoenixcontact.com/pc/products/1770834>

## MSTBT 2,5/14-ST-5,08 - PCB connector

1781108

<https://www.phoenixcontact.com/pc/products/1781108>

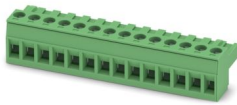

PCB connector, nominal cross section: 2.5 mm<sup>2</sup>, color: green, nominal current: 12 A, rated voltage (III/2): 320 V, contact surface: Tin, contact connection type: Socket, number of potentials: 14, number of rows: 1, number of positions: 14, number of connections: 14, product range: MSTBT 2,5/...-ST, pitch: 5.08 mm, connection method: Screw connection with tension sleeve, screw head form: L Slotted, conductor/PCB connection direction: 0 °, locking clip: - Locking clip, plug-in system: COMBICON MSTB 2,5, locking: without, mounting: without, type of packaging: packed in cardboard

---

## MSTBP 2,5/14-ST-5,08 - PCB connector

1769133

<https://www.phoenixcontact.com/pc/products/1769133>



PCB connector, nominal cross section: 2.5 mm<sup>2</sup>, color: green, nominal current: 12 A, rated voltage (III/2): 320 V, contact surface: Tin, contact connection type: Socket, number of potentials: 14, number of rows: 1, number of positions: 14, number of connections: 14, product range: MSTBP 2,5/...-ST, pitch: 5.08 mm, connection method: Screw connection with tension sleeve, screw head form: L Slotted, conductor/PCB connection direction: 0 °, locking clip: - Locking clip, plug-in system: COMBICON MSTB 2,5, locking: without, mounting: without, type of packaging: packed in cardboard

# MSTB 2,5/14-G-5,08-LA - PCB header

1770834

<https://www.phoenixcontact.com/pc/products/1770834>

## MSTB 2,5/14-STZ-5,08 - PCB connector

1764264

<https://www.phoenixcontact.com/pc/products/1764264>



PCB connector, nominal cross section: 2.5 mm<sup>2</sup>, color: green, nominal current: 12 A, rated voltage (III/2): 320 V, contact surface: Tin, contact connection type: Socket, number of potentials: 14, number of rows: 1, number of positions: 14, number of connections: 14, product range: MSTB 2,5/..-ST, pitch: 5.08 mm, connection method: Screw connection with tension sleeve, screw head form: L Slotted, conductor/PCB connection direction: 0 °, locking clip: - Locking clip, plug-in system: COMBICON MSTB 2,5, locking: without, mounting: without, type of packaging: packed in cardboard

## MSTB 2,5/14-ST-5,08 - PCB connector

1757132

<https://www.phoenixcontact.com/pc/products/1757132>

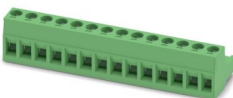

PCB connector, nominal cross section: 2.5 mm<sup>2</sup>, color: green, nominal current: 12 A, rated voltage (III/2): 320 V, contact surface: Tin, contact connection type: Socket, number of potentials: 14, number of rows: 1, number of positions: 14, number of connections: 14, product range: MSTB 2,5/..-ST, pitch: 5.08 mm, connection method: Screw connection with tension sleeve, screw head form: L Slotted, conductor/PCB connection direction: 0 °, locking clip: - Locking clip, plug-in system: COMBICON MSTB 2,5, locking: without, mounting: without, type of packaging: packed in cardboard

# MSTB 2,5/14-G-5,08-LA - PCB header



1770834

<https://www.phoenixcontact.com/pc/products/1770834>

## SMSTB 2,5/14-ST-5,08 - PCB connector

1826403

<https://www.phoenixcontact.com/pc/products/1826403>



PCB connector, nominal cross section: 2.5 mm<sup>2</sup>, color: green, nominal current: 12 A, rated voltage (III/2): 320 V, contact surface: Tin, contact connection type: Socket, number of potentials: 14, number of rows: 1, number of positions: 14, number of connections: 14, product range: SMSTB 2,5/...-ST, pitch: 5.08 mm, connection method: Screw connection with tension sleeve, screw head form: L Slotted, conductor/PCB connection direction: -45 °, locking clip: - Locking clip, plug-in system: COMBICON MSTB 2,5, locking: without, mounting: without, type of packaging: packed in cardboard

---

Phoenix Contact 2024 © - all rights reserved

<https://www.phoenixcontact.com>

PHOENIX CONTACT GmbH & Co. KG

Flachsmarktstraße 8

D-32825 Blomberg

+49 (0) 5235-3 00

[info@phoenixcontact.com](mailto:info@phoenixcontact.com)