

# MCV 1,5/10-G-3,5 P26 THR - PCB header



1779527

<https://www.phoenixcontact.com/pc/products/1779527>

Please be informed that the data shown in this PDF document is generated from our online catalog. Please find the complete data in the user documentation. Our general terms of use for downloads are valid.

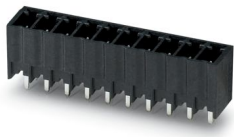

PCB headers, nominal cross section: 1.5 mm<sup>2</sup>, color: black, nominal current: 8 A, rated voltage (III/2): 160 V, contact surface: Tin, contact connection type: Pin, number of potentials: 10, number of rows: 1, number of positions: 10, number of connections: 10, product range: MCV 1,5/...-G-THR, pitch: 3.5 mm, mounting: THR soldering, pin layout: Linear pinning, solder pin [P]: 2.6 mm, number of solder pins per potential: 1, plug-in system: COMBICON MC 1,5, Pin connector pattern alignment: Standard, locking: without, mounting: without, type of packaging: packed in cardboard, For user information and design recommendations for through-hole reflow technology, go to: Downloads

## Your advantages

- Designed for integration into the SMT soldering process
- Vertical connection enables multi-row arrangement on the PCB
- Maximum flexibility when it comes to device design – one header for connectors with different connection technologies

## Commercial data

Item number	1779527
Packing unit	50 pc
Minimum order quantity	1 pc
Product key	AABTAF
Catalog page	Page 217 (C-1-2013)
GTIN	4046356531825
Weight per piece (including packing)	2.37 g
Weight per piece (excluding packing)	2.1 g
Customs tariff number	85366930
Country of origin	DE

# MCV 1,5/10-G-3,5 P26 THR - PCB header



1779527

<https://www.phoenixcontact.com/pc/products/1779527>

## Technical data

### Product properties

Product type	PCB headers
Product family	MCV 1,5/..-G-THR
Product line	COMBICON Connectors S
Type	Component suitable for through hole reflow
Number of positions	10
Pitch	3.5 mm
Number of connections	10
Number of rows	1
Number of potentials	10
Mounting flange	without
Pin layout	Linear pinning
Solder pins per potential	1

### Electrical properties

Nominal current $I_N$	8 A
Nominal voltage $U_N$	160 V
Degree of pollution	3
Contact resistance	1.6 m $\Omega$
Rated voltage (III/3)	160 V
Rated surge voltage (III/3)	2.5 kV
Rated voltage (III/2)	160 V
Rated surge voltage (III/2)	2.5 kV
Rated voltage (II/2)	250 V
Rated surge voltage (II/2)	2.5 kV

### Mounting

Mounting type	THR soldering
Pin layout	Linear pinning

### Processing notes

Process	Reflow/wave soldering
Moisture Sensitive Level	MSL 1
Classification temperature $T_c$	260 °C
Solder cycles in the reflow	3

### Material specifications

#### Material data - contact

Note	WEEE/RoHS-compliant, free of whiskers according to IEC 60068-2-82/JEDEC JESD 201
Contact material	Cu alloy
Surface characteristics	Tin-plated

# MCV 1,5/10-G-3,5 P26 THR - PCB header

1779527

<https://www.phoenixcontact.com/pc/products/1779527>

Metal surface contact area (top layer)	Tin (3 - 5 µm Sn)
Metal surface contact area (middle layer)	Nickel (1.3 - 3 µm Ni)
Metal surface soldering area (top layer)	Tin (3 - 5 µm Sn)
Metal surface soldering area (middle layer)	Nickel (1.3 - 3 µm Ni)

## Material data - housing

Color (Housing)	black (9005)
Insulating material	LCP
Insulating material group	IIIa
CTI according to IEC 60112	175
Flammability rating according to UL 94	V0

## Dimensions

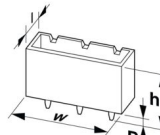
Dimensional drawing	
Pitch	3.5 mm
Width [w]	36.4 mm
Height [h]	11.8 mm
Length [l]	6.9 mm
Installed height	9.2 mm
Solder pin length [P]	2.6 mm
Pin dimensions	0.8 x 0.8 mm

## PCB design

Hole diameter	1.4 mm
---------------	--------

## Mechanical tests

### Visual inspection

Specification	IEC 60512-1-1:2002-02
Result	Test passed

### Dimension check

Specification	IEC 60512-1-2:2002-02
Result	Test passed

### Resistance of inscriptions

Specification	IEC 60068-2-70:1995-12
Result	Test passed

### Polarization and coding

Specification	IEC 60512-13-5:2006-02
Result	Test passed

# MCV 1,5/10-G-3,5 P26 THR - PCB header



1779527

<https://www.phoenixcontact.com/pc/products/1779527>

## Contact holder in insert

Specification	IEC 60512-15-1:2008-05
Contact holder in insert Requirements >20 N	Test passed

## Insertion and withdrawal forces

Result	Test passed
No. of cycles	25
Insertion strength per pos. approx.	9 N
Withdraw strength per pos. approx.	7 N

## Electrical tests

### Thermal test | Test group C

Specification	IEC 60512-5-1:2002-02
Tested number of positions	20

### Insulation resistance

Specification	IEC 60512-3-1:2002-02
Insulation resistance, neighboring positions	> 5 MΩ

### Air clearances and creepage distances |

Specification	IEC 60664-1:2007-04
Insulating material group	IIIa
Comparative tracking index (IEC 60112)	CTI 175
Rated insulation voltage (III/3)	160 V
Rated surge voltage (III/3)	2.5 kV
minimum clearance value - non-homogenous field (III/3)	1.5 mm
minimum creepage distance (III/3)	2.5 mm
Rated insulation voltage (III/2)	160 V
Rated surge voltage (III/2)	2.5 kV
minimum clearance value - non-homogenous field (III/2)	1.5 mm
minimum creepage distance (III/2)	1.6 mm
Rated insulation voltage (II/2)	250 V
Rated surge voltage (II/2)	2.5 kV
minimum clearance value - non-homogenous field (II/2)	1.5 mm
minimum creepage distance (II/2)	2.5 mm

## Environmental and real-life conditions

### Vibration test

Specification	IEC 60068-2-6:2007-12
Frequency	10 - 150 - 10 Hz
Sweep speed	1 octave/min
Amplitude	0.35 mm (10 Hz ... 60.1 Hz)
Acceleration	5g (60.1 Hz ... 150 Hz)

# MCV 1,5/10-G-3,5 P26 THR - PCB header



1779527

<https://www.phoenixcontact.com/pc/products/1779527>

Test duration per axis	2.5 h
------------------------	-------

## Durability test

Specification	IEC 60512-9-1:2010-03
Impulse withstand voltage at sea level	2.95 kV
Contact resistance R <sub>1</sub>	1.6 mΩ
Contact resistance R <sub>2</sub>	1.7 mΩ
Insertion/withdrawal cycles	25

## Climatic test

Specification	ISO 6988:1985-02
Corrosive stress	0.2 dm <sup>3</sup> SO <sub>2</sub> on 300 dm <sup>3</sup> /40 °C/1 cycle
Thermal stress	100 °C/168 h
Power-frequency withstand voltage	1.39 kV

## Ambient conditions

Ambient temperature (operation)	-40 °C ... 100 °C (dependent on the derating curve)
Ambient temperature (storage/transport)	-40 °C ... 70 °C
Relative humidity (storage/transport)	30 % ... 70 %
Ambient temperature (assembly)	-5 °C ... 100 °C

## Packaging specifications

Type of packaging	packed in cardboard
-------------------	---------------------

1779527

<https://www.phoenixcontact.com/pc/products/1779527>

## Drawings

Diagram

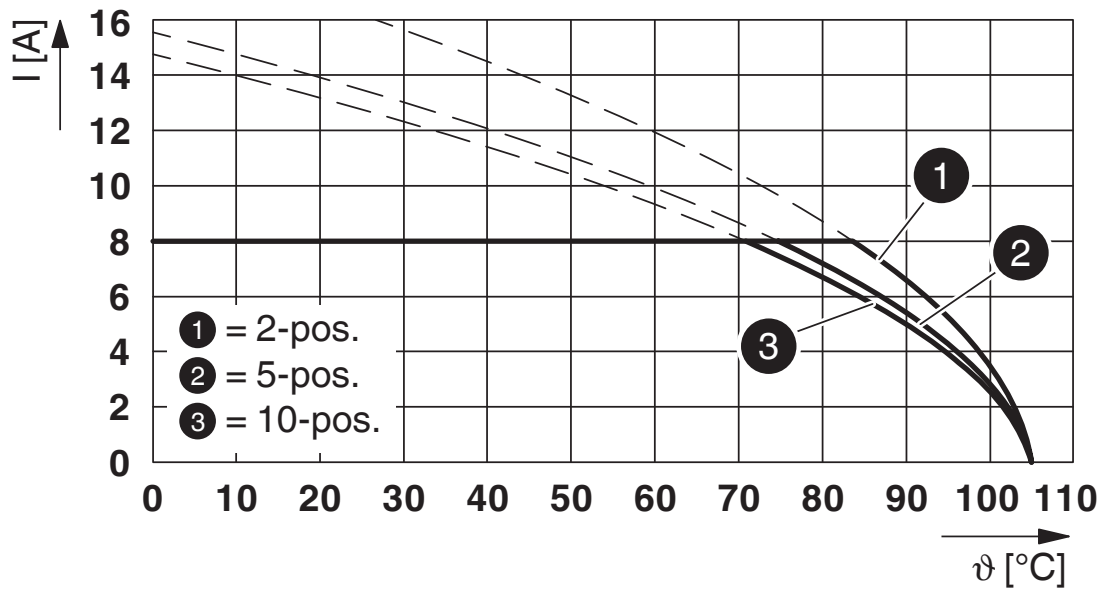

Type: TFMC 1,5/...-ST-3,5 with MCV 1,5/...-G-3,5 P... THR

Drilling plan/solder pad geometry

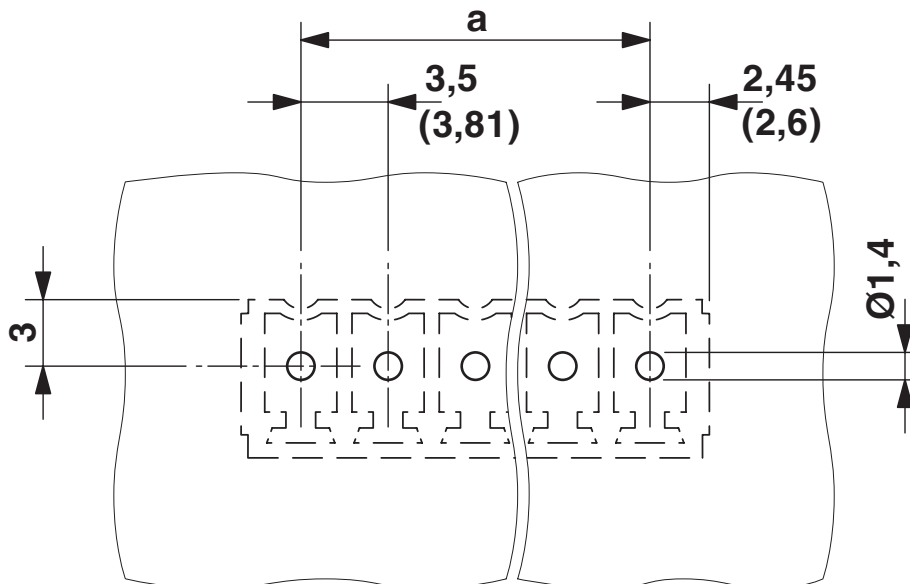

1779527

<https://www.phoenixcontact.com/pc/products/1779527>

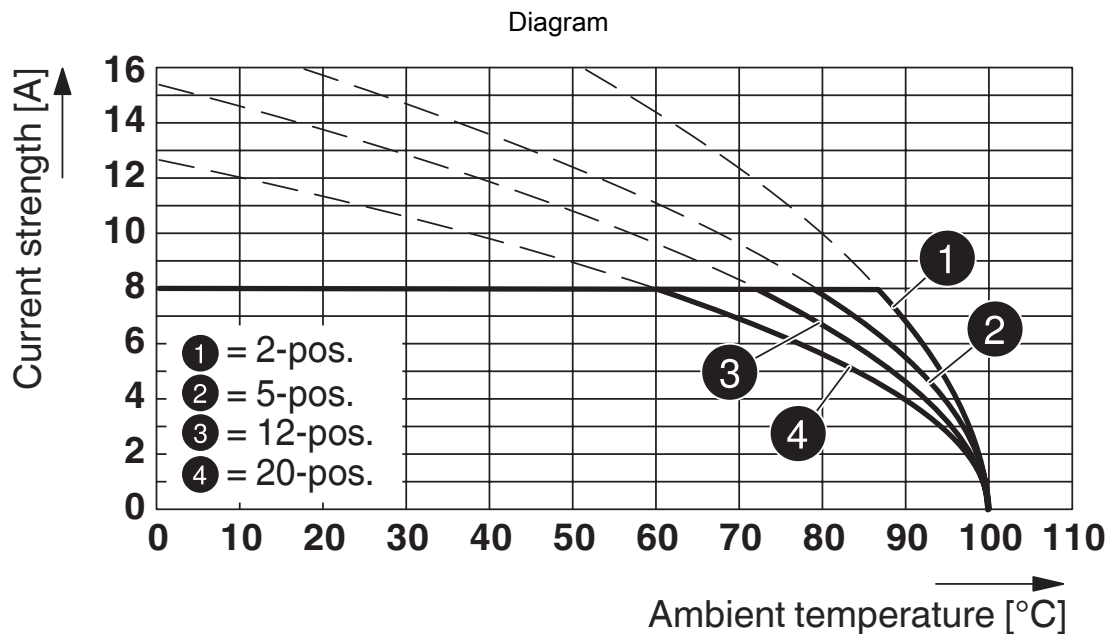

Type: FMC 1,5/...-ST-3,5 with MCV 1,5/...-G-3,5 P... THR

Dimensional drawing

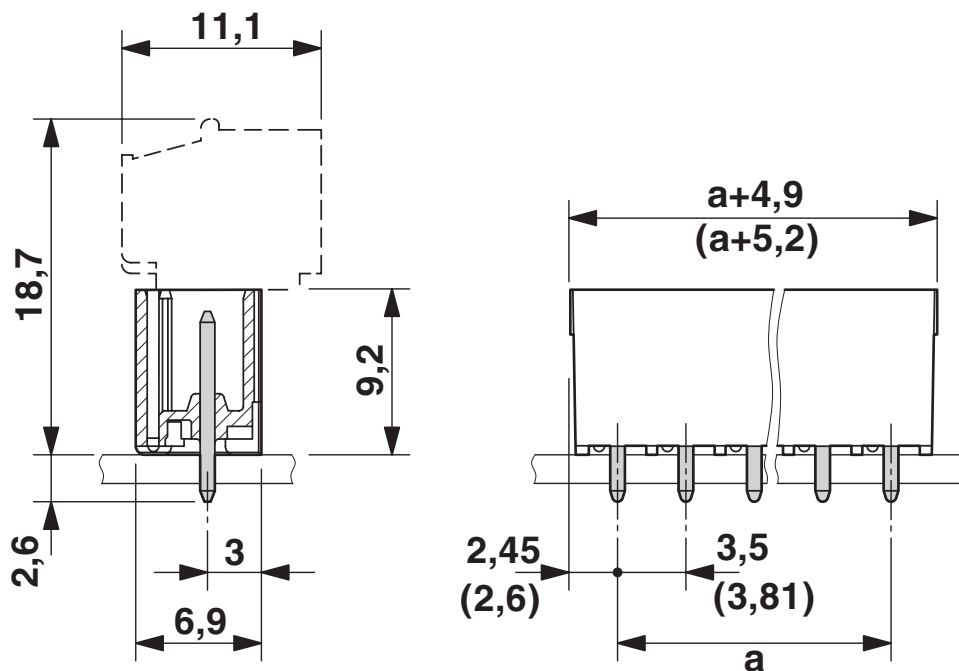

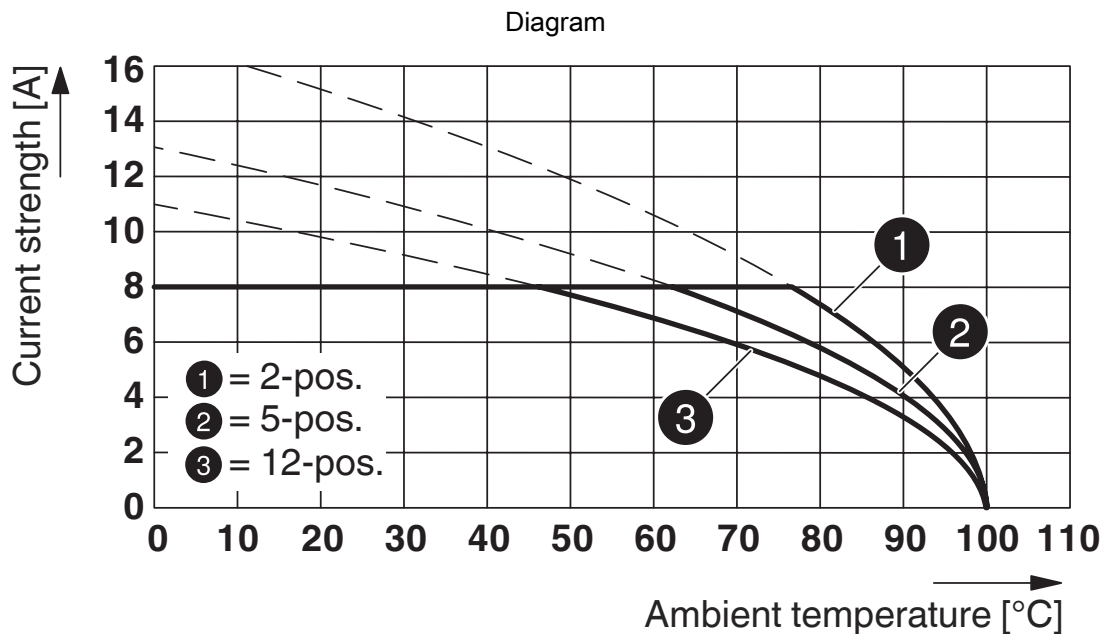

Type: MCVR 1,5/...-ST-3,5 with MCV 1,5/...-G-3,5 P26THR

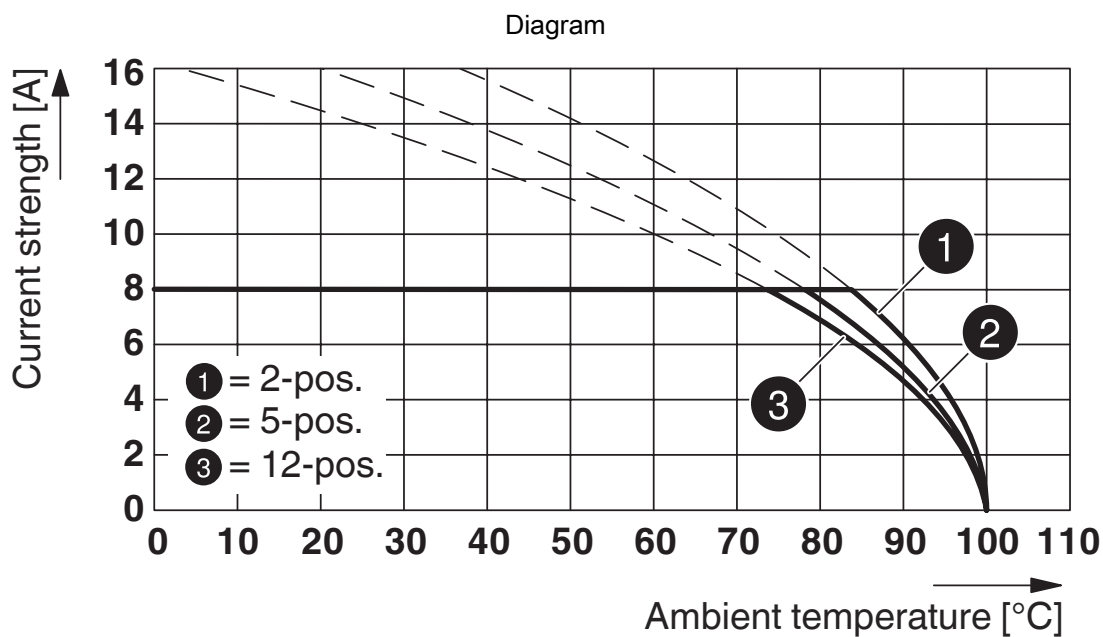

Type: FK-MCP 1,5/...-ST-3,5 with MCV 1,5/...-G-3,5 P... THR



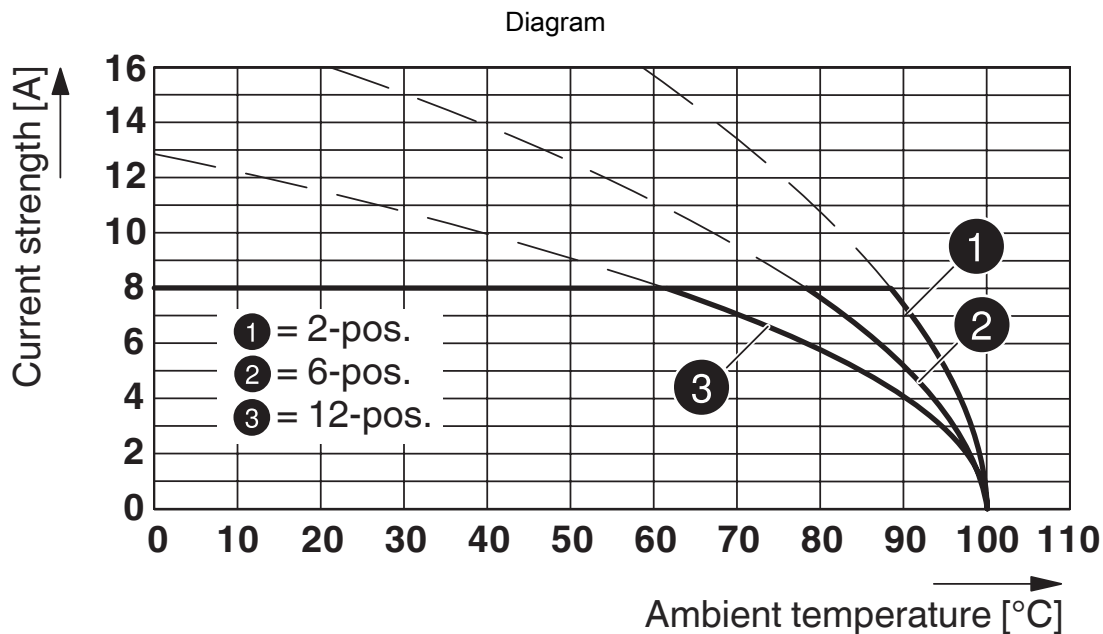

Type: IMCV 1,5/...-G-3,5 P20 THR with MCV 1,5/...-G-3,5 P26 THR

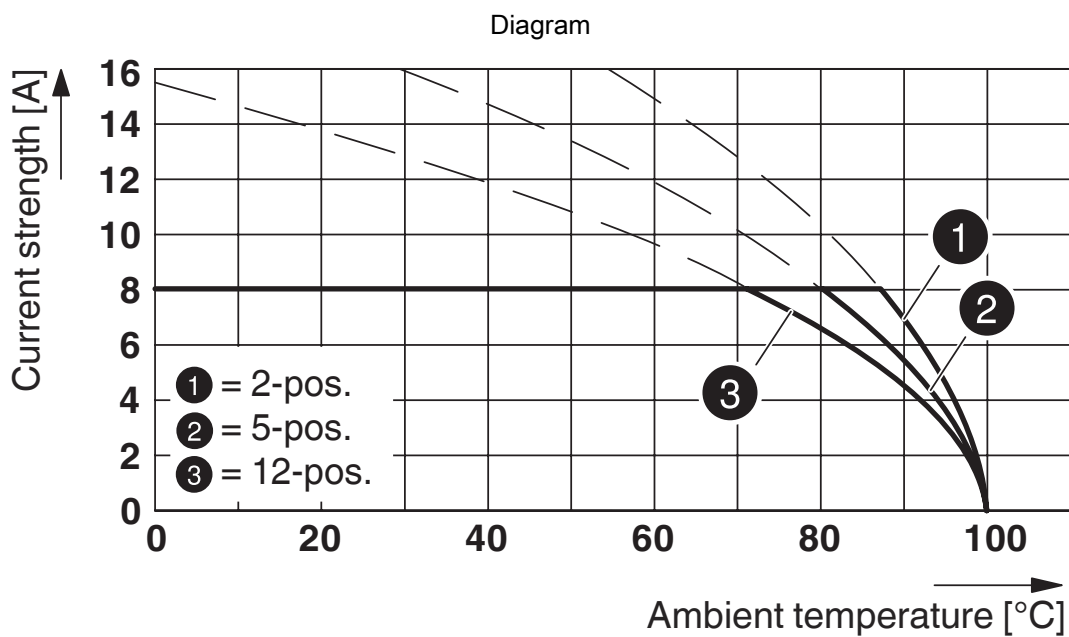

Type: MC 1,5/...-ST(F)-3,5 with MCV 1,5/...-G(F)-3,5 P... THR

# MCV 1,5/10-G-3,5 P26 THR - PCB header





1779527

<https://www.phoenixcontact.com/pc/products/1779527>

## Approvals

To download certificates, visit the product detail page: <https://www.phoenixcontact.com/pc/products/1779527>

 <b>VDE Zeichengenehmigung</b> Approval ID: 40057836				
	Nominal voltage $U_N$	Nominal current $I_N$	Cross section AWG	Cross section $\text{mm}^2$
	160 V	8 A	-	-

 <b>cULus Recognized</b> Approval ID: E60425-20110128				
	Nominal voltage $U_N$	Nominal current $I_N$	Cross section AWG	Cross section $\text{mm}^2$
Use group B	300 V	8 A	-	-
Use group D	300 V	8 A	-	-

 <b>VDE Zeichengenehmigung</b> Approval ID: 40011723				
	Nominal voltage $U_N$	Nominal current $I_N$	Cross section AWG	Cross section $\text{mm}^2$
	160 V	8 A	-	-

# MCV 1,5/10-G-3,5 P26 THR - PCB header



1779527

<https://www.phoenixcontact.com/pc/products/1779527>

## Classifications

### ECLASS

ECLASS-11.0	27460201
ECLASS-12.0	27460201
ECLASS-13.0	27460201

### ETIM

ETIM 9.0	EC002637
----------	----------

### UNSPSC

UNSPSC 21.0	39121400
-------------	----------

# MCV 1,5/10-G-3,5 P26 THR - PCB header



1779527

<https://www.phoenixcontact.com/pc/products/1779527>

## Environmental product compliance

### EU RoHS

Fulfills EU RoHS substance requirements	Yes, No exemptions
---	--------------------

### China RoHS

Environment friendly use period (EFUP)	EFUP-E
	No hazardous substances above the limits

### EU REACH SVHC

REACH candidate substance (CAS No.)	No substance above 0.1 wt%
-------------------------------------	----------------------------

# MCV 1,5/10-G-3,5 P26 THR - PCB header



1779527

<https://www.phoenixcontact.com/pc/products/1779527>

## Accessories

### XPC 1,5/10-ST-3,5 BK - PCB connector

1464114

<https://www.phoenixcontact.com/pc/products/1464114>



PCB connector, nominal cross section: 1.5 mm<sup>2</sup>, color: black, nominal current: 8 A, rated voltage (III/2): 160 V, contact surface: Tin, contact connection type: Socket, number of rows: 1, number of positions: 10, product range: XPC 1,5/..-ST, pitch: 3.5 mm, connection method: Push-X-connection, conductor/PCB connection direction: 0 °, locking clip: - without locking clip, plug-in system: COMBICON MC 1,5, locking: without, mounting: without, type of packaging: packed in cardboard

---

Phoenix Contact 2024 © - all rights reserved  
<https://www.phoenixcontact.com>

PHOENIX CONTACT GmbH & Co. KG  
Flachsmarktstraße 8  
D-32825 Blomberg  
+49 (0) 5235-3 00  
[info@phoenixcontact.com](mailto:info@phoenixcontact.com)