

# MC 1,5/ 4-ST-3,81 - PCB connector



1803594

<https://www.phoenixcontact.com/pc/products/1803594>

Please be informed that the data shown in this PDF document is generated from our online catalog. Please find the complete data in the user documentation. Our general terms of use for downloads are valid.

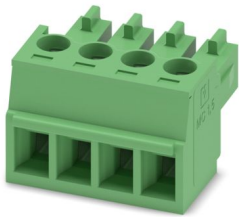

PCB connector, nominal cross section: 1.5 mm<sup>2</sup>, color: green, nominal current: 8 A, rated voltage (III/2): 160 V, contact surface: Tin, contact connection type: Socket, number of potentials: 4, number of rows: 1, number of positions: 4, number of connections: 4, product range: MC 1,5/..-ST, pitch: 3.81 mm, connection method: Screw connection with tension sleeve, screw head form: L Slotted, conductor/PCB connection direction: 0 °, plug-in system: COMBICON MC 1,5, locking: without, mounting: without, type of packaging: packed in cardboard

## Your advantages

- Well-known connection principle allows worldwide use
- Low temperature rise, thanks to maximum contact force
- Allows connection of two conductors

## Commercial data

|                                      |                     |
|--------------------------------------|---------------------|
| Item number                          | 1803594             |
| Packing unit                         | 250 pc              |
| Minimum order quantity               | 1 pc                |
| Product key                          | AABABA              |
| Catalog page                         | Page 190 (C-1-2013) |
| GTIN                                 | 4017918045906       |
| Weight per piece (including packing) | 3 g                 |
| Weight per piece (excluding packing) | 2.874 g             |
| Customs tariff number                | 85366990            |
| Country of origin                    | DE                  |

# MC 1,5/ 4-ST-3,81 - PCB connector



1803594

<https://www.phoenixcontact.com/pc/products/1803594>

## Technical data

### Product properties

|                       |                       |
|-----------------------|-----------------------|
| Product type          | PCB connector         |
| Product family        | MC 1,5/...-ST         |
| Product line          | COMBICON Connectors S |
| Type                  | Standard              |
| Number of positions   | 4                     |
| Pitch                 | 3.81 mm               |
| Number of connections | 4                     |
| Number of rows        | 1                     |
| Number of potentials  | 4                     |
| Mounting flange       | without               |

### Electrical properties

|                             |        |
|-----------------------------|--------|
| Nominal current $I_N$       | 8 A    |
| Nominal voltage $U_N$       | 160 V  |
| Degree of pollution         | 3      |
| Contact resistance          | 1.3 mΩ |
| Rated voltage (III/3)       | 160 V  |
| Rated surge voltage (III/3) | 2.5 kV |
| Rated voltage (III/2)       | 160 V  |
| Rated surge voltage (III/2) | 2.5 kV |
| Rated voltage (II/2)        | 320 V  |
| Rated surge voltage (II/2)  | 2.5 kV |

### Connection data

#### Connection technology

|                         |                     |
|-------------------------|---------------------|
| Type                    | Standard            |
| Connector system        | COMBICON MC 1,5     |
| Nominal cross section   | 1.5 mm <sup>2</sup> |
| Contact connection type | Socket              |

#### Interlock

|                 |         |
|-----------------|---------|
| Locking type    | without |
| Mounting flange | without |

#### Conductor connection

|  |  |
|--|--|
| Connection method  | Screw connection with tension sleeve         |
| Conductor/PCB connection direction                             | 0 °  |
| Conductor cross section rigid                                  | 0.14 mm <sup>2</sup> ... 1.5 mm <sup>2</sup> |
| Conductor cross section flexible                               | 0.14 mm <sup>2</sup> ... 1.5 mm <sup>2</sup> |
| Conductor cross section AWG                                    | 28 ... 16                                    |
| Conductor cross section flexible, with ferrule without plastic | 0.25 mm <sup>2</sup> ... 1.5 mm <sup>2</sup> |

# MC 1,5/ 4-ST-3,81 - PCB connector



1803594

<https://www.phoenixcontact.com/pc/products/1803594>

|   |   |
|---|---|
| sleeve  |   |
| Conductor cross section, flexible, with ferrule, with plastic sleeve                      | 0.25 mm <sup>2</sup> ... 0.75 mm <sup>2</sup> |
| 2 conductors with same cross section, solid   | 0.08 mm <sup>2</sup> ... 0.5 mm <sup>2</sup>  |
| 2 conductors with same cross section, flexible  | 0.08 mm <sup>2</sup> ... 0.75 mm <sup>2</sup> |
| 2 conductors with same cross section, flexible, with ferrule without plastic sleeve       | 0.25 mm <sup>2</sup> ... 0.34 mm <sup>2</sup> |
| 2 conductors with the same cross section, flexible, with TWIN ferrule with plastic sleeve | 0.5 mm <sup>2</sup> ... 0.5 mm <sup>2</sup>   |
| Cylindrical gauge a x b / diameter  | 2.4 mm x 1.5 mm / 1.6 mm                      |
| Stripping length  | 7 mm  |
| Tightening torque   | 0.22 Nm ... 0.25 Nm                           |

## Specifications for ferrules without insulating collar

|                           |                    |
|---------------------------|--------------------|
| recommended crimping tool | 1212034 CRIMPFOX 6 |
|---------------------------|--------------------|

## Specifications for ferrules with insulating collar

|                           |                    |
|---------------------------|--------------------|
| recommended crimping tool | 1212034 CRIMPFOX 6 |
|---------------------------|--------------------|

## Material specifications

### Material data - contact

|  |  |
|--|--|
| Note                                     | WEEE/RoHS-compliant, free of whiskers according to IEC 60068-2-82/JEDEC JESD 201 |
| Contact material                         | Cu alloy   |
| Surface characteristics                  | hot-dip tin-plated   |
| Metal surface terminal point (top layer) | Tin (4 - 8 µm Sn)  |
| Metal surface contact area (top layer)   | Tin (4 - 8 µm Sn)  |

### Material data - housing

|   |              |
|---|--------------|
| Color (Housing)   | green (6021) |
| Insulating material   | PA           |
| Insulating material group   | I            |
| CTI according to IEC 60112  | 600          |
| Flammability rating according to UL 94                            | V0           |
| Glow wire flammability index GWFI according to EN 60695-2-12      | 850          |
| Glow wire ignition temperature GWIT according to EN 60695-2-13    | 775          |
| Temperature for the ball pressure test according to EN 60695-10-2 | 125 °C       |

## Dimensions

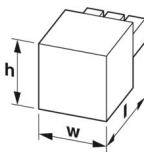
|                     |  |
|---------------------|--|
| Dimensional drawing |  |
| Pitch               | 3.81 mm  |

# MC 1,5/ 4-ST-3,81 - PCB connector



1803594

<https://www.phoenixcontact.com/pc/products/1803594>

|            |          |
|------------|----------|
| Width [w]  | 16.03 mm |
| Height [h] | 11.1 mm  |
| Length [l] | 16.1 mm  |

## Mounting

|                       |             |
|-----------------------|-------------|
| Drive form screw head | Slotted (L) |
|-----------------------|-------------|

## Mechanical tests

### Test for conductor damage and slackening

|               |                     |
|---------------|---------------------|
| Specification | IEC 60999-1:1999-11 |
| Result        | Test passed         |

### Pull-out test

|   |   |
|---|---|
| Specification   | IEC 60999-1:1999-11                     |
| Conductor cross section/conductor type/tractive force setpoint/actual value | 0.14 mm <sup>2</sup> / solid / > 7 N    |
|   | 0.14 mm <sup>2</sup> / flexible / > 7 N |
|   | 1.5 mm <sup>2</sup> / solid / > 40 N    |
|   | 1.5 mm <sup>2</sup> / flexible / > 40 N |

### Insertion and withdrawal forces

|                                     |             |
|-------------------------------------|-------------|
| Result                              | Test passed |
| No. of cycles                       | 25          |
| Insertion strength per pos. approx. | 6 N         |
| Withdraw strength per pos. approx.  | 4 N         |

### Torque test

|               |                     |
|---------------|---------------------|
| Specification | IEC 60999-1:1999-11 |
|---------------|---------------------|

### Resistance of inscriptions

|               |                        |
|---------------|------------------------|
| Specification | IEC 60068-2-70:1995-12 |
| Result        | Test passed            |

### Polarization and coding

|               |                        |
|---------------|------------------------|
| Specification | IEC 60512-13-5:2006-02 |
| Result        | Test passed            |

### Visual inspection

|               |                       |
|---------------|-----------------------|
| Specification | IEC 60512-1-1:2002-02 |
| Result        | Test passed           |

### Dimension check

|               |                       |
|---------------|-----------------------|
| Specification | IEC 60512-1-2:2002-02 |
| Result        | Test passed           |

## Environmental and real-life conditions

### Vibration test

|               |                       |
|---------------|-----------------------|
| Specification | IEC 60068-2-6:2007-12 |
|---------------|-----------------------|

# MC 1,5/ 4-ST-3,81 - PCB connector



1803594

<https://www.phoenixcontact.com/pc/products/1803594>

|                        |                             |
|------------------------|-----------------------------|
| Frequency              | 10 - 150 - 10 Hz            |
| Sweep speed            | 1 octave/min                |
| Amplitude              | 0.35 mm (10 Hz ... 60.1 Hz) |
| Acceleration           | 5g (60.1 Hz ... 150 Hz)     |
| Test duration per axis | 2.5 h                       |

## Durability test

|  |                       |
|--|-----------------------|
| Specification                                | IEC 60512-9-1:2010-03 |
| Impulse withstand voltage at sea level       | 2.95 kV               |
| Contact resistance R <sub>1</sub>            | 1.3 mΩ                |
| Contact resistance R <sub>2</sub>            | 1.5 mΩ                |
| Insertion/withdrawal cycles                  | 25                    |
| Insulation resistance, neighboring positions | > 5 MΩ                |

## Climatic test

|                                   |   |
|-----------------------------------|---|
| Specification                     | ISO 6988:1985-02  |
| Corrosive stress                  | 0.2 dm <sup>3</sup> SO <sub>2</sub> on 300 dm <sup>3</sup> /40 °C/1 cycle |
| Thermal stress                    | 100 °C/168 h  |
| Power-frequency withstand voltage | 1.39 kV   |

## Ambient conditions

|   |   |
|---|---|
| Ambient temperature (operation)         | -40 °C ... 100 °C (dependent on the derating curve) |
| Ambient temperature (storage/transport) | -40 °C ... 70 °C                                    |
| Relative humidity (storage/transport)   | 30 % ... 70 %                                       |
| Ambient temperature (assembly)          | -5 °C ... 100 °C                                    |

## Electrical tests

### Thermal test | Test group C

|                            |                       |
|----------------------------|-----------------------|
| Specification              | IEC 60512-5-1:2002-02 |
| Tested number of positions | 20                    |

### Insulation resistance

|  |                       |
|--|-----------------------|
| Specification                                | IEC 60512-3-1:2002-02 |
| Insulation resistance, neighboring positions | > 5 MΩ                |

### Air clearances and creepage distances |

|  |   |
|--|---|
| Specification  | IEC 60664-1:2007-04                                   |
| Insulating material group                              | I   |
| Comparative tracking index (IEC 60112)                 | CTI 600   |
| Rated insulation voltage (III/3)                       | 160 V   |
| Rated surge voltage (III/3)                            | 2.5 kV  |
| minimum clearance value - non-homogenous field (III/3) | 1.5 mm  |
| minimum creepage distance (III/3)                      | 2 mm  |
| Note on connection cross section                       | With connected conductor 1.5 mm <sup>2</sup> (solid). |
| Rated insulation voltage (III/2)                       | 160 V   |
| Rated surge voltage (III/2)                            | 2.5 kV  |

# MC 1,5/ 4-ST-3,81 - PCB connector



1803594

<https://www.phoenixcontact.com/pc/products/1803594>

|  |        |
|--|--------|
| minimum clearance value - non-homogenous field (III/2) | 1.5 mm |
| minimum creepage distance (III/2)                      | 1.5 mm |
| Rated insulation voltage (II/2)                        | 320 V  |
| Rated surge voltage (II/2)                             | 2.5 kV |
| minimum clearance value - non-homogenous field (II/2)  | 1.5 mm |
| minimum creepage distance (II/2)                       | 1.6 mm |

## Packaging specifications

|                   |                     |
|-------------------|---------------------|
| Type of packaging | packed in cardboard |
|-------------------|---------------------|

# MC 1,5/ 4-ST-3,81 - PCB connector



1803594

<https://www.phoenixcontact.com/pc/products/1803594>

## Drawings

Diagram

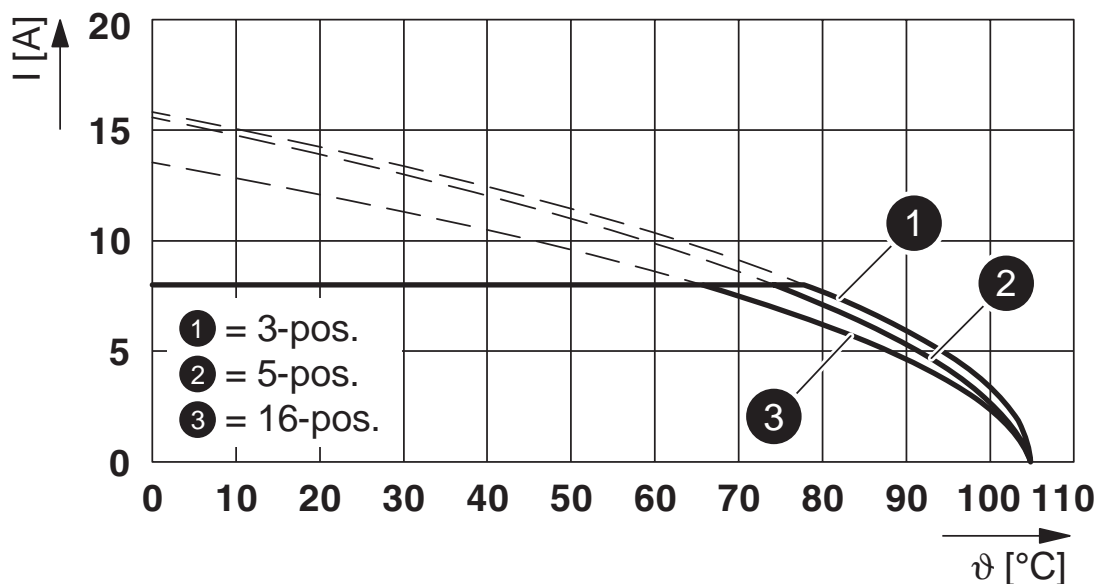

Type: MC 1,5/...-ST-3,81 with MCVK 1,5/...-G-3,81

Diagram

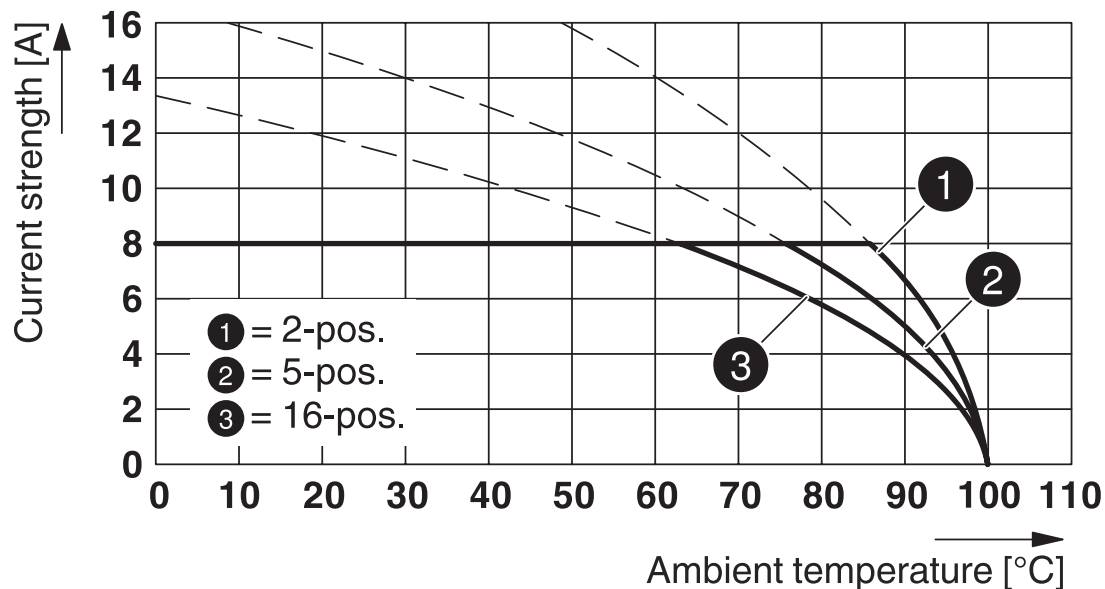

Type: MC 1,5/...-ST-3,81 with MCDV 1,5/...-G1-3,81

# MC 1,5/ 4-ST-3,81 - PCB connector



1803594

<https://www.phoenixcontact.com/pc/products/1803594>

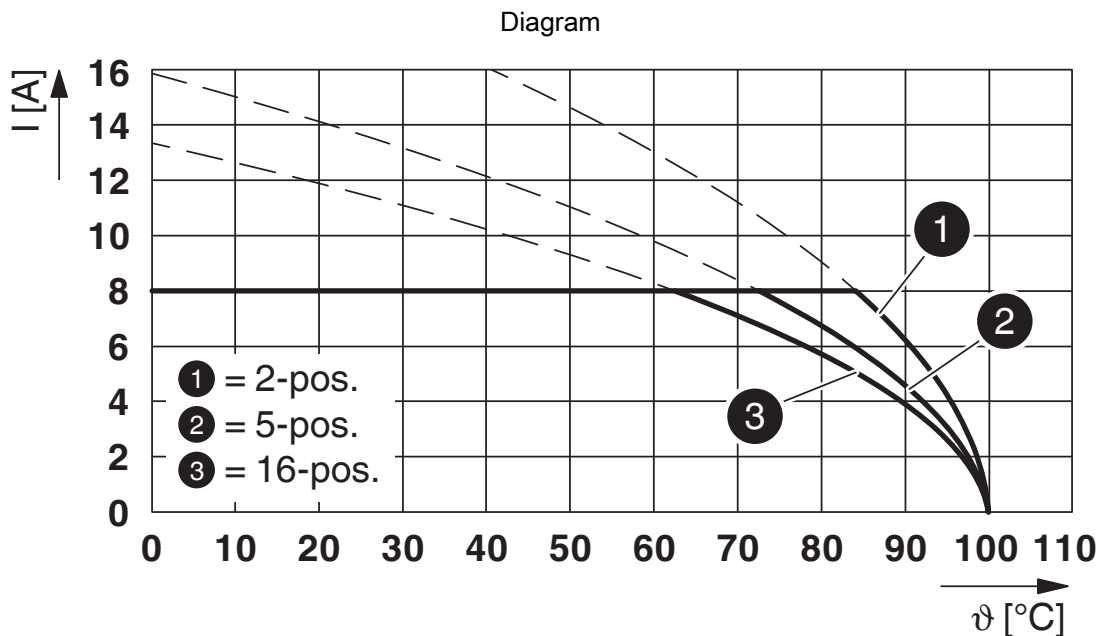

Type: MC 1,5/...-ST-3,81 with MCD 1,5/...-G-3,81

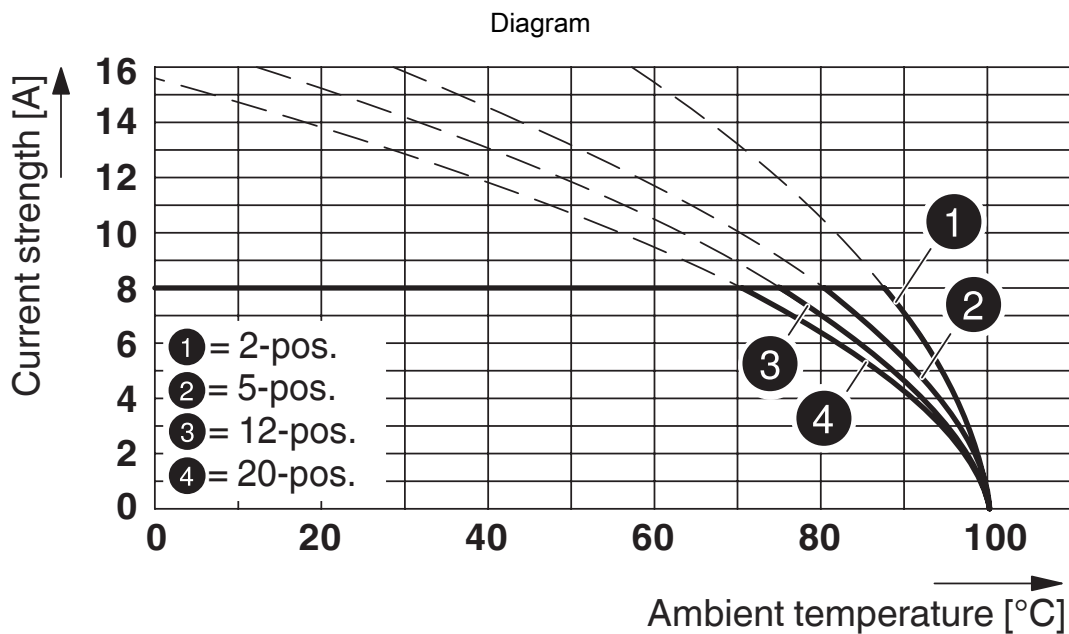

Type: MC 1,5/...-ST-3,81 with MC 1,5/...-G-3,81



# MC 1,5/ 4-ST-3,81 - PCB connector

1803594

<https://www.phoenixcontact.com/pc/products/1803594>

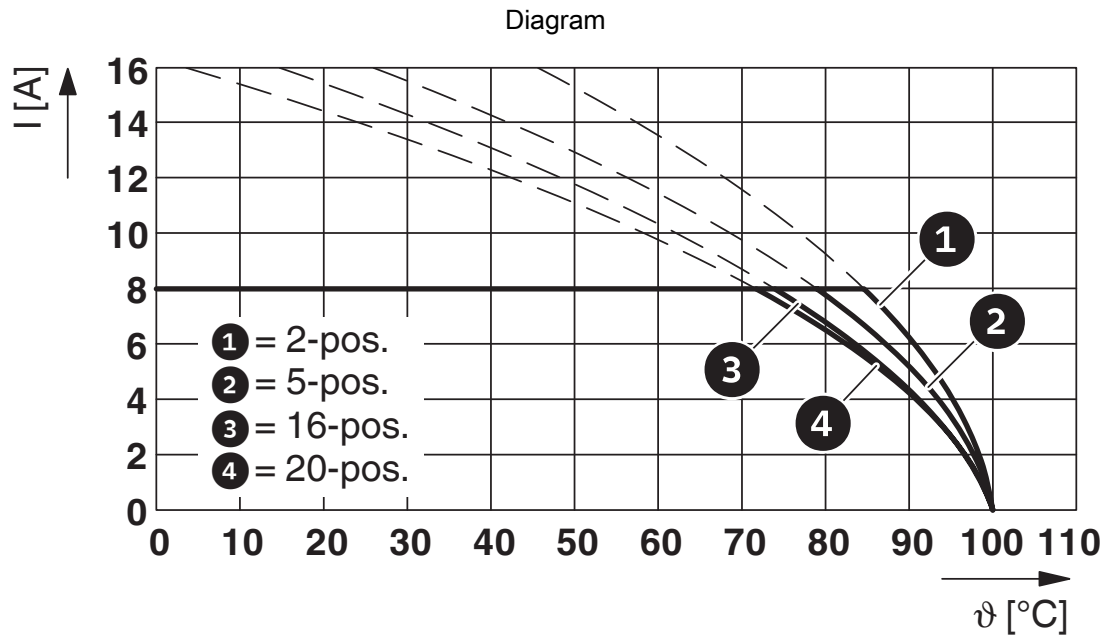

Type: MC 1,5/...-ST-3,81 with MC 1,5/...-G-3,81 P...THR

Dimensional drawing

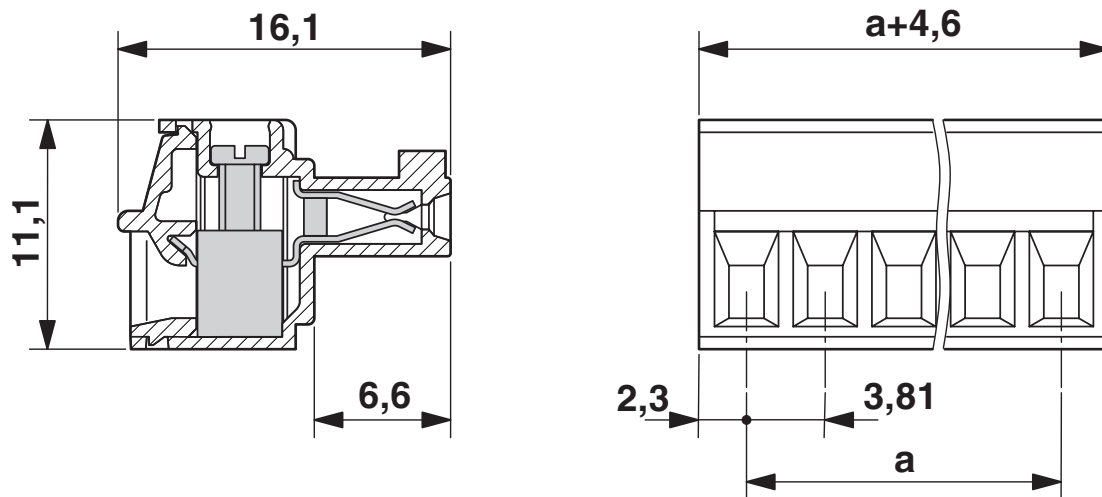

# MC 1,5/ 4-ST-3,81 - PCB connector



1803594

<https://www.phoenixcontact.com/pc/products/1803594>

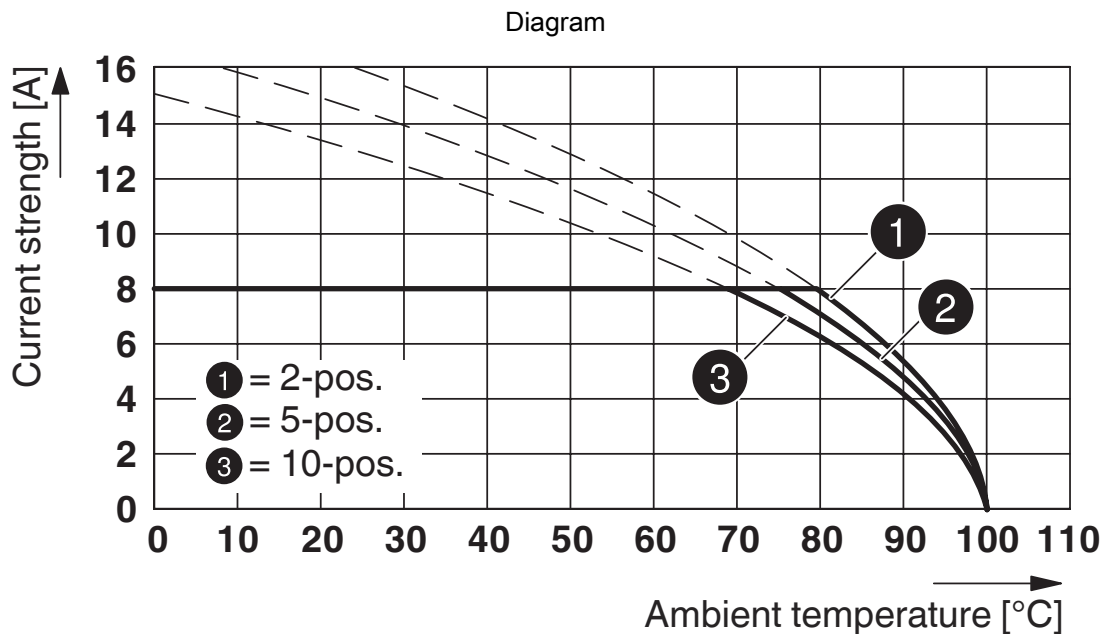

Type: MC 1,5/...-ST-3,81 with MCO 1,5/...-GR-3,81

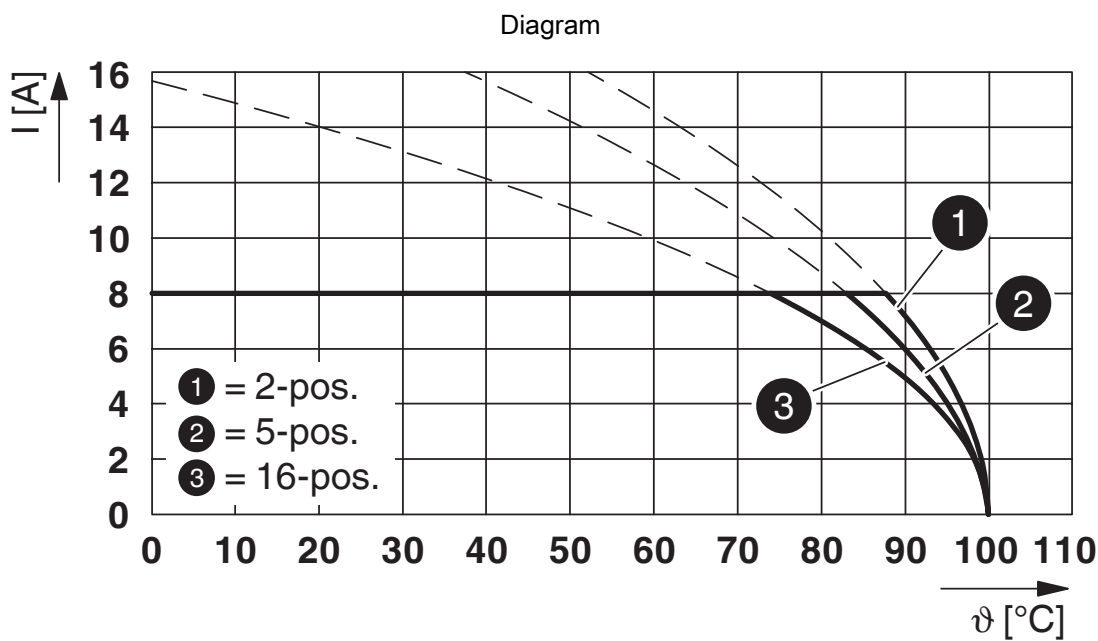

Type: MC 1,5/...-ST-3,81 with SMC 1,5/...-G-3,81

# MC 1,5/ 4-ST-3,81 - PCB connector



1803594

<https://www.phoenixcontact.com/pc/products/1803594>

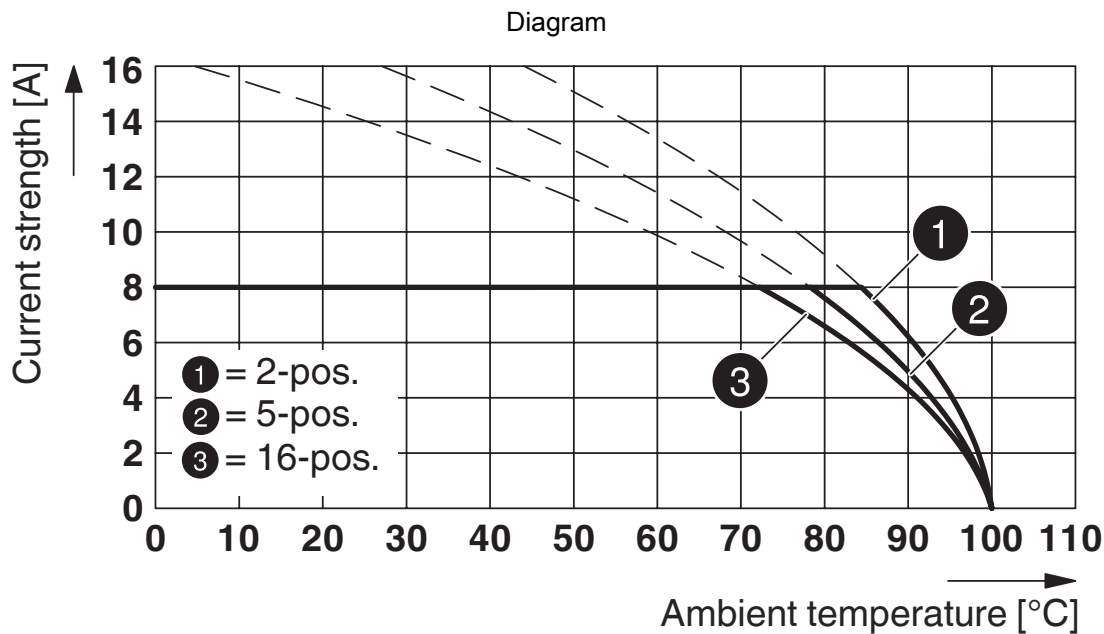

Type: MC 1,5/...-ST-3,81 with IMC 1,5/...-ST-3,81

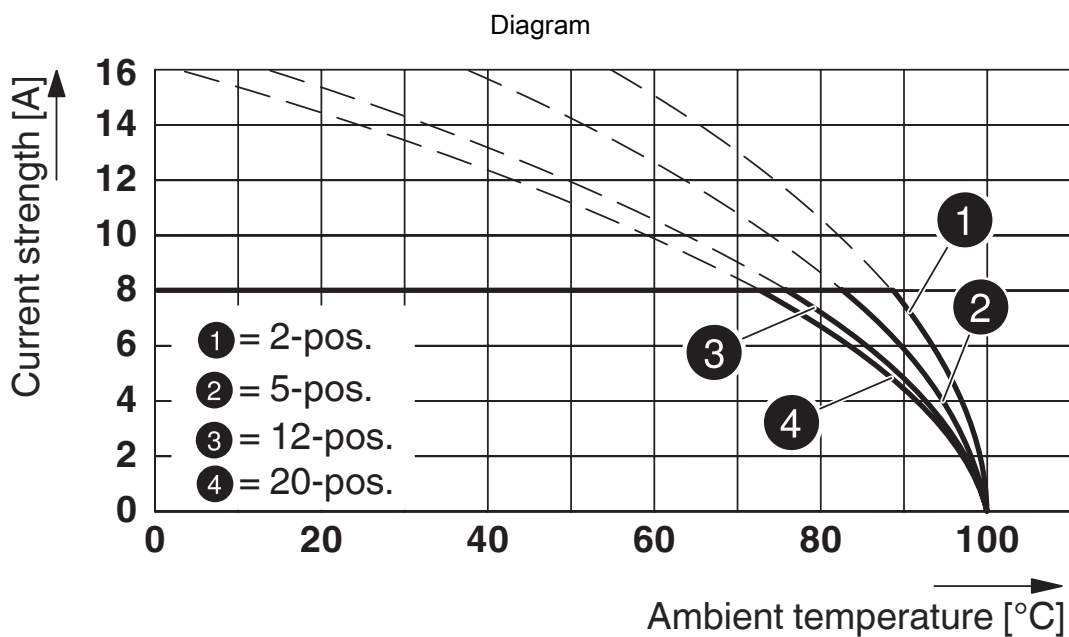

Type: MC 1,5/...-ST-3,81 with MCV 1,5/...-G-3,81

# MC 1,5/ 4-ST-3,81 - PCB connector



1803594

<https://www.phoenixcontact.com/pc/products/1803594>

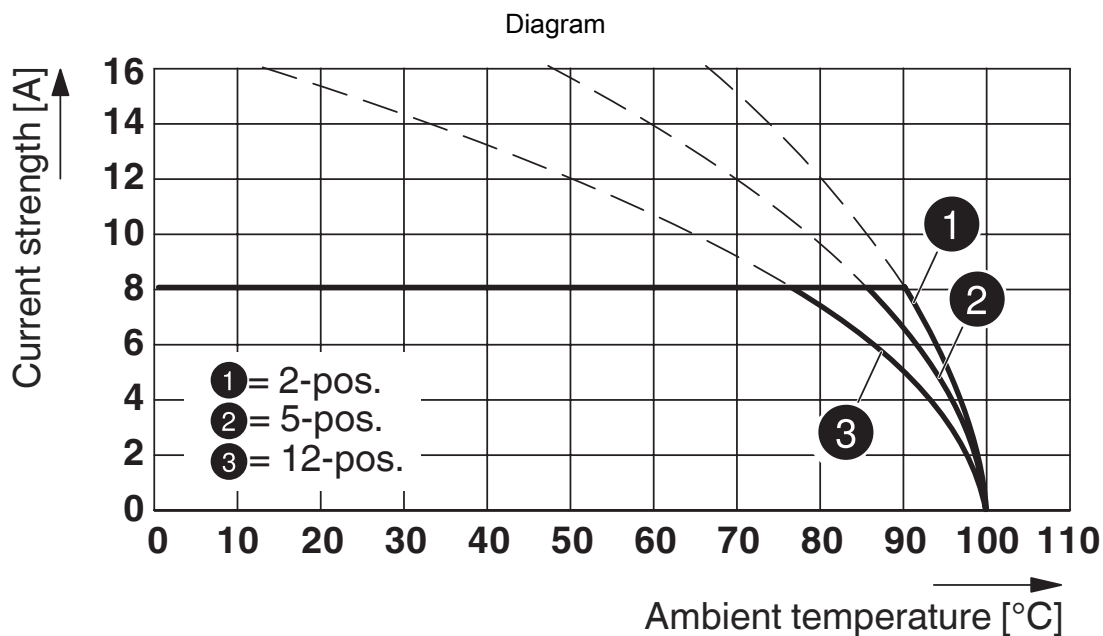

Type: MC 1,5/...-ST-3,81 with MCV 1,5/...-G-3,81 P26 THR

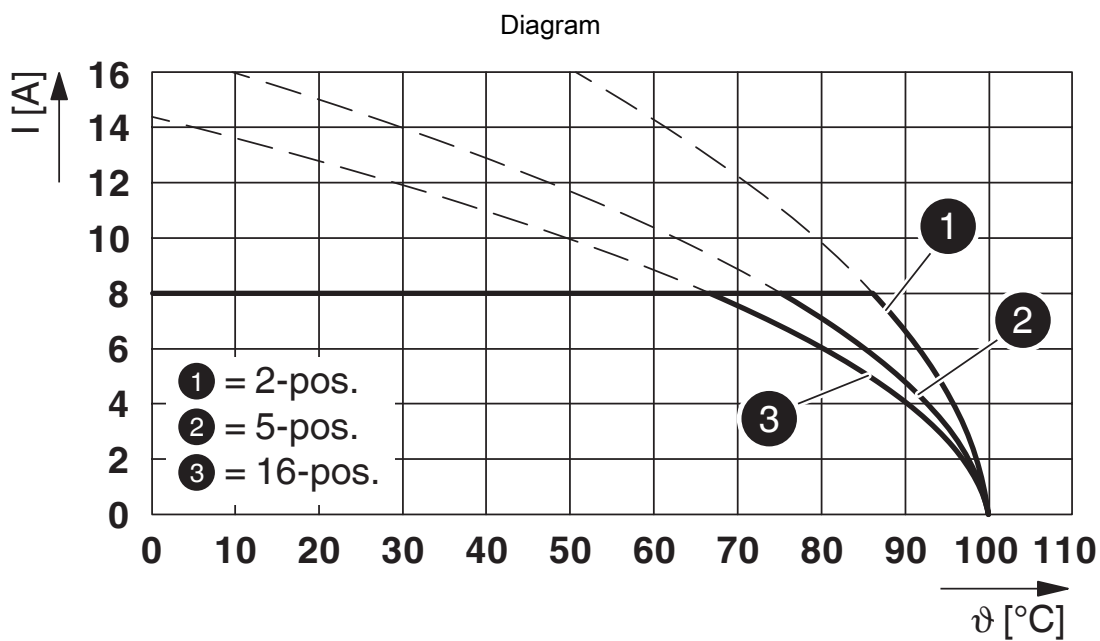

Type: MC 1,5/...-ST-3,81 with MCDV 1,5/...-G-3,81

# MC 1,5/ 4-ST-3,81 - PCB connector



1803594

<https://www.phoenixcontact.com/pc/products/1803594>

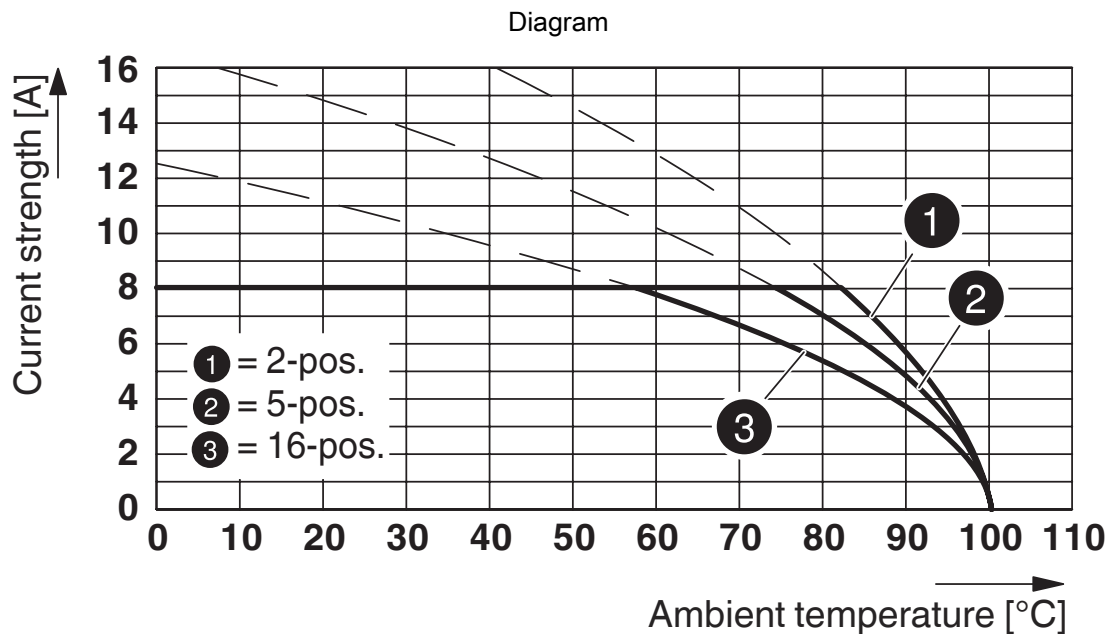

Type: MC 1,5/...-ST-3,81 with MCD 1,5/...-G1-3,81

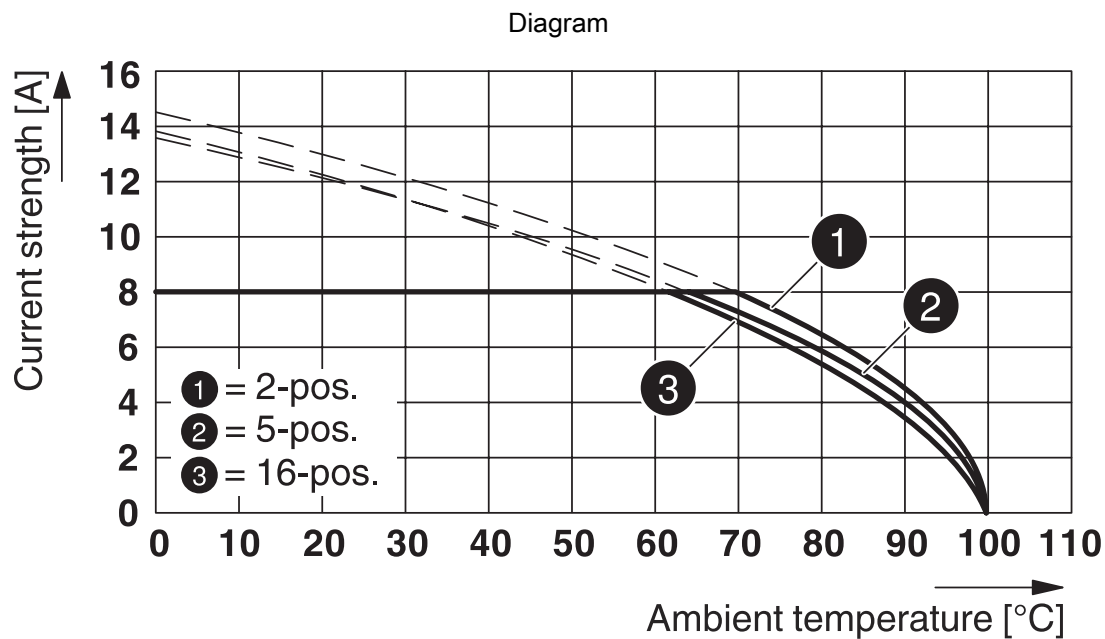

Type: MC 1,5/...-ST-3,81 with MCVU 1,5/...-GFD-3,81

# MC 1,5/ 4-ST-3,81 - PCB connector





1803594

<https://www.phoenixcontact.com/pc/products/1803594>

## Approvals

To download certificates, visit the product detail page: <https://www.phoenixcontact.com/pc/products/1803594>

|  <b>CSA</b><br>Approval ID: 13631 |                       |                       |                   |                             |
|--|-----------------------|-----------------------|-------------------|-----------------------------|
|  | Nominal voltage $U_N$ | Nominal current $I_N$ | Cross section AWG | Cross section $\text{mm}^2$ |
| Use group B  | 300 V                 | 8 A                   | 28 - 16           | -                           |
| Use group D  | 300 V                 | 8 A                   | 28 - 16           | -                           |

|  <b>cULus Recognized</b><br>Approval ID: E60425-20110128 |                       |                       |                   |                             |
|---|-----------------------|-----------------------|-------------------|-----------------------------|
|   | Nominal voltage $U_N$ | Nominal current $I_N$ | Cross section AWG | Cross section $\text{mm}^2$ |
| Use group B   | 300 V                 | 8 A                   | 30 - 14           | -                           |
| Use group D   | 300 V                 | 8 A                   | 30 - 14           | -                           |

|  <b>VDE Zeichengenehmigung</b><br>Approval ID: 40011723 |                       |                       |                   |                             |
|--|-----------------------|-----------------------|-------------------|-----------------------------|
|  | Nominal voltage $U_N$ | Nominal current $I_N$ | Cross section AWG | Cross section $\text{mm}^2$ |
|  | 160 V                 | 8 A                   | -                 | 0.2 - 1.5                   |

# MC 1,5/ 4-ST-3,81 - PCB connector



1803594

<https://www.phoenixcontact.com/pc/products/1803594>

## Classifications

### ECLASS

|             |          |
|-------------|----------|
| ECLASS-11.0 | 27460202 |
| ECLASS-12.0 | 27460202 |
| ECLASS-13.0 | 27460202 |

### ETIM

|          |          |
|----------|----------|
| ETIM 9.0 | EC002638 |
|----------|----------|

### UNSPSC

|             |          |
|-------------|----------|
| UNSPSC 21.0 | 39121400 |
|-------------|----------|

# MC 1,5/ 4-ST-3,81 - PCB connector



1803594

<https://www.phoenixcontact.com/pc/products/1803594>

## Environmental product compliance

### EU RoHS

|   |                    |
|---|--------------------|
| Fulfills EU RoHS substance requirements | Yes, No exemptions |
|---|--------------------|

### China RoHS

|  |  |
|--|--|
| Environment friendly use period (EFUP) | EFUP-E                                   |
|  | No hazardous substances above the limits |

### EU REACH SVHC

|                                     |                            |
|-------------------------------------|----------------------------|
| REACH candidate substance (CAS No.) | No substance above 0.1 wt% |
|-------------------------------------|----------------------------|

Phoenix Contact 2024 © - all rights reserved  
<https://www.phoenixcontact.com>

PHOENIX CONTACT GmbH & Co. KG  
Flachmarktstraße 8  
D-32825 Blomberg  
+49 (0) 5235-3 00  
[info@phoenixcontact.com](mailto:info@phoenixcontact.com)