

VC-TR4/5M - Sleeve frame

1852927

<https://www.phoenixcontact.com/pc/products/1852927>

Please be informed that the data shown in this PDF document is generated from our online catalog. Please find the complete data in the user documentation. Our general terms of use for downloads are valid.



Sleeve frame, Range of articles: VARIOCON, design: VC4, housing material: Polyamide, color: black

Commercial data

Item number	1852927
Packing unit	5 pc
Minimum order quantity	5 pc
Product key	ABLABB
Catalog page	Page 358 (PC-2009)
GTIN	4017918134334
Weight per piece (including packing)	11.78 g
Weight per piece (excluding packing)	11.6 g
Customs tariff number	85389099
Country of origin	PL

Technical data

Notes

Safety note

<p>Safety note</p>	<p>WARNING: The connectors may not be plugged in or disconnected under load. Ignoring the warning or improper use may damage persons and/or property.</p> <ul style="list-style-type: none"> • WARNING: Commission properly functioning products only. The products must be regularly inspected for damage. Decommission defective products immediately. Replace damaged products. Repairs are not possible. • WARNING: Only electrically qualified personnel may install and operate the product. They must observe the following safety notes. The qualified personnel must be familiar with the basics of electrical engineering. They must be able to recognize and prevent danger. The relevant symbol on the packaging indicates that only personnel familiar with electrical engineering are allowed to install and operate the product. • The products are suitable for applications in plant, controller, and electrical device engineering. • When operating the connectors in outdoor applications, they must be separately protected against environmental influences. • Assembled products may not be manipulated or improperly opened. • Only use mating connectors that are specified in the technical data of the standards listed (e.g. the ones listed in the product accessories online at phoenixcontact.com/products). • When using the product in direct connection with third-party manufacturers, the user is responsible. • For operating voltages > 50 V AC, conductive connector housings must be grounded • Ensure that the protective or functional ground has been properly connected. • VDE 0100/1.97 § 411.1.3.2 and DIN EN 60 204/11.98 § 14.1.3 are applicable when combining several circuits in a cable and/or connector • Observe the corresponding technical data. You will find information: <ul style="list-style-type: none"> o On the product o On the packing label o In the supplied documentation o Online at phoenixcontact.com/products under the product • Only use tools recommended by Phoenix Contact • The installation notes/Design In documents online on the download page at phoenixcontact.com/products must be observed for this product. • Use a protective cap to protect connectors that are not in use. The suitable accessories are available online in the accessory section of the product at phoenixcontact.com/products • Operate the connector only when it is fully plugged in. • Ensure that when laying the cable, the tensile load on the connectors does not exceed the upper limit specified in the
--------------------	---

VC-TR4/5M - Sleeve frame

1852927

<https://www.phoenixcontact.com/pc/products/1852927>

	standards.
	<ul style="list-style-type: none">• Observe the minimum bending radius of the cable. Lay the cable without twisting it.
	<ul style="list-style-type: none">• The connector warms up in normal operation. Depending on the ambient conditions, the surface of the connector can continue to warm up. In this case, the user is responsible for posting warnings (e.g. DIN EN ISO 13732-1:2008-12).

Product properties

Product type	Contact insert
Product family	VARIOCON
Series	VC-M
Type	VC4
Number of module slots	5

Connection data

Tightening torque	0.8 ... 0.8 Nm
-------------------	----------------

Dimensions

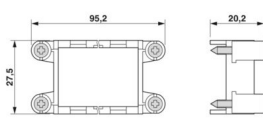
Dimensional drawing	
Width	95.2 mm
Height	27.5 mm
Depth	20.2 mm
Length	20.2 mm

Material specifications

Color	black
Color of the housing part	black
Material	PA-GF
Material	Polyamide
Flammability rating according to UL 94	V2
Housing material	Polyamide
Material for screw connection	Steel, galvanized

Environmental and real-life conditions

Ambient conditions

Ambient temperature (operation)	-40 °C ... 100 °C
---------------------------------	-------------------

VC-TR4/5M - Sleeve frame

1852927

<https://www.phoenixcontact.com/pc/products/1852927>



Drawings

Dimensional drawing

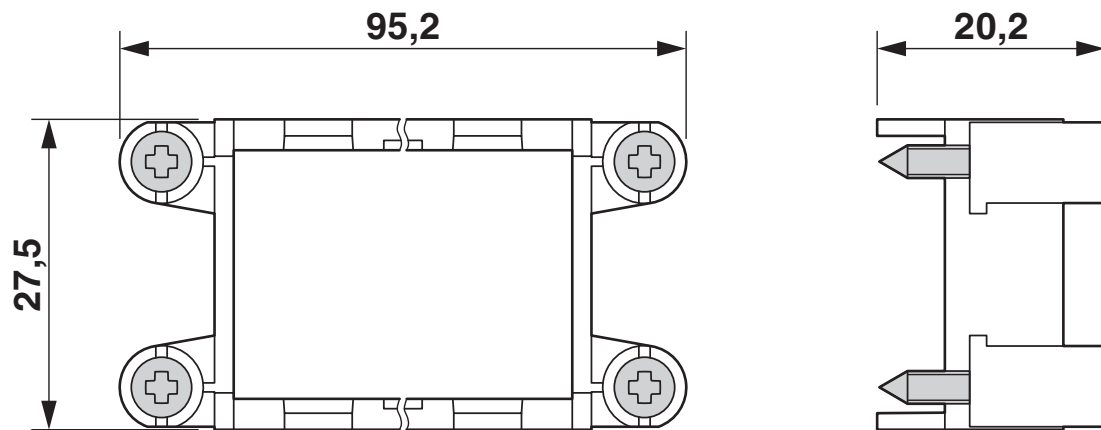

VC-TR4/5M - Sleeve frame

1852927

<https://www.phoenixcontact.com/pc/products/1852927>



Classifications

ECLASS

ECLASS-12.0	27144001
ECLASS-11.0	27440210
ECLASS-13.0	27440210

ETIM

ETIM 9.0	EC000007
----------	----------

UNSPSC

UNSPSC 21.0	31261500
-------------	----------

VC-TR4/5M - Sleeve frame

1852927

<https://www.phoenixcontact.com/pc/products/1852927>



Environmental product compliance

China RoHS	Environmentally friendly use period: unlimited = EFUP-e No hazardous substances above threshold values
------------	---

Phoenix Contact 2024 © - all rights reserved
<https://www.phoenixcontact.com>

PHOENIX CONTACT GmbH & Co. KG
Flachmarktstraße 8
D-32825 Blomberg
+49 (0) 5235-3 00
info@phoenixcontact.com