

IPC 16/ 9-G-10,16 - PCB header



1969603

<https://www.phoenixcontact.com/pc/products/1969603>

Please be informed that the data shown in this PDF document is generated from our online catalog. Please find the complete data in the user documentation. Our general terms of use for downloads are valid.



PCB headers, nominal cross section: 16 mm², color: green, nominal current: 76 A, rated voltage (III/2): 1000 V, contact surface: Silver, contact connection type: Socket, number of potentials: 9, number of rows: 1, number of positions: 9, number of connections: 9, product range: IPC 16/..-G, pitch: 10.16 mm, mounting: Wave soldering, pin layout: Linear pinning, solder pin [P]: 4 mm, number of solder pins per potential: 3, plug-in system: COMBICON PC 16, Pin connector pattern alignment: Standard, locking: without, mounting: without, type of packaging: packed in cardboard

Your advantages

- Well-known mounting principle allows worldwide use
- Maximum flexibility when it comes to device design – one header for connectors with different connection technologies
- Inverted header with socket contacts for touch-proof device outputs or PCB/PCB connections
- Integrated double steel spring provides additional safety in the event of temperature and power fluctuations

Commercial data

Item number	1969603
Packing unit	50 pc
Minimum order quantity	1 pc
Note	Made to order (non-returnable)
Product key	AAESCA
Catalog page	Page 570 (C-1-2013)
GTIN	4017918943844
Weight per piece (including packing)	33.91 g
Weight per piece (excluding packing)	31.564 g
Customs tariff number	85366930
Country of origin	PL

IPC 16/ 9-G-10,16 - PCB header



1969603

<https://www.phoenixcontact.com/pc/products/1969603>

Technical data

Product properties

Product type	PCB headers
Product family	IPC 16/..-G
Product line	COMBICON Connectors XL
Type	Inverted
Number of positions	9
Pitch	10.16 mm
Number of connections	9
Number of rows	1
Number of potentials	9
Mounting flange	without
Pin layout	Linear pinning
Solder pins per potential	3

Electrical properties

Nominal current I_N	76 A
Nominal voltage U_N	1000 V
Degree of pollution	3
Contact resistance	0.3 mΩ
Rated voltage (III/3)	1000 V
Rated surge voltage (III/3)	8 kV
Rated voltage (III/2)	1000 V
Rated surge voltage (III/2)	8 kV
Rated voltage (II/2)	1000 V
Rated surge voltage (II/2)	6 kV

Mounting

Mounting type	Wave soldering
Pin layout	Linear pinning

Material specifications

Material data - contact

Note	WEEE/RoHS-compliant, free of whiskers according to IEC 60068-2-82/JEDEC JESD 201
Contact material	Cu alloy
Surface characteristics	completely silver-plated
Metal surface contact area (top layer)	Silver (4 - 8 μm Ag)
Metal surface soldering area (top layer)	Silver (4 - 8 μm Ag)

Material data - housing

Color (Housing)	green (6021)
Insulating material	PA

IPC 16/ 9-G-10,16 - PCB header

1969603

<https://www.phoenixcontact.com/pc/products/1969603>

Insulating material group	I
CTI according to IEC 60112	600
Flammability rating according to UL 94	V0
Glow wire flammability index GWFI according to EN 60695-2-12	850
Glow wire ignition temperature GWIT according to EN 60695-2-13	775
Temperature for the ball pressure test according to EN 60695-10-2	125 °C

Notes

Notes on operation	In accordance with IEC 61984, COMBICON connectors have no switching power (COC). During designated use, they must not be plugged in or disconnected when carrying voltage or under load.
--------------------	--

Dimensions

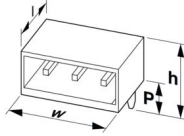
Dimensional drawing	
Pitch	10.16 mm
Width [w]	92.24 mm
Height [h]	17.6 mm
Length [l]	32.1 mm
Installed height	13.6 mm
Solder pin length [P]	4 mm
Pin dimensions	0.8 x 1.2 mm
PCB design	
Pin spacing	10.16 mm
Hole diameter	1.7 mm

Mechanical tests

Visual inspection	
Specification	IEC 60512-1:2001-01
Result	Test passed
Dimension check	
Specification	IEC 60512-1:2001-01
Result	Test passed
Resistance of inscriptions	
Specification	IEC 60068-2-70:1995-12
Result	Test passed

Polarization and coding

IPC 16/ 9-G-10,16 - PCB header



1969603

<https://www.phoenixcontact.com/pc/products/1969603>

Specification	IEC 60512-7:1993-08 (Polarization)
Result	Test passed

Contact holder in insert

Specification	IEC 60512-8:1993-01
Contact holder in insert Requirements >20 N	Test passed

Insertion and withdrawal forces

Result	Test passed
No. of cycles	50
Insertion strength per pos. approx.	12 N
Withdraw strength per pos. approx.	11 N

Electrical tests

Thermal test | Test group C

Specification	IEC 60512-5-1:2002-02
Tested number of positions	9

Insulation resistance

Specification	IEC 60512-2:1985-00
Insulation resistance, neighboring positions	$10^{12} \Omega$

Air clearances and creepage distances |

Specification	IEC 60664-1:2007-04
Insulating material group	I
Comparative tracking index (IEC 60112)	CTI 600
Rated insulation voltage (III/3)	1000 V
Rated surge voltage (III/3)	8 kV
minimum clearance value - non-homogenous field (III/3)	8 mm
minimum creepage distance (III/3)	12.5 mm
Rated insulation voltage (III/2)	1000 V
Rated surge voltage (III/2)	8 kV
minimum clearance value - non-homogenous field (III/2)	8 mm
minimum creepage distance (III/2)	8 mm
Rated insulation voltage (II/2)	1000 V
Rated surge voltage (II/2)	6 kV
minimum clearance value - non-homogenous field (II/2)	5.5 mm
minimum creepage distance (II/2)	5.5 mm

Environmental and real-life conditions

Vibration test

Specification	IEC 60068-2-6:1995-03
Frequency	10 - 150 - 10 Hz
Sweep speed	1 octave/min

IPC 16/ 9-G-10,16 - PCB header



1969603

<https://www.phoenixcontact.com/pc/products/1969603>

Amplitude	0.35 mm (10 Hz ... 60.1 Hz)
Acceleration	5g (60.1 Hz ... 150 Hz)
Test duration per axis	2.5 h

Durability test

Specification	IEC 60512-5:1992-08
Impulse withstand voltage at sea level	9.8 kV
Contact resistance R_1	0.3 m Ω
Contact resistance R_2	0.4 m Ω
Insertion/withdrawal cycles	50

Climatic test

Specification	ISO 6988:1985-02
Corrosive stress	KFW 0.2 S/1 cycle
Thermal stress	100 °C/168 h
Power-frequency withstand voltage	4.26 kV

Ambient conditions

Ambient temperature (operation)	-40 °C ... 100 °C (dependent on the derating curve)
Ambient temperature (storage/transport)	-40 °C ... 70 °C
Relative humidity (storage/transport)	30 % ... 70 %
Ambient temperature (assembly)	-5 °C ... 100 °C

Packaging specifications

Type of packaging	packed in cardboard
Outer packaging type	Carton

Drawings

Diagram

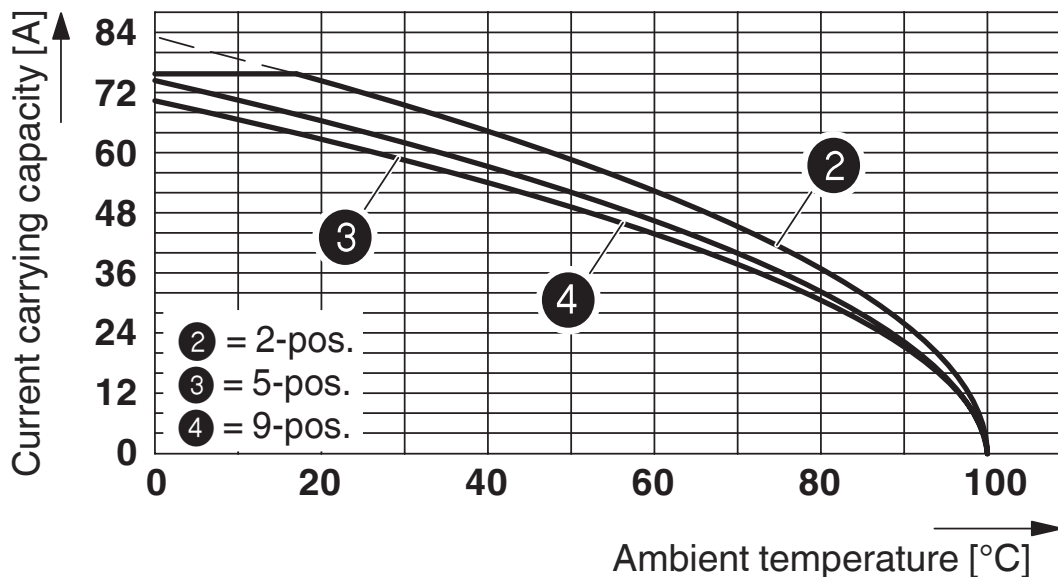

Derating curve for: IPC 16/...-ST-10,16 with IPC 16/...-G-10,16

Diagram

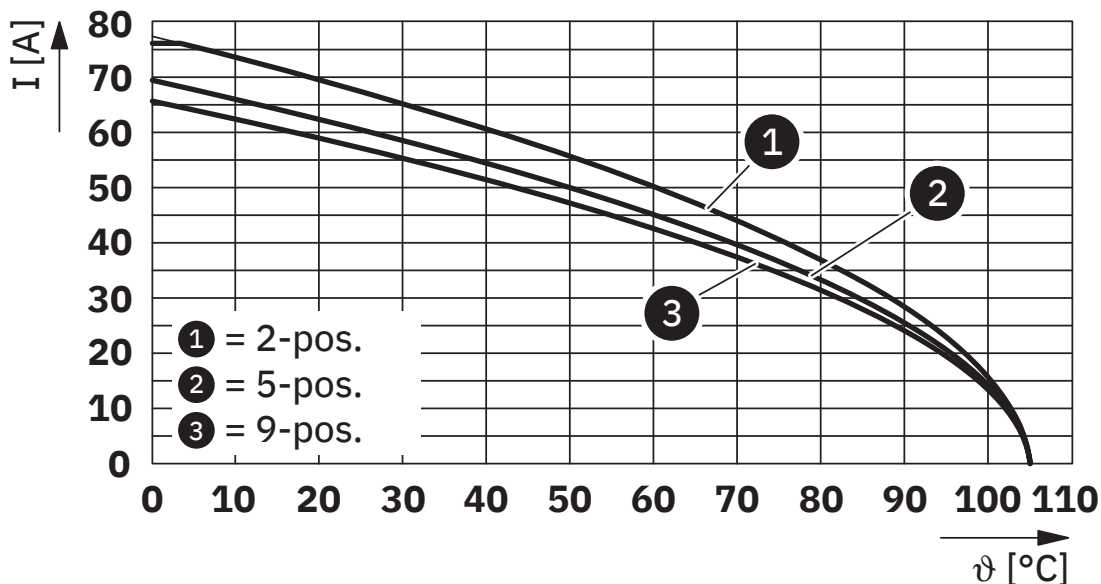

Type: ISPC 16/...-ST-10,16 with IPC 16/...-G-10,16

IPC 16/ 9-G-10,16 - PCB header

1969603

<https://www.phoenixcontact.com/pc/products/1969603>

Drilling plan/solder pad geometry

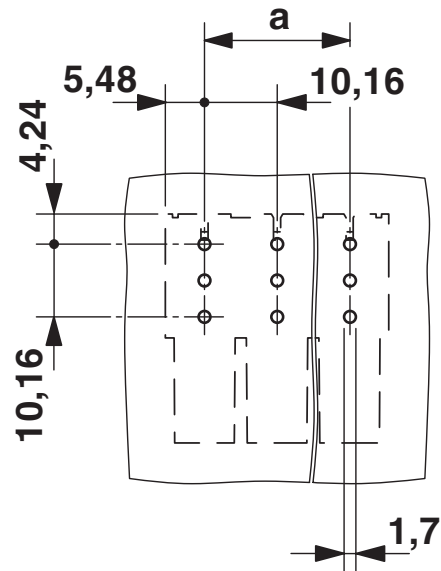

The figure shows the 3-pos. version

Dimensional drawing

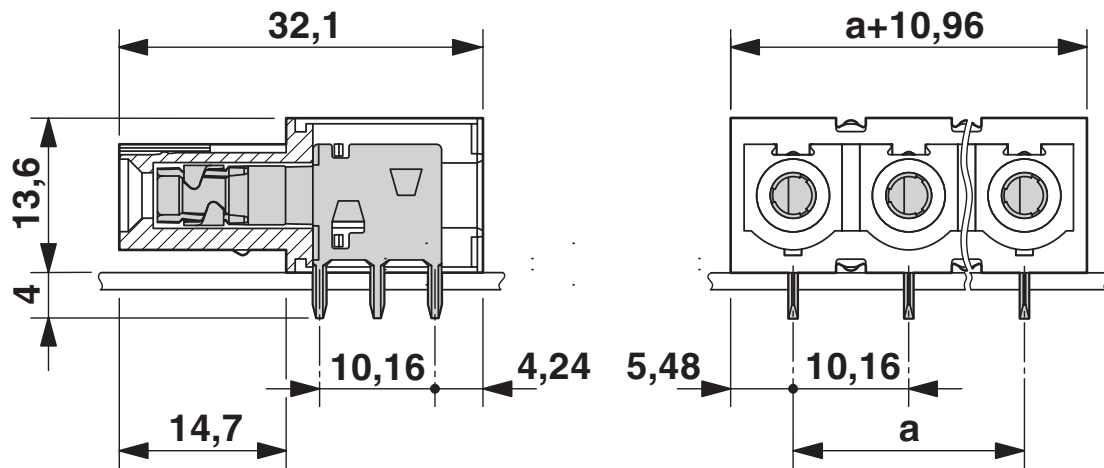

The figure shows the 3-pos. version

IPC 16/ 9-G-10,16 - PCB header





1969603

<https://www.phoenixcontact.com/pc/products/1969603>

Approvals

To download certificates, visit the product detail page: <https://www.phoenixcontact.com/pc/products/1969603>

 cULus Recognized Approval ID: E60425-20040202				
	Nominal voltage U_N	Nominal current I_N	Cross section AWG	Cross section mm^2
Use group B	300 V	66 A	-	-
Use group C	300 V	66 A	-	-
Use group D	600 V	5 A	-	-

 VDE Zeichengenehmigung Approval ID: 40055586				
	Nominal voltage U_N	Nominal current I_N	Cross section AWG	Cross section mm^2
	1000 V	76 A	-	-

IPC 16/ 9-G-10,16 - PCB header



1969603

<https://www.phoenixcontact.com/pc/products/1969603>

Classifications

ECLASS

ECLASS-11.0	27460201
ECLASS-12.0	27460201
ECLASS-13.0	27460201

ETIM

ETIM 9.0	EC002637
----------	----------

UNSPSC

UNSPSC 21.0	39121400
-------------	----------

IPC 16/ 9-G-10,16 - PCB header



1969603

<https://www.phoenixcontact.com/pc/products/1969603>

Environmental product compliance

EU RoHS

Fulfills EU RoHS substance requirements	Yes, No exemptions
---	--------------------

China RoHS

Environment friendly use period (EFUP)	EFUP-E
	No hazardous substances above the limits

EU REACH SVHC

REACH candidate substance (CAS No.)	No substance above 0.1 wt%
-------------------------------------	----------------------------

IPC 16/ 9-G-10,16 - PCB header



1969603

<https://www.phoenixcontact.com/pc/products/1969603>

Accessories

CP-PC RD - Coding profile

1701967

<https://www.phoenixcontact.com/pc/products/1701967>

Coding profile, for plugging into the coding ribs of the plug at a later date, insulating material, color: Red



SK U/5,0 WH:UNBEDRUCKT - Marker card

0803922

<https://www.phoenixcontact.com/pc/products/0803922>

Marker card, Din A4, white, unlabeled, can be labeled with: PLOTMARK, CMS-P1-PLOTTER, Office printing systems, mounting type: adhesive, for terminal block width: 210 mm, lettering field size: 186 x 5 mm, Number of individual labels: 630



IPC 16/ 9-G-10,16 - PCB header

1969603

<https://www.phoenixcontact.com/pc/products/1969603>



IPC 16/ 9-ST-10,16 - PCB connector

1969441

<https://www.phoenixcontact.com/pc/products/1969441>



PCB connector, nominal cross section: 16 mm², color: green, nominal current: 76 A, rated voltage (III/2): 1000 V, contact surface: Silver, contact connection type: Pin, number of potentials: 9, number of rows: 1, number of positions: 9, number of connections: 9, product range: IPC 16/...-ST, pitch: 10.16 mm, connection method: Screw connection with tension sleeve, screw head form: L Slotted, conductor/PCB connection direction: 0 °, locking clip: - without locking clip, plug-in system: COMBICON PC 16, locking: without, mounting: without, type of packaging: packed in cardboard

ISPC 16/ 9-ST-10,16 - PCB connector

1748613

<https://www.phoenixcontact.com/pc/products/1748613>

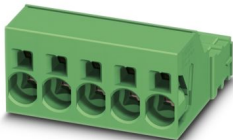

PCB connector, nominal cross section: 16 mm², color: green, nominal current: 76 A, rated voltage (III/2): 1000 V, contact surface: Silver, contact connection type: Pin, number of potentials: 9, number of rows: 1, number of positions: 9, number of connections: 9, product range: ISPC 16/...-ST, pitch: 10.16 mm, connection method: Push-in spring connection, conductor/PCB connection direction: 0 °, locking clip: - without locking clip, plug-in system: COMBICON PC 16, locking: without, mounting: without, type of packaging: packed in cardboard

IPC 16/ 9-G-10,16 - PCB header

1969603

<https://www.phoenixcontact.com/pc/products/1969603>



PC 6-16/ 9-G1-10,16 - PCB header

1996391

<https://www.phoenixcontact.com/pc/products/1996391>



PCB headers, nominal cross section: 16 mm², color: green, nominal current: 76 A (41 A in combination with PC 6 plug), rated voltage (III/2): 1000 V, contact surface: Silver, contact connection type: Pin, number of potentials: 9, number of rows: 1, number of positions: 9, number of connections: 9, product range: PC 6-16/...-G1, pitch: 10.16 mm, mounting: Wave soldering, pin layout: Linear pinning, solder pin [P]: 4 mm, number of solder pins per potential: 3, plug-in system: COMBICON PC 16, Pin connector pattern alignment: Standard, locking: without, mounting: without, type of packaging: packed in cardboard

PC 6-16/ 9-G1U-10,16 - PCB header

1996304

<https://www.phoenixcontact.com/pc/products/1996304>



PCB headers, nominal cross section: 16 mm², color: green, nominal current: 76 A (41 A in combination with PC 6 plug), rated voltage (III/2): 1000 V, contact surface: Silver, contact connection type: Pin, number of potentials: 9, number of rows: 1, number of positions: 9, number of connections: 9, product range: PC 6-16/...-G1U, pitch: 10.16 mm, mounting: Wave soldering, pin layout: Linear pinning, solder pin [P]: 4 mm, number of solder pins per potential: 3, plug-in system: COMBICON PC 16, Pin connector pattern alignment: reversed, locking: without, mounting: without, type of packaging: packed in cardboard

IPC 16/ 9-G-10,16 - PCB header

1969603

<https://www.phoenixcontact.com/pc/products/1969603>



PCV 6-16/ 9-G1-10,16 - PCB header

1998852

<https://www.phoenixcontact.com/pc/products/1998852>



PCB headers, nominal cross section: 16 mm², color: green, nominal current: 76 A (41 A in combination with PC 6 plug), rated voltage (III/2): 1000 V, contact surface: Silver, contact connection type: Pin, number of potentials: 9, number of rows: 1, number of positions: 9, number of connections: 9, product range: PCV 6-16/..-G1, pitch: 10.16 mm, mounting: Wave soldering, pin layout: Linear pinning, solder pin [P]: 4 mm, number of solder pins per potential: 3, plug-in system: COMBICON PC 16, Pin connector pattern alignment: Standard, locking: without, mounting: without, type of packaging: packed in cardboard

Phoenix Contact 2024 © - all rights reserved

<https://www.phoenixcontact.com>

PHOENIX CONTACT GmbH & Co. KG

Flachsmarktstraße 8

D-32825 Blomberg

+49 (0) 5235-3 00

info@phoenixcontact.com