

PTSA 1,5/23-3,5-F - PCB terminal block



1985179

<https://www.phoenixcontact.com/us/products/1985179>

Please be informed that the data shown in this PDF document is generated from our online catalog. Please find the complete data in the user documentation. Our general terms of use for downloads are valid.

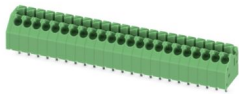

PCB terminal block, nominal current: 8 A, rated voltage (III/2): 250 V, nominal cross section: 1.5 mm², number of potentials: 23, number of rows: 1, number of positions per row: 23, product range: PTSA 1,5, pitch: 3.5 mm, connection method: Push-in spring connection, mounting: Wave soldering, conductor/PCB connection direction: 45 °, color: green, Pin layout: Linear pinning, Solder pin [P]: 3.5 mm, number of solder pins per potential: 1, type of packaging: packed in cardboard. Soldering legs in front area, one-rowed

Your advantages

- Time saving push-in connection, tools not required
- Defined contact force ensures that contact remains stable over the long term
- Angled connection enables multi-row arrangement on the PCB

Commercial data

Item number	1985179
Packing unit	40 pc
Minimum order quantity	40 pc
Note	Made to order (non-returnable)
Sales key	AA12
Product key	AALBDA
Catalog page	Page 305 (CC-2005)
GTIN	4017918922252
Weight per piece (including packing)	10.134 g
Weight per piece (excluding packing)	9.211 g
Customs tariff number	85369010
Country of origin	DE

PTSA 1,5/23-3,5-F - PCB terminal block



1985179

<https://www.phoenixcontact.com/us/products/1985179>

Technical data

Product properties

Product type	Printed circuit board terminal
Product family	PTSA 1,5
Product line	COMBICON Terminals S
Type	PC termination block
Number of positions	23
Pitch	3.5 mm
Number of connections	23
Number of rows	1
Number of potentials	23
Pin layout	Linear pinning
Solder pins per potential	1

Electrical properties

Nominal current I_N	8 A
Nominal voltage U_N	250 V
Degree of pollution	3
Rated voltage (III/3)	200 V
Rated surge voltage (III/3)	2.5 kV
Rated voltage (III/2)	250 V
Rated surge voltage (III/2)	2.5 kV
Rated voltage (II/2)	400 V
Rated surge voltage (II/2)	2.5 kV

Connection data

Connection technology

Type	PC termination block
Nominal cross section	1.5 mm ²

Conductor connection

Connection method	Push-in spring connection
Conductor cross section rigid	0.2 mm ² ... 1.5 mm ²
Conductor cross section flexible	0.2 mm ² ... 1.5 mm ²
Conductor cross section AWG	24 ... 16
Conductor cross section flexible, with ferrule without plastic sleeve	0.25 mm ² ... 1 mm ²
Conductor cross section, flexible, with ferrule, with plastic sleeve	0.25 mm ² ... 0.5 mm ²
Stripping length	9 mm

Mounting

Mounting type	Wave soldering
Pin layout	Linear pinning

PTSA 1,5/23-3,5-F - PCB terminal block

1985179

<https://www.phoenixcontact.com/us/products/1985179>

Material specifications

Material data - contact

Note	WEEE/RoHS-compliant, free of whiskers according to IEC 60068-2-82/JEDEC JESD 201
Contact material	Cu alloy
Surface characteristics	hot-dip tin-plated
Metal surface terminal point (top layer)	Tin (4 - 8 µm Sn)
Metal surface soldering area (top layer)	Tin (4 - 8 µm Sn)

Material data - housing

Color (Housing)	green (6021)
Insulating material	PA
Insulating material group	I
CTI according to IEC 60112	600
Flammability rating according to UL 94	V0
Glow wire flammability index GWFI according to EN 60695-2-12	850
Glow wire ignition temperature GWIT according to EN 60695-2-13	775
Temperature for the ball pressure test according to EN 60695-10-2	125 °C

Material data – actuating element

Color (Actuating element)	green (6021)
---------------------------	--------------

Dimensions

Dimensional drawing	
Pitch	3.5 mm
Width [w]	82 mm
Height [h]	16.7 mm
Length [l]	12 mm
Installed height	13.1 mm
Solder pin length [P]	3.5 mm
Pin dimensions	0.4 x 0.75 mm

PCB design

Pin spacing	3.5 mm
Hole diameter	1 mm

Mechanical tests

Test for conductor damage and slackening

PTSA 1,5/23-3,5-F - PCB terminal block



1985179

<https://www.phoenixcontact.com/us/products/1985179>

Specification	IEC 60999-1:1999-11
Result	Test passed

Pull-out test

Specification	IEC 60999-1:1999-11
Conductor cross section/conductor type/tractive force setpoint/actual value	0.2 mm ² / solid / > 10 N
	0.2 mm ² / flexible / > 10 N
	1.5 mm ² / solid / > 40 N
	1.5 mm ² / flexible / > 40 N

Electrical tests

Temperature-rise test

Specification	IEC 60947-7-4:2013-08
Requirement temperature-rise test	The sum of ambient temperature and temperature rise of the PCB terminal block shall not exceed the upper limiting temperature.

Short-time withstand current

Specification	IEC 60947-7-4:2013-08
---------------	-----------------------

Insulation resistance

Specification	IEC 60512-3-1:2002-02
Insulation resistance, neighboring positions	> 5 MΩ

Air clearances and creepage distances |

Specification	IEC 60947-1:2007-06 + A1:2010-12 + A2:2014-09
Insulating material group	I
Comparative tracking index (IEC 60112)	CTI 600
Rated insulation voltage (III/3)	200 V
Rated surge voltage (III/3)	2.5 kV
minimum clearance value - non-homogenous field (III/3)	1.5 mm
minimum creepage distance (III/3)	2.5 mm
Note on connection cross section	With connected conductor 1.5 mm ² (solid).
Rated insulation voltage (III/2)	250 V
Rated surge voltage (III/2)	2.5 kV
minimum clearance value - non-homogenous field (III/2)	1.5 mm
minimum creepage distance (III/2)	1.5 mm
Rated insulation voltage (II/2)	400 V
Rated surge voltage (II/2)	2.5 kV
minimum clearance value - non-homogenous field (II/2)	1.5 mm
minimum creepage distance (II/2)	2 mm

Environmental and real-life conditions

Vibration test

Specification	IEC 60068-2-6:2007-12
Frequency	10 - 150 - 10 Hz

PTSA 1,5/23-3,5-F - PCB terminal block



1985179

<https://www.phoenixcontact.com/us/products/1985179>

Sweep speed	1 octave/min
Amplitude	0.35 mm (10 Hz ... 60.1 Hz)
Acceleration	5g (60.1 Hz ... 150 Hz)
Test duration per axis	2.5 h

Glow-wire test

Specification	IEC 60695-2-10:2000-10
Temperature	850 °C
Time of exposure	5 s

Aging

Specification	IEC 60947-7-4:2013-08
---------------	-----------------------

Ambient conditions

Ambient temperature (operation)	-40 °C ... 100 °C (Depending on the current carrying capacity/derating curve)
Ambient temperature (storage/transport)	-40 °C ... 70 °C
Relative humidity (storage/transport)	30 % ... 70 %
Ambient temperature (assembly)	-5 °C ... 85 °C

Packaging specifications

Type of packaging	packed in cardboard
-------------------	---------------------

Drawings

Diagram

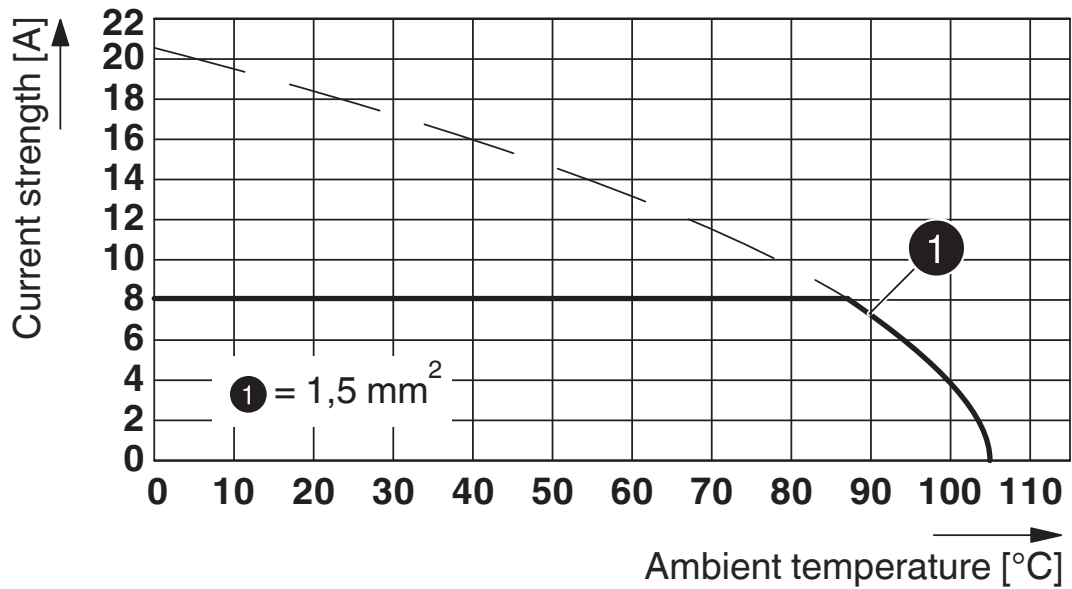

Type: PTSA 1,5/...-3,5-F

Drilling plan/solder pad geometry

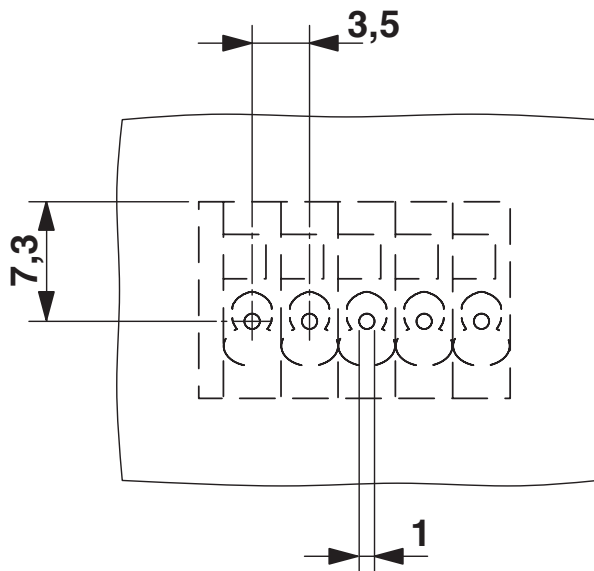

The figure shows the drilling diagram of the 5-position product version

PTSA 1,5/23-3,5-F - PCB terminal block



1985179

<https://www.phoenixcontact.com/us/products/1985179>

Dimensional drawing

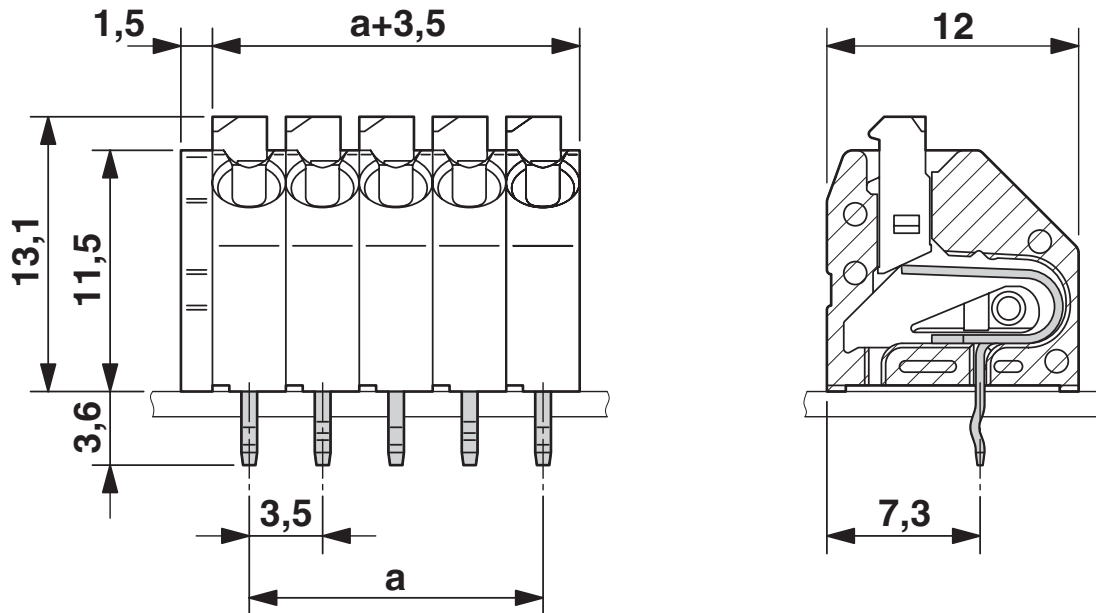

The figure shows the dimensional drawing of the 5-position product version

PTSA 1,5/23-3,5-F - PCB terminal block





1985179

<https://www.phoenixcontact.com/us/products/1985179>

Approvals

To download certificates, visit the product detail page: <https://www.phoenixcontact.com/us/products/1985179>

 cULus Recognized Approval ID: E60425-20030527				
	Nominal voltage U_N	Nominal current I_N	Cross section AWG	Cross section mm^2
Use group B	300 V	5 A	24 - 16	-
Use group D	300 V	5 A	24 - 16	-

 VDE Gutachten mit Fertigungsüberwachung Approval ID: 40018594				
	Nominal voltage U_N	Nominal current I_N	Cross section AWG	Cross section mm^2
	130 V	2 A	-	0.5 - 0.75

 VDE Zeichengenehmigung Approval ID: 40057505				
	Nominal voltage U_N	Nominal current I_N	Cross section AWG	Cross section mm^2
	250 V	8 A	-	0.2 - 1.5

PTSA 1,5/23-3,5-F - PCB terminal block



1985179

<https://www.phoenixcontact.com/us/products/1985179>

Classifications

ECLASS

ECLASS-11.0	27460101
ECLASS-12.0	27460101
ECLASS-13.0	27460101

ETIM

ETIM 9.0	EC002643
----------	----------

UNSPSC

UNSPSC 21.0	39121400
-------------	----------

PTSA 1,5/23-3,5-F - PCB terminal block



1985179

<https://www.phoenixcontact.com/us/products/1985179>

Environmental product compliance

EU RoHS

Fulfills EU RoHS substance requirements	Yes, No exemptions
---	--------------------

China RoHS

Environment friendly use period (EFUP)	EFUP-E
	No hazardous substances above the limits

EU REACH SVHC

REACH candidate substance (CAS No.)	No substance above 0.1 wt%
-------------------------------------	----------------------------

PTSA 1,5/23-3,5-F - PCB terminal block



1985179

<https://www.phoenixcontact.com/us/products/1985179>

Accessories

SZS 0,4X2,5 VDE - Screwdriver

1205037

<https://www.phoenixcontact.com/us/products/1205037>



Screwdriver, slot-headed, VDE insulated, size: 0.4 x 2.5 x 80 mm, 2-component grip, with non-slip grip

CRIMPFOX 6 - Crimping pliers

1212034

<https://www.phoenixcontact.com/us/products/1212034>



Crimping pliers, for ferrules without insulating collar according to DIN 46228 Part 1 and ferrules with insulating collar according to DIN 46228 Part 4, 0.25 mm² ... 6.0 mm², lateral entry, trapezoidal crimp

Phoenix Contact 2024 © - all rights reserved

<https://www.phoenixcontact.com>

Phoenix Contact USA

586 Fulling Mill Road

Middletown, PA 17057, United States

(+717) 944-1300

info@phoenixcon.com