



**Contactor, 55kW/400V, DC operated**

**Part no.**

**DILM115(RDC24)**

**Article no.**

**239555**



## Delivery programme

Product range			Contactors
Application			Contactors for Motors
Subrange			Contactors up to 170 A, 3 pole
Connection technique			Screw terminals
Pole			3 pole
Rated operational current			
AC-3			
380 V 400 V	$I_e$	A	115
AC-1			
Conventional free air thermal current, 3 pole, 50 - 60 Hz			
Open			
at 60 °C	$I_{th} = I_e$	A	130
Max. rating for three-phase motors, 50 - 60 Hz			
AC-3			
220 V 230 V	P	kW	37
380 V 400 V	P	kW	55
660 V 690 V	P	kW	90
AC-4			
220 V 230 V	P	kW	17
380 V 400 V	P	kW	28
660 V 690 V	P	kW	43
Contact sequence			
<b>Instructions</b>			Contacts to EN 50012. integrated suppressor circuit in actuating electronics
Can be combined with auxiliary contact			DILM150-XHI(V).. DILM1000-XHI(V)..
Voltage AC/DC			DC operation

## Approbationen

Product Standards  
UL File No.  
UL CCN  
CSA File No.  
CSA Class No.  
NA Certification  
Specially designed for NA

IEC/EN 60947-4-1; UL 508; CSA-C22.2 No. 14-05; CE marking  
E29096  
NLDX  
012528  
2411-03, 3211-04  
UL Listed, CSA certified  
No

## General

Standards			IEC/EN 60947, VDE 0660, UL, CSA
Lifespan, mechanical			
AC operated	Operations	$\times 10^6$	10
DC operated	Operations	$\times 10^6$	10
Operating frequency, mechanical			
AC operated	Operations/h		3600
DC operated	Operations/h		3600
Climatic proofing			Damp heat, constant to IEC 60068-2-78 Damp heat, cyclic to IEC 60068-2-30

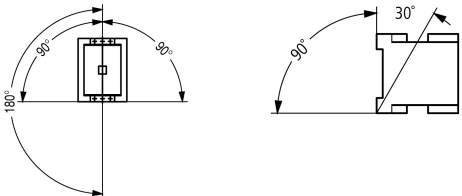
Ambient temperature		°C	
Open		°C	- 25 - 60
Enclosed		°C	- 25 - 40
Storage		°C	- 40 - 80
Mounting position, AC- and DC operated			
Mechanical shock resistance (IEC/EN 60068-2-27)			
Half-sinusoidal shock, 10 ms			
Main contacts			
N/O contact		g	10
Auxiliary contacts			
N/O contact		g	7
N/C contact		g	5
Mechanical shock resistance (IEC/EN 60068-2-27) when tabletop-mounted			
Half-sinusoidal shock, 10 ms			
Main contacts			
N/O contact		g	10
Auxiliary contacts			
N/O contact		g	7
N/C contact		g	5
Protection type			IP00
Protection against direct contact when actuated from front (EN 90274)			Finger- and back-of-hand proof
Weight			
AC operated		kg	2
DC operated		kg	2.1
Terminal capacity main cable			
Flexible with ferrule		mm <sup>2</sup>	1 x (10 - 95) 2 x (10 - 70)
Stranded		mm <sup>2</sup>	1 x (16 - 95) 2 x (16 - 70)
Solid or stranded		AWG	8...3/0
Flat conductor	Number of segments x width x thickness	mm	2 x (6 x 16 x 0.8)
Main cable connection screw/bolt			M10
Tightening torque		Nm	14
Terminal capacity control circuit cables			
Solid		mm <sup>2</sup>	1 x (0.75 - 4) 2 x (0.75 - 4)
Flexible with ferrule		mm <sup>2</sup>	1 x (0.75 - 2.5) 2 x (0.75 - 2.5)
Solid or stranded		AWG	18 - 14
Control circuit cable connection screw/bolt			M3.5
Tightening torque		Nm	1.2
Tool			
Main cable			
Hexagon socket-head spanner	SW	mm	5
Control circuit cables			
Pozidriv screwdriver		Size	2
Standard screwdriver		mm	0.8 x 5.5 1 x 6
Terminal capacity control circuit cables			
Solid		mm <sup>2</sup>	1 x (0.75 - 2.5) 2 x (0.75 - 2.5)
Flexible		mm <sup>2</sup>	1 x (0.75 - 2.5)

			2 x (0.75 - 2.5)
Flexible with ferrule		mm <sup>2</sup>	1 x (0.75 - 1.5) 2 x (0.75 - 1.5)
Solid or stranded		AWG	18 - 14
Tool			
Stripping length		mm	10
Screwdriver blade width		mm	3.5

### Main conducting paths

Rated impulse withstand voltage	$U_{imp}$	V AC	8000
Overvoltage category/pollution degree			III/3
Rated insulation voltage	$U_i$	V AC	690
Rated operational voltage	$U_e$	V AC	690
Safe isolation to VDE 0106 Part 101 and Part 101/A1			
between coil and contacts		V AC	690
between the contacts		V AC	690
Making capacity (p.f. to IEC/EN 60947)			
	Up to 690 V	A	1610
Breaking capacity			
220/230 V		A	1150
380/400 V		A	1150
500 V		A	1150
660/690 V		A	1100
Short-circuit rating			
Short-circuit protection maximum fuse			
Type "2" coordination			
400 V	gG/gL 500 V	A	250
690 V	gG/gL 690 V	A	250
Type "1" coordination			
400 V	gG/gL 500 V	A	250
690 V	gG/gL 690 V	A	250

### AC

AC-1 duty			
Conventional free air thermal current, 3 pole, 50 - 60 Hz			
Open			
at 40 °C	$I_{th} = I_e$	A	160
at 50 °C	$I_{th} = I_e$	A	142
at 55 °C	$I_{th} = I_e$	A	135
at 60 °C	$I_{th} = I_e$	A	130
enclosed	$I_{th}$	A	115
Conventional free air thermal current, 1 pole			
open	$I_{th}$	A	325
enclosed	$I_{th}$	A	285
AC-3 duty			
Rated operational current AC-3 open, 50 - 60 Hz, 3 pole	$I_e$		
220/230 V	$I_e$	A	115
240 V	$I_e$	A	115
380/400 V	$I_e$	A	115
415 V	$I_e$	A	115
440V	$I_e$	A	115
500 V	$I_e$	A	115
660/690 V	$I_e$	A	93
Motor rating	P	kWh	
220/230 V	P	kW	37
240V	P	kW	40
380/400 V	P	kW	55

415 V	P	kW	70
440 V	P	kW	75
500 V	P	kW	85
660/690 V	P	kW	90
AC-4 duty			
Rated operational current AC-4 open, 50 - 60 Hz, 3 pole			
220/230 V	$I_e$	A	55
240 V	$I_e$	A	55
380/400 V	$I_e$	A	55
415 V	$I_e$	A	55
440 V	$I_e$	A	55
500 V	$I_e$	A	55
660/690 V	$I_e$	A	45
Motor rating			
220/230 V	P	kWh	
240 V	P	kW	17
380/400 V	P	kW	19
415 V	P	kW	28
440 V	P	kW	33
500 V	P	kW	35
660/690 V	P	kW	40
660/690 V	P	kW	43

## DC

Rated operational current, open			
DC-1 operation			
60 V	$I_e$	A	160
110 V	$I_e$	A	160
220 V	$I_e$	A	90
440 V	$I_e$	A	4.5
DC-3 operation			
60 V	$I_e$	A	160
110 V	$I_e$	A	160
220 V	$I_e$	A	40
440 V	$I_e$	A	1
DC-5 operation			
60 V	$I_e$	A	160
110 V	$I_e$	A	160
220 V	$I_e$	A	40
440 V	$I_e$	A	1

## Current heat loss (3 pole)

Current heat loss at $I_{th}$		W	20.3
Current heat loss at $I_e$ to AC-3/400 V		W	15.9
Impedance per pole		m $\Omega$	0.4

## Magnet systems

Voltage tolerance			
AC operated	Pick-up	$x U_c$	0.8 - 1.15
Drop-out voltage AC operated	Drop-out	$x U_c$	0.25 - 0.6
Notes			RDC 24 ( $U_{min}$ 24 V DC/ $U_{max}$ 27 V DC) Example: $U_c = 0.7 \times U_{min} - 1.2 \times U_{max} / U_c = 0.7 \times 24 \text{ V} - 1.2 \times 27 \text{ V DC}$
DC operated	Pick-up	$x U_c$	0.7 - 1.2
Notes			at least smoothed two-phase bridge rectifier or three-phase rectifier
DC operated	Drop-out	$x U_c$	0.15 - 0.6
Power consumption of the coil in a cold state and $1.0 \times U_c$			
50 Hz	Pick-up	VA	180
50 Hz	Sealing	VA	3.1

50 Hz	Sealing	W	2.1
60 Hz	Pick-up	VA	170
60 Hz	Sealing	VA	3.1
60 Hz	Sealing	W	2.1
50/60 Hz	Pick-up	VA	170 170
50/60 Hz	Sealing	VA	3.1 3.1
50/60 Hz	Sealing	W	2.1 2.1
DC operated	Pick-up	W	149
DC operated	Sealing	W	2.1
Duty factor		% DF	100
Switching times at 100 % U <sub>c</sub> (approximate values)			
Main contacts			
AC operated			
Closing delay		ms	28 - 33
Opening delay		ms	35 - 41
DC operated			
Closing delay		ms	35
Opening delay		ms	30
Arcing time		ms	15
Permissible residual current with actuation of A1 - A2 by the electronics (with 0 signal).		mA	 1
Lifespan, mechanical; Coil 50/60 Hz	at 50 Hz		Mechanical lifespan at 50 Hz approx. 30% lower than under "Technical data, general"

### Electromagnetic compatibility (EMC)

Emitted interference			to EN 60947-1
Interference immunity			to EN 60947-1

### Technische Daten nach ETIM 4.0

Number of main contacts as N/Os			3
Rated operation current I <sub>e</sub> at AC-1, 400 V			160
Connection type main circuit			Screw connection
Rated control voltage U <sub>s</sub> at AC 60HZ		V	0
Number of auxiliary contacts as N/Os			0
Rated control voltage U <sub>s</sub> at AC 50HZ		V	0
Number of auxiliary contacts as N/Cs			0
Suitable for rail-mounting			No
Rated control voltage U <sub>s</sub> at DC		V	27
Voltage type for actuation			DC
Rated operation current I <sub>e</sub> at AC-3, 400 V		A	115
Number of N/Cs as main contact			0
Motor rating at AC-3, 400 V		kWh	55

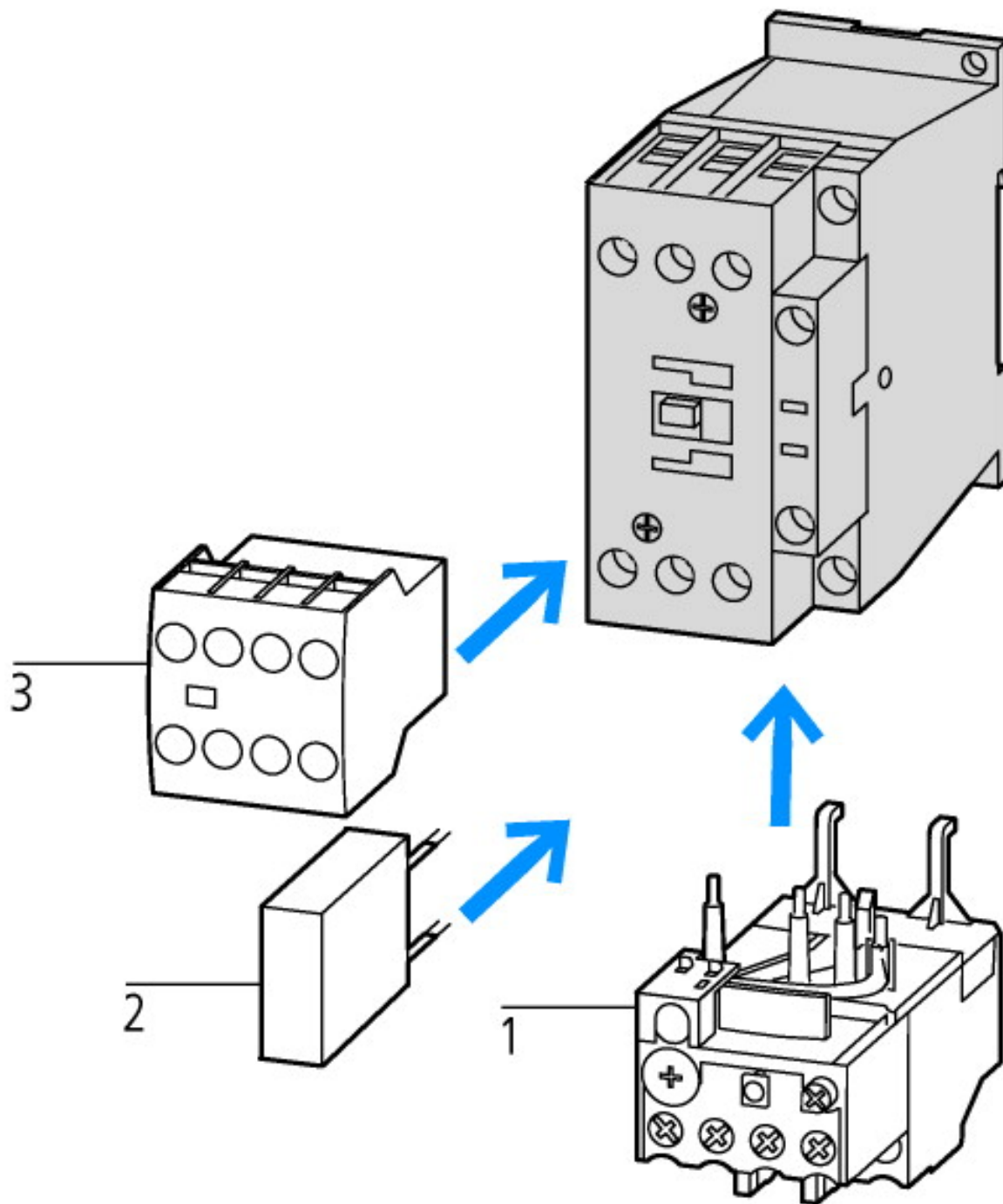

- 1: Overload relay
- 2: Suppressor
- 3: Auxiliary contact modules

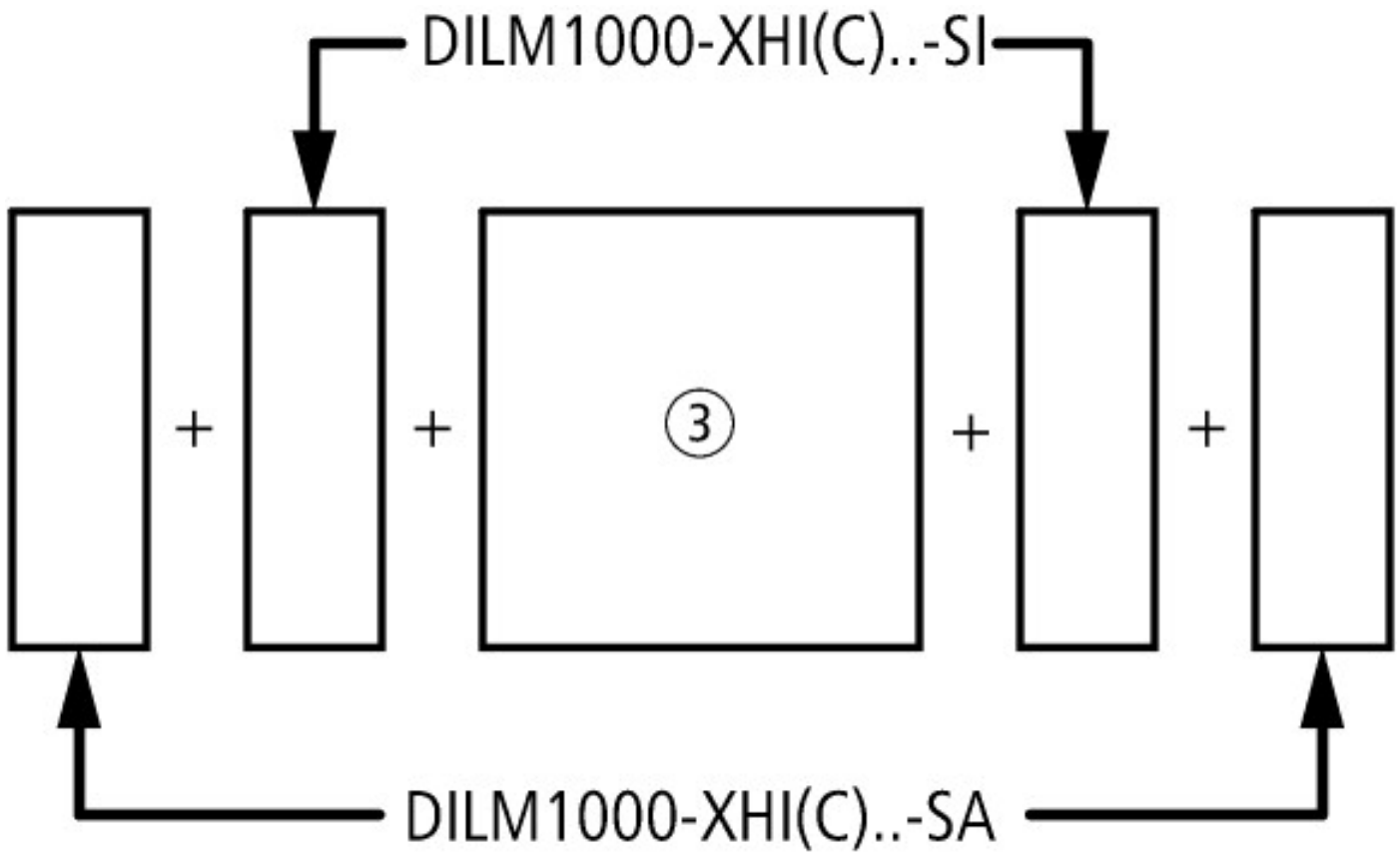

on the side: 2 x DILM820-XHI(V)11-SI; 2 x DILM820-XHI(V)11-SA  
 on the side: 2 x DILM1000-XHI(V)11-SI; surface mounting: 1 x DILM150-XHIA22  
 on the side: 2 x DILM1000-XHI(V)11-SI; surface mounting: 1 x DILM150-XHIA11  
 on the side: 2 x DILM1000-XHI(V)11-SA; surface mounting: 1 x DILM150-XHI (4 pole)  
 on the side: 2 x DILM1000-XHI(V)11-SA; surface mounting: 1 x DILM150-XHI (2 pole)

Projektieren

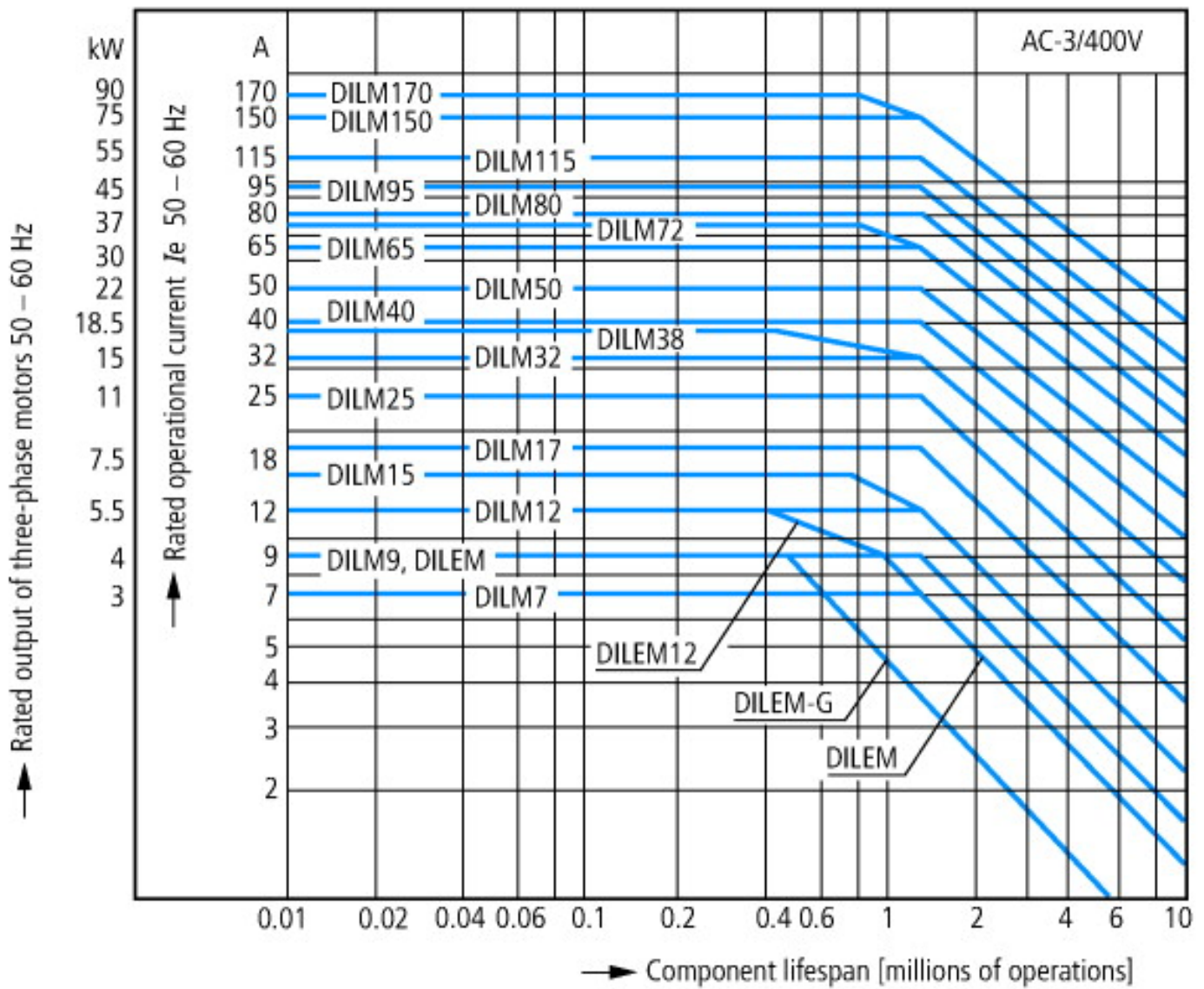

- Squirrel-cage motor
- Operating characteristics
- Starting: from rest
- Stopping: after attaining full running speed
- Electrical characteristics
- Make: up to 6 x rated motor current
- Break: up to 1 x rated motor current
- Utilization category
- 100 % AC-3
- Typical applications
- Compressors
- Lifts
- Mixers
- Pumps
- Escalators
- Agitators
- Fans
- Conveyor belts
- Centrifuges
- Hinged flaps
- Bucket-elevators
- Air conditioning system
- General drives in manufacturing and processing machines



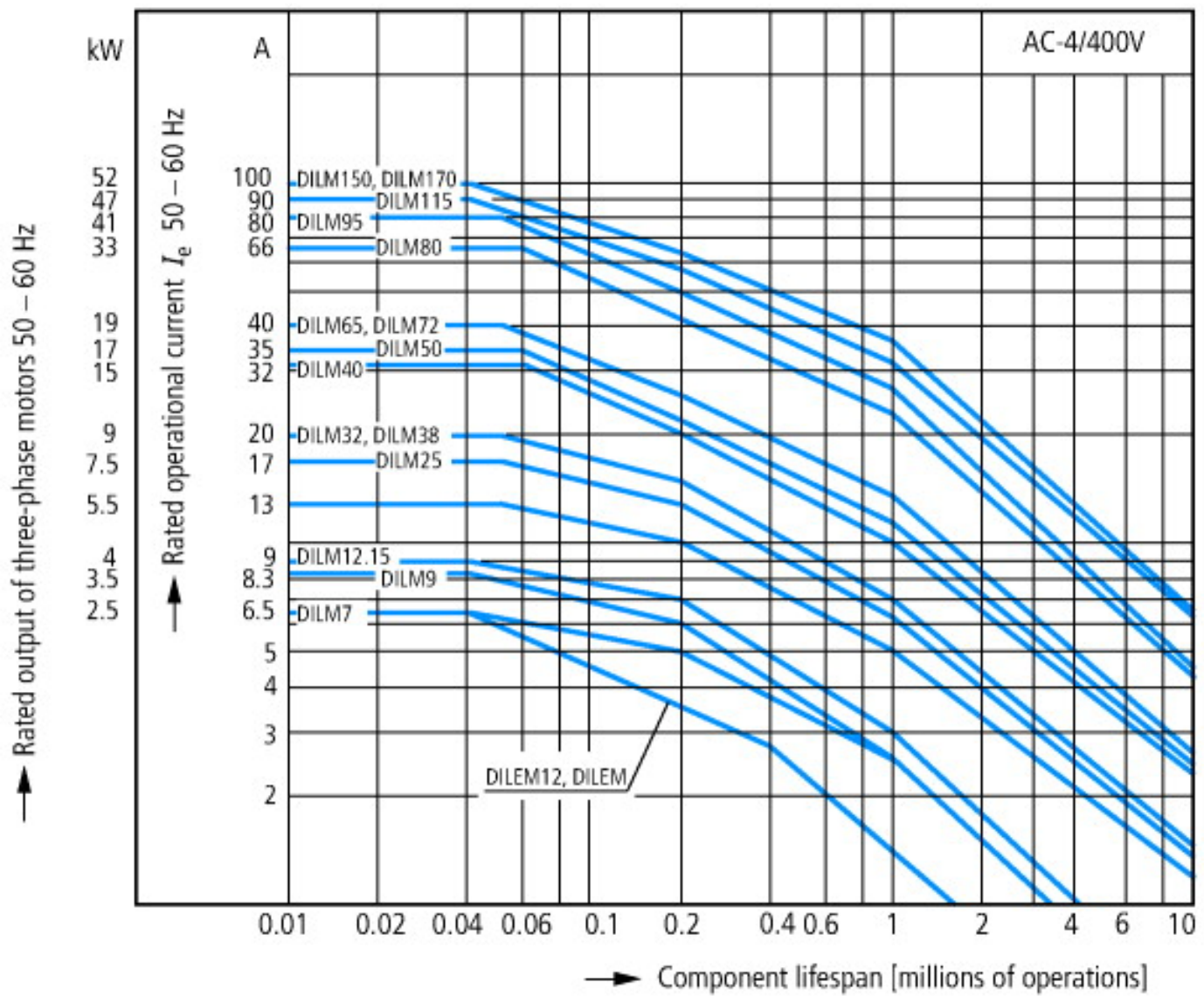

- Extreme switching duty
- Squirrel-cage motor
- Operating characteristics
- Inching, plugging, reversing
- Electrical characteristics
- Make: up to 6 x rated motor current
- Break: up to 6 x rated motor current
- Utilization category
- 100 % AC-4
- Typical applications
- Printing presses
- Wire-drawing machines
- Centrifuges
- Special drives for manufacturing and processing machines

#### CAD-Daten

Product standards CAD data:

<http://eaton-moeller.partcommunity.com>

#### Dimensions

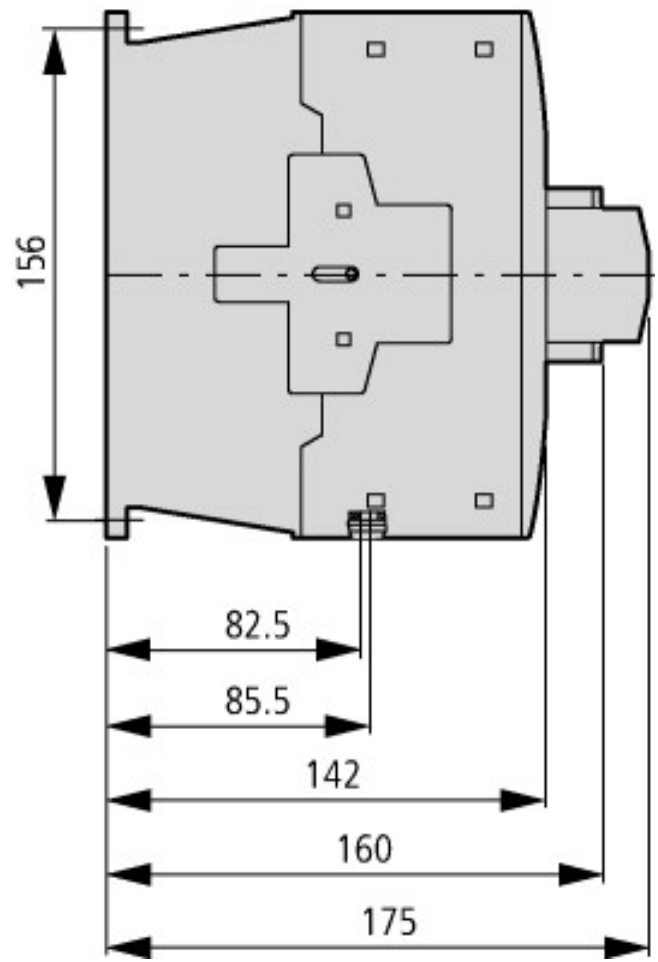
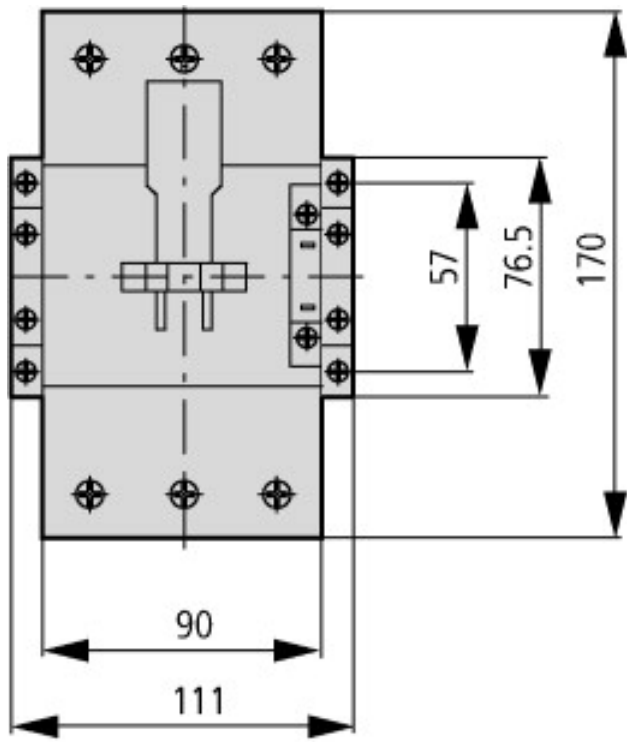

Contacteur with auxiliary contact module

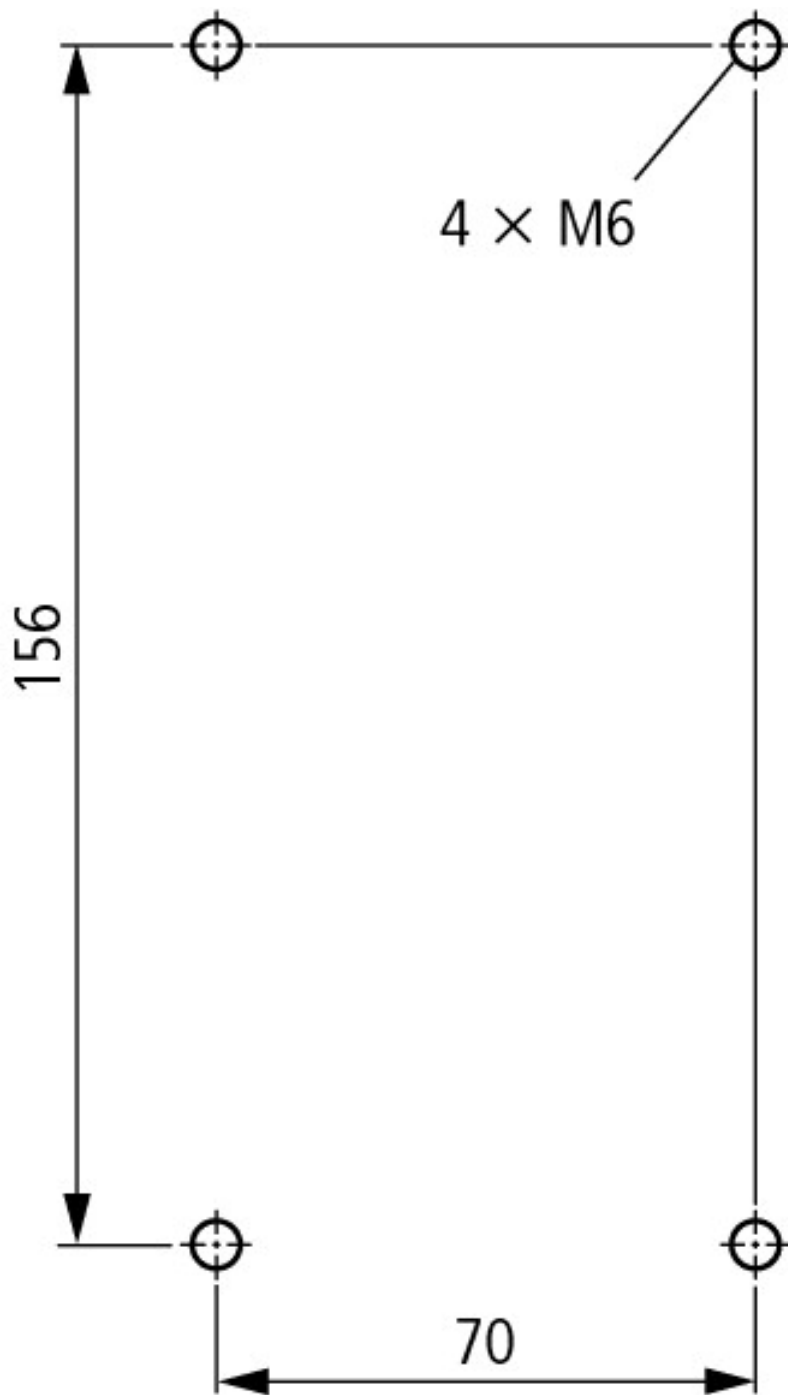

distance at side to earthed parts: 10 mm

DILM80...DILM170  
DILMC80...DILMC150  
DILMF80...DILMF150

#### Additional product information (links)

AWA2100-2286 (IL03407039Z) contactor DILM

[ftp://ftp.moeller.net/DOCUMENTATION/AWA\\_INSTRUCTIONS/22860209.pdf](ftp://ftp.moeller.net/DOCUMENTATION/AWA_INSTRUCTIONS/22860209.pdf)