

# FL MC EF WDM-SET SC - FO converters



2902660

<https://www.phoenixcontact.com/us/products/2902660>

Please be informed that the data shown in this PDF document is generated from our online catalog. Please find the complete data in the user documentation. Our general terms of use for downloads are valid.



FO converter set, consisting of type A devices and type B devices, for full duplex transmission from 10/100Base-T(X) to individual simplex fiberglass with WDM (wavelength division multiplex) technology. SC simplex fiber optic connection (1550/1310 nm).

## Product description

Optical transmission with FO technology provides superior immunity to interference at maximum transmission ranges without restricting the transmission bandwidth.

## Your advantages

- Device set for operation on one fiber
- Full duplex communication with only one fiber
- Transmission ranges up to 38 km
- Auto negotiation
- Auto MDI/MDI-X switch-over
- Link fault pass through (LFPT) and far end fault (FEF) functions for easy connection monitoring
- 10/100 Mbps
- Shipbuilding approval in accordance with DNV GL

## Commercial data

Item number	2902660
Packing unit	1 pc
Minimum order quantity	1 pc
Sales key	DN06
Product key	DNC311
Catalog page	Page 350 (C-6-2019)
GTIN	4046356670616
Weight per piece (including packing)	434.6 g
Weight per piece (excluding packing)	434 g
Customs tariff number	85176200
Country of origin	DE

# FL MC EF WDM-SET SC - FO converters

2902660

<https://www.phoenixcontact.com/us/products/2902660>

## Set consists of

### FL MC EF WDM-A SC - FO converters

2902658

<https://www.phoenixcontact.com/us/products/2902658>



FO converter (replacement device A), for full duplex transmission from 10/100Base-T(X) to individual simplex fiberglass with WDM (wavelength division multiplex) technology, SC simplex fiber optic connection (1310/1550 nm). Device set (type A and type B) required for operation.

---

### FL MC EF WDM-B SC - FO converters

2902659

<https://www.phoenixcontact.com/us/products/2902659>



FO converter (replacement device B), for full duplex transmission from 10/100Base-T(X) to individual simplex fiberglass with WDM (wavelength division multiplex) technology, SC simplex fiber optic connection (1550/1310 nm). Device set (type A and type B) required for operation.

2902660

<https://www.phoenixcontact.com/us/products/2902660>

## Technical data

### Notes

#### Utilization restriction

CCCex note	Use in potentially explosive areas is not permitted in China.
------------	---

### Product properties

Product type	Media converter
--------------	-----------------

### Interfaces

Signal	Ethernet
--------	----------

#### Data: optical FO

Transmission length incl. 3 dB system reserve	38 km (F-E 9/125 0.36 dB/km)
	34 km (F-E 9/125 0.4 dB/km)
	28 km (F-E 9/125 0.5 dB/km)
	21 km (F-G 62.5/125 0.7 dB/km F 1000)
	5.5 km (F-G 62.5/125 2.6 dB/km F 600)
	21 km (F-G 50/125 0.7 dB/km F 1200)
	9 km (F-G 50/125 1.6 dB/km F 800)
Connection method	SC simplex
Wavelength	1550 nm
	1310 nm
Transmission medium	Multi-mode fiberglass
	Single-mode fiberglass

#### Data

Transmission medium	Copper
---------------------	--------

### Environmental and real-life conditions

#### Ambient conditions

Ambient temperature (operation)	-40 °C ... 65 °C
Altitude	≤ 5000 m (For restrictions, see the manufacturer's declaration for altitude operation)
	≤ 2000 m (in acc. with UL)

### Approvals

#### EAC

Identification	EAC
----------------	-----

#### Corrosive gas test

Identification	ISA-S71.04-1985 G3 Harsh Group A
----------------	----------------------------------

#### Shipbuilding

# FL MC EF WDM-SET SC - FO converters



2902660

<https://www.phoenixcontact.com/us/products/2902660>

Identification	DNV GL
----------------	--------

## DNV GL data

Temperature	B
Humidity	A
Vibration	A
EMC	B
Enclosure	Required protection according to the Rules shall be provided upon installation on board

## Mounting

Mounting type	DIN rail mounting
---------------	-------------------

2902660

<https://www.phoenixcontact.com/us/products/2902660>

## Drawings

Schematic diagram

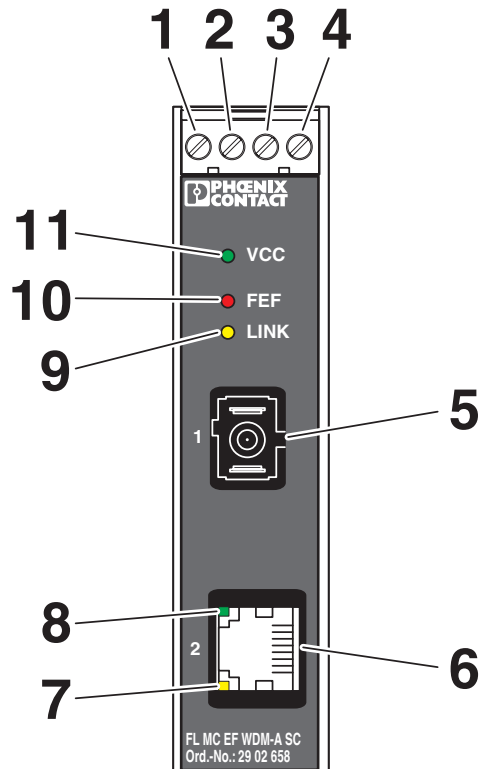

Front view

Application drawing

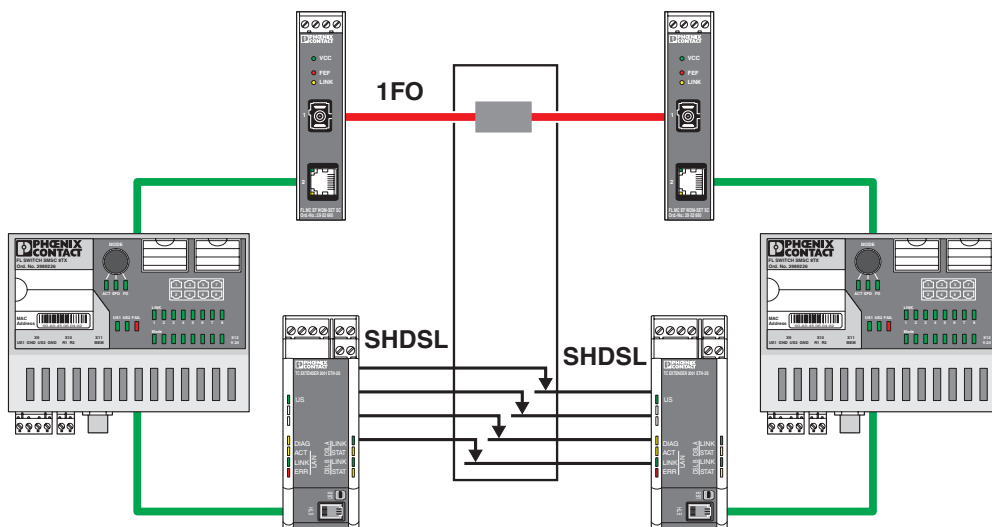

Redundant slip ring communication

# FL MC EF WDM-SET SC - FO converters



2902660

<https://www.phoenixcontact.com/us/products/2902660>

Schematic diagram

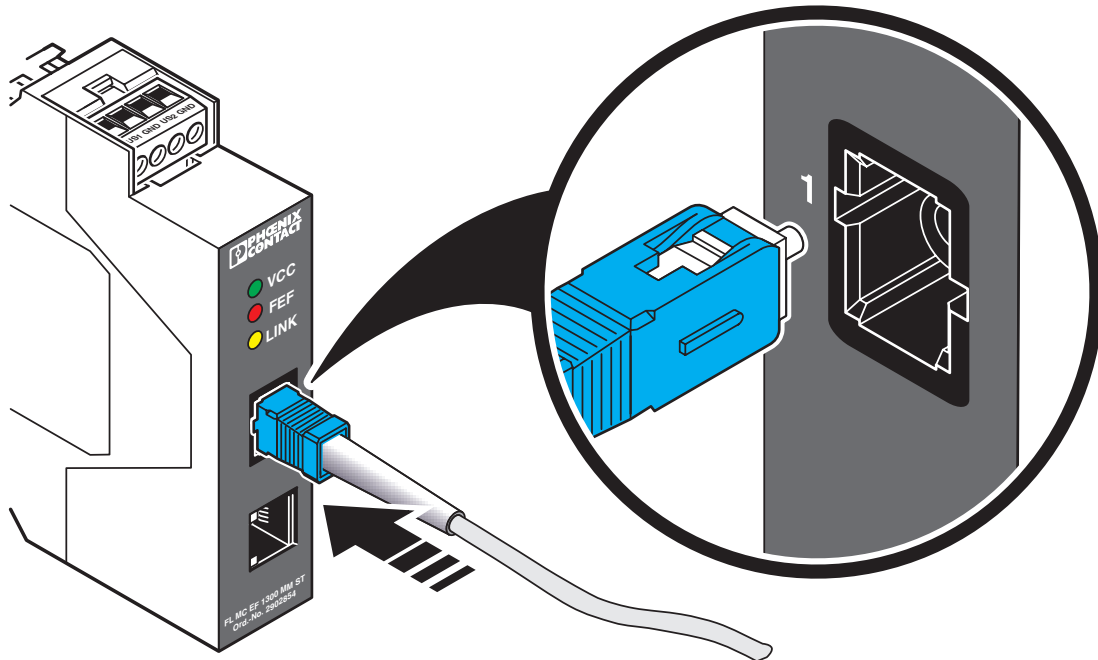

Connect SC simplex plug

Dimensional drawing

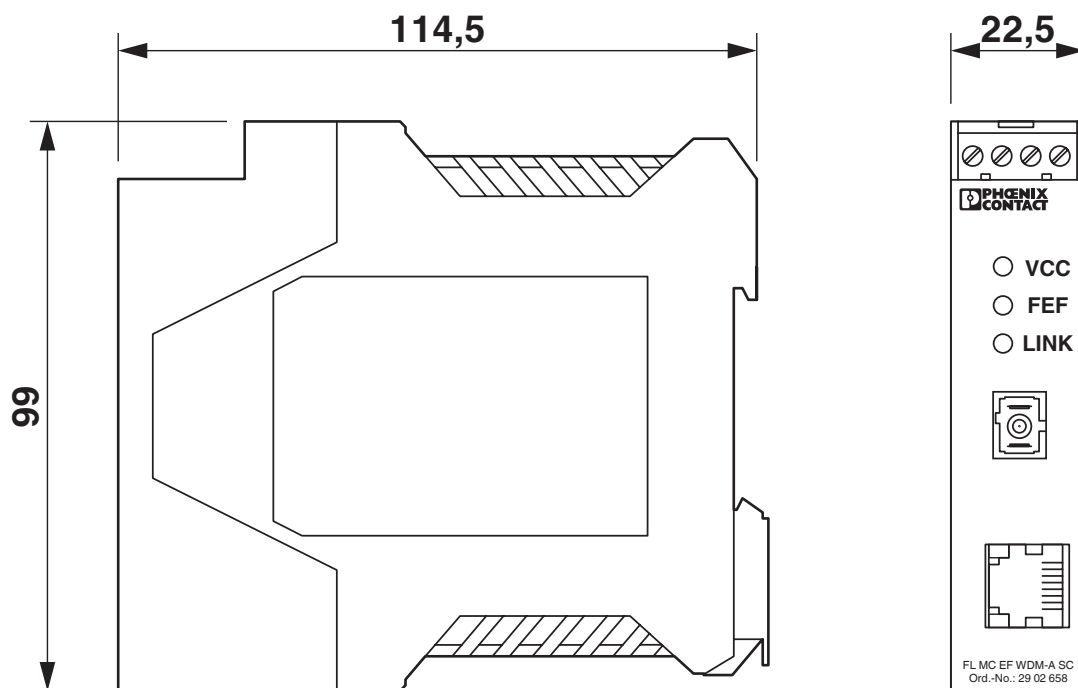

Slim design

# FL MC EF WDM-SET SC - FO converters

2902660

<https://www.phoenixcontact.com/us/products/2902660>

Application drawing

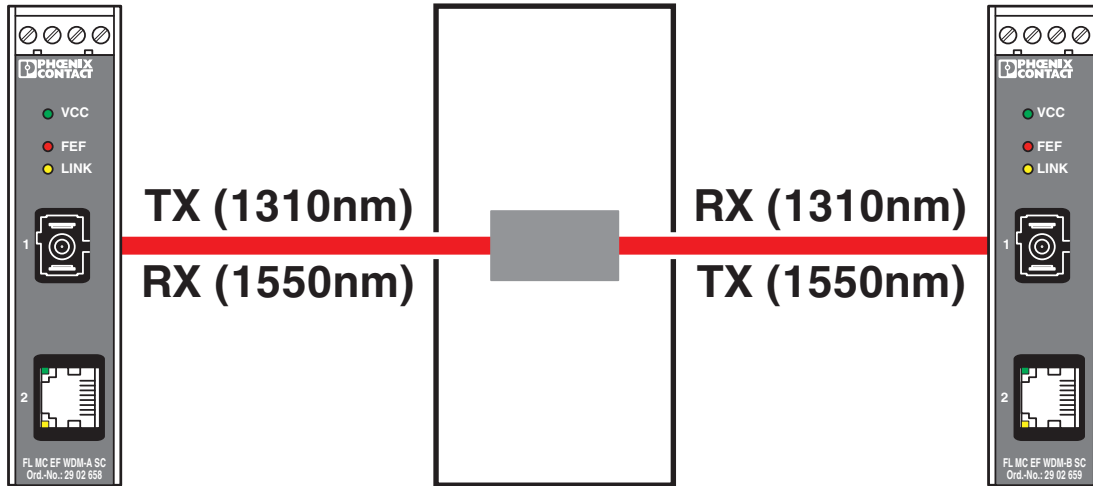

Slip ring communication

Schematic diagram

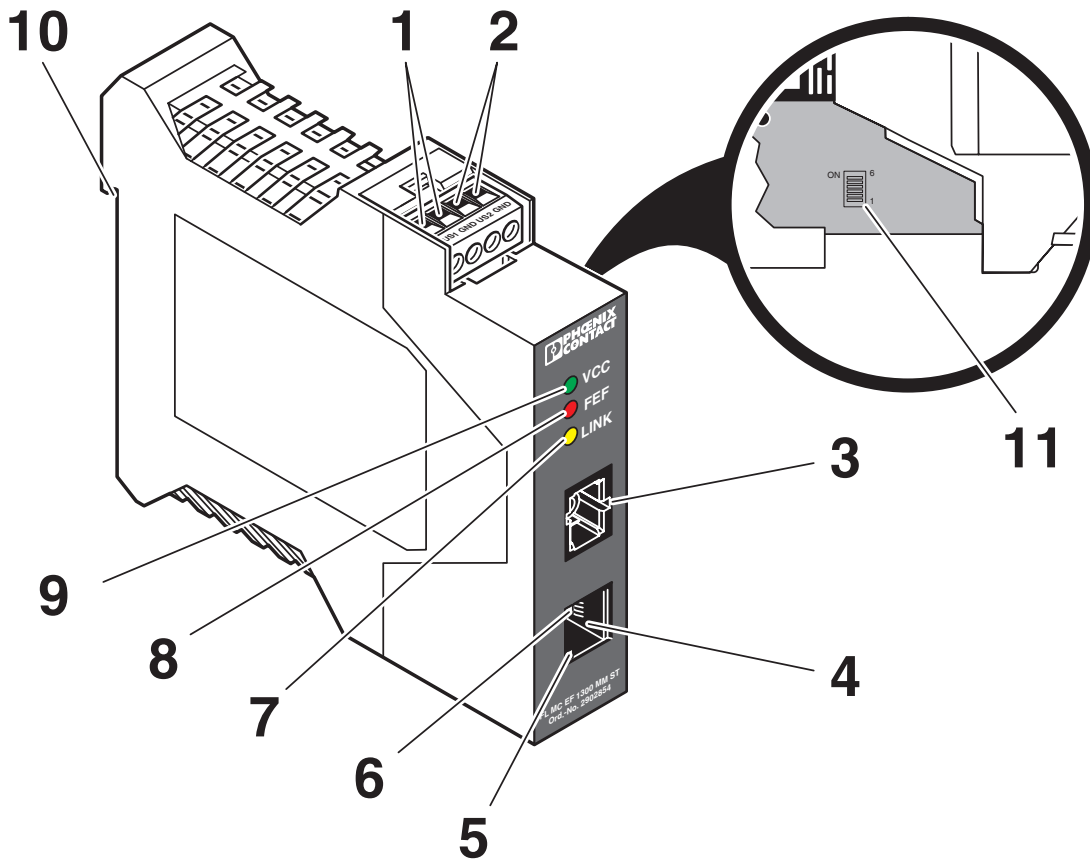

Function elements

# FL MC EF WDM-SET SC - FO converters



2902660

<https://www.phoenixcontact.com/us/products/2902660>

Schematic diagram

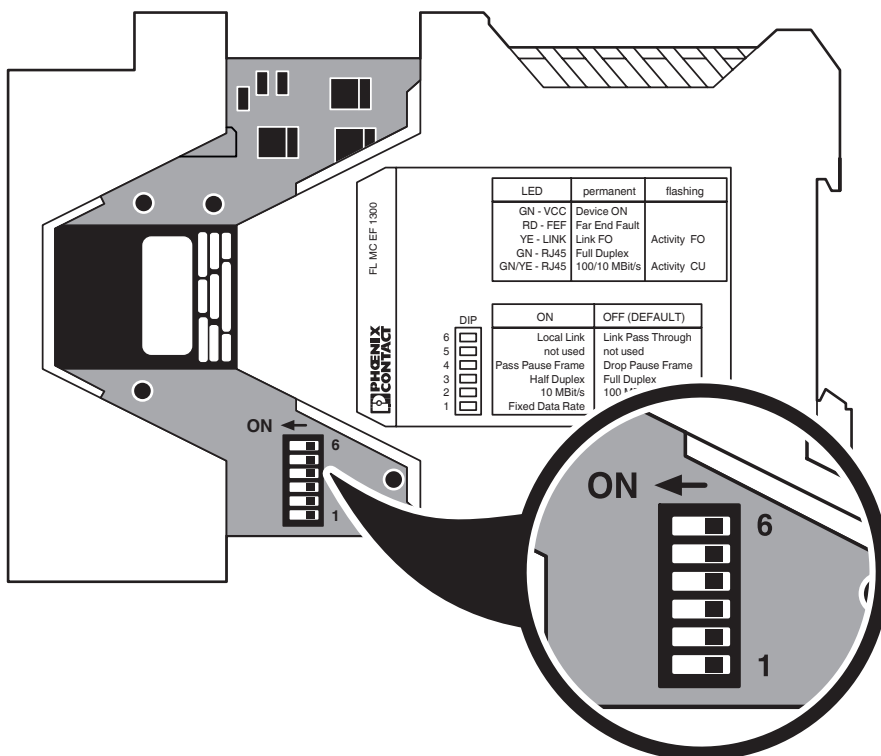

DIP switches

Block diagram

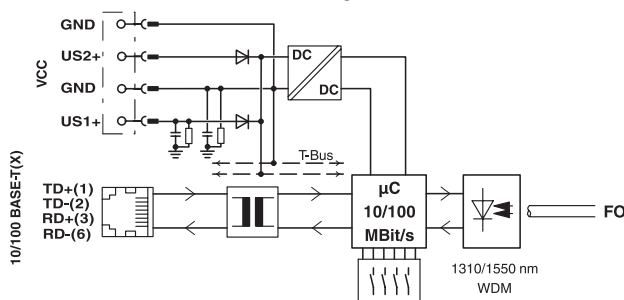

Basic circuit diagram



# FL MC EF WDM-SET SC - FO converters



2902660

<https://www.phoenixcontact.com/us/products/2902660>

## Approvals

 To download certificates, visit the product detail page: <https://www.phoenixcontact.com/us/products/2902660>



**EAC**

Approval ID: RU\*DE\*08.B.00731/19



**DNV GL**

Approval ID: TAA00001KR

# FL MC EF WDM-SET SC - FO converters



2902660

<https://www.phoenixcontact.com/us/products/2902660>

## Classifications

### ECLASS

ECLASS-11.0	19170411
ECLASS-12.0	19170411
ECLASS-13.0	19170411

### ETIM

ETIM 9.0	EC001467
----------	----------

### UNSPSC

UNSPSC 21.0	43201500
-------------	----------

# FL MC EF WDM-SET SC - FO converters



2902660

<https://www.phoenixcontact.com/us/products/2902660>

## Environmental product compliance

REACH SVHC	Lead 7439-92-1
China RoHS	Environmentally Friendly Use Period = 50 years
	For information on hazardous substances, refer to the manufacturer's declaration available under "Downloads"

# FL MC EF WDM-SET SC - FO converters



2902660

<https://www.phoenixcontact.com/us/products/2902660>

## Accessories

### FL MC EF WDM-A SC - FO converters

2902658

<https://www.phoenixcontact.com/us/products/2902658>



FO converter (replacement device A), for full duplex transmission from 10/100Base-T(X) to individual simplex fiberglass with WDM (wavelength division multiplex) technology, SC simplex fiber optic connection (1310/1550 nm). Device set (type A and type B) required for operation.

---

### FL MC EF WDM-B SC - FO converters

2902659

<https://www.phoenixcontact.com/us/products/2902659>



FO converter (replacement device B), for full duplex transmission from 10/100Base-T(X) to individual simplex fiberglass with WDM (wavelength division multiplex) technology, SC simplex fiber optic connection (1550/1310 nm). Device set (type A and type B) required for operation.

# FL MC EF WDM-SET SC - FO converters

2902660

<https://www.phoenixcontact.com/us/products/2902660>

## FL CAT5 HEAVY - Data cable

2744814

<https://www.phoenixcontact.com/us/products/2744814>



CAT5-SF/UTP cable (J-02YS(ST)C HP 2 x 2 x 24 AWG), heavy-duty installation cable, 2 x 2 x 0.22 mm<sup>2</sup>, solid conductor, shielded, outer sheath: 7.8 mm diameter, inner sheath: 5.75 mm ± 0.15 mm diameter

---

## FL CAT5 FLEX - Installation cable

2744830

<https://www.phoenixcontact.com/us/products/2744830>



By the meter, Installation cable, Ethernet CAT5 (100 Mbps), shielded, PUR halogen-free, water blue RAL 5021, 4-wire (2x2xAWG26/7, SF/UTP), color single wire: white/orange-orange, white/green-green, cable length: Free entry (1.0 ... 1000.0 m)

# FL MC EF WDM-SET SC - FO converters

2902660

<https://www.phoenixcontact.com/us/products/2902660>

## FL CRIMPTOOL - Assembly tool

2744869

<https://www.phoenixcontact.com/us/products/2744869>

Crimping pliers, for assembling the RJ45 plugs FL PLUG RJ45..., for assembly on site



---

## ME 22,5 TBUS 1,5/ 5-ST-3,81 GN - DIN rail bus connectors

2707437

<https://www.phoenixcontact.com/us/products/2707437>

DIN rail connector, color: green, nominal current: 8 A (parallel contacts), rated voltage (III/2): 125 V, number of positions: 5, pitch: 3.81 mm, mounting: DIN rail mounting, locking: without, mounting: without, type of packaging: packed in cardboard, Item with gold-plated contacts, bus connectors for connecting with electronics housings, 5 parallel contacts

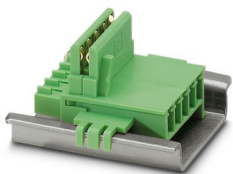

# FL MC EF WDM-SET SC - FO converters

2902660

<https://www.phoenixcontact.com/us/products/2902660>



## QUINT4-SYS-PS/1AC/24DC/2.5/SC - Power supply unit

2904614

<https://www.phoenixcontact.com/us/products/2904614>



Primary-switched power supply, QUINT POWER, screw connection, DIN rail mounting, supply of devices possible via the TBUS DIN rail connector, protective coating, input: single-phase, output: 24 V DC/2.5 A

---

## ME 17,5 TBUS 1,5/ 5-ST-3,81 GN - DIN rail bus connectors

2709561

<https://www.phoenixcontact.com/us/products/2709561>

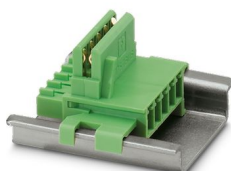

DIN rail connector for DIN rail mounting. Universal for TBUS housing. Gold-plated contacts, 5-pos.

# FL MC EF WDM-SET SC - FO converters



2902660

<https://www.phoenixcontact.com/us/products/2902660>

## ME 17,5 TBUS 1,5/ 5-ST-3,81 KMGY - DIN rail bus connectors

2713645

<https://www.phoenixcontact.com/us/products/2713645>

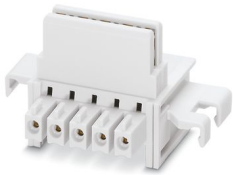

DIN rail connector, color: light grey, nominal current: 8 A (parallel contacts), rated voltage (III/2): 125 V, number of positions: 5, pitch: 3.81 mm, mounting: DIN rail mounting, locking: without, mounting: without, type of packaging: packed in cardboard, Item with gold-plated contacts, bus connectors for connecting with electronics housings, 5 parallel contacts

---

## FOC-LC:PA-SC:PA-OM2:D01/1 - FO patch cable

1115607

<https://www.phoenixcontact.com/us/products/1115607>

Multi-mode OM2 duplex jumper, LC-SC, UPC polishing, length 1 m

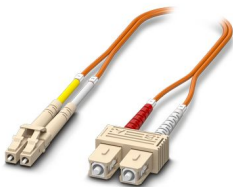



# FL MC EF WDM-SET SC - FO converters

2902660

<https://www.phoenixcontact.com/us/products/2902660>

## FOC-LC:PA-SC:PA-OM2:D01/2 - FO patch cable

1115605

<https://www.phoenixcontact.com/us/products/1115605>

Multi-mode OM2 duplex jumper, LC-SC, UPC polishing, length 2 m

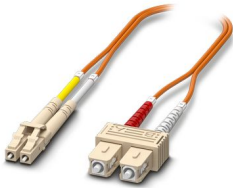

---

## FOC-SC:PA-SC:PA-OM2:D01/1 - FO patch cable

1115536

<https://www.phoenixcontact.com/us/products/1115536>

Multi-mode OM2 duplex jumper, SC-SC, UPC polishing, length 1 m

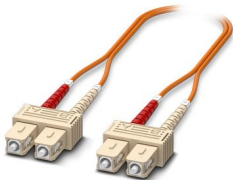

# FL MC EF WDM-SET SC - FO converters

2902660

<https://www.phoenixcontact.com/us/products/2902660>

## FOC-SC:PA-SC:PA-OM2:D01/2 - FO patch cable

1115535

<https://www.phoenixcontact.com/us/products/1115535>

Multi-mode OM2 duplex jumper, SC-SC, UPC polishing, length 2 m

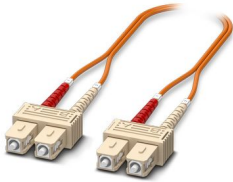

## FOC-ST:PA-SC:PA-OM2:D01/1 - FO patch cable

1115574

<https://www.phoenixcontact.com/us/products/1115574>

Multi-mode OM2 duplex jumper, ST-SC, UPC polishing, length 1 m

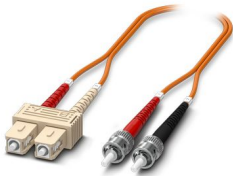

# FL MC EF WDM-SET SC - FO converters

2902660

<https://www.phoenixcontact.com/us/products/2902660>

## FOC-ST:PA-SC:PA-OM2:D01/2 - FO patch cable

1115573

<https://www.phoenixcontact.com/us/products/1115573>

Multi-mode OM2 duplex jumper, ST-SC, UPC polishing, length 2 m

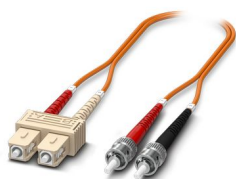

---

## FOC-LC:PA-SC:PA-OM4:D01/1 - FO patch cable

1115601

<https://www.phoenixcontact.com/us/products/1115601>

Multi-mode OM4 duplex jumper, LC-SC, UPC polishing, length 1 m

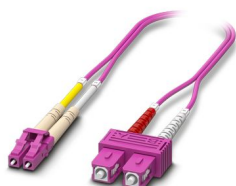

# FL MC EF WDM-SET SC - FO converters

2902660

<https://www.phoenixcontact.com/us/products/2902660>

## FOC-LC:PA-SC:PA-OM4:D01/2 - FO patch cable

1115600

<https://www.phoenixcontact.com/us/products/1115600>

Multi-mode OM4 duplex jumper, LC-SC, UPC polishing, length 2 m

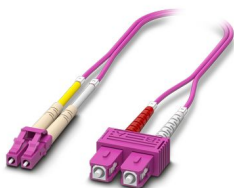

---

## FOC-SC:PA-SC:PA-OM4:D01/1 - FO patch cable

1115424

<https://www.phoenixcontact.com/us/products/1115424>

Multi-mode OM4 duplex jumper, SC-SC, UPC polishing, length 1 m

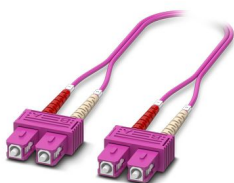

# FL MC EF WDM-SET SC - FO converters

2902660

<https://www.phoenixcontact.com/us/products/2902660>

## FOC-SC:PA-SC:PA-OM4:D01/2 - FO patch cable

1115423

<https://www.phoenixcontact.com/us/products/1115423>

Multi-mode OM4 duplex jumper, SC-SC, UPC polishing, length 2 m

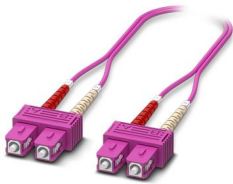

---

## VS-08-RJ45-5-Q/IP20 - RJ45 connector

1656725

<https://www.phoenixcontact.com/us/products/1656725>



RJ45 connector, design: RJ45, degree of protection: IP20, number of positions: 8, 1 Gbps, CAT5, material: Plastic, connection method: Insulation displacement connection, connection cross section: AWG 26- 23, cable outlet: straight, color: traffic grey A RAL 7042, Ethernet

# FL MC EF WDM-SET SC - FO converters



2902660

<https://www.phoenixcontact.com/us/products/2902660>

## VS-08-RJ45-5-Q/IP20 BK - RJ45 connector

1658008

<https://www.phoenixcontact.com/us/products/1658008>



RJ45 connector, design: RJ45, degree of protection: IP20, number of positions: 8, 1 Gbps, CAT5, material: Plastic, connection method: Insulation displacement connection, connection cross section: AWG 26- 23, cable outlet: straight, color: black, Ethernet

---

## FOC-GDM-RUGGED-1016/IP20/... - FO patch cable

2901558

<https://www.phoenixcontact.com/us/products/2901558>



Robust GOF installation cable for assembly (IP20 heads only) for installation in stationary systems and machines, aramid strain-relief elements, with individual elements made from FRNC material, halogen-free, ozone and UV resistant, with a polyurethane (PUR) outer sheath

# FL MC EF WDM-SET SC - FO converters

2902660

<https://www.phoenixcontact.com/us/products/2902660>

## FOC-GDO-1017/IP20/... - FO patch cable

2901559

<https://www.phoenixcontact.com/us/products/2901559>



Highly rugged GOF round cable (IP20 heads only) for assembly and for outdoor installation with integrated moisture barrier as well as rodent-proof scrim. Individual elements made from highly flexible FRNC material. The wire is ozone and UV resistant with a very rugged polyethylene outer sheath.

---

## PSM-LWL-GDO- 50/125 - FO cable

2799432

<https://www.phoenixcontact.com/us/products/2799432>



Fiberglass cable, duplex 50/125  $\mu\text{m}$ , by the meter, without connector, for outdoor installation

# FL MC EF WDM-SET SC - FO converters



2902660

<https://www.phoenixcontact.com/us/products/2902660>

## PSM-LWL-GDM-RUGGED- 50/125 - FO cable

2799322

<https://www.phoenixcontact.com/us/products/2799322>



Fiber glass cable, duplex 50 µm/125 µm, by the meter, without male connector, for installation in stationary systems and machines

---

## FOC-SC:PA-SC:PA-OS2:D01/1 - FO patch cable

1115550

<https://www.phoenixcontact.com/us/products/1115550>

Single-mode OS2 duplex jumper, SC-SC, UPC polishing, length 1 m

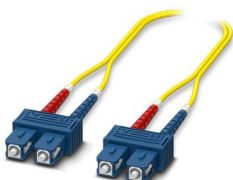



# FL MC EF WDM-SET SC - FO converters

2902660

<https://www.phoenixcontact.com/us/products/2902660>

## FOC-SC:PA-SC:PA-OS2:D01/2 - FO patch cable

1115548

<https://www.phoenixcontact.com/us/products/1115548>

Single-mode OS2 duplex jumper, SC-SC, UPC polishing, length 2 m

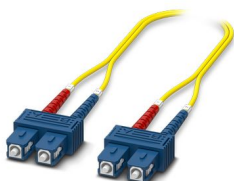

## FOC-ST:PA-SC:PA-OS2:D01/1 - FO patch cable

1115582

<https://www.phoenixcontact.com/us/products/1115582>

Single-mode OS2 duplex jumper, ST-SC, UPC polishing, length 1 m

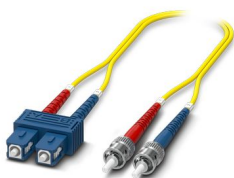

# FL MC EF WDM-SET SC - FO converters



2902660

<https://www.phoenixcontact.com/us/products/2902660>

## FOC-ST:PA-SC:PA-OS2:D01/2 - FO patch cable

1115581

<https://www.phoenixcontact.com/us/products/1115581>

Single-mode OS2 duplex jumper, ST-SC, UPC polishing, length 2 m



---

## FOC-LC:PA-SC:PA-OS2:D01/1 - FO patch cable

1115618

<https://www.phoenixcontact.com/us/products/1115618>

Single-mode OS2 duplex jumper, LC-SC, UPC polishing, length 1 m

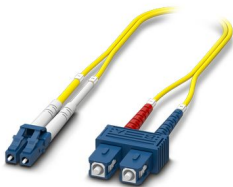

# FL MC EF WDM-SET SC - FO converters

2902660

<https://www.phoenixcontact.com/us/products/2902660>

## FOC-LC:PA-SC:PA-OS2:D01/2 - FO patch cable

1115617

<https://www.phoenixcontact.com/us/products/1115617>

Single-mode OS2 duplex jumper, LC-SC, UPC polishing, length 2 m

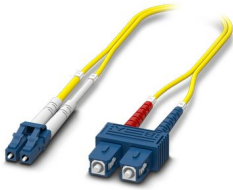

---

## FL CAT5 PATCH 0,5 - Patch cable

2832263

<https://www.phoenixcontact.com/us/products/2832263>

Patch cable, CAT5, assembled, 0.5 m

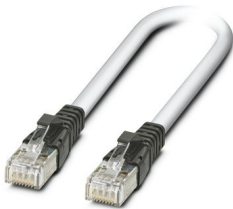

# FL MC EF WDM-SET SC - FO converters

2902660

<https://www.phoenixcontact.com/us/products/2902660>

## FL CAT5 PATCH 1,0 - Patch cable

2832276

<https://www.phoenixcontact.com/us/products/2832276>

Patch cable, CAT5, assembled, 1 m



---

## FL CAT5 PATCH 2,0 - Patch cable

2832289

<https://www.phoenixcontact.com/us/products/2832289>

Patch cable, CAT5, assembled, 2 m



# FL MC EF WDM-SET SC - FO converters



2902660

<https://www.phoenixcontact.com/us/products/2902660>

## FL CAT5 PATCH 3,0 - Patch cable

2832292

<https://www.phoenixcontact.com/us/products/2832292>

Patch cable, CAT5, assembled, 3 m



---

Phoenix Contact 2024 © - all rights reserved

<https://www.phoenixcontact.com>

Phoenix Contact USA  
586 Fulling Mill Road  
Middletown, PA 17057, United States  
(+717) 944-1300  
[info@phoenixcon.com](mailto:info@phoenixcon.com)