

RIF-1-RPT-LDP-24DC/2X21AU - Relay Module



2903330

<https://www.phoenixcontact.com/ca/products/2903330>

Please be informed that the data shown in this PDF document is generated from our online catalog. Please find the complete data in the user documentation. Our general terms of use for downloads are valid.



Preassembled relay module with Push-in connection, consisting of: relay base, multi-layer contact relay, plug-in display/interference suppression module, and retaining bracket. Contact switching type: 2 changeover contacts. Input voltage: 24 V DC

Product description

The pluggable electromechanical and solid-state relays in the RIFLINE complete product range and the base are recognized and approved in accordance with UL 508. The relevant approvals can be called up at the individual components in question.

Commercial data

Item number	2903330
Packing unit	10 pc
Minimum order quantity	10 pc
Sales key	CK05
Product key	CK652G
Catalog page	Page 327 (C-5-2019)
GTIN	4046356732314
Weight per piece (including packing)	67.7 g
Weight per piece (excluding packing)	67.7 g
Customs tariff number	85364110
Country of origin	CN

RIF-1-RPT-LDP-24DC/2X21AU - Relay Module



2903330

<https://www.phoenixcontact.com/ca/products/2903330>

Set consists of

RIF-1-BPT/2X21 - Relay base

2900931

<https://www.phoenixcontact.com/ca/products/2900931>



Relay base RIF-1..., for miniature power relay with 1 or 2 changeover contacts or solid-state relays of the same design, Push-in connection, plug-in option for input/interference suppression modules, for mounting on NS 35/7,5

REL-MR- 24DC/21-21AU - Single relay

2961215

<https://www.phoenixcontact.com/ca/products/2961215>



Plug-in miniature power relay, with multi-layer gold contact, 2 changeover contacts, input voltage 24 V DC

RIF-1-RPT-LDP-24DC/2X21AU - Relay Module



2903330

<https://www.phoenixcontact.com/ca/products/2903330>

RIF-LDP-12-24 DC - Plug-in module

2900939

<https://www.phoenixcontact.com/ca/products/2900939>



Plug-in module, for mounting on RIF-1, RIF-2, RIF-3, and RIF-4, with freewheeling diode and yellow LED, polarity: A1+, A2-, input voltage: 12 V DC ... 24 V DC $\pm 30\%$

RIF-RH-1 - Retaining bracket

2900953

<https://www.phoenixcontact.com/ca/products/2900953>



Relay retaining bracket, with ejector function and holder for marking material, suitable for RIF-1 relay base, for 16 mm tall miniature power relay and solid-state relay

Technical data

Notes

Notes on operation	FBS 2-6... plug-in bridge for the input side (A2) and FBS-2-8... plug-in bridge for the output side (11/21)
--------------------	---

Product properties

Product type	Relay Module
Product family	RIFLINE complete
Application	Universal
Operating mode	100% operating factor
Mechanical service life	approx. 3×10^7 cycles

Insulation characteristics

Insulation	Safe isolation between input and output
	Basic insulation between the changeover contacts

Insulation characteristics

Insulation	Safe isolation between input and output
	Basic insulation between the changeover contacts
Overvoltage category	III
Pollution degree	2

Electrical properties

Service life electrical	see diagram
Maximum power dissipation for nominal condition	0.43 W
Test voltage (Winding/contact)	4 kV _{rms} (50 Hz, 1 min., winding/contact)
Test voltage (Changeover contact/changeover contact)	2.5 kV _{rms} (50 Hz, 1 min., changeover contact/changeover contact)
Rated surge voltage	6 kV (Input/output)
	4 kV (between the changeover contacts)

Input data

Coil side

Nominal input voltage U_N	24 V DC
Input voltage range	19.2 V DC ... 33.6 V DC (20 °C)
Input voltage range in reference to U_N	see diagram
Drive and function	monostable
Drive (polarity)	polarized
Typical input current at U_N	18 mA
Typical response time	8 ms
Typical release time	10 ms
Coil voltage	24 V DC
Protective circuit	Freewheeling diode

RIF-1-RPT-LDP-24DC/2X21AU - Relay Module



2903330

<https://www.phoenixcontact.com/ca/products/2903330>

Operating voltage display	Yellow LED
---------------------------	------------

Output data

Switching

Contact switching type	2 changeover contacts
Type of switch contact	Single contact
Contact material	AgNi, hard gold-plated
Maximum switching voltage	30 V AC 36 V DC
Minimum switching voltage	100 mV (10 mA)
Limiting continuous current	50 mA
Maximum inrush current	50 mA
Min. switching current	1 mA (24 V)
Interrupting rating (ohmic load) max.	1.2 W (at 24 V DC)
Utilization category CB Scheme (IEC 60947-5-1)	AC15, 1.5 A/240 V (N/O contact) AC15, 2 A/250 V (N/C contact) DC13, 2 A/24 V (N/C contact) DC13, 0.2 A/250 V (N/O contact)

Switching: when the gold layer is destroyed

Note	the following values are applicable if a gold layer is destroyed
Contact material	AgNi
Maximum switching voltage	250 V AC/DC
Minimum switching voltage	5 V (at 10 mA)
Maximum inrush current	25 A (20 ms, N/O contacts)
Min. switching current	10 mA (At 5 V)
Interrupting rating (ohmic load) max.	192 W (at 24 V DC) 96 W (at 48 V DC) 60 W (at 60 V DC) 44 W (at 110 V DC) 57 W (at 220 V DC) 2000 VA (for 250 V AC)
Switching capacity	2 A (at 24 V, DC13) 0.2 A (at 110 V, DC13) 0.2 A (at 250 V, DC13) 2 A (at 24 V, AC15) 2 A (at 120 V, AC15) 2 A (at 250 V, AC15)

Connection data

Connection method	Push-in connection
Stripping length	8 mm
Conductor cross section rigid	0.14 mm ² ... 1.5 mm ²

RIF-1-RPT-LDP-24DC/2X21AU - Relay Module



2903330

<https://www.phoenixcontact.com/ca/products/2903330>

Conductor cross section flexible	0.14 mm ² ... 1.5 mm ²
	0.14 mm ² ... 1.5 mm ² (Ferrule with plastic sleeve)
	0.14 mm ² ... 1 mm ² (Ferrule with plastic sleeve, two conductors on double terminal block)
Conductor cross section AWG	26 ... 16 (solid)
	26 ... 16 (flexible)

Dimensions

Drill hole

Diameter	3.2 mm
Width	16 mm
Height	96 mm
Depth	75 mm

Material specifications

Color	gray (RAL 7042)
Flammability rating according to UL 94	V2 (Housing)

Environmental and real-life conditions

Ambient conditions

Degree of protection (Relay base)	IP20 (Relay base)
Degree of protection (Relay)	RT III (Relay)
Ambient temperature (operation)	-40 °C ... 70 °C
Ambient temperature (storage/transport)	-40 °C ... 85 °C

Approvals

Corrosive gas test

Identification	ISA-S71.04. G3 Harsh Group
	EN 60068-2-60

Standards and regulations

Standards/regulations	IEC 60947-5-1
-----------------------	---------------

Mounting

Mounting type	DIN rail mounting
Assembly instructions	in rows with zero spacing
Mounting position	any

Drawings

Circuit diagram

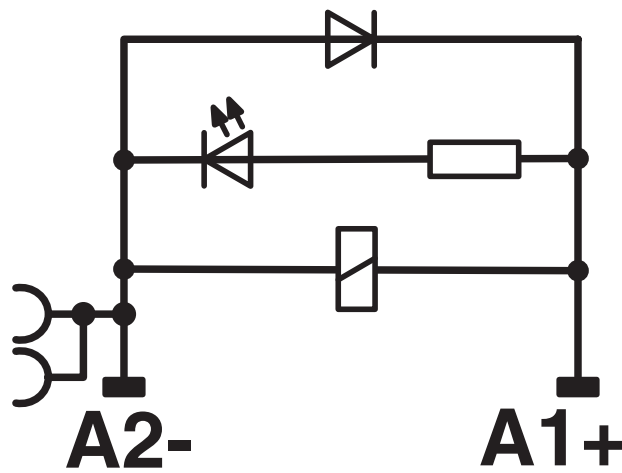
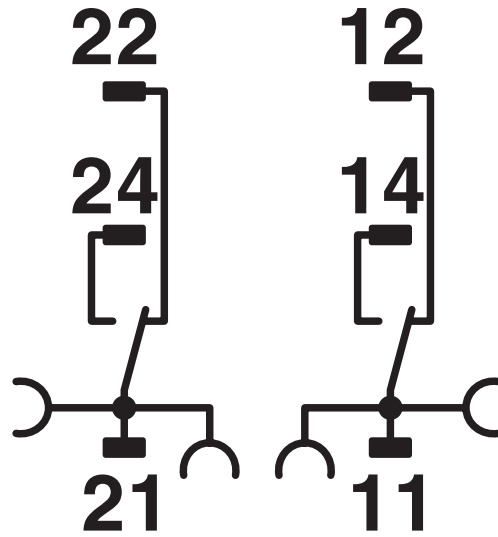

Diagram

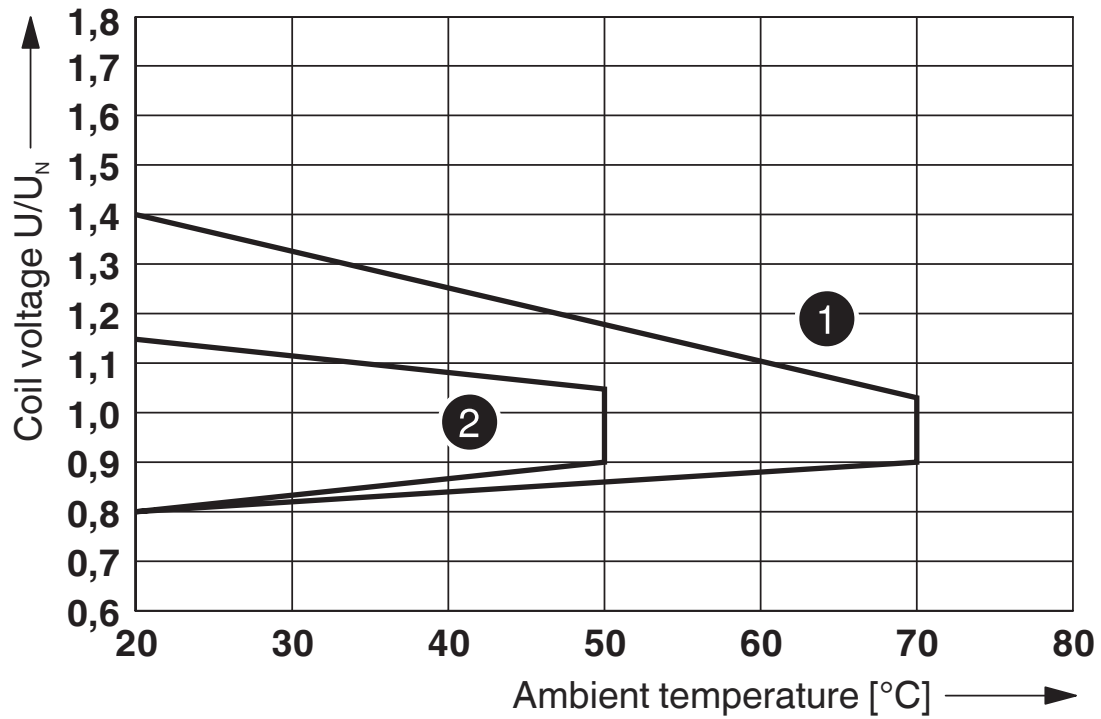

- ① DC coils
- ② AC coils

Operating voltage range

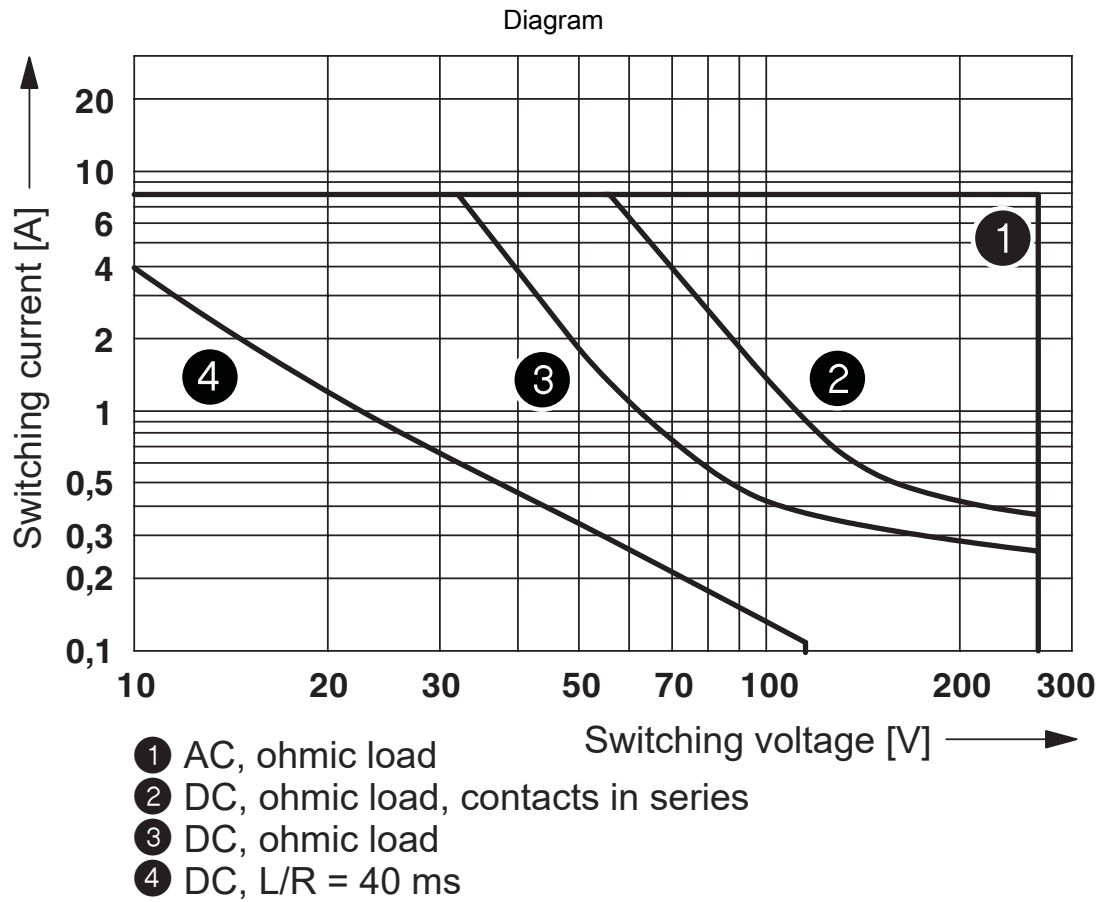

Interrupting rating

Diagram

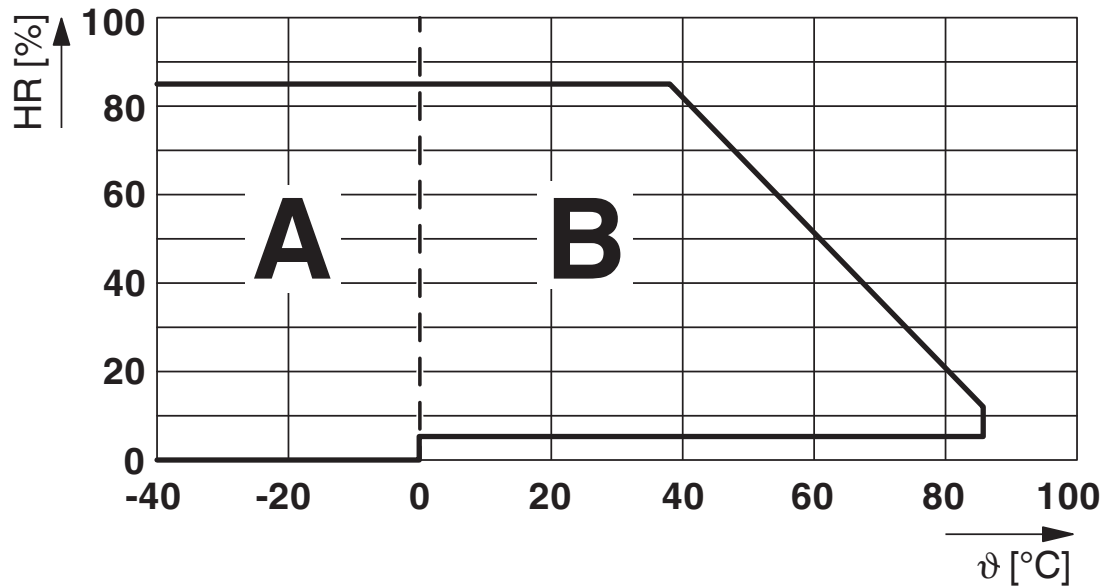

Permissible humidity for operation and storage.

The maximum permissible ambient temperature as specified in the data sheet must be observed.

Area A: Ice buildup at ambient temperatures $\leq 0^\circ\text{C}$ must be prevented

Area B: Condensation at ambient temperatures $> 0^\circ\text{C}$ must be prevented

On 30 full days that are naturally distributed across an entire year, a humidity level of 95% is permissible at an ambient temperature $\leq 25^\circ\text{C}$.

Diagram

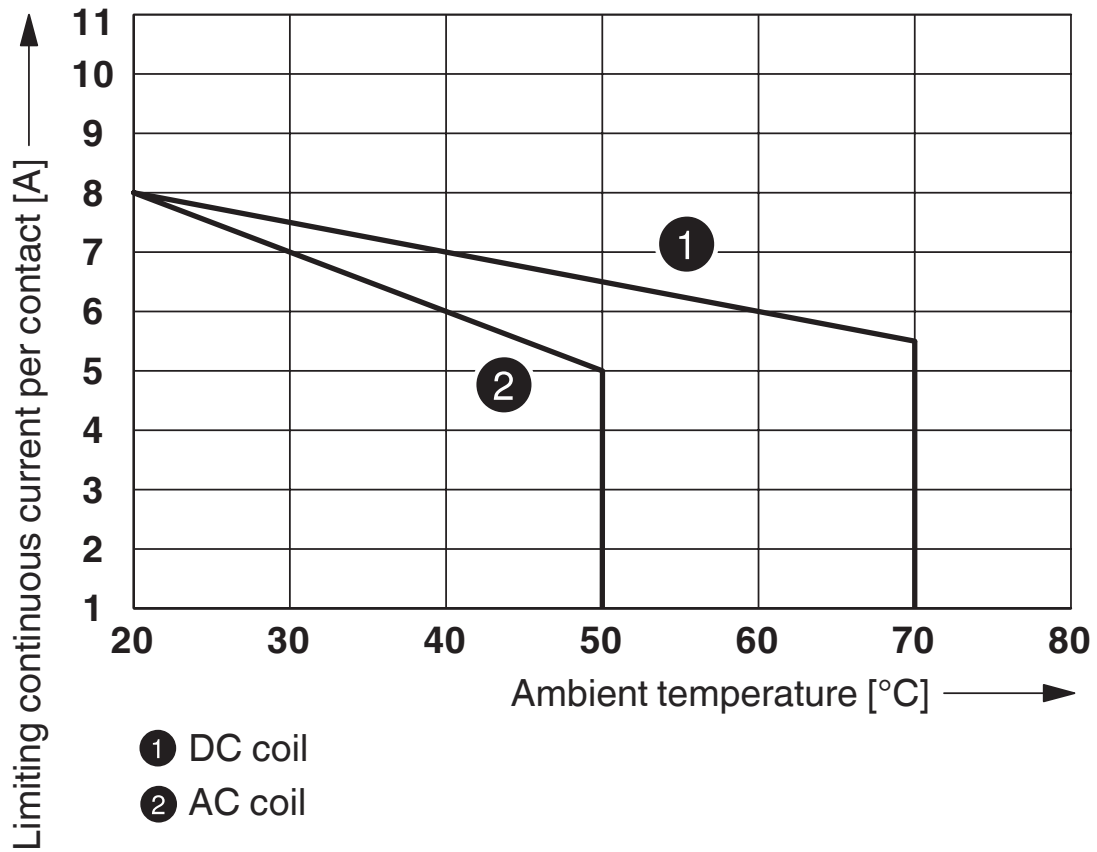

Contact derating

Diagram

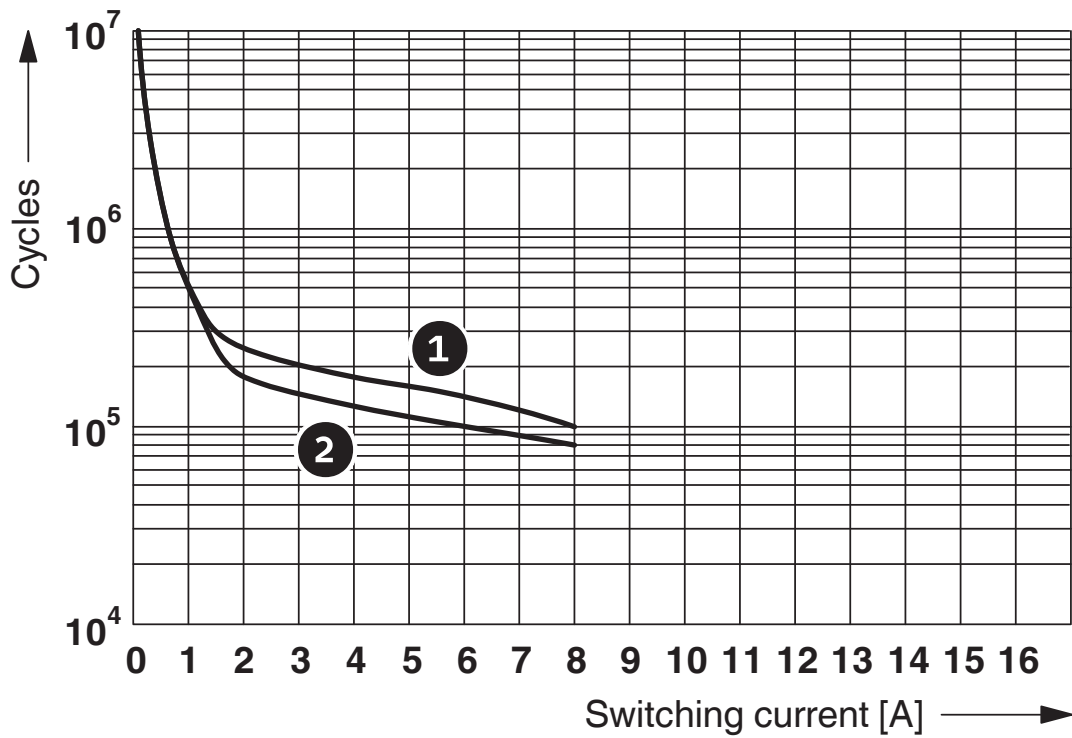

- ① 250 V AC, ohmic load (DC coils)
- ② 250 V AC, ohmic load (AC coils)

Electrical service life

Diagram

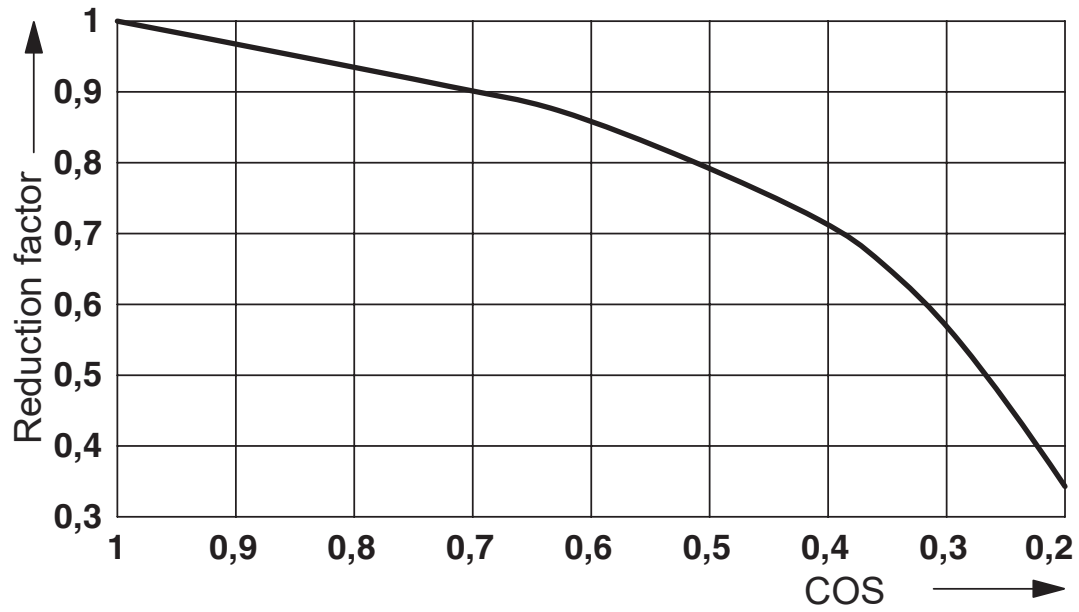

Service life reduction factor

RIF-1-RPT-LDP-24DC/2X21AU - Relay Module



2903330

<https://www.phoenixcontact.com/ca/products/2903330>

Approvals

To download certificates, visit the product detail page: <https://www.phoenixcontact.com/ca/products/2903330>



EAC

Approval ID: TR_TS_D_00573_c



DNV GL

Approval ID: TAA000018V



DNV GL

Approval ID: TAA000018V

RIF-1-RPT-LDP-24DC/2X21AU - Relay Module



2903330

<https://www.phoenixcontact.com/ca/products/2903330>

Classifications

ECLASS

ECLASS-11.0	27371601
ECLASS-12.0	27371601
ECLASS-13.0	27371601

ETIM

ETIM 9.0	EC001437
----------	----------

UNSPSC

UNSPSC 21.0	39122300
-------------	----------

2903330

<https://www.phoenixcontact.com/ca/products/2903330>

Environmental product compliance

EU RoHS

Fulfills EU RoHS substance requirements	Yes
Exemption	7(a), 7(c)-I

China RoHS

Environment friendly use period (EFUP)	EFUP-50
	An article-related China RoHS declaration table can be found in the download area for the respective article under "Manufacturer declaration". For all articles with EFUP-E, no China RoHS declaration table issued and required.

EU REACH SVHC

REACH candidate substance (CAS No.)	Lead(CAS: 7439-92-1)
-------------------------------------	----------------------

Phoenix Contact 2024 © - all rights reserved
<https://www.phoenixcontact.com>

PHOENIX CONTACT Ltd
8240 Parkhill Drive
Milton, Ontario L9T 5V7
1-800-890-2820
cdinfo@phoenixcontact.ca