

REL-IR4/LDP- 60DC/4X21AU - Single relay



2903672

<https://www.phoenixcontact.com/pc/products/2903672>

Please be informed that the data shown in this PDF document is generated from our online catalog. Please find the complete data in the user documentation. Our general terms of use for downloads are valid.



Plug-in industrial relay with power contacts and additional hard gold plating, 4 changeover contacts, test button, status LED, freewheeling diode, mechanical switching position indicator, polarity: A1+, A2-, coil voltage: 60 V DC

Commercial data

Item number	2903672
Packing unit	10 pc
Minimum order quantity	10 pc
Product key	CK6193
Catalog page	Page 292 (C-7-2013)
GTIN	4046356758857
Weight per piece (including packing)	34.88 g
Weight per piece (excluding packing)	34.88 g
Customs tariff number	85364190
Country of origin	PL

REL-IR4/LDP- 60DC/4X21AU - Single relay



2903672

<https://www.phoenixcontact.com/pc/products/2903672>

Technical data

Product properties

Product type	Single relay
Operating mode	100% operating factor
Mechanical service life	approx. 2×10^7 cycles

Insulation characteristics

Insulation	Basic insulation
------------	------------------

Insulation characteristics

Insulation	Basic insulation
Overvoltage category	II
Pollution degree	2

Electrical properties

Service life electrical	see diagram
Maximum power dissipation for nominal condition	1.08 W
Test voltage (Winding/contact)	2.5 kV _{rms} (50 Hz, 1 min., winding/contact)
Test voltage (Changeover contact/changeover contact)	2 kV _{rms} (50 Hz, 1 min., changeover contact/changeover contact)
Rated insulation voltage	250 V AC
Rated surge voltage	2.5 kV

Input data

Coil side

Nominal input voltage U_N	60 V DC
Input voltage range	48 V DC ... 108 V DC (20 °C)
Drive and function	monostable
Drive (polarity)	polarized
Typical input current at U_N	18 mA
Typical response time	13 ms
Typical release time	14 ms
Protective circuit	Freewheeling diode
Status display	Yellow LED

Output data

Switching

Contact switching type	4 changeover contacts
Type of switch contact	Single contact
Contact material	AgNi, hard gold-plated
Note	If the specified maximum values for multi-layer contact relays are exceeded, the gold plating is destroyed. The maximum values of the power contact relay are then valid. This can result in a shorter service life than with a pure power contact.

REL-IR4/LDP- 60DC/4X21AU - Single relay



2903672

<https://www.phoenixcontact.com/pc/products/2903672>

Maximum switching voltage	30 V AC
	36 V DC
Minimum switching voltage	2 V (At 24 mA)
Limiting continuous current	50 mA
Maximum inrush current	50 mA
Min. switching current	2 mA (24 V DC)
Interrupting rating (ohmic load) max.	1.2 W (at 24 V DC)
Switching capacity min.	48 mW
Motor load according to UL 508	1/3 HP, 240 V AC

Switching: when the gold layer is destroyed

Note	the following values are applicable if a gold layer is destroyed
Contact material	AgNi
Maximum switching voltage	250 V AC/DC
Minimum switching voltage	5 V (At 24 mA)
Limiting continuous current	6 A
Maximum inrush current	16 A (20 ms, N/O contacts)
Min. switching current	5 mA (at 24 V)
Interrupting rating (ohmic load) max.	144 W (at 24 V DC)
	124 W (at 48 V DC)
	108 W (at 60 V DC)
	52 W (at 110 V DC)
	48 W (at 220 V DC)
	1500 VA (for 250 V AC)
Switching capacity	2 A (at 24 V, DC13)
	0.22 A (at 120 V, DC13)
	0.11 A (at 250 V, DC13)
	1.5 A (at 24 V, AC15)
	1.5 A (at 120 V, AC15)
	1 A (at 240 V, AC15)

Connection data

Connection method	Plug-in connection
-------------------	--------------------

Dimensions

Width	21.2 mm
Height	27.5 mm
Depth	35.6 mm

Environmental and real-life conditions

Ambient conditions

Degree of protection	RT I
Ambient temperature (operation)	-40 °C ... 70 °C

REL-IR4/LDP- 60DC/4X21AU - Single relay



2903672

<https://www.phoenixcontact.com/pc/products/2903672>

Ambient temperature (storage/transport)	-40 °C ... 85 °C
---	------------------

Approvals

Corrosive gas test

Identification	ISA-S71.04. G3 Harsh Group
	EN 60068-2-60

Standards and regulations

Standards/regulations	IEC 60664
	IEC 61810

Mounting

Mounting position	any
-------------------	-----

2903672

<https://www.phoenixcontact.com/pc/products/2903672>

Drawings

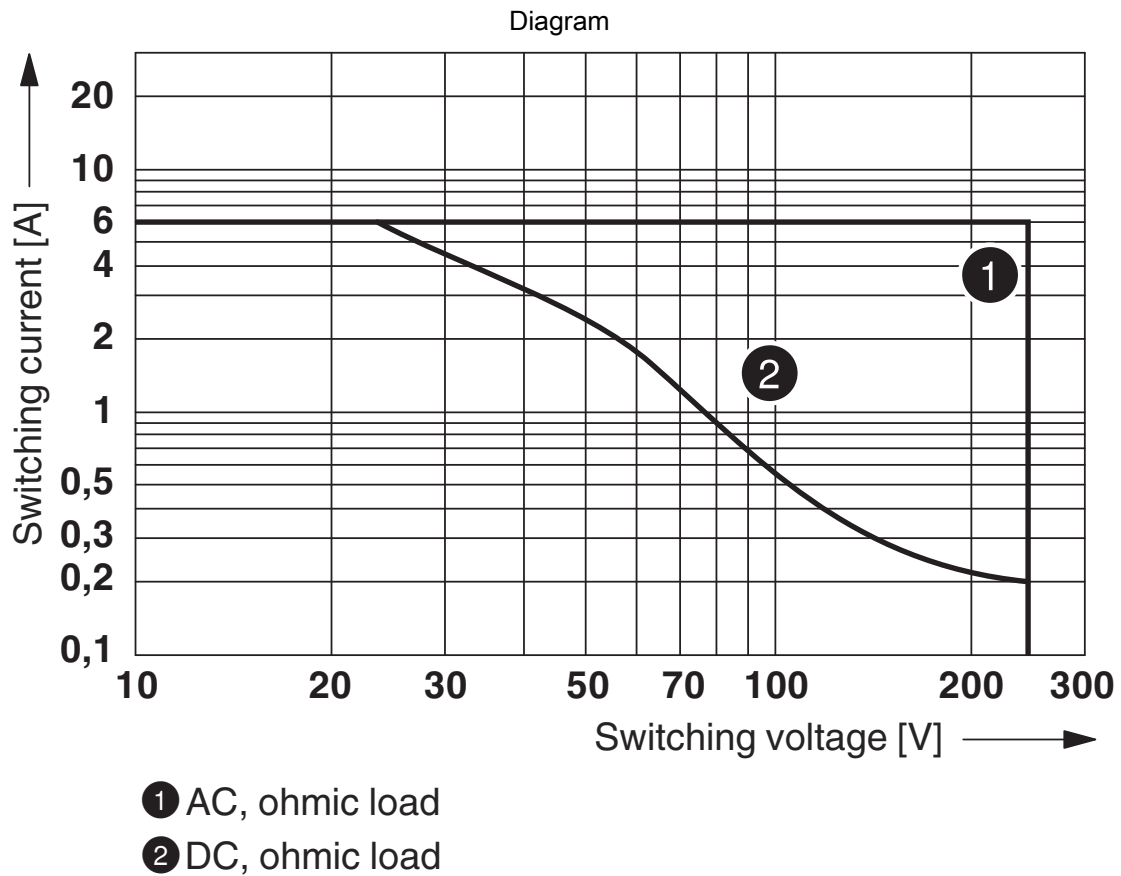

Interrupting rating

Diagram

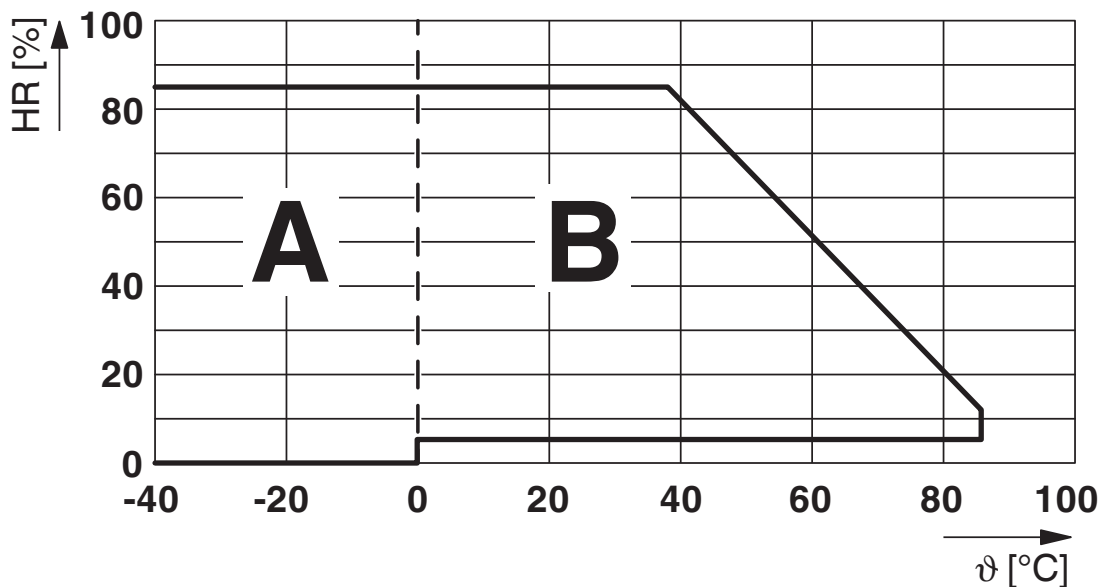

Permissible humidity for operation and storage.

The maximum permissible ambient temperature as specified in the data sheet must be observed.

Area A: Ice buildup at ambient temperatures $\leq 0^\circ\text{C}$ must be prevented

Area B: Condensation at ambient temperatures $> 0^\circ\text{C}$ must be prevented

On 30 full days that are naturally distributed across an entire year, a humidity level of 95% is permissible at an ambient temperature $\leq 25^\circ\text{C}$.

Circuit diagram

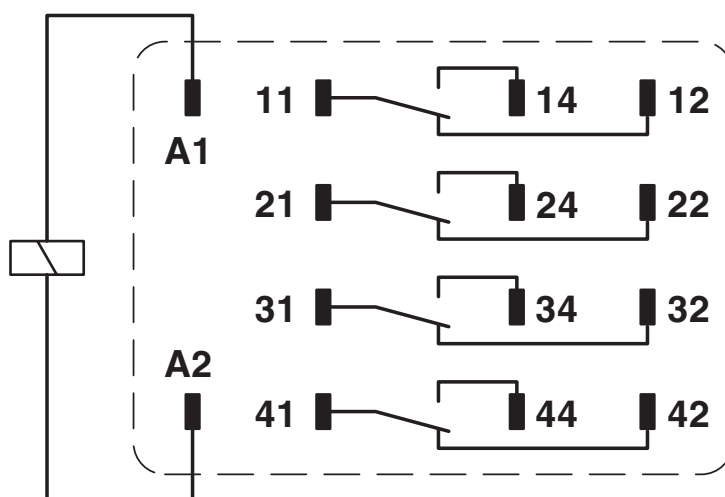

Diagram

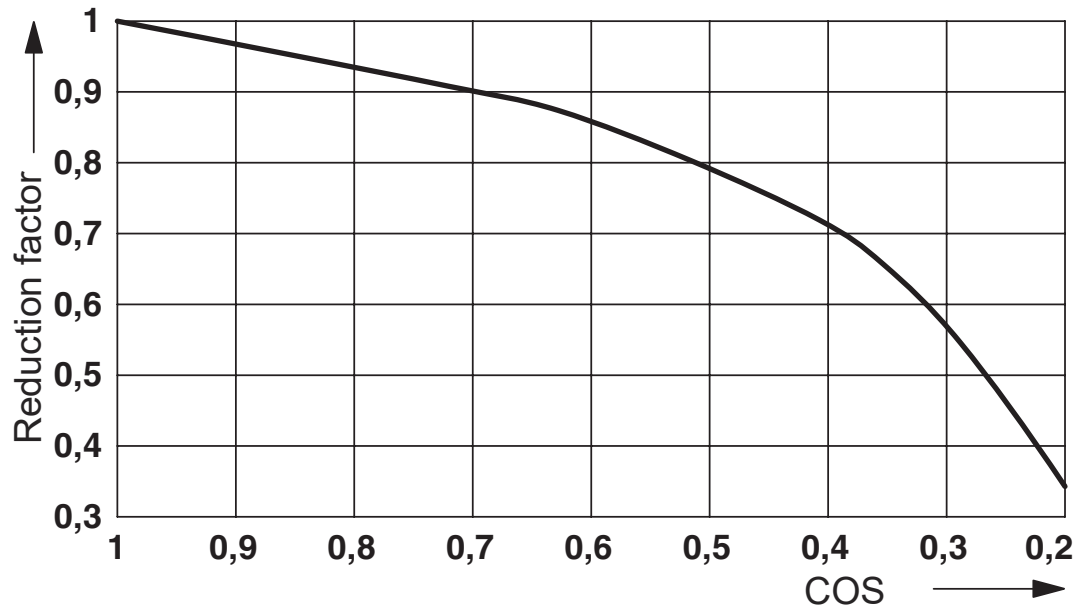

Service life reduction factor

Diagram

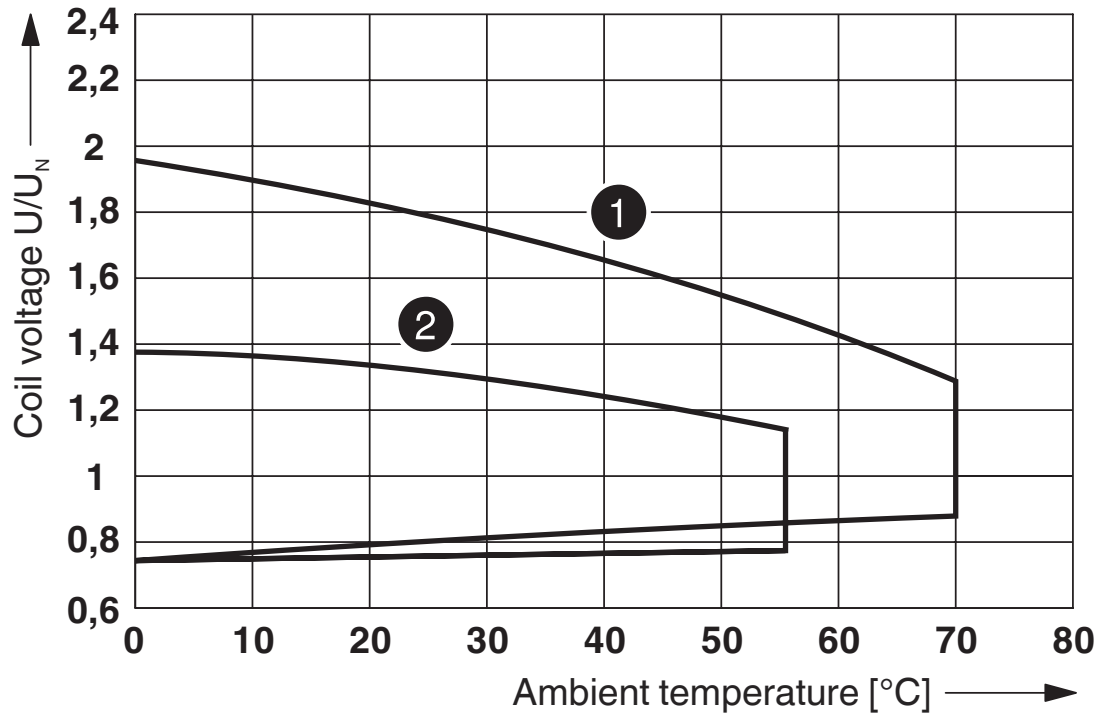

- ① DC coils
- ② AC coils

Operating voltage range

Diagram

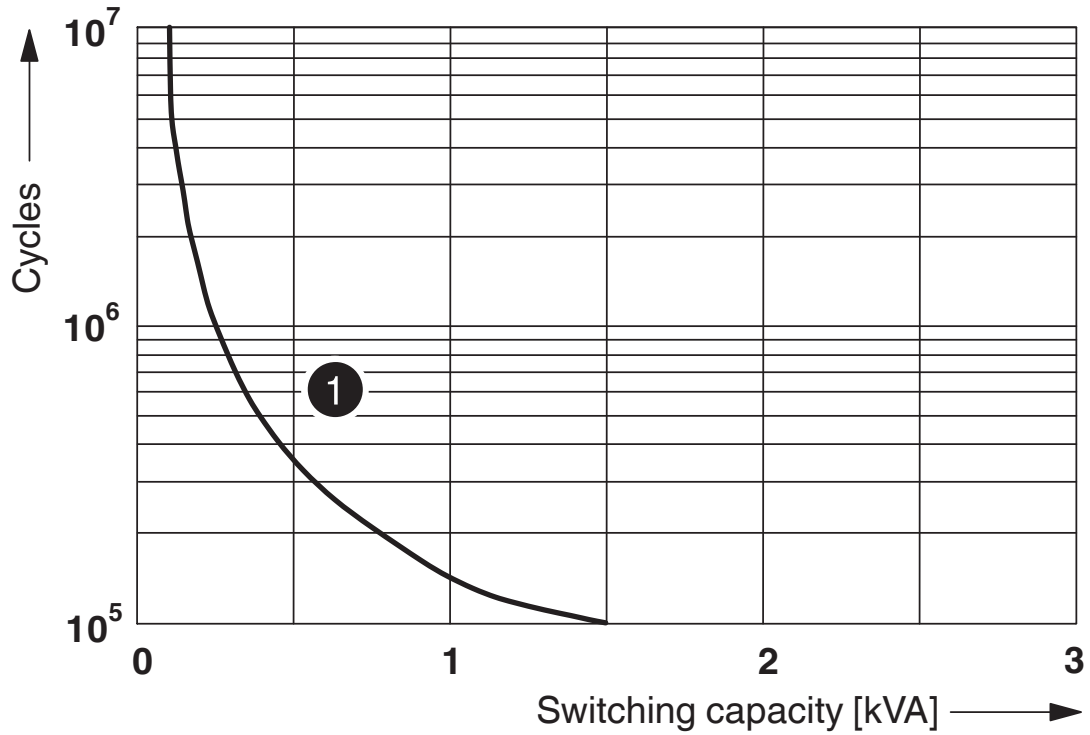

① 250 V AC, Ohmic load

Electrical service life

REL-IR4/LDP- 60DC/4X21AU - Single relay



2903672

<https://www.phoenixcontact.com/pc/products/2903672>

Approvals

To download certificates, visit the product detail page: <https://www.phoenixcontact.com/pc/products/2903672>



CSA

Approval ID: 256725



cUL Recognized

Approval ID: FILE E 172140



UL Recognized

Approval ID: FILE E 172140



EAC

Approval ID: TR_TS_D_00573_c



EAC

Approval ID: RU*C-DE.*08.B.00010



VDE Zeichengenehmigung

Approval ID: 40040427

cULus Recognized

REL-IR4/LDP- 60DC/4X21AU - Single relay



2903672

<https://www.phoenixcontact.com/pc/products/2903672>

Classifications

ECLASS

ECLASS-11.0	27371601
ECLASS-12.0	27371601
ECLASS-13.0	27371601

ETIM

ETIM 9.0	EC001437
----------	----------

UNSPSC

UNSPSC 21.0	39122300
-------------	----------

REL-IR4/LDP- 60DC/4X21AU - Single relay



2903672

<https://www.phoenixcontact.com/pc/products/2903672>

Environmental product compliance

EU RoHS

Fulfills EU RoHS substance requirements	Yes, No exemptions
---	--------------------

China RoHS

Environment friendly use period (EFUP)	EFUP-E
	No hazardous substances above the limits

EU REACH SVHC

REACH candidate substance (CAS No.)	No substance above 0.1 wt%
-------------------------------------	----------------------------

REL-IR4/LDP- 60DC/4X21AU - Single relay



2903672

<https://www.phoenixcontact.com/pc/products/2903672>

Mandatory accessories

RIF-2-BPT/4X21 - Relay base

2900934

<https://www.phoenixcontact.com/pc/products/2900934>



Relay base RIF-2..., for industrial relay with 2 or 4 changeover contacts, Push-in connection, plug-in option for input/interference suppression modules, for mounting on NS 35/7,5

RIF-2-BSC/4X21 - Relay base

2900932

<https://www.phoenixcontact.com/pc/products/2900932>

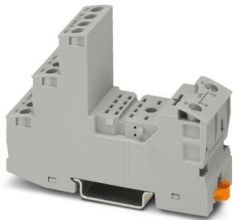

RIF-2... relay base, for industrial relay with 2 or 4 changeover contacts, screw connection, plug-in option for input/interference suppression modules, for mounting on NS 35/7,5

Phoenix Contact 2024 © - all rights reserved

<https://www.phoenixcontact.com>

PHOENIX CONTACT GmbH & Co. KG

Flachsmarktstraße 8

D-32825 Blomberg

+49 (0) 5235-3 00

info@phoenixcontact.com