

PTME 6 HV BU - Test disconnect terminal block



3035695

<https://www.phoenixcontact.com/us/products/3035695>

Please be informed that the data shown in this PDF document is generated from our online catalog. Please find the complete data in the user documentation. Our general terms of use for downloads are valid.



Test disconnect terminal block, nom. voltage: 1000 V, nominal current: 30 A, number of connections: 2, connection method: Push-in connection, 1 level, Rated cross section: 6 mm², cross section: 0.5 mm² - 10 mm², mounting type: NS 35/15, NS 35/7,5, color: blue

Commercial data

Item number	3035695
Packing unit	1 pc
Minimum order quantity	50 pc
Sales key	BE22
Product key	BE2233
Catalog page	Page 116 (C-1-2019)
GTIN	4046356644839
Weight per piece (including packing)	27.856 g
Weight per piece (excluding packing)	26.83 g
Customs tariff number	85369010
Country of origin	PL

PTME 6 HV BU - Test disconnect terminal block



3035695

<https://www.phoenixcontact.com/us/products/3035695>

Technical data

Product properties

Product type	Test disconnect terminal block
Number of connections	2
Number of rows	1
Potentials	1

Insulation characteristics

Overvoltage category	III
Degree of pollution	3

Electrical properties

Rated surge voltage	8 kV
Maximum power dissipation for nominal condition	1.31 W

Connection data

Number of connections per level	2
Nominal cross section	6 mm ²

1 level

Stripping length	12 mm
Internal cylindrical gage	A5
Connection in acc. with standard	IEC 60947-7-1
Conductor cross section rigid	0.5 mm ² ... 10 mm ²
Cross section AWG	20 ... 8 (converted acc. to IEC)
Conductor cross section flexible	0.5 mm ² ... 6 mm ²
Conductor cross section, flexible [AWG]	20 ... 10 (converted acc. to IEC)
Conductor cross-section flexible (ferrule without plastic sleeve)	0.5 mm ² ... 6 mm ²
Flexible conductor cross section (ferrule with plastic sleeve)	0.5 mm ² ... 6 mm ²
Conductor cross-section flexible (2 conductors with the same cross-section, with TWIN ferrule and plastic sleeve)	0.5 mm ² ... 1.5 mm ²
2 conductors with the same cross section, flexible, with TWIN ferrule with plastic sleeve	0.5 mm ² ... 1.5 mm ²
Nominal current	30 A
Maximum load current	30 A (with 10 mm ² conductor cross section)
Nominal voltage	1000 V
Nominal cross section	6 mm ²

1 level Connection cross sections directly pluggable

Conductor cross section rigid	1 mm ² ... 10 mm ²
Conductor cross-section flexible (ferrule without plastic sleeve)	1 mm ² ... 6 mm ²
Flexible conductor cross section (ferrule with plastic sleeve)	1 mm ² ... 6 mm ²

Dimensions

PTME 6 HV BU - Test disconnect terminal block



3035695

<https://www.phoenixcontact.com/us/products/3035695>

Width	8.2 mm
End cover width	2.2 mm
Height	100.8 mm
Depth	49 mm
Depth on NS 35/7,5	49.6 mm
Depth on NS 35/15	57.1 mm

Material specifications

Color	blue
Flammability rating according to UL 94	V0
Insulating material group	I
Insulating material	PA
Static insulating material application in cold	-60 °C
Temperature index of insulation material (DIN EN 60216-1 (VDE 0304-21))	130 °C
Relative insulation material temperature index (Elec., UL 746 B)	130 °C
Fire protection for rail vehicles (DIN EN 45545-2) R22	HL 1 - HL 3
Fire protection for rail vehicles (DIN EN 45545-2) R23	HL 1 - HL 3
Fire protection for rail vehicles (DIN EN 45545-2) R24	HL 1 - HL 3
Fire protection for rail vehicles (DIN EN 45545-2) R26	HL 1 - HL 3
Calorimetric heat release NFPA 130 (ASTM E 1354)	28 MJ/kg
Surface flammability NFPA 130 (ASTM E 162)	passed
Specific optical density of smoke NFPA 130 (ASTM E 662)	passed
Smoke gas toxicity NFPA 130 (SMP 800C)	passed

Electrical tests

Surge voltage test

Test voltage setpoint	9.8 kV
Result	Test passed

Temperature-rise test

Requirement temperature-rise test	Increase in temperature \leq 45 K
Result	Test passed
Short-time withstand current 4 mm ²	0.48 kA
Short-time withstand current 6 mm ²	0.5 kA
Result	Test passed

Power-frequency withstand voltage

Test voltage setpoint	2.2 kV
Result	Test passed

Mechanical properties

Mechanical data

Open side panel	Yes
-----------------	-----

PTME 6 HV BU - Test disconnect terminal block



3035695

<https://www.phoenixcontact.com/us/products/3035695>

Mechanical tests

Mechanical strength

Result	Test passed
--------	-------------

Attachment on the carrier

DIN rail/fixing support	NS 35
Test force setpoint	5 N
Result	Test passed

Test for conductor damage and slackening

Conductor cross section/weight	0.5 mm ² / 0.3 kg
	6 mm ² / 1.4 kg
	10 mm ² / 2 kg
Result	Test passed

Environmental and real-life conditions

Aging

Temperature cycles	192
Result	Test passed

Needle-flame test

Time of exposure	30 s
Result	Test passed

Oscillation/broadband noise

Specification	DIN EN 50155 (VDE 0115-200):2008-03
Spectrum	Service life test category 1, class B, body mounted
Frequency	$f_1 = 5 \text{ Hz}$ to $f_2 = 150 \text{ Hz}$
ASD level	1.857 (m/s ²)/Hz
Acceleration	0.8g
Test duration per axis	5 h
Test directions	X-, Y- and Z-axis
Result	Test passed

Shocks

Specification	DIN EN 50155 (VDE 0115-200):2008-03
Pulse shape	Half-sine
Acceleration	5g
Shock duration	30 ms
Number of shocks per direction	3
Test directions	X-, Y- and Z-axis (pos. and neg.)
Result	Test passed

Ambient conditions

Ambient temperature (operation)	-60 °C ... 110 °C (Operating temperature range incl. self-heating;
---------------------------------	--

PTME 6 HV BU - Test disconnect terminal block



3035695

<https://www.phoenixcontact.com/us/products/3035695>

	for max. short-term operating temperature, see RTI Elec.)
Ambient temperature (storage/transport)	-25 °C ... 60 °C ()
Ambient temperature (assembly)	-5 °C ... 70 °C
Ambient temperature (actuation)	-5 °C ... 70 °C
Permissible humidity (operation)	20 % ... 90 %
Permissible humidity (storage/transport)	30 % ... 70 %

Standards and regulations

Connection in acc. with standard	IEC 60947-7-1
----------------------------------	---------------

Mounting

Mounting type	NS 35/15
	NS 35/7,5

PTME 6 HV BU - Test disconnect terminal block



3035695

<https://www.phoenixcontact.com/us/products/3035695>

Drawings

Circuit diagram

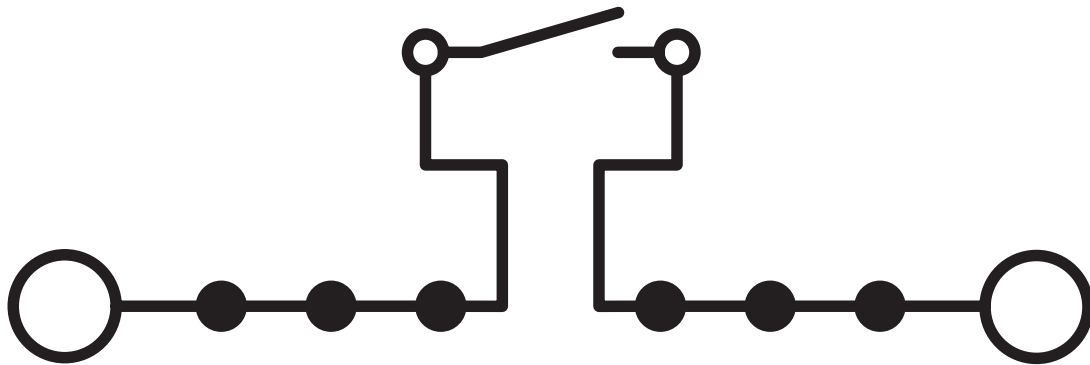

Circuit diagram

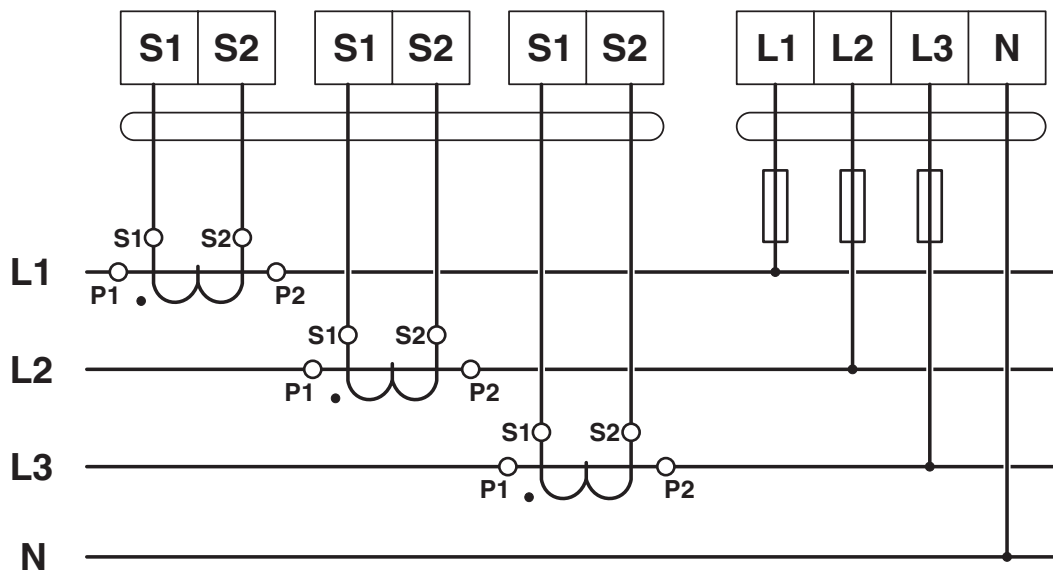

PTME 6 HV BU - Test disconnect terminal block



3035695

<https://www.phoenixcontact.com/us/products/3035695>

Circuit diagram

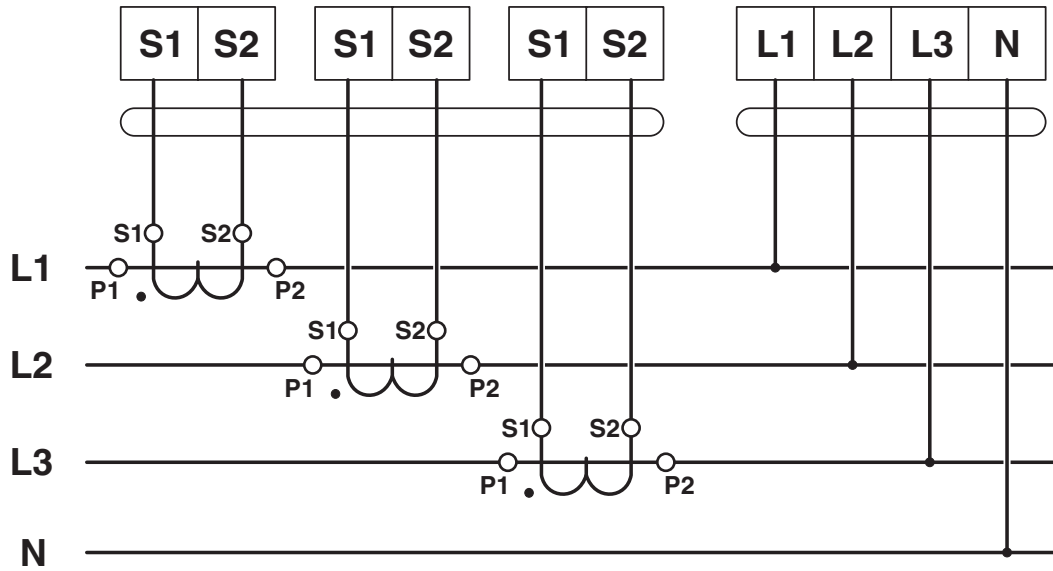

PTME 6 HV BU - Test disconnect terminal block





3035695

<https://www.phoenixcontact.com/us/products/3035695>

Approvals

To download certificates, visit the product detail page: <https://www.phoenixcontact.com/us/products/3035695>

 CSA Approval ID: 2030668				
	Nominal voltage U_N	Nominal current I_N	Cross section AWG	Cross section mm^2
Use group B	600 V	30 A	20 - 8	-
Use group C	600 V	30 A	20 - 8	-

 IECEE CB Scheme Approval ID: NL-37536				
---	--	--	--	--

 EAC Approval ID: RU C-DE.BL08.B.00644				
---	--	--	--	--

 KEMA-KEUR Approval ID: 2183172.01				
	Nominal voltage U_N	Nominal current I_N	Cross section AWG	Cross section mm^2
Only flexible conductors	1000 V	30 A	-	0.5 - 6
Only rigid conductors	1000 V	30 A	-	0.5 - 10

 cULus Recognized Approval ID: E60425				
--	--	--	--	--

 cULus Recognized Approval ID: E60425				
--	--	--	--	--

PTME 6 HV BU - Test disconnect terminal block



3035695

<https://www.phoenixcontact.com/us/products/3035695>

Classifications

ECLASS

ECLASS-11.0	27141126
ECLASS-12.0	27141126
ECLASS-13.0	27250109

ETIM

ETIM 9.0	EC000902
----------	----------

UNSPSC

UNSPSC 21.0	39121400
-------------	----------

PTME 6 HV BU - Test disconnect terminal block



3035695

<https://www.phoenixcontact.com/us/products/3035695>

Environmental product compliance

China RoHS	Environmentally friendly use period: unlimited = EFUP-e
	No hazardous substances above threshold values

PTME 6 HV BU - Test disconnect terminal block

3035695

<https://www.phoenixcontact.com/us/products/3035695>

Accessories

 Note: Applying some accessories below might limit this product.

FBS 2-8 - Plug-in bridge

3030284

<https://www.phoenixcontact.com/us/products/3030284>



Plug-in bridge, pitch: 8.2 mm, number of positions: 2, color: red

 Max. current carrying capacity: 30 A

FBS 3-8 - Plug-in bridge

3030297

<https://www.phoenixcontact.com/us/products/3030297>



Plug-in bridge, pitch: 8.2 mm, number of positions: 3, color: red

 Max. current carrying capacity: 30 A

PTME 6 HV BU - Test disconnect terminal block

3035695

<https://www.phoenixcontact.com/us/products/3035695>

FBS 4-8 - Plug-in bridge

3030307

<https://www.phoenixcontact.com/us/products/3030307>



Plug-in bridge, pitch: 8.2 mm, number of positions: 4, color: red

 Max. current carrying capacity: 30 A

FBS 5-8 - Plug-in bridge

3030310

<https://www.phoenixcontact.com/us/products/3030310>



Plug-in bridge, pitch: 8.2 mm, number of positions: 5, color: red

 Max. current carrying capacity: 30 A

PTME 6 HV BU - Test disconnect terminal block



3035695

<https://www.phoenixcontact.com/us/products/3035695>

FBS 10-8 - Plug-in bridge

3030323

<https://www.phoenixcontact.com/us/products/3030323>



Plug-in bridge, pitch: 8.2 mm, number of positions: 10, color: red

 Max. current carrying capacity: 30 A

FBS 6-8 - Plug-in bridge

3032470

<https://www.phoenixcontact.com/us/products/3032470>



Plug-in bridge, pitch: 8.2 mm, number of positions: 6, color: red

 Max. current carrying capacity: 30 A

PTME 6 HV BU - Test disconnect terminal block



3035695

<https://www.phoenixcontact.com/us/products/3035695>

FBS 1/3-8 - Plug-in bridge

3032363

<https://www.phoenixcontact.com/us/products/3032363>



Plug-in bridge, pitch: 8.2 mm, number of positions: 3, pin assignment: 1,3, color: red

 Max. current carrying capacity: 30 A

FBS 1/4-8 - Plug-in bridge

3032376

<https://www.phoenixcontact.com/us/products/3032376>



Plug-in bridge, pitch: 8.2 mm, number of positions: 4, pin assignment: 1, 4, color: red

 Max. current carrying capacity: 30 A

PTME 6 HV BU - Test disconnect terminal block



3035695

<https://www.phoenixcontact.com/us/products/3035695>

FBS 1/3/5-8 - Plug-in bridge

3032389

<https://www.phoenixcontact.com/us/products/3032389>



Plug-in bridge, pitch: 8.2 mm, number of positions: 5, pin assignment: 1,3,5, color: red

 Max. current carrying capacity: 30 A

FBS 1/4/7/10-8 - Plug-in bridge

3032402

<https://www.phoenixcontact.com/us/products/3032402>



Plug-in bridge, pitch: 8.2 mm, number of positions: 10, pin assignment: 1,4,7,10, color: red

 Max. current carrying capacity: 30 A

PTME 6 HV BU - Test disconnect terminal block



3035695

<https://www.phoenixcontact.com/us/products/3035695>

FBS 1/5-8 - Plug-in bridge

3032381

<https://www.phoenixcontact.com/us/products/3032381>



Plug-in bridge, pitch: 8.2 mm, number of positions: 5, pin assignment: 1,5, color: red

 Max. current carrying capacity: 30 A

SB-ME 2-8 - Switching jumper

3034468

<https://www.phoenixcontact.com/us/products/3034468>



Switching jumper, pitch: 8.2 mm, number of positions: 2, length: 25 mm, color: gray/orange

 Max. current carrying capacity: 30 A

PTME 6 HV BU - Test disconnect terminal block

3035695

<https://www.phoenixcontact.com/us/products/3035695>

SB-ME 3-8 - Switching jumper

3032800

<https://www.phoenixcontact.com/us/products/3032800>



Switching jumper, pitch: 8.2 mm, number of positions: 3, length: 25 mm, color: gray/orange

 Max. current carrying capacity: 30 A

SB-ME 4-8 - Switching jumper

3034484

<https://www.phoenixcontact.com/us/products/3034484>



Switching jumper, pitch: 8.2 mm, number of positions: 4, length: 25 mm, color: gray/orange

 Max. current carrying capacity: 30 A

PTME 6 HV BU - Test disconnect terminal block

3035695

<https://www.phoenixcontact.com/us/products/3035695>

SB-MER 2-8 - Switching jumper

3000587

<https://www.phoenixcontact.com/us/products/3000587>



Switching jumper, pitch: 8.2 mm, number of positions: 2, length: 25 mm, color: gray/orange

 Max. current carrying capacity: 25 A

SB-MER 3-8 - Switching jumper

3000588

<https://www.phoenixcontact.com/us/products/3000588>



Switching jumper, pitch: 8.2 mm, number of positions: 3, length: 25 mm, color: gray/orange

 Max. current carrying capacity: 25 A

PTME 6 HV BU - Test disconnect terminal block

3035695

<https://www.phoenixcontact.com/us/products/3035695>

SB-MER 4-8 - Switching jumper

3000589

<https://www.phoenixcontact.com/us/products/3000589>



Switching jumper, pitch: 8.2 mm, number of positions: 4, length: 25 mm, color: gray/orange

 Max. current carrying capacity: 25 A

FBSRH 2-8 - Short-circuit connector

3033802

<https://www.phoenixcontact.com/us/products/3033802>



Short-circuit connector, pitch: 8.2 mm, number of positions: 2, color: red

 Max. current carrying capacity: 30 A

PTME 6 HV BU - Test disconnect terminal block

3035695

<https://www.phoenixcontact.com/us/products/3035695>

FBSRH 3-8 - Short-circuit connector

3033803

<https://www.phoenixcontact.com/us/products/3033803>



Short-circuit connector, pitch: 8.2 mm, number of positions: 3, color: red

 Max. current carrying capacity: 30 A

FBSRH 4-8 - Short-circuit connector

3033804

<https://www.phoenixcontact.com/us/products/3033804>



Short-circuit connector, pitch: 8.2 mm, number of positions: 4, color: red

 Max. current carrying capacity: 30 A

PTME 6 HV BU - Test disconnect terminal block

3035695

<https://www.phoenixcontact.com/us/products/3035695>

FBSR 2-8 - Plug-in bridge

3033808

<https://www.phoenixcontact.com/us/products/3033808>



Plug-in bridge, pitch: 8.2 mm, number of positions: 2, color: red

 Max. current carrying capacity: 30 A

FBSR 3-8 - Plug-in bridge

3001597

<https://www.phoenixcontact.com/us/products/3001597>



Plug-in bridge, pitch: 8.2 mm, number of positions: 3, color: red

 Max. current carrying capacity: 30 A

PTME 6 HV BU - Test disconnect terminal block

3035695

<https://www.phoenixcontact.com/us/products/3035695>

FBSR 4-8 - Plug-in bridge

3000585

<https://www.phoenixcontact.com/us/products/3000585>



Plug-in bridge, pitch: 8.2 mm, number of positions: 4, color: red

 Max. current carrying capacity: 30 A

FBSR 5-8 - Plug-in bridge

3033809

<https://www.phoenixcontact.com/us/products/3033809>



Plug-in bridge, pitch: 8.2 mm, number of positions: 5, color: red

 Max. current carrying capacity: 30 A

PTME 6 HV BU - Test disconnect terminal block

3035695

<https://www.phoenixcontact.com/us/products/3035695>

FBSR 10-8 - Plug-in bridge

3001599

<https://www.phoenixcontact.com/us/products/3001599>



Plug-in bridge, pitch: 8.2 mm, number of positions: 10, color: red

 Max. current carrying capacity: 30 A

FBSR 16-8 - Plug-in bridge

3033816

<https://www.phoenixcontact.com/us/products/3033816>



Plug-in bridge, pitch: 8.2 mm, number of positions: 16, color: red

 Max. current carrying capacity: 30 A

PTME 6 HV BU - Test disconnect terminal block



3035695

<https://www.phoenixcontact.com/us/products/3035695>

FBSR 1/6/11/16-8 - Plug-in bridge

3033820

<https://www.phoenixcontact.com/us/products/3033820>



Plug-in bridge, non-adjacent, pitch: 8.2 mm, number of positions: 16, pin assignment: 1, 6, 11, 16, color: red

 Max. current carrying capacity: 30 A

FBSR 1/7/13/16-8 - Plug-in bridge

3033821

<https://www.phoenixcontact.com/us/products/3033821>



Plug-in bridge, non-adjacent, pitch: 8.2 mm, number of positions: 16, pin assignment: 1, 7, 13, 16, color: red

 Max. current carrying capacity: 30 A

PTME 6 HV BU - Test disconnect terminal block



3035695

<https://www.phoenixcontact.com/us/products/3035695>

FBSR 1/6/11/14-8 - Plug-in bridge

3033822

<https://www.phoenixcontact.com/us/products/3033822>



Plug-in bridge, non-adjacent, pitch: 8.2 mm, number of positions: 16, pin assignment: 1, 6, 11, 14, color: red

 Max. current carrying capacity: 30 A

FBS 2-8 CT - Plug-in bridge

3033830

<https://www.phoenixcontact.com/us/products/3033830>



Plug-in bridge, pitch: 8.2 mm, number of positions: 2, color: orange

 Max. current carrying capacity: 30 A

PTME 6 HV BU - Test disconnect terminal block

3035695

<https://www.phoenixcontact.com/us/products/3035695>

FBS 3-8 CT - Plug-in bridge

3033831

<https://www.phoenixcontact.com/us/products/3033831>



Plug-in bridge, pitch: 8.2 mm, number of positions: 3, color: orange

 Max. current carrying capacity: 30 A

FBS 4-8 CT - Plug-in bridge

3033832

<https://www.phoenixcontact.com/us/products/3033832>



Plug-in bridge, pitch: 8.2 mm, number of positions: 4, color: orange

 Max. current carrying capacity: 30 A

PTME 6 HV BU - Test disconnect terminal block

3035695

<https://www.phoenixcontact.com/us/products/3035695>

FBS 10-8 CT - Plug-in bridge

3033833

<https://www.phoenixcontact.com/us/products/3033833>



Plug-in bridge, pitch: 8.2 mm, number of positions: 10, color: orange

 Max. current carrying capacity: 30 A

FBS 2-8 BU - Plug-in bridge

3032567

<https://www.phoenixcontact.com/us/products/3032567>



Plug-in bridge, pitch: 8.2 mm, number of positions: 2, color: blue

 Max. current carrying capacity: 30 A

PTME 6 HV BU - Test disconnect terminal block

3035695

<https://www.phoenixcontact.com/us/products/3035695>

FBS 3-8 BU - Plug-in bridge

3032570

<https://www.phoenixcontact.com/us/products/3032570>



Plug-in bridge, pitch: 8.2 mm, number of positions: 3, color: blue

 Max. current carrying capacity: 30 A

FBS 4-8 BU - Plug-in bridge

3032583

<https://www.phoenixcontact.com/us/products/3032583>



Plug-in bridge, pitch: 8.2 mm, number of positions: 4, color: blue

 Max. current carrying capacity: 30 A

PTME 6 HV BU - Test disconnect terminal block

3035695

<https://www.phoenixcontact.com/us/products/3035695>

FBS 5-8 BU - Plug-in bridge

3032596

<https://www.phoenixcontact.com/us/products/3032596>



Plug-in bridge, pitch: 8.2 mm, number of positions: 5, color: blue

 Max. current carrying capacity: 30 A

FBS 6-8 BU - Plug-in bridge

3032677

<https://www.phoenixcontact.com/us/products/3032677>



Plug-in bridge, pitch: 8.2 mm, number of positions: 6, color: blue

 Max. current carrying capacity: 30 A

PTME 6 HV BU - Test disconnect terminal block

3035695

<https://www.phoenixcontact.com/us/products/3035695>

FBS 10-8 BU - Plug-in bridge

3032606

<https://www.phoenixcontact.com/us/products/3032606>



Plug-in bridge, pitch: 8.2 mm, number of positions: 10, color: blue

 Max. current carrying capacity: 30 A

FBS 2-8 GY - Plug-in bridge

3032621

<https://www.phoenixcontact.com/us/products/3032621>



Plug-in bridge, pitch: 8.2 mm, number of positions: 2, color: gray

 Max. current carrying capacity: 30 A

PTME 6 HV BU - Test disconnect terminal block

3035695

<https://www.phoenixcontact.com/us/products/3035695>

FBS 3-8 GY - Plug-in bridge

3032622

<https://www.phoenixcontact.com/us/products/3032622>



Plug-in bridge, pitch: 8.2 mm, number of positions: 3, color: gray

 Max. current carrying capacity: 30 A

FBS 4-8 GY - Plug-in bridge

3032635

<https://www.phoenixcontact.com/us/products/3032635>



Plug-in bridge, pitch: 8.2 mm, number of positions: 4, color: gray

 Max. current carrying capacity: 30 A

PTME 6 HV BU - Test disconnect terminal block

3035695

<https://www.phoenixcontact.com/us/products/3035695>

FBS 5-8 GY - Plug-in bridge

3032648

<https://www.phoenixcontact.com/us/products/3032648>



Plug-in bridge, pitch: 8.2 mm, number of positions: 5, color: gray

 Max. current carrying capacity: 30 A

FBS 6-8 GY - Plug-in bridge

3032664

<https://www.phoenixcontact.com/us/products/3032664>



Plug-in bridge, pitch: 8.2 mm, number of positions: 6, color: gray

 Max. current carrying capacity: 30 A

PTME 6 HV BU - Test disconnect terminal block



3035695

<https://www.phoenixcontact.com/us/products/3035695>

FBS 10-8 GY - Plug-in bridge

3032651

<https://www.phoenixcontact.com/us/products/3032651>

Plug-in bridge, pitch: 8.2 mm, number of positions: 10, color: gray



 Max. current carrying capacity: 30 A

D-DTME 6 - End cover

3034426

<https://www.phoenixcontact.com/us/products/3034426>

End cover, depth: 49.6 mm, width: 2.2 mm, height: 99.8 mm, color: gray



PTME 6 HV BU - Test disconnect terminal block



3035695

<https://www.phoenixcontact.com/us/products/3035695>

CARRIER 35-8 - Partition plate

3034387

<https://www.phoenixcontact.com/us/products/3034387>

Partition plate, With storage option for FBS...-8 and PAI 4-FIX, material: PA, color: gray



AP-ME

METER - Cover profile

3034361

<https://www.phoenixcontact.com/us/products/3034361>

Cover profile, for covering terminal strips, snapped onto APT-ME cover profile carrier or APH-ME end bracket. A cover profile carrier should be positioned at the ends and at intervals of around 40 cm. Length supplied: 1 m



PTME 6 HV BU - Test disconnect terminal block

3035695

<https://www.phoenixcontact.com/us/products/3035695>

APH-ME - Cover profile carrier

3034374

<https://www.phoenixcontact.com/us/products/3034374>



Cover profile carrier, for mounting on NS 35/7,5 DIN rail, for fixing the AP-ME cover profile, can be sealed as an option

APT-ME - Cover profile carrier

3034358

<https://www.phoenixcontact.com/us/products/3034358>



Cover profile carrier for mounting on NS 35/7.5 DIN rail for attaching the cover profile AP-ME

PTME 6 HV BU - Test disconnect terminal block



3035695

<https://www.phoenixcontact.com/us/products/3035695>

AH-ME - Covering hood

3240265

<https://www.phoenixcontact.com/us/products/3240265>



Cover, for the contact- and dust-protected encapsulation of the components

SL-SB - Switching lock

3035761

<https://www.phoenixcontact.com/us/products/3035761>



Switching lock, for additional locking of short-circuit switching elements in current transformer measuring circuits, depth: 13.6 mm, width: 12.5 mm, height: 16.3 mm, color: white

PTME 6 HV BU - Test disconnect terminal block

3035695

<https://www.phoenixcontact.com/us/products/3035695>

WS PT 6 - Warning label

1029029

<https://www.phoenixcontact.com/us/products/1029029>



Warning label, yellow/black, labeled: Lightning flash, mounting type: plug in, for terminal block width: 8.2 mm

LPS-8/E - Service connector

3270560

<https://www.phoenixcontact.com/us/products/3270560>



Service connector, nom. voltage: 800 V, nominal current: 24 A, number of positions: 1, connection method: Push-in connection, Rated cross section: 2.5 mm², cross section: 0.14 mm²- 4 mm², color: red

PTME 6 HV BU - Test disconnect terminal block



3035695

<https://www.phoenixcontact.com/us/products/3035695>

LPS-8 - Service connector

3270561

<https://www.phoenixcontact.com/us/products/3270561>



Service connector, nom. voltage: 800 V, nominal current: 24 A, number of positions: 1, connection method: Push-in connection, Rated cross section: 2.5 mm², cross section: 0.14 mm²- 4 mm², color: red

LPO 6/E - Pick-up plug

3270525

<https://www.phoenixcontact.com/us/products/3270525>



Pick-up plug, nom. voltage: 800 V, nominal current: 24 A, number of positions: 1, connection method: Push-in connection, Rated cross section: 2.5 mm², cross section: 0.14 mm²- 4 mm², color: gray

PTME 6 HV BU - Test disconnect terminal block



3035695

<https://www.phoenixcontact.com/us/products/3035695>

LPO 6 - Pick-up plug

3270526

<https://www.phoenixcontact.com/us/products/3270526>



Pick-up plug, nom. voltage: 800 V, nominal current: 24 A, number of positions: 1, connection method: Push-in connection, Rated cross section: 2.5 mm², cross section: 0.14 mm²- 4 mm², color: gray

ATS-PTME 6 - Partition plate

1183875

<https://www.phoenixcontact.com/us/products/1183875>



Partition plate, depth: 47 mm, width: 0.8 mm, height: 100.8 mm, color: gray

PTME 6 HV BU - Test disconnect terminal block



3035695

<https://www.phoenixcontact.com/us/products/3035695>

ATS-PTME 6 OG - Partition plate

1179660

<https://www.phoenixcontact.com/us/products/1179660>

Partition plate, depth: 47 mm, width: 0.8 mm, height: 100.8 mm, color: orange



NS 35/ 7,5 PERF 2000MM - DIN rail perforated

0801733

<https://www.phoenixcontact.com/us/products/0801733>

DIN rail perforated, Pack of 25 (50 m), acc. to EN 60715, material: Steel, galvanized, passivated with a thick layer, Standard profile, color: silver



PTME 6 HV BU - Test disconnect terminal block



3035695

<https://www.phoenixcontact.com/us/products/3035695>

NS 35/ 7,5 UNPERF 2000MM - DIN rail, unperforated

0801681

<https://www.phoenixcontact.com/us/products/0801681>



DIN rail, unperforated, Pack of 25 (50 m), acc. to EN 60715, material: Steel, galvanized, passivated with a thick layer, Standard profile, color: silver

NS 35/ 7,5 WH PERF 2000MM - DIN rail perforated

1204119

<https://www.phoenixcontact.com/us/products/1204119>



DIN rail perforated, Pack of 25 (50 m), acc. to EN 60715, material: Steel, Galvanized, white passivated, Standard profile, color: silver

PTME 6 HV BU - Test disconnect terminal block



3035695

<https://www.phoenixcontact.com/us/products/3035695>

NS 35/ 7,5 WH UNPERF 2000MM-VPE 10 - DIN rail, unperforated

1204122

<https://www.phoenixcontact.com/us/products/1204122>



DIN rail, unperforated, Pack of 10 (20 m), acc. to EN 60715, material: Steel, Galvanized, white passivated, Standard profile, color: silver

NS 35/ 7,5 AL UNPERF 2000MM - DIN rail, unperforated

0801704

<https://www.phoenixcontact.com/us/products/0801704>



DIN rail, unperforated, Pack of 25 (50 m), acc. to EN 60715, material: Aluminum, uncoated, Standard profile, color: silver

PTME 6 HV BU - Test disconnect terminal block



3035695

<https://www.phoenixcontact.com/us/products/3035695>

NS 35/ 7,5 ZN PERF 2000MM - DIN rail perforated

1206421

<https://www.phoenixcontact.com/us/products/1206421>



DIN rail perforated, Pack of 25 (50 m), acc. to EN 60715, material: Steel, galvanized, Standard profile, color: silver

NS 35/ 7,5 ZN UNPERF 2000MM - DIN rail, unperforated

1206434

<https://www.phoenixcontact.com/us/products/1206434>



DIN rail, unperforated, Pack of 25 (50 m), acc. to EN 60715, material: Steel, galvanized, Standard profile, color: silver

PTME 6 HV BU - Test disconnect terminal block



3035695

<https://www.phoenixcontact.com/us/products/3035695>

NS 35/ 7,5 CU UNPERF 2000MM-VPE 10 - DIN rail, unperforated

0801762

<https://www.phoenixcontact.com/us/products/0801762>



DIN rail, unperforated, Pack of 10 (20 m), acc. to EN 60715, material: Copper, uncoated, Standard profile, color: copper-colored

NS 35/ 7,5 CAP - End cap

1206560

<https://www.phoenixcontact.com/us/products/1206560>

DIN rail end piece, for DIN rail NS 35/7.5



PTME 6 HV BU - Test disconnect terminal block



3035695

<https://www.phoenixcontact.com/us/products/3035695>

NS 35/15 PERF 2000MM - DIN rail perforated

1201730

<https://www.phoenixcontact.com/us/products/1201730>



DIN rail perforated, Pack of 25 (50 m), similar to EN 60715, material: Steel, galvanized, passivated with a thick layer, Standard profile, color: silver

NS 35/15 UNPERF 2000MM - DIN rail, unperforated

1201714

<https://www.phoenixcontact.com/us/products/1201714>



DIN rail, unperforated, Pack of 25 (50 m), similar to EN 60715, material: Steel, galvanized, passivated with a thick layer, Standard profile, color: silver

PTME 6 HV BU - Test disconnect terminal block



3035695

<https://www.phoenixcontact.com/us/products/3035695>

NS 35/15 WH PERF 2000MM - DIN rail perforated

0806602

<https://www.phoenixcontact.com/us/products/0806602>



DIN rail perforated, Pack of 25 (50 m), similar to EN 60715, material: Steel, Galvanized, white passivated, Standard profile, color: white

NS 35/15 WH UNPERF 2000MM-VPE 10 - DIN rail, unperforated

1204135

<https://www.phoenixcontact.com/us/products/1204135>



DIN rail, unperforated, Pack of 10 (20 m), similar to EN 60715, material: Steel, Galvanized, white passivated, Standard profile, color: silver

PTME 6 HV BU - Test disconnect terminal block



3035695

<https://www.phoenixcontact.com/us/products/3035695>

NS 35/15 AL UNPERF 2000MM - DIN rail, unperforated

1201756

<https://www.phoenixcontact.com/us/products/1201756>



DIN rail, unperforated, similar to EN 60715, material: Aluminum, uncoated, Standard profile, color: silver

NS 35/15 ZN PERF 2000MM - DIN rail perforated

1206599

<https://www.phoenixcontact.com/us/products/1206599>



DIN rail perforated, Pack of 25 (50 m), similar to EN 60715, material: Steel, galvanized, Standard profile, color: silver

PTME 6 HV BU - Test disconnect terminal block



3035695

<https://www.phoenixcontact.com/us/products/3035695>

NS 35/15 ZN UNPERF 2000MM - DIN rail, unperforated

1206586

<https://www.phoenixcontact.com/us/products/1206586>



DIN rail, unperforated, Pack of 25 (50 m), similar to EN 60715, material: Steel, galvanized, Standard profile, color: silver

NS 35/15 CU UNPERF 2000MM-VPE 10 - DIN rail, unperforated

1201895

<https://www.phoenixcontact.com/us/products/1201895>



DIN rail, unperforated, Pack of 10 (20 m), similar to EN 60715, material: Copper, uncoated, Standard profile, color: copper-colored

PTME 6 HV BU - Test disconnect terminal block



3035695

<https://www.phoenixcontact.com/us/products/3035695>

NS 35/15 CAP - End cap

1206573

<https://www.phoenixcontact.com/us/products/1206573>

DIN rail end piece, for DIN rail NS 35/15



NS 35/15-2,3 UNPERF 2000MM-VPE 10 - DIN rail, unperforated

1201798

<https://www.phoenixcontact.com/us/products/1201798>



DIN rail, unperforated, Pack of 10 (20 m), acc. to EN 60715, material: Steel, galvanized, passivated with a thick layer, Standard profile 2.3 mm, color: silver

PTME 6 HV BU - Test disconnect terminal block



3035695

<https://www.phoenixcontact.com/us/products/3035695>

ZB 8:UNBEDRUCKT - Zack marker strip

1052002

<https://www.phoenixcontact.com/us/products/1052002>

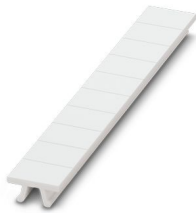

Zack marker strip, Strip, white, unlabeled, can be labeled with: PLOTMARK, CMS-P1-PLOTTER, mounting type: snapped, for terminal block width: 8.2 mm, lettering field size: 10.5 x 8.15 mm, Number of individual labels: 10

ZB 8 CUS - Zack marker strip

0825011

<https://www.phoenixcontact.com/us/products/0825011>

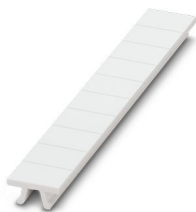

Zack marker strip, can be ordered: Strip, white, labeled according to customer specifications, mounting type: snap into tall marker groove, for terminal block width: 8.2 mm, lettering field size: 10.5 x 8.15 mm, Number of individual labels: 10

PTME 6 HV BU - Test disconnect terminal block



3035695

<https://www.phoenixcontact.com/us/products/3035695>

UC-TM 8 - Marker for terminal blocks

0818072

<https://www.phoenixcontact.com/us/products/0818072>



Marker for terminal blocks, Sheet, white, unlabeled, can be labeled with: BLUEMARK ID COLOR, BLUEMARK ID, BLUEMARK CLED, PLOTMARK, CMS-P1-PLOTTER, mounting type: snapped, for terminal block width: 8.2 mm, lettering field size: 7.6 x 10.5 mm, Number of individual labels: 56

UC-TM 8 CUS - Marker for terminal blocks

0824597

<https://www.phoenixcontact.com/us/products/0824597>



Marker for terminal blocks, can be ordered: by sheet, white, labeled according to customer specifications, mounting type: snap into tall marker groove, for terminal block width: 8.2 mm, lettering field size: 7.6 x 10.5 mm, Number of individual labels: 56

PTME 6 HV BU - Test disconnect terminal block



3035695

<https://www.phoenixcontact.com/us/products/3035695>

UCT-TM 8 - Marker for terminal blocks

0828740

<https://www.phoenixcontact.com/us/products/0828740>



Marker for terminal blocks, Sheet, white, unlabeled, can be labeled with: TOPMARK NEO, TOPMARK LASER, BLUEMARK ID COLOR, BLUEMARK ID, BLUEMARK CLED, THERMOMARK PRIME, THERMOMARK CARD 2.0, THERMOMARK CARD, mounting type: snapped, for terminal block width: 8.2 mm, lettering field size: 7.6 x 10.5 mm, Number of individual labels: 42

UCT-TM 8 CUS - Marker for terminal blocks

0829616

<https://www.phoenixcontact.com/us/products/0829616>



Marker for terminal blocks, can be ordered: by sheet, white, labeled according to customer specifications, mounting type: snap into tall marker groove, for terminal block width: 8.2 mm, lettering field size: 7.6 x 10.5 mm, Number of individual labels: 42

PTME 6 HV BU - Test disconnect terminal block



3035695

<https://www.phoenixcontact.com/us/products/3035695>

ZB 8,LGS:FORTL.ZAHLEN - Zack marker strip

1052015

<https://www.phoenixcontact.com/us/products/1052015>

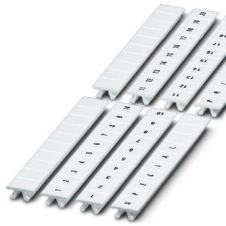

Zack marker strip, Strip, white, labeled, can be labeled with: CMS-P1-PLOTTER, printed horizontally: consecutive numbers 1 ... 10, 11 ... 20, etc. up to 91 ... 100, mounting type: snapped, for terminal block width: 8.2 mm, lettering field size: 10. 5 x 8.15 mm, Number of individual labels: 10

ZB 8,QR:FORTL.ZAHLEN - Zack marker strip

1052028

<https://www.phoenixcontact.com/us/products/1052028>



Zack marker strip, Strip, white, labeled, can be labeled with: CMS-P1-PLOTTER, Printed vertically: consecutive numbers 1 ... 10, 11 ... 20, etc. up to 91 ... 100, mounting type: snapped, for terminal block width: 8.2 mm, lettering field size: 10. 5 x 8.15 mm, Number of individual labels: 10

PTME 6 HV BU - Test disconnect terminal block



3035695

<https://www.phoenixcontact.com/us/products/3035695>

ZB 8,LGS:L1-N,PE - Marker for terminal blocks

1052413

<https://www.phoenixcontact.com/us/products/1052413>

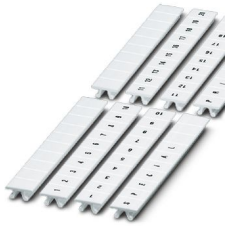

Marker for terminal blocks, Strip, white, labeled, can be labeled with: CMS-P1-PLOTTER, horizontal: L1, L2, L3, N, PE, L1, L2, L3, N, PE, mounting type: snapped, for terminal block width: 8.2 mm, lettering field size: 10.5 x 8.15 mm, Number of individual labels: 10

ZBF 8:UNBEDRUCKT - Zack Marker strip, flat

0808781

<https://www.phoenixcontact.com/us/products/0808781>



Zack Marker strip, flat, Strip, white, unlabeled, can be labeled with: PLOTMARK, CMS-P1-PLOTTER, mounting type: snapped, for terminal block width: 8 mm, lettering field size: 5.15 x 8.15 mm, Number of individual labels: 10

PTME 6 HV BU - Test disconnect terminal block



3035695

<https://www.phoenixcontact.com/us/products/3035695>

ZBF 8 CUS - Zack Marker strip, flat

0825030

<https://www.phoenixcontact.com/us/products/0825030>



Zack Marker strip, flat, can be ordered: Strip, white, labeled according to customer specifications, mounting type: snap into flat marker groove, for terminal block width: 8 mm, lettering field size: 5.15 x 8.15 mm, Number of individual labels: 10

ZBF 8,LGS:FORTL.ZAHLEN - Zack Marker strip, flat

0808804

<https://www.phoenixcontact.com/us/products/0808804>



Zack Marker strip, flat, Strip, white, labeled, printed horizontally: consecutive numbers 1 ... 10, 11 ... 20, etc. up to 101 ... 110, mounting type: snapped, for terminal block width: 8 mm, lettering field size: 5.15 x 8.15 mm, Number of individual labels: 10

PTME 6 HV BU - Test disconnect terminal block



3035695

<https://www.phoenixcontact.com/us/products/3035695>

UC-TMF 8 - Marker for terminal blocks

0818137

<https://www.phoenixcontact.com/us/products/0818137>



Marker for terminal blocks, Sheet, white, unlabeled, can be labeled with: BLUEMARK ID COLOR, BLUEMARK ID, BLUEMARK CLED, PLOTMARK, CMS-P1-PLOTTER, mounting type: snapped, for terminal block width: 8.2 mm, lettering field size: 7.6 x 5.1 mm, Number of individual labels: 56

UC-TMF 8 CUS - Marker for terminal blocks

0824654

<https://www.phoenixcontact.com/us/products/0824654>



Marker for terminal blocks, can be ordered: by sheet, white, labeled according to customer specifications, mounting type: snap into flat marker groove, for terminal block width: 8.2 mm, lettering field size: 7.6 x 5.1 mm, Number of individual labels: 56

PTME 6 HV BU - Test disconnect terminal block



3035695

<https://www.phoenixcontact.com/us/products/3035695>

UCT-TMF 8 - Marker for terminal blocks

0828748

<https://www.phoenixcontact.com/us/products/0828748>



Marker for terminal blocks, Sheet, white, unlabeled, can be labeled with: TOPMARK NEO, TOPMARK LASER, BLUEMARK ID COLOR, BLUEMARK ID, BLUEMARK CLED, THERMOMARK PRIME, THERMOMARK CARD 2.0, THERMOMARK CARD, mounting type: snapped, for terminal block width: 8.2 mm, lettering field size: 7.4 x 4.7 mm, Number of individual labels: 42

UCT-TMF 8 CUS - Marker for terminal blocks

0829672

<https://www.phoenixcontact.com/us/products/0829672>



Marker for terminal blocks, can be ordered: by sheet, white, labeled according to customer specifications, mounting type: snap into flat marker groove, for terminal block width: 8.2 mm, lettering field size: 7.4 x 4.7 mm, Number of individual labels: 42

PTME 6 HV BU - Test disconnect terminal block



3035695

<https://www.phoenixcontact.com/us/products/3035695>

PAI-4-FIX BU - Test adapter

3032729

<https://www.phoenixcontact.com/us/products/3032729>



Test adapter, Touch proof against unintentional direct contact according to DIN EN 50274 when plugged in, for 4 mm test plug and terminal blocks with 8.2 mm pitch, number of positions: 1, color: blue

PAI-4-FIX OG - Test adapter

3034455

<https://www.phoenixcontact.com/us/products/3034455>



4 mm test adapter, for terminal blocks with 8.2 mm pitch

PTME 6 HV BU - Test disconnect terminal block



3035695

<https://www.phoenixcontact.com/us/products/3035695>

PAI-4-FIX YE - Test adapter

3032745

<https://www.phoenixcontact.com/us/products/3032745>



Test adapter, Touch proof against unintentional direct contact according to DIN EN 50274 when plugged in, for 4 mm test plug and terminal blocks with 8.2 mm pitch, number of positions: 1, color: yellow

PAI-4-FIX RD - Test adapter

3032732

<https://www.phoenixcontact.com/us/products/3032732>



Test adapter, Touch proof against unintentional direct contact according to DIN EN 50274 when plugged in, for 4 mm test plug and terminal blocks with 8.2 mm pitch, number of positions: 1, color: red

PTME 6 HV BU - Test disconnect terminal block



3035695

<https://www.phoenixcontact.com/us/products/3035695>

PAI-4-FIX GN - Test adapter

3032758

<https://www.phoenixcontact.com/us/products/3032758>



Test adapter, Touch proof against unintentional direct contact according to DIN EN 50274 when plugged in, for 4 mm test plug and terminal blocks with 8.2 mm pitch, number of positions: 1, color: green

PAI-4-FIX BK - Test adapter

3032774

<https://www.phoenixcontact.com/us/products/3032774>



Test adapter, Touch proof against unintentional direct contact according to DIN EN 50274 when plugged in, for 4 mm test plug and terminal blocks with 8.2 mm pitch, number of positions: 1, color: black

PTME 6 HV BU - Test disconnect terminal block



3035695

<https://www.phoenixcontact.com/us/products/3035695>

PAI-4-FIX GY - Test adapter

3032790

<https://www.phoenixcontact.com/us/products/3032790>



Test adapter, Touch proof against unintentional direct contact according to DIN EN 50274 when plugged in, for 4 mm test plug and terminal blocks with 8.2 mm pitch, number of positions: 1, color: gray

PAI-4-FIX VT - Test adapter

3032761

<https://www.phoenixcontact.com/us/products/3032761>



Test adapter, Touch proof against unintentional direct contact according to DIN EN 50274 when plugged in, for 4 mm test plug and terminal blocks with 8.2 mm pitch, number of positions: 1, color: violet

PTME 6 HV BU - Test disconnect terminal block



3035695

<https://www.phoenixcontact.com/us/products/3035695>

PAI-4-FIX BN - Test adapter

3032787

<https://www.phoenixcontact.com/us/products/3032787>



Test adapter, Touch proof against unintentional direct contact according to DIN EN 50274 when plugged in, for 4 mm test plug and terminal blocks with 8.2 mm pitch, number of positions: 1, color: brown

PAI-4-FIX WH - Test adapter

3032797

<https://www.phoenixcontact.com/us/products/3032797>



Test adapter, Touch proof against unintentional direct contact according to DIN EN 50274 when plugged in, for 4 mm test plug and terminal blocks with 8.2 mm pitch, number of positions: 1, color: white

PTME 6 HV BU - Test disconnect terminal block



3035695

<https://www.phoenixcontact.com/us/products/3035695>

PAIS-4-FIX GY - Test adapter

3032791

<https://www.phoenixcontact.com/us/products/3032791>



Test adapter, Touch proof against unintentional direct contact according to DIN EN 50274 when plugged in, for 4 mm test plug and terminal blocks with 5.2 mm, 6.2 mm, and 8.2 mm pitch, number of positions: 1, color: gray

PAIS-4-FIX BK - Test adapter

3032792

<https://www.phoenixcontact.com/us/products/3032792>



Test adapter, Touch proof against unintentional direct contact according to DIN EN 50274 when plugged in, for 4 mm test plug and terminal blocks with 5.2 mm, 6.2 mm, and 8.2 mm pitch, number of positions: 1, color: black

PTME 6 HV BU - Test disconnect terminal block



3035695

<https://www.phoenixcontact.com/us/products/3035695>

PAIS-4-FIX RD - Test adapter

3032793

<https://www.phoenixcontact.com/us/products/3032793>



Test adapter, Do not plug in while the power is connected, for 4 mm test plug and terminal blocks with 5.2 mm, 6.2 mm, and 8.2 mm pitch, number of positions: 1, color: red

PAIS-4-FIX BU - Test adapter

3032798

<https://www.phoenixcontact.com/us/products/3032798>



Test adapter, Touch proof against unintentional direct contact according to DIN EN 50274 when plugged in, for 4 mm test plug and terminal blocks with 5.2 mm, 6.2 mm, and 8.2 mm pitch, number of positions: 1, color: blue

PTME 6 HV BU - Test disconnect terminal block



3035695

<https://www.phoenixcontact.com/us/products/3035695>

PAIS-4-FIX YE - Test adapter

3032799

<https://www.phoenixcontact.com/us/products/3032799>



Test adapter, Touch proof against unintentional direct contact according to DIN EN 50274 when plugged in, for 4 mm test plug and terminal blocks with 5.2 mm, 6.2 mm, and 8.2 mm pitch, number of positions: 1, color: yellow

PAIS-4-FIX GN - Test adapter

3032801

<https://www.phoenixcontact.com/us/products/3032801>



Test adapter, Touch proof against unintentional direct contact according to DIN EN 50274 when plugged in, for 4 mm test plug and terminal blocks with 5.2 mm, 6.2 mm, and 8.2 mm pitch, number of positions: 1, color: green

PTME 6 HV BU - Test disconnect terminal block



3035695

<https://www.phoenixcontact.com/us/products/3035695>

PAIS-4-FIX VT - Test adapter

3032802

<https://www.phoenixcontact.com/us/products/3032802>



Test adapter, Touch proof against unintentional direct contact according to DIN EN 50274 when plugged in, for 4 mm test plug and terminal blocks with 5.2 mm, 6.2 mm, and 8.2 mm pitch, number of positions: 1, color: violet

PS-6 - Test plug

3030996

<https://www.phoenixcontact.com/us/products/3030996>



Test plug, Modular test plug, number of positions: 1, color: red

PTME 6 HV BU - Test disconnect terminal block



3035695

<https://www.phoenixcontact.com/us/products/3035695>

PS-6/2,3MM RD - Test plug

3038736

<https://www.phoenixcontact.com/us/products/3038736>



Test plug, number of positions: 1, color: red

SZF 2-0,8X4,0 - Screwdriver

1204520

<https://www.phoenixcontact.com/us/products/1204520>



Actuation tool, for ST terminal blocks, also suitable for use as a bladed screwdriver, size: 0.8 x 4.0 x 100 mm, 2-component grip, with non-slip grip

PTME 6 HV BU - Test disconnect terminal block



3035695

<https://www.phoenixcontact.com/us/products/3035695>

C-ME 6/1 - Operating lever

3034441

<https://www.phoenixcontact.com/us/products/3034441>



Operating lever, for switching test disconnect terminal blocks on and off

C-ME 6/2 - Operating lever

3034442

<https://www.phoenixcontact.com/us/products/3034442>



Operating lever, depth: 5 mm, width: 16 mm, height: 5 mm, number of positions: 2, color: orange

PTME 6 HV BU - Test disconnect terminal block



3035695

<https://www.phoenixcontact.com/us/products/3035695>

S-ME 6 - Switching lock

3034439

<https://www.phoenixcontact.com/us/products/3034439>

Switching lock, width: 8.2 mm, height: 12 mm, color: white



C-ME 6/3 - Operating lever

3034390

<https://www.phoenixcontact.com/us/products/3034390>

Operating lever, depth: 5 mm, width: 24.1 mm, height: 5 mm, number of positions: 3, color: orange



PTME 6 HV BU - Test disconnect terminal block



3035695

<https://www.phoenixcontact.com/us/products/3035695>

SZF 1-0,6X3,5 - Screwdriver

1204517

<https://www.phoenixcontact.com/us/products/1204517>



Actuation tool, for ST terminal blocks, also suitable for use as a bladed screwdriver, size: 0.6 x 3.5 x 100 mm, 2-component grip, with non-slip grip

TS-UT 6-T/SP - Separating plate

3072821

<https://www.phoenixcontact.com/us/products/3072821>



Separating plate, depth: 67.5 mm, width: 1 mm, height: 105.2 mm, color: gray

PTME 6 HV BU - Test disconnect terminal block



3035695

<https://www.phoenixcontact.com/us/products/3035695>

PROJECT COMPLETE - Software

1050453

<https://www.phoenixcontact.com/us/products/1050453>



Intuitive planning and marking software for configuring terminal strips and for professional marking of marking materials for terminal blocks, conductors, cables, devices, and systems. The software is available for download

CRIMPFOX CENTRUS 6S - Crimping pliers

1213144

<https://www.phoenixcontact.com/us/products/1213144>



Crimping pliers, for uninsulated and insulated ferrules, DIN 46228 Part 1 and 4, from 0.14 mm² ... 6 mm², also for TWIN ferrules up to 2 x 4 mm², automatic cross section adjustment, lateral insertion, equipped with fall protection

PTME 6 HV BU - Test disconnect terminal block



3035695

<https://www.phoenixcontact.com/us/products/3035695>

CRIMPFOX CENTRUS 10S - Crimping pliers

1213154

<https://www.phoenixcontact.com/us/products/1213154>



Crimping pliers, for uninsulated and insulated ferrules, DIN 46228 Part 1 and 4, from 0.14 mm² ... 10 mm², also for TWIN ferrules up to 2 x 4 mm², automatic cross section adjustment, lateral insertion, equipped with fall protection

CRIMPFOX CENTRUS 6H - Crimping pliers

1213146

<https://www.phoenixcontact.com/us/products/1213146>



Crimping pliers, for uninsulated and insulated ferrules, DIN 46228 Part 1 and 4, from 0.14 mm² ... 6 mm², also for TWIN ferrules up to 2 x 4 mm², automatic cross section adjustment, lateral insertion, equipped with fall protection

PTME 6 HV BU - Test disconnect terminal block

3035695

<https://www.phoenixcontact.com/us/products/3035695>

CRIMPFOX CENTRUS 10H - Crimping pliers

1213156

<https://www.phoenixcontact.com/us/products/1213156>



Crimping pliers, for uninsulated and insulated ferrules, DIN 46228 Part 1 and 4, from 0.14 mm² ... 10 mm², also for TWIN ferrules up to 2 x 4 mm², automatic cross section adjustment, lateral insertion, equipped with fall protection

CRIMPFOX 10S - Crimping pliers

1212045

<https://www.phoenixcontact.com/us/products/1212045>



Crimping pliers, for ferrules without insulating collar according to DIN 46228 Part 1 and ferrules with insulating collar according to DIN 46228 Part 4, 0.14 mm² ... 10 mm², unlockable pressure lock, lateral entry

PTME 6 HV BU - Test disconnect terminal block

3035695

<https://www.phoenixcontact.com/us/products/3035695>

CRIMPFOX 6H - Crimping pliers

1212046

<https://www.phoenixcontact.com/us/products/1212046>



Crimping pliers, for ferrules without insulating collar according to DIN 46228 Part 1 and ferrules with insulating collar according to DIN 46228 Part 4, 0.14 mm² ... 6 mm², unlockable pressure lock, lateral entry

CRIMPFOX 2,5-M - Crimping pliers

1212719

<https://www.phoenixcontact.com/us/products/1212719>



Crimping pliers, for ferrules without insulating collar according to DIN 46228 Part 1 and ferrules with insulating collar according to DIN 46228 Part 4, 0.25 mm² ... 2.5 mm², lateral entry, trapezoidal crimp

PTME 6 HV BU - Test disconnect terminal block



3035695

<https://www.phoenixcontact.com/us/products/3035695>

CRIMPFOX 6-M - Crimping pliers

1212720

<https://www.phoenixcontact.com/us/products/1212720>



Crimping pliers, for ferrules without insulating collar according to DIN 46228 Part 1 and ferrules with insulating collar according to DIN 46228 Part 4, 0.25 mm² ... 6.0 mm², lateral entry, trapezoidal crimp

CRIMPFOX 6 - Crimping pliers

1212034

<https://www.phoenixcontact.com/us/products/1212034>



Crimping pliers, for ferrules without insulating collar according to DIN 46228 Part 1 and ferrules with insulating collar according to DIN 46228 Part 4, 0.25 mm² ... 6.0 mm², lateral entry, trapezoidal crimp

PTME 6 HV BU - Test disconnect terminal block



3035695

<https://www.phoenixcontact.com/us/products/3035695>

CRIMPFOX 6T - Crimping pliers

1212037

<https://www.phoenixcontact.com/us/products/1212037>



Crimping pliers, for ferrules without insulating collar according to DIN 46228 Part 1 and ferrules with insulating collar according to DIN 46228 Part 4, 0.25 mm² ... 6 mm², lateral entry, trapezoidal crimp

CRIMPFOX 6T-F - Crimping pliers

1212038

<https://www.phoenixcontact.com/us/products/1212038>



Crimping pliers, for ferrules without insulating collar according to DIN 46228 Part 1 and ferrules with insulating collar according to DIN 46228 Part 4, 0.25 mm² ... 6 mm², front entry, trapezoidal crimp

PTME 6 HV BU - Test disconnect terminal block



3035695

<https://www.phoenixcontact.com/us/products/3035695>

CRIMPFOX 6S-F - Crimping pliers

1212043

<https://www.phoenixcontact.com/us/products/1212043>



Crimping pliers, for ferrules without insulating collar according to DIN 46228 Part 1 and ferrules with insulating collar according to DIN 46228 Part 4, 0.5 mm² ... 6 mm², front entry, square crimp

CRIMPFOX-M - Crimping pliers

1212072

<https://www.phoenixcontact.com/us/products/1212072>



Basic pliers, for accommodating dies for a wide range of type of contacts

Phoenix Contact 2024 © - all rights reserved
<https://www.phoenixcontact.com>

Phoenix Contact USA
586 Fulling Mill Road
Middletown, PA 17057, United States
(+717) 944-1300
info@phoenixcon.com