

QP 1,5/ 1-L BU - Plug

3051027

<https://www.phoenixcontact.com/pc/products/3051027>



Please be informed that the data shown in this PDF document is generated from our online catalog. Please find the complete data in the user documentation. Our general terms of use for downloads are valid.



Plug, nom. voltage: 500 V, nominal current: 17.5 A, number of positions: 1, connection method: Quick connection, 1 level, Rated cross section: 1.5 mm², cross section: 0.25 mm²- 1.5 mm², color: blue

Product description

Connector element left, left housing without engagement pin, right opened without cover

Your advantages

- The QT-COMBI plugs for self-assembly provide solutions that users can implement themselves
- The conductor is connected using the familiar IDC connection with no stripping, therefore saving time
- Tested for railway applications
- The QP 1,5/... fast connector plug is designed for the connection of solid and stranded conductors

Commercial data

Item number	3051027
Packing unit	50 pc
Minimum order quantity	50 pc
Product key	BE3144
Catalog page	Page 289 (C-1-2019)
GTIN	4046356082877
Weight per piece (including packing)	4.066 g
Weight per piece (excluding packing)	4.066 g
Customs tariff number	85366990
Country of origin	TR

QP 1,5/ 1-L BU - Plug

3051027

<https://www.phoenixcontact.com/pc/products/3051027>



Technical data

Product properties

Product type	Terminal plug
Number of positions	1
Pitch	5.2 mm

Insulation characteristics

Overvoltage category	III
Degree of pollution	3

Electrical properties

Rated surge voltage	6 kV
---------------------	------

Connection data

Nominal cross section	1.5 mm ²
-----------------------	---------------------

1 level

Material wire insulation	PVC / PE
Connection in acc. with standard	IEC 61984
Conductor cross section rigid	0.25 mm ² ... 1.5 mm ²
Cross section AWG	24 ... 16 (converted acc. to IEC)
Conductor cross section flexible	0.25 mm ² ... 1.5 mm ²
Conductor cross section, flexible [AWG]	24 ... 16 (converted acc. to IEC)
Cross section, sensor conductors	0.25 mm ² ... 0.34 mm ²
Nominal current	17.5 A
Maximum load current	17.5 A (with 1.5 mm ² conductor cross section)
Nominal voltage	500 V
Nominal cross section	1.5 mm ²

Dimensions

Width	5.2 mm
Height	20 mm
Depth	40 mm
Length	20 mm
Pitch	5.2 mm

Material specifications

Color	blue
Flammability rating according to UL 94	V0
Insulating material group	I
Insulating material	PA
Static insulating material application in cold	-60 °C
Relative insulation material temperature index (Elec., UL 746 B)	125 °C
Fire protection for rail vehicles (DIN EN 45545-2) R22	HL 1 - HL 3

QP 1,5/ 1-L BU - Plug



3051027

<https://www.phoenixcontact.com/pc/products/3051027>

Fire protection for rail vehicles (DIN EN 45545-2) R23	HL 1 - HL 3
Fire protection for rail vehicles (DIN EN 45545-2) R24	HL 1 - HL 3
Fire protection for rail vehicles (DIN EN 45545-2) R26	HL 1 - HL 3
Calorimetric heat release NFPA 130 (ASTM E 1354)	28 MJ/kg
Surface flammability NFPA 130 (ASTM E 162)	passed
Specific optical density of smoke NFPA 130 (ASTM E 662)	passed
Smoke gas toxicity NFPA 130 (SMP 800C)	passed

Environmental and real-life conditions

Ambient conditions

Ambient temperature (operation)	-60 °C (max. operating temperature see derating curve)
Ambient temperature (storage/transport)	-25 °C ... 60 °C ()
Ambient temperature (assembly)	-5 °C ... 70 °C
Ambient temperature (actuation)	-5 °C ... 70 °C
Permissible humidity (operation)	20 % ... 90 %
Permissible humidity (storage/transport)	30 % ... 70 %

Standards and regulations

Connection in acc. with standard	IEC 61984
----------------------------------	-----------

Drawings

Diagram

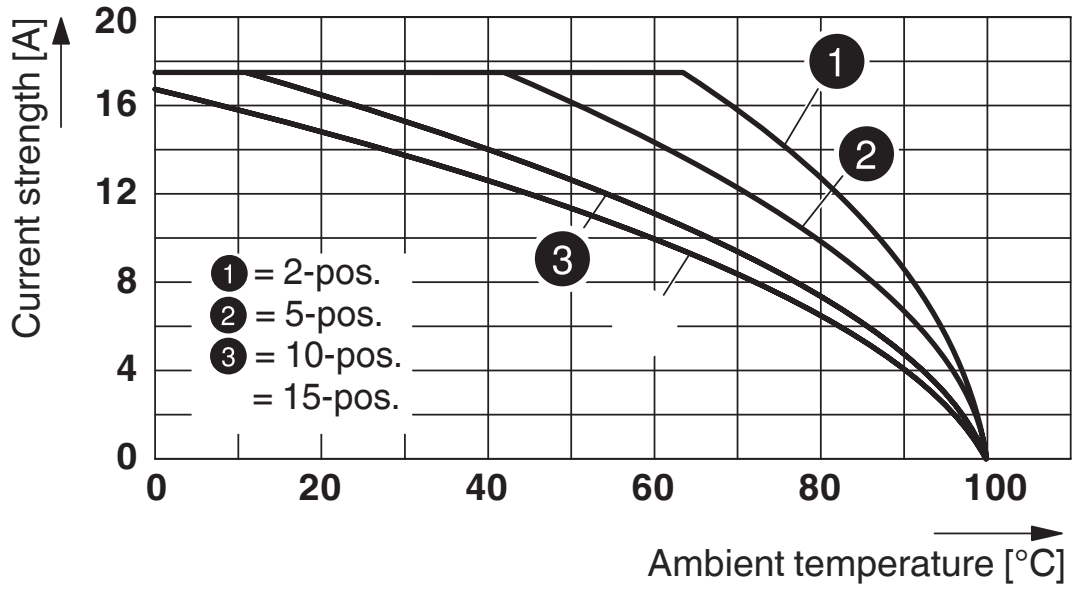

Circuit diagram



QP 1,5/ 1-L BU - Plug

3051027

<https://www.phoenixcontact.com/pc/products/3051027>

Schematic diagram

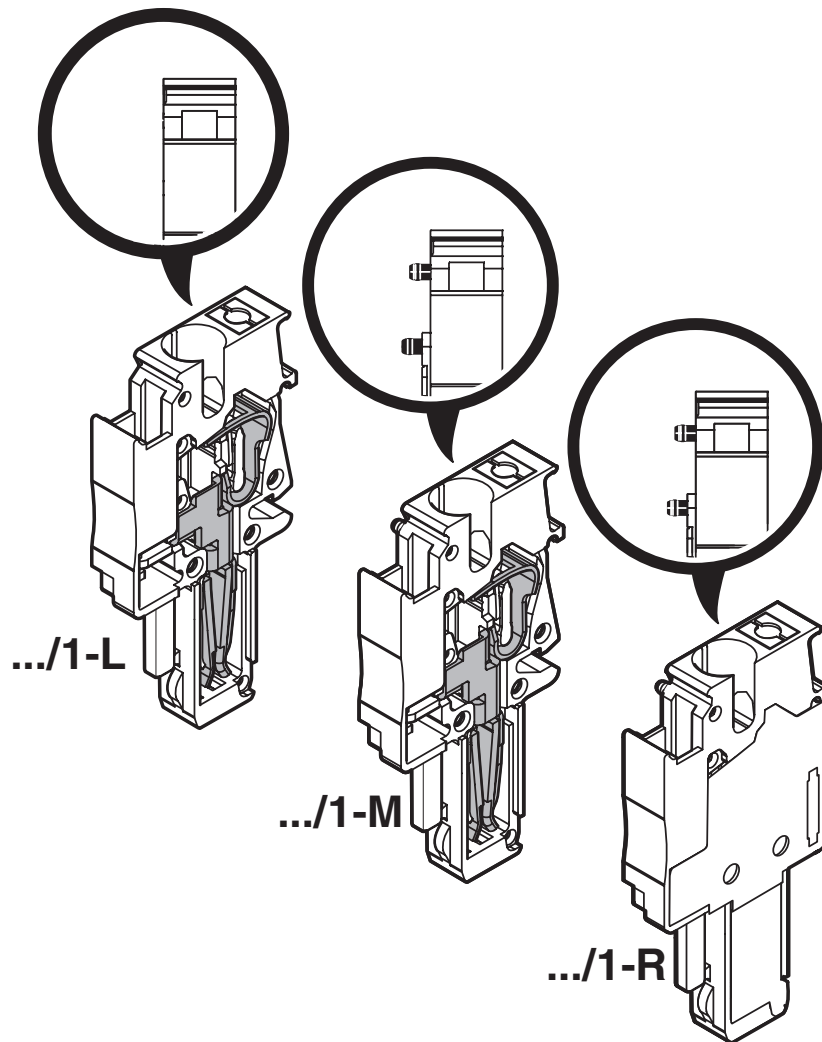

QP 1,5/ 1-L BU - Plug



3051027

<https://www.phoenixcontact.com/pc/products/3051027>

Approvals

To download certificates, visit the product detail page: <https://www.phoenixcontact.com/pc/products/3051027>

 CSA Approval ID: 2030668				
	Nominal voltage U_N	Nominal current I_N	Cross section AWG	Cross section mm^2
Use group B	300 V	10 A	24 - 16	-
Use group C	300 V	10 A	24 - 16	-
Use group D	600 V	5 A	24 - 16	-

 EAC Approval ID: RU C-DE.BL08.B.00511				
-----------------------------------------------------------------------------------------------------------------------------------	--	--	--	--

 DNV GL Approval ID: TAE00003J6				
------------------------------------------------------------------------------------------------------------------------------	--	--	--	--

 cULus Recognized Approval ID: E60425				
	Nominal voltage U_N	Nominal current I_N	Cross section AWG	Cross section mm^2
Use group B	300 V	10 A	24 - 16	-
Use group C	300 V	10 A	24 - 16	-
Use group D	600 V	5 A	24 - 16	-

QP 1,5/ 1-L BU - Plug

3051027

<https://www.phoenixcontact.com/pc/products/3051027>



Classifications

ECLASS

ECLASS-11.0	27141151
ECLASS-12.0	27141151
ECLASS-13.0	27250306

ETIM

ETIM 9.0	EC002021
----------	----------

UNSPSC

UNSPSC 21.0	39121400
-------------	----------

QP 1,5/ 1-L BU - Plug

3051027

<https://www.phoenixcontact.com/pc/products/3051027>



Environmental product compliance

China RoHS	Environmentally friendly use period: unlimited = EFUP-e
	No hazardous substances above threshold values

QP 1,5/ 1-L BU - Plug

3051027

<https://www.phoenixcontact.com/pc/products/3051027>



Accessories

RPS - Reducing plug

0201647

<https://www.phoenixcontact.com/pc/products/0201647>



Reducing plug, number of positions: 1, color: gray

QP 1,5/ 1-M - Plug

3051043

<https://www.phoenixcontact.com/pc/products/3051043>



Plug, nom. voltage: 500 V, nominal current: 17.5 A, number of positions: 1, connection method: Quick connection, 1 level, Rated cross section: 1.5 mm², cross section: 0.25 mm²- 1.5 mm², color: gray

QP 1,5/ 1-L BU - Plug

3051027

<https://www.phoenixcontact.com/pc/products/3051027>

QP 1,5/ 1-M BU - Plug

3051056

<https://www.phoenixcontact.com/pc/products/3051056>



Plug, nom. voltage: 500 V, nominal current: 17.5 A, number of positions: 1, connection method: Quick connection, 1 level, Rated cross section: 1.5 mm², cross section: 0.25 mm²- 1.5 mm², color: blue

QP 1,5/ 1-M GNYE - Plug

3051069

<https://www.phoenixcontact.com/pc/products/3051069>



Plug, nom. voltage: 500 V, nominal current: 17.5 A, number of positions: 1, connection method: Quick connection, 1 level, Rated cross section: 1.5 mm², cross section: 0.25 mm²- 1.5 mm², color: green-yellow

QP 1,5/ 1-L BU - Plug

3051027

<https://www.phoenixcontact.com/pc/products/3051027>



QP 1,5/ 1-R - Plug

3051072

<https://www.phoenixcontact.com/pc/products/3051072>



Plug, nom. voltage: 500 V, nominal current: 17.5 A, number of positions: 1, connection method: Quick connection, 1 level, Rated cross section: 1.5 mm², cross section: 0.25 mm²- 1.5 mm², color: gray

QP 1,5/ 1-R BU - Plug

3051085

<https://www.phoenixcontact.com/pc/products/3051085>



Plug, nom. voltage: 500 V, nominal current: 17.5 A, number of positions: 1, connection method: Quick connection, 1 level, Rated cross section: 1.5 mm², cross section: 0.25 mm²- 1.5 mm², color: blue

QP 1,5/ 1-L BU - Plug

3051027

<https://www.phoenixcontact.com/pc/products/3051027>



QP 1,5/ 1-R GNYE - Plug

3051098

<https://www.phoenixcontact.com/pc/products/3051098>



Plug, nom. voltage: 500 V, nominal current: 17.5 A, number of positions: 1, connection method: Quick connection, 1 level, Rated cross section: 1.5 mm², cross section: 0.25 mm²- 1.5 mm², color: green-yellow

PZ/2 - Strain relief

3040627

<https://www.phoenixcontact.com/pc/products/3040627>



Strain relief, width: 9.3 mm, height: 48.7 mm, number of positions: 2, color: black

QP 1,5/ 1-L BU - Plug

3051027

<https://www.phoenixcontact.com/pc/products/3051027>



PZ/4 - Strain relief

3040643

<https://www.phoenixcontact.com/pc/products/3040643>



Strain relief, width: 19.6 mm, height: 48.7 mm, number of positions: 4, color: black

PRZ - Latching

3040614

<https://www.phoenixcontact.com/pc/products/3040614>



Latching, number of positions: 2, length: 64 mm, color: orange

QP 1,5/ 1-L BU - Plug

3051027

<https://www.phoenixcontact.com/pc/products/3051027>



PR - Latching

3040559

<https://www.phoenixcontact.com/pc/products/3040559>



Latching, width: 4.4 mm, height: 29.8 mm, number of positions: 1, color: orange

PR/2 - Latching

3040630

<https://www.phoenixcontact.com/pc/products/3040630>



Latching, width: 10 mm, height: 29.8 mm, number of positions: 2, color: orange

QP 1,5/ 1-L BU - Plug

3051027

<https://www.phoenixcontact.com/pc/products/3051027>



PRT/2 - Latching

3040631

<https://www.phoenixcontact.com/pc/products/3040631>



Latching, can only be released using a screwdriver, width: 9 mm, height: 23.2 mm, number of positions: 2, color: orange

MPS-MT - Test plug

0201744

<https://www.phoenixcontact.com/pc/products/0201744>



Test plug, with solder connection up to 1 mm² conductor cross section, number of positions: 1, color: gray

QP 1,5/ 1-L BU - Plug

3051027

<https://www.phoenixcontact.com/pc/products/3051027>



MPS-IH WH - Insulating sleeve

0201663

<https://www.phoenixcontact.com/pc/products/0201663>

Insulating sleeve, color: white



MPS-IH RD - Insulating sleeve

0201676

<https://www.phoenixcontact.com/pc/products/0201676>

Insulating sleeve, color: red



QP 1,5/ 1-L BU - Plug

3051027

<https://www.phoenixcontact.com/pc/products/3051027>



MPS-IH BU - Insulating sleeve

0201689

<https://www.phoenixcontact.com/pc/products/0201689>

Insulating sleeve, color: blue

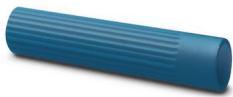

MPS-IH YE - Insulating sleeve

0201692

<https://www.phoenixcontact.com/pc/products/0201692>

Insulating sleeve, color: yellow



QP 1,5/ 1-L BU - Plug

3051027

<https://www.phoenixcontact.com/pc/products/3051027>



MPS-IH GN - Insulating sleeve

0201702

<https://www.phoenixcontact.com/pc/products/0201702>

Insulating sleeve, color: green



MPS-IH GY - Insulating sleeve

0201728

<https://www.phoenixcontact.com/pc/products/0201728>

Insulating sleeve, color: gray



QP 1,5/ 1-L BU - Plug

3051027

<https://www.phoenixcontact.com/pc/products/3051027>



MPS-IH BK - Insulating sleeve

0201731

<https://www.phoenixcontact.com/pc/products/0201731>

Insulating sleeve, color: black



PS-5 - Test plug

3030983

<https://www.phoenixcontact.com/pc/products/3030983>

Test plug, Modular test plug, number of positions: 1, color: red



QP 1,5/ 1-L BU - Plug

3051027

<https://www.phoenixcontact.com/pc/products/3051027>



DP PS-5 - Spacer plate

3036725

<https://www.phoenixcontact.com/pc/products/3036725>



Spacer plate, depth: 29 mm, width: 5.2 mm, height: 22.4 mm, number of positions: 1, color: red

PS-5/2,3MM RD - Test plug

3038723

<https://www.phoenixcontact.com/pc/products/3038723>



Test plug, number of positions: 1, color: red

QP 1,5/ 1-L BU - Plug

3051027

<https://www.phoenixcontact.com/pc/products/3051027>



ZBF 5:UNBEDRUCKT - Zack Marker strip, flat

0808642

<https://www.phoenixcontact.com/pc/products/0808642>



Zack Marker strip, flat, Strip, white, unlabeled, can be labeled with: PLOTMARK, CMS-P1-PLOTTER, mounting type: snapped, for terminal block width: 5 mm, lettering field size: 5.1 x 5.2 mm, Number of individual labels: 10

ZBF 5 CUS - Zack Marker strip, flat

0825025

<https://www.phoenixcontact.com/pc/products/0825025>



Zack Marker strip, flat, can be ordered: Strip, white, labeled according to customer specifications, mounting type: snap into flat marker groove, for terminal block width: 5 mm, lettering field size: 5.15 x 5.15 mm, Number of individual labels: 10

QP 1,5/ 1-L BU - Plug

3051027

<https://www.phoenixcontact.com/pc/products/3051027>



ZBF 5,LGS:FORTL.ZAHLEN - Zack Marker strip, flat

0808671

<https://www.phoenixcontact.com/pc/products/0808671>

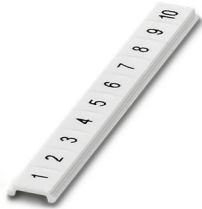

Zack Marker strip, flat, Strip, white, labeled, printed horizontally: consecutive numbers 1 ... 10, 11 ... 20, etc. up to 491 ... 500, mounting type: snapped, for terminal block width: 5 mm, lettering field size: 5.15 x 5.15 mm, Number of individual labels: 10

ZBF 5,QR:FORTL.ZAHLEN - Zack Marker strip, flat

0808697

<https://www.phoenixcontact.com/pc/products/0808697>



Zack Marker strip, flat, Strip, white, labeled, Printed vertically: consecutive numbers 1 ... 10, 11 ... 20, etc. up to 91 ... 100, mounting type: snapped, for terminal block width: 5 mm, lettering field size: 5.15 x 5.15 mm, Number of individual labels: 10

QP 1,5/ 1-L BU - Plug

3051027

<https://www.phoenixcontact.com/pc/products/3051027>



ZBF 5,LGS:GERADE ZAHLEN - Zack Marker strip, flat

0810821

<https://www.phoenixcontact.com/pc/products/0810821>



Zack Marker strip, flat, Strip, white, labeled, printed horizontally: consecutive even numbers 2 ... 20, 22 ... 40, etc. up to 82 ... 100, mounting type: snapped, for terminal block width: 5 mm, lettering field size: 5.15 x 5.15 mm, Number of individual labels: 10

ZBF 5,LGS:UNGERADE ZAHLEN - Zack Marker strip, flat

0810863

<https://www.phoenixcontact.com/pc/products/0810863>



Zack Marker strip, flat, Strip, white, labeled, printed horizontally: Odd numbers 1 - 19, 21 - 39, etc. up to 81 - 99, mounting type: snapped, for terminal block width: 5 mm, lettering field size: 5.15 x 5.15 mm, Number of individual labels: 10

QP 1,5/ 1-L BU - Plug

3051027

<https://www.phoenixcontact.com/pc/products/3051027>



UC-TMF 5 - Marker for terminal blocks

0818153

<https://www.phoenixcontact.com/pc/products/0818153>



Marker for terminal blocks, Sheet, white, unlabeled, can be labeled with: BLUEMARK ID COLOR, BLUEMARK ID, BLUEMARK CLED, PLOTMARK, CMS-P1-PLOTTER, mounting type: snapped, for terminal block width: 5.2 mm, lettering field size: 4.6 x 5.1 mm, Number of individual labels: 96

UC-TMF 5 CUS - Marker for terminal blocks

0824638

<https://www.phoenixcontact.com/pc/products/0824638>



Marker for terminal blocks, can be ordered: by sheet, white, labeled according to customer specifications, mounting type: snap into flat marker groove, for terminal block width: 5.2 mm, lettering field size: 4.6 x 5.1 mm, Number of individual labels: 96

QP 1,5/ 1-L BU - Plug

3051027

<https://www.phoenixcontact.com/pc/products/3051027>



UCT-TMF 5 - Marker for terminal blocks

0828744

<https://www.phoenixcontact.com/pc/products/0828744>



Marker for terminal blocks, Sheet, white, unlabeled, can be labeled with: TOPMARK NEO, TOPMARK LASER, BLUEMARK ID COLOR, BLUEMARK ID, BLUEMARK CLED, THERMOMARK PRIME, THERMOMARK CARD 2.0, THERMOMARK CARD, mounting type: snapped, for terminal block width: 5.2 mm, lettering field size: 4.4 x 4.7 mm, Number of individual labels: 72

UCT-TMF 5 CUS - Marker for terminal blocks

0829658

<https://www.phoenixcontact.com/pc/products/0829658>



Marker for terminal blocks, can be ordered: by sheet, white, labeled according to customer specifications, mounting type: snap into flat marker groove, for terminal block width: 5.2 mm, lettering field size: 4.4 x 4.7 mm, Number of individual labels: 72

QP 1,5/ 1-L BU - Plug

3051027

<https://www.phoenixcontact.com/pc/products/3051027>



SZF 1-0,6X3,5 - Screwdriver

1204517

<https://www.phoenixcontact.com/pc/products/1204517>



Actuation tool, for ST terminal blocks, also suitable for use as a bladed screwdriver, size: 0.6 x 3.5 x 100 mm, 2-component grip, with non-slip grip

Phoenix Contact 2024 © - all rights reserved

<https://www.phoenixcontact.com>

PHOENIX CONTACT GmbH & Co. KG

Flachsmarktstraße 8

D-32825 Blomberg

+49 (0) 5235-3 00

info@phoenixcontact.com