



Main catalog

# Motor protection and control

## Manual motor starters, contactors and overload relays

# Motor rated operational powers and currents

The currents given below concern standard three-phase four-pole cage motors (1500 r.p.m. at 50 Hz 1800 r.p.m. at 60 Hz). These values are given for guidance and may vary according to the motor manufacturer and depending on the number of poles.

IEC Motor power kW	Motor nominal current: standardized values in blue colour (according to IEC 60947-4-1 Annex G)									
	220 V A	230 V A	240 V A	380 V A	400 V A	415 V A	440 V A	500 V A	660 V A	690 V A
0.06	0.37	0.35	0.34	0.21	0.2	0.19	0.18	0.16	0.13	0.12
0.09	0.54	0.52	0.50	0.32	0.3	0.29	0.26	0.24	0.18	0.17
0.12	0.73	0.7	0.67	0.46	0.44	0.42	0.39	0.32	0.24	0.23
0.18	1	1	1	0.63	0.6	0.58	0.53	0.48	0.37	0.35
0.25	1.6	1.5	1.4	0.9	0.85	0.82	0.74	0.68	0.51	0.49
0.37	2.0	1.9	1.8	1.2	1.1	1.1	1	0.88	0.67	0.64
0.55	2.7	2.6	2.5	1.6	1.5	1.4	1.3	1.2	0.91	0.87
0.75	3.5	3.3	3.2	2.0	1.9	1.8	1.7	1.5	1.15	1.1
1.1	4.9	4.7	4.5	2.8	2.7	2.6	2.4	2.2	1.7	1.6
1.5	6.6	6.3	6	3.8	3.6	3.5	3.2	2.9	2.2	2.1
2.2	8.9	8.5	8.1	5.2	4.9	4.7	4.3	3.9	2.9	2.8
3	11.8	11.3	10.8	6.8	6.5	6.3	5.7	5.2	4	3.8
4	15.7	15	14.4	8.9	8.5	8.2	7.4	6.8	5.1	4.9
5.5	20.9	20	19.2	12.1	11.5	11.1	10.1	9.2	7	6.7
7.5	28.2	27	25.9	16.3	15.5	14.9	13.6	12.4	9.3	8.9
11	39.7	38	36.4	23.2	22	21.2	19.3	17.6	13.4	12.8
15	53.3	51	48.9	30.5	29	28	25.4	23	17.8	17
18.5	63.8	61	58.5	36.8	35	33.7	30.7	28	22	21
22	75.3	72	69	43.2	41	39.5	35.9	33	25.1	24
30	100	96	92	57.9	55	53	48.2	44	33.5	32
37	120	115	110	69	66	64	58	53	40.8	39
45	146	140	134	84	80	77	70	64	49.1	47
55	177	169	162	102	97	93	85	78	59.6	57
75	240	230	220	139	132	127	116	106	81	77
90	291	278	266	168	160	154	140	128	97	93
110	355	340	326	205	195	188	171	156	118	113
132	418	400	383	242	230	222	202	184	140	134
160	509	487	467	295	280	270	245	224	169	162
200	637	609	584	368	350	337	307	280	212	203
250	782	748	717	453	430	414	377	344	261	250
315	983	940	901	568	540	520	473	432	327	313
355	1109	1061	1017	642	610	588	535	488	370	354
400	1255	1200	1150	726	690	665	605	552	418	400
500	1545	1478	1416	895	850	819	745	680	515	493
560	1727	1652	1583	1000	950	916	832	760	576	551
630	1928	1844	1767	1116	1060	1022	929	848	643	615
710	2164	2070	1984	1253	1190	1147	1043	952	721	690
800	2446	2340	2243	1417	1346	1297	1179	1076	815	780
900	2760	2640	2530	1598	1518	1463	1330	1214	920	880
1000	3042	2910	2789	1761	1673	1613	1466	1339	1014	970

UL / CSA Motor power hp	Motor nominal current: standardized values (according to IEC 60947-4-1 Annex G and UL 508)				
	208 V A	220-240 V A	380-415 V A	440-480 V A	550-600 V A
1/2	2.4	2.2	1.3	1.1	0.9
3/4	3.5	3.2	1.8	1.6	1.3
1	4.6	4.2	2.3	2.1	1.7
1-1/2	6.6	6	3.3	3	2.4
2	7.5	6.8	4.3	3.4	2.7
3	10.6	9.6	6.1	4.8	3.9
5	16.7	15.2	9.7	7.6	6.1
7-1/2	24.2	22	14	11	9
10	30.8	28	18	14	11
15	46.2	42	27	21	17
20	59.4	54	34	27	22
25	74.8	68	44	34	27
30	88	80	51	40	32
40	114	104	66	52	41
50	143	130	83	65	52
60	169	154	103	77	62
75	211	192	128	96	77
100	273	248	165	124	99
125	343	312	208	156	125
150	396	360	240	180	144
200	528	480	320	240	192
250	-	604	403	302	242
300	-	722	482	361	289
350	-	828	560	414	336
400	-	954	636	477	382
450	-	1030	-	515	412
500	-	1180	786	590	472



# Motor protection and control

## Manual motor starters, contactors and overload relays

<a href="#">Overview</a>	1
<a href="#">Manual motor starters</a>	2
<a href="#">B mini contactors</a>	3
<a href="#">AS contactors with screw terminals</a>	4
<a href="#">AF, A and EK contactors with screw terminals</a>	5
<a href="#">AS and AF contactors with spring terminals</a>	6
<a href="#">Overload relays</a>	7
<a href="#">R contactors</a>	8
<a href="#">Motor management system</a>	9
<a href="#">S800 self resetting current limiting module</a>	10
<a href="#">General technical data</a>	11
<a href="#">Index</a>	12

# ABB sets a new standard in motor control and power switching

1

Featuring AF technology as standard, the latest range of ABB's contactors establishes a new industry benchmark. The electronically controlled coil offers multiple benefits over conventional alternatives, and together with ABB's wide product offering – an optimal configuration, every time.



## Access Global Support

The contactor and motor protection range from ABB is compatible with all major national and international standards and is available worldwide via a global distribution network. One contactor coil now handles 100 V – 250 V, AC/DC for use in Europe or Asia as well as North America.



## Optimize logistics

With its contactor and motor protection range, ABB has managed to reduce the number of contactor coils to just four. The total number of product variants has been reduced by up to 90%. This simplifies the customers' logistics and cuts administration costs.



## Simplify design

By reducing contactor coil energy consumption by up to 80%, panels can be built smaller and transformers more compact. All the features of the AF technology, along with access to drawings and coordination tables online, simplifies your design and assembly process.



## Secure uptime

Time to prevent stoppages caused by voltage fluctuations. The AF contactor ensures distinct operation in unstable networks and signifies a major advance in motor control and power switching. Voltage sags, dips and surges pose no threat. The AF contactor secures your uptime.



## MacGregor. Keeping turnarounds brief.

Until the AF range was installed, voltage sags were affecting MacGregor's deck cranes. Conventional contactors welded shut, leading to several stoppages a week. No longer. Known for superior quality and an ability to operate in the most hostile environments, MacGregor deck cranes enjoy a global reputation for reliability. A small but vital component, the AF contactor helps maintain this reputation.

To keep things moving, you need Control. Connect to Control.

Explore all our case studies at [www.abb.com/connecttocontrol](http://www.abb.com/connecttocontrol)

**SSAB**  
Making certainty  
standard

**Gamesa**  
Taming the wind

**LKAB**  
Providing fresh air



# Contactors and motor protection

## For a wide variety of segments

1

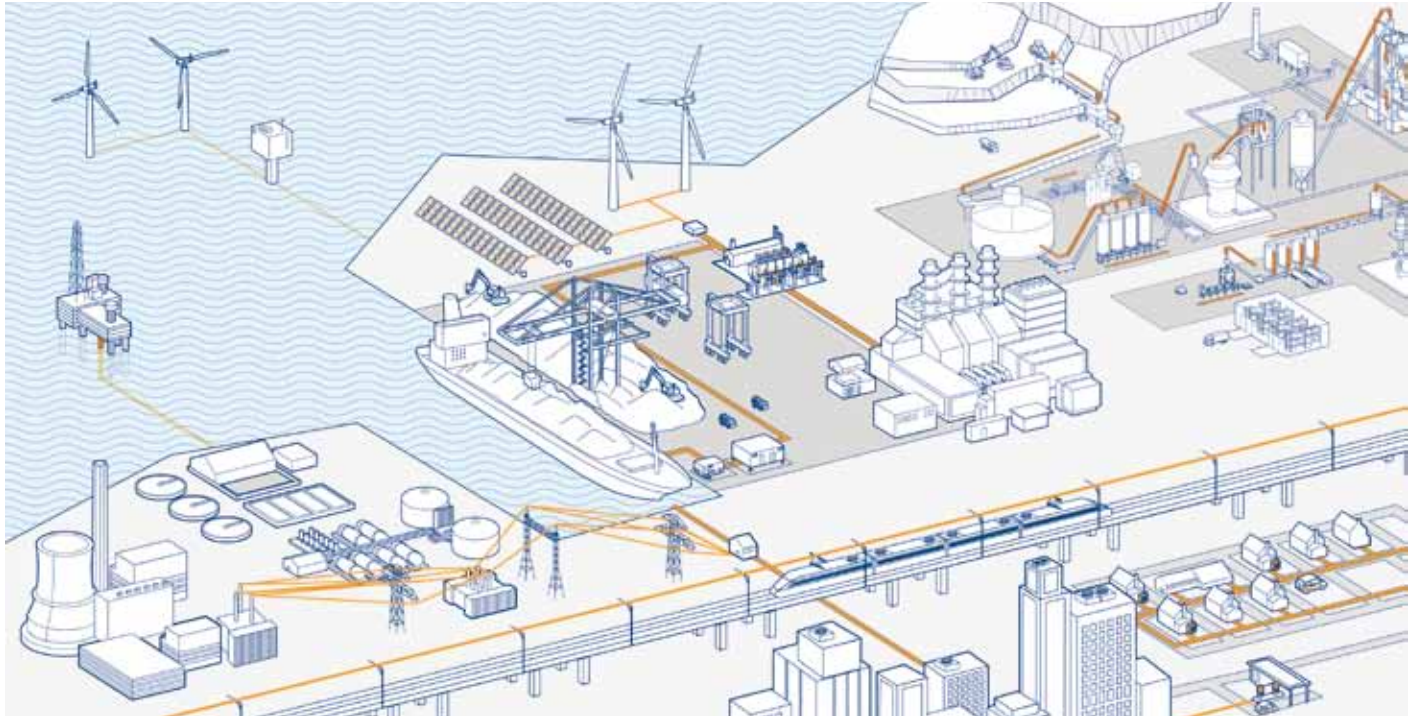

HVAC, General Machinery, Rail, Critical Power, Wind, Solar, Marine and Water & Wastewater

### Contactors for any use

The AF contactor range covers small motor starting solutions from 4 kW / 5 hp up to big power switching solutions with our unique AF2650, the biggest single case block contactor in the world.

The contactor and motor protection range is part of one of the widest product offerings on the market meaning that ABB not only can provide the contactor but the full solution.

In addition to the standard product range ABB also offer products for special needs such as Bar contactors, GAF and contactors for capacitor switching.

### Cooperating with customers

ABB cooperates closely with its customers to ensure that products meet requirements from their specific segments and applications. With over 100 years' experience in motor control and power switching ABB knows how to create efficient solutions for its customers.

# AF technology

## Benefits



### Reliable in all networks

The electronic system within the AF contactor rectifies the AC or DC control circuit voltage to a DC control voltage that is applied on the coil. The contactor is safely operated in an always optimized condition making it virtually noise free.

### Four coils for the entire voltage range

The AF contactor features both AC and DC support. With the complete AF contactor range, functionality is improved. Still, the total number of product variants compared to a conventional range is reduced by 90%. Only four coils are required to cover 24 V AC, 20 V DC - 500 V AC/DC.

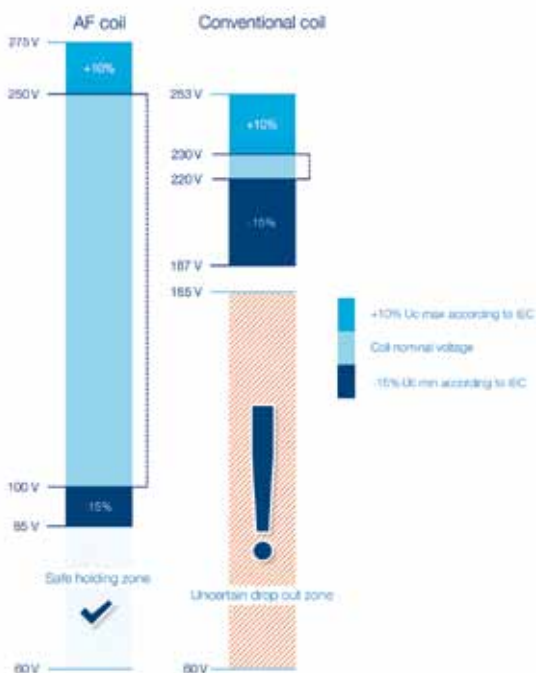

### Wide control voltage range

With conventional contactor technology, different contactors were needed for different network voltages. Thanks to the wide operating range of the AF contactor it can operate just as well in Europe as in Asia or North America. The core coil of the AF contactor range covers 100-250 V AC/DC 50/60 Hz.

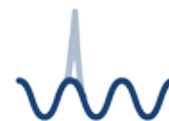

### Built-in surge suppression

With conventional contactor technology it is recommended to use an external surge suppressor, an accessory that could cost as much as half the contactor itself. With the AF technology the surges are handled by the contactor itself and the surge never reaches the control circuit. Neither the surge suppressor nor the actual surge has to be considered anymore. One less product and one less complication to worry about.

# Contactors and motor protection

## Advanced but simple

1

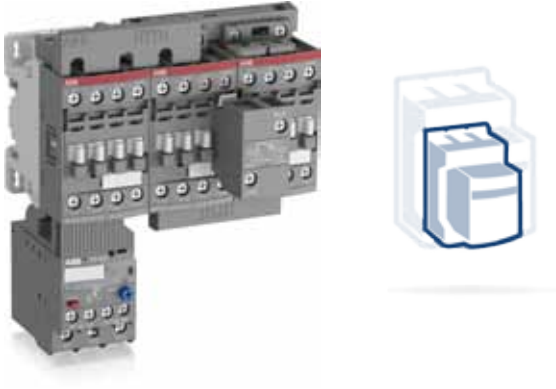

### The AF contactor is compact

The AF contactor is compact in size and has had its width reduced by up to 30% thanks to an 80% reduction of the coil's energy consumption.



### The AF contactor is flexible

AF09...AF370 is perfect for motor starting applications and for solutions where space is limited. Interlocked reversing pairs require no spacing between contactors meaning you can fit more functionality into cabinets or other small enclosures.



### Coil terminal access in the front

The AF contactor has its coil terminals accessible from the front. The cables or bars do not have to be disconnected in order to perform voltage measurement or servicing work.

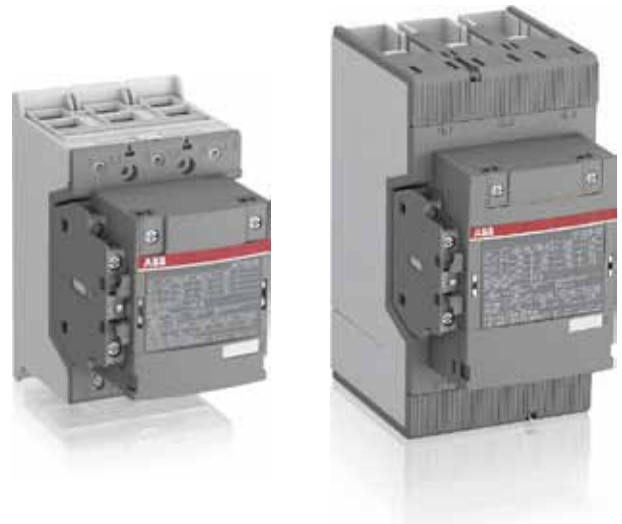

### More functionality without adding width

The AF116 ... AF2650 can take up to 2 side mounted auxiliary contact blocks without adding to its width and are delivered with 1 N.O. + 1 N.C. as standard.

# Contactors and motor protection

## Mechanical features

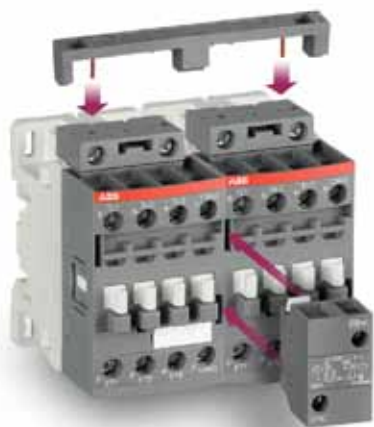

### Easy-to-use accessories

Contactors up to 96 A offer free choice of coil terminal access and can take side and front mounted auxiliary contact blocks. All the accessories: Coil connection terminals, mechanical and electrical interlocks and electronic timers are easily connected through the snap-to-connect function.



Front-mounted

Top-mounted

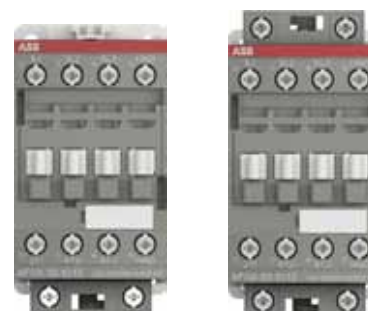

Bottom-mounted

Additional LDC4  
coil terminal block



### Safe control circuit with:

- Mirror contact according to IEC 60947-4-1
- Mechanically linked contacts according to IEC 60947-5-1
- Sealable and transparent protective covers on AF09...AF96 and overload relays TF/EF





# 3-pole contactors

# Mini contactors

# Contactors for motor control and

1



IEC (1)	AC-3 Rated operational power	$\theta \leq 60^\circ\text{C}$ (2), 400 V	kW	4	5.5
UL/CSA	3-phase motor rating	480 V	hp	3	5
AC / DC Control supply		Type	—	—	
AC Control supply		Type	B6	B7	
DC Control supply		Type	BC6	BC7	
IEC	AC-3 Rated operational current	$\theta \leq 60^\circ\text{C}$ (2), 400 V	A	9	12
	AC-1 Rated operational current	$\theta \leq 40^\circ\text{C}$ , 690 V	A	16 (400 V)	20 (400 V)
UL/CSA	General use rating	600 V	A	12 (300 V)	16
NEMA	NEMA Size			—	—

(1) 1000 V IEC ratings available for AF146 ... AF2650 contactors.  
 (2)  $\theta \leq 55^\circ\text{C}$  for mini contactors and AF400 ... AF2650 contactors.

## Main accessories

Auxiliary contact blocks	Front mounting	CAF6
	Side mounting	CA6
Timers	Electronic	
	Mechanical	
Interlocking units (4)	Mechanical / Electrical	
	For reversing contactors	BSM6-30
Surge suppressors	Varistor (AC/DC)	RV-BC6
	RC type (AC)	
	Transil diode (DC)	RD7

(4) See available reversing contactors VB6, VB7 and VAS09 ... VAS16.

## Overload relays

Thermal relays		Class 10 (Class 10A for TF140, TA200DU)	T16 (0.10...16 A)
Electronic relays		Class 10E, 20E, 30E	E16DU (0.10...18.9 A)

## Manual motor starters

	Thermal / magnetic protection Class 10	MS116 (0.10...32 A) lcs up to 50 kA for class 10A
		MS132 (0.10...32 A) lcs up to 100 kA
	Magnetic only types	MO132 (0.16...32 A)

4	5.5	7.5	4	5.5	7.5	11	15	18.5
5	7.5	10	5	7.5	10	15	20	20
—	—	—	AF09	AF12	AF16	AF26	AF30	AF38
AS09	AS12	AS16	AF09	AF12	AF16	AF26	AF30	AF38
ASL09	ASL12	ASL16	AF09	AF12	AF16	AF26	AF30	AF38
9	12	15.5	9	12	18	26	32	38
22	24	24	25	28	30	45	50	50
20	20	20	25	28	30	45	50	50
00	00	0	00	0	—	1	—	—

CA3-10 (1 x N.O.)	CA4-10 (1 x N.O.)	
CA3-01 (1 x N.C.)	CA4-01 (1 x N.C.)	
	CAL4-11 (1 x N.O. + 1 x N.C.)	
TEF3-ON	TEF4-ON	
TEF3-OFF	TEF4-OFF	
VM3	VM4	
	VEM4	
BER16C-3	BER16-4	BER38-4
RV5 (24...440 V)	Built-in surge protection	
RC5-1 (24...440 V)		
RT5 (12...264 V)		

T16 (0.10...16 A)	TF42 (0.10...38 A)		
	EF19 (0.10...19 A)	EF19 (0.10...19 A)	EF45 (9...45 A)

MS116 (0.10...32 A) lcs up to 50 kA for class 10 A	MS450 (28...50 A) lcs up to 50 kA
MS132 (0.10...32 A) lcs up to 100 kA	MS497 (22...100 A) lcs up to 100 kA
MO132 (0.16...32 A) lcs up to 100 kA	

Accessories	For contactor mounting	BEA7/132	BEA16-3	BEA16-4	BEA38-4
-------------	------------------------	----------	---------	---------	---------

## power switching



1

	18.5	22	30	37	45	55	75	75	90	110	132	160	200	200	250	315	400	—	475	560	—	—
	30	40	50	60	60	75	100	100	125	150	200	250	300	350	400	500	600	—	800	900	—	—
	AF40 AF52 AF65			AF80 AF96		AF116 AF140 AF146			AF190 AF205		AF265 AF305 AF370			AF400 AF460		AF580 AF750 AF1250			AF1350 AF1650 AF2050 AF2650			
	AF40 AF52 AF65			AF80 AF96		AF116 AF140 AF146			AF190 AF205		AF265 AF305 AF370			AF400 AF460		AF580 AF750 AF1250			AF1350 AF1650 AF2050 AF2650			
	AF40 AF52 AF65			AF80 AF96		AF116 AF140 AF146			AF190 AF205		AF265 AF305 AF370			AF400 AF460		AF580 AF750 AF1250			AF1350 AF1650 AF2050 AF2650			
	40	53	65	80	96	116	140	146	190	205	265	305	370	400	460	580	750	—	860	1050	—	—
	70	100	105	125	130	160	200	225	275	350	400	500	600	600	700	800	1050	1260	1350	1650	2050	2650
	60	80	90	105	115	160	200	200	250	300	350	400	520	550	650	750	900	1210	1350	1650	2100	2700
	2	—	—	3	—	—	4	—	—	—	5	—	—	—	6	—	7	—	—	8	—	—

		CAL19			CAL18		
VM96-4	VM19 (for same size contactors)			VM750H VM750V			VM1650H
BER65-4	BER96-4	BER140-4	BER205-4	BER370-4	BEM460-30	BEM750-30	

TF65 (22...67 A)	TF96 (40...96 A)	TF140DU (66...142 A) $\theta \leq 55^\circ\text{C}$	TA200DU (66...200 A) $\theta \leq 55^\circ\text{C}$				
EF65 (25...70 A)	EF96 (36...100 A)	EF146 (54...150 A)	EF205 (63...210 A)	EF370 (115...380 A)	E500DU (150...500 A)	E800DU (250...800 A)	E1250DU (375...1250 A)

### Short-circuit protection devices

Tmax Circuit breaker and accessories

MS495 (45...100 A) lcs up to 50 kA	
MO496 (16...100 A) lcs up to 100 kA	
MO450 (40...50 A) lcs up to 50 kA	MO495 (63...100 A) lcs up to 50 kA

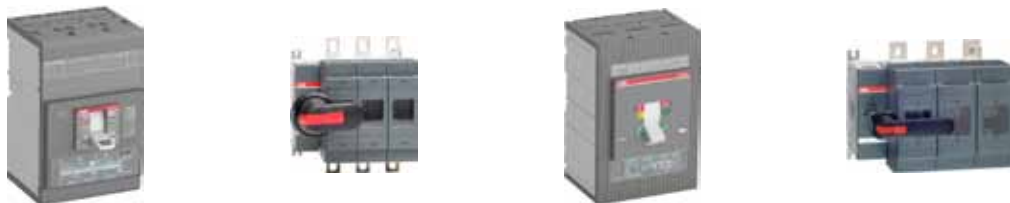



18BC101753S0201

## 4-pole contactors

1

## Mini contactors







<b>IEC</b>	<b>AC-1 Rated operational current</b>	$\theta \leq 40\text{ }^{\circ}\text{C}$ , 690 V	<b>A</b>	<b>16</b>	<b>20</b>
<b>UL/CSA</b>	<b>General use rating</b>	600 V	<b>A</b>	<b>12</b> (300 V)	<b>16</b>
<b>AC Control supply</b>		Type	<b>B6</b>	<b>B7</b>	
<b>DC Control supply</b>		Type	<b>BC6</b>	<b>BC7</b>	
<b>AC / DC Control supply</b>		Type	—	—	

## Contactor relays

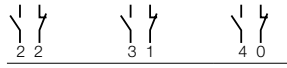
## Mini contactor relays



<b>IEC</b>	<b>AC-15 Rated operational current</b>	400 V	<b>A</b>	<b>3</b>	
<b>UL/CSA</b>	<b>Pilot duty</b>			<b>A 600</b>	
					
<b>AC Control supply</b>		Type	<b>K6-22Z</b>	<b>K6-31Z</b>	<b>K6-40E</b>
<b>DC Control supply</b>		Type	<b>KC6-22Z</b>	<b>KC6-31Z</b>	<b>KC6-40E</b>
<b>AC / DC Control supply</b>		Type	—	—	—

## R contactors

## DC Circuit switching



DC-1 Rated current up to 5000 A  
 DC-3/DC-5 Rated current up to 2000 A  
 1500 V with poles in series

**IOR.. 63-...-CC to IOR.. 5100-...-CC**

## Specific contactors

## DC Circuit switching



100 A, 440 V, DC-1  
**GA75, GAE75** types



275 to 2050 A, 1000 V, DC-1  
**GAF185 to GAF2050** types

## Contactors



25	30	45	55	70	100	125	200	250	300	350	550	800	1000
25	30	45	55	80	80	105	170	200	250	300	420	540	—
AF09	AF16	AF26	AF38	A45	A50	A75	EK110	EK150	EK175	EK210	EK370	EK550	EK1000
AF09	AF16	AF26	AF38	AE45	AE50	AE75	EK110	EK150	EK175	EK210	EK370	EK550	EK1000
AF09	AF16	AF26	AF38	AF45	AF50	AF75	—	—	—	—	—	—	—

## Contactor relays



3 A 600, Q 300			3 A 600, Q 600		
NS22E	NS31E	NS40E	NF22E	NF31E	NF40E
NSL22E	NSL31E	NSL40E	NF22E	NF31E	NF40E
—	—	—	NF22E	NF31E	NF40E

## AC Circuit switching

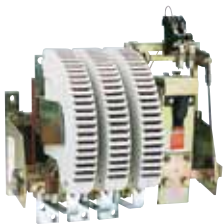

AC-1 Rated current up to 5000 A  
AC-3 Rated power up to 1500 kW  
(1520 A - 440 V)

IOR.. 63...-MT to IOR.. 5100...-MT

## Special versions

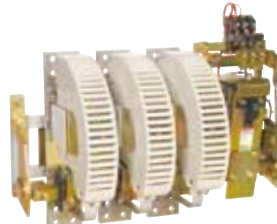

AC/DC Coupling: LOR.. contactors  
Slip ring motor control: FOR .. contactors  
Field discharge: AM(F)-CC-JORE contactors  
AC/DC Switching (N.C./N.O. main poles):  
NOR & JOR contactors  
Latching contactors for energy saving  
and safety requirements: AMA or AME contactors

## Capacitor switching



12.5 to 80 kvar  
UA16..RA to UA110..RA types  
UA16 to UA110 types



# Manual motor starters

## Overview

Manual motor starters	2/2
-----------------------	-----

### 0.10 to 32 A – with thermal and electromagnetic protection

#### I<sub>cs</sub> up to 50 kA

MS116 manual motor starters	2/4
Technical data	2/5
Main accessories	2/8

#### I<sub>cs</sub> up to 100 kA

MS132 manual motor starters	2/15
Technical data	2/16
Main accessories	2/19

### 0.10 to 32 A – with electromagnetic protection

MO132 manual motor starters	2/26
Technical data	2/27
Main accessories	2/31

### 22 to 100 A – with thermal and electromagnetic protection

MS450, MS495, MS497 manual motor starters	2/38
Technical data	2/39
Main accessories	2/42

### 16 to 100 A – with electromagnetic protection

MO450, MO495, MO496 manual motor starters	2/47
Technical data	2/48
Main accessories	2/51

# Manual motor starters



20DC241010F0011



1S5C101222F0010

2

<b>Thermal- and electromagnetic release</b>	Type	<b>MS116</b>	<b>MS132</b>	
<b>Magnetic release only</b>	Type	-		<b>MO132</b>
<b>Phase loss sensitivity</b>		Yes	Yes	No
<b>Switch position</b>		ON/OFF	ON/OFF/TRIP	
<b>Magnetic trip indication</b>		-	Yes	
<b>Lockable handle without accessories</b>		-	Yes	
<b>Disconnecting feature</b>		Yes	Yes	
<b>Width</b>		45 mm	45 mm	
<b>Setting range for thermal release</b>		0.1 ... 32 A	0.1 ... 32 A	
<b>Rated operational voltage <math>U_e</math></b>		690 V AC	690 V AC / 250 V DC	
<b>Rated frequency</b>		50/60 Hz	DC, 50/60 Hz	
<b>Trip class</b>		10A	10	
<b>Short-circuit breaking capacity <math>I_{cs}</math></b>	<b>400 V AC</b>	Up to 50 kA	Up to 100 kA	
<b>Ambient air temperature open compensated</b>		-25 ... +55 °C	-25 ... +60 °C	

## Main accessories

<b>Auxiliary contacts</b>			
Front mounting		HKF1	
Side mounting		HK1	
<b>Signalling contacts</b>			
Tripped alarm		SK1	
Short-circuit alarm		-	CK1
<b>Auxiliary trip units</b>			
Shunt trip		AA1	
Undervoltage release		UA1	
<b>Busbar systems</b>			
3-phase busbar		PS1	
Feeder terminals		S1	





2CDC24104F0009



1SBC101184F0014



2CDC241020F0011

MS450		MS495		MS497	
MO450		MO495		MO496	
Yes	No	Yes	No	Yes	No
ON/OFF/TRIP		ON/OFF/TRIP		ON/OFF/TRIP	
-		-		-	
Yes		Yes		Yes	
Yes		Yes		Yes	
55 mm		70 mm		70 mm	
28 ... 50 A		45 ... 100 A		22 ... 100 A	
690 V AC / 440 V DC		690 V AC / 440 V DC		690 V AC / 440 V DC	
DC, 50/60 Hz		DC, 50/60 Hz		DC, 50/60 Hz	
10		10		10	
Up to 50 kA		Up to 50 kA		Up to 100 kA	
-20 ... +60 °C		-20 ... +60 °C		-20 ... +60 °C	

HK4
HKS4
SK4
SK4
AA4
UA4
PS4
S4

# MS116 manual motor starters

## 0.10 to 32 A – with thermal and electromagnetic protection

2



2CDC241010F0011

MS116-16



2CDC241001F0011

MS116-25



2CDC241013F0011

MS116-0.16-HKF1-11



2CDC241012F0011

MS116-32-HKF1-11

### Description

Manual motor starters (MMS) are protection devices for the main circuit. They combine motor control and protection in a single device. MMS are used mainly to switch motors manually ON/OFF and protect them and the installation fuse less against short-circuit, overload and phase failures. Fuse less protection with a manual motor starter saves costs, space and ensures a quick reaction under short-circuit condition, by switching off the motor within milliseconds.

MS116 is a compact and economic range for motor protection up to 15.5 kW (400 V) / 32 A in width of 45 mm. Further features are the build-in disconnect function, temperature compensation, trip-free mechanism and a rotary handle with a clear switch position indication. The manual motor starter is suitable for three- and single-phase applications. Auxiliary contacts, signalling contacts, undervoltage releases, shunt trips, three-phase bus bars, power in-feed blocks and locking devices for protection against unauthorized changes are available as accessory.

### Ordering details

Rated operational power 400 V AC-3	Rated operational current	Short-circuit breaking capacity $I_{cs}$ at 400 V AC	Rated instantaneous current setting $I_i$	Type	Order code	Weight (1 pce)
kW	A	kA	A			kg
0.03	0.10 ... 0.16	50	1.56	MS116-0.16	1SAM250000R1001	0.225
0.06	0.16 ... 0.25	50	2.44	MS116-0.25	1SAM250000R1002	0.225
0.09	0.25 ... 0.40	50	3.90	MS116-0.4	1SAM250000R1003	0.225
0.12	0.40 ... 0.63	50	6.14	MS116-0.63	1SAM250000R1004	0.225
0.25	0.63 ... 1.00	50	11.50	MS116-1.0	1SAM250000R1005	0.225
0.55	1.00 ... 1.60	50	18.40	MS116-1.6	1SAM250000R1006	0.265
0.75	1.60 ... 2.50	50	28.75	MS116-2.5	1SAM250000R1007	0.265
1.5	2.50 ... 4.00	50	50.00	MS116-4.0	1SAM250000R1008	0.265
2.2	4.00 ... 6.30	50	78.75	MS116-6.3	1SAM250000R1009	0.265
4.0	6.30 ... 10.0	50	150	MS116-10	1SAM250000R1010	0.265
5.5	8.00 ... 12.0	25	180	MS116-12	1SAM250000R1012	0.265
7.5	10.0 ... 16.0	16	240	MS116-16	1SAM250000R1011	0.265
9.0	16.0 ... 20.0	10	300	MS116-20	1SAM250000R1013	0.310
12.5	20.0 ... 25.0	10	375	MS116-25	1SAM250000R1014	0.310
15.5	25.0 ... 32.0	10	480	MS116-32	1SAM250000R1015	0.310
0.03	0.10 ... 0.16	50	1.56	MS116-0.16-HKF1-11	1SAM250005R1001	0.240
0.06	0.16 ... 0.25	50	2.44	MS116-0.25-HKF1-11	1SAM250005R1002	0.240
0.09	0.25 ... 0.40	50	3.90	MS116-0.4-HKF1-11	1SAM250005R1003	0.240
0.12	0.40 ... 0.63	50	6.14	MS116-0.63-HKF1-11	1SAM250005R1004	0.240
0.25	0.63 ... 1.00	50	11.50	MS116-1.0-HKF1-11	1SAM250005R1005	0.240
0.55	1.00 ... 1.60	50	18.40	MS116-1.6-HKF1-11	1SAM250005R1006	0.280
0.75	1.60 ... 2.50	50	28.75	MS116-2.5-HKF1-11	1SAM250005R1007	0.280
1.5	2.50 ... 4.00	50	50.00	MS116-4.0-HKF1-11	1SAM250005R1008	0.280
2.2	4.00 ... 6.30	50	78.75	MS116-6.3-HKF1-11	1SAM250005R1009	0.280
4.0	6.30 ... 10.0	50	150	MS116-10.0-HKF1-11	1SAM250005R1010	0.280
5.5	8.00 ... 12.0	25	180	MS116-12.0-HKF1-11	1SAM250005R1012	0.280
7.5	10.0 ... 16.0	16	240	MS116-16.0-HKF1-11	1SAM250005R1011	0.280
9.0	16.0 ... 20.0	10	300	MS116-20-HKF1-11	1SAM250005R1013	0.326
12.5	20.0 ... 25.0	10	375	MS116-25-HKF1-11	1SAM250005R1014	0.326
15.5	25.0 ... 32.0	10	480	MS116-32-HKF1-11	1SAM250005R1015	0.326

### Main dimensions mm, inches

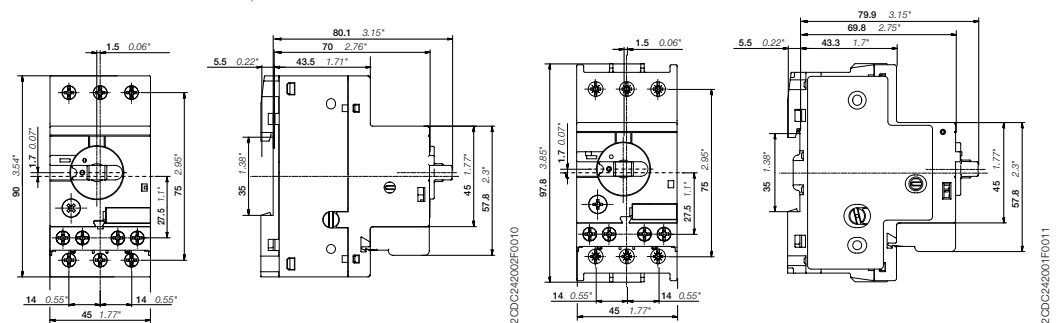

MS116 ≤ 16 A & MS116-HKF1-11 ≤ 16 A

MS116 ≥ 20 A & MS116-HKF1-11 ≥ 20 A

# MS116 manual motor starters

## Technical data

### Main circuit – Utilization characteristics according to IEC/EN

Type	MS116
Standards	IEC/EN 60947-2, IEC/EN 60947-4-1, IEC/EN 60947-1
Rated operational voltage $U_e$	690 V AC
Rated frequency	50/60 Hz
Trip class	10A
Number of poles	3
Duty time	100 %
Rated impulse withstand voltage $U_{imp}$	6 kV
Mechanical durability	100000 operations
Electrical durability, up to 16 A	100000 operations
Electrical durability, 20...32 A	50000 operations
Rated insulation voltage $U_i$	690 V AC
Rated operational current $I_e$	See ordering details
Rated instantaneous short-circuit current setting $I_{cs}$	See ordering details
Rated service short-circuit breaking capacity $I_{cs}$	See table "Short-circuit breaking capacity and back-up fuses"
Rated ultimate short-circuit breaking capacity $I_{cu}$	See table "Short-circuit breaking capacity and back-up fuses"

### Short-circuit breaking capacity and back-up fuses

$I_{cs}$  Rated service short-circuit breaking capacity

$I_{cu}$  Rated ultimate short-circuit breaking capacity

$I_{cc}$  Prospective short-circuit current at installation location

Note: Maximum rated current of the back-up fuses if  $I_{cc} > I_{cs}$

Type	230 V AC			400 V AC			440 V AC			500 V AC			690 V AC		
	$I_{cs}$ kA	$I_{cu}$ kA	gG, aM A	$I_{cs}$ kA	$I_{cu}$ kA	gG, aM A	$I_{cs}$ kA	$I_{cu}$ kA	gG, aM A	$I_{cs}$ kA	$I_{cu}$ kA	gG, aM A	$I_{cs}$ kA	$I_{cu}$ kA	gG, aM A
MS116-0.16															
MS116-0.25															
MS116-0.4															
MS116-0.63															
MS116-1.0	No back-up fuse required up to $I_{cc} = 50$ kA														
MS116-1.6	No back-up fuse required up to $I_{cc} = 50$ kA														
MS116-2.5							10	10	25	10	10	25	5	5	25
MS116-4.0							6	6	25	6	6	25	2	2	25
MS116-6.3							6	6	63	6	6	63	2	2	40
MS116-10							6	6	63	6	6	63	2	2	50
MS116-12	25	25	80	25	25	80	6	6	63	6	6	63	2	2	50
MS116-16	16	16	80	16	16	80	6	6	63	4	4	63	2	2	63
MS116-20	10	15	-	10	15	-	3	6	-	3	4	-	2	2	-
MS116-25	10	15	-	10	15	-	3	6	-	3	4	-	2	2	-
MS116-32	10	10	-	10	10	-	3	6	-	3	4	-	2	2	-

MS116-10: No need for back-up fuse in networks with a prospective current of up to 50 kA at 400 V.

MS116-16: No need for back-up fuse in networks with a prospective current of up to 16 kA at 400 V.

With an appropriate 80 A type gG fuse the device can be used in a network with a prospective current of up to 100 kA.

MS116-32: No need for back-up fuse in networks with a prospective current of up to 10 kA at 400 V.

# MS116 manual motor starters

## Technical data

### Main circuit – Utilization characteristics according to UL/CSA

Type	MS116	
Standards	UL 508, CSA 22.2 No. 14	
Maximum operational voltage	600 V AC	
Manual motor controller ratings	See table "UL 508 – Manual motor controller"	
Trip rating	125 % FLA	
Motor ratings	Horse power	See table "Motor rating, three phase"
	Full load amps (FLA)	See table "Motor rating, three phase"
	Locked rotor amps (LRA)	See table "Motor rating, three phase"

### Motor rating, three phase

hp Horse power

FLA Full load amps

LRA Locked rotor amps

Type	110-120 V AC			220-240 V AC			440-480 V AC			500-600 V AC		
	hp	FLA	LRA	hp	FLA	LRA	hp	FLA	LRA	hp	FLA	LRA
MS116-0.16	-	0.16	0.96	-	0.16	0.96	-	0.16	0.96	-	0.16	0.96
MS116-0.25	-	0.25	1.5	-	0.25	1.5	-	0.25	1.5	-	0.25	1.5
MS116-0.4	-	0.4	2.4	-	0.4	2.4	-	0.4	2.4	-	0.4	2.4
MS116-0.63	-	0.63	3.78	-	0.63	3.78	-	0.63	3.78	-	0.63	3.78
MS116-1.0	-	1.0	6.0	-	1.0	6.0	-	1.0	6.0	1/2	0.9	8
MS116-1.6	-	1.6	9.6	-	1.6	9.6	3/4	1.6	12.5	3/4	1.3	10
MS116-2.5	-	2.5	15.0	1/2	2.2	20	1	2.1	15	1-1/2	2.4	16
MS116-4.0	-	4.0	16.0	1	4.2	30	2	3.4	25	3	3.9	25.6
MS116-6.3	1/2	4.4	40	1-1/2	6.4	40	3	4.8	32	5	6.1	36.8
MS116-10	1	8.4	60	3	9.6	64	5	7.6	46	7-1/2	9	50.8
MS116-12	1-1/2	12	80	3	9.6	64	7-1/2	11	63.5	10	11	64.8
MS116-16	2	13.6	100	5	15.2	92	10	14	81	10	11	64.8
MS116-20	3	19.2	128	5	15.2	92	10	14	81	15	17	93
MS116-25	3	19.2	128	7-1/2	22	127	15	21	116	20	22	116
MS116-32	5	30.4	184	10	28	162	20	27	145	25	27	146

### UL 508 – Manual motor controller

Type	Maximum fuse type K5 o. RK5 per UL/NEC 480 V / 600 V A	Maximum short-circuit current for motor disconnect <sup>1)</sup>			
		480 V		600 V	
		kA	kA	kA	kA
MS116-0.16	100	30	5	30	5
MS116-0.25	100	30	5	30	5
MS116-0.4	100	30	5	30	5
MS116-0.63	100	30	5	30	5
MS116-1.0	100	30	5	30	5
MS116-1.6	100	30	5	30	5
MS116-2.5	100	30	5	30	5
MS116-4.0	100	18	5	18	5
MS116-6.3	100	18	5	18	5
MS116-10	100	18	5	18	5
MS116-12	100	18	5	18	5
MS116-16	100	18	5	18	5
MS116-20	100	18	5	18	5
MS116-25	100	18	5	18	5
MS116-32	100	18	5	18	5

<sup>1)</sup> Suitable as motor disconnect only when provided with padlock SA1 or SA3...



# MS116 manual motor starters

## Technical data

### General technical data

Type	MS116	
Pollution degree	3	
Phase loss sensitivity	Yes	
Disconnect function acc. to IEC/EN 60947-2	Yes	
Ambient air temperature		
Operation	Open - compensated	-25 ... +55 °C
Open	Open	-25 ... +70 °C
Enclosed (IB132)	Enclosed (IB132)	0 ... +40 °C
Storage		-50 ... +80 °C
Ambient air temperature compensation	Acc. to IEC/EN60947-4-1	
Maximum operating altitude permissible	2000 m	
Resistance to shock acc. to IEC 60068-2-27	25 g / 11 ms	
Resistance to vibrations acc. to IEC 60068-2-6	5 g / 3 ... 150 Hz	
Mounting position	Position 1-6 (optional for single mounting)	
Mounting	DIN-rail (EN 60715)	
Group mounting	On request	
Minimum distance to other units same type	Horizontal	0 mm
	Vertical	150 mm
Minimum distance to electrical conductive board	Horizontal, up to 400 V	0 mm
	Horizontal, up to 690 V	> 1.5 mm
	Vertical	75 mm
Degree of protection	Housing	IP20
	Main circuit terminals	IP20

### Connecting characteristics

Main circuit		MS116 ≤ 16 A	MS116 ≥ 20 A
Type			
Connecting capacity			
 Solid	1 or 2 x	1 ... 4 mm <sup>2</sup>	2.5 ... 6 mm <sup>2</sup>
 Flexible	1 or 2 x	0.75 ... 2.5 mm <sup>2</sup>	1 ... 6 mm <sup>2</sup>
	Stranded acc. to UL/CSA	1 or 2 x AWG 16-12	AWG 12-8
	Flexible acc. to UL/CSA	1 or 2 x AWG 16-12	AWG 12-8
Stripping length		9 mm	10 mm
Tightening torques		0.8 ... 1.2 Nm / 10 ... 12 lb.in	2.0 Nm / 18 lb.in
Connection screw		M3.5 (Pozidriv 2 / 5.5 mm)	M4 (Pozidriv 2 / 6.5 mm)

# MS116 manual motor starters

## Main accessories

2



PS1-2-0-65

2CDC241017F0010

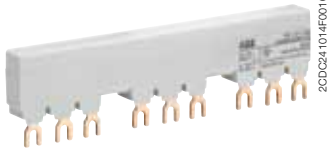

PS1-3-1-100

2CDC241014F0010



S1-M1-25

1SBC10126F0014



S1-M2-25

1SBC10126F0014



SA1

SKO108B91



SA2

SKO108B91

### Description

Three-phase busbars ensure a quick and safe connection and are therefore a cost effective solution. A variety of different three-phase busbars up to 100 A are in the assortment. Between 2 and 5 manual motor starters with none, one or two lateral auxiliary contacts can be connected. Different three-phase feeder terminals are available according to the application.

### Ordering details

Rated operational current A	Number of MMS	Number of lateral aux.	Type	Order code	Pkg qty	Weight (1 pce) kg
<b>Three-phase busbars</b>						
65	2	0	PS1-2-0-65	1SAM201906R1102	10	0.034
65	3	0	PS1-3-0-65	1SAM201906R1103	10	0.055
65	4	0	PS1-4-0-65	1SAM201906R1104	10	0.077
65	5	0	PS1-5-0-65	1SAM201906R1105	10	0.098
65	2	1	PS1-2-1-65	1SAM201906R1112	10	0.036
65	3	1	PS1-3-1-65	1SAM201906R1113	10	0.060
65	4	1	PS1-4-1-65	1SAM201906R1114	10	0.087
65	5	1	PS1-5-1-65	1SAM201906R1115	10	0.108
65	2	2	PS1-2-2-65	1SAM201906R1122	10	0.040
65	3	2	PS1-3-2-65	1SAM201906R1123	10	0.067
65	4	2	PS1-4-2-65	1SAM201906R1124	10	0.095
65	5	2	PS1-5-2-65	1SAM201906R1125	10	0.122
100	3	0	PS1-3-0-100	1SAM201916R1103	10	0.084
100	4	0	PS1-4-0-100	1SAM201916R1104	10	0.117
100	5	0	PS1-5-0-100	1SAM201916R1105	10	0.154
100	3	1	PS1-3-1-100	1SAM201916R1113	10	0.094
100	4	1	PS1-4-1-100	1SAM201916R1114	10	0.134
100	5	1	PS1-5-1-100	1SAM201916R1115	10	0.172
100	3	2	PS1-3-2-100	1SAM201916R1123	10	0.105

Rated operational current A	Rated cross section mm <sup>2</sup>	Mounting form	Type	Order code	Pkg qty	Weight (1 pce) kg
<b>Three-phase feeder terminals</b>						
65	25	Flat	S1-M1-25	1SAM201907R1101	10	0.038
65	25	High	S1-M2-25	1SAM201907R1102	10	0.051
65	25	UL type E and IEC	S1-M3-25	1SAM201907R1103	10	0.042
100	35	UL type E and IEC	S1-M3-35	1SAM201913R1103	10	0.060

Description	Type	Order code	Pkg qty	Weight (1 pce) kg
Protection cover for busbars	BS1-3	1SAM201908R1001	50	0.003
Lock handle	SA1	GJF1101903R0001	10	0.003
Padlock	SA2	GJF1101903R0002	10	0.020
Lock handle box SA1/SA2	SA3	GJF1101903R0003	10	0.050
Screw fixing kit	FS116	1SAM201909R1001	1	0.020

# MS116 manual motor starters

## Main accessories



HKF1-11

1SBC101209F0014



HK1-11

1SBC101209F0014



SK1-11

1SBC101219F0014



AA1-24

1SBC101211F0014



UA1-24

1SBC101212F0014

### Description

MS116 manual motor starters can be equipped with auxiliary contacts for lateral/front mounting, signalling contact for lateral mounting, undervoltage release and shunt trips. The accessories can be fitted wiring free and without tools. A variety of combinations is possible as required for the application. The auxiliary contacts change position with the main contacts. The signalling contact signals tripping regardless if it was caused by short-circuit or overload. Undervoltage release are used for remote tripping of the manual motor starter especially for emergency stop circuits. Shunt trips release the MMS used for remote tripping.

### Ordering details

Auxiliary contacts N.O.	Auxiliary contacts N.C.	Description	Type	Order code	Pkg qty	Weight (1 pce) kg
-------------------------	-------------------------	-------------	------	------------	---------	-------------------

#### Auxiliary contacts – mountable on the front

1	1		HKF1-11	1SAM201901R1001	10	0.015
2	0		HKF1-20	1SAM201901R1002	10	0.015

#### Auxiliary contacts – mountable on the right

1	1	max. 2 pieces	HK1-11	1SAM201902R1001	2	0.035
2	0	max. 2 pieces	HK1-20	1SAM201902R1002	2	0.035
0	2	max. 2 pieces	HK1-02	1SAM201902R1003	2	0.035
2	0	with lead contacts	HK1-20L	1SAM201902R1004	2	0.035

#### Signalling contacts – mountable on the right

1	1	for tripped alarm, max. 2 pieces	SK1-11	1SAM201903R1001	2	0.035
2	0	for tripped alarm, max. 2 pieces	SK1-20	1SAM201903R1002	2	0.035
0	2	for tripped alarm, max. 2 pieces	SK1-02	1SAM201903R1003	2	0.035

Rated control supply voltage V	Frequency Hz	Type	Order code	Pkg qty	Weight (1 pce) kg
--------------------------------	--------------	------	------------	---------	-------------------

#### Shunt trip units – mountable on the left

20 ... 24	50/60	AA1-24	1SAM201910R1001	1	0.100
110	50/60	AA1-110	1SAM201910R1002	1	0.100
200 ... 240	50/60	AA1-230	1SAM201910R1003	1	0.100
350 ... 415	50/60	AA1-400	1SAM201910R1004	1	0.100

#### Undervoltage releases – mountable on the left

24	50	UA1-24	1SAM201904R1001	1	0.100
48	50	UA1-48	1SAM201904R1002	1	0.100
60	50	UA1-60	1SAM201904R1003	1	0.100
110 ... 120	50/60	UA1-110	1SAM201904R1004	1	0.100
208	60	UA1-208	1SAM201904R1008	1	0.100
230 ... 240	50/60	UA1-230	1SAM201904R1005	1	0.100
400	50	UA1-400	1SAM201904R1006	1	0.100
415 ... 480	50/60	UA1-415	1SAM201904R1007	1	0.100

### Main dimensions mm, inches

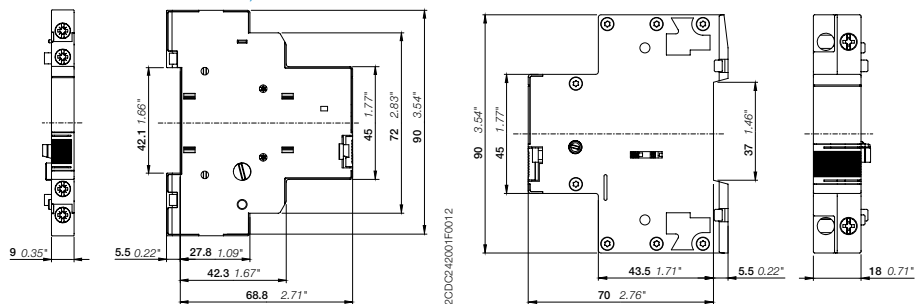

HK1

UA1

2CDC24200F0012

2CDC131039C0201



# MS116 manual motor starters

## Main accessories

### Manual motor starter with three-phase busbar systems

2

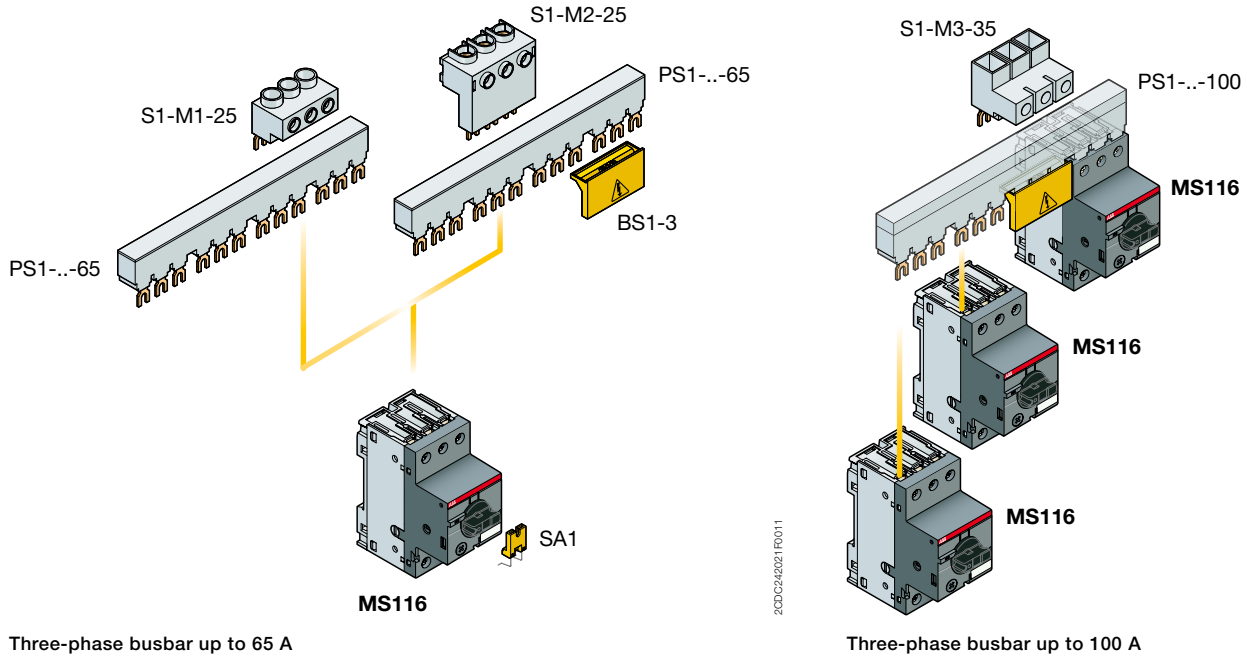

Three-phase busbar up to 65 A

Three-phase busbar up to 100 A

### General technical data

Type	PS1-xxx-65	PS1-xxx-100	S1-Mx-25	S1-Mx-35
Standards	IEC/EN 60947-4-1, IEC/EN 60947-1			
Rated operational voltage $U_n$	690 V			
Rated operational current $I_n$	65 A	100 A	65 A	100 A
Rated frequency	50/60 Hz			
Rated impulse withstand voltage $U_{imp}$	6 kV			
Rated insulation voltage $U_i$	690 V AC			
Pollution degree	3			
Cross-section	10 mm <sup>2</sup>	16 mm <sup>2</sup>	25 mm <sup>2</sup>	35 mm <sup>2</sup>
Ambient air temperature	Operation -25 ... +70 °C Storage -50 ... +80 °C			
Resistance to shock acc. to IEC 60068-2-27	25 g / 11 ms			
Resistance to vibrations acc. to IEC 60068-2-6	5 g / 3 ... 150 Hz			

### Electrical connection

#### Main circuit

Type	S1-Mx-25	S1-Mx-35
Connecting capacity		
Solid	1 x 6 ... 25 mm <sup>2</sup>	10 ... 35 mm <sup>2</sup>
Flexible	1 x 6 ... 16 mm <sup>2</sup>	10 ... 35 mm <sup>2</sup>
Stranded acc. to UL/CSA	1 x AWG 10-4	AWG 8-2
Flexible acc. to UL/CSA	1 x AWG 10-6	AWG 8-2
Stripping length	10 mm	12 mm
Tightening torques	2.5 Nm / 22 lb.in	4.5 Nm / 40 lb.in
Connection screw	PZ2 (6 mm)	Hexagon SW4

# MS116 manual motor starters

## Main accessories

### Manual motor starter with accessories

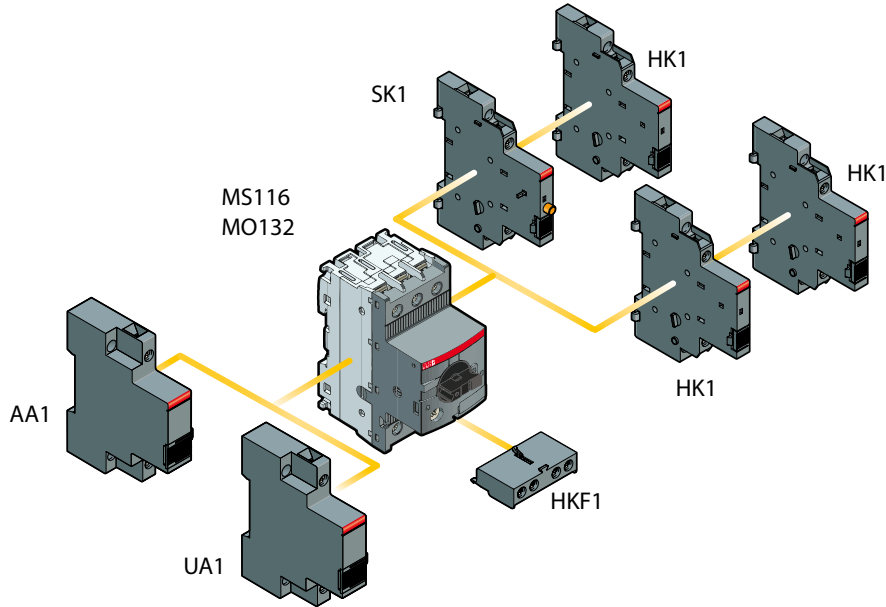

2CDC246001F0013

### General technical data

Type	HK1	SK1	HKF1
Standards	IEC/EN 60947-2, IEC/EN 60947-4-1, IEC/EN 60947-1		
Rated operational voltage $U_e$	690 V AC / 600 V DC		250 V AC / 250 V DC
Conventional free-air thermal current $I_{th}$	6 A		5 A
Rated frequency	50/60 Hz		
Rated impulse withstand voltage $U_{imp}$	6 kV		
Rated insulation voltage $U_i$	690 V AC		250 V AC
Pollution degree	3		
Ambient air temperature	Operation	-25 ... +70 °C	
	Storage	-50 ... +80 °C	
Resistance to shock acc. to IEC 60068-2-27	25 g / 11 ms		
Resistance to vibrations acc. to IEC 60068-2-6	5 g / 3 ... 150 Hz		
$I_e$ / Rated operational current AC-15 acc. to IEC/EN 60947-5-1 for utilization category			
	24 V, 120 V	6 A	3 A
	240 V	4 A	1.5 A
	400 V	3 A	-
	440 V, 690 V	1 A	-
$I_e$ / Rated operational current DC-13 acc. to IEC/EN 60947-5-1 for utilization category			
	24 V	2 A	1 A
	125 V	0.55 A	0.27 A
	250 V	0.27 A	0.11 A
	440 V, 600 V	0.15 A	-
Minimum switching capacity	17 V / 5 mA		
Short-circuit protective device	N.C., 95-96	10 A Type gG	
	N.O., 97-98	10 A Type gG	
Duty time	100 %		
Mounting	Right side of MMS		Front of MMS
Mounting positions	1-6		
Mechanical durability	50000 cycles		-
Electrical durability	50000 cycles		-



2CDC131039C0201

# MS116 manual motor starters

## Main accessories

### Electrical connection

#### Main circuit

Type	HK1	SK1	HKF1
<b>Connecting capacity</b>			
 Solid	<b>1 or 2 x</b>	1 ... 1.5 mm <sup>2</sup>	1 ... 2.5 mm <sup>2</sup>
 Flexible	<b>1 or 2 x</b>	0.75 ... 1.5 mm <sup>2</sup>	
Stranded acc. to UL/CSA	<b>1 or 2 x</b>	AWG 16-14	
Flexible acc. to UL/CSA	<b>1 or 2 x</b>	AWG 16-14	
<b>Stripping length</b>	8 mm		
<b>Tightening torques</b>	0.8 ... 1.2 Nm / 7 lb.in		
<b>Connection screw</b>	M3 (Pozidriv 2)		

2

# MS116 manual motor starters

## Main accessories



2CDC241004F0010

IB132-Y



2CDC241003F0010

IB132-G



2CDC241002F0010

DMS132-Y



2CDC241001F0010

DMS132-G

### Description

IB132 are IP65 enclosures for single MMS installation. Additional mounting of auxiliary and signalling contacts, shunt trips and undervoltage release is possible. The handle is lockable in OFF position. For detailed specification see installation instruction.

DMS132 are IP65 door mounting kits for MMS installation in any enclosure. Additional mounting of auxiliary, signalling, shunt trips and undervoltage release is possible. The handle is lockable in OFF position. For detailed specification see installation instruction.

### Ordering details

Description	Color	Type	Order code	Pkg qty	Weight (1 pce) kg
<b>Enclosures IP65</b>					
Padlockable max. 3 padlocks with bail diameter 4 ... 6.5 mm	Yellow/red	IB132-Y	1SAM201911R1011	1	0.370
	Grey/black	IB132-G	1SAM201911R1010	1	0.370
<b>Door mounting kit IP65</b>					
Padlockable max. 3 padlocks with bail diameter 4 ... 6.5 mm	Yellow/red	DMS132-Y	1SAM201912R1011	1	0.170
	Grey/black	DMS132-G	1SAM201912R1010	1	0.170

Indication I-O-T and ON-OFF-T

### Main dimensions mm, inches

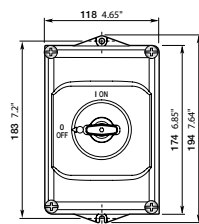

IB132

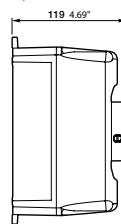

2CDC242011F0011

DMS132

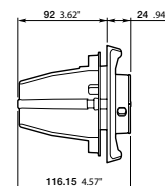
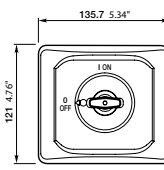

2CDC242012F0011

# MS116 manual motor starters

## Main accessories

2



2CDC241003F0011

MSHD-LB



2CDC24100250011

MSHD-LY



2CDC241004F0011

MSMN



2CDC241006F0011

MSOX-30



2CDC241001F0012

MSH-AR

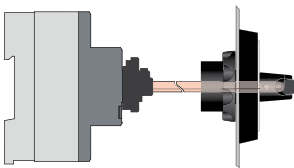

2CDC242003F0012

Shaft alignment ring

### Description

The complete set includes handle, shaft and driver. All accessories fit 6 mm shafts of maximum 180 mm length. The degree of protection for handles MSHD is IP64.

### Ordering details

Description	Shaft length mm	Type	Order code	Pkg qty	Weight (1 pce) kg
<b>Shafts</b>					
For selector type handles. Shaft diameter 6 mm. Shaft extension for door coupling driver.	85	OXS6X85	1SCA101647R1001	1	0.020
	105	OXS6X105	1SCA108043R1001	1	0.020
	130	OXS6X130	1SCA101655R1001	1	0.030
	180	OXS6X180	1SCA101659R1001	1	0.040

Description	Color mm	Type	Order code	Pkg qty	Weight (1 pce) kg
<b>Selector type handles IP64</b>					
Padlockable max. 3 padlocks with bail diameter 5 ... 8 mm, door interlock in ON position defeatable, for use with 6 mm OXS6...types up to 180 mm or driver shafts MSOX.	Black	MSHD-LB <sup>1)</sup>	1SAM201920R1001	1	0.065
	Yellow	MSHD-LY	1SAM201920R1002	1	0.065

<sup>1)</sup> Indication I-O and ON-OFF

Description	Type	Order code	Pkg qty	Weight (1 pce) kg
<b>Driver</b>				
Coupling driver for use with 6 mm OXS6... types up to 180 mm.	MSMN <sup>1)</sup>	1SAM101923R0002	1	0.002
	MSMNO <sup>2)</sup>	1SAM101923R0012	1	0.002

<sup>1)</sup> Coded - Positioning of ON indication dependent from mounting orientation of the MS

<sup>2)</sup> Uncoded - Positioning of ON indication independent from mounting orientation of the MS

Description	Shaft length mm	Type	Order code	Pkg qty	Weight (1 pce) kg
<b>Driver shafts</b>					
Driver shaft - combination driver & shaft. Shaft diameter 6 mm.	32	MSOX-32 <sup>1)</sup>	1SAM101924R0003	1	0.010
	30	MSOX-30 <sup>2)</sup>	1SAM101924R0013	1	0.010

<sup>1)</sup> MSOX-32 is for normal vertical use

<sup>2)</sup> MSOX-30 is for horizontal use

Description	Type	Order code	Pkg qty	Weight (1 pce) kg
<b>Shaft alignment ring</b>				
The MSH-AR supports the long axis for alignment to the handle inlet. It makes closing panel doors more easy.	MSH-AR	1SAM201920R1000	1	0.010

# MS132 manual motor starters

## 0.10 to 32 A – with thermal and electromagnetic protection



1SEB101232F010

MS132-10



2CDC241001F0011

MS132-32



2CDC241014F0011

MS132-0.16-HKF1-11



2CDC241015F0011

MS132-32-HKF1-11

### Description

Manual motor starters (MMS) are protection devices for the main circuit. They combine motor control and protection in a single device. MMS are used mainly to switch motors manually ON/OFF and protect them and the installation fuse less against short-circuit, overload and phase failures. Fuse less protection with a manual motor starter saves costs, space and ensures a quick reaction under short-circuit condition, by switching off the motor within milliseconds.

MS132 is a compact and powerful range for motor protection up to 15 kW (400 V) / 32 A in width of 45 mm. Further features are the built-in disconnect function, temperature compensation, trip-free mechanism and a rotary handle with a clear switch position indication. The manual motor starter is suitable for three- and single-phase applications. The handle is lockable to protect against unauthorized changes. Auxiliary contacts, signalling contacts, undervoltage releases, shunt trips, three-phase bus bars, power in-feed blocks.

### Ordering details

Rated operational power 400 V AC-3	Setting range	Short-circuit breaking capacity $I_{cs}$ at 400 V AC	Rated instantaneous short-circuit current setting $I_i$	Type	Order code	Weight (1 pce)
kW	A	kA	A			kg
0.03	0.10 ... 0.16	100	1.56	MS132-0.16	1SAM350000R1001	0.215
0.06	0.16 ... 0.25	100	2.44	MS132-0.25	1SAM350000R1002	0.215
0.09	0.25 ... 0.40	100	3.90	MS132-0.4	1SAM350000R1003	0.215
0.12	0.40 ... 0.63	100	6.14	MS132-0.63	1SAM350000R1004	0.215
0.25	0.63 ... 1.00	100	11.50	MS132-1.0	1SAM350000R1005	0.215
0.55	1.00 ... 1.60	100	18.40	MS132-1.6	1SAM350000R1006	0.265
0.75	1.60 ... 2.50	100	28.75	MS132-2.5	1SAM350000R1007	0.265
1.5	2.50 ... 4.00	100	50.00	MS132-4.0	1SAM350000R1008	0.265
2.2	4.00 ... 6.30	100	78.75	MS132-6.3	1SAM350000R1009	0.265
4.0	6.30 ... 10.0	100	150	MS132-10	1SAM350000R1010	0.265
5.5	8.00 ... 12.0	100	180	MS132-12	1SAM350000R1012	0.310
7.5	10.0 ... 16.0	100	240	MS132-16	1SAM350000R1011	0.310
9.0	16.0 ... 20.0	100	300	MS132-20	1SAM350000R1013	0.310
12.5	20.0 ... 25.0	50	375	MS132-25	1SAM350000R1014	0.310
15.5	25.0 ... 32.0	25	480	MS132-32	1SAM350000R1015	0.310
0.03	0.10 ... 0.16	100	1.56	MS132-0.16-HKF1-11	1SAM350005R1001	0.231
0.06	0.16 ... 0.25	100	2.44	MS132-0.25-HKF1-11	1SAM350005R1002	0.231
0.09	0.25 ... 0.40	100	3.90	MS132-0.4-HKF1-11	1SAM350005R1003	0.231
0.12	0.40 ... 0.63	100	6.14	MS132-0.63-HKF1-11	1SAM350005R1004	0.231
0.25	0.63 ... 1.00	100	11.50	MS132-1.0-HKF1-11	1SAM350005R1005	0.231
0.55	1.00 ... 1.60	100	18.40	MS132-1.6-HKF1-11	1SAM350005R1006	0.281
0.75	1.60 ... 2.50	100	28.75	MS132-2.5-HKF1-11	1SAM350005R1007	0.281
1.5	2.50 ... 4.00	100	50.00	MS132-4.0-HKF1-11	1SAM350005R1008	0.281
2.2	4.00 ... 6.30	100	78.75	MS132-6.3-HKF1-11	1SAM350005R1009	0.281
4.0	6.30 ... 10.0	100	150	MS132-10.0-HKF1-11	1SAM350005R1010	0.281
5.5	8.00 ... 12.0	100	180	MS132-12.0-HKF1-11	1SAM350005R1012	0.326
7.5	10.0 ... 16.0	100	240	MS132-16.0-HKF1-11	1SAM350005R1011	0.326
9.0	16.0 ... 20.0	100	300	MS132-20-HKF1-11	1SAM350005R1013	0.326
12.5	20.0 ... 25.0	50	375	MS132-25-HKF1-11	1SAM350005R1014	0.326
15.5	25.0 ... 32.0	25	480	MS132-32-HKF1-11	1SAM350005R1015	0.326

### Main dimensions mm, inches

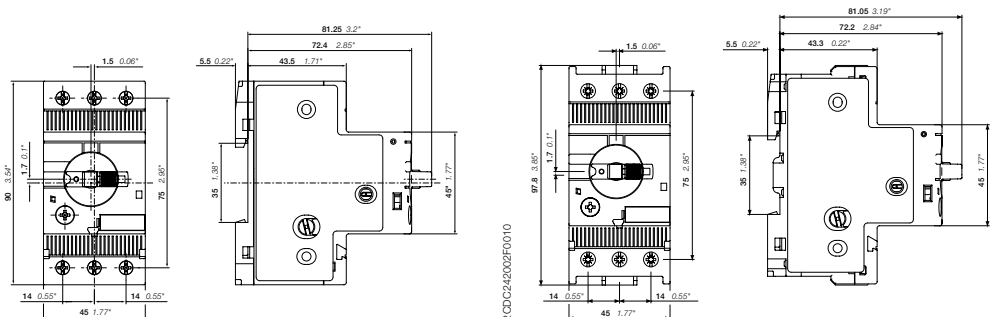

MS132 ≤ 10 A

MS132 ≥ 12 A

# MS132 manual motor starters

## Technical data

2

### Main circuit – Utilization characteristics according to IEC/EN

Type	MS132
Standards	IEC/EN 60947-2, IEC/EN 60947-4-1, IEC/EN 60947-1
Rated operational voltage $U_n$	690 V AC / 250 V DC
Rated frequency	DC, 50/60 Hz
Trip class	10 (10A for 1SAM350000R1001)
Number of poles	3
Duty time	100 %
Mechanical durability	100000 operations
Electrical durability	50000 operations
Rated impulse withstand voltage $U_{imp}$	6 kV
Rated insulation voltage $U_i$	690 V AC
Rated operational current $I_n$	See ordering details
Rated operational current DC $I_g$	See "Rated operational current $I_g$ "
3 conducting paths in series up to 250 V	
Rated instantaneous short-circuit current setting $I_{cs}$	See ordering details
Rated service short-circuit breaking capacity $I_{cs}$	See table "Short-circuit breaking capacity and back-up fuses"
Rated ultimate short-circuit breaking capacity $I_{cu}$	See table "Short-circuit breaking capacity and back-up fuses"
Rated service short-circuit breaking capacity DC $I_{cs}$	10 kA
3 conducting paths in series up to 250 V	

### Short-circuit breaking capacity and back-up fuses

$I_{cs}$  Rated service short-circuit breaking capacity

$I_{cu}$  Rated ultimate short-circuit breaking capacity

$I_{cc}$  Prospective short-circuit current at installation location

Note: Maximum rated current of the back-up fuses if  $I_{cc} > I_{cs}$

Type	230 V AC			400 V AC			440 V AC			500 V AC			690 V AC		
	$I_{cs}$ kA	$I_{cu}$ kA	gG, aM A	$I_{cs}$ kA	$I_{cu}$ kA	gG, aM A	$I_{cs}$ kA	$I_{cu}$ kA	gG, aM A	$I_{cs}$ kA	$I_{cu}$ kA	gG, aM A	$I_{cs}$ kA	$I_{cu}$ kA	gG, aM A
MS132-0.16															
MS132-0.25															
MS132-0.4															
MS132-0.63	No back-up fuse required up to $I_{cc} = 100$ kA														
MS132-1.0															
MS132-1.6															
MS132-2.5															
MS132-4.0							20	20	35	20	20	35	3	3	32
MS132-6.3							20	20	63	20	20	63	3	3	50
MS132-10							20	20	100	20	20	100	3	3	50
MS132-12							20	20	100	20	20	100	3	3	63
MS132-16							20	20	125	20	20	125	3	3	63
MS132-20							20	20	125	20	20	125	3	3	80
MS132-25	50	50	125	50	50	125	20	20	125	10	10	125	3	3	100
MS132-32	25	50	125	25	50	125	20	20	125	10	10	125	3	3	100

MS132-16: No need for back-up fuse in networks with a prospective current of up to 100 kA at 400 V.

MS132-32: No need for back-up fuse in networks with a prospective current of up to 50 kA at 400 V.

With an appropriate 125 A type gG fuse the device can be used in a network with a prospective current of up to 100 kA



# MS132 manual motor starters

## Technical data

### Main circuit – Utilization characteristics according to UL/CSA

Type	MS132	
Standards	UL 508, CSA 22.2 No. 14	
Maximum operational voltage	600 V AC	
Manual motor controller ratings	See table "UL 508 – Manual motor controller"	
Trip rating	125 % FLA	
Motor ratings	Horse power	See table "Motor rating, three phase"
	Full load amps (FLA)	See table "Motor rating, three phase"
	Locked rotor amps (LRA)	See table "Motor rating, three phase"

### Motor rating, single phase

hp Horse power

FLA Full load amps

LRA Locked rotor amps

Type	220-240 V AC			440-480 V AC		
	hp	FLA	LRA	hp	FLA	LRA
MS132-0.16	-	0.16	0.96	-	0.16	0.96
MS132-0.25	-	0.25	1.5	-	0.25	1.5
MS132-0.4	-	0.4	2.4	-	0.4	2.4
MS132-0.63	-	0.63	3.78	-	0.63	3.78
MS132-1.0	-	1	6	-	1	6
MS132-1.6	1/10	1.6	9.6	-	1.6	9.6
MS132-2.5	1/6	2.5	15	1/2	2.5	15
MS132-4.0	1/3	4	24	1/2	4	24
MS132-6.3	1/2	6.3	37.8	1	6.3	37.8
MS132-10	1-1/2	10	60	3	8.5	46
MS132-12	2	12	72	3	8.5	64
MS132-16	2	12	72	5	14	81
MS132-20	3	17	92	5	14	81
MS132-25	3	17	127	7-1/2	21	116
MS132-32	5	28	162	10	26	145

### Motor rating, three phase

hp Horse power

FLA Full load amps

LRA Locked rotor amps

Type	110-120 V AC			220-240 V AC			440-480 V AC			500-600 V AC		
	hp	FLA	LRA	hp	FLA	LRA	hp	FLA	LRA	hp	FLA	LRA
MS132-0.16	-	0.16	0.96	-	0.16	0.96	-	0.16	0.96	-	0.16	0.96
MS132-0.25	-	0.25	1.5	-	0.25	1.5	-	0.25	1.5	-	0.25	1.5
MS132-0.4	-	0.4	2.4	-	0.4	2.4	-	0.4	2.4	-	0.4	2.4
MS132-0.63	-	0.63	3.78	-	0.63	3.78	-	0.63	3.78	-	0.63	3.78
MS132-1.0	-	1.0	6.0	-	1.0	6.0	-	1.0	6.0	1/2	1.0	6.0
MS132-1.6	-	1.6	9.6	-	1.6	9.6	3/4	1.6	9.6	3/4	1.6	9.6
MS132-2.5	-	2.5	15.0	1/2	2.5	15.0	1	2.5	15.0	1-1/2	2.5	15.0
MS132-4.0	-	4.0	24.0	1	4.0	24.0	2	4.0	24.0	3	3.9	26.0
MS132-6.3	1/2	6.3	37.8	1-1/2	6.3	37.8	3	4.8	32.0	5	6.1	37.0
MS132-10	3/4	10.0	60.0	3	9.6	64.0	5	7.6	46.0	7-1/2	9.0	51.0
MS132-12	1-1/2	12.0	72.0	3	9.6	64.0	7-1/2	11.0	64.0	10	11.0	65.0
MS132-16	2	16.0	84.0	5	15.2	92.0	10	14.0	81.0	10	11.0	65.0
MS132-20	3	19.2	128.0	5	15.2	92.0	10	14.0	81.0	15	17.0	93.0
MS132-25	3	19.2	128.0	7-1/2	22.0	127.0	15	21.0	116.0	20	22.0	116.0
MS132-32	5	30.4	184.0	10	28.0	162.0	20	27.0	145.0	25	27.0	146.0

# MS132 manual motor starters

## Technical data

### UL 508 – Manual motor controller



Type	Maximum short-circuit current for motor disconnect <sup>1)</sup>		for group installation		for self-protected combination motor controller (type E) in combination with feeder block S1-M3-xx		for tap conductor protection	
	480 V kA	600 V kA	480 V kA	600 V kA	480Y / 277 V kA	600Y / 347 V kA	480 V kA	600 V kA
MS132-0.16	65	47	65	47	65	47	65	47
MS132-0.25	65	47	65	47	65	47	65	47
MS132-0.4	65	47	65	47	65	47	65	47
MS132-0.63	65	47	65	47	65	47	65	47
MS132-1.0	65	47	65	47	65	47	65	47
MS132-1.6	65	47	65	47	65	47	65	47
MS132-2.5	65	47	65	47	65	47	65	47
MS132-4.0	65	18	65	30	65	18	65	18
MS132-6.3	65	18	65	30	65	18	65	18
MS132-10	65	18	65	30	65	18	65	18
MS132-12	30	18	30	30	30	-	30	18
MS132-16	30	18	30	30	30	-	30	18
MS132-20	30	18	30	30	30	-	30	18
MS132-25	30	18	30	30	30	-	30	18
MS132-32	30	18	30	30	30	-	30	18

### General technical data

Type	MS132	
Pollution degree	3	
Phase loss sensitivity	Yes	
Disconnect function acc. to IEC/EN 60947-2	Yes	
Ambient air temperature		
Operation	Open - compensated	-25 ... +60 °C
	Open	-25 ... +70 °C
	Enclosed (IB132)	0 ... +40 °C
Storage	-50 ... +70 °C	
Ambient air temperature compensation	Acc. to IEC/EN60947-4-1	
Maximum operating altitude permissible	2000 m	
Resistance to shock acc. to IEC 60068-2-27	25 g / 11 ms	
Resistance to vibrations acc. to IEC 60068-2-6	5 g / 3 ... 150 Hz	
Mounting position	Position 1-6 (optional for single mounting)	
Mounting	DIN-rail (EN 60715)	
Group mounting	On request	
Minimum distance to other units same type	Horizontal	0 mm
	Vertical	150 mm
Minimum distance to electrical conductive board	Horizontal, up to 400 V	0 mm
	Horizontal, up to 690 V	> 1.5 mm
	Vertical	75 mm
Degree of protection	Housing	IP20
	Main circuit terminals	IP20

### Connecting characteristics

#### Main circuit

Type	MS132-0.16 ... MS132-10	MS132-12 ... MS132-16	MS132-20 ... MS132-32
Connecting capacity			
 Solid	1 or 2 x 1 ... 4 mm <sup>2</sup>	1 ... 4 mm <sup>2</sup>	2.5 ... 6 mm <sup>2</sup>
 Flexible	1 or 2 x 0.75 ... 2.5 mm <sup>2</sup>	0.75 ... 2.5 mm <sup>2</sup>	1 ... 6 mm <sup>2</sup>
Stranded acc. to UL/CSA	1 or 2 x AWG 16-12	AWG 16-12	AWG 12-8
Flexible acc. to UL/CSA	1 or 2 x AWG 16-12	AWG 16-12	AWG 12-8
Stripping length	9 mm	10 mm	10 mm
Tightening torques	0.8 ... 1.2 Nm / 10 ... 12 lb.in	1.5 Nm / 14 lb.in	2.0 Nm / 18 lb.in
Connection screw	M3.5 (Pozi driv 2)	M4 (Pozi driv 2)	M4 (Pozi driv 2)

# MS132 manual motor starters

## Main accessories



PS1-3-1-65

2CDC241007F0010



PS1-3-1-100

2CDC241014F0010



S1-M1-25

1SBC101228F0014



S1-M2-25

1SBC101268F0014



S1-M3-25

1SBC101214F0014



SA2

SK0109B91

### Description

Three-phase busbars ensure a quick and safe connection and are therefore a cost effective solution. A variety of different three-phase busbars up to 100 A are in the assortment. Between 2 and 5 manual motor starters with none, one or two lateral auxiliary contacts can be connected. Different three-phase feeder terminals are available according to the application.

### Ordering details

Rated operational current A	Number of MMS	Number of lateral aux.	Type	Order code	Pkg qty	Weight (1 pce) kg
<b>Three-phase busbars</b>						
65	2	0	PS1-2-0-65	1SAM201906R1102	10	0.034
65	3	0	PS1-3-0-65	1SAM201906R1103	10	0.055
65	4	0	PS1-4-0-65	1SAM201906R1104	10	0.077
65	5	0	PS1-5-0-65	1SAM201906R1105	10	0.098
65	2	1	PS1-2-1-65	1SAM201906R1112	10	0.036
65	3	1	PS1-3-1-65	1SAM201906R1113	10	0.060
65	4	1	PS1-4-1-65	1SAM201906R1114	10	0.087
65	5	1	PS1-5-1-65	1SAM201906R1115	10	0.108
65	2	2	PS1-2-2-65	1SAM201906R1122	10	0.040
65	3	2	PS1-3-2-65	1SAM201906R1123	10	0.067
65	4	2	PS1-4-2-65	1SAM201906R1124	10	0.095
65	5	2	PS1-5-2-65	1SAM201906R1125	10	0.122
100	3	0	PS1-3-0-100	1SAM201916R1103	10	0.084
100	4	0	PS1-4-0-100	1SAM201916R1104	10	0.117
100	5	0	PS1-5-0-100	1SAM201916R1105	10	0.154
100	3	1	PS1-3-1-100	1SAM201916R1113	10	0.094
100	4	1	PS1-4-1-100	1SAM201916R1114	10	0.134
100	5	1	PS1-5-1-100	1SAM201916R1115	10	0.172
100	3	2	PS1-3-2-100	1SAM201916R1123	10	0.105

Rated operational current A	Rated cross section mm <sup>2</sup>	Mounting form	Type	Order code	Pkg qty	Weight (1 pce) kg
<b>Three-phase feeder terminals</b>						
65	25	Flat	S1-M1-25	1SAM201907R1101	10	0.038
65	25	High	S1-M2-25	1SAM201907R1102	10	0.051
65	25	UL type E and IEC	S1-M3-25	1SAM201907R1103	10	0.042
100	35	UL type E and IEC	S1-M3-35	1SAM201913R1103	10	0.060

Description	Type	Order code	Pkg qty	Weight (1 pce) kg
Protection cover for busbars	BS1-3	1SAM201908R1001	50	0.003
Padlock	SA2	GJF1101903R0002	10	0.020
Screw fixing kit	FS116	1SAM201909R1001	1	0.020

# MS132 manual motor starters

## Main accessories

2



1SBC101208F0014

HKF1-11



1SBC101209F0014

HK1-11



1SBC101219F0014

SK1-11



1SBC101288F0014

CK1-11



1SBC101211F0014

AA1-24



1SBC101212F0014

UA1-24

### Description

MS132 manual motor starters can be equipped with auxiliary contacts for lateral/front mounting, signalling contact for lateral mounting, undervoltage release and shunt trips. Two different signalling contacts are available. The accessories can be fitted wiring free and without tools. A variety of combinations is possible as required for the application. The auxiliary contacts change position with the main contacts. The signalling contact SK signals tripping regardless if it was caused by short-circuit or overload. The signalling contact CK signals tripping in case it was caused by short-circuit. Undervoltage release are used for remote tripping of the manual motor starter especially for emergency stop circuits. Shunt trips release the MMS used for remote tripping.

### Ordering details

Auxiliary contacts N.O.	Auxiliary contacts N.C.	Description	Type	Order code	Pkg qty	Weight (1 pce) kg
-------------------------	-------------------------	-------------	------	------------	---------	-------------------

#### Auxiliary contacts – mountable on the front

1	1		HKF1-11	1SAM201901R1001	10	0.015
2	0		HKF1-20	1SAM201901R1002	10	0.015

#### Auxiliary contacts – mountable on the right

1	1	max. 2 pieces	HK1-11	1SAM201902R1001	2	0.035
2	0	max. 2 pieces	HK1-20	1SAM201902R1002	2	0.035
0	2	max. 2 pieces	HK1-02	1SAM201902R1003	2	0.035
2	0	with lead contacts	HK1-20L	1SAM201902R1004	2	0.035

#### Signalling contacts – mountable on the right

1	1	for tripped alarm, max. 2 pieces	SK1-11	1SAM201903R1001	2	0.035
2	0	for tripped alarm, max. 2 pieces	SK1-20	1SAM201903R1002	2	0.035
0	2	for tripped alarm, max. 2 pieces	SK1-02	1SAM201903R1003	2	0.035
1	1	for short-circuit alarm, max. 2 pieces	CK1-11	1SAM301901R1001	2	0.035
2	0	for short-circuit alarm, max. 2 pieces	CK1-20	1SAM301901R1002	2	0.035
0	2	for short-circuit alarm, max. 2 pieces	CK1-02	1SAM301901R1003	2	0.035

Rated control supply voltage	Frequency	Type	Order code	Pkg qty	Weight (1 pce) kg
V	Hz				

#### Shunt trip units – mountable on the left

20 ... 24	50/60	AA1-24	1SAM201910R1001	1	0.100
110	50/60	AA1-110	1SAM201910R1002	1	0.100
200 ... 240	50/60	AA1-230	1SAM201910R1003	1	0.100
350 ... 415	50/60	AA1-400	1SAM201910R1004	1	0.100

#### Undervoltage releases – mountable on the left

24	50	UA1-24	1SAM201904R1001	1	0.100
48	50	UA1-48	1SAM201904R1002	1	0.100
60	50	UA1-60	1SAM201904R1003	1	0.100
110 ... 120	50/60	UA1-110	1SAM201904R1004	1	0.100
208	60	UA1-208	1SAM201904R1008	1	0.100
230 ... 240	50/60	UA1-230	1SAM201904R1005	1	0.100
400	50	UA1-400	1SAM201904R1006	1	0.100
415 ... 480	50/60	UA1-415	1SAM201904R1007	1	0.100

### Main dimensions mm, inches

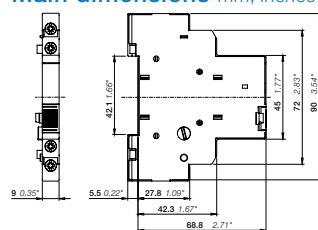

HK1

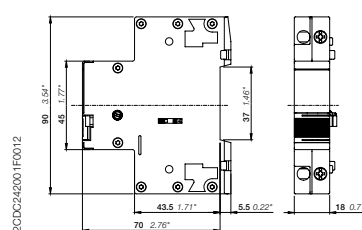

UA1

# MS132 manual motor starters

## Main accessories

### Manual motor starter with three-phase busbar systems

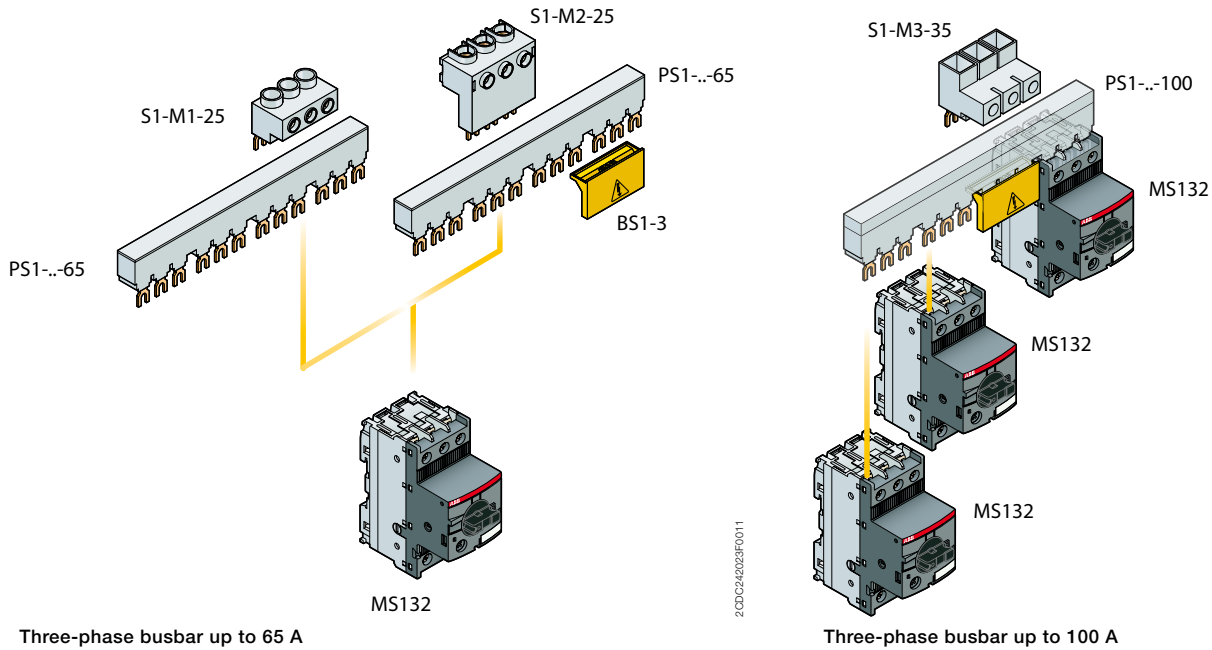

### General technical data

Type	PS1-xxx-65	PS1-xxx-100	S1-Mx-25	S1-Mx-35
Standards	IEC/EN 60947-4-1, IEC/EN 60947-1			
Rated operational voltage $U_n$	690 V			
Rated operational current $I_n$	65 A	100 A	65 A	100 A
Rated frequency	50/60 Hz			
Rated impulse withstand voltage $U_{imp}$	6 kV			
Rated insulation voltage $U_i$	690 V AC			
Pollution degree	3			
Cross-section	10 mm <sup>2</sup>	16 mm <sup>2</sup>	25 mm <sup>2</sup>	35 mm <sup>2</sup>
Ambient air temperature	Operation: -25 ... +70 °C Storage: -50 ... +80 °C			
Resistance to shock acc. to IEC 60068-2-27	25 g / 11 ms			
Resistance to vibrations acc. to IEC 60068-2-6	5 g / 3 ... 150 Hz			

### Electrical connection

#### Main circuit

Type	S1-Mx-25	S1-Mx-35
Connecting capacity		
Solid	1 x 6 ... 25 mm <sup>2</sup>	10 ... 35 mm <sup>2</sup>
Flexible	1 x 6 ... 16 mm <sup>2</sup>	10 ... 35 mm <sup>2</sup>
Stranded acc. to UL/CSA	1 x AWG 10-4	AWG 8-2
Flexible acc. to UL/CSA	1 x AWG 10-6	AWG 8-2
Stripping length	10 mm	12 mm
Tightening torques	2.5 Nm / 22 lb.in	4.5 Nm / 40 lb.in
Connection screw	PZ2 (6 mm)	Hexagon SW4

# MS132 manual motor starters

## Main accessories

### Manual motor starter with accessories

2

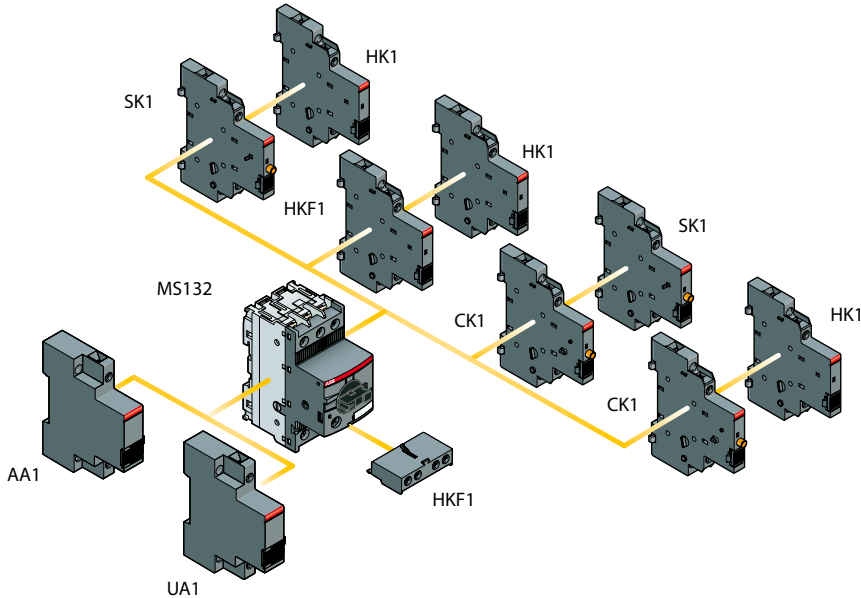

1SBC500311F0000

### General technical data

Type	HK1	SK1	CK1	HKF1
Standards	IEC/EN 60947-2, IEC/EN 60947-4-1, IEC/EN 60947-1			
Rated operational voltage $U_n$	690 V AC / 600 V DC			250 V AC / 250 V DC
Conventional free-air thermal current $I_{th}$	6 A	6 A	65 A	5 A
Rated frequency	50/60 Hz			
Rated impulse withstand voltage $U_{imp}$	6 kV			
Rated insulation voltage $U_i$	690 V AC			250 V AC
Pollution degree	3			
Ambient air temperature	Operation: -25 ... +70 °C			
	Storage: -50 ... +80 °C			
Resistance to shock acc. to IEC 60068-2-27	25 g / 11 ms			
Resistance to vibrations acc. to IEC 60068-2-6	5 g / 3 ... 150 Hz			
$I_e$ / Rated operational current AC-15 acc. to IEC/EN 60947-5-1 for utilization category				
	24 V, 120 V	6 A		3 A
	240 V	4 A		1.5 A
	400 V	3 A		-
	440 V, 690 V	1 A		-
$I_e$ / Rated operational current DC-13 acc. to IEC/EN 60947-5-1 for utilization category				
	24 V	2 A		1 A
	125 V	0.55 A		0.27 A
	250 V	0.27 A		0.11 A
	440 V, 600 V	0.15 A		-
Minimum switching capacity	17 V / 5 mA			
Short-circuit protective device	N.C., 95-96	10 A Type gG		
	N.O., 97-98	10 A Type gG		
Duty time	100 %			
Mounting	Right side of MMS			Front of MMS
Mounting positions	1-6			
Mechanical durability	50000 cycles			100000 cycles
Electrical durability	50000 cycles			100000 cycles



2CDC131040C0201



# MS132 manual motor starters

## Main accessories

### Electrical connection

Main circuit			HK1	SK1	CK1	HKF1
Type						
<b>Connecting capacity</b>						
 Solid	<b>1 or 2 x</b>	1 ... 1.5 mm <sup>2</sup>				1 ... 2.5 mm <sup>2</sup>
 Flexible	<b>1 or 2 x</b>	0.75 ... 1.5 mm <sup>2</sup>				
	<b>1 or 2 x</b>	AWG 16-14				
	<b>1 or 2 x</b>	AWG 16-14				
<b>Stripping length</b>						
		8 mm				
<b>Tightening torques</b>						
		0.8 ... 1.2 Nm / 7 lb.in				
<b>Connection screw</b>						
		M3 (Pozidriv 2)				

# MS132 manual motor starters

## Main accessories

2



2CDC241004F0010

IB132-Y



2CDC241003F0010

IB132-G



2CDC241002F0010

DMS132-Y



2CDC241001F0010

DMS132-G

### Description

IB132 are IP65 enclosures for single MMS installation. Additional mounting of auxiliary and signalling contacts, shunt trips and undervoltage release is possible. The handle is lockable in OFF position. For detailed specification see installation instruction.

DMS132 are IP65 door mounting kits for MMS installation in any enclosure. Additional mounting of auxiliary, signalling, shunt trips and undervoltage release is possible. The handle is lockable in OFF position. For detailed specification see installation instruction.

### Ordering details

Description	Colour	Type	Order code	Pkg qty	Weight (1 pce) kg
<b>Enclosures IP65</b>					
Padlockable max. 3 padlocks with bail diameter 4 ... 6.5 mm	Yellow/red	IB132-Y	1SAM201911R1011	1	0.370
	Grey/black	IB132-G	1SAM201911R1010	1	0.370
<b>Door mounting kit IP65</b>					
Padlockable max. 3 padlocks with bail diameter 4 ... 6.5 mm	Yellow/red	DMS132-Y	1SAM201912R1011	1	0.170
	Grey/black	DMS132-G	1SAM201912R1010	1	0.170

Indication I-O-T and ON-OFF-T

### Main dimensions mm, inches

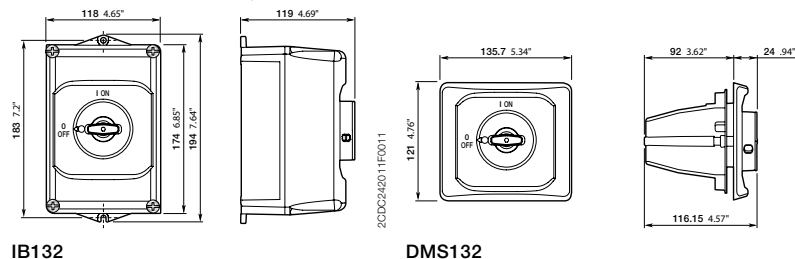

IB132

DMS132

# MS132 manual motor starters

## Main accessories



MSHD-LTB

2CDC24100FF0011



MSHD-LTY

2CDC241006FF0011



MSMN

2CDC241004FF0011



MSOX-30

2CDC241003FF0011



MSH-AR

2CDC241001FF0012

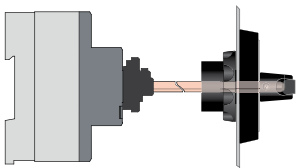

Shaft alignment ring

2CDC242003FF0012

### Description

The complete set includes handle, shaft and driver. All accessories fit 6 mm shafts of maximum 180 mm length. The degree of protection for handles MSHD is IP64.

### Ordering details

Description	Shaft length mm	Type	Order code	Pkg qty	Weight (1 pce) kg
-------------	--------------------	------	------------	------------	-------------------------

#### Shafts

For selector type handles. Shaft diameter 6 mm. Shaft extension for door coupling driver.

85	OXS6X85	1SCA101647R1001	1	0.020
105	OXS6X105	1SCA108043R1001	1	0.020
130	OXS6X130	1SCA101655R1001	1	0.030
180	OXS6X180	1SCA101659R1001	1	0.040

Description	Color mm	Type	Order code	Pkg qty	Weight (1 pce) kg
-------------	-------------	------	------------	------------	-------------------------

#### Selector type handles IP64

Padlockable max. 3 padlocks with bail diameter 5 ... 8 mm, door interlock in ON position defeatable, for use with 6 mm OXS6...types up to 180 mm or driver shafts MSOX.

Black	MSHD-LTB <sup>1)</sup>	1SAM201920R1011	1	0.065
Yellow	MSHD-LTY <sup>1)</sup>	1SAM201920R1012	1	0.065

<sup>1)</sup> Indication I-O-T and ON-OFF-T

Description	Type	Order code	Pkg qty	Weight (1 pce) kg
-------------	------	------------	------------	-------------------------

#### Driver

Coupling driver for use with 6 mm OXS6... types up to 180 mm.

MSMN <sup>1)</sup>	1SAM101923R0002	1	0.002
MSMNO <sup>2)</sup>	1SAM101923R0012	1	0.002

<sup>1)</sup> Coded - Positioning of ON indication dependent from mounting orientation of the MS

<sup>2)</sup> Uncoded - Positioning of ON indication independent from mounting orientation of the MS

Description	Shaft length mm	Type	Order code	Pkg qty	Weight (1 pce) kg
-------------	--------------------	------	------------	------------	-------------------------

#### Driver shafts

Driver shaft - combination driver & shaft. Shaft diameter 6 mm.

32	MSOX-32 <sup>1)</sup>	1SAM101924R0003	1	0.010
30	MSOX-30 <sup>2)</sup>	1SAM101924R0013	1	0.010

<sup>1)</sup> MSOX-32 is for normal vertical use

<sup>2)</sup> MSOX-30 is for horizontal use

Description	Type	Order code	Pkg qty	Weight (1 pce) kg
-------------	------	------------	------------	-------------------------

#### Shaft alignment ring

The MSH-AR supports the long axis for alignment to the handle inlet. It makes closing panel doors more easy.

MSH-AR	1SAM201920R1000	1	0.010
--------	-----------------	---	-------

# MO132 manual motor starters magnetic only 0.10 to 32 A – with electromagnetic protection

2



2CDC241009F0011

MO132-6.3



2CDC241009F0011

MO132-32

## Description

Manual motor starters magnetic only are electromechanical protection devices for the main circuit. They are used mainly to switch motors manually ON/OFF and protect them fuse less against short-circuit.

Fuse less protection with a manual motor starter saves costs, space and ensures a quick reaction under short-circuit condition, by switching off the motor within milliseconds. Fuse less starter combinations are setup together with contactors and overload relays.

## Ordering details

Rated operational power 400 V AC-3 <sup>1)</sup> kW	Rated operational current A	Short-circuit breaking capacity $I_{cs}$ at 400 V AC kA	Rated instantaneous short-circuit current setting $I_i$ A	Type	Order code	Weight (1 pce) kg
0.03	0.16	100	1.56	MO132-0.16	1SAM360000R1001	0.215
0.06	0.25	100	2.44	MO132-0.25	1SAM360000R1002	0.215
0.09	0.40	100	3.90	MO132-0.4	1SAM360000R1003	0.215
0.12	0.63	100	6.14	MO132-0.63	1SAM360000R1004	0.215
0.25	1.0	100	11.50	MO132-1.0	1SAM360000R1005	0.215
0.55	1.6	100	18.40	MO132-1.6	1SAM360000R1006	0.265
0.75	2.5	100	28.75	MO132-2.5	1SAM360000R1007	0.265
1.5	4.0	50	50.00	MO132-4.0	1SAM360000R1008	0.265
2.2	6.3	50	78.75	MO132-6.3	1SAM360000R1009	0.265
4.0	10	50	125.00	MO132-10	1SAM360000R1010	0.265
5.5	12	50	150.00	MO132-12	1SAM360000R1012	0.310
7.5	16	50	200.00	MO132-16	1SAM360000R1011	0.310
9.0	20	50	250.00	MO132-20	1SAM360000R1013	0.310
12.5	25	50	312.50	MO132-25	1SAM360000R1014	0.310
15.5	32	25	400.00	MO132-32	1SAM360000R1015	0.310

<sup>1)</sup> For overload protection of motors, an appropriate thermal or electronic overload relay must be used

## Main dimensions mm, inches

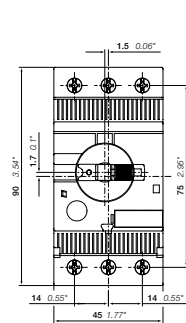

MO132 ≤ 10 A

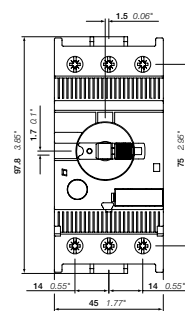
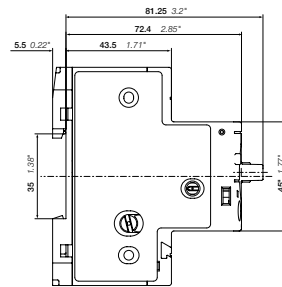

MO132 ≥ 12 A

# MO132 manual motor starters magnetic only

## Technical data

### Main circuit – Utilization characteristics according to IEC/EN

Type	MO132
Standards	IEC/EN 60947-2, IEC/EN 60947-4-1, IEC/EN 60947-1
Rated operational voltage $U_n$	690 V AC
Rated frequency	50/60 Hz
Number of poles	3
Duty time	100 %
Mechanical durability	100000 operations
Electrical durability	50000 operations
Rated impulse withstand voltage $U_{imp}$	6 kV
Rated insulation voltage $U_i$	690 V AC
Rated operational current $I_n$	See ordering details
Rated instantaneous short-circuit current setting $I_{sc}$	See ordering details
Rated service short-circuit breaking capacity $I_{cs}$	See table "Short-circuit breaking capacity and back-up fuses"
Rated ultimate short-circuit breaking capacity $I_{cu}$	See table "Short-circuit breaking capacity and back-up fuses"

### Short-circuit breaking capacity and back-up fuses

$I_{cs}$  Rated service short-circuit breaking capacity

$I_{cu}$  Rated ultimate short-circuit breaking capacity

$I_{cc}$  Prospective short-circuit current at installation location

Note: Maximum rated current of the back-up fuses if  $I_{cc} > I_{cs}$

Type	230 V AC			400 V AC			440 V AC			500 V AC			690 V AC		
	$I_{cs}$ kA	$I_{cu}$ kA	gG, aM A	$I_{cs}$ kA	$I_{cu}$ kA	gG, aM A	$I_{cs}$ kA	$I_{cu}$ kA	gG, aM A	$I_{cs}$ kA	$I_{cu}$ kA	gG, aM A	$I_{cs}$ kA	$I_{cu}$ kA	gG, aM A
MO132-0.16															
MO132-0.25															
MO132-0.4															
MO132-0.63	No back-up fuse required up to $I_{cc} = 100$ kA														
MO132-1.0															
MO132-1.6															
MO132-2.5															
MO132-4.0							20	20	35	20	20	35	3	3	32
MO132-6.3							20	20	63	20	20	63	3	3	50
MO132-10							20	20	100	20	20	100	3	3	50
MO132-12							20	20	100	20	20	100	3	3	63
MO132-16							20	20	125	20	20	125	3	3	63
MO132-20							20	20	125	20	20	125	3	3	80
MO132-25	50	50	125	50	50	125	10	10	125	10	10	125	3	3	100
MO132-32	25	50	125	25	50	125	10	10	125	10	10	125	3	3	100

MO132-20: No need for back-up fuse in networks with a prospective current of up to 100 kA at 400 V.

MO132-32: No need for back-up fuse in networks with a prospective current of up to 50 kA at 400 V.

With an appropriate 125 A type gG fuse the device can be used in a network with a prospective current of up to 100 kA.



# MO132 manual motor starters magnetic only

## Technical data

### General technical data

Type			MO132
Pollution degree			3
Phase loss sensitivity			No
Disconnect function acc. to IEC/EN 60947-2			Yes
Ambient air temperature			
Operation	Open		-25 ... +60 °C
	Enclosed (IB132)		0 ... +40 °C
Storage			-50 ... +80 °C
Ambient air temperature compensation			-
Maximum operating altitude permissible			2000 m
Resistance to shock acc. to IEC 60068-2-27			25 g / 11 ms
Resistance to vibrations acc. to IEC 60068-2-6			5 g / 3 ... 150 Hz
Mounting position			Position 1-6 (optional for single mounting)
Mounting			DIN-rail (EN 60715)
Group mounting			On request
Minimum distance to other units same type	Horizontal		0 mm
	Vertical		150 mm
Minimum distance to electrical conductive board	Horizontal, up to 400 V		0 mm
	Horizontal, up to 690 V		> 1.5 mm
	Vertical		75 mm
Degree of protection	Housing		IP20
	Main circuit terminals		IP20

### Connecting characteristics

Main circuit				
Type		MO132-0.16 ... MO132-10	MO132-12 ... MO132-16	MO132-20 ... MO132-32
Connecting capacity				
 Solid	<b>1 or 2 x</b>	1 ... 4 mm <sup>2</sup>	1 ... 4 mm <sup>2</sup>	2.5 ... 6 mm <sup>2</sup>
 Flexible	<b>1 or 2 x</b>	0.75 ... 2.5 mm <sup>2</sup>	0.75 ... 2.5 mm <sup>2</sup>	1 ... 6 mm <sup>2</sup>
Stripping length		9 mm	10 mm	10 mm
Tightening torques		0.8 ... 1.2 Nm / 10 ... 12 lb.in	1.5 Nm / 14 lb.in	2.0 Nm / 18 lb.in
Connection screw		M3.5 (Pozi driv 2)	M4 (Pozi driv 2)	M4 (Pozi driv 2)



# MO132 manual motor starters magnetic only

## Technical data

### General technical data UL/CSA

Main circuit		
Maximum operational voltage		600 V
Manual motor controller ratings		see table "Manual motor controller for motor disconnect"
Motor ratings	Horse power	see table below
	Full load amps (FLA)	see table below
	Locked rotor amps (LRA)	see table below

2

### Electrical connection

		MO132 ≤ 10 A	MO132-12, -16	MO132-20, -25, -32
Connecting capacity	Stranded	1/2 x AWG 16 ... 12		1/2 x AWG 12 ... 8
	Flexible without ferrule	1/2 x AWG 16 ... 12		1/2 x AWG 12 ... 8
Stripping length		9 mm	10 mm	10 mm
Tightening torque		10 ... 12 lb-in	14 lb-in	18 lb-in
Connection screw		M3.5 (Pozidriv 2)	M4 (Pozidriv 2)	M4 (Pozidriv 2)

### Motor rating, single phase

hp Horse power

FLA Full load amps

LRA Locked rotor amps

Type	220 ... 240 V AC			440 ... 480 V AC		
	hp	FLA	LRA	hp	FLA	LRA
MO132-0.16	-	0.16	0.96	-	0.16	0.96
MO132-0.25	-	0.25	1.5	-	0.25	1.5
MO132-0.4	-	0.4	2.4	-	0.4	2.4
MO132-0.63	-	0.63	3.78	-	0.63	3.78
MO132-1.0	-	1	6	-	1	6
MO132-1.6	1/10	1.6	9.6	-	1.6	9.6
MO132-2.5	1/6	2.5	15	1/2	2.5	15
MO132-4.0	1/3	4	24	1/2	4	24
MO132-6.3	1/2	6.3	37.8	1	6.3	37.8
MO132-10	1-1/2	10	60	3	8.5	46
MO132-12	2	12	72	3	8.5	64
MO132-16	2	12	72	5	14	81
MO132-20	3	17	92	5	14	81
MO132-25	3	17	127	7-1/2	21	116
MO132-32	5	28	162	10	26	145

# MO132 manual motor starters magnetic only

## Technical data

### Motor rating, three phase

hp Horse power

FLA Full load amps

LRA Locked rotor amps

Type	110 ... 120 V AC			220 ... 240 V AC			440 ... 480 V AC			500 ... 600 V AC		
	hp	FLA	LRA	hp	FLA	LRA	hp	FLA	LRA	hp	FLA	LRA
MO132-0.16	-	0.16	0.96	-	0.16	0.96	-	0.16	0.96	-	0.16	0.96
MO132-0.25	-	0.25	1.5	-	0.25	1.5	-	0.25	1.5	-	0.25	1.5
MO132-0.4	-	0.4	2.4	-	0.4	2.4	-	0.4	2.4	-	0.4	2.4
MO132-0.63	-	0.63	3.78	-	0.63	3.78	-	0.63	3.78	-	0.63	3.78
MO132-1.0	-	1	6	-	1	6	-	1	6	1/2	1	6
MO132-1.6	-	1.6	9.6	-	1.6	9.6	3/4	1.6	9.6	3/4	1.6	9.6
MO132-2.5	-	2.5	15	1/2	2.5	15	1	2.5	15	1-1/2	2.5	15
MO132-4.0	-	4	24	1	4	24	2	4	24	3	3.9	26
MO132-6.3	1/2	6.3	37.8	1-1/2	6.3	37.8	3	4.8	32	5	6.1	37
MO132-10	3/4	10	60	3	9.6	64	5	7.6	46	7-1/2	9	51
MO132-12	1-1/2	12	72	3	9.6	64	7-1/2	11	64	10	11	65
MO132-16	2	16	84	5	15.2	92	10	14	81	10	11	65
MO132-20	3	19.2	128	5	15.2	92	10	14	81	15	17	93
MO132-25	3	19.2	128	7-1/2	22	127	15	21	116	20	22	116
MO132-32	5	30.4	184	10	28	162	20	27	145	25	27	146

### Manual motor controller for motor disconnect

Type	Circuit breaker or class R fuse per UL/NEC 480 V / 600 V	Maximum short-circuit current rating	
		480 V	600 V
		kA	kA
MO132-0.16	with minimum interrupting rating of 35,000 rms symmetrical amperes	30	18
MO132-0.25		30	18
MO132-0.4		30	18
MO132-0.63		30	18
MO132-1.0		30	18
MO132-1.6		30	18
MO132-2.5		30	18
MO132-4.0		30	18
MO132-6.3		30	18
MO132-10		30	18
MO132-12		30	18
MO132-16		30	18
MO132-20		30	18
MO132-25		30	18
MO132-32		30	18

# MO132 manual motor starters magnetic only

## Main accessories

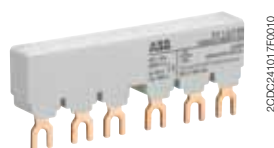

PS1-2-0-65

2CDC24101TF0010



PS1-3-1-100

2CDC241014F0010



S1-M1-25

1SBC10126F0014



S1-M2-25

1SBC10126F0014



SA1

SK0108B91

### Description

Three-phase busbars ensure a quick and safe connection and are therefore a cost effective solution. A variety of different three-phase busbars up to 100 A are in the assortment. Between 2 and 5 manual motor starters with none, one or two lateral auxiliary contacts can be connected. Different three-phase feeder terminals are available according to the application.

### Ordering details

Rated operational current A	Number of MMS	Number of lateral aux.	Type	Order code	Pkg qty	Weight (1 pce) kg
<b>Three-phase busbars</b>						
65	2	0	PS1-2-0-65	1SAM201906R1102	10	0.034
65	3	0	PS1-3-0-65	1SAM201906R1103	10	0.055
65	4	0	PS1-4-0-65	1SAM201906R1104	10	0.077
65	5	0	PS1-5-0-65	1SAM201906R1105	10	0.098
65	2	1	PS1-2-1-65	1SAM201906R1112	10	0.036
65	3	1	PS1-3-1-65	1SAM201906R1113	10	0.060
65	4	1	PS1-4-1-65	1SAM201906R1114	10	0.087
65	5	1	PS1-5-1-65	1SAM201906R1115	10	0.108
65	2	2	PS1-2-2-65	1SAM201906R1122	10	0.040
65	3	2	PS1-3-2-65	1SAM201906R1123	10	0.067
65	4	2	PS1-4-2-65	1SAM201906R1124	10	0.095
65	5	2	PS1-5-2-65	1SAM201906R1125	10	0.122
100	3	0	PS1-3-0-100	1SAM201916R1103	10	0.084
100	4	0	PS1-4-0-100	1SAM201916R1104	10	0.117
100	5	0	PS1-5-0-100	1SAM201916R1105	10	0.154
100	3	1	PS1-3-1-100	1SAM201916R1113	10	0.094
100	4	1	PS1-4-1-100	1SAM201916R1114	10	0.134
100	5	1	PS1-5-1-100	1SAM201916R1115	10	0.172
100	3	2	PS1-3-2-100	1SAM201916R1123	10	0.105

Rated operational current A	Rated cross section mm <sup>2</sup>	Mounting form	Type	Order code	Pkg qty	Weight (1 pce) kg
<b>Three-phase feeder terminals</b>						
65	25	Flat	S1-M1-25	1SAM201907R1101	10	0.038
65	25	High	S1-M2-25	1SAM201907R1102	10	0.051
65	25	UL type E and IEC	S1-M3-25	1SAM201907R1103	10	0.042
100	35	UL type E and IEC	S1-M3-35	1SAM201913R1103	10	0.060

Description	Type	Order code	Pkg qty	Weight (1 pce) kg
Protection cover for busbars	BS1-3	1SAM201908R1001	50	0.003
Padlock + two keys	SA2	GJF1101903R0002	10	0.020
Screw fixing kit	FS116	1SAM201909R1001	1	0.020

# MO132 manual motor starters magnetic only

## Main accessories

2



1SBC101208F0014

HKF1-11



1SBC101209F0014

HK1-11



1SBC101219F0014

SK1-11



1SBC101211F0014

AA1-24



1SBC101212F0014

UA1-24

### Description

MO132 manual motor starters can be equipped with auxiliary contacts for lateral/front mounting, signalling contact for lateral mounting, undervoltage release and shunt trips. The accessories can be fitted wiring free and without tools. A variety of combinations is possible as required for the application. The auxiliary contacts change position with the main contacts. Undervoltage release are used for remote tripping of the manual motor starter especially for emergency stop circuits. Shunt trips release the MMS used for remote tripping.

### Ordering details

Auxiliary contacts N.O.	Auxiliary contacts N.C.	Description	Type	Order code	Pkg qty	Weight (1 pce) kg
-------------------------	-------------------------	-------------	------	------------	---------	-------------------

#### Auxiliary contacts – mountable on the front

1	1		HKF1-11	1SAM201901R1001	10	0.015
2	0		HKF1-20	1SAM201901R1002	10	0.015

#### Auxiliary contacts – mountable on the right

1	1	Max. 2 pieces	HK1-11	1SAM201902R1001	2	0.035
2	0	Max. 2 pieces	HK1-20	1SAM201902R1002	2	0.035
0	2	Max. 2 pieces	HK1-02	1SAM201902R1003	2	0.035
2	0	With lead contacts	HK1-20L	1SAM201902R1004	2	0.035

#### Signalling contacts – mountable on the right

1	1	For tripped alarm, max. 2 pieces	SK1-11	1SAM201903R1001	2	0.035
2	0	For tripped alarm, max. 2 pieces	SK1-20	1SAM201903R1002	2	0.035
0	2	For tripped alarm, max. 2 pieces	SK1-02	1SAM201903R1003	2	0.035

Rated control supply voltage V	Frequency Hz	Type	Order code	Pkg qty	Weight (1 pce) kg
--------------------------------	--------------	------	------------	---------	-------------------

#### Shunt trip units – mountable on the left

20 ... 24	50/60	AA1-24	1SAM201910R1001	1	0.100
110	50/60	AA1-110	1SAM201910R1002	1	0.100
200 ... 240	50/60	AA1-230	1SAM201910R1003	1	0.100
350 ... 415	50/60	AA1-400	1SAM201910R1004	1	0.100

#### Undervoltage releases – mountable on the left

24	50	UA1-24	1SAM201904R1001	1	0.100
48	50	UA1-48	1SAM201904R1002	1	0.100
60	50	UA1-60	1SAM201904R1003	1	0.100
110 ... 120	50/60	UA1-110	1SAM201904R1004	1	0.100
208	60	UA1-208	1SAM201904R1008	1	0.100
230 ... 240	50/60	UA1-230	1SAM201904R1005	1	0.100
400	50	UA1-400	1SAM201904R1006	1	0.100
415 ... 480	50/60	UA1-415	1SAM201904R1007	1	0.100

### Main dimensions mm, inches

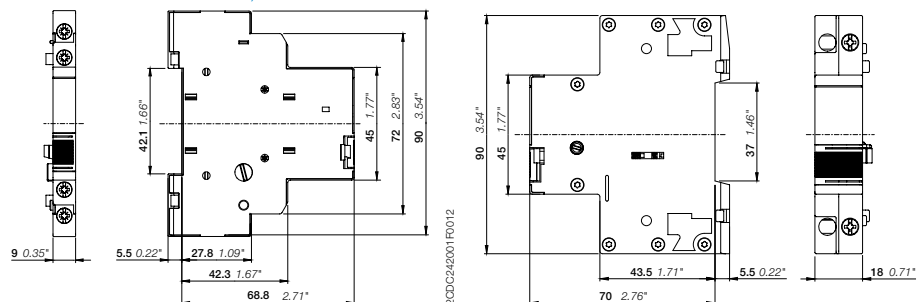

HK1

UA1

# MO132 manual motor starters magnetic only

## Main accessories

### Manual motor starter with three-phase busbar systems

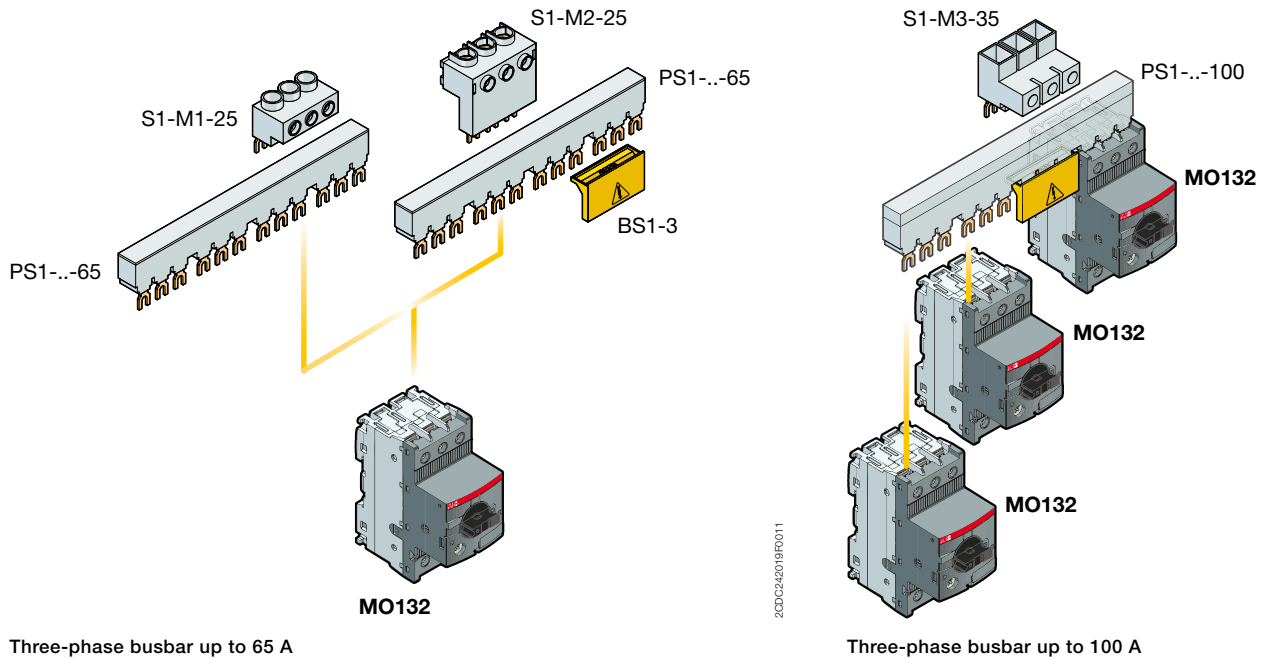

Three-phase busbar up to 65 A

Three-phase busbar up to 100 A

### General technical data

Type	PS1-xxx-65	PS1-xxx-100	S1-Mx-25	S1-Mx-35
Standards	IEC/EN 60947-4-1, IEC/EN 60947-1			
Rated operational voltage $U_n$	690 V			
Rated operational current $I_n$	65 A	100 A	65 A	100 A
Rated frequency	50/60 Hz			
Rated impulse withstand voltage $U_{imp}$	6 kV			
Rated insulation voltage $U_i$	690 V AC			
Pollution degree	3			
Cross-section	10 mm <sup>2</sup>	16 mm <sup>2</sup>	25 mm <sup>2</sup>	35 mm <sup>2</sup>
Ambient air temperature	Operation: -25 ... +70 °C Storage: -50 ... +80 °C			
Resistance to shock acc. to IEC 60068-2-27	25 g / 11 ms			
Resistance to vibrations acc. to IEC 60068-2-6	5 g / 3 ... 150 Hz			

### Electrical connection

#### Main circuit

Type	S1-Mx-25	S1-Mx-35
Connecting capacity		
Solid	1 x 6 ... 25 mm <sup>2</sup>	10 ... 35 mm <sup>2</sup>
Flexible	1 x 6 ... 16 mm <sup>2</sup>	10 ... 35 mm <sup>2</sup>
Stranded acc. to UL/CSA	1 x AWG 10-4	AWG 8-2
Flexible acc. to UL/CSA	1 x AWG 10-6	AWG 8-2
Stripping length	10 mm	12 mm
Tightening torques	2.5 Nm / 22 lb.in	4.5 Nm / 40 lb.in
Connection screw	PZ2 (6 mm)	Hexagon SW4

# MO132 manual motor starters magnetic only

## Main accessories

### Manual motor starter with accessories

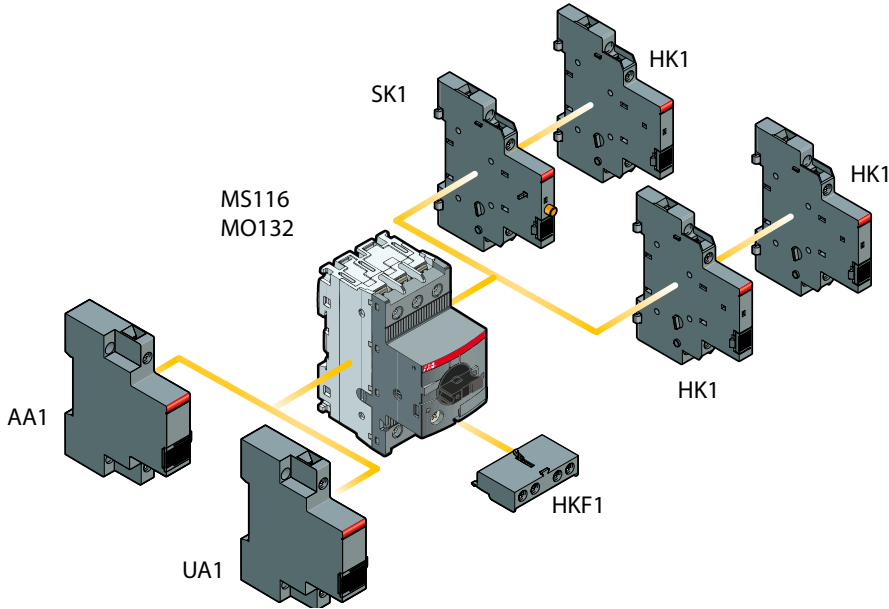

2CDC24601FD013

### General technical data

Type	HK1	SK1	HKF1
Standards	IEC/EN 60947-2, IEC/EN 60947-4-1, IEC/EN 60947-1		
Rated operational voltage $U_n$	690 V AC / 600 DC		250 V AC / 250 V DC
Conventional free-air thermal current $I_{th}$	6 A		5 A
Rated frequency	50/60 Hz		
Rated impulse withstand voltage $U_{imp}$	6 kV		
Rated insulation voltage $U_i$	690 V AC		250 V AC
Pollution degree	3		
Ambient air temperature	Operation	-25 ... +70 °C	
	Storage	-50 ... +80 °C	
Resistance to shock acc. to IEC 60068-2-27	25 g / 11 ms		
Resistance to vibrations acc. to IEC 60068-2-6	5 g / 3 ... 150 Hz		
$I_n$ / Rated operational current AC-15 acc. to IEC/EN 60947-5-1 for utilization category			
	24 V, 120 V	6 A	3 A
	240 V	4 A	1.5 A
	400 V	3 A	-
	440 V, 690 V	1 A	-
$I_n$ / Rated operational current DC-13 acc. to IEC/EN 60947-5-1 for utilization category			
	24 V	2 A	1 A
	125 V	0.55 A	0.27 A
	250 V	0.27 A	0.11 A
	440 V, 600 V	0.15 A	-
Minimum switching capacity	17 V / 5 mA		
Short-circuit protective device	N.C., 95-96	10 A Type gG	
	N.O., 97-98	10 A Type gG	
Duty time	100 %		
Mounting	Right side of MMS		Front of MMS
Mounting positions	1-6		
Mechanical durability	50000 cycles		
Electrical durability	50000 cycles		

2CDC131036C0201





# MO132 manual motor starters magnetic only

## Main accessories

### Electrical connection

#### Main circuit

Type	HK1	SK1	HKF1
<b>Connecting capacity</b>			
 Solid	1 or 2 x	1 ... 1.5 mm <sup>2</sup>	1 ... 2.5 mm <sup>2</sup>
 Flexible	1 or 2 x	0.75 ... 1.5 mm <sup>2</sup>	
Stranded acc. to UL/CSA	1 or 2 x	AWG 16-14	
Flexible acc. to UL/CSA	1 or 2 x	AWG 16-14	
<b>Stripping length</b>	8 mm		
<b>Tightening torques</b>	0.8 ... 1.2 Nm / 7 lb.in		
<b>Connection screw</b>	M3 (Pozidriv 2)		

# MO132 manual motor starters magnetic only

## Main accessories

2



2CDC241004F0010

IB132-Y



2CDC241003F0010

IB132-G



2CDC241002F0010

DMS132-Y



2CDC241001F0010

DMS132-G

### Description

IB132 are IP65 enclosures for single MMS installation. Additional mounting of auxiliary and signalling contacts, shunt trips and undervoltage release is possible. The handle is lockable in OFF position. For detailed specification see installation instruction.

DMS132 are IP65 door mounting kits for MMS installation in any enclosure. Additional mounting of auxiliary, signalling, shunt trips and undervoltage release is possible. The handle is lockable in OFF position. For detailed specification see installation instruction.

### Ordering details

Description	Color	Type	Order code	Pkg qty	Weight (1 pce) kg
<b>Enclosures IP65</b>					
Padlockable max. 3 padlocks with bail diameter 4 ... 6.5 mm	Yellow/red	IB132-Y	1SAM201911R1011	1	0.370
	Grey/black	IB132-G	1SAM201911R1010	1	0.370
<b>Door mounting kit IP65</b>					
Padlockable max. 3 padlocks with bail diameter 4 ... 6.5 mm	Yellow/red	DMS132-Y	1SAM201912R1011	1	0.170
	Grey/black	DMS132-G	1SAM201912R1010	1	0.170

Indication I-O-T and ON-OFF-T

### Main dimensions mm, inches

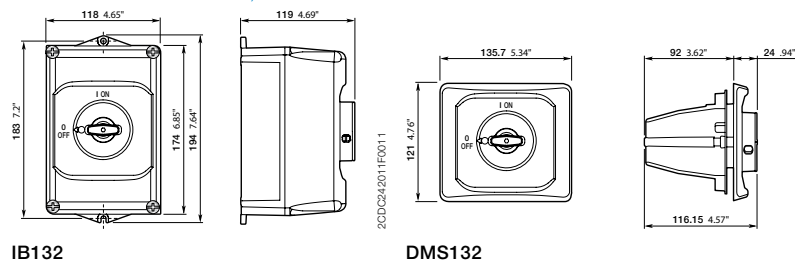

# MO132 manual motor starters magnetic only

## Main accessories



MSHD-LTB

2CDC241004F0011



MSHD-LTY

2CDC241006F0011



MSMN

2CDC241004F0011



MSOX-30

2CDC241005F0011



MSH-AR

2CDC241001F0012

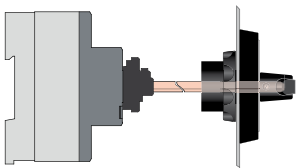

Shaft alignment ring

2CDC242003F0012

### Description

The complete set includes handle, shaft and driver. All accessories fit 6 mm shafts of maximum 180 mm length. The degree of protection for handles MSHD is IP64.

### Ordering details

Description	Shaft length mm	Type	Order code	Pkg qty	Weight (1 pce) kg
-------------	--------------------	------	------------	------------	-------------------------

#### Shafts

For selector type handles. Shaft diameter 6 mm. Shaft extension for door coupling driver.

85	OXS6X85	1SCA101647R1001	1	0.020
105	OXS6X105	1SCA108043R1001	1	0.020
130	OXS6X130	1SCA101655R1001	1	0.030
180	OXS6X180	1SCA101659R1001	1	0.040

Description	Color mm	Type	Order code	Pkg qty	Weight (1 pce) kg
-------------	-------------	------	------------	------------	-------------------------

#### Selector type handles IP64

Padlockable max. 3 padlocks with bail diameter 5 ... 8 mm, door interlock in ON position defeatable, for use with 6 mm OXS6...types up to 180 mm or driver shafts MSOX.

Black	MSHD-LTB <sup>1)</sup>	1SAM201920R1011	1	0.065
Yellow	MSHD-LTY <sup>1)</sup>	1SAM201920R1012	1	0.065

<sup>1)</sup> Indication I-O-T and ON-OFF-T

Description	Type	Order code	Pkg qty	Weight (1 pce) kg
-------------	------	------------	------------	-------------------------

#### Driver

Coupling driver for use with 6 mm OXS6... types up to 180 mm.

MSMN <sup>1)</sup>	1SAM101923R0002	1	0.002
MSMNO <sup>2)</sup>	1SAM101923R0012	1	0.002

<sup>1)</sup> Coded - Positioning of ON indication dependent from mounting orientation of the MS

<sup>2)</sup> Uncoded - Positioning of ON indication independent from mounting orientation of the MS

Description	Shaft length mm	Type	Order code	Pkg qty	Weight (1 pce) kg
-------------	--------------------	------	------------	------------	-------------------------

#### Driver shafts

Driver shaft - combination driver & shaft. Shaft diameter 6 mm.

32	MSOX-32 <sup>1)</sup>	1SAM101924R0003	1	0.010
30	MSOX-30 <sup>2)</sup>	1SAM101924R0013	1	0.010

<sup>1)</sup> MSOX-32 is for normal vertical use

<sup>2)</sup> MSOX-30 is for horizontal use

Description	Type	Order code	Pkg qty	Weight (1 pce) kg
-------------	------	------------	------------	-------------------------

#### Shaft alignment ring

The MSH-AR supports the long axis for alignment to the handle inlet. It makes closing panel doors more easy.

MSH-AR	1SAM201920R1000	1	0.010
--------	-----------------	---	-------

# MS450, MS495, MS497 manual motor starters

## 22 to 100 A – with thermal and electromagnetic protection

2



2CDC241004F0009

MS450-40



1SBC101184F0014

MS495-40



2CDC241020F0011

MS497-100

### Description

Manual motor starters (MMS) are protection devices for the main circuit. They combine motor control and protection in a single device. MMS are used mainly to switch motors manually ON/OFF and protect them and the installation fuse less against short-circuit, overload and phase failures. Fuse less protection with a manual motor starter saves costs, space and ensures a quick reaction under short-circuit condition, by switching off the motor within milliseconds.

Further features are the build-in disconnect function, temperature compensation, trip-free mechanism and a rotary handle with a clear switch position indication. The manual motor starter is suitable for three- and single-phase applications. The handle is lockable to protect against unauthorized changes. Auxiliary contacts, signalling contacts, undervoltage releases, shunt trips, three-phase busbars, power in-feed blocks are available as accessory.

### Ordering details

Rated operational power 400 V AC-3 kW	Setting range A	Short-circuit breaking capacity $I_{CS}$ at 400 V AC kA	Rated instantaneous short-circuit current setting $I_i$ A	Type	Order code	Weight (1 pce) kg
<b>MS450 manual motor starter</b>						
15.8	28.0 ... 40.0	25	520.00	MS450-40	1SAM450000R1005	1.047
22	36.0 ... 45.0	25	585.00	MS450-45	1SAM450000R1006	1.039
22	40.0 ... 50.0	25	650.00	MS450-50	1SAM450000R1007	1.027
<b>MS495 manual motor starter</b>						
30	45.0 ... 63.0	25	819.00	MS495-63	1SAM550000R1007	2.247
37	57.0 ... 75.0	25	975.00	MS495-75	1SAM550000R1008	2.253
45	70.0 ... 90.0	25	1170.00	MS495-90	1SAM550000R1009	2.280
55	80.0 ... 100.0	25	1235.00	MS495-100	1SAM550000R1010	2.295
<b>MS497 manual motor starter</b>						
15	22.0 ... 32.0	50	416.00	MS497-32	1SAM580000R1004	2.222
18.5	28.0 ... 40.0	50	520.00	MS497-40	1SAM580000R1005	2.203
22	36.0 ... 50.0	50	650.00	MS497-50	1SAM580000R1006	2.230
30	45.0 ... 63.0	50	819.00	MS497-63	1SAM580000R1007	2.255
37	57.0 ... 75.0	50	975.00	MS497-75	1SAM580000R1008	2.266
45	70.0 ... 90.0	50	1170.00	MS497-90	1SAM580000R1009	2.268
55	80.0 ... 100.0	50	1235.00	MS497-100	1SAM580000R1010	2.275

### Main dimensions mm, inches

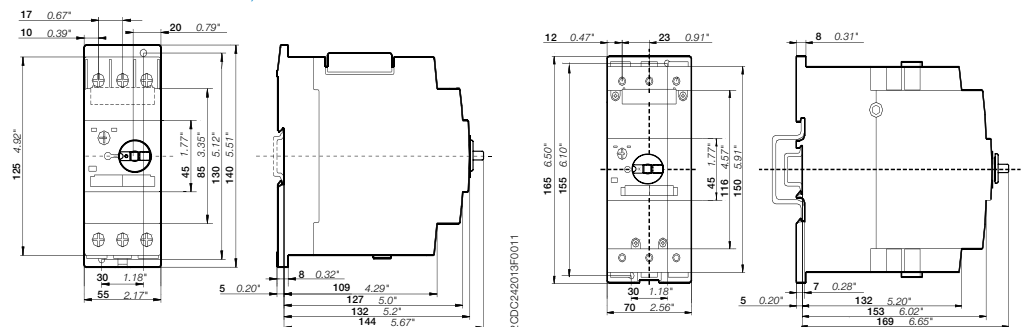

MS450

MS495, MS497

# MS450, MS495, MS497 manual motor starters

## Technical data

### Main circuit – Utilization characteristics according to IEC/EN

Type	MS450, MS495, MS497
Standards	IEC/EN 60947-2, IEC/EN 60947-4-1, IEC/EN 60947-1
Rated operational voltage U <sub>e</sub>	690 V AC / 450 V DC
Rated frequency	50/60 Hz
Trip class	10
Number of poles	3
Duty time	100 %
Mechanical durability	50000 operations
Electrical durability	25000 operations
Rated impulse withstand voltage U <sub>imp</sub>	6 kV
Rated insulation voltage U <sub>i</sub>	690 V AC
Rated operational current I <sub>e</sub>	See ordering details
Rated instantaneous short-circuit current setting I <sub>cc</sub>	See ordering details
Rated service short-circuit breaking capacity I <sub>cs</sub>	See table "Short-circuit breaking capacity and back-up fuses"
Rated ultimate short-circuit breaking capacity I <sub>cu</sub>	See table "Short-circuit breaking capacity and back-up fuses"

### Short-circuit breaking capacity and back-up fuses

I<sub>cs</sub> Rated service short-circuit breaking capacity

I<sub>cu</sub> Rated ultimate short-circuit breaking capacity

I<sub>cc</sub> Prospective short-circuit current at installation location

Note: Maximum rated current of the back-up fuses if I<sub>cc</sub> > I<sub>cs</sub>

Type	240 V AC			400 V AC			440 V AC			500 V AC			690 V AC		
	I <sub>cs</sub> kA	I <sub>cu</sub> kA	gG, aM A	I <sub>cs</sub> kA	I <sub>cu</sub> kA	gG, aM A	I <sub>cs</sub> kA	I <sub>cu</sub> kA	gG, aM A	I <sub>cs</sub> kA	I <sub>cu</sub> kA	gG, aM A	I <sub>cs</sub> kA	I <sub>cu</sub> kA	gG, aM A

#### Short-circuit protection MS450

MS450-40	No back-up fuse required up to I <sub>cc</sub> = 100 kA	25	50	160	15	50	125	5	10	100	2	4	63
MS450-45		25	50	160	15	50	125	5	10	100	2	4	63
MS450-50		25	50	160	15	50	125	5	10	100	2	4	80

MS450: No need for back-up fuse in networks with a prospective current of up to 50 kA at 400 V.  
With an appropriate 160 A type gG fuse the device can be used in a network with a prospective current of up to 100 kA.

#### Short-circuit protection MS495

MS495-40	No back-up fuse required up to I <sub>cc</sub> = 100 kA	25	50	125	20	50	125	6	12	125	3	6	63
MS495-50		25	50	125	20	50	125	6	12	125	3	6	80
MS495-63		25	50	160	20	50	160	6	12	160	3	6	80
MS495-75		25	50	160	20	50	160	6	8	160	3	5	100
MS495-90		25	50	160	20	50	160	6	8	160	3	5	125
MS495-100		25	50	160	20	50	160	6	8	160	3	5	125

MS495-40: No need for back-up fuse in networks with a prospective current of up to 50 kA at 400 V.  
With an appropriate 125 A type gG fuse the device can be used in a network with a prospective current of up to 100 kA.  
MS495-100: No need for back-up fuse in networks with a prospective current of up to 50 kA at 400 V.  
With an appropriate 160 A type gG fuse the device can be used in a network with a prospective current of up to 100 kA.

#### Short-circuit protection MS497

MS497-32	No back-up fuse required up to I <sub>cc</sub> = 100 kA	50	100	No back-up fuse required up to I <sub>cc</sub> = 100 kA	50	100	No back-up fuse required up to I <sub>cc</sub> = 100 kA	11	22	100	7	12	63	
MS497-40		50	100		50	100		9	18	160	6	12	80	
MS497-50		50	100		50	100		7.5	15	160	5	10	100	
MS497-63		50	100		50	70		200	7.5	15	160	4	7.5	100
MS497-75		50	100		50	70		200	5	10	160	3	6	125
MS497-90		50	100		50	70		200	5	10	160	3	6	160
MS497-100		50	100		50	70		200	5	10	160	3	6	160

MS497-32: No need for back-up fuse in networks with a prospective current of up to 100 kA at 440 V.  
MS497-90: No need for back-up fuse in networks with a prospective current of up to 70 kA at 440 V.  
With an appropriate 200 A type gG fuse the device can be used in a network with a prospective current of up to 100 kA.

# MS450, MS495, MS497 manual motor starters

## Technical data

### General technical data

Type		MS450	MS495	MS497
Pollution degree		3		
Phase loss sensitivity		Yes		
Disconnect function acc. to IEC/EN 60947-2		Yes		
Ambient air temperature				
Operation	Open - compensated	-20 ... +60 °C		
	Open	-20 ... +70 °C		
	Enclosed	-20 ... +35 °C		
Storage		-50 ... +80 °C		
Ambient air temperature compensation		Acc. to IEC/EN60947-4-1		
Maximum operating altitude permissible		2000 m		
Resistance to shock acc. to IEC 60068-2-27		25 g / 11 ms	-	
Resistance to vibrations acc. to IEC 60068-2-6		2 g / 5-150 Hz		
Mounting position		Position 1-6 (optional for single mounting)		
Mounting		DIN-rail 35 mm (EN 60715)	DIN-rail 15 mm / 75 mm (EN 60715)	
Minimum distance to other units same type	Horizontal	0 mm	0 mm	
	Vertical - up to 240 V	-	50 mm	
	Vertical - up to 440 V	-	70 mm	
	Vertical - up to 500 V	-	110 mm	
	Vertical - up to 690 V	-	150 mm	
	Vertical	50 mm	-	
Minimum distance to electrical conductive board	Horizontal	10 mm	-	
	Horizontal - up to 500 V	-	10 mm	
	Horizontal - up to 690 V	-	30 mm	
	Vertical - up to 240 V	-	50 mm	
	Vertical - up to 440 V	-	70 mm	
	Vertical - up to 500 V	-	110 mm	
	Vertical - up to 690 V	-	150 mm	
	Vertical	50 mm	-	
Degree of protection	Housing	IP20		
	Main circuit terminals	IP00		

### Connecting characteristics

Main circuit					
Type		MS450	MS495	MS497	
Connecting capacity	 Solid	<b>1 or 2 x</b>	0.75 ... 16 mm <sup>2</sup>	2.5 ... 16 mm <sup>2</sup>	2.5 ... 16 mm <sup>2</sup>
		<b>1 x</b>	0.75 ... 35 mm <sup>2</sup>	10 ... 70 mm <sup>2</sup>	10 ... 70 mm <sup>2</sup>
	<b>2 x</b>		0.75 ... 25 mm <sup>2</sup>	10 ... 50 mm <sup>2</sup>	10 ... 50 mm <sup>2</sup>
	Stranded acc. to UL/CSA	<b>1 x</b>	AWG 18-2	AWG 10-2/0	AWG 10-2/0
		<b>2 x</b>	AWG 18-2	AWG 10-1/0	AWG 10-1/0
	Flexible acc. to UL/CSA	<b>1 x</b>	AWG 18-2	AWG 10-2/0	AWG 10-2/0
<b>2 x</b>		AWG 18-2	AWG 10-1/0	AWG 10-1/0	
Stripping length		13 mm	17 mm	17 mm	
Tightening torques		3 - 4.5 Nm / 27 ... 40 lb.in	4 - 6 Nm / 35 - 53 lb.in	4 - 6 Nm / 35 - 53 lb.in	
Connection screw		Pozidriv 2	Hexagon 4	Hexagon 4	



# MS450, MS495, MS497 manual motor starters

## Technical data

### Main circuit – Utilization characteristics according to UL/CSA

Type	MS450, MS495, MS497	
Standards	UL 508, CSA 22.2 No. 14	
Maximum operational voltage	600 V AC	
Manual motor controller ratings	See table "UL 508 – Manual motor controller"	
Trip rating	125 % FLA	
Motor ratings	Horse power	See table "Motor rating, three phase"
	Full load amps (FLA)	See table "Motor rating, three phase"
	Locked rotor amps (LRA)	See table "Motor rating, three phase"

### Motor rating, three phase

hp Horse power

FLA Full load amps

LRA Locked rotor amps

Type	General purpose rating at max. 600 V AC	Full load amps	200 - 208 V AC	230 V AC	460 V AC	575 V AC
	A	FLA	hp	hp	hp	hp
MS450-40	40	40	10	15	30	40
MS450-45	45	45	15	15	30	40
MS450-50	50	50	15	20	40	50
MS495-63	63	63	20	25	50	60
MS495-75	75	75	25	25	60	75
MS495-90	90	90	30	30	75	100
MS495-100	100	100	40	40	75	100
MS497-32	32	32	10	10	25	30
MS497-40	40	40	15	15	30	40
MS497-50	50	50	15	20	40	50
MS497-63	63	63	20	25	50	60
MS497-75	75	75	25	25	60	75
MS497-90	90	90	30	30	75	100
MS497-100	100	100	30	40	75	100

### UL 508 – Manual motor controller

Type	Circuit breaker or class R fuse per UL/NEC	Max. circuit breaker or fuse per UL/NEC	Maximum short-circuit current									
			for motor disconnect		for group installation		for tap conductor	for protection	UL 508			
			480/600 V A	480/600 V A	480 V kA	600 V kA	480 V kA	600 V kA	480Y/277V kA	600Y/347V kA	Type E * 480Y/277V	Type E 600Y/347V
MS450-40	150	350	65	25	65	25	65	25	65	25	65	25
MS450-45	175	350	65	25	65	25	65	25	65	25	65	25
MS450-50	200	350	65	25	65	25	65	25	65	25	65	25
MS495-63	250	500	65	30	65	30	65	30	65	30	65	30
MS495-75	300	500	65	30	65	30	65	30	65	30	65	30
MS495-90	350	500	65	10	65	10	65	-	65	-	65	-
MS495-100	400	500	65	10	65	10	65	-	65	-	65	-
MS497-32	120	500	65	30	65	30	65	30	65	30	65	30
MS497-40	160	500	65	30	65	30	65	30	65	30	65	30
MS497-50	200	500	65	30	65	30	65	30	65	30	65	30
MS497-63	250	500	65	30	65	30	65	30	65	30	65	30
MS497-75	300	500	65	30	65	30	65	30	65	30	65	30
MS497-90	350	500	65	10	65	10	-	-	65	-	65	-
MS497-100	400	500	65	10	65	10	-	-	65	-	65	-

\* only with use DX495

# MS450, MS495, MS497 manual motor starters

## Main accessories

2



SA2

SK0109B91



PS4-2-0

2CDC241003F0012



PS4-3-0

2CDC241004F0012



PS4-4-0

2CDC241005F0012

### Description

Three-phase busbars ensure a quick and safe connection and are therefore a cost effective solution. A variety of different three-phase busbars up to 108A are in the assortment. Between 2 and 4 manual motor starter with none or two lateral auxiliary contacts can be connected.

### Ordering details

Rated operational current A	Number of MMS	Number of lateral aux.	Type	Order code	Pkg qty	Weight (1 pce) kg
<b>Three-phase busbars for MS450 only</b>						
108 A	2	0	PS4-2-0	1SAM401911R1001	5	0.134
108 A	3	0	PS4-3-0	1SAM401911R1002	5	0.206
108 A	4	0	PS4-4-0	1SAM401911R1003	5	0.280
108 A	2	1	PS4-2-2	1SAM401911R1004	5	0.148
108 A	3	1	PS4-3-2	1SAM401911R1005	5	0.250
108 A	4	1	PS4-4-2	1SAM401911R1006	5	0.362

Rated operational current A	Rated cross section mm <sup>2</sup>	Mounting form	Type	Order code	Pkg qty	Weight (1 pce) kg
<b>Three-phase feeder terminals for MS450 only</b>						
108 A	25	Flat	S4-M1	1SAM401911R1007	2	0.106

Description	For MMS	Type	Order code	Pkg qty	Weight (1 pce) kg
Protection cover for busbar	PS4	BS4-3	1SAM401911R1008	10	0.001
Disconnecter module	MS450	TB450	1SAM401910R1001	1	0.315
Terminal shroud	MS450	KA450	1SAM401908R1001	1	0.154
Terminal shroud	MS495	KA495	1SAM501901R1001	10	0.018
Terminal shroud	MS495	KA495C <sup>1)</sup>	1SAM501902R1001	10	0.038
Terminal insulation barrier for UL508E	MS495	DX495	1SAM401912R1001	1	0.154
Padlock + 2 keys	MS450, MS495, MS497	SA2	GJF1101903R0002	10	0.020

<sup>1)</sup> Is plugged onto the housing after removing the box terminals, if using cable lugs.

# MS450, MS495, MS497 manual motor starters

## Main accessories



2CDC24102BF0011

HK4-11



2CDC24102ZF0011

HKS4-20



2CDC241024F0011

SK4-11



2CDC241023F0011

AA4-24



2CDC241025F0011

UA4-110

### Description

MS450, MS495, MS497 manual motor starters can be equipped with auxiliary contacts for lateral/front mounting, signalling contact for lateral mounting, undervoltage release and shunt trips. The accessories can be fitted wiring free and without tools. A variety of combinations is possible as required for the application. The auxiliary contacts change position with the main contacts. Undervoltage release are used for remote tripping of the manual motor starter especially for emergency stop circuits. Shunt trips release the MMS used for remote tripping.

### Ordering details

Auxiliary contacts: N.O.	Auxiliary contacts: N.C.	Description	Type	Order code	Pkg qty	Weight (1 pce) kg
<b>Auxiliary contacts – mountable on the front</b>						
1	1		HK4-11	1SAM401901R1001	10	0.017
		Changeover	HK4-W	1SAM401901R1002	10	0.015
<b>Auxiliary contacts – mountable on the left</b>						
1	1	Max. 1 pieces	HKS4-11	1SAM401902R1001	2	0.045
2	0	Max. 1 pieces	HKS4-20	1SAM401902R1002	2	0.045
0	2	Max. 1 pieces	HKS4-02	1SAM401902R1003	2	0.045
<b>Signalling contacts – mountable on the right</b>						
2	2	Separate signalling acc. UL508E 1 N.O. + 1 N.C. for short circuit and 1NO+NC for general tripping , max. 2 pieces	SK4-11	1SAM401904R1001	1	0.093

Rated control supply voltage	Frequency	Type	Order code	Pkg qty	Weight (1 pce) kg
V	Hz				
<b>Shunt trip units – mountable on the left</b>					
20 ... 24	50/60	AA4-24	1SAM401907R1001	1	0.135
90 ... 110	50/60	AA4-110	1SAM401907R1002	1	0.135
200 ... 240	50/60	AA4-230	1SAM401907R1003	1	0.128
350 ... 415	50/60	AA4-400	1SAM401907R1004	1	0.125
<b>Undervoltage releases – mountable on the left</b>					
24	50/60	UA4-24	1SAM401905R1004	1	0.134
110/120	50/60	UA4-110	1SAM401905R1001	1	0.134
230/240	50/60	UA4-230	1SAM401905R1002	1	0.131
400/440	50/60	UA4-400	1SAM401905R1003	1	0.129
230/240	50/60	UA4-HK-230	1SAM401906R1001	1	0.140
400/440	50/60	UA4-HK-400	1SAM401906R1002	1	0.137

# MS450, MS495, MS497 manual motor starters

## Main accessories

### Manual motor starters MS45x and MS49x with accessories

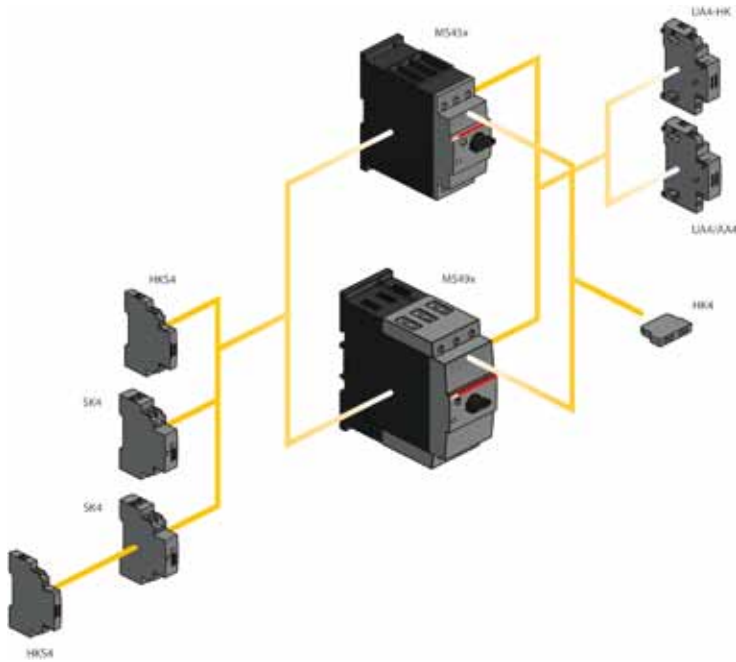

2CDC42025F0011

### General technical data

Type	HK4-11	HK4-W	HKS4	SK4
Standards	IEC/EN 60947-1, IEC/EN 60947-5-1, UL 508, CSA22.2 No. 14			
Rated operational voltage $U_n$	230 V AC / 220 V DC	690 V AC / 220 V DC	690 V AC	690 V AC
Conventional free-air thermal current $I_{th}$	2.5 A	5 A	10 A	10 A
Rated frequency	DC, 50/60 Hz			
Rated impulse withstand voltage $U_{imp}$	6 kV			
Rated insulation voltage $U_i$	300 V	300 V	690 V	690 V
Pollution degree	3			
Ambient air temperature	Operation: -20 ... +70 °C Storage: -50 ... +80 °C			
Resistance to shock acc. to IEC 60068-2-27	25 g / 11 ms			
Resistance to vibrations acc. to IEC 60068-2-6	2 g / 5 ... 150Hz			
Number of poles	1 N.C. + 1 N.O.	Changeover	1 N.C. + 1 N.O. / 2 N.O. / 2 N.C.	2 N.C. + 2 N.O.
$I_n$ / Rated operational current AC-15 acc. to IEC/EN 60947-5-1 for utilization category				
	24 V 2 A	4 A	6 A	6 A
	230 V 0.5 A	3 A	4 A	4 A
	400 V -	1.5 A	3 A	3 A
	690 V -	0.5 A	1 A	1 A
$I_n$ / Rated operational current DC-13 acc. to IEC/EN 60947-5-1 for utilization category				
	24 V 1 A	1 A	2 A	2 A
	48 V 0.3 A	-	-	-
	60 V 0.15 A	-	-	-
	110 V -	0.22 A	0.5 A	0.5 A
	230 V -	0.1 A	0.25 A	0.25 A
Minimum switching capacity	17 V / 1 mA			
Short-circuit protective device	10 A Type gG			
Duty time	100 %			
Mounting	Front of MMS	Front of MMS	Left side of MMS	Left side of MMS
Mounting positions	1-6			
Mechanical durability	100000 cycles			
Electrical durability	100000 cycles			

2CDC131042C0201

# MS450, MS495, MS497 manual motor starters

## Main accessories



2

Type	PS4-xxx		S4-M1
Standards	IEC/EN 60947-1		
Rated operational voltage U <sub>e</sub>	690 V AC		
Rated operational current I <sub>e</sub>	108 A		
Rated frequency	50/60 Hz		
Rated impulse withstand voltage U <sub>imp</sub>	6 kV		
Rated insulation voltage U <sub>i</sub>	690 V AC		
Pollution degree	3		
Cross-section	10 mm <sup>2</sup>	25 mm <sup>2</sup>	
Ambient air temperature	Operation	-25 ... +70 °C	
	Storage	-50 ... +80 °C	



Type	UA4-xxx	AA4-xxx
Power consumption		
Pull-in	AC 20.2/13 VA/W DC 20 W	20.2/13 VA/W 13 ... 80 W
Holding	AC 7.2/2.4 VA/W DC 2.1 W	- -
Operating voltage		
Tripping	0.35 ... 0.7 V x U <sub>s</sub>	0.7 ... 1.1 V x U <sub>s</sub>
Coil operating voltage	0.85 ... 1.1 V x U <sub>s</sub>	-

### Electrical connection

#### Main circuit

Type	HK4-11	HK4-W	HKS4	SK4
Connecting capacity				
 Solid	1 x 0.5... 2.5 mm <sup>2</sup> 2 x 0.5 ... 1.5 mm <sup>2</sup> or 0.75 ... 2.5 mm			
 Flexible	1 x 0.5 ... 2.5 mm <sup>2</sup> 2 x 0.5 ... 1.5 mm <sup>2</sup> or 0.75 ... 2.5 mm			
Stranded acc. to UL/CSA	1 or 2 x AWG 18-14			
Flexible acc. to UL/CSA	1 or 2 x AWG 18-14			
Stripping length	10 mm			
Tightening torques	0.8 ... 1.2 Nm / 7 ... 10.3 lb.in			
Connection screw	Pozidriv 2			

#### Main circuit

Type	S4-M1
Connecting capacity	
 Solid	1 x 2.5 ... 50 mm <sup>2</sup>
 Flexible	1 x 4 ... 16 mm <sup>2</sup>
Stranded acc. to UL/CSA	1 x AWG 14-4
Flexible acc. to UL/CSA	1 x AWG 14-4
Tightening torques	4 Nm
Connection screw	Pozidriv 2

# MS450, MS495, MS497 manual motor starters

## Main accessories

2



2CDC241007F0011

MSHD-LTB



2CDC241008F0011

MSHD-LTY



2CDC241004F0011

MSMN



2CDC241001F0012

MSH-AR

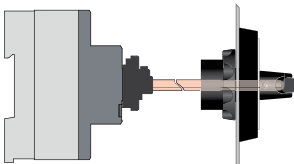

2CDC240203F0012

Shaft alignment ring

### Description

The complete set includes handle, shaft and driver. All accessories fit 6 mm shafts of maximum 180 mm length. The degree of protection for handles MSHD is IP64.

### Ordering details

Description	Shaft length mm	Type	Order code	Pkg qty	Weight (1 pce) kg
-------------	--------------------	------	------------	------------	-------------------------

#### Shafts

For selector type handles. Shaft diameter 6 mm. Shaft extension for door coupling driver.

85	OXS6X85	1SCA101647R1001	1	0.020
105	OXS6X105	1SCA108043R1001	1	0.020
130	OXS6X130	1SCA101655R1001	1	0.030
180	OXS6X180	1SCA101659R1001	1	0.040

Description	Color mm	Type	Order code	Pkg qty	Weight (1 pce) kg
-------------	-------------	------	------------	------------	-------------------------

#### Selector type handles IP64

Padlockable max. 3 padlocks with bail diameter 5 ... 8 mm, door interlock in ON position defeatable, for use with 6 mm OXS6...types up to 180 mm or driver shafts MSOX.

Black	MSHD-LTB <sup>1)</sup>	1SAM201920R1011	1	0.065
Yellow	MSHD-LTY <sup>1)</sup>	1SAM201920R1012	1	0.065

<sup>1)</sup> Indication I-O-T and ON-OFF-T

Description	Type	Order code	Pkg qty	Weight (1 pce) kg
-------------	------	------------	------------	-------------------------

#### Driver

Coupling driver for use with 6 mm OXS6... types up to 180 mm.

MSMN <sup>1)</sup>	1SAM101923R0002	1	0.002
MSMNO <sup>2)</sup>	1SAM101923R0012	1	0.002

<sup>1)</sup> Coded - Positioning of ON indication dependent from mounting orientation of the MS

<sup>2)</sup> Uncoded - Positioning of ON indication independent from mounting orientation of the MS

Description	Type	Order code	Pkg qty	Weight (1 pce) kg
-------------	------	------------	------------	-------------------------

#### Shaft alignment ring

The MSH-AR supports the long axis for alignment to the handle inlet. It makes closing panel doors more easy.

MSH-AR	1SAM201920R1000	1	0.010
--------	-----------------	---	-------

# MO450, MO495, MO496 manual motor starters magnetic only 16 to 100 A – with electromagnetic protection



5T028501

MO450-40



5T028501

MO495-75



2CDC241021F0011

MO496-100

## Description

The manual motor starter magnetic only is used to manually switch on and off motors and to protect them reliably and without the need for a fuse from short-circuits.

Further features are the build-in disconnect function, trip-free mechanism and a rotary handle with a clear switch position indication. The manual motor starter magnetic only is suitable for three- and single-phase applications. The handle is lockable to protect against unauthorized changes. Auxiliary contacts, signalling contacts, undervoltage releases, shunt trips, three-phase busbars, power in-feed blocks are available as accessory.

## Ordering details

Rated operational power 400 V AC-3 <sup>1)</sup> kW	Rated operational current A	Short-circuit breaking capacity I <sub>CS</sub> at 400 V AC kA	Rated instantaneous short-circuit current setting I <sub>i</sub> A	Type	Order code	Weight (1 pce) kg
<b>MO450 manual motor starter magnetic only</b>						
15.8	40	25	520.00	MO450-40	1SAM460000R1005	1.033
22	45	25	585.00	MO450-45	1SAM460000R1006	1.040
22	50	25	650.00	MO450-50	1SAM460000R1007	1.019
<b>MO495 manual motor starter magnetic only</b>						
30	63	25	819.00	MO495-63	1SAM560000R1007	2.244
37	75	25	975.00	MO495-75	1SAM560000R1008	2.247
45	90	25	1170.00	MO495-90	1SAM560000R1009	2.269
55	100	25	1235.00	MO495-100	1SAM560000R1010	2.292
<b>MO496 manual motor starter magnetic only</b>						
15	32	50	416.00	MO496-32	1SAM590000R1004	2.208
18.5	40	50	520.00	MO496-40	1SAM590000R1005	2.218
22	50	50	650.00	MO496-50	1SAM590000R1006	2.218
30	63	50	819.00	MO496-63	1SAM590000R1007	2.248
37	75	50	975.00	MO496-75	1SAM590000R1008	2.278
45	90	50	1170.00	MO496-90	1SAM590000R1009	2.266
55	100	50	1235.00	MO496-100	1SAM590000R1010	2.293

<sup>1)</sup> For overload protection of motors, an appropriate thermal or electronic overload relay must be used

## Main dimensions mm, inches

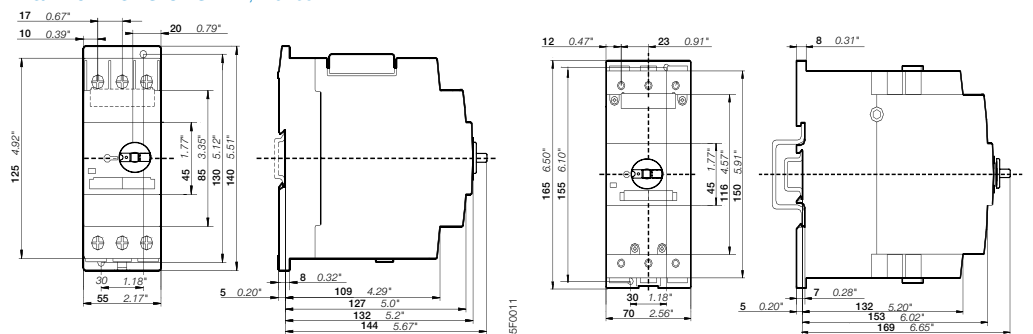

MO450

MO495, MO496



# MO450, MO495, MO496 manual motor starters magnetic only

## Technical data

### Main circuit – Utilization characteristics according to IEC/EN

Type	MO450, MO495, MO496
Standards	IEC/EN 60947-2, IEC/EN 60947-4-1, IEC/EN 60947-1
Rated operational voltage $U_n$	690 V AC / 450 V DC
Rated frequency	50/60 Hz
Number of poles	3
Duty time	100 %
Mechanical durability	50000 operations
Electrical durability	25000 operations
Rated impulse withstand voltage $U_{imp}$	6 kV
Rated insulation voltage $U_i$	690 V AC
Rated operational current $I_n$	See ordering details
Rated instantaneous short-circuit current setting $I_{cc}$	See ordering details
Rated service short-circuit breaking capacity $I_{cs}$	See table "Short-circuit breaking capacity and back-up fuses"
Rated ultimate short-circuit breaking capacity $I_{cu}$	See table "Short-circuit breaking capacity and back-up fuses"

### Short-circuit breaking capacity and back-up fuses

$I_{cs}$  Rated service short-circuit breaking capacity

$I_{cu}$  Rated ultimate short-circuit breaking capacity

$I_{cc}$  Prospective short-circuit current at installation location

Note: Maximum rated current of the back-up fuses if  $I_{cc} > I_{cs}$

Type	240 V AC			400 V AC			440 V AC			500 V AC			690 V AC		
	$I_{cs}$ kA	$I_{cu}$ kA	gG, aM A	$I_{cs}$ kA	$I_{cu}$ kA	gG, aM A	$I_{cs}$ kA	$I_{cu}$ kA	gG, aM A	$I_{cs}$ kA	$I_{cu}$ kA	gG, aM A	$I_{cs}$ kA	$I_{cu}$ kA	gG, aM A

#### Short-circuit protection MO450

MO450-40	No back-up fuse required up to $I_{cc} = 100$ kA	25	50	160	15	50	125	5	10	100	2	4	63
MO450-45		25	50	160	15	50	125	5	10	100	2	4	63
MO450-50		25	50	160	15	50	125	5	10	100	2	4	80

MO450: No need for back-up fuse in networks with a prospective current of up to 50 kA at 400 V.  
With an appropriate 160 A type gG fuse the device can be used in a network with a prospective current of up to 100 kA.

#### Short-circuit protection MO495

MO495-63	No back-up fuse required up to $I_{cc} = 100$ kA	25	50	160	20	50	160	6	12	160	3	6	80
MO495-75		25	50	160	20	50	160	6	8	160	3	5	100
MO495-90		25	50	160	20	50	160	6	8	160	3	5	125
MO495-100		25	50	160	20	50	160	6	8	160	3	5	125

MO495-100: No need for back-up fuse in networks with a prospective current of up to 50 kA at 400 V.  
With an appropriate 160 A type gG fuse the device can be used in a network with a prospective current of up to 100 kA.

#### Short-circuit protection MO496

MO496-32	No back-up fuse required up to $I_{cc} = 100$ kA	50	100	No back-up fuse required up to $I_{cc} = 100$ kA	50	100	No back-up fuse required up to $I_{cc} = 100$ kA	11	22	100	7	12	63
MO496-40		50	100		50	100	9	18	160	6	12	80	
MO496-50		50	100		50	100	7.5	15	160	5	10	100	
MO496-63		50	100		50	70	200	7.5	15	160	4	7.5	100
MO496-75		50	100		50	70	200	5	10	160	3	6	125
MO496-90		50	100		50	70	200	5	10	160	3	6	160
MO496-100		50	100		50	70	200	5	10	160	3	6	160

MO496-32: No need for back-up fuse in networks with a prospective current of up to 100 kA at 440 V.  
MO496-90: No need for back-up fuse in networks with a prospective current of up to 70 kA at 440 V.  
With an appropriate 200 A type gG fuse the device can be used in a network with a prospective current of up to 100 kA.

# MO450, MO495, MO496 manual motor starters magnetic only



## Technical data

### General technical data

Type		MO450	MO495	MO496
Pollution degree		3		
Phase loss sensitivity		Yes		
Disconnect function acc. to IEC/EN 60947-2		Yes		
Ambient air temperature				
Operation	Open - compensated	-20 ... +60 °C		
	Open	-20 ... +70 °C (above 60° C, current derating)		
	Enclosed	-20 ... +35 °C		
Storage		-50 ... +80 °C		
Ambient air temperature compensation				
Maximum operating altitude permissible		2000 m		
Resistance to shock acc. to IEC 60068-2-27		25 g / 11 ms		
Resistance to vibrations acc. to IEC 60068-2-6		2 g / 5-150 Hz	-	
Mounting position		Position 1-6 (optional for single mounting)		
Mounting		DIN-rail 35 mm (EN 60715)	DIN-rail 15 mm / 75 mm (EN 60715)	
Minimum distance to other units same type	Horizontal	0 mm	0 mm	
	Vertical - up to 240 V	-	50 mm	
	Vertical - up to 440 V	-	70 mm	
	Vertical - up to 500 V	-	110 mm	
	Vertical - up to 690 V	-	150 mm	
	Vertical	50 mm	-	
Minimum distance to electrical conductive board	Horizontal	10 mm	-	
	Horizontal - up to 500 V	-	10 mm	
	Horizontal - up to 690 V	-	30 mm	
	Vertical - up to 240 V	-	50 mm	
	Vertical - up to 440 V	-	70 mm	
	Vertical - up to 500 V	-	110 mm	
	Vertical - up to 690 V	-	150 mm	
	Vertical	50 mm	-	
Degree of protection	Housing	IP20		
	Main circuit terminals	IP20		

### Connecting characteristics

#### Main circuit

Type		MO450	MO495	MO496
Connecting capacity				
 Solid	1 or 2 x	0.75 ... 16 mm <sup>2</sup>	2.5 ... 16 mm <sup>2</sup>	2.5 ... 16 mm <sup>2</sup>
 Flexible	1 x	0.75 ... 35 mm <sup>2</sup>	10 ... 70 mm <sup>2</sup>	10 ... 70 mm <sup>2</sup>
	2 x	0.75 ... 25 mm <sup>2</sup>	10 ... 50 mm <sup>2</sup>	10 ... 50 mm <sup>2</sup>
	Stranded acc. to UL/CSA	1 x AWG 18-2	AWG 10-2/0	AWG 10-2/0
		2 x AWG 18-2	AWG 10-1/0	AWG 10-1/0
	Flexible acc. to UL/CSA	1 x AWG 18-2	AWG 10-2/0	AWG 10-2/0
		2 x AWG 18-2	AWG 10-1/0	AWG 10-1/0
Stripping length		13 mm	17 mm	17 mm
Tightening torques		3 - 4.5 Nm / 27 ... 40 lb.in	4 - 6 Nm / 35 - 53 lb.in	4 - 6 Nm / 35 - 53 lb.in
Connection screw		Pozidriv 2	Hexagon 4	Hexagon 4

# MO450, MO495, MO496 manual motor starters magnetic only

## Technical data

### Main circuit – Utilization characteristics according to UL/CSA

Type	M0450, M0495, M0496	
Standards	UL 508, CSA 22.2 No. 14	
Maximum operational voltage	600 V AC	
Manual motor controller ratings	See table "UL 508 – Manual motor controller"	
Trip rating	125 % FLA	
Motor ratings	Horse power	See table "Motor rating, three phase"
	Full load amps (FLA)	See table "Motor rating, three phase"
	Locked rotor amps (LRA)	See table "Motor rating, three phase"

### Motor rating, three phase

hp Horse power

FLA Full load amps

LRA Locked rotor amps

Type	General purpose rating at max. 600 V AC	Full load amps	200 - 208 V AC	230 V AC	460 V AC	575 V AC
	A	FLA	hp	hp	hp	hp
MO450-40	40	40	10	15	30	40
MO450-45	45	45	15	15	30	40
MO450-50	50	50	15	20	40	50
MO495-63	63	63	20	25	50	60
MO495-75	75	75	25	25	60	75
MO495-90	90	90	30	30	75	100
MO495-100	100	100	40	40	75	100
MO496-32	32	32	10	10	25	30
MO496-40	40	40	15	15	30	40
MO496-50	50	50	15	20	40	50
MO496-63	63	63	20	25	50	60
MO496-75	75	75	25	25	60	75
MO496-90	90	90	30	30	75	100
MO496-100	100	100	30	40	75	100

### UL 508 – Manual motor controller

Type	Circuit breaker or class R fuse per UL/NEC	Max. circuit breaker or fuse per UL/NEC	Maximum short-circuit current for motor disconnect			
			for motor disconnect		for group installation	
			480/600 V A	480/600 V A	480 V kA	600 V kA
MO450-40	150	-	65	25	65	25
MO450-45	175	-	65	25	65	25
MO450-50	200	-	65	25	65	25
MO495-63	60	500	65	30	65	30
MO495-75	250	500	65	30	65	30
MO495-90	300	500	65	30	65	30
MO495-100	350	500	65	10	65	10
MO496-32	120	500	65	30	65	30
MO496-40	160	500	65	30	65	30
MO496-50	200	500	65	30	65	30
MO496-63	250	500	65	30	65	30
MO496-75	300	500	65	30	65	30
MO496-90	350	500	65	10	65	10
MO496-100	400	500	65	10	65	10

\* only with use DX495

# MO450, MO495, MO496 manual motor starters magnetic only

## Main accessories



SA2

SK0106B01

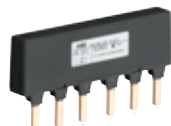

PS4-2-0

2CDC241003F0012



PS4-3-0

2CDC241004F0012



PS4-4-0

2CDC241005F0012

### Description

Three-phase busbars ensure a quick and safe connection and are therefore a cost effective solution. A variety of different three-phase busbars up to 108 A are in the assortment. Between 2 and 4 manual motor starter with none or two lateral auxiliary contacts can be connected.

### Ordering details

Rated operational current A	Number of MMS	Number of lateral aux.	Type	Order code	Pkg qty	Weight (1 pce) kg
<b>Three-phase busbars for MO450 only</b>						
108 A	2	0	PS4-2-0	1SAM401911R1001	5	0.134
108 A	3	0	PS4-3-0	1SAM401911R1002	5	0.206
108 A	4	0	PS4-4-0	1SAM401911R1003	5	0.280
108 A	2	1	PS4-2-2	1SAM401911R1004	5	0.148
108 A	3	1	PS4-3-2	1SAM401911R1005	5	0.250
108 A	4	1	PS4-4-2	1SAM401911R1006	5	0.362

Rated operational current A	Rated cross section mm <sup>2</sup>	Mounting form	Type	Order code	Pkg qty	Weight (1 pce) kg
<b>Three-phase feeder terminals for MO450 only</b>						
108 A	25	Flat	S4-M1	1SAM401911R1007	2	0.106

Description	for MMS	Type	Order code	Pkg qty	Weight (1 pce) kg
Protection cover for busbar	PS4	BS4-3	1SAM401911R1008	10	0.001
Disconnecter module	MO450	TB450	1SAM401910R1001	1	0.315
Terminal shroud	MO450	KA450	1SAM401908R1001	1	0.154
Terminal shroud	MO495	KA495	1SAM501901R1001	10	0.018
Terminal shroud	MO495	KA495C <sup>(1)</sup>	1SAM501902R1001	10	0.038
Terminal insulation barrier for UL508E	MO495	DX495	1SAM401912R1001	1	0.154
Padlock + 2 keys	MO450, MO495, MO496	SA2	GJF1101903R0002		

<sup>(1)</sup> is plugged onto the housing after removing the box terminals, if using cable lugs or buses

# MO450, MO495, MO496 manual motor starters magnetic only

## Main accessories

2



2CDC24102BF0011

HK4-11



2CDC24102ZF0011

HKS4-20



2CDC241024F0011

SK4-11



2CDC241023F0011

AA4-24



2CDC241026F0011

UA4-110

### Description

MO450, MO495, MO497 manual motor starters can be equipped with auxiliary contacts for lateral/front mounting, signalling contact for lateral mounting, undervoltage release and shunt trips. The accessories can be fitted wiring free and without tools. A variety of combinations is possible as required for the application. The auxiliary contacts change position with the main contacts. Undervoltage release are used for remote tripping of the manual motor starter especially for emergency stop circuits. Shunt trips release the MMS used for remote tripping.

### Ordering details

Auxiliary contacts N.O.	Auxiliary contacts N.C.	Description	Type	Order code	Pkg qty	Weight (1 pce)
<b>Auxiliary contacts – mountable on the front</b>						
1	1		HK4-11	1SAM401901R1001	10	0.017
-	-	Changeover	HK4-W	1SAM401901R1002	10	0.015
<b>Auxiliary contacts – mountable on the left</b>						
1	1	Max. 1 pieces	HKS4-11	1SAM401902R1001	2	0.045
2	0	Max. 1 pieces	HKS4-20	1SAM401902R1002	2	0.045
0	2	Max. 1 pieces	HKS4-02	1SAM401902R1003	2	0.045
<b>Signalling contacts – mountable on the right</b>						
2	2	Separate signalling acc. UL508E 1 N.O. + 1 N.C. for short circuit and 1NO+NC for general tripping , max. 2 pieces	SK4-11	1SAM401904R1001	1	0.093

Rated control supply voltage	Frequency	Type	Order code	Pkg qty	Weight (1 pce)
V	Hz				kg
<b>Shunt trip units – mountable on the left</b>					
20 ... 24	50/60	AA4-24	1SAM401907R1001	1	0.135
90 ... 110	50/60	AA4-110	1SAM401907R1002	1	0.135
200 ... 240	50/60	AA4-230	1SAM401907R1003	1	0.128
350 ... 415	50/60	AA4-400	1SAM401907R1004	1	0.125
<b>Undervoltage releases – mountable on the left</b>					
24	50/60	UA4-24	1SAM401905R1004	1	0.134
110/120	50/60	UA4-110	1SAM401905R1001	1	0.134
230/240	50/60	UA4-230	1SAM401905R1002	1	0.131
400/440	50/60	UA4-400	1SAM401905R1003	1	0.129
230/240	50/60	UA4-HK-230	1SAM401906R1001	1	0.140
400/440	50/60	UA4-HK-400	1SAM401906R1002	1	0.137

# MO450, MO495, MO496 manual motor starters magnetic only

## Main accessories

### Motor starters MO45x and MO49x with accessories

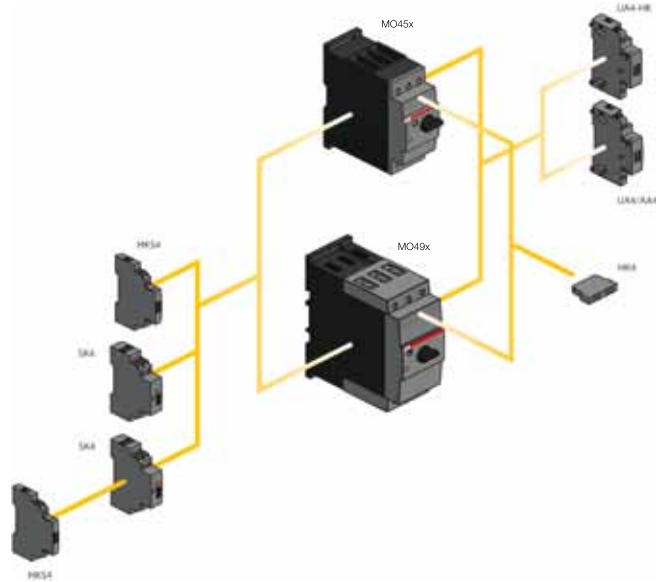

2CDC242025F0011

### General technical data

Type	HK4-11	HK4-W	HKS4	SK4
Standards	IEC/EN 60947-1, IEC/EN 60947-5-1, UL 508, CSA22.2 No. 14			
Rated operational voltage $U_b$	230 V AC / 220 V DC	690 V AC / 220 V DC	690 V AC	690 V AC
Conventional free-air thermal current $I_{th}$	2.5 A	5 A	10 A	10 A
Rated frequency	DC, 50/60 Hz			
Rated impulse withstand voltage $U_{imp}$	6 kV			
Rated insulation voltage $U_i$	300 V	300 V	690 V	690 V
Pollution degree	3			
Ambient air temperature	Operation Storage			
	-20 ... +70 °C -50 ... +80 °C			
Resistance to shock acc. to IEC 60068-2-27	25 g / 11 ms			
Resistance to vibrations acc. to IEC 60068-2-6	2 g / 5 ... 150Hz			
Number of poles	1 N.C. + 1 N.O.	Changeover	1 N.C. + 1 N.O. / 2 N.O. / 2 N.C.	2 N.C. + 2 N.O.
$I_b$ / Rated operational current AC-15 acc. to IEC/EN 60947-5-1 for utilization category				
	24 V	2 A	4 A	6 A
	230 V	0.5 A	3 A	4 A
	400 V	-	1.5 A	3 A
	690 V	-	0.5 A	1 A
$I_b$ / Rated operational current DC-13 acc. to IEC/EN 60947-5-1 for utilization category				
	24 V	1 A	1 A	2 A
	48 V	0.3 A	-	-
	60 V	0.15 A	-	-
	110 V	-	0.22 A	0.5 A
	230 V	-	0.1 A	0.25 A
Minimum switching capacity	17 V / 1 mA			
Short-circuit protective device	10 A Type gG			
Duty time	100 %			
Mounting	Front of MMS	Front of MMS	Left side of MMS	Left side of MMS
Mounting positions	1-6			
Mechanical durability	100000 cycles			
Electrical durability	100000 cycles			

2CDC131038C0201

# MO450, MO495, MO496 manual motor starters magnetic only

## Main accessories



2

Type		PS4-xxx	S4-M1
Standards		IEC/EN 60947-1	
Rated operational voltage $U_e$		690 V AC	
Rated operational current $I_e$		108 A	
Rated frequency		50/60 Hz	
Rated impulse withstand voltage $U_{imp}$		6 kV	
Rated insulation voltage $U_i$		690 V AC	
Pollution degree		3	
Cross-section		10 mm <sup>2</sup>	25 mm <sup>2</sup>
Ambient air temperature	Operation	-25 ... +70 °C	
	Storage	-50 ... +80 °C	



Type		UA4-xxx	AA4-xxx
Power consumption			
Pull-in	AC	20.2/13 VA/W	20.2/13 VA/W
	DC	20 W	13 ... 80 W
Holding	AC	7.2/2.4 VA/W	-
	DC	2.1 W	-
Operating voltage			
Tripping		0.35 ... 0.7 V x $U_s$	0.7 ... 1.1 V x $U_s$
Coil operating voltage		0.85 ... 1.1 V x $U_s$	-

### Electrical connection

#### Main circuit

Type		HK4-11	HK4-W	HKS4	SK4
Connecting capacity					
 Solid	1 x	0.5 ... 2.5 mm <sup>2</sup>			
	2 x	0.5 ... 1.5 mm <sup>2</sup> or 0.75 ... 2.5 mm			
 Flexible	1 x	0.5 ... 2.5 mm <sup>2</sup>			
	2 x	0.5 ... 1.5 mm <sup>2</sup> or 0.75 ... 2.5 mm			
	Stranded acc. to UL/CSA	1 or 2 x : AWG 18-14			
	Flexible acc. to UL/CSA	1 or 2 x : AWG 18-14			
Stripping length		10 mm			
Tightening torques		0.8 ... 1.2 Nm / 7 ... 10.3 lb.in			
Connection screw		Pozidriv 2			

#### Main circuit

Type		S4-M1
Connecting capacity		
 Solid	1 x	2.5 ... 50 mm <sup>2</sup>
 Flexible	1 x	4 ... 16 mm <sup>2</sup>
	Stranded acc. to UL/CSA	1 x : AWG 14-4
	Flexible acc. to UL/CSA	1 x : AWG 14-4
Tightening torques		4 Nm
Connection screw		Pozidriv 2



# MO450, MO495, MO496 manual motor starters magnetic only

## Main accessories



2CDC241007F0011

MSHD-LTB



2CDC241008F0011

MSHD-LTY



2CDC241004F0011

MSMN



2CDC241001F0012

MSH-AR

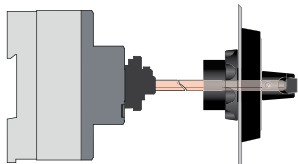

2CDC24003F0012

Shaft alignment ring

### Description

The complete set includes handle, shaft and driver. All accessories fit 6 mm shafts of maximum 180 mm length. The degree of protection for handles MSHD is IP64.

### Ordering details

Description	Shaft length mm	Type	Order code	Pkg qty	Weight (1 pce) kg
-------------	--------------------	------	------------	------------	-------------------------

#### Shafts

For selector type handles. Shaft diameter 6 mm. Shaft extension for door coupling driver.

85	OXS6X85	1SCA101647R1001	1	0.020
105	OXS6X105	1SCA108043R1001	1	0.020
130	OXS6X130	1SCA101655R1001	1	0.030
180	OXS6X180	1SCA101659R1001	1	0.040

Description	Color mm	Type	Order code	Pkg qty	Weight (1 pce) kg
-------------	-------------	------	------------	------------	-------------------------

#### Selector type handles IP64

Padlockable max. 3 padlocks with bail diameter 5 ... 8 mm, door interlock in ON position defeatable, for use with 6 mm OXS6...types up to 180 mm or driver shafts MSOX.

Black	MSHD-LTB <sup>1)</sup>	1SAM201920R1011	1	0.065
Yellow	MSHD-LTY <sup>1)</sup>	1SAM201920R1012	1	0.065

<sup>1)</sup> Indication I-O-T and ON-OFF-T

Description	Type	Order code	Pkg qty	Weight (1 pce) kg
-------------	------	------------	------------	-------------------------

#### Driver

Coupling driver for use with 6 mm OXS6... types up to 180 mm.

MSMN <sup>1)</sup>	1SAM101923R0002	1	0.002
MSMNO <sup>2)</sup>	1SAM101923R0012	1	0.002

<sup>1)</sup> Coded - Positioning of ON indication dependent from mounting orientation of the MS

<sup>2)</sup> Uncoded - Positioning of ON indication independent from mounting orientation of the MS

Description	Type	Order code	Pkg qty	Weight (1 pce) kg
-------------	------	------------	------------	-------------------------

#### Shaft alignment ring

The MSH-AR supports the long axis for alignment to the handle inlet. It makes closing panel doors more easy.

MSH-AR	1SAM201920R1000	1	0.010
--------	-----------------	---	-------



# B mini contactors

## K mini contactor relays

### With screw terminals

#### 3-pole contactors

B6, B7	AC operated	3/2
BC6, BC7, B7D	DC operated	3/3

#### 3-pole reversing contactors

VB6, VB7	AC operated	3/4
VBC6, VBC7	DC operated	3/5
VB6A, VB7A	AC operated	3/6
VBC6A, VBC7A	DC operated	3/7

#### 3-pole interface contactors

BC6, BC7	DC operated	3/8
----------	-------------	-----

#### 3-pole contactors - large coil voltage range

TBC7	DC operated	3/9
------	-------------	-----

#### 4-pole contactors

B6, B7	AC operated	3/10
BC6, B7D	DC operated	3/11
TBC7	DC operated - large coil voltage range	3/12

#### Contactors relays

K6	AC operated	3/13
KC6	DC operated	3/14

#### Interface contactor relays

KC6	DC operated	3/15
TKC6	DC operated - large coil voltage range	3/16

### With soldering pins

#### 3-pole contactors

B6, B7	AC operated	3/17
BC6, BC7	DC operated	3/18

#### 3-pole reversing contactors

VB6, VB7	AC operated	3/19
VBC6, VBC7	DC operated	3/20
VB6A, VB7A	AC operated	3/21
VBC7A	DC operated	3/22

#### Contactors relays

K6	AC operated	3/23
KC6	DC operated	3/24

#### 3-pole interface contactors

BC6, BC7	DC operated	3/25
----------	-------------	------

#### Interface contactors relays

KC6	DC operated	3/26
-----	-------------	------

### With flat pin connection

#### 3-pole contactors

B6, B7	AC operated	3/27
BC6, BC7	DC operated	3/28

#### 3-pole reversing contactors

VB7	AC operated	3/29
VBC7	DC operated	3/30
VB7A	AC operated	3/31
VBC7A	DC operated	3/32

#### 3-pole interface contactors

BC6, BC7	DC operated	3/33
----------	-------------	------

#### Contactors relays

K6	AC operated	3/34
KC6	DC operated	3/35

#### Interface contactors relays

KC6	DC operated	3/36
-----	-------------	------

<b>Accessories</b>	<b>3/37</b>
--------------------	-------------

<b>Technical data</b>	<b>3/39</b>
-----------------------	-------------

<b>Terminal marking and positioning</b>	<b>3/47</b>
---	-------------

# B6, B7 3-pole mini contactors – with screw terminals

## 4 to 5.5 kW

### AC operated



2CDC21001F0010

B6-30-10

3



2CDC21014F0011

B7-30-10

#### Description

B6, B7 3-pole mini contactors are compact control products mainly used for switching resistive or motor loads up to 690 V AC.

These contactors are designed with:

- 3 main poles and one built-in auxiliary contact
- control circuit: AC operated
  - low coil consumption (3.5 VA at pull-in and at holding).
- add-on auxiliary contact blocks for front or side mounting and a wide range of accessories
- hum-free coil
- designed for rail or wall mounting.

#### Ordering details

IEC Rated operational power	Rated operational current $\theta \leq 40^\circ\text{C}$	UL/CSA		Rated control circuit voltage $U_c$		Auxiliary contacts fitted	Type	Order code	Pkg qty	Weight (1 pce)
		3-phase motor rating	General use rating	50 Hz	60 Hz					
400 V AC-3 kW	AC-1 A	hp		V AC	V AC					kg

#### B6 mini contactors

Rated operational power (kW)	Rated operational current (A)	3-phase motor rating (hp)	UL/CSA General use rating (V AC)	Rated control circuit voltage $U_c$ (50 Hz V AC)	Rated control circuit voltage $U_c$ (60 Hz V AC)	Auxiliary contacts fitted	Type	Order code	Pkg qty	Weight (1 pce) (kg)
4	20	3	300 V / 12 A	24	24	1 0	B6-30-10-01	GJL1211001R0101	10	0.175
					42	42	0 1	B6-30-01-01	GJL1211001R0011	10
				48	48	1 0	B6-30-10-02	GJL1211001R0102	10	0.175
						0 1	B6-30-01-02	GJL1211001R0012	10	0.175
				110 ... 127	110 ... 127	1 0	B6-30-10-03	GJL1211001R0103	10	0.175
						0 1	B6-30-01-03	GJL1211001R0013	10	0.175
				220 ... 240	220 ... 240	1 0	B6-30-10-84	GJL1211001R8104	10	0.175
						0 1	B6-30-01-84	GJL1211001R8014	10	0.175
				380 ... 415	380 ... 415	1 0	B6-30-10-80	GJL1211001R8100	10	0.175
						0 1	B6-30-01-80	GJL1211001R8010	10	0.175
				380 ... 415	380 ... 415	1 0	B6-30-10-85	GJL1211001R8105	10	0.175
						0 1	B6-30-01-85	GJL1211001R8015	10	0.175

#### B7 mini contactors

Rated operational power (kW)	Rated operational current (A)	3-phase motor rating (hp)	UL/CSA General use rating (V AC)	Rated control circuit voltage $U_c$ (50 Hz V AC)	Rated control circuit voltage $U_c$ (60 Hz V AC)	Auxiliary contacts fitted	Type	Order code	Pkg qty	Weight (1 pce) (kg)
5.5	20	5	600 V / 16 A	24	24	1 0	B7-30-10-01	GJL1311001R0101	10	0.175
					42	42	0 1	B7-30-01-01	GJL1311001R0011	10
				48	48	1 0	B7-30-10-02	GJL1311001R0102	10	0.175
						0 1	B7-30-01-02	GJL1311001R0012	10	0.175
				110 ... 127	110 ... 127	1 0	B7-30-10-03	GJL1311001R0103	10	0.175
						0 1	B7-30-01-03	GJL1311001R0013	10	0.175
				220 ... 240	220 ... 240	1 0	B7-30-10-84	GJL1311001R8104	10	0.175
						0 1	B7-30-01-84	GJL1311001R8014	10	0.175
				380 ... 415	380 ... 415	1 0	B7-30-10-80	GJL1311001R8100	10	0.175
						0 1	B7-30-01-80	GJL1311001R8010	10	0.175
				380 ... 415	380 ... 415	1 0	B7-30-10-85	GJL1311001R8105	10	0.175
						0 1	B7-30-01-85	GJL1311001R8015	10	0.175

Other types on request.

#### Main dimensions mm, inches

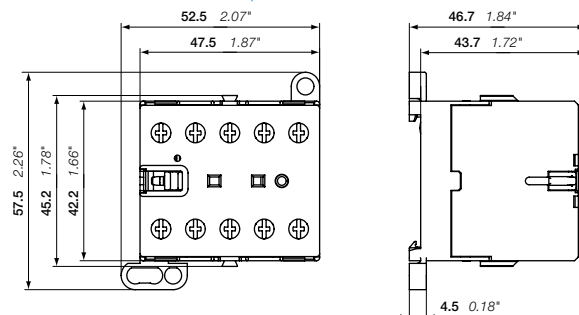

B6, B7

# BC6, BC7, B7D 3-pole mini contactors – with screw terminals

## 4 to 5.5 kW

### DC operated



BC6-30-10

2CDC21104RF0011



BC7-30-10

2CDC21104RF0011

#### Description

BC6, BC7, B7D 3-pole mini contactors are compact control products mainly used for switching resistive or motor loads up to 690 V AC.

These contactors are designed with:

- 3 main poles and one built-in auxiliary contact
- control circuit: DC operated, low consumption (3.5 W at pull-in and at holding)
- hum-free coil
- add-on auxiliary contact blocks for front or side mounting and a wide range of accessories
- designed for rail or wall mounting.

#### Ordering details

IEC	UL/CSA	Rated control circuit voltage: U <sub>c</sub>	Auxiliary contacts fitted	Type	Order code	Pkg qty	Weight (1 pce)
Rated operational power	3-phase motor rating θ ≤ 40 °C	General use rating					kg
400 V AC-3 kW	AC-1 A	hp					

#### BC6 mini contactors

Rated operational power	3-phase motor rating	General use rating	Rated control circuit voltage: U <sub>c</sub>	Auxiliary contacts fitted	Type	Order code	Pkg qty	Weight (1 pce)
400 V AC-3 kW	AC-1 A	hp	V DC					kg
4	20	3	300 V / 12 A	1 0	BC6-30-10-07	GJL1213001R0107	10	0.175
				0 1	BC6-30-01-07	GJL1213001R0017	10	0.175
				1 0	BC6-30-10-01	GJL1213001R0101	10	0.175
				0 1	BC6-30-01-01	GJL1213001R0011	10	0.175
				1 0	BC6-30-10-16	GJL1213001R1106	10	0.175
				0 1	BC6-30-01-16	GJL1213001R1016	10	0.175
				1 0	BC6-30-10-03	GJL1213001R0103	10	0.175
				0 1	BC6-30-01-03	GJL1213001R0013	10	0.175
				1 0	BC6-30-10-04	GJL1213001R0104	10	0.175
				0 1	BC6-30-01-04	GJL1213001R0014	10	0.175
				1 0	BC6-30-10-05	GJL1213001R0105	10	0.175
				0 1	BC6-30-01-05	GJL1213001R0015	10	0.175

#### BC7 mini contactors

Rated operational power	3-phase motor rating	General use rating	Rated control circuit voltage: U <sub>c</sub>	Auxiliary contacts fitted	Type	Order code	Pkg qty	Weight (1 pce)
400 V AC-3 kW	AC-1 A	hp	V DC					kg
5.5	20	5	600 V / 16 A	1 0	BC7-30-10-07	GJL1313001R0107	10	0.175
				0 1	BC7-30-01-07	GJL1313001R0017	10	0.175
				1 0	BC7-30-10-01	GJL1313001R0101	10	0.175
				0 1	BC7-30-01-01	GJL1313001R0011	10	0.175
				1 0	BC7-30-10-16	GJL1313001R1106	10	0.175
				0 1	BC7-30-01-16	GJL1313001R1016	10	0.175
				1 0	BC7-30-10-03	GJL1313001R1103	10	0.175
				0 1	BC7-30-01-03	GJL1313001R0013	10	0.175
				1 0	BC7-30-10-04	GJL1313001R0104	10	0.175
				0 1	BC7-30-01-04	GJL1313001R0014	10	0.175
				1 0	BC7-30-10-05	GJL1313001R0105	10	0.175
				0 1	BC7-30-01-05	GJL1313001R0015	10	0.175

#### B7D mini contactors with integrated suppressor diode

Rated operational power	3-phase motor rating	General use rating	Rated control circuit voltage: U <sub>c</sub>	Auxiliary contacts fitted	Type	Order code	Pkg qty	Weight (1 pce)
400 V AC-3 kW	AC-1 A	hp	V DC					kg
5.5	20	5	600 V / 16 A	1 0	B7D-30-10-01	GJL1317001R0101	10	0.175
				0 1	B7D-30-01-01	GJL1317001R0011	10	0.175
				1 0	B7D-30-10-05	GJL1317001R0105	10	0.175
				0 1	B7D-30-01-05	GJL1317001R0015	10	0.175

Other types on request.

#### Main dimensions mm, inches

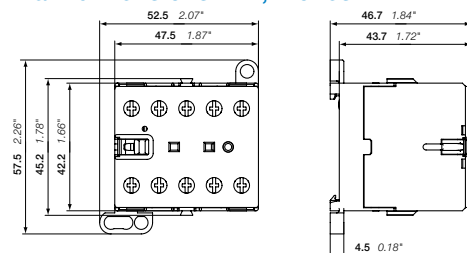

BC6, BC7, B7D

2CDC212001F0011

2CDC102015C0201

# VB6, VB7 3-pole mini reversing contactors – with screw terminals

## 4 to 5.5 kW

### AC operated



2CDC211006F0011

3

VB7-30-10

#### Description

VB6, VB7 3-pole compact design reversing contactors are space optimized control products mainly used for switching resistive or motor loads up to 690 V AC.

These reversing contactors are designed with:

- built-in mechanical interlock. The coils must be mutually interlocked electrically and coils must be de-energised for 50 ms at least to prevent phase to phase short circuit on the arc.
- control circuit: AC operated
  - low coil consumption (3.5 VA at pull-in and at holding).
- hum-free coil
- add-on auxiliary contact blocks for front mounting
- designed for rail or wall mounting.

#### Ordering details

IEC Rated operational power	Rated operational current $\theta \leq 40^\circ\text{C}$	UL/CSA		Rated control circuit voltage $U_c$		Auxiliary contacts fitted	Type	Order code	Pkg qty	Weight (1 pce)
		3-phase motor rating 480 V	General use rating hp	50 Hz V AC	60 Hz V AC					
400 V AC-3 kW	AC-1 A									kg

#### VB6 mini reversing contactors

4	20	3	300 V / 12 A	24	24	1 0	0 1	VB6-30-10-01	GJL1211901R0101	5	0.355
				42	42	1 0	0 1	VB6-30-01-01	GJL1211901R0011	5	0.355
						1 0	0 1	VB6-30-10-02	GJL1211901R0102	5	0.355
						0 1	0 1	VB6-30-01-02	GJL1211901R0012	5	0.355
				48	48	1 0	0 1	VB6-30-10-03	GJL1211901R0103	5	0.355
						0 1	0 1	VB6-30-01-03	GJL1211901R0013	5	0.355
				110 ... 127	110 ... 127	1 0	0 1	VB6-30-10-84	GJL1211901R8104	5	0.355
						0 1	0 1	VB6-30-01-84	GJL1211901R8014	5	0.355
				220 ... 240	220 ... 240	1 0	0 1	VB6-30-10-80	GJL1211901R8100	5	0.355
						0 1	0 1	VB6-30-01-80	GJL1211901R8010	5	0.355
				380 ... 415	380 ... 415	1 0	0 1	VB6-30-10-85	GJL1211901R8105	5	0.355
						0 1	0 1	VB6-30-01-85	GJL1211901R8015	5	0.355

#### VB7 mini reversing contactors

5.5	20	5	600 V / 16 A	24	24	1 0	0 1	VB7-30-10-01	GJL1311901R0101	5	0.355
				42	42	1 0	0 1	VB7-30-01-01	GJL1311901R0011	5	0.355
						1 0	0 1	VB7-30-10-02	GJL1311901R0102	5	0.355
						0 1	0 1	VB7-30-01-02	GJL1311901R0012	5	0.355
				48	48	1 0	0 1	VB7-30-10-03	GJL1311901R0103	5	0.355
						0 1	0 1	VB7-30-01-03	GJL1311901R0013	5	0.355
				110 ... 127	110 ... 127	1 0	0 1	VB7-30-10-84	GJL1311901R8104	5	0.355
						0 1	0 1	VB7-30-01-84	GJL1311901R8014	5	0.355
				220 ... 240	220 ... 240	1 0	0 1	VB7-30-10-80	GJL1311901R8100	5	0.355
						0 1	0 1	VB7-30-01-80	GJL1311901R8010	5	0.355
				380 ... 415	380 ... 415	1 0	0 1	VB7-30-10-85	GJL1311901R8105	5	0.355
						0 1	0 1	VB7-30-01-85	GJL1311901R8015	5	0.355

Other types on request.

#### Main dimensions mm, inches

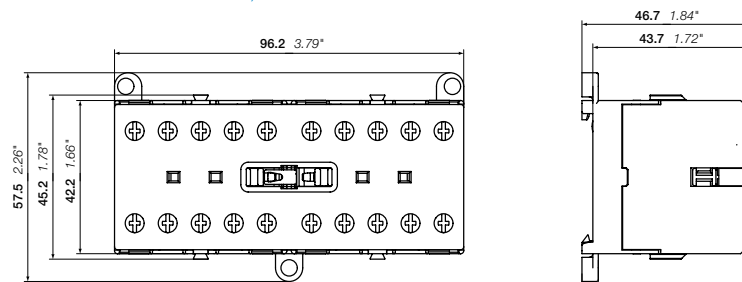

VB6, VB7

2CDC211006F0011

2CDC102016C0201

# VBC6, VBC7 3-pole mini reversing contactors – with screw terminals

## 4 to 5.5 kW

### DC operated



VBC6-30-10

2CDC21104R0011



VBC7-30-10

2CDC21100R0011

### Description

VBC6, VBC7 3-pole compact design reversing contactors are space optimized control products mainly used for switching resistive or motor loads up to 690 V AC.

These reversing contactors are designed with:

- built-in mechanical interlock. The coils must be mutually interlocked electrically and coils must be de-energised for 50 ms at least to prevent phase to phase short circuit on the arc.
- control circuit: DC operated
  - low coil consumption (3.5 W at pull-in and at holding).
- hum-free coil
- add-on auxiliary contact blocks for front mounting
- designed for rail or wall mounting.

### Ordering details

IEC	UL/CSA	Rated control circuit voltage: U <sub>c</sub>	Auxiliary contacts fitted	Type	Order code	Pkg qty	Weight (1 pce)
Rated operational power	3-phase motor rating θ ≤ 40 °C	General use rating					kg
400 V AC-3 kW	AC-1 A	hp					

#### VBC6 mini reversing contactors

Rated operational power	3-phase motor rating	General use rating	Rated control circuit voltage: U <sub>c</sub>	Auxiliary contacts fitted	Type	Order code	Pkg qty	Weight (1 pce)	
4	20	3	300 V / 12 A	12	1 0	VBC6-30-10-07	GJL1213901R0107	5	0.355
					0 1	VBC6-30-01-07	GJL1213901R0017	5	0.355
				24	1 0	VBC6-30-10-01	GJL1213901R0101	5	0.355
					0 1	VBC6-30-01-01	GJL1213901R0011	5	0.355
				48	1 0	VBC6-30-10-16	GJL1213901R1106	5	0.355
					0 1	VBC6-30-01-16	GJL1213901R1016	5	0.355
				60	1 0	VBC6-30-10-03	GJL1213901R0103	5	0.355
					0 1	VBC6-30-01-03	GJL1213901R0013	5	0.355
				110 ... 125	1 0	VBC6-30-10-04	GJL1213901R0104	5	0.355
					0 1	VBC6-30-01-04	GJL1213901R0014	5	0.355
				220 ... 240	1 0	VBC6-30-10-05	GJL1213901R0105	5	0.355
					0 1	VBC6-30-01-05	GJL1213901R0015	5	0.355

#### VBC7 mini reversing contactors

Rated operational power	3-phase motor rating	General use rating	Rated control circuit voltage: U <sub>c</sub>	Auxiliary contacts fitted	Type	Order code	Pkg qty	Weight (1 pce)	
5.5	20	5	600 V / 16 A	12	1 0	VBC7-30-10-07	GJL1313901R0107	5	0.355
					0 1	VBC7-30-01-07	GJL1313901R0017	5	0.355
				24	1 0	VBC7-30-10-01	GJL1313901R0101	5	0.355
					0 1	VBC7-30-01-01	GJL1313901R0011	5	0.355
				48	1 0	VBC7-30-10-16	GJL1313901R1106	5	0.355
					0 1	VBC7-30-01-16	GJL1313901R1016	5	0.355
				60	1 0	VBC7-30-10-03	GJL1313901R0103	5	0.355
					0 1	VBC7-30-01-03	GJL1313901R0013	5	0.355
				110 ... 125	1 0	VBC7-30-10-04	GJL1313901R0104	5	0.355
					0 1	VBC7-30-01-04	GJL1313901R0014	5	0.355
				220 ... 240	1 0	VBC7-30-10-05	GJL1313901R0105	5	0.355
					0 1	VBC7-30-01-05	GJL1313901R0015	5	0.355

Other types on request.

### Main dimensions mm, inches

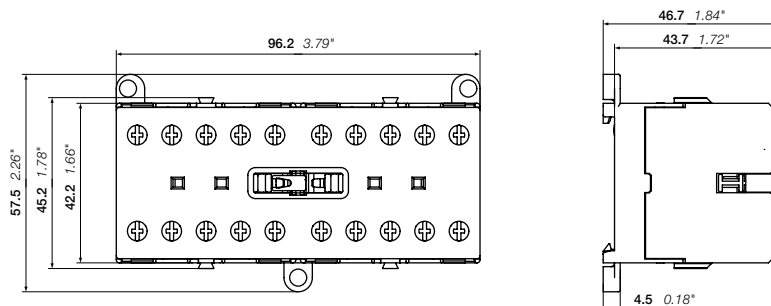

VBC6, VBC7

2CDC21200R0011

2CDC102017C0201



# VB6A, VB7A 3-pole mini reversing contactors – with screw terminals

## 4 to 5.5 kW

### AC operated – with safety blocking function



2CDC21103BF0011

3 VB6A-30-10



2CDC21103BF0011

VB7A-30-10

#### Description

VB6A, VB7A 3-pole compact design reversing contactors are space optimized control products mainly used for switching resistive or motor loads up to 690 V AC.

These reversing contactors are designed with:

- built-in mechanical interlock and safety blocking function. The safety blocking function is triggered if the voltage is applied to the coil of the contactor to be switched on before the contactor to be switched off has dropped out. The contactor coils are designed for continuous operation when the contactor is de-energised i.e. the coil is not damaged if the mechanical interlock prevents switch-on of the contactor with the coil voltage applied.
- control circuit: AC operated
  - low coil consumption (3.5 VA at pull-in and at holding).
- hum-free coil
- add-on auxiliary contact blocks for front mounting
- designed for rail or wall mounting.

#### Ordering details

IEC	UL/CSA	Rated control circuit voltage $U_c$	Auxiliary contacts fitted	Type	Order code	Pkg qty	Weight (1 pce)
Rated operational power	3-phase motor rating $\theta \leq 40^\circ\text{C}$	General use rating					kg
400 V AC-3 kW	AC-1 A hp	50 Hz V AC 60 Hz V AC					

#### VB6A mini reversing contactors with safety blocking function

Rated power	Rated current	3-phase motor rating	Rated control circuit voltage $U_c$	Rated control circuit voltage $U_c$	Auxiliary contacts fitted	Type	Order code	Pkg qty	Weight (1 pce)	
4	20	3	300 V / 12 A	24	24	1 0	VB6A-30-10-01	GJL1211911R0101	5	0.355
						0 1	VB6A-30-01-01	GJL1211911R0011	5	0.355
				42	42	1 0	VB6A-30-10-02	GJL1211911R0102	5	0.355
						0 1	VB6A-30-01-02	GJL1211911R0012	5	0.355
				48	48	1 0	VB6A-30-10-03	GJL1211911R0103	5	0.355
						0 1	VB6A-30-01-03	GJL1211911R0013	5	0.355
				110 ... 127	110 ... 127	1 0	VB6A-30-10-84	GJL1211911R8104	5	0.355
						0 1	VB6A-30-01-84	GJL1211911R8014	5	0.355
				220 ... 240	220 ... 240	1 0	VB6A-30-10-80	GJL1211911R8100	5	0.355
						0 1	VB6A-30-01-80	GJL1211911R8010	5	0.355
				380 ... 415	380 ... 415	1 0	VB6A-30-10-85	GJL1211911R8105	5	0.355
						0 1	VB6A-30-01-85	GJL1211911R8015	5	0.355

#### VB7A mini reversing contactors with safety blocking function

Rated power	Rated current	3-phase motor rating	Rated control circuit voltage $U_c$	Rated control circuit voltage $U_c$	Auxiliary contacts fitted	Type	Order code	Pkg qty	Weight (1 pce)	
5.5	20	5	600 V / 16 A	24	24	1 0	VB7A-30-10-01	GJL1311911R0101	5	0.355
						0 1	VB7A-30-01-01	GJL1311911R0011	5	0.355
				42	42	1 0	VB7A-30-10-02	GJL1311911R0102	5	0.355
						0 1	VB7A-30-01-02	GJL1311911R0012	5	0.355
				48	48	1 0	VB7A-30-10-03	GJL1311911R0103	5	0.355
						0 1	VB7A-30-01-03	GJL1311911R0013	5	0.355
				110 ... 127	110 ... 127	1 0	VB7A-30-10-84	GJL1311911R8104	5	0.355
						0 1	VB7A-30-01-84	GJL1311911R8014	5	0.355
				220 ... 240	220 ... 240	1 0	VB7A-30-10-80	GJL1311911R8100	5	0.355
						0 1	VB7A-30-01-80	GJL1311911R8010	5	0.355
				380 ... 415	380 ... 415	1 0	VB7A-30-10-85	GJL1311911R8105	5	0.355
						0 1	VB7A-30-01-85	GJL1311911R8015	5	0.355

Other types on request.

#### Main dimensions mm, inches

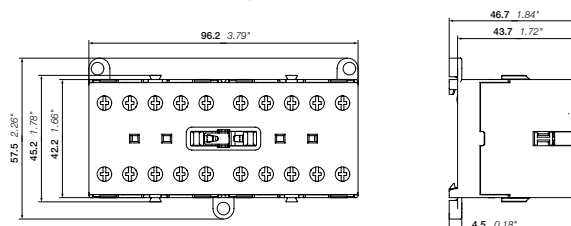

VB6A, VB7A

# VBC6A, VBC7A 3-pole mini reversing contactors – with screw terminals

## 4 to 5.5 kW

### DC operated – with safety blocking function



VBC6A-30-10

2CDC21104F0011



VBC7A-30-10

2CDC211007F0011

#### Description

VBC6A, VBC7A 3-pole compact design reversing contactors are space optimized control products mainly used for switching resistive or motor loads up to 690 V AC.

These reversing contactors are designed with:

- built-in mechanical interlock and safety blocking function. The safety blocking function is triggered if the voltage is applied to the coil of the contactor to be switched on before the contactor to be switched off has dropped out. The contactor coils are designed for continuous operation when the contactor is de-energised i.e. the coil is not damaged if the mechanical interlock prevents switch-on of the contactor with the coil voltage applied.
- control circuit: DC operated
  - low coil consumption (3.5 W at pull-in and at holding).
- hum-free coil
- add-on auxiliary contact blocks for front mounting
- designed for rail or wall mounting.

#### Ordering details

IEC	UL/CSA	Rated control circuit voltage: $U_c$	Auxiliary contacts fitted	Type	Order code	Pkg qty	Weight (1 pce)
Rated operational power	3-phase motor rating $\theta \leq 40^\circ\text{C}$	General use rating					kg
400 V AC-3 kW	AC-1 A hp		V DC				

#### VBC6A mini reversing contactors with safety blocking function

Power (kW)	Current (A)	Motor Rating (hp)	Rated Voltage (V)	Rated Current (A)	Control Voltage (V DC)	Auxiliary Contacts	Type	Order Code	Pkg Qty	Weight (kg)
4	20	3	300 V / 12 A	12	12	0	VBC6A-30-10-07	GJL1213911R0107	5	0.355
						1	VBC6A-30-01-07	GJL1213911R0017	5	0.355
						0	VBC6A-30-10-01	GJL1213911R0101	5	0.355
						1	VBC6A-30-01-01	GJL1213911R0011	5	0.355
						0	VBC6A-30-10-16	GJL1213911R1106	5	0.355
						1	VBC6A-30-01-16	GJL1213911R1016	5	0.355
						0	VBC6A-30-10-03	GJL1213911R0103	5	0.355
						1	VBC6A-30-01-03	GJL1213911R0013	5	0.355
						0	VBC6A-30-10-04	GJL1213911R0104	5	0.355
						1	VBC6A-30-01-04	GJL1213911R0014	5	0.355
						0	VBC6A-30-10-05	GJL1213911R0105	5	0.355
						1	VBC6A-30-01-05	GJL1213911R0015	5	0.355

#### VBC7A mini reversing contactors with safety blocking function

Power (kW)	Current (A)	Motor Rating (hp)	Rated Voltage (V)	Rated Current (A)	Control Voltage (V DC)	Auxiliary Contacts	Type	Order Code	Pkg Qty	Weight (kg)
5.5	20	5	600 V / 16 A	12	12	0	VBC7A-30-10-07	GJL1313911R0107	5	0.355
						1	VBC7A-30-01-07	GJL1313911R0017	5	0.355
						0	VBC7A-30-10-01	GJL1313911R0101	5	0.355
						1	VBC7A-30-01-01	GJL1313911R0011	5	0.355
						0	VBC7A-30-10-16	GJL1313911R1106	5	0.355
						1	VBC7A-30-01-16	GJL1313911R0016	5	0.355
						0	VBC7A-30-10-03	GJL1313911R0103	5	0.355
						1	VBC7A-30-01-03	GJL1313911R0013	5	0.355
						0	VBC7A-30-10-04	GJL1313911R0104	5	0.355
						1	VBC7A-30-01-04	GJL1313911R0014	5	0.355
						0	VBC7A-30-10-05	GJL1313911R0105	5	0.355
						1	VBC7A-30-01-05	GJL1313911R0015	5	0.355

Other types on request.

#### Main dimensions mm, inches

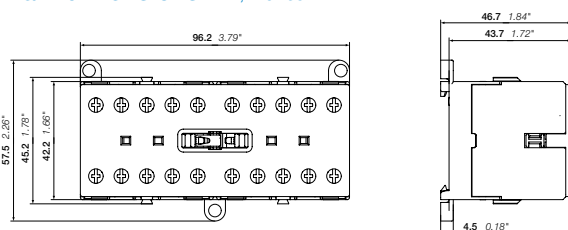

VBC6A, VBC7A

2CDC212006F0011

2CDC102019C0201

# BC6, BC7 3-pole interface mini contactors – with screw terminals

## 4 to 5.5 kW

### DC operated



2CDC21104F0011

BC6-30-10

3



2CDC21109F0011

BC7-30-10

#### Description

BC6, BC7 3-pole interface mini contactors are compact control products mainly used for switching resistive or motor loads up to 690 V AC.

These contactors are designed with:

- 3 main poles and one built-in auxiliary contact
- control circuit: DC operated, very low coil consumption. Suitable for direct control by PLC outputs
- hum-free coil
- no auxiliary contact block permitted for mounting
- designed for rail or wall mounting.

#### Ordering details

IEC Rated operational power	UL/CSA 3-phase motor rating 480 V	General use rating	Rated control circuit voltage $U_c$	Auxiliary contacts fitted	Type	Order code	Pkg qty	Weight (1 pce)
400 V AC-3 kW	$\theta \leq 40^\circ\text{C}$ AC-1 A	hp	V DC					kg

#### DC operation 24 V / 1.4 W

4	20	3	300 V / 12 A	24	1 0	BC6-30-10-1.4-81	GJL1213001R8101	10	0.175
					0 1	BC6-30-01-1.4-81	GJL1213001R8011	10	0.175
5.5	20	5	600 V / 16 A	24	1 0	BC7-30-10-1.4-81	GJL1313001R8101	10	0.175
					0 1	BC7-30-01-1.4-81	GJL1313001R8011	10	0.175

#### DC operation 17 ... 32 V / 2.4 W

4	20	3	300 V / 12 A	17 ... 32	1 0	BC6-30-10-2.4-51	GJL1213001R5101	10	0.175
					0 1	BC6-30-01-2.4-51	GJL1213001R5011	10	0.175
5.5	20	5	600 V / 16 A	17 ... 32	1 0	BC7-30-10-2.4-51	GJL1313001R5101	10	0.175
					0 1	BC7-30-01-2.4-51	GJL1313001R5011	10	0.175

#### Connection to PLCs with integrated protective circuit

##### DC operation 24 V / 1.7 W

4	20	3	300 V / 12 A	24	1 0	B6S-30-10-1.7-71	GJL1213001R7101	10	0.175
					0 1	B6S-30-01-1.7-71	GJL1213001R7011	10	0.175
5.5	20	5	600 V / 16 A	24	1 0	B7S-30-10-1.7-71	GJL1313001R7101	10	0.175
					0 1	B7S-30-01-1.7-71	GJL1313001R7011	10	0.175

##### DC operation 17 ... 32 V / 2.8 W

4	20	3	300 V / 12 A	17 ... 32	1 0	B6S-30-10-2.8-72	GJL1213001R7102	10	0.175
					0 1	B6S-30-01-2.8-72	GJL1213001R7012	10	0.175
5.5	20	5	600 V / 16 A	17 ... 32	1 0	B7S-30-10-2.8-72	GJL1313001R7102	10	0.175
					0 1	B7S-30-01-2.8-72	GJL1313001R7012	10	0.175

Other types on request.

#### Main dimensions mm, inches

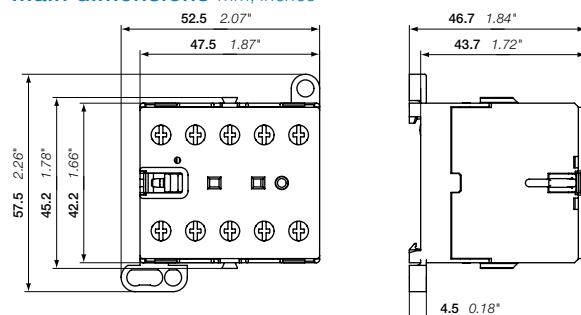

BC6, BC7

2CDC212001F0011

2CDC102010C0201

# TBC7 3-pole mini contactors – with screw terminals

## 4 to 5.5 kW

### DC operated – large coil voltage range



2CDC211015F0011

TBC7-30-10

#### Description

TBC7 3-pole mini contactors are compact control products mainly used for switching resistive or motor loads up to 690 V AC.

These contactors are designed with:

- 3 main poles and one built-in auxiliary contact
- control circuit: DC operated
  - low coil consumption (5 W at pull-in and at holding).
  - hum-free coil
- expanded ambient temperature range -30 ... +70 °C and wide range voltage supply
- no auxiliary contact block permitted for mounting
- designed for rail or wall mounting
- material is approved for railway applications.

#### Ordering details

IEC	UL/CSA	Rated control circuit voltage	Auxiliary contacts fitted	Type	Order code	Pkg qty	Weight (1 pce)
Rated operational power 400 V AC-3 kW	3-phase motor rating 480 V hp	General use rating V DC					kg
current $\theta \leq 40\text{ }^\circ\text{C}$ A		$U_{Cmin} \dots U_{Cmax}$					

#### TBC7 mini contactors

Power (kW)	Current (A)	Motor Rating (hp)	Rated Voltage (V)	Control Voltage Range (V DC)	Auxiliary Contact Config	Type	Order Code	Pkg Qty	Weight (kg)
5.5	20	5	600 V / 16 A	17 ... 32	1 0	TBC7-30-10-51	GJL1313061R5101	10	0.185
					0 1	TBC7-30-01-51	GJL1313061R5011	10	0.185
				50 ... 90	1 0	TBC7-30-10-55	GJL1313061R5105	10	0.185
					0 1	TBC7-30-01-55	GJL1313061R5015	10	0.185
				77 ... 143	1 0	TBC7-30-10-62	GJL1313061R6102	10	0.185
					0 1	TBC7-30-01-62	GJL1313061R6012	10	0.185
				140 ... 260	1 0	TBC7-30-10-68	GJL1313061R6108	10	0.185
					0 1	TBC7-30-01-68	GJL1313061R6018	10	0.185

Other types on request.

#### Main dimensions mm, inches

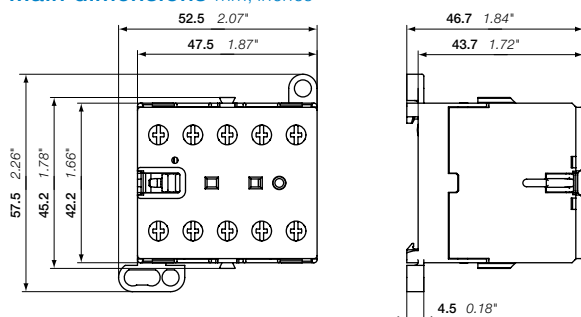

TBC7

2CDC211015F0011

2CDC102020 C0201

# B6, B7 4-pole mini contactors – with screw terminals

## 4 to 5.5 kW

### AC operated



2CDC211029F0011

3

B6-22-00

#### Description

B6, B7 4-pole mini contactors are compact control products mainly used for switching resistive loads up to 690 V AC.

These contactors are designed with:

- 4 main poles
- control circuit: AC operated
  - low coil consumption (3.5 VA at pull-in and at holding).
- add-on auxiliary contact blocks for front or side mounting and a wide range of accessories
- hum-free coil
- designed for rail or wall mounting.

#### Ordering details

IEC Rated operational current $\theta \leq 40^\circ\text{C}$ AC-1	UL/CSA General use rating	Rated control circuit voltage $U_c$ 50/60 HZ	Auxiliary contacts fitted	Type	Order code	Pkg qty	Weight (1 pce)
A		V AC					kg

#### 4 N.O. main poles

20	300 V / 12 A	24	0 0	B6-40-00-01	GJL1211201R0001	10	0.175
		42	0 0	B6-40-00-02	GJL1211201R0002	10	0.175
		48	0 0	B6-40-00-03	GJL1211201R0003	10	0.175
		110 ... 127	0 0	B6-40-00-84	GJL1211201R8004	10	0.175
		220 ... 240	0 0	B6-40-00-80	GJL1211201R8000	10	0.175
20	600 V / 16 A	24	0 0	B7-40-00-01	GJL1311201R0001	10	0.175
		42	0 0	B7-40-00-02	GJL1311201R0002	10	0.175
		48	0 0	B7-40-00-03	GJL1311201R0003	10	0.175
		110 ... 127	0 0	B7-40-00-84	GJL1311201R8004	10	0.175
		220 ... 240	0 0	B7-40-00-80	GJL1311201R8000	10	0.175

#### 2 N.O. + 2 N.C. main poles

20	300 V / 12 A	24	0 0	B6-22-00-01	GJL1211501R0001	10	0.175
		42	0 0	B6-22-00-02	GJL1211501R0002	10	0.175
		48	0 0	B6-22-00-03	GJL1211501R0003	10	0.175
		110 ... 127	0 0	B6-22-00-84	GJL1211501R8004	10	0.175
		220 ... 240	0 0	B6-22-00-80	GJL1211501R8000	10	0.175
20	600 V / 16 A	24	0 0	B7-22-00-01	GJL1311501R0001	10	0.175
		42	0 0	B7-22-00-02	GJL1311501R0002	10	0.175
		48	0 0	B7-22-00-03	GJL1311501R0003	10	0.175
		110 ... 127	0 0	B7-22-00-84	GJL1311501R8004	10	0.175
		220 ... 240	0 0	B7-22-00-80	GJL1311501R8000	10	0.175

Other types on request.

#### Main dimensions mm, inches

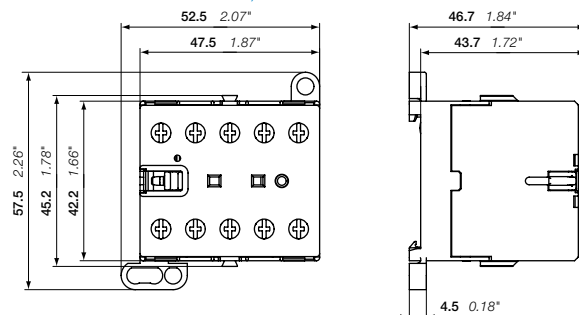

B6, B7

2CDC212001F0011

2CDC102009C0201

# BC6, B7D 4-pole mini contactors – with screw terminals

## 4 to 5.5 kW

### DC operated



BC6-22-00

2CDC21102RF0011

#### Description

BC6, B7D 4-pole mini contactors are compact control products mainly used for switching resistive loads up to 690 V AC.

These contactors are designed with:

- 4 main poles
- control circuit: DC operated
  - low coil consumption (3.5 W at pull-in and at holding).
- hum-free coil
- add-on auxiliary contact blocks for front or side mounting
- designed for rail or wall mounting.

#### Ordering details

IEC Rated operational current $\theta \leq 40^\circ\text{C}$ AC-1 A	UL/CSA General use rating	Rated control circuit voltage: $U_c$ V DC	Auxiliary contacts fitted 	Type	Order code	Pkg qty	Weight (1 pce) kg
<b>4 N.O. main poles</b>							
20	600 V / 16 A	24	0 0	B7D-40-00-01	GJL1317201R0001	10	0.175
		220	0 0	B7D-40-00-05	GJL1317201R0005	10	0.175
<b>2 N.O. + 2 N.C. main poles</b>							
20	300 V / 12 A	12	0 0	BC6-22-00-07	GJL1213501R0007	10	0.175
		24	0 0	BC6-22-00-01	GJL1213501R0001	10	0.175
		42	0 0	BC6-22-00-02	GJL1213501R0002	10	0.175
		48	0 0	BC6-22-00-16	GJL1213501R1006	10	0.175
		60	0 0	BC6-22-00-03	GJL1213501R0003	10	0.175
		110 ... 125	0 0	BC6-22-00-04	GJL1213501R0004	10	0.175
220 ... 240	0 0	BC6-22-00-05	GJL1213501R0005	10	0.175		

Other types on request.

#### Main dimensions mm, inches

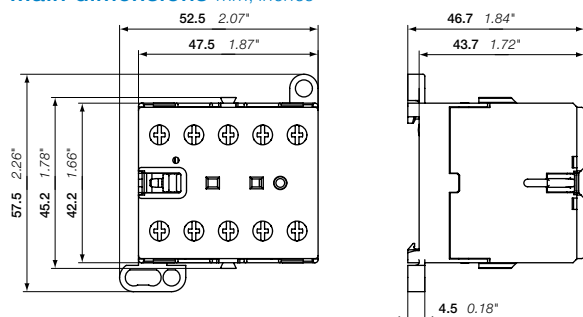

BC6, B7D

2CDC212001F0011

2CDC102021C0201

# TBC7 4-pole mini contactors – with screw terminals

## 4 to 5.5 kW

### DC operated – large coil voltage range



2CDC021102R0011

3

TBC7-31-00

#### Description

TBC7 4-pole mini contactors are compact control products mainly used for switching resistive or motor loads up to 690 V AC.

These contactors are designed with:

- 4 main poles
- control circuit: DC operated
  - low coil consumption (5 W at pull-in and at holding).
- hum-free coil
- expanded ambient temperature range -30 ... +70 °C and wide range voltage supply
- no auxiliary contact block permitted for mounting
- designed for rail or wall mounting
- material is approved for railway applications.

#### Ordering details

IEC Rated operational current $\theta \leq 40^\circ\text{C}$ AC-1 A	UL/CSA General use rating	Rated control circuit voltage $U_{C\text{min}} \dots U_{C\text{max}}$	Auxiliary contacts fitted 	Type	Order code	Pkg qty	Weight (1 pce) kg
--	---------------------------------	---	-------------------------------------	------	------------	------------	-------------------------

#### 3 N.O. + 1 N.C. main poles

20	600 V / 16 A	50 ... 90	0 0	TBC7-31-00-55	GJL1313461R5005	10	0.185
		77 ... 143	0 0	TBC7-31-00-62	GJL1313461R6002	10	0.185
		140 ... 260	0 0	TBC7-31-00-68	GJL1313461R6008	10	0.185

#### 2 N.O. + 2 N.C. main poles

20	600 V / 16 A	50 ... 90	0 0	TBC7-22-00-55	GJL1313561R5005	10	0.185
		77 ... 143	0 0	TBC7-22-00-62	GJL1313561R6002	10	0.185
		140 ... 260	0 0	TBC7-22-00-68	GJL1313561R6008	10	0.185

Other types on request.

#### Main dimensions mm, inches

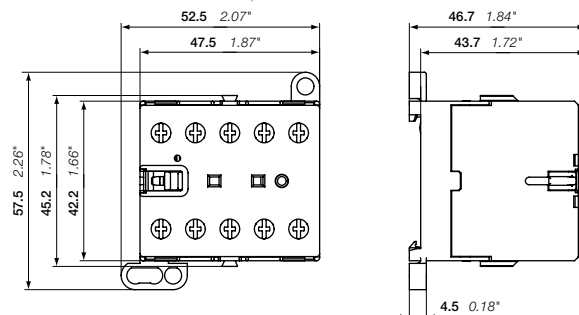

TBC7

2CDC0210201F0011

2CDC102022C0201



# K6 4-pole mini contactor relays – with screw terminals AC operated



2CDC211012F0011

K6-22Z



2CDC211004F0010

K6-31Z

## Description

K6 4-pole mini-contactor relays are space optimized control products mainly used for control functions or for small loads up to 4 A.

These contactors are designed with:

- 4-poles with various contact combinations
- control circuit: AC operated
  - low coil consumption (3.5 VA at pull-in and at holding).
  - hum-free coil
- add-on auxiliary contact blocks for front or side mounting
- designed for rail or wall mounting.

## Ordering details

Rated control circuit voltage $U_c$		Type	Order code	Pkg qty	Weight (1 pce)
50 Hz	60 Hz				kg
V AC	V AC				

### K6 4-pole mini contactor relays

24	24	K6-22Z-01	GJH1211001R0221	10	0.175
42	42	K6-22Z-02	GJH1211001R0222	10	0.175
48	48	K6-22Z-03	GJH1211001R0223	10	0.175
110 ...127	110 ...127	K6-22Z-84	GJH1211001R8224	10	0.175
220 ... 240	220 ... 240	K6-22Z-80	GJH1211001R8220	10	0.175
380 ... 415	380 ... 415	K6-22Z-85	GJH1211001R8225	10	0.175
24	24	K6-31Z-01	GJH1211001R0311	10	0.175
42	42	K6-31Z-02	GJH1211001R0312	10	0.175
48	48	K6-31Z-03	GJH1211001R0313	10	0.175
110 ...127	110 ...127	K6-31Z-84	GJH1211001R8314	10	0.175
220 ... 240	220 ... 240	K6-31Z-80	GJH1211001R8310	10	0.175
380 ... 415	380 ... 415	K6-31Z-85	GJH1211001R8315	10	0.175
24	24	K6-40E-01	GJH1211001R0401	10	0.175
42	42	K6-40E-02	GJH1211001R0402	10	0.175
48	48	K6-40E-03	GJH1211001R0403	10	0.175
110 ...127	110 ...127	K6-40E-84	GJH1211001R8404	10	0.175
220 ... 240	220 ... 240	K6-40E-80	GJH1211001R8400	10	0.175
380 ... 415	380 ... 415	K6-40E-85	GJH1211001R8405	10	0.175

Other types on request.

## Main dimensions mm, inches

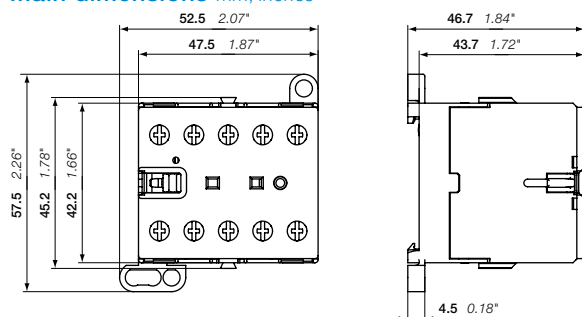

K6

2CDC21E001F0011

2CDC102011C0201

# KC6 4-pole mini contactor relays – with screw terminals DC operated



2CDC21101R0011

3

KC6-22Z

## Description

KC6 4-pole mini-contactor relays are space optimized control products mainly used for control functions or for small loads up to 4 A.

These contactors are designed with:

- 4-poles with various contact combinations
- control circuit: DC operated
  - low coil consumption (3.5 W at pull-in and at holding).
  - hum-free coil
- add-on auxiliary contact blocks for front or side mounting
- designed for rail or wall mounting.

## Ordering details

Rated control circuit voltage $U_c$	Type	Order code	Pkg qty	Weight (1 pce) kg
V DC				
<b>KC6 4-pole mini contactor relays</b>				
12	KC6-22Z-07	GJH1213001R0227	10	0.175
24	KC6-22Z-01	GJH1213001R0221	10	0.175
48	KC6-22Z-16	GJH1213001R1226	10	0.175
60	KC6-22Z-13	GJH1213001R1223	10	0.175
110 ... 125	KC6-22Z-04	GJH1213001R0224	10	0.175
220 ... 240	KC6-22Z-05	GJH1213001R0225	10	0.175
12	KC6-31Z-07	GJH1213001R0317	10	0.175
24	KC6-31Z-01	GJH1213001R0311	10	0.175
48	KC6-31Z-16	GJH1213001R1316	10	0.175
60	KC6-31Z-13	GJH1213001R1313	10	0.175
110 ... 125	KC6-31Z-04	GJH1213001R0314	10	0.175
220 ... 240	KC6-31Z-05	GJH1213001R0315	10	0.175
12	KC6-40E-07	GJH1213001R0407	10	0.175
24	KC6-40E-01	GJH1213001R0401	10	0.175
48	KC6-40E-16	GJH1213001R1406	10	0.175
60	KC6-40E-13	GJH1213001R1403	10	0.175
110 ... 125	KC6-40E-04	GJH1213001R0404	10	0.175
220 ... 240	KC6-40E-05	GJH1213001R0405	10	0.175

Other types on request.

## Main dimensions mm, inches

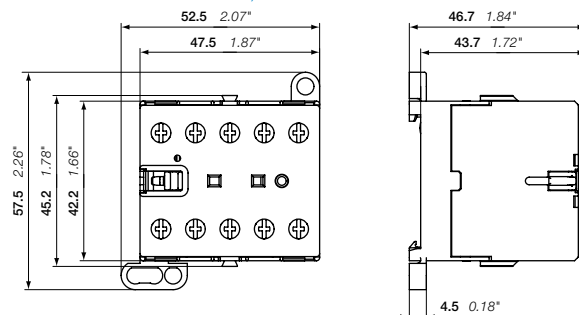

KC6

2CDC212001R0011

2CDC102012C0201

# KC6 4-pole interface mini contactor relays – with screw terminals DC operated



KC6-31Z

2CDC21101FF0011

## Description

KC6 4-pole interface mini-contactor relays are space optimized control products mainly used for control functions or for small loads up to 4 A.

These contactors are designed with:

- 4-poles with various contact combinations
- control circuit: DC operated
  - low coil consumption (1.4 ... 2.8 W at pull-in and at holding).
- hum-free coil
- no auxiliary contact block permitted for mounting
- designed for rail or wall mounting.

## Ordering details

Rated control circuit voltage $U_c$	Type	Order code	Pkg qty	Weight (1 pce) kg
<b>V DC</b>				
<b>DC operation 24 V / 1.4 W</b>				
24	KC6-31Z-1.4-81	GJH1213001R8311	10	0.175
24	KC6-40E-1.4-81	GJH1213001R8401	10	0.175
<b>DC operation 17 ... 32 V / 2.4 W</b>				
17 ... 32	KC6-31Z-2.4-51	GJH1213001R5311	10	0.175
17 ... 32	KC6-40E-2.4-51	GJH1213001R5401	10	0.175
<b>DC operation 24 V / 1.7 W</b>				
24	K6S-22Z-1.7-71	GJH1213001R7221	10	0.175
24	K6S-31Z-1.7-71	GJH1213001R7311	10	0.175
24	K6S-40E-1.7-71	GJH1213001R7401	10	0.175
<b>DC operation 17 ... 32 V / 2.8 W</b>				
17 ... 32	K6S-22Z-2.8-72	GJH1213001R7222	10	0.175
17 ... 32	K6S-31Z-2.8-72	GJH1213001R7312	10	0.175
17 ... 32	K6S-40E-2.8-72	GJH1213001R7402	10	0.175

Other types on request.

## Main dimensions mm, inches

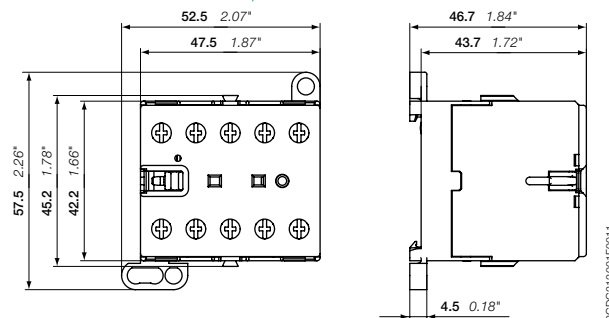

KC6

2CDC21101FF0011

2CDC102013C0201

# TKC6 4-pole mini contactor relays – with screw terminals

## DC operated – large coil voltage range



2CDC211021F0011

3

TKC6-31Z

### Description

TKC6 4-pole mini contactors are space optimized control products mainly used for control functions or for small loads up to 4 A.

These contactors are designed with:

- 4-poles with various contact combinations
- control circuit: DC operated, hum free, low consumption (5 W at pull-in and at holding)
- expanded ambient temperature range -30 ... +70 °C and wide range voltage supply
- material is suitable for railway applications
- humfree operating DC coil
- no auxiliary contact block permitted for mounting
- designed for rail or wall mounting.

### Ordering details

Rated control circuit voltage $U_{Cmin} \dots U_{Cmax}$	Type	Order code	Pkg qty	Weight (1 pce) kg
<b>V DC</b>				
<b>TKC6 mini contactors</b>				
17 ... 32	TKC6-22Z-51	GJH1213061R5221	10	0.180
50 ... 90	TKC6-22Z-55	GJH1213061R5225	10	0.180
77 ... 143	TKC6-22Z-62	GJH1213061R6222	10	0.180
140 ... 260	TKC6-22Z-68	GJH1213061R6228	10	0.180
17 ... 32	TKC6-31Z-51	GJH1213061R5311	10	0.180
50 ... 90	TKC6-31Z-55	GJH1213061R5315	10	0.180
77 ... 143	TKC6-31Z-62	GJH1213061R6312	10	0.180
140 ... 260	TKC6-31Z-68	GJH1213061R6318	10	0.180
17 ... 32	TKC6-40E-51	GJH1213061R5401	10	0.180
50 ... 90	TKC6-40E-55	GJH1213061R5405	10	0.180
77 ... 143	TKC6-40E-62	GJH1213061R6402	10	0.180
140 ... 260	TKC6-40E-68	GJH1213061R6408	10	0.180

Other types on request.

### Main dimensions mm, inches

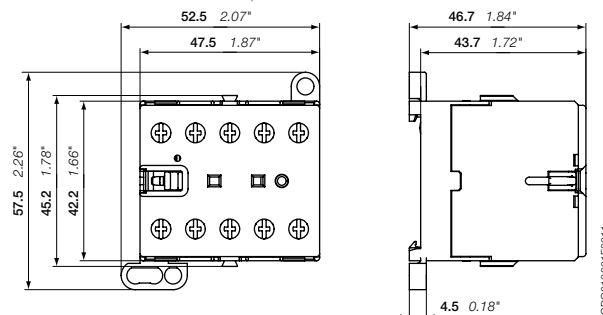

TKC6

2CDC212001F0011

2CDC102014C0201

# B6, B7 3-pole mini contactors – with soldering pins 4 to 5.5 kW AC operated



2CDC211003F0010

B6-30-10-P



2CDC211011F0011

B7-30-10-P

## Description

B6..P and B7..P 3-pole mini contactors are compact control products mainly used for switching resistive or motor loads up to 690 V AC.

These contactors are designed with:

- 3 main poles and one built-in auxiliary contact
- control circuit: AC operated
  - low coil consumption (3.5 VA at pull-in and at holding).
- hum-free coil
- add-on auxiliary contact blocks for side mounting
- designed for soldering on PCB boards.

## Ordering details

IEC	Rated operational power	UL/CSA	3-phase motor rating	General use rating	Rated control circuit voltage $U_c$		Auxiliary contacts fitted	Type	Order code	Pkg qty	Weight (1 pce)
					50 Hz	60 Hz					
400 V AC-3 kW	AC-1 A	hp	480 V		V AC	V AC					kg

### B6 mini contactors

4	12	3	300 V / 12 A	24	24	1 0	B6-30-10-P-01	GJL1211009R0101	10	0.170
						0 1	B6-30-01-P-01	GJL1211009R0011	10	0.170
				42	42	1 0	B6-30-10-P-02	GJL1211009R0102	10	0.170
						0 1	B6-30-01-P-02	GJL1211009R0012	10	0.170
				48	48	1 0	B6-30-10-P-03	GJL1211009R0103	10	0.170
						0 1	B6-30-01-P-03	GJL1211009R0013	10	0.170
				110 ... 127	110 ... 127	1 0	B6-30-10-P-84	GJL1211009R8104	10	0.170
						0 1	B6-30-01-P-84	GJL1211009R8014	10	0.170
				220 ... 240	220 ... 240	1 0	B6-30-10-P-80	GJL1211009R8100	10	0.170
						0 1	B6-30-01-P-80	GJL1211009R8010	10	0.170
				380 ... 415	380 ... 415	1 0	B6-30-10-P-85	GJL1211009R8105	10	0.170
						0 1	B6-30-01-P-85	GJL1211009R8015	10	0.170

### B7 mini contactors

5.5	12	5	600 V / 16 A	24	24	1 0	B7-30-10-P-01	GJL1311009R0101	10	0.170
						0 1	B7-30-01-P-01 <th>GJL1311009R0011</th> <td>10</td> <td>0.170</td>	GJL1311009R0011	10	0.170
				42	42	1 0	B7-30-10-P-02	GJL1311009R0102	10	0.170
						0 1	B7-30-01-P-02	GJL1311009R0012	10	0.170
				48	48	1 0	B7-30-10-P-03	GJL1311009R0103	10	0.170
						0 1	B7-30-01-P-03	GJL1311009R0013	10	0.170
				110 ... 127	110 ... 127	1 0	B7-30-10-P-84	GJL1311009R8104	10	0.170
						0 1	B7-30-01-P-84	GJL1311009R8014	10	0.170
				220 ... 240	220 ... 240	1 0	B7-30-10-P-80	GJL1311009R8100	10	0.170
						0 1	B7-30-01-P-80	GJL1311009R8010	10	0.170
				380 ... 415	380 ... 415	1 0	B7-30-10-P-85	GJL1311009R8105	10	0.170
						0 1	B7-30-01-P-85	GJL1311009R8015	10	0.170

Other types on request.

## Main dimensions mm, inches

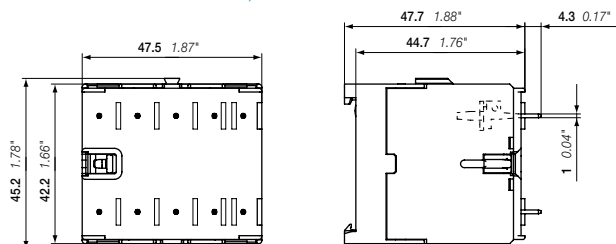

B6, B7

2CDC212003F0011

2CDC102023C0201

# BC6, BC7 3-pole mini contactors – with soldering pins

## 4 to 5.5 kW

### DC operated



2CDC211036R0011

BC7-30-10-P

3

#### Description

BC6, BC7 3-pole mini contactors are compact control products mainly used for switching resistive or motor loads up to 690 V AC.

These contactors are designed with:

- 3 main poles and one built-in auxiliary contact
- control circuit: DC operated
  - low coil consumption (3.5 W at pull-in and at holding).
- hum-free coil
- add-on auxiliary contact blocks for side mounting
- designed for soldering on PCB boards.

#### Ordering details

IEC	UL/CSA	Rated control circuit voltage $U_c$	Auxiliary contacts fitted	Type	Order code	Pkg qty	Weight (1 pce)				
Rated operational power $\theta \leq 40^\circ\text{C}$	3-phase motor rating	General use rating									
400 V AC-3 kW	AC-1 A hp	480 V hp	V DC				kg				
<b>BC6 mini contactors with 3 N.O. main poles</b>											
4	12	3	300 V / 12 A	1 0	BC6-30-10-P-07	GJL1213009R0107	10	0.170			
					0 1	BC6-30-01-P-07	GJL1213009R0017	10	0.170		
				24	1 0	BC6-30-10-P-01	GJL1213009R0101	10	0.170		
					0 1	BC6-30-01-P-01	GJL1213009R0011	10	0.170		
				48	1 0	BC6-30-10-P-16	GJL1213009R1106	10	0.170		
					0 1	BC6-30-01-P-16	GJL1213009R1016	10	0.170		
				60	1 0	BC6-30-10-P-03	GJL1213009R0103	10	0.170		
					0 1	BC6-30-01-P-03	GJL1213009R0013	10	0.170		
				110 ... 125	1 0	BC6-30-10-P-04	GJL1213009R0104	10	0.170		
					0 1	BC6-30-01-P-04	GJL1213009R0014	10	0.170		
				220 ... 240	1 0	BC6-30-10-P-05	GJL1213009R0105	10	0.170		
					0 1	BC6-30-01-P-05	GJL1213009R0015	10	0.170		
				<b>BC7 mini contactors with 3 N.O. main poles</b>							
				5.5	12	5	600 V / 16 A	1 0	BC7-30-10-P-07	GJL1313009R0107	10
0 1	BC7-30-01-P-07	GJL1313009R0017	10						0.170		
24	1 0	BC7-30-10-P-01	GJL1313009R0101					10	0.170		
	0 1	BC7-30-01-P-01	GJL1313009R0011					10	0.170		
48	1 0	BC7-30-10-P-16	GJL1313009R1106					10	0.170		
	0 1	BC7-30-01-P-16	GJL1313009R1016					10	0.170		
60	1 0	BC7-30-10-P-03	GJL1313009R0103					10	0.170		
	0 1	BC7-30-01-P-03	GJL1313009R0013					10	0.170		
110 ... 125	1 0	BC7-30-10-P-04	GJL1313009R0104					10	0.170		
	0 1	BC7-30-01-P-04	GJL1313009R0014					10	0.170		
220 ... 240	1 0	BC7-30-10-P-05	GJL1313009R0105					10	0.170		
	0 1	BC7-30-01-P-05	GJL1313009R0015					10	0.170		
<b>BC6 mini contactors 2 N.O. + 1 N.C. main poles</b>											
4	12	3	300 V / 12 A					1 0	BC6-21-10-P-01	GJL1213109R0101	10
				1 0	BC6-21-10-P-16	GJL1213109R1106	10		0.170		
				1 0	BC6-21-10-P-03	GJL1213109R0103	10		0.170		
				1 0	BC6-21-10-P-04	GJL1213109R0104	10		0.170		
				1 0	BC6-21-10-P-05	GJL1213109R0105	10		0.170		

Other types on request.

#### Main dimensions mm, inches

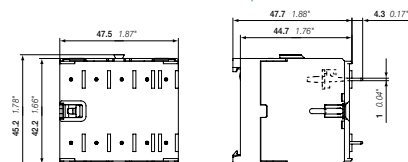

2CDC211036R0011

B6, B7

2CDC102024C0201

# VB6, VB7 3-pole mini reversing contactors – with soldering pins 4 to 5.5 kW AC operated



VB7-30-10-P

2CDC211010S0011

## Description

VB6, VB7 3-pole compact design reversing contactors are space optimized control products mainly used for switching resistive or motor loads up to 690 V AC.

These reversing contactors are designed with:

- built-in mechanical interlock. The coils must be mutually interlocked electrically and coils must be de-energised for 50 ms at least to prevent phase to phase short circuit on the arc
- control circuit: AC operated
  - low coil consumption (3.5 VA at pull-in and at holding).
- hum-free coil
- no auxiliary contact block permitted for mounting
- designed for soldering on PCB boards.

## Ordering details

IEC Rated operational power	UL/CSA 3-phase motor rating 480 V AC-1 A	General use rating hp	Rated control circuit voltage $U_c$		Auxiliary contacts fitted	Type	Order code	Pkg qty	Weight (1 pce) kg
			50 Hz V AC	60 Hz V AC					
400 V AC-3 kW									

### VB6 mini reversing contactors

4	12	3	300 V / 12 A	24	24	1 0	VB6-30-10-P-01	GJL1211909R0101	5	0.345
						0 1	VB6-30-01-P-01	GJL1211909R0011	5	0.345
				42	42	1 0	VB6-30-10-P-02	GJL1211909R0102	5	0.345
						0 1	VB6-30-01-P-02	GJL1211909R0012	5	0.345
				48	48	1 0	VB6-30-10-P-03	GJL1211909R0103	5	0.345
						0 1	VB6-30-01-P-03	GJL1211909R0013	5	0.345
				110 ... 127	110 ... 127	1 0	VB6-30-10-P-84	GJL1211909R8104	5	0.345
						0 1	VB6-30-01-P-84	GJL1211909R8014	5	0.345
				220 ... 240	220 ... 240	1 0	VB6-30-10-P-80	GJL1211909R8100	5	0.345
						0 1	VB6-30-01-P-80	GJL1211909R8010	5	0.345
				380 ... 415	380 ... 415	1 0	VB6-30-10-P-85	GJL1211909R8105	5	0.345
						0 1	VB6-30-01-P-85	GJL1211909R8015	5	0.345

### VB7 mini reversing contactors

5.5	12	5	600 V / 16 A	24	24	1 0	VB7-30-10-P-01	GJL1311909R0101	5	0.345
						0 1	VB7-30-01-P-01 <td>GJL1311909R0011</td> <td>5</td> <td>0.345</td>	GJL1311909R0011	5	0.345
				42	42	1 0	VB7-30-10-P-02	GJL1311909R0102	5	0.345
						0 1	VB7-30-01-P-02	GJL1311909R0012	5	0.345
				48	48	1 0	VB7-30-10-P-03	GJL1311909R0103	5	0.345
						0 1	VB7-30-01-P-03	GJL1311909R0013	5	0.345
				110 ... 127	110 ... 127	1 0	VB7-30-10-P-84	GJL1311909R8104	5	0.345
						0 1	VB7-30-01-P-84	GJL1311909R8014	5	0.345
				220 ... 240	220 ... 240	1 0	VB7-30-10-P-80	GJL1311909R8100	5	0.345
						0 1	VB7-30-01-P-80	GJL1311909R8010	5	0.345
				380 ... 415	380 ... 415	1 0	VB7-30-10-P-85	GJL1311909R8105	5	0.345
						0 1	VB7-30-01-P-85	GJL1311909R8015	5	0.345

Other types on request.

## Main dimensions mm, inches

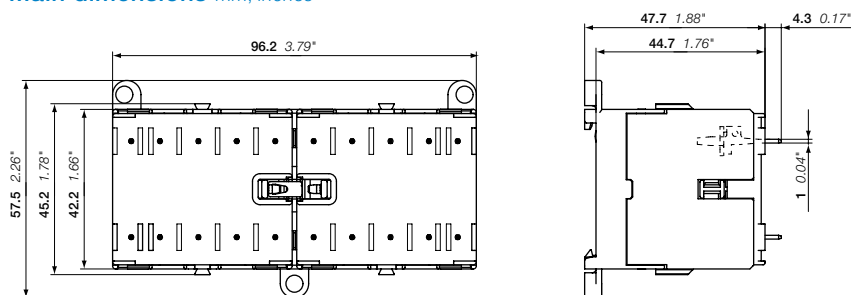

VB6, VB7

2CDC212001F0011

2CDC102025C0201



# VBC6, VBC7 3-pole mini reversing contactors – with soldering pins

## 4 to 5.5 kW

### DC operated



2CDC21008F0011

3

VBC7-30-10-P

#### Description

VBC6, VBC7 3-pole compact design reversing contactors are space optimized control products mainly used for switching resistive or motor loads up to 690 V AC.

These reversing contactors are designed with:

- built-in mechanical interlock. The coils must be mutually interlocked electrically and coils must be de-energised for 50 ms at least to prevent phase to phase short circuit on the arc
- control circuit: DC operated
  - low coil consumption (3.5 W at pull-in and at holding).
- hum-free coil
- no auxiliary contact block permitted for mounting
- designed for soldering on PCB boards.

#### Ordering details

IEC	UL/CSA	Rated control circuit voltage $U_c$	Auxiliary contacts fitted	Type	Order code	Pkg qty	Weight (1 pce)
Rated operational power 400 V AC-3 kW	3-phase motor rating $\theta \leq 40^\circ\text{C}$ 480 V AC-1 A hp	General use rating V DC					kg

#### VBC6 mini reversing contactors

Rated power (kW)	Rated current (A)	Rated voltage (V)	Rated current (A)	Rated voltage (V)	Rated current (A)	Rated voltage (V)	Order code	Pkg qty	Weight (kg)	
4	12	3	300 V / 12 A	12	1	0	VBC6-30-10-P-07	GJL1213909R0107	5	0.345
					0	1	VBC6-30-01-P-07	GJL1213909R0017	5	0.345
				24	1	0	VBC6-30-10-P-01	GJL1213909R0101	5	0.345
					0	1	VBC6-30-01-P-01	GJL1213909R0011	5	0.345
				48	1	0	VBC6-30-10-P-06	GJL1213909R0106	5	0.345
					0	1	VBC6-30-06-P-06	GJL1213909R0016	5	0.345
				60	1	0	VBC6-30-10-P-03	GJL1213909R0103	5	0.345
					0	1	VBC6-30-01-P-03	GJL1213909R0013	5	0.345
				110 ... 125	1	0	VBC6-30-10-P-04	GJL1213909R0104	5	0.345
					0	1	VBC6-30-01-P-04	GJL1213909R0014	5	0.345
				220 ... 240	1	0	VBC6-30-10-P-05	GJL1213909R0105	5	0.345
					0	1	VBC6-30-01-P-05	GJL1213909R0015	5	0.345

#### VBC7 mini reversing contactors

Rated power (kW)	Rated current (A)	Rated voltage (V)	Rated current (A)	Rated voltage (V)	Rated current (A)	Rated voltage (V)	Order code	Pkg qty	Weight (kg)	
5.5	12	5	600 V / 16 A	12	1	0	VBC7-30-10-P-07	GJL1313909R0107	5	0.345
					0	1	VBC7-30-01-P-07	GJL1313909R0017	5	0.345
				24	1	0	VBC7-30-10-P-01	GJL1313909R0101	5	0.345
					0	1	VBC7-30-01-P-01	GJL1313909R0011	5	0.345
				48	1	0	VBC7-30-10-P-16	GJL1313909R1106	5	0.345
					0	1	VBC7-30-01-P-16	GJL1313909R1016	5	0.345
				60	1	0	VBC7-30-10-P-03	GJL1313909R0103	5	0.345
					0	1	VBC7-30-01-P-03	GJL1313909R0013	5	0.345
				110 ... 125	1	0	VBC7-30-10-P-04	GJL1313909R0104	5	0.345
					0	1	VBC7-30-01-P-04	GJL1313909R0014	5	0.345
				220 ... 240	1	0	VBC7-30-10-P-05	GJL1313909R0105	5	0.345
					0	1	VBC7-30-01-P-05	GJL1313909R0015	5	0.345

Other types on request.

#### Main dimensions mm, inches

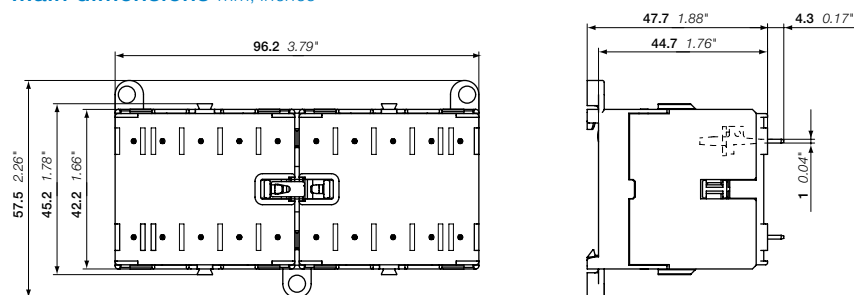

VBC6, VBC7

2CDC21007F0011

2CDC102026C0201

# VB6A, VB7A 3-pole mini reversing contactors – with soldering pins

## 4 to 5.5 kW

### AC operated – with safety blocking function



VB7-30-01-P

2CDC211019F0010

#### Description

VB6A, VB7A 3-pole compact design reversing contactors are space optimized control products mainly used for switching resistive or motor loads up to 690 V AC.

These reversing contactors are designed with:

- built-in mechanical interlock and safety blocking function. The safety blocking function is triggered if the voltage is applied to the coil of the contactor to be switched on before the contactor to be switched off has dropped out. The contactor coils are designed for continuous operation when the contactor is de-energised i.e. the coil is not damaged if the mechanical interlock prevents switch-on of the contactor with the coil voltage applied.
- control circuit: AC operated
  - low coil consumption (3.5 VA at pull-in and at holding).
  - hum-free coil
- no auxiliary contact block permitted for mounting
- designed for soldering on PCB boards.

#### Ordering details

IEC		UL/CSA		Rated control circuit voltage $U_c$		Auxiliary contacts fitted	Type	Order code	Pkg qty	Weight (1 pce)
Rated power	operational current $\theta \leq 40^\circ\text{C}$	3-phase motor rating	General use rating	50 Hz	60 Hz					
400 V AC-3 kW	AC-1 A	hp		V AC	V AC					kg

#### VB6A mini reversing contactors with safety blocking function

4	12	3	300 V / 12 A	24	24	1 0	VB6A-30-10-P-01	GJL1211919R0101	5	0.345
						0 1	VB6A-30-01-P-01	GJL1211919R0011	5	0.345
				42	42	1 0	VB6A-30-10-P-02	GJL1211919R0102	5	0.345
						0 1	VB6A-30-01-P-02	GJL1211919R0012	5	0.345
				48	48	1 0	VB6A-30-10-P-03	GJL1211919R0103	5	0.345
						0 1	VB6A-30-01-P-03	GJL1211919R0013	5	0.345
				110 ... 127	110 ... 127	1 0	VB6A-30-10-P-84	GJL1211919R8104	5	0.345
						0 1	VB6A-30-01-P-84	GJL1211919R8014	5	0.345
				220 ... 240	220 ... 240	1 0	VB6A-30-10-P-80	GJL1211919R8100	5	0.345
						0 1	VB6A-30-01-P-80	GJL1211919R8010	5	0.345
				380 ... 415	380 ... 415	1 0	VB6A-30-10-P-85	GJL1211919R8105	5	0.345
						0 1	VB6A-30-01-P-85	GJL1211919R8015	5	0.345

#### VB7A mini reversing contactors with safety blocking function

5.5	12	5	600 V / 16 A	24	24	1 0	VB7A-30-10-P-01	GJL1311919R0101	5	0.345
						0 1	VB7A-30-01-P-01	GJL1311919R0011	5	0.345
				42	42	1 0	VB7A-30-10-P-02	GJL1311919R0102	5	0.345
						0 1	VB7A-30-01-P-02	GJL1311919R0012	5	0.345
				48	48	1 0	VB7A-30-10-P-03	GJL1311919R0103	5	0.345
						0 1	VB7A-30-01-P-03	GJL1311919R0013	5	0.345
				110 ... 127	110 ... 127	1 0	VB7A-30-10-P-84	GJL1311919R8104	5	0.345
						0 1	VB7A-30-01-P-84	GJL1311919R8014	5	0.345
				220 ... 240	220 ... 240	1 0	VB7A-30-10-P-80	GJL1311919R8100	5	0.345
						0 1	VB7A-30-01-P-80	GJL1311919R8010	5	0.345
				380 ... 415	380 ... 415	1 0	VB7A-30-10-P-85	GJL1311919R8105	5	0.345
						0 1	VB7A-30-01-P-85	GJL1311919R8015	5	0.345

Other types on request.

#### Main dimensions mm, inches

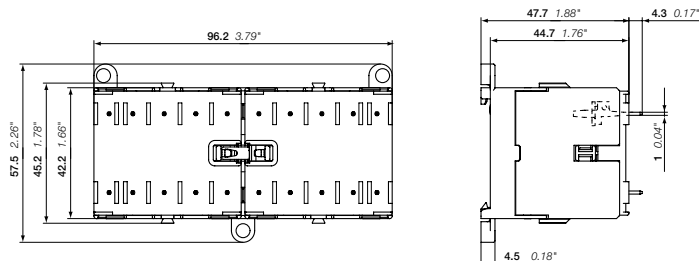

VB6A, VB7A

2CDC21007F0011

2CDC102027C0201

# VBC7A 3-pole mini reversing contactors – with soldering pins

## 4 to 5.5 kW

### DC operated – with safety blocking function



2CDC21008F0011

3

VBC7A-30-10-P

#### Description

VBC7A 3-pole compact design reversing contactors are space optimized control products mainly used for switching resistive or motor loads up to 690 V AC.

These reversing contactors are designed with:

- built-in mechanical interlock and safety blocking function. The safety blocking function is triggered if the voltage is applied to the coil of the contactor to be switched on before the contactor to be switched off has dropped out. The contactor coils are designed for continuous operation when the contactor is de-energised i.e. the coil is not damaged if the mechanical interlock prevents switch-on of the contactor with the coil voltage applied.
- control circuit: AC operated
  - low coil consumption (3.5 W at pull-in and at holding).
- hum-free coil
- no auxiliary contact block permitted for mounting
- designed for soldering on PCB boards.

#### Ordering details

IEC		UL/CSA		Rated control circuit voltage $U_c$	Auxiliary contacts fitted	Type	Order code	Pkg qty	Weight (1 pce)
Rated operational power	current $\theta \leq 40^\circ\text{C}$	3-phase motor rating	General use rating						
400 V AC-3 kW	AC-1 A	480 V hp		V DC					kg

#### VBC7A mini reversing contactors with safety blocking function

Rated power (kW)	Rated current (A)	Motor rating (hp)	Rated voltage (V)	Rated current (A)	0	1	Order code	Order code	Pkg qty	Weight (kg)
5.5	12	5	600 V / 16 A	12	1	0	VBC7A-30-10-P-07	GJL1313919R0107	5	0.345
					0	1	VBC7A-30-01-P-07	GJL1313919R0017	5	0.345
				24	1	0	VBC7A-30-10-P-01	GJL1313919R0101	5	0.345
					0	1	VBC7A-30-01-P-01	GJL1313919R0011	5	0.345
				48	1	0	VBC7A-30-10-P-16	GJL1313919R1106	5	0.345
					0	1	VBC7A-30-01-P-16	GJL1313919R1016	5	0.345
				60	1	0	VBC7A-30-10-P-03	GJL1313919R0103	5	0.345
					0	1	VBC7A-30-01-P-03	GJL1313919R0013	5	0.345
				110 ... 125	1	0	VBC7A-30-10-P-04	GJL1313919R0104	5	0.345
					0	1	VBC7A-30-01-P-04	GJL1313919R0014	5	0.345
				220 ... 240	1	0	VBC7A-30-10-P-05	GJL1313919R0105	5	0.345
					0	1	VBC7A-30-01-P-05	GJL1313919R0015	5	0.345

Other types on request.

#### Main dimensions mm, inches

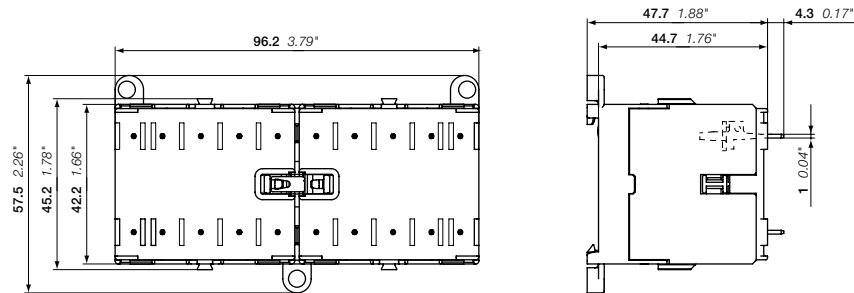

VBC7A

2CDC21007F0011

2CDC102028C0201

# K6 4-pole mini contactor relays – with soldering pins AC operated



2CDC21102ZF0011

K6-22Z-P

## Description

K6 4-pole mini-contactor relays are space optimized control products mainly used for control functions or for small loads up to 4 A.

These contactors are designed with:

- 4-poles with various contact combinations
- control circuit: AC operated
  - low coil consumption (3.5 VA at pull-in and at holding).
- hum-free coil
- add-on auxiliary contact block for side mounting
- designed for soldering on PCB boards.

## Ordering details

Rated control circuit voltage $U_c$		Type	Order code	Pkg qty	Weight (1 pce)
50 Hz V AC	60 Hz V AC				

### K6 4-pole mini contactor relays

24	24	K6-22Z-P-01	GJH1211009R0221	10	0.170
42	42	K6-22Z-P-02	GJH1211009R0222	10	0.170
48	48	K6-22Z-P-03	GJH1211009R0223	10	0.170
110 ...127	110 ...127	K6-22Z-P-84	GJH1211009R8224	10	0.170
220 ... 240	220 ... 240	K6-22Z-P-80	GJH1211009R8220	10	0.170
380 ... 415	380 ... 415	K6-22Z-P-85	GJH1211009R8225	10	0.170
24	24	K6-31Z-P-01	GJH1211009R0311	10	0.170
42	42	K6-31Z-P-02	GJH1211009R0312	10	0.170
48	48	K6-31Z-P-03	GJH1211009R0313	10	0.170
110 ...127	110 ...127	K6-31Z-P-84	GJH1211009R8314	10	0.170
220 ... 240	220 ... 240	K6-31Z-P-80	GJH1211009R8310	10	0.170
380 ... 415	380 ... 415	K6-31Z-P-85	GJH1211009R8315	10	0.170
24	24	K6-40E-P-01	GJH1211009R0401	10	0.170
42	42	K6-40E-P-02	GJH1211009R0402	10	0.170
48	48	K6-40E-P-03	GJH1211009R0403	10	0.170
110 ...127	110 ...127	K6-40E-P-84	GJH1211009R8404	10	0.170
220 ... 240	220 ... 240	K6-40E-P-80	GJH1211009R8400	10	0.170
380 ... 415	380 ... 415	K6-40E-P-85	GJH1211009R8405	10	0.170

Other types on request.

## Main dimensions mm, inches

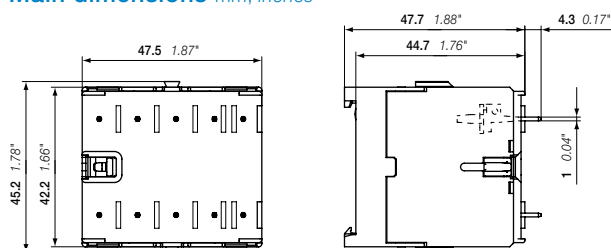

K6

2CDC212003F0011

2CDC102030C0201

# KC6 4-pole mini contactor relays – with soldering pins DC operated



2CDC211023F0011

3 KC6-22Z-P



2CDC211023F0011

KC6-31Z-P

## Description

KC6 4-pole mini-contactor relays are space optimized control products mainly used for control functions or for small loads up to 4 A.

These contactors are designed with:

- 4-poles with various contact combinations
- control circuit: DC operated
  - low coil consumption (3.5 W at pull-in and at holding).
- hum-free coil
- add-on auxiliary contact block for side mounting
- designed for soldering on PCB boards.

## Ordering details

Rated control circuit voltage $U_c$	Type	Order code	Pkg qty	Weight (1 pce) kg
V DC				
<b>K6 4-pole mini contactor relays</b>				
12	KC6-22Z-P-07	GJH1213009R0227	10	0.170
24	KC6-22Z-P-01	GJH1213009R0221	10	0.170
48	KC6-22Z-P-16	GJH1213009R1226	10	0.170
110 ... 125	KC6-22Z-P-04	GJH1213009R0224	10	0.170
220 ... 240	KC6-22Z-P-05	GJH1213009R0225	10	0.170
24	KC6-31Z-P-01	GJH1213009R0311	10	0.170
48	KC6-31Z-P-16	GJH1213009R1316	10	0.170
110 ... 125	KC6-31Z-P-04	GJH1213009R0314	10	0.170
220 ... 240	KC6-31Z-P-05	GJH1213009R0315	10	0.170
12	KC6-40E-P-07	GJH1213009R0407	10	0.170
24	KC6-40E-P-01	GJH1213009R0401	10	0.170
48	KC6-40E-P-16	GJH1213009R1406	10	0.170
110 ... 125	KC6-40E-P-04	GJH1213009R0404	10	0.170
220 ... 240	KC6-40E-P-05	GJH1213009R0405	10	0.170

Other types on request.

## Main dimensions mm, inches

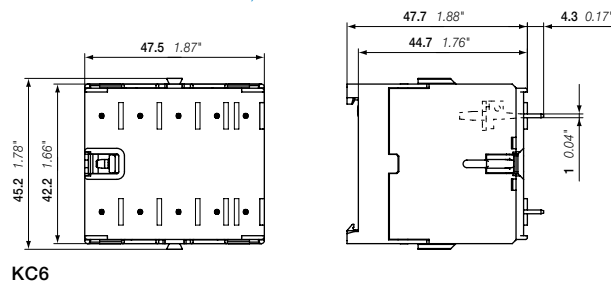

2CDC211023F0011

2CDC102031C0201

# BC6, BC7 3-pole interface mini contactors – with soldering pins

## 4 to 5.5 kW

### DC operated



2CDC211038F0011

BC7-30-10-P

#### Description

BC6, BC7 3-pole interface mini contactors are compact control products mainly used for switching resistive or motor loads up to 690 V AC.

These contactors are designed with:

- 3 main poles and one built-in auxiliary contact
- control circuit: DC operated
  - low coil consumption (1.4 ... 2.4 W at pull-in and at holding).
- hum-free coil
- no auxiliary contact block permitted for mounting
- designed for soldering on PCB boards.

#### Ordering details

IEC	UL/CSA	Rated control circuit voltage: $U_c$	Auxiliary contacts fitted	Type	Order code	Pkg qty	Weight (1 pce)
Rated operational power 400 V AC-3 kW	3-phase motor rating $\theta \leq 40^\circ\text{C}$ AC-1 hp	General use rating 300 V / 12 A 480 V / 16 A					kg

#### DC operation 24 V / 1.4 W

4	12	3	300 V / 12 A	24	1 0	BC6-30-10-P-1.4-81	GJL1213009R8101	10	0.170
					0 1	BC6-30-01-P-1.4-81	GJL1213009R8011	10	0.170
5.5	12	5	600 V / 16 A	24	1 0	BC7-30-10-P-1.4-81	GJL1313009R8101	10	0.170
					0 1	BC7-30-01-P-1.4-81	GJL1313009R8011	10	0.170

#### DC operation 17 ... 32 V / 2.4 W, $I_{th} < 8\text{ A}$

4	12	3	300 V / 12 A	17 ... 32	1 0	BC6-30-10-P-2.4-51	GJL1213009R5101	10	0.170
					0 1	BC6-30-01-P-2.4-51	GJL1213009R5011	10	0.170
5.5	12	5	600 V / 16 A	17 ... 32	1 0	BC7-30-10-P-2.4-51	GJL1313009R5101	10	0.170
					0 1	BC7-30-01-P-2.4-51	GJL1313009R5011	10	0.170

Other types on request.

#### Main dimensions mm, inches

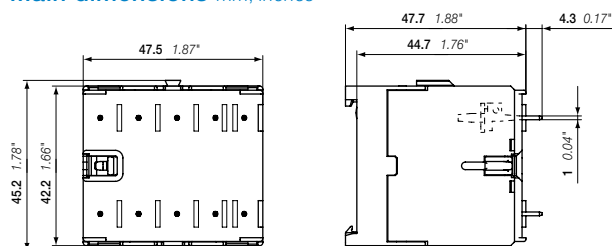

BC6, BC7

2CDC211038F0011

2CDC102028 C0201

# KC6 4-pole interface mini contactor relays – with solderings pins DC operated



2CDC211023F0011

KC6-31Z-P-1.4

3

## Description

KC6 4-pole interface mini-contactor relays are space optimized control products mainly used for control functions or for small loads up to 4 A.

These contactors are designed with:

- 4-poles with various contact combinations
- control circuit: DC operated
  - low coil consumption (3.5 W at pull-in and at holding).
- hum-free coil
- add-on auxiliary contact block for side mounting
- designed for soldering on PCB boards.

## Ordering details

Rated control circuit voltage $U_c$	Type	Order code	Pkg qty	Weight (1 pce)
V DC				kg
<b>DC operation 24 V / 1.4 W</b>				
24	KC6-31Z-P-1.4-81	GJH1213009R8311	10	0.170
24	KC6-40E-P-1.4-81	GJH1213009R8401	10	0.170
<b>DC operation 17 ... 32 V / 2.4 W</b>				
17 ... 32	KC6-31Z-P-2.4-51	GJH1213009R5311	10	0.170
17 ... 32	KC6-40E-P-2.4-51	GJH1213009R5401	10	0.170

Other types on request.

## Main dimensions mm, inches

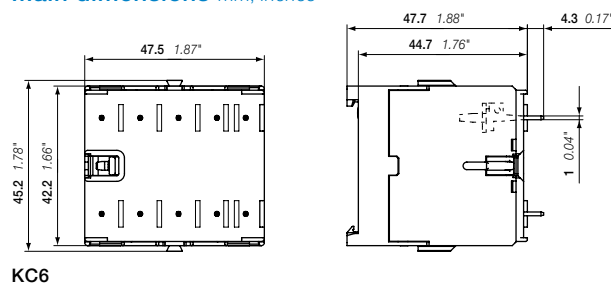

KC6

2CDC211023F0011

2CDC102032C0201



# B6, B7 3-pole mini contactors – with flat pin connection

## 4 to 5.5 kW

### AC operated



2CDC211002F0010

B6-30-10-F



2CDC211031F0011

B7-30-10-F

#### Description

B6..F, B7..F 3-pole mini contactors are compact control products mainly used for switching resistive or motor loads up to 690 V AC.

These contactors are designed with:

- flat pin connection for plug-in wiring and shake proven connection
- 3 main poles and one built-in auxiliary contact
- control circuit: AC operated
  - low coil consumption (3.5 VA at pull-in and at holding).
- hum-free coil
- add-on auxiliary contact blocks for side mounting
- designed for rail or wall mounting.

#### Ordering details

IEC	UL/CSA	Rated control circuit voltage $U_c$	Auxiliary contacts fitted	Type	Order code	Pkg qty	Weight (1 pce)
Rated operational power	3-phase motor rating $\theta \leq 40^\circ\text{C}$	General use rating					kg
400 V AC-3 kW	AC-1 A hp	300 V / 12 A	50 Hz V AC	60 Hz V AC			

#### B6 mini contactors

Rated operational power	3-phase motor rating	General use rating	Rated control circuit voltage $U_c$	Auxiliary contacts fitted	Type	Order code	Pkg qty	Weight (1 pce)		
4	20	3	300 V / 12 A	24	0	B6-30-10-F-01	GJL1211003R0101	10	0.170	
					1	B6-30-01-F-01	GJL1211003R0011	10	0.170	
				42	0	B6-30-10-F-02	GJL1211003R0102	10	0.170	
					1	B6-30-01-F-02	GJL1211003R0012	10	0.170	
				48	0	B6-30-10-F-03	GJL1211003R0103	10	0.170	
					1	B6-30-01-F-03	GJL1211003R0013	10	0.170	
				110 ... 127	110 ... 127	0	B6-30-10-F-84	GJL1211003R8104	10	0.170
						1	B6-30-01-F-84	GJL1211003R8014	10	0.170
				220 ... 240	220 ... 240	0	B6-30-10-F-80	GJL1211003R8100	10	0.170
						1	B6-30-01-F-80	GJL1211003R8010	10	0.170
				380 ... 415	380 ... 415	0	B6-30-10-F-85	GJL1211003R8105	10	0.170
						1	B6-30-01-F-85	GJL1211003R8015	10	0.170

#### B7 mini contactors

Rated operational power	3-phase motor rating	General use rating	Rated control circuit voltage $U_c$	Auxiliary contacts fitted	Type	Order code	Pkg qty	Weight (1 pce)		
5.5	20	5	600 V / 16 A	24	0	B7-30-10-F-01	GJL1311003R0101	10	0.170	
					1	B7-30-01-F-01	GJL1311003R0011	10	0.170	
				42	0	B7-30-10-F-02	GJL1311003R0102	10	0.170	
					1	B7-30-01-F-02	GJL1311003R0012	10	0.170	
				48	0	B7-30-10-F-03	GJL1311003R0103	10	0.170	
					1	B7-30-01-F-03	GJL1311003R0013	10	0.170	
				110 ... 127	110 ... 127	0	B7-30-10-F-84	GJL1311003R8104	10	0.170
						1	B7-30-01-F-84	GJL1311003R8014	10	0.170
				220 ... 240	220 ... 240	0	B7-30-10-F-80	GJL1311003R8100	10	0.170
						1	B7-30-01-F-80	GJL1311003R8010	10	0.170
				380 ... 415	380 ... 415	0	B7-30-10-F-85	GJL1311003R8105	10	0.170
						1	B7-30-01-F-85	GJL1311003R8015	10	0.170

Other types on request.

#### Main dimensions mm, inches

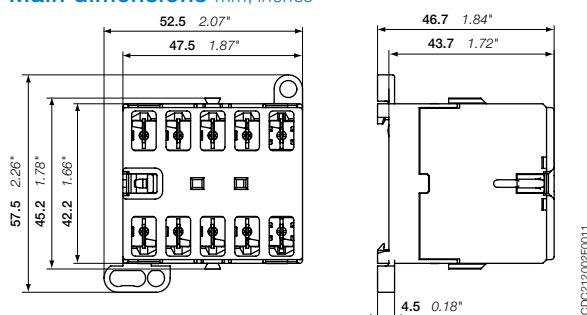

B6, B7

2CDC211002F0010

2CDC1020300201

# BC6, BC7 3-pole mini contactors – with flat pin connection

## 4 to 5.5 kW

### DC operated



2CDC211041F0011

BC6-30-10-F

3



2CDC211024F0011

BC7-30-10-F

#### Description

BC6, BC7 3-pole mini contactors are compact control products mainly used for switching resistive or motor loads up to 690 V AC.

These contactors are designed with:

- flat pin connection for plug-in wiring and shake proven connection
- 3 main poles and one built-in auxiliary contact
- control circuit: DC operated
  - low coil consumption (3.5 W at pull-in and at holding).
- hum-free coil
- add-on auxiliary contact blocks for side mounting
- designed for rail or wall mounting.

#### Ordering details

IEC	UL/CSA		Rated control circuit voltage $U_c$	Auxiliary contacts fitted	Type	Order code	Pkg qty	Weight (1 pce)
Rated operational power	3-phase motor rating	General use rating						
$\theta \leq 40^\circ\text{C}$			V DC					kg
400 V AC-3 kW	AC-1 hp							

#### BC6 mini contactors

Rated power (kW)	Rated current (A)	Motor rating (hp)	Rated voltage (V)	Rated current (A)	Control voltage (V DC)	NO	NC	Order code	Pkg qty	Weight (kg)				
4	20	3	300 V / 12 A	12	12	1	0	BC6-30-10-F-07	GJL1213003R0107	10	0.170			
						0	1	BC6-30-01-F-07	GJL1213003R0017	10	0.170			
				24	24	24	24	24	1	0	BC6-30-10-F-01	GJL1213003R0101	10	0.170
									0	1	BC6-30-01-F-01	GJL1213003R0011	10	0.170
				48	48	48	48	48	1	0	BC6-30-10-F-16	GJL1213003R1106	10	0.170
									0	1	BC6-30-01-F-16	GJL1213003R1016	10	0.170
				60	60	60	60	60	1	0	BC6-30-10-F-03	GJL1213003R0103	10	0.170
									0	1	BC6-30-01-F-03	GJL1213003R0013	10	0.170
				110 ... 125	110 ... 125	110 ... 125	110 ... 125	110 ... 125	1	0	BC6-30-10-F-04	GJL1213003R0104	10	0.170
									0	1	BC6-30-01-F-04	GJL1213003R0014	10	0.170
				220 ... 240	220 ... 240	220 ... 240	220 ... 240	220 ... 240	1	0	BC6-30-10-F-05	GJL1213003R0105	10	0.170
									0	1	BC6-30-01-F-05	GJL1213003R0015	10	0.170

#### BC7 mini contactors

Rated power (kW)	Rated current (A)	Motor rating (hp)	Rated voltage (V)	Rated current (A)	Control voltage (V DC)	NO	NC	Order code	Pkg qty	Weight (kg)				
5.5	20	5	600 V / 16 A	12	12	1	0	BC7-30-10-F-07	GJL1313003R0107	10	0.170			
						0	1	BC7-30-01-F-07	GJL1313003R0017	10	0.170			
				24	24	24	24	24	1	0	BC7-30-10-F-01	GJL1313003R0101	10	0.170
									0	1	BC7-30-01-F-01	GJL1313003R0011	10	0.170
				48	48	48	48	48	1	0	BC7-30-10-F-16	GJL1313003R1106	10	0.170
									0	1	BC7-30-01-F-16	GJL1313003R1016	10	0.170
				60	60	60	60	60	1	0	BC7-30-10-F-03	GJL1313003R0103	10	0.170
									0	1	BC7-30-01-F-03	GJL1313003R0013	10	0.170
				110 ... 125	110 ... 125	110 ... 125	110 ... 125	110 ... 125	1	0	BC7-30-10-F-04	GJL1313003R0104	10	0.170
									0	1	BC7-30-01-F-04	GJL1313003R0014	10	0.170
				220 ... 240	220 ... 240	220 ... 240	220 ... 240	220 ... 240	1	0	BC7-30-10-F-05	GJL1313003R0105	10	0.170
									0	1	BC7-30-01-F-05	GJL1313003R0015	10	0.170

Other types on request.

#### Main dimensions mm, inches

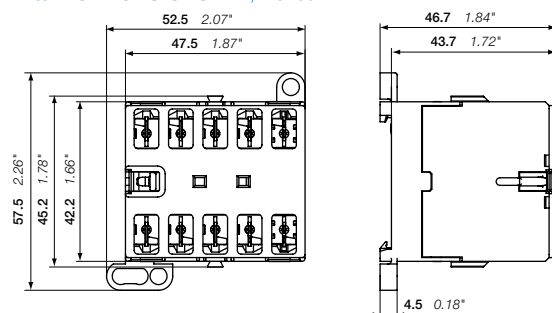

BC6, BC7

# VB7 3-pole mini reversing contactors – with flat pin connection

## 4 to 5.5 kW

### AC operated



VB7-30-10-F

2CDC211006F0011

#### Description

VB7 3-pole compact design reversing contactors are space optimized control products mainly used for switching resistive or motor loads up to 690 V AC.

These reversing contactors are designed with:

- built-in mechanical interlock. The coils must be mutually interlocked electrically and coils must be de-energised for 50 ms at least to prevent phase to phase short circuit on the arc.
- flat pin connection for plug-in wiring and shake proven connection
- control circuit: AC operated
  - low coil consumption (3.5 VA at pull-in and at holding).
- hum-free coil
- no auxiliary contact block permitted for mounting
- for rail and wall mounting.

#### Ordering details

IEC		UL/CSA		Rated control circuit voltage $U_c$		Auxiliary contacts fitted	Type	Order code	Pkg qty	Weight (1 pce)
Rated operational power	current $\theta \leq 40^\circ\text{C}$	3-phase motor rating	General use rating	50 Hz V AC	60 Hz V AC					kg
400 V AC-3 kW	AC-1 A	480 V hp								

#### VB7 mini reversing contactors

Power (kW)	Current (A)	Motor Rating (hp)	Rated Voltage (V)	Rated Current (A)	Control Voltage (V)	Control Current (A)	Order Code	Order Code	Pkg Qty	Weight (kg)
5.5	20	5	600 V / 16 A	24	24	1 0	VB7-30-10-F-01	GJL1311903R0101	5	0.345
						0 1	VB7-30-01-F-01	GJL1311903R0011	5	0.345
				42	42	1 0	VB7-30-10-F-02	GJL1311903R0102	5	0.345
						0 1	VB7-30-01-F-02	GJL1311903R0012	5	0.345
				48	48	1 0	VB7-30-10-F-03	GJL1311903R0103	5	0.345
						0 1	VB7-30-01-F-03	GJL1311903R0013	5	0.345
				110 ... 127	110 ... 127	1 0	VB7-30-10-F-84	GJL1311903R8104	5	0.345
						0 1	VB7-30-01-F-84	GJL1311903R8014	5	0.345
				220 ... 240	220 ... 240	1 0	VB7-30-10-F-80	GJL1311903R8100	5	0.345
						0 1	VB7-30-01-F-80	GJL1311903R8010	5	0.345
				380 ... 415	380 ... 415	1 0	VB7-30-10-F-85	GJL1311903R8105	5	0.345
						0 1	VB7-30-01-F-85	GJL1311903R8015	5	0.345

Other types on request.

#### Main dimensions mm, inches

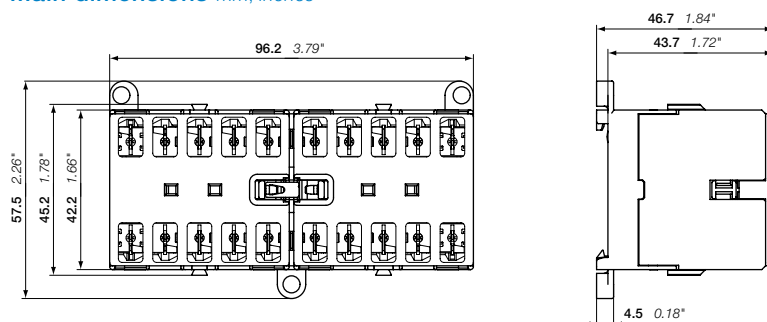

VB7

2CDC211006F0011

2CDC102035C0201

# VBC7 3-pole mini reversing contactors – with flat pin connection

## 4 to 5.5 kW

### DC operated



2CDC211004F0011

3

VBC7-30-10-F

#### Description

VBC7 3-pole compact design reversing contactors are space optimized control products mainly used for switching resistive or motor loads up to 690 V AC.

These reversing contactors are designed with:

- built-in mechanical interlock. The coils must be mutually interlocked electrically and coils must be de-energised for 50 ms at least to prevent phase to phase short circuit on the arc
- flat pin connection for plug-in wiring and shake proven connection
- control circuit: DC operated
  - low coil consumption (3.5 W at pull-in and at holding).
  - hum-free coil
- no auxiliary contact block permitted for mounting
- for rail and wall mounting.

#### Ordering details

IEC		UL/CSA		Rated control circuit voltage $U_c$	Auxiliary contacts fitted	Type	Order code	Pkg qty	Weight (1 pce)
Rated operational power	current $\theta \leq 40^\circ\text{C}$	3-phase motor rating	General use rating						
400 V AC-3 kW	AC-1 A	480 V hp		V DC					kg

#### VBC7 mini reversing contactors

Power (kW)	Current (A)	Motor Rating (hp)	Rated Voltage (V)	Rated Current (A)	NO	NC	Order Code	Order Code	Pkg Qty	Weight (kg)
5.5	20	5	600 V / 16 A	12	1	0	VBC7-30-10-F-07	GJL1313903R0107	5	0.345
					0	1	VBC7-30-01-F-07	GJL1313903R0017	5	0.345
				24	1	0	VBC7-30-10-F-01	GJL1313903R0101	5	0.345
					0	1	VBC7-30-01-F-01	GJL1313903R0011	5	0.345
				48	1	0	VBC7-30-10-F-16	GJL1313903R1106	5	0.345
					0	1	VBC7-30-01-F-16	GJL1313903R1016	5	0.345
				60	1	0	VBC7-30-10-F-03	GJL1313903R0103	5	0.345
					0	1	VBC7-30-01-F-03	GJL1313903R0013	5	0.345
				110 ... 125	1	0	VBC7-30-10-F-04	GJL1313903R0104	5	0.345
					0	1	VBC7-30-01-F-04	GJL1313903R0014	5	0.345
				220 ... 240	1	0	VBC7-30-10-F-05	GJL1313903R0105	5	0.345
					0	1	VBC7-30-01-F-05	GJL1313903R0015	5	0.345

Other types on request.

#### Main dimensions mm, inches

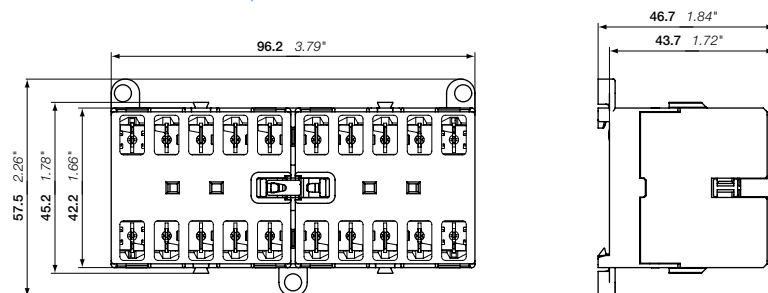

VBC7

2CDC211004F0011

2CDC102036C0201

# VB7A 3-pole mini reversing contactors – with flat pin connection

## 4 to 5.5 kW

### AC operated – with safety blocking function



VB7A-30-10-F

2CDC211008F0011

#### Description

VB7A 3-pole compact design reversing contactors are space optimized control products mainly used for switching resistive or motor loads up to 690 V AC.

These reversing contactors are designed with:

- built-in mechanical interlock and safety blocking function. The safety blocking function is triggered if the voltage is applied to the coil of the contactor to be switched on before the contactor to be switched off has dropped out. The contactor coils are designed for continuous operation when the contactor is de-energised i.e. the coil is not damaged if the mechanical interlock prevents switch-on of the contactor with the coil voltage applied.
- flat pin connection for plug-in wiring and shake proven connection
- control circuit: AC operated
  - low coil consumption (3.5 VA at pull-in and at holding).
- hum-free coil
- no auxiliary contact block permitted for mounting
- for rail and wall mounting.

#### Ordering details

IEC		UL/CSA		Rated control circuit voltage $U_c$		Auxiliary contacts fitted	Type	Order code	Pkg qty	Weight (1 pce)
Rated operational power	Rated operational current $I_n$ at $\theta \leq 40^\circ\text{C}$	3-phase motor rating	General use rating	50 Hz	60 Hz					
400 V	AC-3	AC-1		V AC	V AC				pce	kg
kW	A	hp								

#### VB7A mini reversing contactors with safety blocking function

Rated operational power (kW)	Rated operational current (A)	3-phase motor rating (hp)	UL/CSA General use rating	Rated control circuit voltage (50 Hz) (V AC)	Rated control circuit voltage (60 Hz) (V AC)	Auxiliary contacts (1/0/1)	Type	Order code	Pkg qty	Weight (kg)
5.5	20	5	600 V / 16 A	24	24	1 0	VB7A-30-10-F-01	GJL1311913R0101	5	0.345
						0 1	VB7A-30-01-F-01	GJL1311913R0011	5	0.345
				42	42	1 0	VB7A-30-10-F-02	GJL1311913R0102	5	0.345
						0 1	VB7A-30-01-F-02	GJL1311913R0012	5	0.345
				48	48	1 0	VB7A-30-10-F-03	GJL1311913R0103	5	0.345
						0 1	VB7A-30-01-F-03	GJL1311913R0013	5	0.345
				110 ... 127	110 ... 127	1 0	VB7A-30-10-F-84	GJL1311913R8104	5	0.345
						0 1	VB7A-30-01-F-84	GJL1311913R8014	5	0.345
				220 ... 240	220 ... 240	1 0	VB7A-30-10-F-80	GJL1311913R8100	5	0.345
						0 1	VB7A-30-01-F-80	GJL1311913R8010	5	0.345
				380 ... 415	380 ... 415	1 0	VB7A-30-10-F-85	GJL1311913R8105	5	0.345
						0 1	VB7A-30-01-F-85	GJL1311913R8015	5	0.345

Other types on request.

#### Main dimensions mm, inches

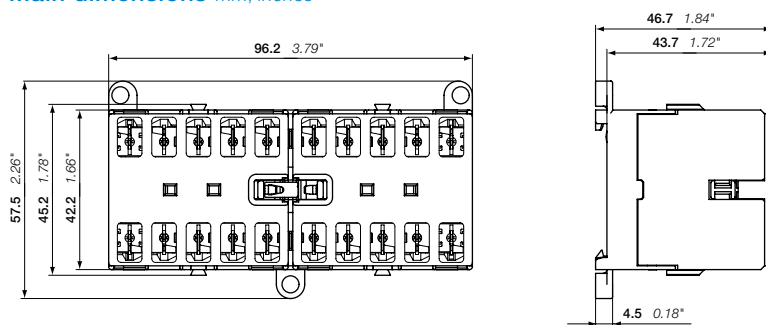

VB7A

2CDC211008F0011

2CDC102037C0201

# VBC7A 3-pole mini reversing contactors – with flat pin connection

## 4 to 5.5 kW

### DC operated – with safety blocking function



2CDC211002F0011

VBC7A-30-10-F

3

#### Description

VBC7A 3-pole compact design reversing contactors are space optimized control products mainly used for switching resistive or motor loads up to 690 V AC.

These reversing contactors are designed with:

- built-in mechanical interlock and safety blocking function. The safety blocking function is triggered if the voltage is applied to the coil of the contactor to be switched on before the contactor to be switched off has dropped out. The contactor coils are designed for continuous operation when the contactor is de-energised i.e. the coil is not damaged if the mechanical interlock prevents switch-on of the contactor with the coil voltage applied.
- flat pin connection for plug-in wiring and shake proven connection
- control circuit: DC operated
  - low coil consumption (3.5 W at pull-in and at holding).
- hum-free coil
- no auxiliary contact block permitted for mounting
- for rail and wall mounting.

#### Ordering details

IEC	UL/CSA	Rated control circuit voltage $U_c$	Auxiliary contacts fitted	Type	Order code	Pkg qty	Weight (1 pce)
Rated operational power 400 V AC-3 kW	3-phase: General use rating motor rating 480 V AC-1 A hp	V DC					kg

#### VBC7A mini reversing contactors with safety blocking function

Rated operational power (kW)	Rated operational current (A)	UL/CSA motor rating (hp)	Rated control circuit voltage (V DC)	Auxiliary contacts	Type	Order code	Pkg qty	Weight (kg)	
5.5	20	5	600 V / 16 A	12	1 0	VBC7A-30-10-F-07	GJL1313913R0107	5	0.345
					0 1	VBC7A-30-01-F-07	GJL1313913R0017	5	0.345
				24	1 0	VBC7A-30-10-F-01	GJL1313913R0101	5	0.345
					0 1	VBC7A-30-01-F-01	GJL1313913R0011	5	0.345
				48	1 0	VBC7A-30-10-F-16	GJL1313913R1106	5	0.345
					0 1	VBC7A-30-01-F-16	GJL1313913R1016	5	0.345
				60	1 0	VBC7A-30-10-F-03	GJL1313913R0103	5	0.345
					0 1	VBC7A-30-01-F-03	GJL1313913R0013	5	0.345
				110 ... 125	1 0	VBC7A-30-10-F-04	GJL1313913R0104	5	0.345
					0 1	VBC7A-30-01-F-04	GJL1313913R0014	5	0.345
				220 ... 240	1 0	VBC7A-30-10-F-05	GJL1313913R0105	5	0.345
					0 1	VBC7A-30-01-F-05	GJL1313913R0015	5	0.345

Other types on request.

#### Main dimensions mm, inches

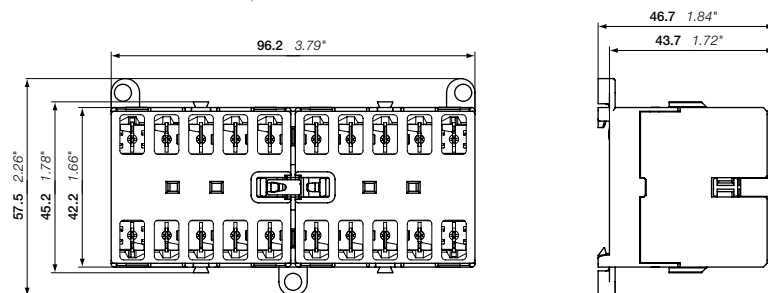

VBC7A

2CDC211002F0011

2CDC102038C0201

# BC6, BC7 3-pole interface mini contactors – with flat pin connection 4 to 5.5 kW DC operated



BC6-30-10-F

2CDC211041F0011



BC7-30-10-F

2CDC211024F0011

## Description

BC6, BC7 3-pole interface mini contactors are compact control products mainly used for switching resistive or motor loads up to 690 V AC.

These contactors are designed with:

- flat pin connection for plug-in wiring and shake proven connection
- 3 main poles and one built-in auxiliary contact
- control circuit: DC operated
  - low coil consumption (1.4 ... 2.4 W at pull-in and at holding).
- hum-free coil
- no auxiliary contact block permitted for mounting
- designed for rail or wall mounting.

## Ordering details

IEC	UL/CSA		Rated control circuit voltage: $U_c$	Auxiliary contacts fitted	Type	Order code	Pkg qty	Weight (1 pce)
Rated operational power	3-phase motor current $\theta \leq 40^\circ\text{C}$	General use rating						
400 V AC-3 kW	AC-1 A	hp	V DC					kg

### DC operation 24 V / 1.4 W

4	20	3	300 V / 12 A	24	1 0	BC6-30-10-F-1.4-81	GJL1213003R8101	10	0.170
					0 1	BC6-30-01-F-1.4-81	GJL1213003R8011	10	0.170
5.5	20	5	600 V / 16 A	24	1 0	BC7-30-10-F-1.4-81	GJL1313003R8101	10	0.170
					0 1	BC7-30-01-F-1.4-81	GJL1313003R8011	10	0.170

### DC operation 17 ... 32 V / 2.4 W

4	20	3	300 V / 12 A	17 ... 32	1 0	BC6-30-10-F-2.4-51	GJL1213003R5101	10	0.170
					0 1	BC6-30-01-F-2.4-51	GJL1213003R5011	10	0.170
5.5	20	5	600 V / 16 A	17 ... 32	1 0	BC7-30-10-F-2.4-51	GJL1313003R5101	10	0.170
					0 1	BC7-30-01-F-2.4-51	GJL1313003R5011	10	0.170

Other types on request.

## Main dimensions mm, inches

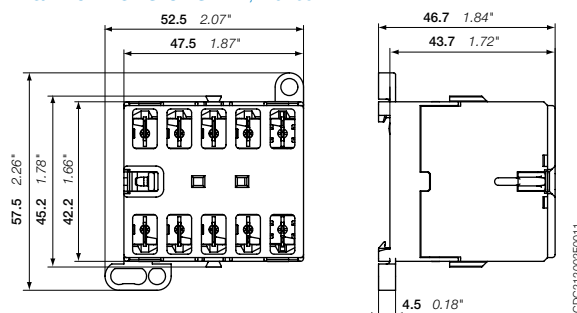

BC6, BC7

2CDC211024F0011

2CDC102039C0201



# K6 4-pole mini contactor relays – with flat pin connection AC operated



2CDC21004S0011

3

K6-22Z-F

## Description

K6 4-pole mini-contactor relays are space optimized control products mainly used for control functions or for small loads up to 4 A.

These contactors are designed with:

- flat pin connection for plug-in wiring and shake proven connection
- 4-poles with various contact combinations
- control circuit: AC operated
  - low coil consumption (3.5 VA at pull-in and at holding).
- hum-free coil
- add-on auxiliary contact blocks for side mounting
- for rail and wall mounting
- add-on auxiliary contact blocks for side mounting.

## Ordering details

Rated control circuit voltage $U_c$		Type	Order code	Pkg qty	Weight (1 pce)
50 Hz	60 Hz				kg
V AC	V AC				

### K6 4-pole mini contactor relays

24	42	48	110 ... 127	220 ... 240	380 ... 415	Type	Order code	Pkg qty	Weight (1 pce)
						K6-22Z-F-01	GJH1211003R0221	10	0.170
						K6-22Z-F-02	GJH1211003R0222	10	0.170
						K6-22Z-F-03	GJH1211003R0223	10	0.170
						K6-22Z-F-84	GJH1211003R8224	10	0.170
						K6-22Z-F-80	GJH1211003R8220	10	0.170
						K6-22Z-F-85	GJH1211003R8225	10	0.170
						K6-31Z-F-01	GJH1211003R0311	10	0.170
						K6-31Z-F-02	GJH1211003R0312	10	0.170
						K6-31Z-F-03	GJH1211003R0313	10	0.170
						K6-31Z-F-84	GJH1211003R8314	10	0.170
						K6-31Z-F-80	GJH1211003R8310	10	0.170
						K6-31Z-F-85	GJH1211003R8315	10	0.170
						K6-40E-F-01	GJH1211003R0401	10	0.170
						K6-40E-F-02	GJH1211003R0402	10	0.170
						K6-40E-F-03	GJH1211003R0403	10	0.170
						K6-40E-F-84	GJH1211003R8404	10	0.170
						K6-40E-F-80	GJH1211003R8400	10	0.170
						K6-40E-F-85	GJH1211003R8405	10	0.170

Other types on request.

## Main dimensions mm, inches

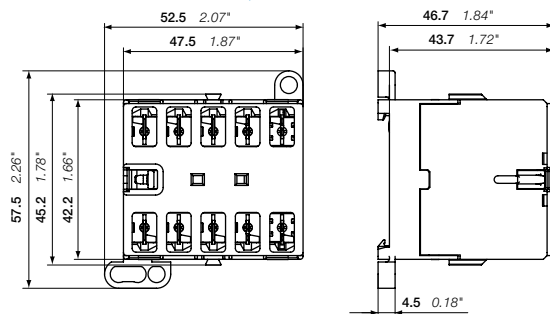

K6

2CDC21004S0011

2CDC102040C0201

# KC6 4-pole mini contactor relays – with flat pin connection DC operated



KC6-22Z-F-01

2CDC211022F0011

## Description

K6 4-pole mini-contactor relays are space optimized control products mainly used for control functions or for small loads up to 4 A.

These contactors are designed with:

- flat pin connection for plug-in wiring and shake proven connection
- 4-poles with various contact combinations
- control circuit: AC operated
  - low coil consumption (3.5 VA at pull-in and at holding).
- hum-free coil
- add-on auxiliary contact blocks for side mounting
- for rail and wall mounting.

## Ordering details

Rated control circuit voltage $U_c$	Type	Order code	Pkg qty	Weight (1 pce) kg
V DC				
<b>K6 4-pole mini contactor relays</b>				
12	KC6-22Z-F-07	GJH1213003R0227	10	0.170
24	KC6-22Z-F-01	GJH1213003R0221	10	0.170
48	KC6-22Z-F-16	GJH1213003R1226	10	0.170
110 ... 125	KC6-22Z-F-04	GJH1213003R0224	10	0.170
220 ... 240	KC6-22Z-F-05	GJH1213003R0225	10	0.170
12	KC6-31Z-F-07	GJH1213003R0317	10	0.170
24	KC6-31Z-F-01	GJH1213003R0311	10	0.170
48	KC6-31Z-F-16	GJH1213003R1316	10	0.170
110 ... 125	KC6-31Z-F-04	GJH1213003R0314	10	0.170
220 ... 240	KC6-31Z-F-05	GJH1213003R0315	10	0.170
24	KC6-40E-F-01	GJH1213003R0401	10	0.170
48	KC6-40E-F-16	GJH1213003R1406	10	0.170
110 ... 125	KC6-40E-F-04	GJH1213003R0404	10	0.170
220 ... 240	KC6-40E-F-05	GJH1213003R0405	10	0.170

Other types on request.

## Main dimensions mm, inches

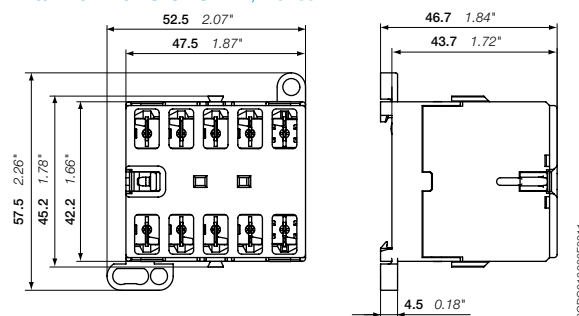

KC6

2CDC211022F0011

2CDC102041C0201

# KC6 4-pole interface mini contactor relays – with flat pin connection DC operated



2CDC21103RF0011

3

KC6-31Z-F-05

## Description

KC6 4-pole interface mini-contactor relays are space optimized control products mainly used for control functions or for small loads up to 4 A.

These contactors are designed with:

- flat pin connection for plug-in wiring and shake proven connection
- 4-poles with various contact combinations
- control circuit: AC operated
  - low coil consumption (1.4 ... 2.4 W at pull-in and at holding).
- hum-free coil
- no auxiliary contact block permitted for mounting
- for rail and wall mounting
- no add-on auxiliary contact blocks possible.

## Ordering details

Rated control circuit voltage $U_c$	Type	Order code	Pkg qty	Weight (1 pce) kg
V DC				
<b>DC operation 24 V / 1.4 W</b>				
24	KC6-31Z-F-1.4-81	GJH1213003R8311	10	0.170
24	KC6-40E-F-1.4-81	GJH1213003R8401	10	0.170
<b>DC operation 17 ... 32 V / 2.4 W</b>				
17 ... 32	KC6-31Z-F-51	GJH1213003R5311	10	0.170
17 ... 32	KC6-40E-F-51	GJH1213003R5401	10	0.170

Other types on request.

## Main dimensions mm, inches

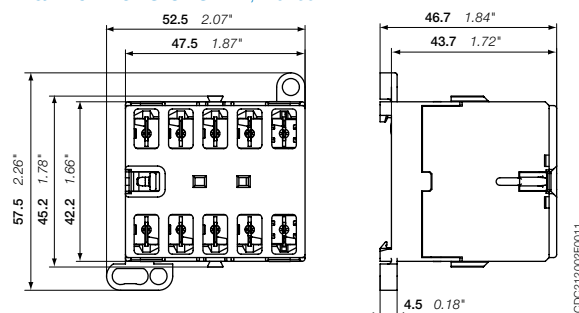

KC6

2CDC21103RF0011

2CDC102045C0201

# B6, B7, BC6, BC7 3- and 4-pole mini contactors VB6, VB7, VBC6, VBC7 3-pole mini reversing contactors

## Accessories



2CDC211012F0010

CAF6-11N



2CDC211007F0010

RV-BC6/250



2CDC211008F0010

CA6-11E



2CDC211018F0011

CA6-11E-P



2CDC211028F0011

CA6-11E-F



SSTZ792R

BSM6-30



2CDC251012F0011

T16-16

### Ordering details

For contactors	Auxiliary contacts	Type	Order code	Pkg qty	Weight (1 pce)
					kg

#### Front mounted instantaneous auxiliary contact blocks (not allowed for mounting on TBC, B6S, B7S, interface contactors) <sup>1)</sup>

B6-, B7-40-00, BC6-, BC7-40-00	1 1	CAF6-11E	GJL1201330R0002	10	0.020
VB6, VB7, VBC6, VBC7, VB6A, VB7A	2 0	CAF6-20E	GJL1201330R0006	10	0.020
VBC6A, VBC7A	0 2	CAF6-02E	GJL1201330R0010	10	0.020
B6-, B7-30-10, BC6-, BC7-30-10	1 1	CAF6-11M	GJL1201330R0003	10	0.020
VB6, VB7, VBC6, VBC7, VB6A, VB7A	2 0	CAF6-20M	GJL1201330R0007	10	0.020
VBC6A, VBC7A	0 2	CAF6-02M	GJL1201330R0011	10	0.020
B6-, B7-30-01, BC6-, BC7-30-01	1 1	CAF6-11N	GJL1201330R0004	10	0.020
VB6, VB7, VBC6, VBC7, VB6A, VB7A	2 0	CAF6-20N	GJL1201330R0008	10	0.020
VBC6A, VBC7A	0 2	CAF6-02N	GJL1201330R0012	10	0.020

#### Side mounted instantaneous auxiliary contact block <sup>1)</sup>

B6-, B7-40-00, BC6-, BC7-40-00	1 1	CA6-11E	GJL1201317R0002	10	0.030
B6-, B7-30-10, BC6-, BC7-30-10	1 1	CA6-11M	GJL1201317R0003	10	0.030
B6-, B7-30-01, BC6-, BC7-30-01	1 1	CA6-11N	GJL1201317R0004	10	0.030

#### Side mounted instantaneous auxiliary contact block with soldering pins <sup>2)</sup>

B6-, B7-40-00-P, BC6-, BC7-40-00-P	1 1	CA6-11E-P	GJL1201319R0002	10	0.025
B6-, B7-30-10-P, BC6-, BC7-30-10-P	1 1	CA6-11M-P	GJL1201319R0003	10	0.025
B6-, B7-30-01-P, BC6-, BC7-30-01-P	1 1	CA6-11N-P	GJL1201319R0004	10	0.025

#### Side mounted instantaneous auxiliary contact block with flat pin connection <sup>2)</sup>

B6-, B7-40-00-F, BC6-, BC7-40-00-F	1 1	CA6-11E-F	GJL1201318R0002	10	0.025
B6-, B7-30-10-F, BC6-, BC7-30-10-F	1 1	CA6-11M-F	GJL1201318R0003	10	0.025
B6-, B7-30-01-F, BC6-, BC7-30-01-F	1 1	CA6-11N-F	GJL1201318R0004	10	0.025

#### Soldering receptacle (I<sub>th</sub> = 10 A, AC-3: 500 V / 8 A, 690 V / 3.5 A, UL: 300 V / 8 A)

B6, B7, BC6, BC7	LB6	GJL1201902R0001	10	0.020
2-pole aux.contact blocks CA	LB6-CA	GJL1201903R0001	10	0.010

<sup>1)</sup> CA6 and CAF6 must not be fitted simultaneously.

For contactors	Rated control circuit voltage U <sub>c</sub> V DC	Connection type	Type	Order code	Pkg qty	Weight (1 pce)
						kg

#### Surge suppressors for contactor coils

BC6, BC7	24 ... 60	Cable lug	RV-BC6/60	GHV2501902R0002	10	0.005
		Flat pin, 2.8 mm	RV-BC6-F/60	GHV2501902R0003	10	0.005
	50 ... 250	Cable lug	RV-BC6/250	GHV2501903R0002	10	0.005
		Flat pin, 2.8 mm	RV-BC6-F/250	GHV2501903R0003	10	0.010
	380	Cable lug	RV-BC6/380	GHV2501904R0002	10	0.005
		Flat pin, 2.8 mm	RV-BC6-F/380	GHV2501904R0003	10	0.010

Note: Mini contactors for AC operation have an integrated protective circuit.

#### Connecting links with manual motor starters

To connect B..VB.. mini contactor to MS116, MS132	BEA7/132	1SBN080906R1002	10	0.013
To connect B..VB.. mini contactors to MS325	BEA7/325	1SBN080906R1001	10	0.021

#### Connection sets for reversing contactors

VB6, VB7, VBC6, VBC7, VB6A, VB7A, VBC6A, VBC7A, cross-section 1.8 mm <sup>2</sup>	BSM6-30	GJL1201908R0001	10	0.010
---	---------	-----------------	----	-------

#### Parallel connecting link

B6, B7, BC6, BC7	LP6	GJL1201907R0001	100	0.009
------------------	-----	-----------------	-----	-------

#### Cover cap, transparent fitting to DIN rail design, sealable

B6, B7, BC6, BC7	LT6-B	GJL1201906R0001	10	0.015
------------------	-------	-----------------	----	-------

#### Plastic label for markings

B6, B7, BC6, BC7	BA5-50	1SBN110000R1000	50	0.020
------------------	--------	-----------------	----	-------

#### Thermal overload relays

T16	(see page 2CDC106036C0201)		1	0.100
-----	----------------------------	--	---	-------

# K6, KC6 4-pole mini contactor relays

## Accessories



2CDC211019FC011

CAF6-11K



2CDC211009F0010

CA6-11K



2CDC211011F0010

CA6-11K-P



2CDC211010F0010

CA6-11K-F



2CDC211006F0010

LT6-B



2CDC211007F0010

RV-BC6/250

### Ordering details

For contactors	Auxiliary contacts	Type	Order code	Pkg qty	Weight (1 pce)
					kg
<b>Front mounted instantaneous auxiliary contact blocks <sup>1)</sup></b>					
K6, KC6	1 1	CAF6-11K	GJL1201330R0001	10	0.020
	2 0	CAF6-20K	GJL1201330R0005	10	0.020
	0 2	CAF6-02K	GJL1201330R0009	10	0.020
<b>Side mounted instantaneous auxiliary contact block <sup>1)</sup></b>					
K6, KC6	1 1	CA6-11K	GJL1201317R0001	10	0.030
<b>Side mounted instantaneous auxiliary contact block with soldering pins <sup>2)</sup></b>					
K6..P, KC6..P	1 1	CA6-11K-P	GJL1201319R0001	10	0.025
<b>Side mounted instantaneous auxiliary contact block with flat pin connection <sup>2)</sup></b>					
K6..F, KC6..F	1 1	CA6-11K-F	GJL1201318R0001	10	0.025
<b>Soldering receptacle (<math>I_n &lt; 8 A</math>)</b>					
K6, KC6		LB6	GJL1201902R0001	10	0.020
2-pole auxiliary contact blocks CA		LB6-CA	GJL1201903R0001	10	0.010

<sup>1)</sup> CA6 and CAF6 must not be fitted simultaneously.

For contactors	Rated control circuit voltage $U_c$ V DC	Connection type	Type	Order code	Pkg qty	Weight (1 pce)
<b>Surge suppressors for contactor coils</b>						
KC6	24 ... 60	Cable lug	RV-BC6/60	GHV2501902R0002	10	0.005
		Flat pin, 2.8 mm	RV-BC6-F/60	GHV2501902R0003	10	0.005
	50 ... 250	Cable lug	RV-BC6/250	GHV2501903R0002	10	0.005
		Flat pin, 2.8 mm	RV-BC6-F/250	GHV2501903R0003	10	0.010
	380	Cable lug	RV-BC6/380	GHV2501904R0002	10	0.005
		Flat pin, 2.8 mm	RV-BC6-F/380	GHV2501904R0003	10	0.010

Note: Mini contactors for AC operation have an integrated protective circuit.



### Cover cap, transparent fitting to DIN rail design, sealable

K6, KC6		LT6-B	GJL1201906R0001	10	0.015
---------	--	-------	-----------------	----	-------

# B6, B7, BC6, BC7, TBC7 3- and 4-pole mini contactors VB6, VB7, VBC6, VBC7 3- and 4-pole mini reversing contactors

## Technical data

### Main pole – Utilization characteristics according to IEC

Contactor types	AC operated	B6, VB6, VB6A	B7, VB7, VB7A
	DC operated	BC6, VBC6, VBC6A	BC7, TBC7, VBC7, VBC7A
Standards	IEC/EN 60947-1, IEC/EN 60947-4-1		
Rated operational voltage $U_e$	690 V AC		
Rated frequency (without derating)	DC or 50 / 60 Hz		
Conventional free-air thermal current $I_{th}$ acc. to IEC 60947-4-1, open contactors, $\theta \leq 40$ °C, with conductor cross-sectional area	Screw terminal types: 20 A Flat pin types: 20 A Soldering pin types: 12 A		
AC-1 Utilization category for air temperature close to contactor $\theta \leq 40$ °C			
$I_e$ / Rated operational current AC-1 $U_{e \max} \leq 690$ V, 50/60 Hz	220-230-240 V	Screw terminal types: 20 A Flat pin types: 20 A Soldering pin types: 12 A	
	380-400 V	Screw terminal types: 20 A Flat pin types: 20 A Soldering pin types: 12 A	
	440 V	Screw terminal types: 20 A Flat pin types: 20 A Soldering pin types: 12 A	
	500 V	12 A	
	690 V	6 A	
AC-1 Utilization category for air temperature close to contactor $\theta \leq 55$ °C			
$I_e$ / Rated operational current AC-1 $U_{e \max} \leq 690$ V, 50/60 Hz	220-230-240 V	Screw terminal types: 16 A Flat pin types: 16 A Soldering pin types: 12 A	
	380-400 V	Screw terminal types: 16 A Flat pin types: 16 A Soldering pin types: 12 A	
	440 V	Screw terminal types: 16 A Flat pin types: 16 A Soldering pin types: 12 A	
	500 V	12 A	
	690 V	6 A	
AC-3 Utilization category for air temperature close to contactor $\theta \leq 55$ °C			
$I_e$ / Rated operational current AC-3 	220 / 230 / 240 V	8.9 / 8.5 / 8.1 A	11.8 / 11.3 / 10.8 A
	380 / 400 V	8.9 / 8.5 A	12.1 / 11.5 A
	440 V	7.4 A	10.1 A
	500 V	6.8 A	9.2 A
	690 V	3.8 A	3.8 A
Rated operational power AC-3 1500 r.p.m. 50 Hz 1800 r.p.m. 60 Hz 3-phase motors 	220-230-240 V	2.2 kW	3 kW
	380-400 V	4 kW	5.5 kW
	440 V	4 kW	5.5 kW
	500 V	4 kW	5.5 kW
	690 V	3 kW	3 kW
DC-1 Utilization category for air temperature close to contactor $\theta \leq 55$ °C			
$I_e$ / Rated operational current DC-1	110 V	-	4 A
	220 V	-	0.6 A
DC-3 Utilization category for air temperature close to contactor $\theta \leq 55$ °C			
$I_e$ / Rated operational current DC-3	110 V	-	1.5 A
	220 V	-	0.25 A
DC-5 Utilization category for air temperature close to contactor $\theta \leq 55$ °C			
$I_e$ / Rated operational current DC-5	110 V	-	0.4 A
	220 V	-	0.2 A
Rated making capacity AC-3	10 x $I_e$ AC-3 acc. to IEC 60947-4-1		
Rated breaking capacity AC-3	8 x $I_e$ AC-3 acc. to IEC 60947-4-1		
Short-circuit protection device for contactors without thermal O/L relay - motor protection excluded $U_e \leq 500$ V AC - gG type fuse	Type 1: 25 A / Type 2: 25 A		
Rated short-time withstand current $I_{cw}$ at 40 °C ambient temperature, in free air from a cold state	10 s	64 A	96 A
Maximum breaking capacity $\cos \phi = 0.45$	at 400 V	64 A	96 A
Maximum electrical switching frequency	AC-1	300 cycles/h	
	AC-3	600 cycles/h	
	DC-1, DC-3, DC-5	600 cycles/h	

# B6, B7, BC6, BC7, TBC7 3- and 4-pole mini contactors VB6, VB7, VBC6, VBC7 3- and 4-pole mini reversing contactors

## Technical data

### Main pole – Utilization characteristics according to UL/NEMA/CSA

Contactor types	AC operated	B6, VB6, VB6A	B7, VB7, VB7A
	DC operated	BC6, VBC6, VBC6A	BC7, TBC7, VBC7, VBC7A
Standards	UL 508, CSA C22.2 N°14		
Maximum operational voltage	600 V		
UL/CSA general use rating	12 A / 300 V		16 A / 600 V
UL/CSA maximum 1-phase motor rating			
Full load current	120 V AC	5.8 A	13.8 A
	240 V AC	4.9 A	10.0 A
Horse power rating	120 V AC	0.25 hp	0.75 hp
	240 V AC	0.5 hp	1.5 hp
UL/CSA maximum 3-phase motor rating			
Full load current <sup>1)</sup>	200 / 208 V AC	4.8 / 4.6 A	7.8 / 10.6 A
	220-240 V AC	6.8 A	9.6 A
	440-480 V AC	4.8 A	7.6 A
	550-600 V AC	1.7 A	6.1 A
Horse power rating <sup>1)</sup>	200 / 208 V AC	1 hp	2 / 3 hp
	220-240 V AC	2 hp	3 hp
	440-480 V AC	3 hp	5 hp
	550-600 V AC	1 hp	5 hp
Resistive Heating	300 V per pole	8 A	8 A
Incandescent Lamps	300 V per pole	6 A	6 A
Fluorescent Lamps	300 V per pole	8.4 A	8.4 A
Short-circuit protection device for contactors without thermal overload relay - motor protection excluded			
Fuse rating	600 V	40 A	
Fuse type, 600 V	600 V	Class J	
Maximum electrical switching frequency			
For resistive loads AC-1			300 cycles/h
For motor loads AC-3			600 cycles/h

<sup>1)</sup> For the corresponding kW/A or hp/A values of 1500 r.p.m, 50 Hz or 1800 r.p.m, 60 Hz, 3-phase motors, see "Motor rated operational powers and currents".

### General technical data

Contactor types	AC operated	B6, VB6, VB6A	B7, VB7, VB7A
	DC operated	BC6, VBC6, VBC6A	BC7, TBC7, VBC7, VBC7A
Rated insulation voltage U <sub>i</sub>			
acc. to IEC 60947-4-1	690 V		
acc. to UL/CSA	600 V		
Rated impulse withstand voltage U <sub>imp</sub>	6 kV		
Ambient air temperature, close to contactor			
Operation	Fitted with thermal overload relay	-25 ... +55 °C	
	Without thermal overload relay	-25 ... +55 °C	
Storage	-40 ... +80 °C		
Climatic withstand	Acc. to IEC 60947-1 Annex Q		
Maximum operating altitude (without derating)	2000 m		
Mechanical durability	10 <sup>7</sup> operating cycles		
Resistance to shock	Half-sine		
acc. IEC 60068-2-27 and EN 60068-2-27	15 g / 11 ms		
acc. to IEC/EN 60947-1 Annex. Q	Category E		
Resistance to vibrations	Sinusoidal		
acc. IEC 60068-2-27 and EN 60068-2-27	5 g / 3 ... 150 Hz		
acc. to IEC/EN 60947-1 Annex. Q	Category E		



# B6, B7, BC6, BC7, TBC7 3- and 4-pole mini contactors

## VB6, VB7, VBC6, VBC7 3- and 4-pole mini reversing contactors

### Technical data

#### Magnet system characteristics for B6, B7 contactors

Contactor types	AC operated	B6, VB6	B7, VB7
Coil operating limits acc. to IEC 60947-4-1	AC supply	0.85 ... 1.1 x U <sub>c</sub>	
AC control voltage			
Rated control circuit voltage U <sub>c</sub>		See ordering tables	
Coil consumption	Average pull-in value	3.5 VA / 3.5 W	
	Average holding value	3.5 VA / 3.5 W	
Drop-out voltage		0.20 ... 0.75 % of U <sub>c</sub>	

#### Magnet system characteristics for BC6, BC7 contactors

Contactor types	DC operated	BC6, VBC6	BC7, VBC7
Coil operating limits acc. to IEC 60947-4-1	DC supply	0.85 ... 1.1 x U <sub>c</sub>	
AC control voltage			
Rated control circuit voltage U <sub>c</sub>		See ordering tables	
Coil consumption <sup>1)</sup>	Average pull-in value	3.5 VA / 3.5 W	
	Average holding value	3.5 VA / 3.5 W	
Drop-out voltage in % of U <sub>cmin</sub>		0.10 ... 0.75 x U <sub>c</sub>	

<sup>1)</sup> Interface mini-contactors: see coil consumption on ordering details pages

#### Magnet system characteristics for TBC7 contactors

Contactor types	DC operated	TBC7
Coil operating limits acc. to IEC 60947-4-1	DC supply	Wide range voltage supply see ordering tables, U <sub>cmin</sub> ... U <sub>cmax</sub>
AC control voltage		
Rated control circuit voltage U <sub>c</sub>		See ordering tables
Coil consumption	Average pull-in value	5 VA / 5 W
	Average holding value	5 VA / 5 W
Drop-out voltage in % of U <sub>cmin</sub>		≤ 0.20 % of U <sub>cmin</sub>

#### Mounting characteristics and conditions for use

Contactor types	AC operated	B6, VB6, VB6A	B7, VB7, VB7A
	DC operated	BC6, VBC6, VBC6A	BC7, TBC7, VBC7, VBC7A
Mounting positions	<p>Any position possible</p>		
Mounting distances	The contactors can be assembled side by side		
Fixing	On rail acc. to IEC 60715, EN 60715	35 x 7.5 mm or 35 x 15 mm	
	By screws (not supplied)	2 x M4 screws placed diagonally	

# B6, B7, BC6, BC7, TBC7 3- and 4-pole mini contactors VB6, VB7, VBC6, VBC7 3- and 4-pole mini reversing contactors

## Technical data

### Built-in auxiliary contacts according to IEC

Contactor types	AC operated	B6, VB6, VB6A	B7, VB7, VB7A
	DC operated	BC6, VBC6, VBC6A	BC7, TBC7, VBC7, VBC7A
Standards	IEC/EN 60947-1, IEC/EN 60947-4-1		
Rated operational voltage $U_e$ max	690 V		
Rated frequency (without derating)	DC or 50 / 60 Hz		
Conventional free-air thermal current $I_m$ , $\theta \leq 40$ °C	6 A		
$I_o$ / Rated operational current AC-15 acc. to IEC 60947-5-1	24 V 50/60 Hz	4 A	
	110-120 V 50/60 Hz	4 A	
	220-230-240 V 50/60 Hz	4 A	
	380-400 V 50/60 Hz	3 A	
	440 V 50/60 Hz	3 A	
$I_o$ / Rated operational current DC-13 acc. to IEC 60947-5-1	24 V DC	2.5 A	
	110 V DC	0.7 A	
	220 - 240 V DC	0.4 A	
Short-circuit protection device	6 A, Type gG		
Minimum switching capacity with failure rate acc. to IEC 60947-5-4	17 V / 5 mA		
Maximum electrical switching frequency	AC-15	600 cycles/h	
	DC-13	600 cycles/h	

### Built-in auxiliary contacts according to UL/CSA

Contactor types	AC operated	B6, VB6, VB6A	B7, VB7, VB7A
	DC operated	BC6, VBC6, VBC6A	BC7, TBC7, VBC7, VBC7A
Max. operational voltage	600 V AC		
Pilot duty	A600		
AC thermal rated current	5 A		

### Accessories for mini contactors

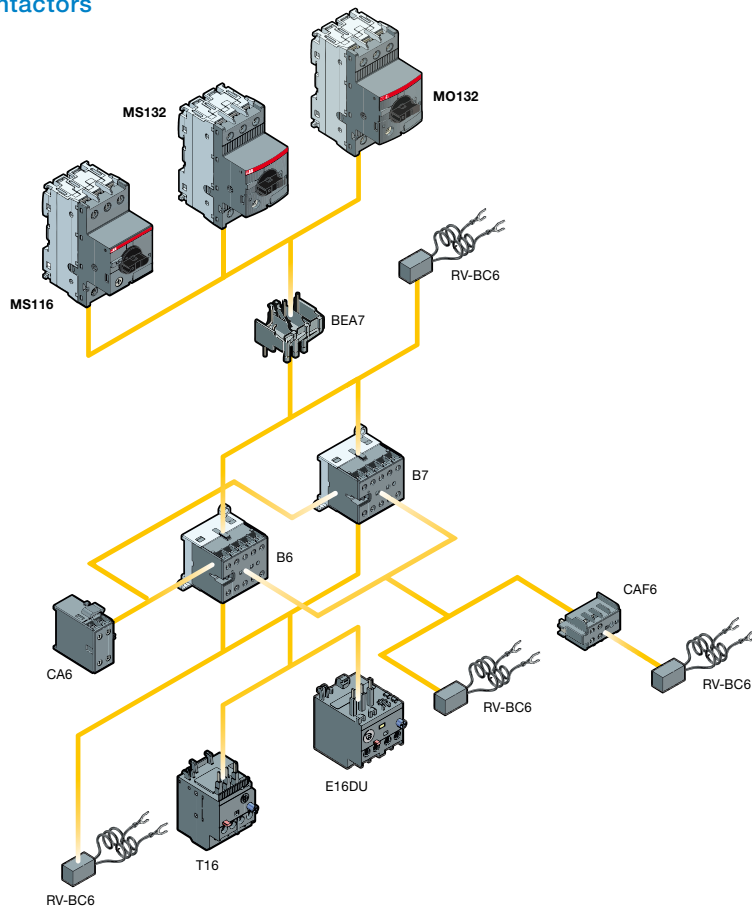





2CDC212018F0011

2CDC102043C0201

# B6, B7, BC6, BC7, TBC7 3- and 4-pole mini contactors VB6, VB7, VBC6, VBC7 3- and 4-pole mini reversing contactors

## Technical data

### Connection characteristics

Contactor types	AC operated	B6, VB6, VB6A	B7, VB7, VB7A
	DC operated	BC6, VBC6, VBC6A	BC7, TBC7, VBC7, VBC7A
Main terminals <sup>1)</sup>	 <p>Screw terminals with cable clamp</p>		
<b>Connection capacity</b>			
<b>Main conductors (poles)</b>			
 Rigid: solid	1 or 2 x	1 ... 4 mm <sup>2</sup>	
 Flexible without ferrule	1 or 2 x	1 ... 2.5 mm <sup>2</sup>	
Connection capacity acc. to UL/CSA	1 or 2 x	AWG 22 ... 10	
Stripping length		9 mm	
Tightening torques		0.8 ... 1.1 Nm / 7 lb.in	
<b>Connection capacity – auxiliary conductors</b> (built-in auxiliary terminals + coil terminals)			
 Rigid: solid	1 or 2 x	1 ... 4 mm <sup>2</sup>	
 Flexible without ferrule	1 or 2 x	1 ... 2.5 mm <sup>2</sup>	
Connection capacity acc. to UL/CSA	1 or 2 x	AWG 22 ... 10	
Stripping length		9 mm	
Tightening torques		0.8 ... 1.1 Nm / 7 lb.in	
Coil terminals		0.8 ... 1.1 Nm / 7 lb.in	
Built-in auxiliary terminals		0.8 ... 1.1 Nm / 7 lb.in	
<b>Degree of protection</b> acc. to IEC 60947-1 / EN 60947-1 and IEC 60529 / EN 60529			
Main terminals		IP20	
Coil terminals		IP20	
Built-in auxiliary terminals		IP20	
<b>Screw terminals</b> (Delivered in open position, screws of unused terminals must be tightened)			
All terminals		M3	
<b>Screwdriver type</b>		Flat Ø 5.5 mm / Pozidriv 1	

<sup>1)</sup> Soldering pin connection acc. to DIN 40801: 0.8 x 1 mm / 0.8 x 2.54 mm  
Flat pin connection acc. to DIN 46248: 1 x 6.3 mm / 1 x 2.8 mm

# K6, KC6, TKC6 4-pole mini contactor relays

## Technical data

### Main pole – Utilization characteristics according to IEC

Contactor types	AC operated	K6
	DC operated	KC6, TKC6
Standards	IEC/EN 60947-1, IEC/EN 60947-4-1, IEC/EN 60947-5-1	
Rated operational voltage $U_{emax}$	690 V	
Rated frequency (without derating)	DC or 50 / 60 Hz	
Conventional free-air thermal current $I_{th}$ , $\theta \leq 40$ °C	6 A	
$I_o$ / Rated operational current AC-15 acc. to IEC 60947-5-1	24 V 50/60 Hz	4 A
	110-120 V 50/60 Hz	4 A
	220-230-240 V 50/60 Hz	4 A
	380-400 V 50/60 Hz	3 A
	440 V 50/60 Hz	3 A
	480-500 V 50/60 Hz	2 A
$I_o$ / Rated operational current DC-13 acc. to IEC 60947-5-1	24 V DC	2.5 A
	110 V DC	0.7 A
	220-240 V DC	0.4 A
Short-circuit protection device for contactors $U_n \leq 500$ V AC, gG fuse type	6 A	
Minimum switching capacity	17 V / 5 mA	
Maximum electrical switching frequency	AC-15	600 cycles/h
	DC-13	600 cycles/h

### Main pole – Utilization characteristics according to UL/NEMA/CSA

Contactor types	AC operated	K6
	DC operated	KC6, TKC6
Standards	UL 508, CSA C22.2 No14	
Maximum operational voltage	600 V AC	
Pilot duty	A600	

# K6, KC6, TKC6 4-pole mini contactor relays

## Technical data

### General technical data

Contactor relay types	AC operated	K6
	DC operated	KC6, TKC6
Rated insulation voltage $U_i$	acc. to IEC 60947-5-1	690 V
	acc. to UL/CSA	600 V
Rated impulse withstand voltage $U_{imp}$		6 kV
Electromagnetic compatibility		
Ambient air temperature close to contactor relay	Operation in free air	-25 ... +55 °C
	Storage	-40 ... +80 °C
Climatic withstand		Acc. to IEC 60068-2-30
Maximum operating altitude (without derating)		2000 m
Mechanical durability		10 <sup>7</sup> operating cycles
Resistance to shock		Half-sine
	acc. IEC 60068-2-27 and EN 60068-2-27	15 g / 11ms
	acc. to IEC/EN 60947-1 Annex. Q	Category E
Resistance to vibrations		Sinusoidal
	acc. IEC 60068-2-27 and EN 60068-2-27	5 g / 3 ... 150 Hz
	acc. to IEC/EN 60947-1 Annex. Q	Category E

3

### Magnet system characteristics for K6 contactor relays

Contactor relay types	AC operated	K6	
Coil operating limits acc. to IEC 60947-4-1	AC supply	0.85 ... 1.1 x $U_c$	
AC control voltage	Coil consumption	Average pull-in value	3.5 VA / 3.5 W
		Average holding value	3.5 VA / 3.5 W
	Drop-out voltage in % of $U_c$ min.		Approx. 20 ... 75%

### Magnet system characteristics for KC6, TKC6 contactor relays

Contactor relay types	DC operated	KC6	TKC6	
Coil operating limits acc. to IEC 60947-5-1	DC supply	0.85 ... 1.1 x $U_c$	See ordering details	
DC control voltage	Coil consumption	Average pull-in value	3.5 VA / 3.5 W	5 VA / 5 W
		Average holding value	3.5 VA / 3.5 W	5 VA / 5 W
	Drop-out voltage in % of $U_c$ min.		10 ... 75 %	10 ... 75 %



# K6, KC6, TKC6 4-pole mini contactor relays

## Technical data

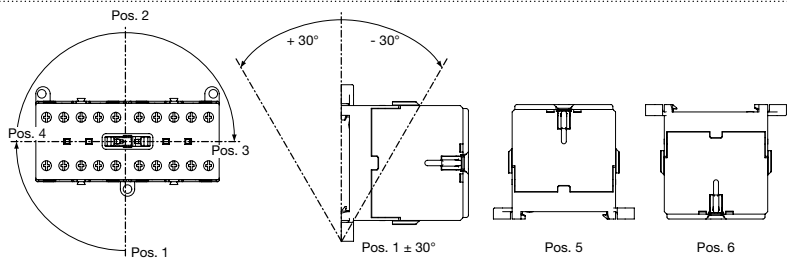
### Mounting characteristics and conditions for use

Contactor types	AC operated	K6
	DC operated	KC6, TKC6
Mounting positions	 <p>Any position possible</p>	
Mounting distances	The contactors can be assembled side by side	
Fixing	<p>On rail acc. to IEC 60715, EN 60715</p> <p>By screws (not supplied)</p>	
	<p>35 x 7.5 mm or 35 x 15 mm</p> <p>2 x M4 screws placed diagonally</p>	

### Connecting characteristics

Contactor relay types	AC operated	K6
	DC operated	KC6, TKC6
Main terminals <sup>1)</sup>	 <p>Screw terminals with cable clamp</p>	
Connection capacity	<p><b>Main conductors (poles)</b></p> <p> Rigid: solid      <b>1 or 2 x</b> 1 ... 4 mm<sup>2</sup></p> <p> Flexible without ferrule      <b>1 or 2 x</b> 1 ... 2.5 mm<sup>2</sup></p> <p>Connection capacity acc. to UL/CSA      <b>1 or 2 x</b> AWG 22 ... 10</p> <p>Stripping length      9 mm</p> <p>Tightening torques      0.8 ... 1.1 Nm / 7 lb.in</p>	
Degree of protection	IP20	
acc. to IEC 60947-1 / EN 60947-1 and IEC 60529 / EN 60529		
All		
Screw terminals	(Delivered in open position, screws of unused terminals must be tightened)	
All terminals	M3	
Screwdriver type	Flat Ø 5.5 / Pozidriv 1	

<sup>1)</sup> Soldering pin connection acc. to DIN 40801: 0.8 x 1 mm / 0.8 x 2.54 mm  
 Flat pin connection acc. to DIN 46248: 1 x 6.3 mm / 1 x 2.8 mm

# Mini contactors and mini contactor relays

## Terminal marking and positioning

### Mini contactors

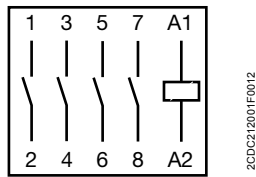

2CDC212001F0012

B6(7)-40-00 ...  
BC6(7)-40-00 ...

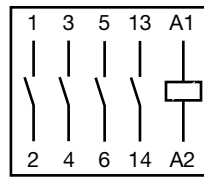

2CDC212002F0012

B6(7)-30-10 ...  
BC6(7)-30-10 ...

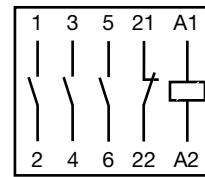

2CDC212003F0012

B6(7)-30-01 ...  
BC6(7)-30-01 ...

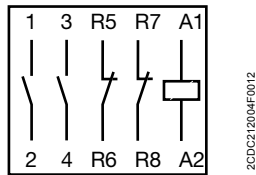

2CDC212004F0012

B6(7)-22-00 ...  
BC6(7)-22-00 ...

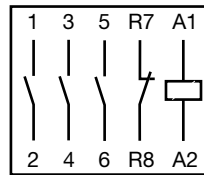

2CDC212006F0012

B6(7)-31-00 ...  
BC6(7)-31-00 ...

### Compact reversing contactors

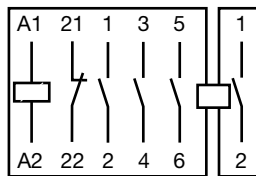

2CDC212008F0012

VB6(7)-30-01 ...  
VBC6(7)-30-01 ...

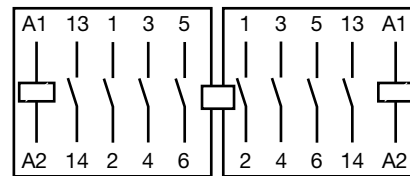

2CDC212007F0012

VB6(7)-30-10 ...  
VBC6(7)-30-10 ...

### Mini contactor relays

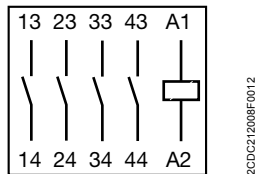

2CDC212009F0012

K6-40E ...  
KC6-40E ...

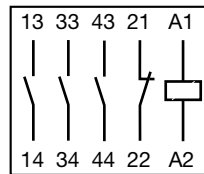

2CDC212009F0012

K6-31Z ...  
KC6-31Z ...

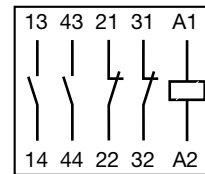

2CDC212010F0012

K6-22Z ...  
KC6-22Z ...

### Auxiliary switches

#### CA6...

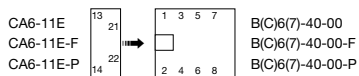

2CDC212011F0012

B(C)6(7)-40-00  
B(C)6(7)-40-00-F  
B(C)6(7)-40-00-P

#### CAF...

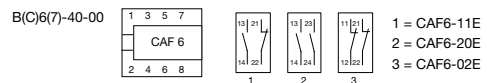

2CDC212015F0012

1 = CAF6-11E  
2 = CAF6-20E  
3 = CAF6-02E

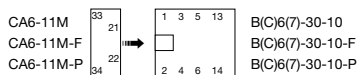

2CDC212012F0012

B(C)6(7)-30-10  
B(C)6(7)-30-10-F  
B(C)6(7)-30-10-P

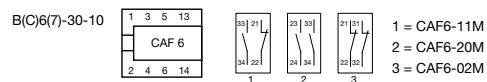

2CDC212016F0012

1 = CAF6-11M  
2 = CAF6-20M  
3 = CAF6-02M



2CDC212019F0012

B(C)6(7)-30-01  
B(C)6(7)-30-01-F  
B(C)6(7)-30-01-P

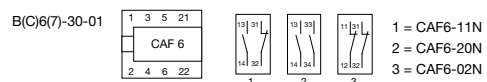

2CDC212017F0012

1 = CAF6-11N  
2 = CAF6-20N  
3 = CAF6-02N



2CDC212014F0012

K(C)6 .....  
K(C)6 .....-F  
K(C)6 .....-P

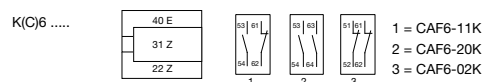

2CDC212018F0012

1 = CAF6-11K  
2 = CAF6-20K  
3 = CAF6-02K





# AS contactors and NS contactor relays with screw terminals

[Overview](#) 4/2

---

[Motor starting solutions - open type version, in kit form  
with screw terminals](#) 4/5

---

[3-pole contactors and contactor relays with screw terminals](#) 4/29

---

[Voltage code table](#) 4/82

---

# Compact Optimize your equipment dimensions!

**One frame size** for contactors up to 7.5 kW - 400 V

## Same dimensions

for AC and DC operated contactors with screw or spring terminals

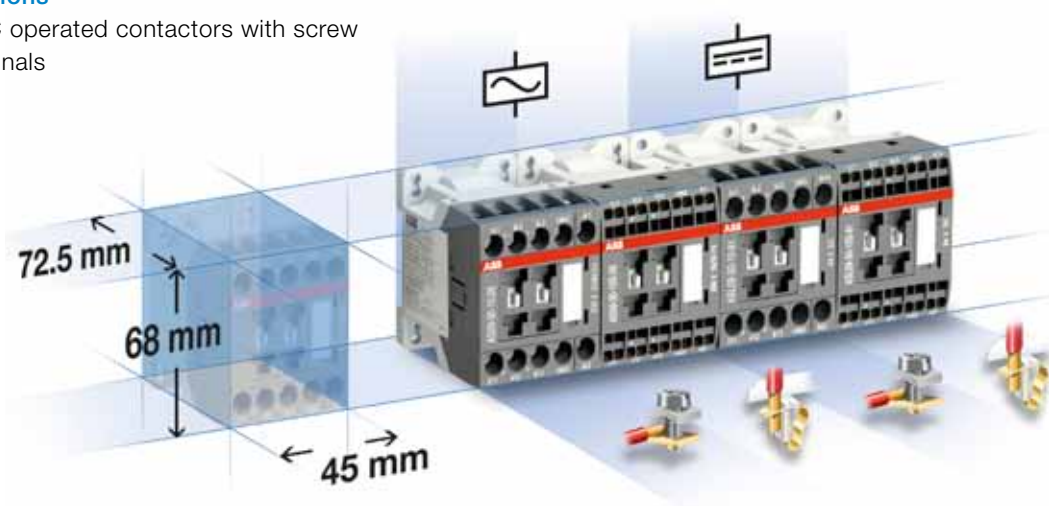

4

## Reversing contactors

including mechanical and electrical interlocking without additional width

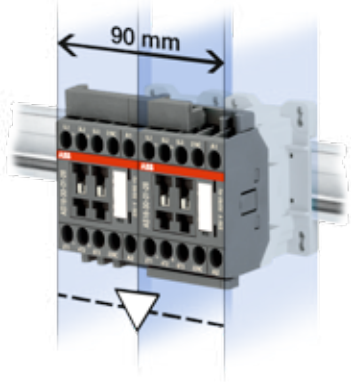

## Direct control by PLC

removing any use of interface relay and reducing panel power consumption



## Side clipped-on surge suppressors

integrated into overall contactor dimensions allowing free access to coil terminals



## Multiple packaging available for all products



# Simple

## Choose reliable and time-saving solutions

### Select compact starters:

- Direct-on-line and reversing starters up to 7.5 kW – 400 V
- Star-delta starters up to 11 KW – 400 V.

### Protect your motors against short-circuits and overloads

- Type 1 or type 2 coordination guaranteed between contactors and short-circuit protection devices (manual motor starters or fuses)



### Time/cost saving solutions with

- Connection sets for reversing and star-delta starter
- Easy, fast and secure assembly, fitting and wiring of components
- Direct 35 mm rail mounting: no additional mounting plate required
- Easy installation and dismantling of contactors: no unwiring of manual motor starters.



Compliant to International standards  
Complies with RoHS European directives



### Make your control circuits safe



High reliability  
for low signals



Mechanically linked  
contacts according to  
IEC 60947-5-1  
Annex L 3.0



Mirror contact  
according to  
IEC 60947-4-1  
Annex F 2.1

### Time and space-saving solutions, suitable for your applications

- Escalators
- Elevators
- Conveyors
- Compressors
- Door control
- Hvac
- Pumps
- Washing machines...





# Motor starting solutions

## Open type version, in kit form with screw terminals

### Starters protected by manual motor starters

Overview	4/6
Direct-on-line starters	4/8
Reversing starters	4/12
Dimensions	4/16

### Starters protected by thermal overload relays

Overview	4/6
Direct-on-line and reversing starters	4/18
Star-delta starters	4/22
Dimensions	4/26

# Motor starting solutions

## Open type version, in kit form

### Starters protected by manual motor starters

#### Direct-on-line starters

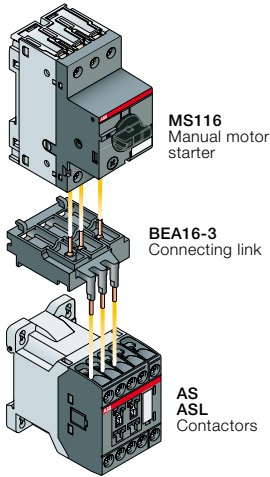
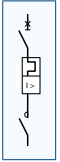

#### Reversing starters

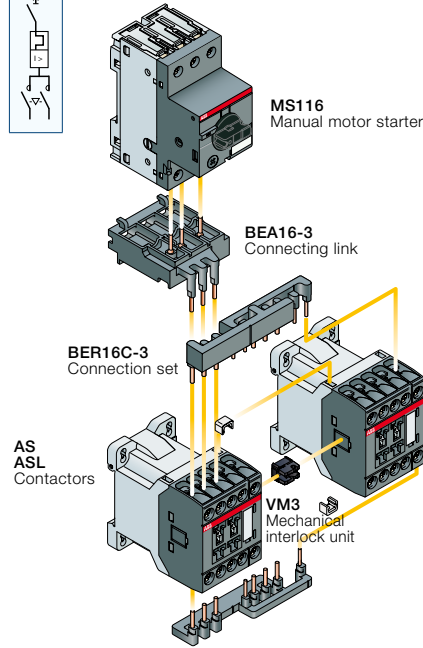
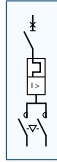

### Starters protected by thermal overload relays

#### Direct-on-line starters

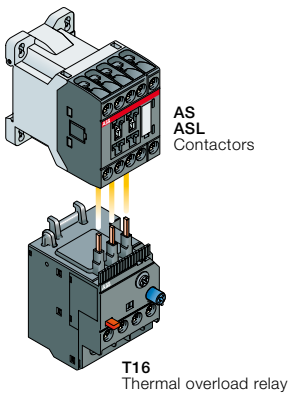

#### Reversing starters

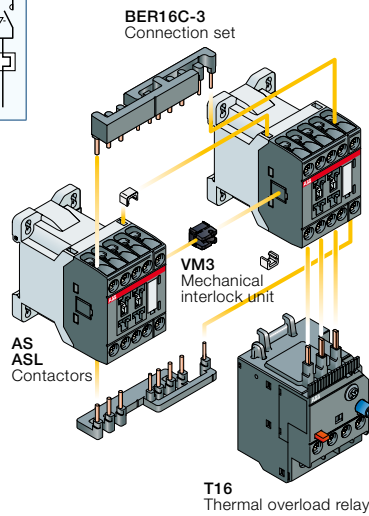

#### Star-delta starters

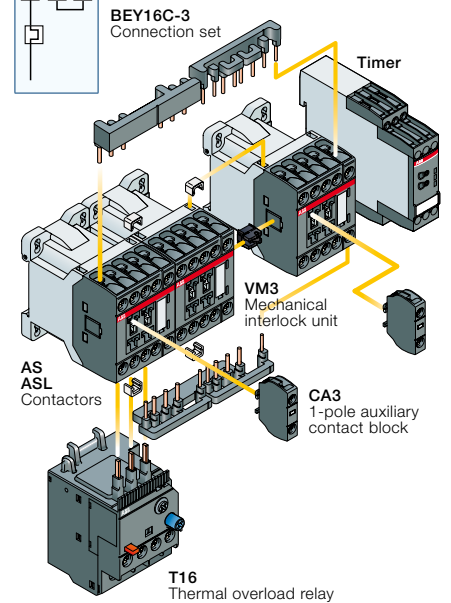



## Starters protected by manual motor starters



Switching of 3-phase cage motors		Direct-on-line starters	Reversing starters
Rated power - AC-3, 400 V		0.06...7.5 kW	0.06...7.5 kW
Short-circuit current I <sub>q</sub>		16 kA - 50 kA	16 kA - 50 kA
Coordination type		Type 1 & type 2	Type 1 & type 2
<b>Manual motor starters</b>		<b>MS116</b>	<b>MS116</b>
Contactors	AC operated	AS09 ... AS16	AS09 ... AS16
	DC operated	ASL09 ... ASL16	ASL09 ... ASL16

4

## Starters protected by thermal overload relays

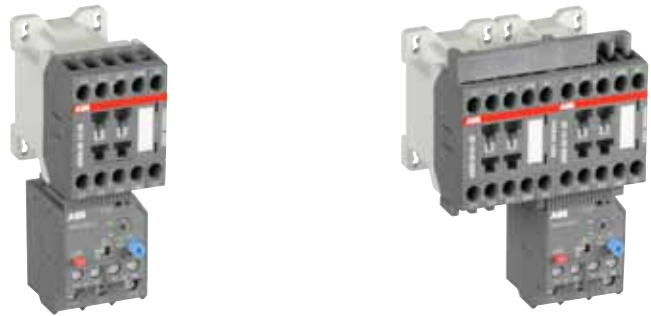

Switching of 3-phase cage motors		Direct-on-line starters	Reversing starters
Rated power - AC-3, 400 V		4...7.5 kW	4...7.5 kW
Contactors	AC operated	AS09 ... AS16	AS09 ... AS16
	DC operated	ASL09 ... ASL16	ASL09 ... ASL16
Thermal overload relays		T16	T16



Switching of 3-phase cage motors		Star-delta starters
Rated power - AC-3, 400 V		7.5...11 kW
Contactors	AC operated	AS09 ... AS16
	DC operated	ASL09 ... ASL16
Thermal overload relays		T16

1SEC101271S0201

# Direct-on-line starters protected by manual motor starters

## With AS, ASL contactors - open type version in kit form

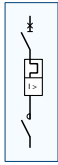

### Application

Full voltage direct-on-line starting for controlling three-phase asynchronous motors is a simple and economic solution characterised by a high starting torque (1.9 to 2.1 times full-speed torque) and a starting current 5.5 to 7 times nominal current.

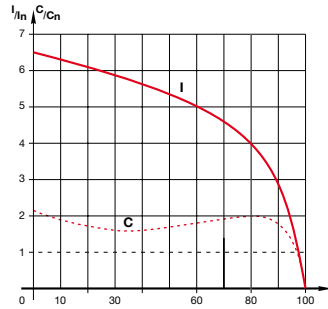

I = current  
C = torque  
In = nominal current  
Cn = nominal torque

MS116 + BEA16-3 + AS16-30-10

### Coordination types

The contactor and the manual motor starter control and protect motors against overload and short-circuits according to coordination types 1 and 2 (IEC 60947-4-1 / EN 60947-4-1) defining the anticipated level of service continuity as follow:

**Type 1:** In short-circuit conditions, the contactor or starter does not endanger persons or installations and will not be able to then operate without being repaired or having parts replaced.

**Type 2:** In short-circuit conditions, the contactor or starter does not endanger persons or installations and will be able to operate afterwards. The risk of contacts light welding is acceptable.

### Main technical data

Standards	IEC 60947-4-1 / EN 60947-4-1
Rated operational voltage Ue max.	690 V - 50/60 Hz
Rated insulation voltage Ui according to IEC 60947-4-1	690 V
Switching frequency	≤ 15 starts/hour - 80 % max. load factor - with max. 1.5 s starting time ≤ 30 starts/hour - 50 % max. load factor - with max. 1.5 s starting time
Ambient air temperature close to the device	≤ 55 °C
Degree of protection	IP20

### Mounting positions

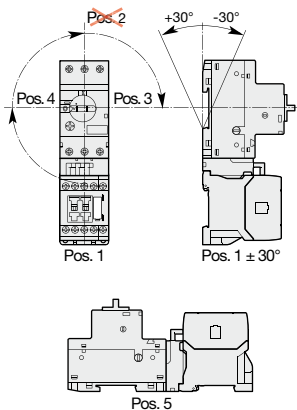

# Direct-on-line starters protected by manual motor starters

## With AS, ASL contactors - open type version in kit form

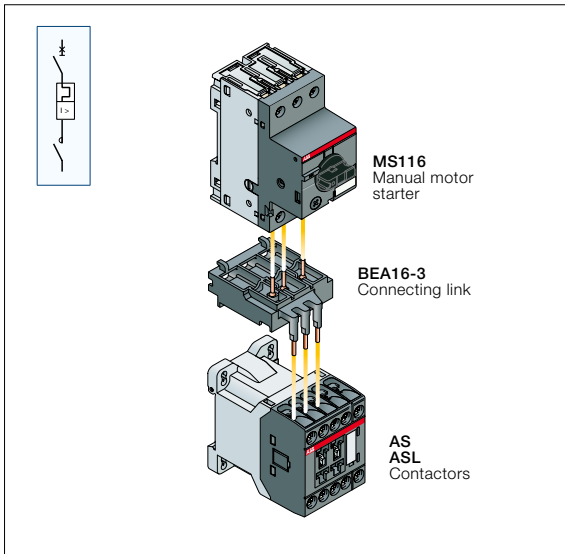

### Description

You can easily assemble a direct-on-line starter by using the BEA16-3 connecting link 3-pole insulated. It is used to electrically and mechanically connect MS116 manual motor starter and AS or ASL contactors.

**Select now easily and quickly your starter** in the following pages for coordination type 1 or 2 at 400 V, 50 / 60 Hz, I<sub>q</sub> = 16 kA or I<sub>q</sub> = 50 kA up to 7.5 kW.

For complete coordination tables with MS116 or MS132, please contact your ABB local sales organization.

### Wiring diagrams

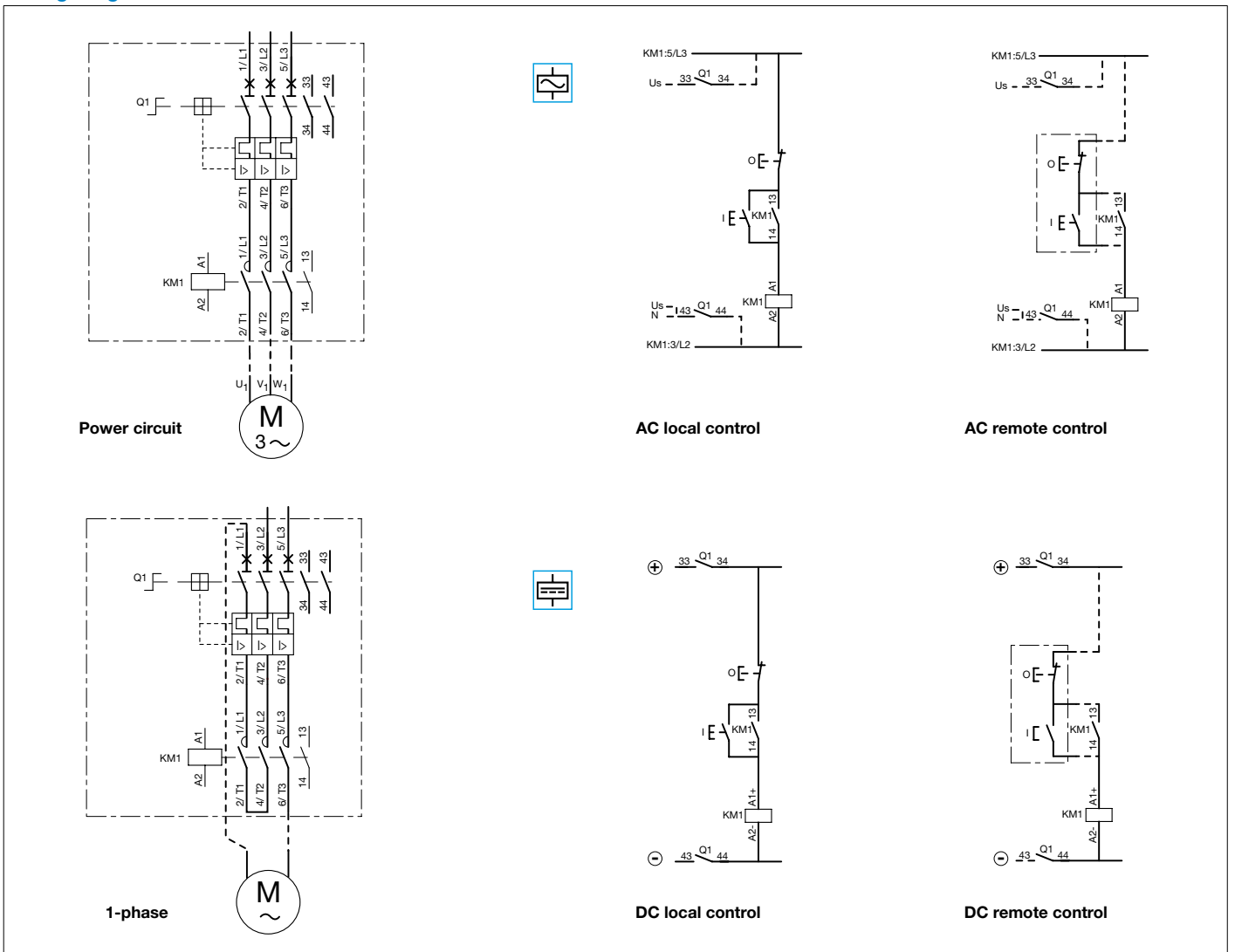

# DOL starters protected by MS116 manual motor starters

## With AS contactors - open type version in kit form

Coordination type 1 or type 2, AC-3, 16 kA or 50 kA, 400 V, 50/60 Hz

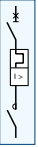
 IEC AC-3, 400 V Rated operational power kW	Manual motor starters				Contactors				
	Type	Order code	Current setting range	Magnetic tripping current	Rated control circuit voltage U <sub>c</sub> (1)	Type	Order code	Allowed setting current	
	A	A	A	A	V 50 Hz	V 60 Hz	A		

Coordination type 1

Coordination type 2

I<sub>q</sub> = 16 kA

I<sub>q</sub> = 50 kA

4

0.06	0.2	MS116-0.25	1SAM250000R1002	0.16...0.25	2.44	24	24	AS09-30-10-20	1SBL101001R2010	0.25
						-	120	AS09-30-10-16	1SBL101001R1610	
						230	230	AS09-30-10-26	1SBL101001R2610	
						400	400	AS09-30-10-28	1SBL101001R2810	
0.09	0.3	MS116-0.4	1SAM250000R1003	0.25...0.40	3.9	24	24	AS09-30-10-20	1SBL101001R2010	0.4
						-	120	AS09-30-10-16	1SBL101001R1610	
						230	230	AS09-30-10-26	1SBL101001R2610	
						400	400	AS09-30-10-28	1SBL101001R2810	
0.12	0.44	MS116-0.63	1SAM250000R1004	0.40...0.63	6.14	24	24	AS09-30-10-20	1SBL101001R2010	0.63
						-	120	AS09-30-10-16	1SBL101001R1610	
						230	230	AS09-30-10-26	1SBL101001R2610	
						400	400	AS09-30-10-28	1SBL101001R2810	
0.18	0.6	MS116-1.0	1SAM250000R1005	0.63...1.00	11.5	24	24	AS09-30-10-20	1SBL101001R2010	1
						-	120	AS09-30-10-16	1SBL101001R1610	
						230	230	AS09-30-10-26	1SBL101001R2610	
						400	400	AS09-30-10-28	1SBL101001R2810	
0.25	0.85	MS116-1.0	1SAM250000R1005	0.63...1.00	11.5	24	24	AS09-30-10-20	1SBL101001R2010	1
						-	120	AS09-30-10-16	1SBL101001R1610	
						230	230	AS09-30-10-26	1SBL101001R2610	
						400	400	AS09-30-10-28	1SBL101001R2810	
0.37	1.1	MS116-1.6	1SAM250000R1006	1.00...1.60	18.4	24	24	AS09-30-10-20	1SBL101001R2010	1.6
						-	120	AS09-30-10-16	1SBL101001R1610	
						230	230	AS09-30-10-26	1SBL101001R2610	
						400	400	AS09-30-10-28	1SBL101001R2810	
0.55	1.5	MS116-1.6	1SAM250000R1006	1.00...1.60	18.4	24	24	AS09-30-10-20	1SBL101001R2010	1.6
						-	120	AS09-30-10-16	1SBL101001R1610	
						230	230	AS09-30-10-26	1SBL101001R2610	
						400	400	AS09-30-10-28	1SBL101001R2810	
0.75	1.9	MS116-2.5	1SAM250000R1007	1.60...2.50	28.75	24	24	AS09-30-10-20	1SBL101001R2010	2.5
						-	120	AS09-30-10-16	1SBL101001R1610	
						230	230	AS09-30-10-26	1SBL101001R2610	
						400	400	AS09-30-10-28	1SBL101001R2810	
1.1	2.7	MS116-4.0	1SAM250000R1008	2.50...4.00	50	24	24	AS09-30-10-20	1SBL101001R2010	4
						-	120	AS09-30-10-16	1SBL101001R1610	
						230	230	AS09-30-10-26	1SBL101001R2610	
						400	400	AS09-30-10-28	1SBL101001R2810	
1.5	3.6	MS116-4.0	1SAM250000R1008	2.50...4.00	50	24	24	AS09-30-10-20	1SBL101001R2010	4
						-	120	AS09-30-10-16	1SBL101001R1610	
						230	230	AS09-30-10-26	1SBL101001R2610	
						400	400	AS09-30-10-28	1SBL101001R2810	
2.2	4.9	MS116-6.3	1SAM250000R1009	4.00...6.30	78.75	24	24	AS09-30-10-20	1SBL101001R2010	6.3
						-	120	AS09-30-10-16	1SBL101001R1610	
						230	230	AS09-30-10-26	1SBL101001R2610	
						400	400	AS09-30-10-28	1SBL101001R2810	
3	6.5	MS116-10	1SAM250000R1010	6.30...10.0	150	24	24	AS12-30-10-20	1SBL111001R2010	10
						-	120	AS12-30-10-16	1SBL111001R1610	
						230	230	AS12-30-10-26	1SBL111001R2610	
						400	400	AS12-30-10-28	1SBL111001R2810	
4	8.5	MS116-10	1SAM250000R1010	6.30...10.0	150	24	24	AS12-30-10-20	1SBL111001R2010	10
						-	120	AS12-30-10-16	1SBL111001R1610	
						230	230	AS12-30-10-26	1SBL111001R2610	
						400	400	AS12-30-10-28	1SBL111001R2810	
5.5	11.5	MS116-12	1SAM250000R1012	8.00...12.0	180	24	24	AS12-30-10-20	1SBL111001R2010	12
						-	120	AS12-30-10-16	1SBL111001R1610	
						230	230	AS12-30-10-26	1SBL111001R2610	
						400	400	AS12-30-10-28	1SBL111001R2810	
7.5	15.5	MS116-16	1SAM250000R1011	10.0...16.0	240	24	24	AS16-30-10-20	1SBL121001R2010	15.5
						-	120	AS16-30-10-16	1SBL121001R1610	
						230	230	AS16-30-10-26	1SBL121001R2610	
						400	400	AS16-30-10-28	1SBL121001R2810	

Note: for multiple packaging, please contact your ABB local sales organization.

(1) Other control voltages see voltage code table.



Main accessories

Connecting link for manual motor starter

Type

BEA16-3



Order code

1SBN081006T1000

# DOL starters protected by MS116 manual motor starters

## With ASL contactors - open type version in kit form

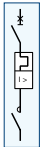
Coordination type 1 or type 2, AC-3, 16 or 50 kA, 400 V, 50/60 Hz

	Manual motor starters				Contactors					
	IEC	Type	Order code	Current setting range	Magnetic tripping current	Rated control circuit voltage Uc (1)	Type	Order code	Allowed setting current	
	AC-3, 400 V Rated operational power kW			A	A	V DC			A	
Coordination type 1										
Coordination type 2										
										
0.06	0.2	MS116-0.25	1SAM250000R1002	0.16...0.25	2.44	24 48 110 220	ASL09-30-10-81 ASL09-30-10-83 ASL09-30-10-86 ASL09-30-10-88	1SBL103001R8110 1SBL103001R8310 1SBL103001R8610 1SBL103001R8810	0.25	
0.09	0.3	MS116-0.4	1SAM250000R1003	0.25...0.40	3.9	24 48 110 220	ASL09-30-10-81 ASL09-30-10-83 ASL09-30-10-86 ASL09-30-10-88	1SBL103001R8110 1SBL103001R8310 1SBL103001R8610 1SBL103001R8810	0.4	
0.12	0.44	MS116-0.63	1SAM250000R1004	0.40...0.63	6.14	24 48 110 220	ASL09-30-10-81 ASL09-30-10-83 ASL09-30-10-86 ASL09-30-10-88	1SBL103001R8110 1SBL103001R8310 1SBL103001R8610 1SBL103001R8810	0.63	
0.18	0.6	MS116-1.0	1SAM250000R1005	0.63...1.00	11.5	24 48 110 220	ASL09-30-10-81 ASL09-30-10-83 ASL09-30-10-86 ASL09-30-10-88	1SBL103001R8110 1SBL103001R8310 1SBL103001R8610 1SBL103001R8810	1	
0.25	0.85	MS116-1.0	1SAM250000R1005	0.63...1.00	11.5	24 48 110 220	ASL09-30-10-81 ASL09-30-10-83 ASL09-30-10-86 ASL09-30-10-88	1SBL103001R8110 1SBL103001R8310 1SBL103001R8610 1SBL103001R8810	1	
0.37	1.1	MS116-1.6	1SAM250000R1006	1.00...1.60	18.4	24 48 110 220	ASL09-30-10-81 ASL09-30-10-83 ASL09-30-10-86 ASL09-30-10-88	1SBL103001R8110 1SBL103001R8310 1SBL103001R8610 1SBL103001R8810	1.6	
0.55	1.5	MS116-1.6	1SAM250000R1006	1.00...1.60	18.4	24 48 110 220	ASL09-30-10-81 ASL09-30-10-83 ASL09-30-10-86 ASL09-30-10-88	1SBL103001R8110 1SBL103001R8310 1SBL103001R8610 1SBL103001R8810	1.6	
0.75	1.9	MS116-2.5	1SAM250000R1007	1.60...2.50	28.75	24 48 110 220	ASL09-30-10-81 ASL09-30-10-83 ASL09-30-10-86 ASL09-30-10-88	1SBL103001R8110 1SBL103001R8310 1SBL103001R8610 1SBL103001R8810	2.5	
1.1	2.7	MS116-4.0	1SAM250000R1008	2.50...4.00	50	24 48 110 220	ASL09-30-10-81 ASL09-30-10-83 ASL09-30-10-86 ASL09-30-10-88	1SBL103001R8110 1SBL103001R8310 1SBL103001R8610 1SBL103001R8810	4	
1.5	3.6	MS116-4.0	1SAM250000R1008	2.50...4.00	50	24 48 110 220	ASL09-30-10-81 ASL09-30-10-83 ASL09-30-10-86 ASL09-30-10-88	1SBL103001R8110 1SBL103001R8310 1SBL103001R8610 1SBL103001R8810	4	
2.2	4.9	MS116-6.3	1SAM250000R1009	4.00...6.30	78.75	24 48 110 220	ASL09-30-10-81 ASL09-30-10-83 ASL09-30-10-86 ASL09-30-10-88	1SBL103001R8110 1SBL103001R8310 1SBL103001R8610 1SBL103001R8810	6.3	
3	6.5	MS116-10	1SAM250000R1010	6.30...10.0	150	24 48 110 220	ASL12-30-10-81 ASL12-30-10-83 ASL12-30-10-86 ASL12-30-10-88	1SBL113001R8110 1SBL113001R8310 1SBL113001R8610 1SBL113001R8810	10	
4	8.5	MS116-10	1SAM250000R1010	6.30...10.0	150	24 48 110 220	ASL12-30-10-81 ASL12-30-10-83 ASL12-30-10-86 ASL12-30-10-88	1SBL113001R8110 1SBL113001R8310 1SBL113001R8610 1SBL113001R8810	10	
5.5	11.5	MS116-12	1SAM250000R1012	8.00...12.0	180	24 48 110 220	ASL12-30-10-81 ASL12-30-10-83 ASL12-30-10-86 ASL12-30-10-88	1SBL113001R8110 1SBL113001R8310 1SBL113001R8610 1SBL113001R8810	12	
7.5	15.5	MS116-16	1SAM250000R1011	10.0...16.0	240	24 48 110 220	ASL16-30-10-81 ASL16-30-10-83 ASL16-30-10-86 ASL16-30-10-88	1SBL123001R8110 1SBL123001R8310 1SBL123001R8610 1SBL123001R8810	15.5	

Note: for multiple packaging, please contact your ABB local sales organization.

(1) Other control voltages see voltage code table.



### Main accessories

Connecting link for manual motor starter

Type

BEA16-3

Order code

1SBN081006T1000

# Reversing starters protected by manual motor starters

## With AS, ASL contactors - open type version in kit form

4

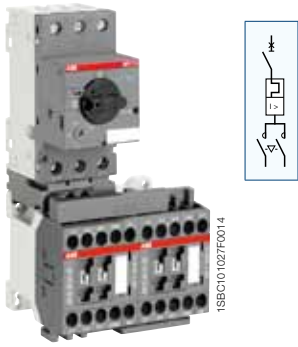

MS116 + BEA16-3 + VM3 + BER16C-3 + AS16-30-01

### Application

Full voltage reversing starting for controlling three-phase asynchronous motors is a simple and economic solution characterised by a high starting torque (1.9 to 2.1 times full-speed torque) and a starting current 5.5 to 7 times nominal current.

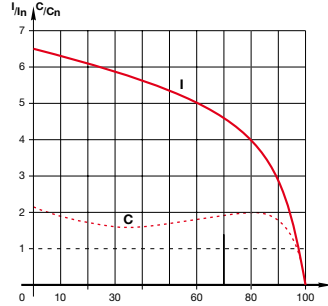

I = current  
C = torque  
In = nominal current  
Cn = nominal torque

### Coordination types

The contactor and the manual motor starter control and protect motors against overload and short-circuits according to coordination types 1 and 2 (IEC 60947-4-1 / EN 60947-4-1) defining the anticipated level of service continuity as follow:

**Type 1:** In short-circuit conditions, the contactor or starter does not endanger persons or installations and will not be able to then operate without being repaired or having parts replaced.

**Type 2:** In short-circuit conditions, the contactor or starter does not endanger persons or installations and will be able to operate afterwards. The risk of contacts light welding is acceptable.

### Main technical data

Standards	IEC 60947-4-1 / EN 60947-4-1
Rated operational voltage Ue max.	690 V - 50/60 Hz
Rated insulation voltage Ui according to IEC 60947-4-1	690 V
Switching frequency	≤ 15 starts/hour - 80 % max. load factor - with max. 1.5 s starting time ≤ 30 starts/hour - 50 % max. load factor - with max. 1.5 s starting time
Ambient air temperature close to the device	≤ 55 °C
Degree of protection	IP20

Note: Minimum switchover delay of 50 ms must be introduced between respective opening and closing of AC operated reversing contactors

### Mounting positions

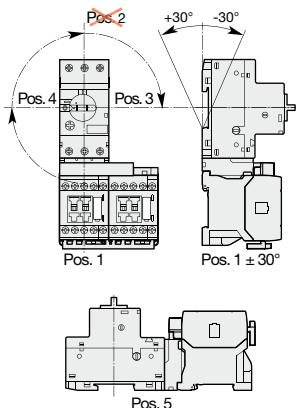

# Reversing starters protected by manual motor starters

## With AS, ASL contactors - open type version in kit form

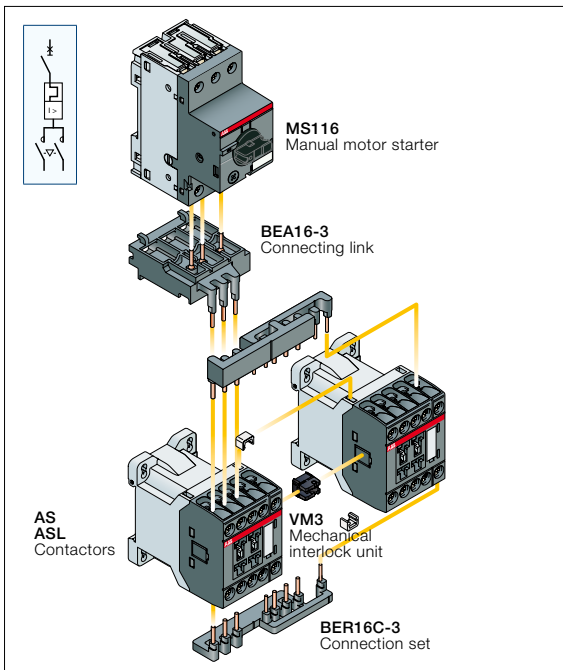

### Description

You can easily assemble reversing starter thanks to our complete range of accessories:

- BEA16-3 connecting link 3-pole insulated: it is used to electrically and mechanically connect MS116 manual motor starter and AS or ASL contactors.
- VM3 mechanical interlock unit: just clip it between the 2 contactors without increasing starter width.
- BER16C-3 connection set: it assures a safe and simple connection between both contactor main terminals and an electrical interlocking between coil and N.C. built-in auxiliary contact terminals of both contactors.

**Select now easily and quickly your starter** in the following pages for coordination type 1 or 2 at 400 V, 50 / 60 Hz, I<sub>q</sub> = 16 kA or I<sub>q</sub> = 50 kA up to 7.5 kW.

For complete coordination tables with MS116 or MS132, please contact your ABB local sales organization.

### Wiring diagrams

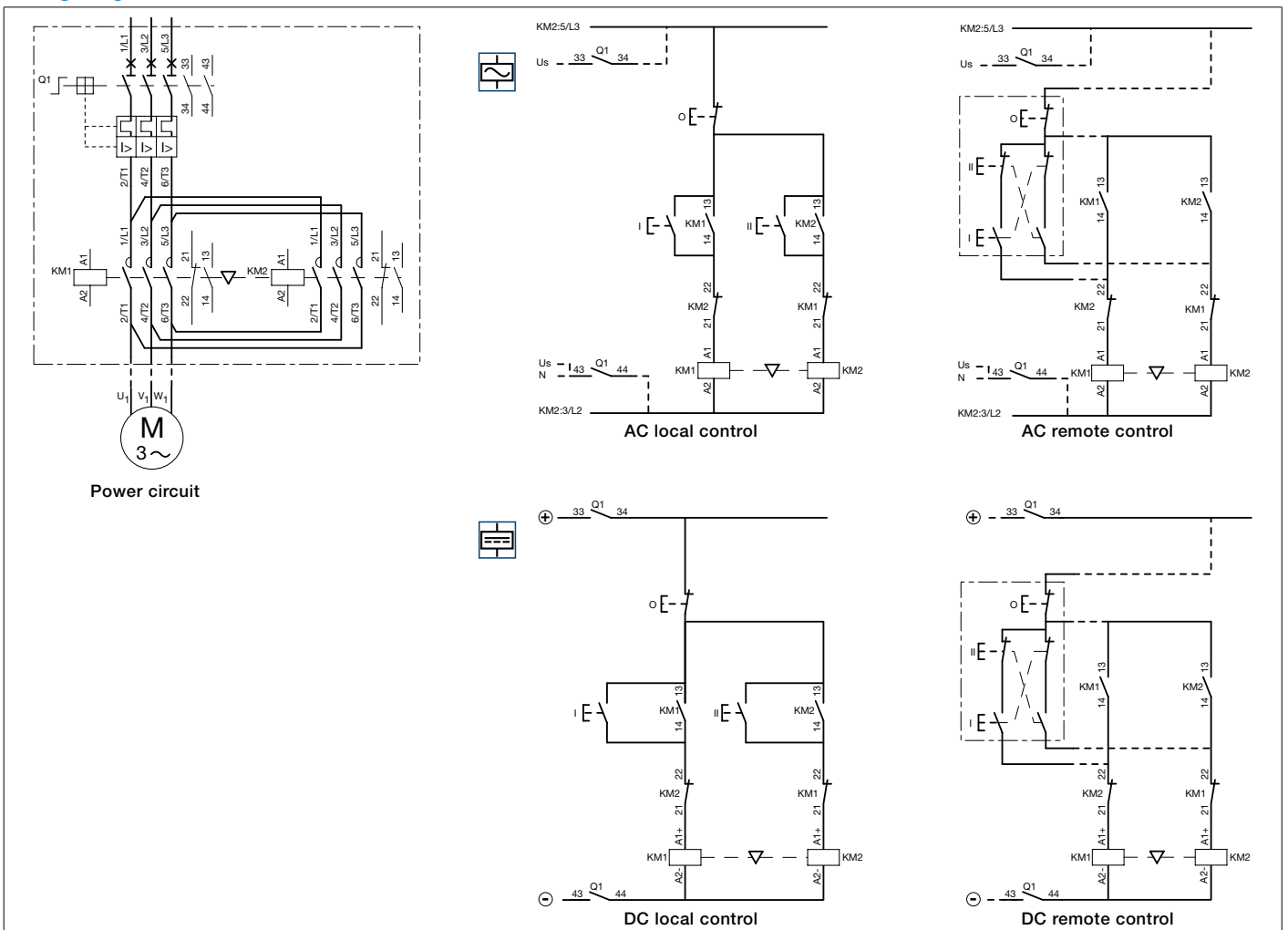



# Reversing starters protected by MS116 manual motor starters



## With AS contactors - open type version in kit form

Coordination type 1 or type 2, AC-3, 16 kA or 50 kA, 400 V, 50/60 Hz

IEC AC-3, 400 V Rated operational power kW	Type	Manual motor starters		Current setting range A	Magnetic tripping current A	Contactors		Type	Order code	Allowed setting current A
		Type	Order code			Rated control circuit voltage Uc (1) V 50 Hz	V 60 Hz			
		Rated operational current A								
0.06	0.2	MS116-0.25	1SAM250000R1002	0.16...0.25	2.44	24	24	AS09-30-01-20	1SBL101001R2001	0.25
						-	120	AS09-30-01-16	1SBL101001R1601	
0.09	0.3	MS116-0.4	1SAM250000R1003	0.25...0.40	3.9	230	230	AS09-30-01-26	1SBL101001R2601	0.4
						400	400	AS09-30-01-28	1SBL101001R2801	
						-	120	AS09-30-01-16	1SBL101001R1601	
0.12	0.44	MS116-0.63	1SAM250000R1004	0.40...0.63	6.14	230	230	AS09-30-01-26	1SBL101001R2601	0.63
						400	400	AS09-30-01-28	1SBL101001R2801	
						-	120	AS09-30-01-16	1SBL101001R1601	
0.18	0.6	MS116-1.0	1SAM250000R1005	0.63...1.00	11.5	230	230	AS09-30-01-26	1SBL101001R2601	1
						400	400	AS09-30-01-28	1SBL101001R2801	
						-	120	AS09-30-01-16	1SBL101001R1601	
0.25	0.85	MS116-1.0	1SAM250000R1005	0.63...1.00	11.5	24	24	AS09-30-01-20	1SBL101001R2001	1
						-	120	AS09-30-01-16	1SBL101001R1601	
						230	230	AS09-30-01-26	1SBL101001R2601	
0.37	1.1	MS116-1.6	1SAM250000R1006	1.00...1.60	18.4	400	400	AS09-30-01-28	1SBL101001R2801	1.6
						-	120	AS09-30-01-16	1SBL101001R1601	
						230	230	AS09-30-01-26	1SBL101001R2601	
0.55	1.5	MS116-1.6	1SAM250000R1006	1.00...1.60	18.4	400	400	AS09-30-01-28	1SBL101001R2801	1.6
						-	120	AS09-30-01-16	1SBL101001R1601	
						230	230	AS09-30-01-26	1SBL101001R2601	
0.75	1.9	MS116-2.5	1SAM250000R1007	1.60...2.50	28.75	400	400	AS09-30-01-28	1SBL101001R2801	2.5
						-	120	AS09-30-01-16	1SBL101001R1601	
						230	230	AS09-30-01-26	1SBL101001R2601	
1.1	2.7	MS116-4.0	1SAM250000R1008	2.50...4.00	50	24	24	AS09-30-01-20	1SBL101001R2001	4
						-	120	AS09-30-01-16	1SBL101001R1601	
						230	230	AS09-30-01-26	1SBL101001R2601	
1.5	3.6	MS116-4.0	1SAM250000R1008	2.50...4.00	50	400	400	AS09-30-01-28	1SBL101001R2801	4
						-	120	AS09-30-01-16	1SBL101001R1601	
						230	230	AS09-30-01-26	1SBL101001R2601	
2.2	4.9	MS116-6.3	1SAM250000R1009	4.00...6.30	78.75	400	400	AS09-30-01-28	1SBL101001R2801	6.3
						-	120	AS09-30-01-16	1SBL101001R1601	
						230	230	AS09-30-01-26	1SBL101001R2601	
3	6.5	MS116-10	1SAM250000R1010	6.30...10.0	150	24	24	AS12-30-01-20	1SBL111001R2001	10
						-	120	AS12-30-01-16	1SBL111001R1601	
						230	230	AS12-30-01-26	1SBL111001R2601	
4	8.5	MS116-10	1SAM250000R1010	6.30...10.0	150	400	400	AS12-30-01-28	1SBL111001R2801	10
						-	120	AS12-30-01-16	1SBL111001R1601	
						230	230	AS12-30-01-26	1SBL111001R2601	
5.5	11.5	MS116-12	1SAM250000R1012	8.00...12.0	180	400	400	AS12-30-01-28	1SBL111001R2801	12
						-	120	AS12-30-01-16	1SBL111001R1601	
						230	230	AS12-30-01-26	1SBL111001R2601	
7.5	15.5	MS116-16	1SAM250000R1011	10.0...16.0	240	24	24	AS16-30-01-20	1SBL121001R2001	15.5
						-	120	AS16-30-01-16	1SBL121001R1601	
						230	230	AS16-30-01-26	1SBL121001R2601	
						400	400	AS16-30-01-28	1SBL121001R2801	

Note: for multiple packaging, please contact your ABB local sales organization.

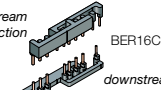
(1) Other control voltages see voltage code table.

Main accessories		Type	Order code
	Connecting link for manual motor starter	BEA16-3	1ISBN081006T1000
	Connection set for reversing starter	BER16C-3	1ISBN081012R1000
	Mechanical interlock unit	VM3	1ISBN031005T1000

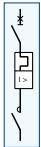

# Reversing starters protected by MS116 manual motor starters With ASL contactors - open type version in kit form

Coordination type 1 or type 2, AC-3, 16 or 50 kA, 400 V, 50/60 Hz

IEC AC-3, 400 V Rated operational power current kW A		Manual motor starters				Contactors				
Type	Order code	Current setting range A	Magnetic tripping current A	Rated control circuit voltage Uc (1) V DC	Type	Order code	Allowed setting current A			
	Coordination type 1		Coordination type 2							
	0.06	0.2	MS116-0.25	1SAM250000R1002	0.16...0.25	2.44	24 48 110 220	ASL09-30-01-81 ASL09-30-01-83 ASL09-30-01-86 ASL09-30-01-88	1SBL103001R8101 1SBL103001R8301 1SBL103001R8601 1SBL103001R8801	0.25
	0.09	0.3	MS116-0.4	1SAM250000R1003	0.25...0.40	3.9	24 48 110 220	ASL09-30-01-81 ASL09-30-01-83 ASL09-30-01-86 ASL09-30-01-88	1SBL103001R8101 1SBL103001R8301 1SBL103001R8601 1SBL103001R8801	0.4
	0.12	0.44	MS116-0.63	1SAM250000R1004	0.40...0.63	6.14	24 48 110 220	ASL09-30-01-81 ASL09-30-01-83 ASL09-30-01-86 ASL09-30-01-88	1SBL103001R8101 1SBL103001R8301 1SBL103001R8601 1SBL103001R8801	0.63
	0.18	0.6	MS116-1.0	1SAM250000R1005	0.63...1.00	11.5	24 48 110 220	ASL09-30-01-81 ASL09-30-01-83 ASL09-30-01-86 ASL09-30-01-88	1SBL103001R8101 1SBL103001R8301 1SBL103001R8601 1SBL103001R8801	1
	0.25	0.85	MS116-1.0	1SAM250000R1005	0.63...1.00	11.5	24 48 110 220	ASL09-30-01-81 ASL09-30-01-83 ASL09-30-01-86 ASL09-30-01-88	1SBL103001R8101 1SBL103001R8301 1SBL103001R8601 1SBL103001R8801	1
	0.37	1.1	MS116-1.6	1SAM250000R1006	1.00...1.60	18.4	24 48 110 220	ASL09-30-01-81 ASL09-30-01-83 ASL09-30-01-86 ASL09-30-01-88	1SBL103001R8101 1SBL103001R8301 1SBL103001R8601 1SBL103001R8801	1.6
	0.55	1.5	MS116-1.6	1SAM250000R1006	1.00...1.60	18.4	24 48 110 220	ASL09-30-01-81 ASL09-30-01-83 ASL09-30-01-86 ASL09-30-01-88	1SBL103001R8101 1SBL103001R8301 1SBL103001R8601 1SBL103001R8801	1.6
	0.75	1.9	MS116-2.5	1SAM250000R1007	1.60...2.50	28.75	24 48 110 220	ASL09-30-01-81 ASL09-30-01-83 ASL09-30-01-86 ASL09-30-01-88	1SBL103001R8101 1SBL103001R8301 1SBL103001R8601 1SBL103001R8801	2.5
	1.1	2.7	MS116-4.0	1SAM250000R1008	2.50...4.00	50	24 48 110 220	ASL09-30-01-81 ASL09-30-01-83 ASL09-30-01-86 ASL09-30-01-88	1SBL103001R8101 1SBL103001R8301 1SBL103001R8601 1SBL103001R8801	4
	1.5	3.6	MS116-4.0	1SAM250000R1008	2.50...4.00	50	24 48 110 220	ASL09-30-01-81 ASL09-30-01-83 ASL09-30-01-86 ASL09-30-01-88	1SBL103001R8101 1SBL103001R8301 1SBL103001R8601 1SBL103001R8801	4
	2.2	4.9	MS116-6.3	1SAM250000R1009	4.00...6.30	78.75	24 48 110 220	ASL09-30-01-81 ASL09-30-01-83 ASL09-30-01-86 ASL09-30-01-88	1SBL103001R8101 1SBL103001R8301 1SBL103001R8601 1SBL103001R8801	6.3
	3	6.5	MS116-10	1SAM250000R1010	6.30...10.0	150	24 48 110 220	ASL12-30-01-81 ASL12-30-01-83 ASL12-30-01-86 ASL12-30-01-88	1SBL113001R8101 1SBL113001R8301 1SBL113001R8601 1SBL113001R8801	10
	4	8.5	MS116-10	1SAM250000R1010	6.30...10.0	150	24 48 110 220	ASL12-30-01-81 ASL12-30-01-83 ASL12-30-01-86 ASL12-30-01-88	1SBL113001R8101 1SBL113001R8301 1SBL113001R8601 1SBL113001R8801	10
	5.5	11.5	MS116-12	1SAM250000R1012	8.00...12.0	180	24 48 110 220	ASL12-30-01-81 ASL12-30-01-83 ASL12-30-01-86 ASL12-30-01-88	1SBL113001R8101 1SBL113001R8301 1SBL113001R8601 1SBL113001R8801	12
	7.5	15.5	MS116-16	1SAM250000R1011	10.0...16.0	240	24 48 110 220	ASL16-30-01-81 ASL16-30-01-83 ASL16-30-01-86 ASL16-30-01-88	1SBL123001R8101 1SBL123001R8301 1SBL123001R8601 1SBL123001R8801	15.5

Note: for multiple packaging, please contact your ABB local sales organization.

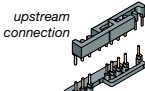
(1) Other control voltages see voltage code table.

Main accessories		Type	Order code
	Connecting link for manual motor starter	BEA16-3	1SBN081006T1000
	Connection set for reversing starter	BER16C-3	1SBN081012R1000
	Mechanical interlock unit	VM3	1SBN031005T1000

1SBC10127350201

# DOL starters protected by MS116 manual motor starters

## With AS, ASL contactors - open type version in kit form

### Main dimensions mm, inches

#### Direct-on-line starters

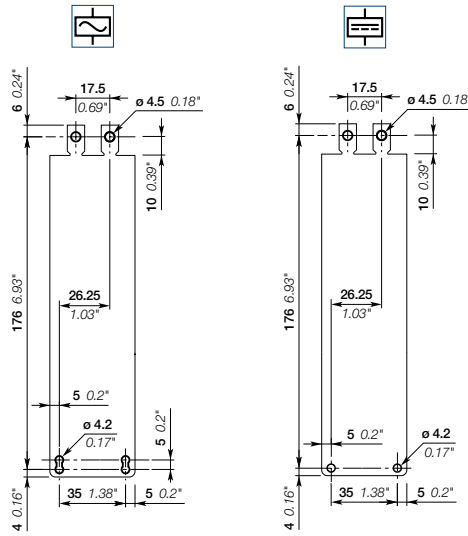
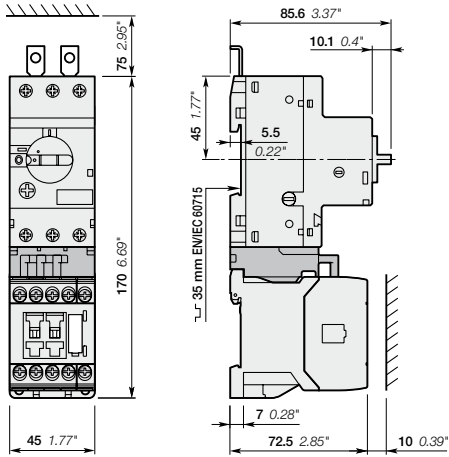

MS116

+ BEA16-3

+ AS09, ASL09, AS12, ASL12, AS16, ASL16

# Reversing starters protected by MS116 manual motor starters With AS, ASL contactors - open type version in kit form

Main dimensions mm, inches

## Reversing starters

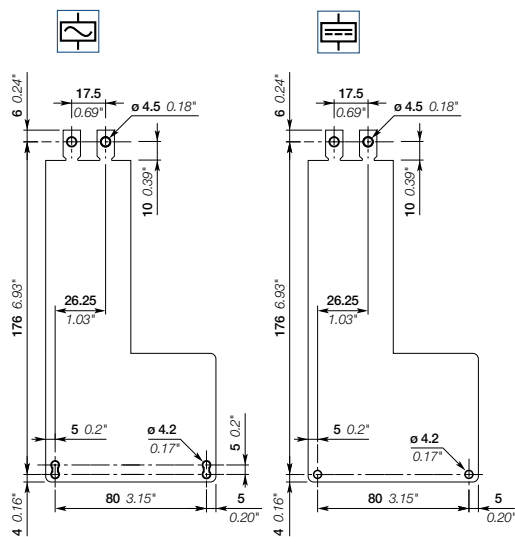
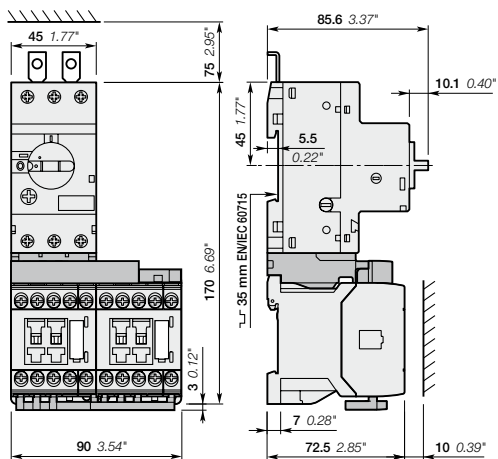

### MS116

+ BEA16-3 + BER16C-3 + VM3

+ AS09, ASL09, AS12, ASL12, AS16, ASL16

# DOL & reversing starters protected by thermal overload relays

## With AS, ASL contactors - open type version in kit form



AS09-30-10 + T16

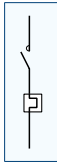

### Application

Full voltage direct-on-line and reversing starting for controlling three-phase asynchronous motors is a simple and economic solution characterised by a high starting torque (1.9 to 2.1 times full-speed torque) and a starting current 5.5 to 7 times nominal current.

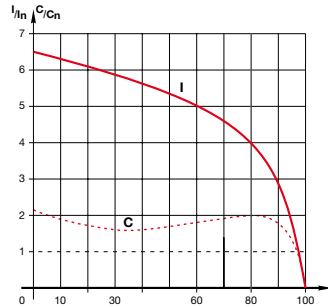

I = current  
C = torque  
 $I_n$  = nominal current  
 $C_n$  = nominal torque



AS09-30-01 + BER16C + VM3 + T16



### Coordination types

The contactor, the short-circuit protection device and the thermal overload relay control and protect motors against overload and short-circuits according to coordination types 1 and 2 (IEC 60947-4-1 / EN 60947-4-1) defining the anticipated level of service continuity as follow:

**Type 1:** In short-circuit conditions, the contactor or starter does not endanger persons or installations and will not be able to then operate without being repaired or having parts replaced.

**Type 2:** In short-circuit conditions, the contactor or starter does not endanger persons or installations and will be able to operate afterwards. The risk of contacts light welding is acceptable.

### Main technical data

Standards	IEC 60947-4-1 / EN 60947-4-1
Rated operational voltage $U_e$ max.	690 V - 50/60 Hz
Rated insulation voltage $U_i$ according to IEC 60947-4-1	690 V
Air temperature close to the device	$\leq 60$ °C
Degree of protection	IP20

#### Switching frequency

Thermal overload relays cannot be operated at any arbitrary switching frequency in order to avoid tripping. Applications involving up to 15 operations per hour are acceptable. Higher switching frequencies are permitted if the duty ratio and the motor starting time are allowed for and if the motor's making current does not appreciably exceed 6 times the rated operating current. Please refer to the adjacent diagram for guideline values for the permitted switching frequency.

Example:

Starting time of the motor: 1 second Duty ratio: 40 % means a permitted switching frequency of max. 60 operating cycles per hour.

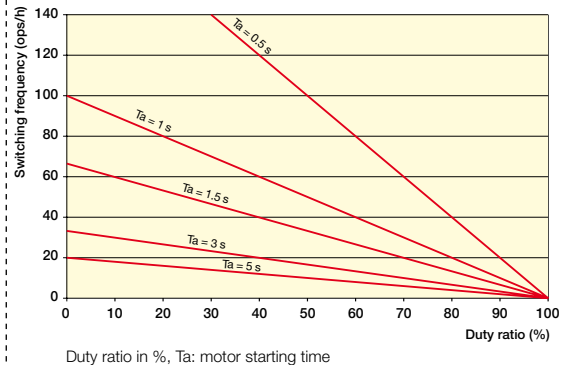

Note: Minimum switchover delay of 50 ms must be introduced between respective opening and closing of AC operated reversing contactors

### Mounting positions

Direct-on-line

Reversing

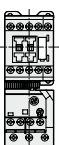

Pos. 1

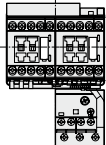

Pos. 1

# DOL & reversing starters protected by thermal overload relays With AS, ASL contactors - open type version in kit form

## Direct-on-line starters

## Reversing starters

## Description

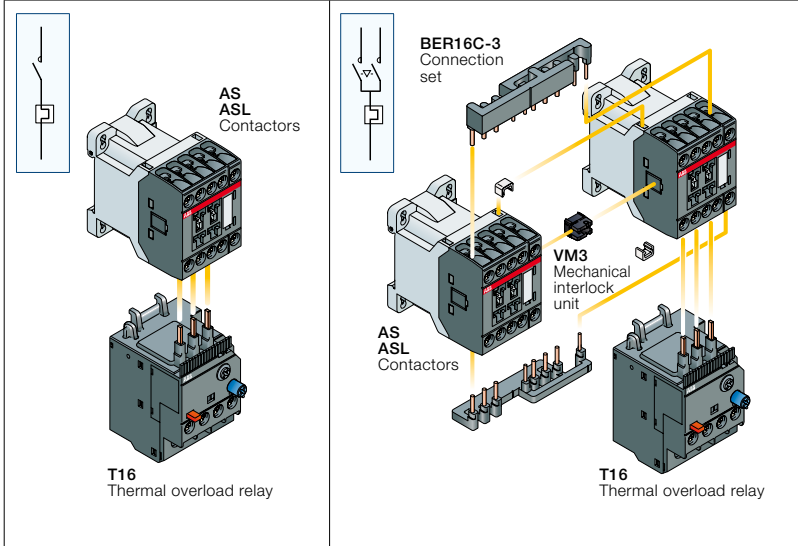

You can easily assemble a direct-on-line starter by connecting AS or ASL contactors and T16 thermal overload relay.

You can easily assemble reversing starter thanks to our complete range of accessories:

- VM3 mechanical interlock unit: just clip it between the 2 contactors without increasing starter length.
- BER16C-3 connection set: it assures a safe and simple reversing connection between both contactor main terminals and an electrical interlocking between coil and N.C. built-in auxiliary contact terminals of both contactors.

**Select now easily and quickly your starter** in the following pages at 400 V, up to 7.5 kW.

For complete coordination tables, please contact your ABB local sales organization.

## Wiring diagrams

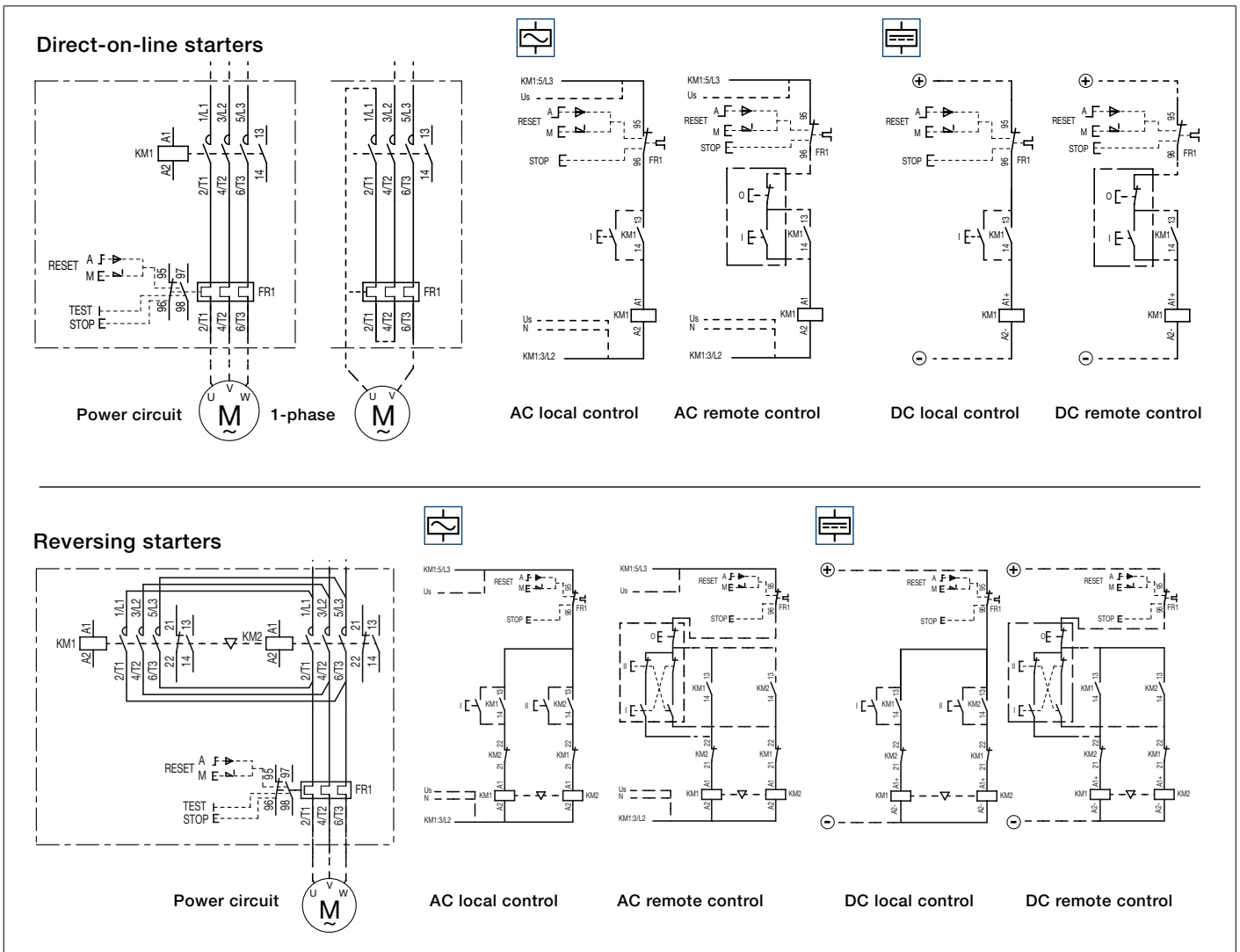

# DOL starters protected by thermal overload relays

## With AS, ASL contactors - open type version in kit form

### Contactors - AC operated

IEC AC-3, 400 V Rated operational power kW		Rated control circuit voltage Uc (1) V 50 Hz V 60 Hz		Type	Order code	Setting ranges A ... A	Type	Order code	Accessories
4	8.5	24	24	AS09-30-10-20	1SBL101001R2010	7.60...10.0	T16-10	1SAZ711201R1043	-
		-	120	AS09-30-10-16	1SBL101001R1610				
		230	230	AS09-30-10-26	1SBL101001R2610				
		400	400	AS09-30-10-28	1SBL101001R2810				
5.5	11.5	24	24	AS12-30-10-20	1SBL111001R2010	10.0...13.0	T16-13	1SAZ711201R1045	-
		-	120	AS12-30-10-16	1SBL111001R1610				
		230	230	AS12-30-10-26	1SBL111001R2610				
		400	400	AS12-30-10-28	1SBL111001R2810				
7.5	15.5	24	24	AS16-30-10-20	1SBL121001R2010	13.0...16.0	T16-16	1SAZ711201R1047	-
		-	120	AS16-30-10-16	1SBL121001R1610				
		230	230	AS16-30-10-26	1SBL121001R2610				
		400	400	AS16-30-10-28	1SBL121001R2810				

### Contactors - DC operated

IEC AC-3, 400 V Rated operational power kW		Rated control circuit voltage Uc (1) DC		Type	Order code	Setting ranges A ... A	Type	Order code	Accessories
4	8.5	24		ASL09-30-10-81	1SBL103001R8110	7.60...10.0	T16-10	1SAZ711201R1043	-
		48		ASL09-30-10-83	1SBL103001R8310				
		110		ASL09-30-10-86	1SBL103001R8610				
		220		ASL09-30-10-88	1SBL103001R8810				
5.5	11.5	24		ASL12-30-10-81	1SBL113001R8110	10.0...13.0	T16-13	1SAZ711201R1045	-
		48		ASL12-30-10-83	1SBL113001R8310				
		110		ASL12-30-10-86	1SBL113001R8610				
		220		ASL12-30-10-88	1SBL113001R8810				
7.5	15.5	24		ASL16-30-10-81	1SBL123001R8110	13.0...16.0	T16-16	1SAZ711201R1047	-
		48		ASL16-30-10-83	1SBL123001R8310				
		110		ASL16-30-10-86	1SBL123001R8610				
		220		ASL16-30-10-88	1SBL123001R8810				

Note: for multiple packaging, please contact your ABB local sales organization.  
 (1) Other control voltages see voltage code table.

see table below for all setting ranges

Setting ranges	Type	Order code
<b>A ... A</b>		
0.10...0.13	T16-0.13	1SAZ711201R1005
0.13...0.17	T16-0.17	1SAZ711201R1008
0.17...0.23	T16-0.23	1SAZ711201R1009
0.23...0.31	T16-0.31	1SAZ711201R1013
0.31...0.41	T16-0.41	1SAZ711201R1014
0.41...0.55	T16-0.55	1SAZ711201R1017
0.55...0.74	T16-0.74	1SAZ711201R1021
0.74...1.00	T16-1.0	1SAZ711201R1023
1.00...1.30	T16-1.3	1SAZ711201R1025
1.30...1.70	T16-1.7	1SAZ711201R1028
1.70...2.30	T16-2.3	1SAZ711201R1031
2.30...3.10	T16-3.1	1SAZ711201R1033
3.10...4.20	T16-4.2	1SAZ711201R1035
4.20...5.70	T16-5.7	1SAZ711201R1038
5.70...7.60	T16-7.6	1SAZ711201R1040
7.60...10.0	T16-10	1SAZ711201R1043
10.0...13.0	T16-13	1SAZ711201R1045
13.0...16.0	T16-16	1SAZ711201R1047



# Reversing starters protected by thermal overload relays

## With AS, ASL contactors - open type version in kit form

### Contactors - AC operated

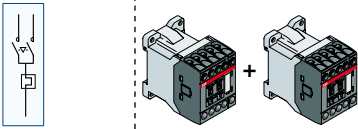
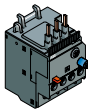
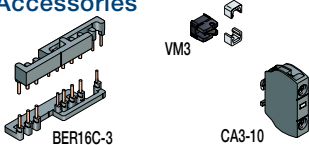
Contactors				Thermal overload relays			Accessories			
										
IEC AC-3, 400 V Rated operational power kW	Rated control circuit voltage U <sub>c</sub> (1) A	Type	Order code	Setting ranges A ... A	Type	Order code	Type	Order code		
4	8.5	24 24	AS09-30-01-20	1SBL101001R2001	7.60...10.0	T16-10	1SAZ711201R1043	BER16C-3 + VM3 + 2x CA3-10	1SBN081012R1000 + 1SBN031005T1000 + 1SBN011010T1010	
		- 120	AS09-30-01-16	1SBL101001R1601						
		230 230	AS09-30-01-26	1SBL101001R2601						
5.5	11.5	24 24	AS12-30-01-20	1SBL111001R2001	10.0...13.0	T16-13	1SAZ711201R1045	BER16C-3 + VM3 + 2x CA3-10	1SBN081012R1000 + 1SBN031005T1000 + 1SBN011010T1010	
		- 120	AS12-30-01-16	1SBL111001R1601						
		230 230	AS12-30-01-26	1SBL111001R2601						
7.5	15.5	24 24	AS16-30-01-20	1SBL121001R2001	13.0...16.0	T16-16	1SAZ711201R1047	BER16C-3 + VM3 + 2x CA3-10	1SBN081012R1000 + 1SBN031005T1000 + 1SBN011010T1010	
		- 120	AS16-30-01-16	1SBL121001R1601						
		230 230	AS16-30-01-26	1SBL121001R2601						
		400 400	AS16-30-01-28	1SBL121001R2801						

### Contactors - DC operated

IEC AC-3, 400 V Rated operational power kW	Rated control circuit voltage U <sub>c</sub> (1) A	Type	Order code	Setting ranges A ... A	Type	Order code	Type	Order code	
4	8.5	24	ASL09-30-10-81	1SBL103001R8110	7.60...10.0	T16-10	1SAZ711201R1043	BER16C-3 + VM3 + 2x CA3-10	1SBN081012R1000 + 1SBN031005T1000 + 1SBN011010T1010
		48	ASL09-30-10-83	1SBL103001R8310					
		110	ASL09-30-10-86	1SBL103001R8610					
		220	ASL09-30-10-88	1SBL103001R8810					
5.5	11.5	24	ASL12-30-10-81	1SBL113001R8110	10.0...13.0	T16-13	1SAZ711201R1045	BER16C-3 + VM3 + 2x CA3-10	1SBN081012R1000 + 1SBN031005T1000 + 1SBN011010T1010
		48	ASL12-30-10-83	1SBL113001R8310					
		110	ASL12-30-10-86	1SBL113001R8610					
		220	ASL12-30-10-88	1SBL113001R8810					
7.5	15.5	24	ASL16-30-10-81	1SBL123001R8110	13.0...16.0	T16-16	1SAZ711201R1047	BER16C-3 + VM3 + 2x CA3-10	1SBN081012R1000 + 1SBN031005T1000 + 1SBN011010T1010
		48	ASL16-30-10-83	1SBL123001R8310					
		110	ASL16-30-10-86	1SBL123001R8610					
		220	ASL16-30-10-88	1SBL123001R8810					

Note: for multiple packaging, please contact your ABB local sales organization.

(1) Other control voltages see voltage code table.

see table below for all setting ranges

Setting ranges A ... A	Type	Order code
0.10...0.13	T16-0.13	1SAZ711201R1005
0.13...0.17	T16-0.17	1SAZ711201R1008
0.17...0.23	T16-0.23	1SAZ711201R1009
0.23...0.31	T16-0.31	1SAZ711201R1013
0.31...0.41	T16-0.41	1SAZ711201R1014
0.41...0.55	T16-0.55	1SAZ711201R1017
0.55...0.74	T16-0.74	1SAZ711201R1021
0.74...1.00	T16-1.0	1SAZ711201R1023
1.00...1.30	T16-1.3	1SAZ711201R1025
1.30...1.70	T16-1.7	1SAZ711201R1028
1.70...2.30	T16-2.3	1SAZ711201R1031
2.30...3.10	T16-3.1	1SAZ711201R1033
3.10...4.20	T16-4.2	1SAZ711201R1035
4.20...5.70	T16-5.7	1SAZ711201R1038
5.70...7.60	T16-7.6	1SAZ711201R1040
7.60...10.0	T16-10	1SAZ711201R1043
10.0...13.0	T16-13	1SAZ711201R1045
13.0...16.0	T16-16	1SAZ711201R1047

# Star-delta starters protected by thermal overload relays

## With AS, ASL contactors - open type version in kit form

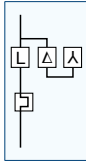

### Application

Star-delta starting is the most common method to reduce the starting current of a motor. This system can be used on all the squirrel cage motors, which are normally used in delta connection. In this type of starting, it is recommended to choose motors having high starting torque i.e. much higher than the resistive torque in order to reach sufficient high speed when the motor is connected in star.

### When starting:

- Inrush current is reduced to a third of direct starting current
- Motor torque is reduced to a third or even less of direct starting torque.

Transient current is generated when switching from star to delta connection.

During the initial starting phase ("star" connection), the resistive torque of the driven load must remain, irrespective of speed, less than the "star" motor torque until "star-delta" switching occurs.

This starting mode is therefore ideal for machines having low starting torque such as pumps, centrifugal compressors, wood-working machines...

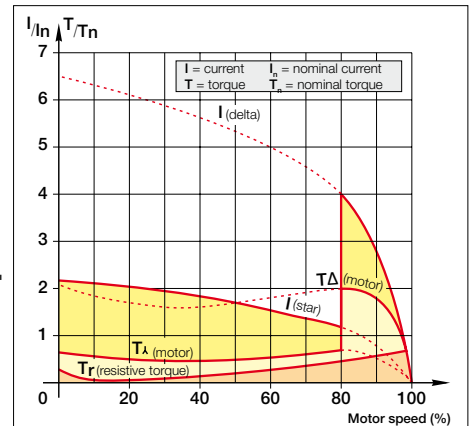

### Precaution

- Motor nominal voltage in delta connection must be equal to that of the mains. Example: a motor for 400 V star-delta starting must be designed for 400 V in "delta" connection. Its usual designation is "400 V / 690 V motor". The motor must be constructed with 6 terminal windings
- In order to prevent a high current peak, at least 85 % of nominal speed must be reached before switching from star to delta

### Sequence

#### Starting is a three-stage process:

- 1<sup>st</sup> stage:** "Star" connection - Press the "On" button on the control circuit to close the KM2 "Star" contactor. The KM1 "line" contactor then closes and the motor starts. Countdown of programmed starting time (6 to 10 s) then begins.
- 2<sup>nd</sup> stage:** "Star" to "Delta" switching - when programmed starting time is over, the KM2 "Star" contactor opens.
- 3<sup>rd</sup> stage:** "Delta" connection - A transition time (or dwelling time) of 50 ms is fixed between opening of the "star" contactor and closing of the "delta" contactor by the use of CT-SDS timer. This prevent short-circuit between "star" and "delta".

### Main technical data

Standards	IEC 60947-4-1 / EN 60947-4-1
Rated operational voltage $U_e$ max.	690 V - 50/60 Hz
Rated insulation voltage $U_i$ according to IEC 60947-4-1	690 V
Air temperature close to the device	$\leq 60$ °C
Degree of protection	IP20
Switching frequency	
Switching frequency/hour, according to acceleration time and load factor. Respect of the following conditions enables utilization of the starter without excessive overheating of the connections or nuisance tripping of the thermal overload relay.	
Example:	
- Switching frequency = 15 starts/hr	
- Motor starting time "Ta" = 7 s (use 8 s curve)	
- Maximum load factor = 63 %	
This corresponds to a 4-minute operating cycle (15 starts/hr) with 7 seconds acceleration, 2.5 minutes operation and 1.5 minutes rest.	

4



AS09-30-10 + AS09-30-01  
+ AS09-30-01 + BEY16C-3 + VM3  
+ CT-SDS + CA3-10 + T16

### Mounting positions

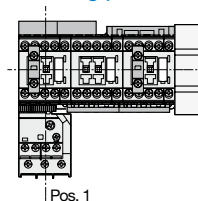

# Star-delta starters protected by thermal overload relays

## With AS, ASL contactors - open type version in kit form

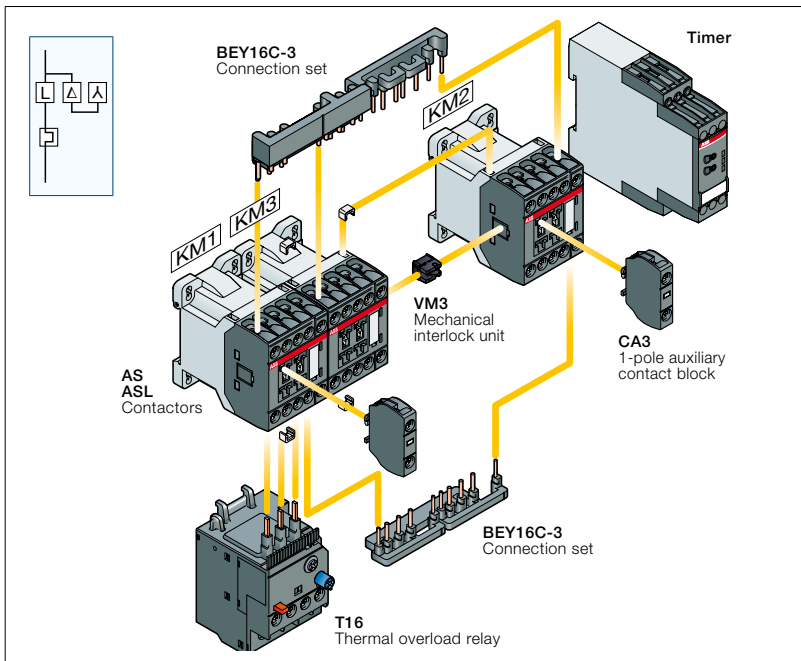

### Description

You can easily assemble a star-delta starter thanks to our complete range of accessories:

- VM3 mechanical interlock unit: just clip it between the 2 contactors without increasing starter length.
- BEY16C-3 connection set: it assures a safe and simple connection between contactors main terminals and an electrical interlocking between coil and N.C. built-in auxiliary contact terminals of star and delta contactors.

Select now easily and quickly your starter in the following pages at 400 V, up to 11 kW.

For complete coordination tables, please contact your ABB local sales organization.

### Wiring diagrams

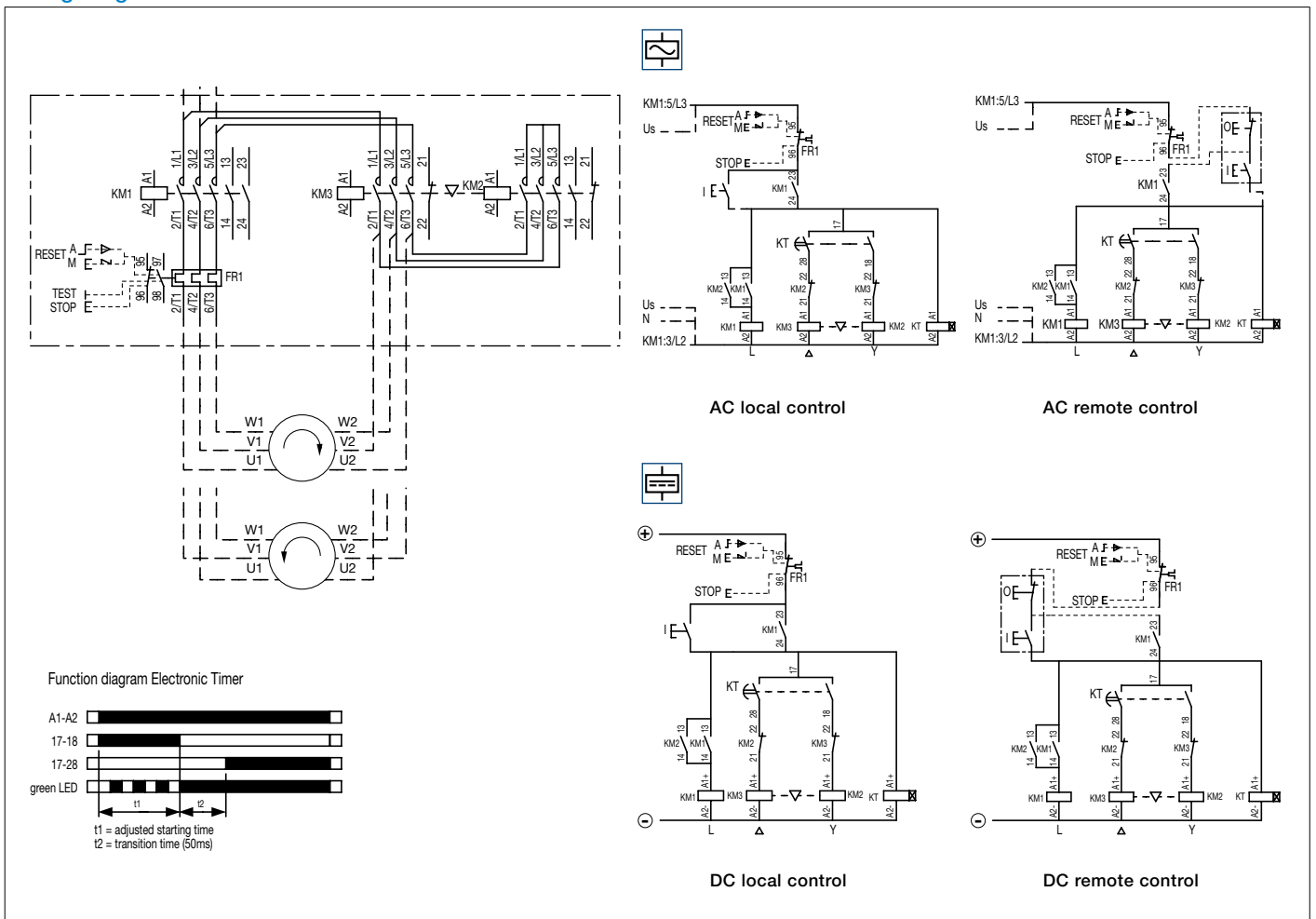

# Star-delta starters protected by thermal overload relays

## With AS, ASL contactors - open type version in kit form

### Contactors - AC operated

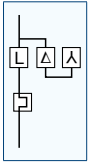

Line contactor KM1

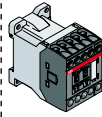

Delta contactor KM3

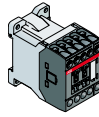

Star contactor KM2

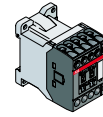



IEC AC-3, 400 V Rated operational power	Rated control circuit voltage U <sub>c</sub> (1)	Rated operational current		Type	Order code	Type	Order code	Type	Order code		
		kW	A							V 50 Hz	V 60 Hz
7.5	15.5	-	24	AS09-30-10-20	1SBL101001R2010	AS09-30-01-20	1SBL101001R2001	AS09-30-01-20	1SBL101001R2001		
			120	AS09-30-10-16	1SBL101001R1610	AS09-30-01-16	1SBL101001R1601	AS09-30-01-16	1SBL101001R1601		
			230	AS09-30-10-26	1SBL101001R2610	AS09-30-01-26	1SBL101001R2601	AS09-30-01-26	1SBL101001R2601		
			400	AS09-30-10-28	1SBL101001R2810	AS09-30-01-28	1SBL101001R2801	AS09-30-01-28	1SBL101001R2801		
11	22	-	24	AS12-30-10-20	1SBL111001R2010	AS12-30-01-20	1SBL111001R2001	AS09-30-01-20	1SBL101001R2001		
			120	AS12-30-10-16	1SBL111001R1610	AS12-30-01-16	1SBL111001R1601	AS09-30-01-16	1SBL101001R1601		
			230	AS12-30-10-26	1SBL111001R2610	AS12-30-01-26	1SBL111001R2601	AS09-30-01-26	1SBL101001R2601		
			400	AS12-30-10-28	1SBL111001R2810	AS12-30-01-28	1SBL111001R2801	AS09-30-01-28	1SBL101001R2801		

### Contactors - DC operated

IEC AC-3, 400 V Rated operational power	Rated control circuit voltage U <sub>c</sub> (1)	DC	Type	Order code	Type	Order code	Type	Order code		
									kW	A
7.5	15.5	-	24	ASL09-30-10-81	1SBL103001R8110	ASL09-30-01-81	1SBL103001R8101	ASL09-30-01-81	1SBL103001R8101	
			48	ASL09-30-10-83	1SBL103001R8310	ASL09-30-01-83	1SBL103001R8301	ASL09-30-01-83	1SBL103001R8301	
			110	ASL09-30-10-86	1SBL103001R8610	ASL09-30-01-86	1SBL103001R8601	ASL09-30-01-86	1SBL103001R8601	
			220	ASL09-30-10-88	1SBL103001R8810	ASL09-30-01-88	1SBL103001R8801	ASL09-30-01-88	1SBL103001R8801	
11	22	-	24	ASL12-30-10-81	1SBL113001R8110	ASL12-30-01-81	1SBL113001R8101	ASL09-30-01-81	1SBL103001R8101	
			48	ASL12-30-10-83	1SBL113001R8310	ASL12-30-01-83	1SBL113001R8301	ASL09-30-01-83	1SBL103001R8301	
			110	ASL12-30-10-86	1SBL113001R8610	ASL12-30-01-86	1SBL113001R8601	ASL09-30-01-86	1SBL103001R8601	
			220	ASL12-30-10-88	1SBL113001R8810	ASL12-30-01-88	1SBL113001R8801	ASL09-30-01-88	1SBL103001R8801	

Note: for multiple packaging, please contact your ABB local sales organization.  
(1) Other control voltages see voltage code table.

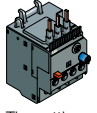
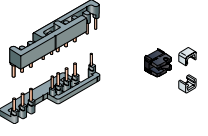
# Star-delta starters protected by thermal overload relays With AS, ASL contactors - open type version in kit form

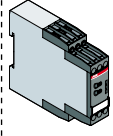
		Thermal overload relays		Connection sets Mechanical interlock unit		Auxiliary contact block		Electronic timer	
		 The setting current value is: nominal motor current x 0.58							
Setting ranges	Type	Order code	Type	Order code	Type	Order code	Type	Order code	
<b>A ... A</b>									
7.60...10.0	T16-10	1SAZ711201R1043	BEY16C-3 + VM3	1SBN081018R2000 + 1SBN031005T1000	<b>KM1:</b> 1 x CA3-10 <b>KM2:</b> 1 x CA3-10	1SBN011010T1010 1SBN011010T1010	CT-SDS...	see "Ordering Details"	
10.0...13.0	T16-13	1SAZ711201R1045	BEY16C-3 + VM3	1SBN081018R2000 + 1SBN031005T1000	<b>KM1:</b> 1 x CA3-10 <b>KM2:</b> 1 x CA3-10	1SBN011010T1010 1SBN011010T1010	CT-SDS...	see "Ordering Details"	

Setting ranges	Type	Order code	Type	Order code	Type	Order code	Type	Order code
<b>A ... A</b>								
7.60...10.0	T16-10	1SAZ711201R1043	BEY16C-3 + VM3	1SBN081018R2000 + 1SBN031005T1000	<b>KM1:</b> 1 x CA3-10 <b>KM2:</b> 1 x CA3-10	1SBN011010T1010 1SBN011010T1010	CT-SDS...	see "Ordering Details"
10.0...13.0	T16-13	1SAZ711201R1045	BEY16C-3 + VM3	1SBN081018R2000 + 1SBN031005T1000	<b>KM1:</b> 1 x CA3-10 <b>KM2:</b> 1 x CA3-10	1SBN011010T1010 1SBN011010T1010	CT-SDS...	see "Ordering Details"

see table below for all setting ranges

Setting ranges A ... A	Type	Order code
0.10...0.13	T16-0.13	1SAZ711201R1005
0.13...0.17	T16-0.17	1SAZ711201R1008
0.17...0.23	T16-0.23	1SAZ711201R1009
0.23...0.31	T16-0.31	1SAZ711201R1013
0.31...0.41	T16-0.41	1SAZ711201R1014
0.41...0.55	T16-0.55	1SAZ711201R1017
0.55...0.74	T16-0.74	1SAZ711201R1021
0.74...1.00	T16-1.0	1SAZ711201R1023
1.00...1.30	T16-1.3	1SAZ711201R1025
1.30...1.70	T16-1.7	1SAZ711201R1028
1.70...2.30	T16-2.3	1SAZ711201R1031
2.30...3.10	T16-3.1	1SAZ711201R1033
3.10...4.20	T16-4.2	1SAZ711201R1035
4.20...5.70	T16-5.7	1SAZ711201R1038
5.70...7.60	T16-7.6	1SAZ711201R1040
7.60...10.0	T16-10	1SAZ711201R1043
10.0...13.0	T16-13	1SAZ711201R1045
13.0...16.0	T16-16	1SAZ711201R1047

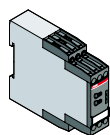

CT-SDS...

## Ordering details - Main accessories

	Type	Order code	Pkg qty	Weight (1 pce) kg
Electronic timer*	28-48 V DC 24-240 V AC	CT-SDS.22S 1SVR730210R3300	1	0.114
	380-440 V AC	CT-SDS.23S 1SVR730211R2300	1	0.118

\* 7 time ranges (0.05 s - 10 min), 50 ms transition time, 2 n/o contacts, 3 LEDs

# Protected by thermal overload relays

## With AS, ASL contactors - open type version in kit form

### Main dimensions mm, inches

#### Direct-on-line starters

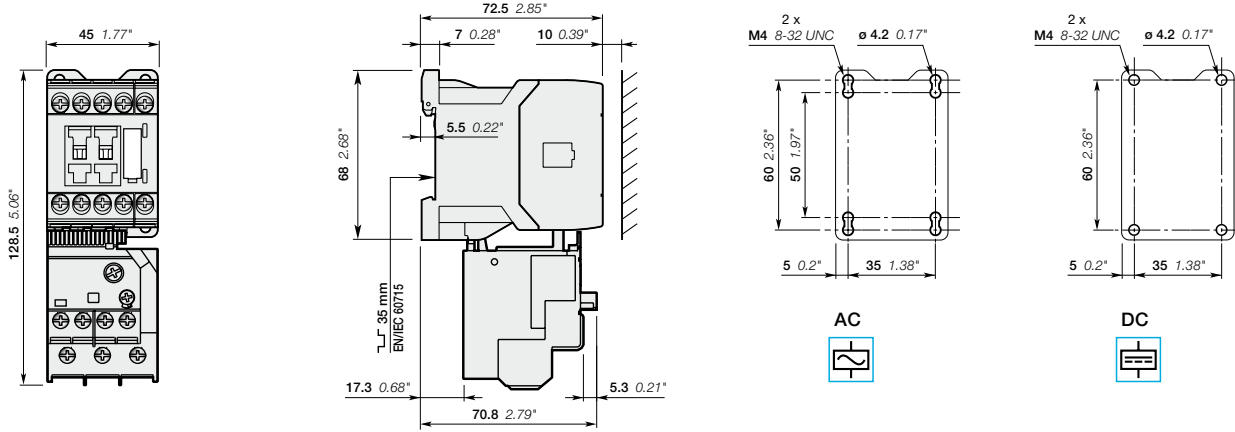

#### Reversing starters

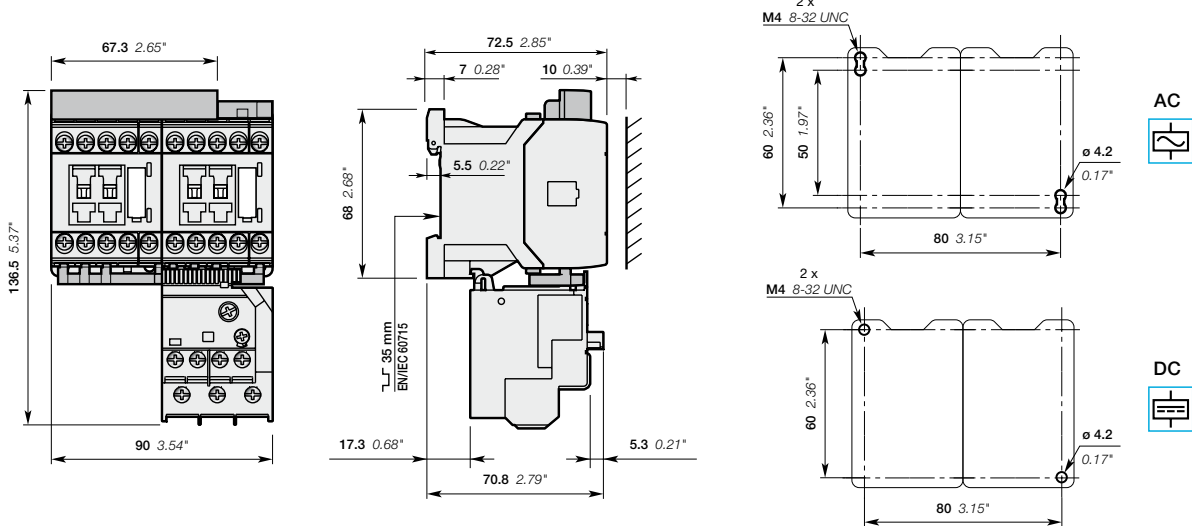

#### Star-delta starters

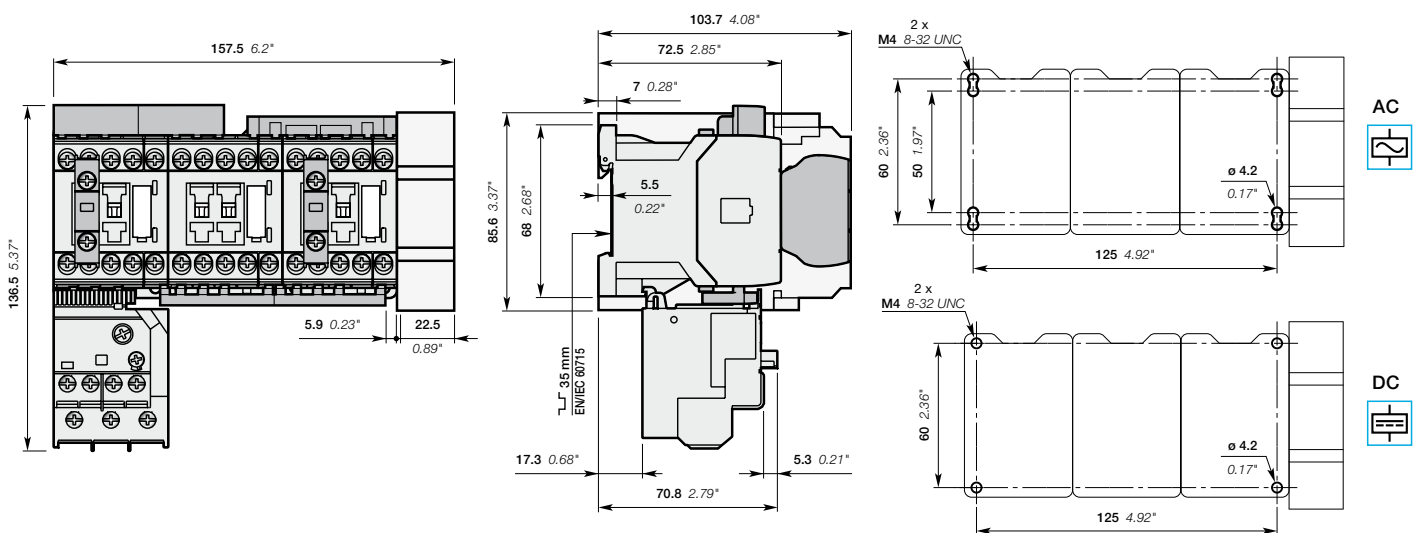

# Notes

A series of horizontal dotted lines for taking notes, spanning the width of the page.

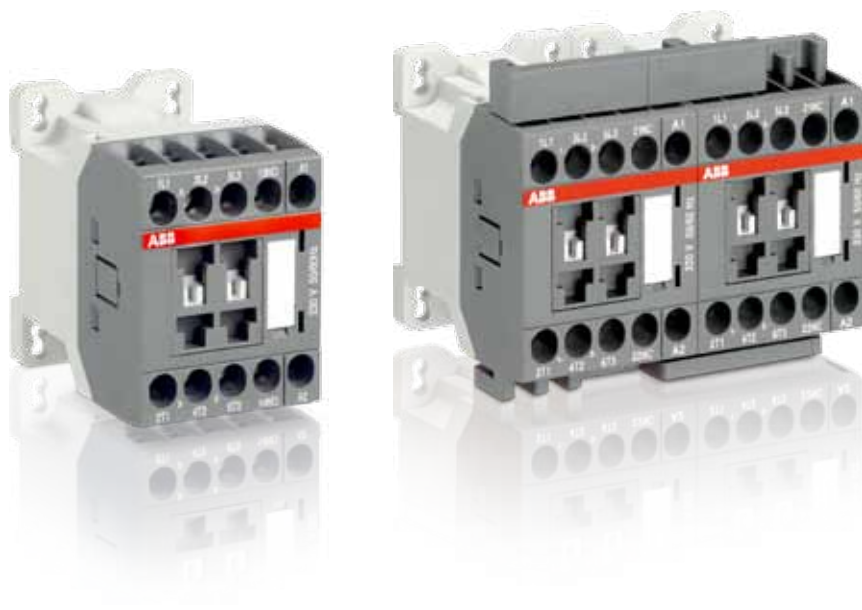



# 3-pole contactors and contactor relays with screw terminals

## 3-pole contactors

Overview	4/30
AS09 ... AS16 AC operated	4/32
ASL09 ... ASL16 DC operated	4/33
AS09 ... AS16 AC operated - 2-stack	4/34
ASL09 ... ASL16 DC operated - 2-stack	4/35
Main accessories	4/36
Technical data	4/38
Terminal marking and positioning	4/50
Dimensions	4/52

## 3-pole reversing contactors

VAS09 ... VAS16 AC operated	4/44
VASL09 ... VASL16 DC operated	4/45
Technical data	4/46
Terminal marking and positioning	4/50
Dimensions	4/56

## Contactor relays

Overview	4/58
NS AC operated	4/60
NSL DC operated	4/61
Main accessories	4/62
Technical data	4/64
Terminal marking and positioning	4/68
Dimensions	4/70

## Accessories

Auxiliary contact blocks	4/72
Electronic timers	4/75
Surge suppressors	4/78
Mechanical interlock unit and other accessories	4/80
Connection accessories for starting solutions	4/81

Voltage code table	4/82
--------------------	------

# 3-pole contactors

## Main accessories

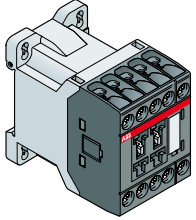

**AS09 ... AS16**  
3-pole contactors

4

## Main accessories for contactors

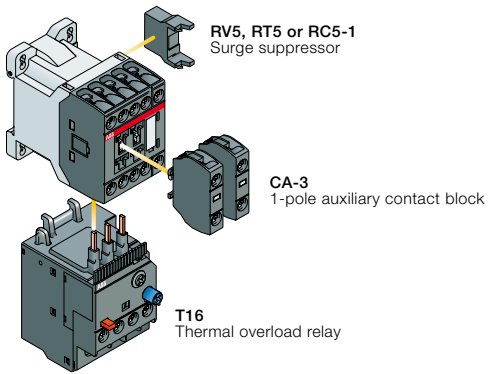

## Main accessories for starting solutions

### Direct-on-line starter

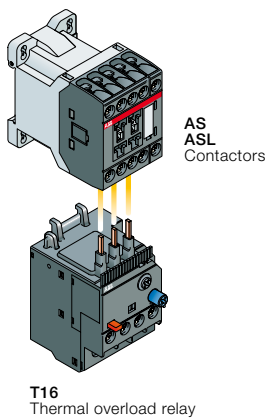

### Reversing starter

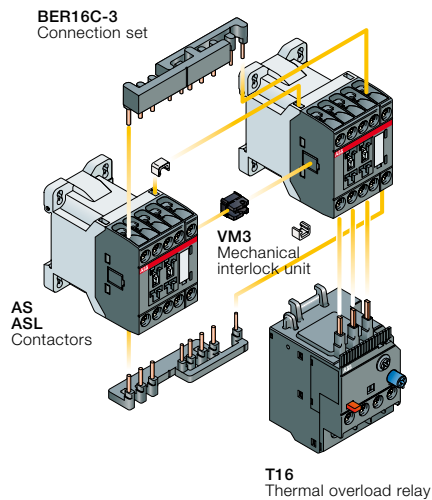

### Star-delta starter

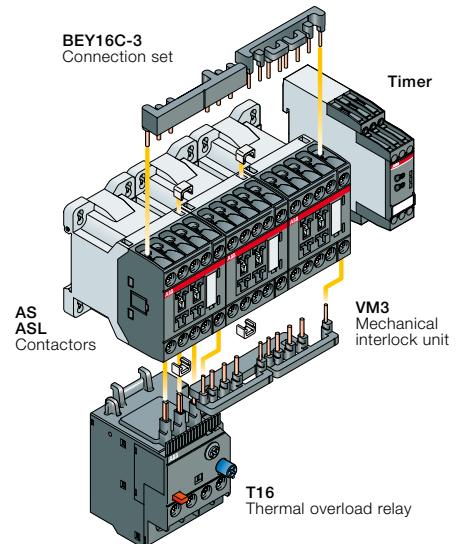

# 3-pole contactors



Screw terminals



	AC control voltage	AS09	AS12	AS16
	DC control voltage	ASL09	ASL12	ASL16

## Switching of 3-phase cage motors

	IEC	AC-3	Rated operational power	400 V	4 kW	5.5 kW	7.5 kW	
			Rated operational current	$\theta \leq 60\text{ }^{\circ}\text{C}$	400 V	9 A	12 A	15.5 A
				$\theta \leq 60\text{ }^{\circ}\text{C}$	415 V	9 A	12 A	15.5 A
			$\theta \leq 60\text{ }^{\circ}\text{C}$	690 V	5 A	7 A	9 A	
UL / CSA	3-phase motor rating		440-480 V	5 hp	7.5 hp	10 hp		
	NEMA size			00	00	0		

## Protection of 3-phase motors

Thermal overload relays



T16...

0.10...0.13	0.23...0.31	0.55...0.74	1.30...1.70	3.10...4.20	7.60...10.0
0.13...0.17	0.31...0.41	0.74...1.00	1.70...2.30	4.20...5.70	10.0...13.0
0.17...0.23	0.41...0.55	1.00...1.30	2.30...3.10	5.70...7.60	13.0...16.0

## Switching of resistive circuits

	IEC	AC-1	Rated operational current	$\theta \leq 40\text{ }^{\circ}\text{C}$	690 V	22 A	24 A	24 A
			$\theta \leq 60\text{ }^{\circ}\text{C}$	690 V	18 A	20 A	20 A	
			$\theta \leq 70\text{ }^{\circ}\text{C}$	690 V	15 A	16 A	16 A	
		With conductor cross-sectional area			2.5 mm <sup>2</sup>	2.5 mm <sup>2</sup>	2.5 mm <sup>2</sup>	
UL / CSA	General use rating		600 V AC	20 A	20 A	20 A		
	With conductor cross-sectional area			AWG 12	AWG 12	AWG 12		

## Main accessories

Auxiliary contact blocks	Front mounting		1-pole CA3-10 or CA3-01
Interlocks	Mechanical		VM3
Surge suppressors	Side-mounted (without additional width)		RV5 (Varistor) AC / DC RC5-1 (Capacitor) AC RT5 (Transil diode) DC
Connection sets	Reversing starters Star-delta starters		BER16C-3 BEY16C-3
Connecting link	With manual motor starter		BEA16-3

# AS09 ... AS16 3-pole contactors

## 4 to 7.5 kW

### AC operated



AS09-30-10

1SBC101007F0014

#### Description

AS09 ... AS16 contactors are mainly used for controlling 3-phase motors and power circuits up to 690 V AC and 220 V DC.

These contactors are of the block type design with:

- 3 main poles and 1 built-in auxiliary contact
- control circuit: AC operated
- add-on auxiliary contact blocks for front mounting and a comprehensive range of accessories.

#### Ordering details

IEC Rated operational power 400 V AC-3 kW	Rated operational current $\theta \leq 40\text{ }^\circ\text{C}$ AC-1 A	UL/CSA 3-phase motor rating 480 V hp	General use rating 600 V AC A	Rated control circuit voltage Uc (1)		Auxiliary contacts fitted 	Type	Order code	Weight Pkg (1 pce) kg				
				V 50 Hz	V 60 Hz								
4	22	5	20	24	24	1 0	AS09-30-10-20	1SBL101001R2010	0.220				
						0 1	AS09-30-01-20	1SBL101001R2001	0.220				
				-	120	1 0	AS09-30-10-16	1SBL101001R1610	0.220				
						0 1	AS09-30-01-16	1SBL101001R1601	0.220				
				230	230	1 0	AS09-30-10-26	1SBL101001R2610	0.220				
						0 1	AS09-30-01-26	1SBL101001R2601	0.220				
				400	400	1 0	AS09-30-10-28	1SBL101001R2810	0.220				
						0 1	AS09-30-01-28	1SBL101001R2801	0.220				
				5.5	24	7.5	20	24	24	1 0	AS12-30-10-20	1SBL111001R2010	0.220
										0 1	AS12-30-01-20	1SBL111001R2001	0.220
-	120	1 0	AS12-30-10-16					1SBL111001R1610	0.220				
		0 1	AS12-30-01-16					1SBL111001R1601	0.220				
230	230	1 0	AS12-30-10-26					1SBL111001R2610	0.220				
		0 1	AS12-30-01-26					1SBL111001R2601	0.220				
400	400	1 0	AS12-30-10-28					1SBL111001R2810	0.220				
		0 1	AS12-30-01-28					1SBL111001R2801	0.220				
7.5	24	10	20					24	24	1 0	AS16-30-10-20	1SBL121001R2010	0.220
										0 1	AS16-30-01-20	1SBL121001R2001	0.220
				-	120	1 0	AS16-30-10-16	1SBL121001R1610	0.220				
						0 1	AS16-30-01-16	1SBL121001R1601	0.220				
				230	230	1 0	AS16-30-10-26	1SBL121001R2610	0.220				
						0 1	AS16-30-01-26	1SBL121001R2601	0.220				
				400	400	1 0	AS16-30-10-28	1SBL121001R2810	0.220				
						0 1	AS16-30-01-28	1SBL121001R2801	0.220				

Note: for multiple packaging, please contact your ABB local sales organization.

(1) Other control voltages see voltage code table.

#### Main dimensions mm, inches

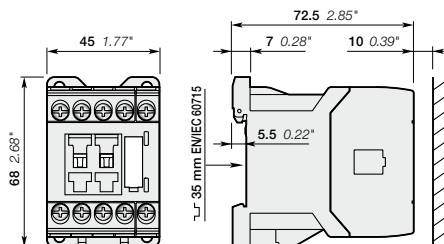

AS09, AS12, AS16

# ASL09 ... ASL16 3-pole contactors

## 4 to 7.5 kW

### DC operated



ASL09-30-10

1SBC101010F0014

#### Description

ASL09 ... ASL16 contactors are mainly used for controlling 3-phase motors and power circuits up to 690 V AC and 220 V DC.

These contactors are of the block type design with:

- 3 main poles and 1 built-in auxiliary contact
- control circuit: low consumption (3 W at pull-in and holding) DC operated with solid core magnet. Suitable for direct control by PLC outputs (the polarity on the coil terminals A1+ and A2- must be respected)
- add-on auxiliary contact blocks for front mounting and a comprehensive range of accessories.

#### Ordering details

IEC		UL/CSA		Rated control circuit voltage Uc (1)	Auxiliary contacts fitted	Type	Order code	Weight
Rated operational power	Rated operational current $\theta \leq 40^\circ\text{C}$	3-phase motor rating 480 V	General use rating 600 V AC					
400 V AC-3 kW	AC-1 A	hp	A	V DC				kg
4	22	5	20	24	1 0	ASL09-30-10-81	1SBL103001R8110	0.280
					0 1	ASL09-30-01-81	1SBL103001R8101	0.280
				48	1 0	ASL09-30-10-83	1SBL103001R8310	0.280
					0 1	ASL09-30-01-83	1SBL103001R8301	0.280
				110	1 0	ASL09-30-10-86	1SBL103001R8610	0.280
					0 1	ASL09-30-01-86	1SBL103001R8601	0.280
220	1 0	ASL09-30-10-88	1SBL103001R8810	0.280				
	0 1	ASL09-30-01-88	1SBL103001R8801	0.280				
5.5	24	7.5	20	24	1 0	ASL12-30-10-81	1SBL113001R8110	0.280
					0 1	ASL12-30-01-81	1SBL113001R8101	0.280
				48	1 0	ASL12-30-10-83	1SBL113001R8310	0.280
					0 1	ASL12-30-01-83	1SBL113001R8301	0.280
				110	1 0	ASL12-30-10-86	1SBL113001R8610	0.280
					0 1	ASL12-30-01-86	1SBL113001R8601	0.280
220	1 0	ASL12-30-10-88	1SBL113001R8810	0.280				
	0 1	ASL12-30-01-88	1SBL113001R8801	0.280				
7.5	24	10	20	24	1 0	ASL16-30-10-81	1SBL123001R8110	0.280
					0 1	ASL16-30-01-81	1SBL123001R8101	0.280
				48	1 0	ASL16-30-10-83	1SBL123001R8310	0.280
					0 1	ASL16-30-01-83	1SBL123001R8301	0.280
				110	1 0	ASL16-30-10-86	1SBL123001R8610	0.280
					0 1	ASL16-30-01-86	1SBL123001R8601	0.280
220	1 0	ASL16-30-10-88	1SBL123001R8810	0.280				
	0 1	ASL16-30-01-88	1SBL123001R8801	0.280				

Note: for multiple packaging, please contact your ABB local sales organization.

(1) Other control voltages see voltage code table.

#### Main dimensions mm, inches

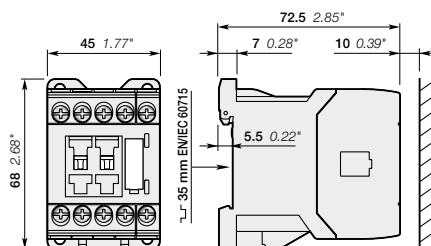

ASL09, ASL12, ASL16

# AS09 ... AS16 2-stack 3-pole contactors

## 4 to 7.5 kW

### AC operated



1SBC101303R0014

AS09-30-32

#### Description

AS09 ... AS16 contactors are mainly used for controlling 3-phase motors and power circuits up to 690 V AC and 220 V DC.

These contactors are of the block type design with:

- 1st stack with 3 main poles and 1 N.O. built-in auxiliary contact
- 2nd stack with permanently fixed 2 N.O. + 2 N.C. auxiliary contact block. The auxiliary contact elements are mechanically linked (side-marked symbol) and the N.C. auxiliary contacts are mirror contacts
- control circuit: AC operated
- a comprehensive range of accessories.

#### Ordering details

IEC Rated operational power 400 V AC-3 kW	UL/CSA 3-phase motor rating 480 V hp	General use rating 600 V AC A	Rated control circuit voltage Uc (1)		Auxiliary contacts fitted	Type	Order code	Weight Pkg (1 pce) kg	
			V 50 Hz	V 60 Hz					
4	22	5	20	24	24	3 2	AS09-30-32-20	1SBL101001R2032	0.260
				-	120		3 2	AS09-30-32-16	1SBL101001R1632
				230	230	3 2	AS09-30-32-26	1SBL101001R2632	0.260
				400	400	3 2	AS09-30-32-28	1SBL101001R2832	0.260
5.5	24	7.5	20	24	24	3 2	AS12-30-32-20	1SBL111001R2032	0.260
				-	120		3 2	AS12-30-32-16	1SBL111001R1632
				230	230	3 2	AS12-30-32-26	1SBL111001R2632	0.260
				400	400	3 2	AS12-30-32-28	1SBL111001R2832	0.260
7.5	24	10	20	24	24	3 2	AS16-30-32-20	1SBL121001R2032	0.260
				-	120		3 2	AS16-30-32-16	1SBL121001R1632
				230	230	3 2	AS16-30-32-26	1SBL121001R2632	0.260
				400	400	3 2	AS16-30-32-28	1SBL121001R2832	0.260

Note: for multiple packaging, please contact your ABB local sales organization.

(1) Other control voltages see voltage code table.

#### Main dimensions mm, inches

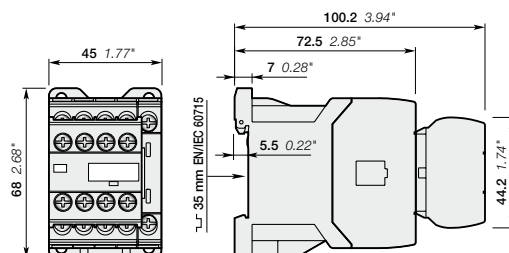

AS09, AS12, AS16

# ASL09 ... ASL16 2-stack 3-pole contactors

## 4 to 7.5 kW

### DC operated



ASL09-30-32

#### Description

ASL09 ... ASL16 contactors are mainly used for controlling 3-phase motors and power circuits up to 690 V AC and 220 V DC.

These contactors are of the block type design with:

- 1st stack with 3 main poles and 1 N.O. built-in auxiliary contact
- 2nd stack with permanently fixed 2 N.O. + 2 N.C. auxiliary contact block. The auxiliary contact elements are mechanically linked (side-marked symbol) and the N.C. auxiliary contacts are mirror contacts
- control circuit: low consumption (3 W at pull-in and holding) DC operated with solid core magnet. Suitable for direct control by PLC outputs (the polarity on the coil terminals A1+ and A2- must be respected)
- a comprehensive range of accessories.

#### Ordering details

IEC		UL/CSA		Rated control circuit voltage U <sub>c</sub> (1)	Auxiliary contacts fitted	Type	Order code	Weight
Rated power	operational current θ ≤ 40 °C	3-phase motor rating 480 V	General use rating 600 V AC					
400 V AC-3 kW	AC-1 A	hp	A	V DC				kg
4	22	5	20	24	3 2	ASL09-30-32-81	1SBL103001R8132	0.320
				48	3 2	ASL09-30-32-83	1SBL103001R8332	0.320
				110	3 2	ASL09-30-32-86	1SBL103001R8632	0.320
				220	3 2	ASL09-30-32-88	1SBL103001R8832	0.320
5.5	24	7.5	20	24	3 2	ASL12-30-32-81	1SBL113001R8132	0.320
				48	3 2	ASL12-30-32-83	1SBL113001R8332	0.320
				110	3 2	ASL12-30-32-86	1SBL113001R8632	0.320
				220	3 2	ASL12-30-32-88	1SBL113001R8832	0.320
7.5	24	10	20	24	3 2	ASL16-30-32-81	1SBL123001R8132	0.320
				48	3 2	ASL16-30-32-83	1SBL123001R8332	0.320
				110	3 2	ASL16-30-32-86	1SBL123001R8632	0.320
				220	3 2	ASL16-30-32-88	1SBL123001R8832	0.320

Note: for multiple packaging, please contact your ABB local sales organization.

(1) Other control voltages see voltage code table.

#### Main dimensions mm, inches

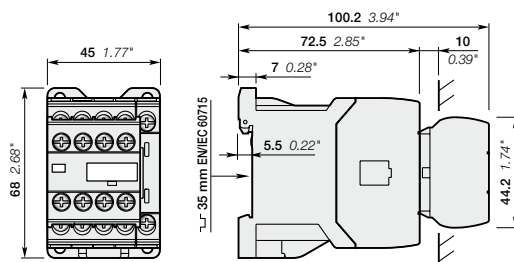

ASL09, ASL12, ASL16

# AS09 ... AS16 and ASL09 ... ASL16 3-pole contactors

## Main accessories

Contactor and main accessories (other accessories available)

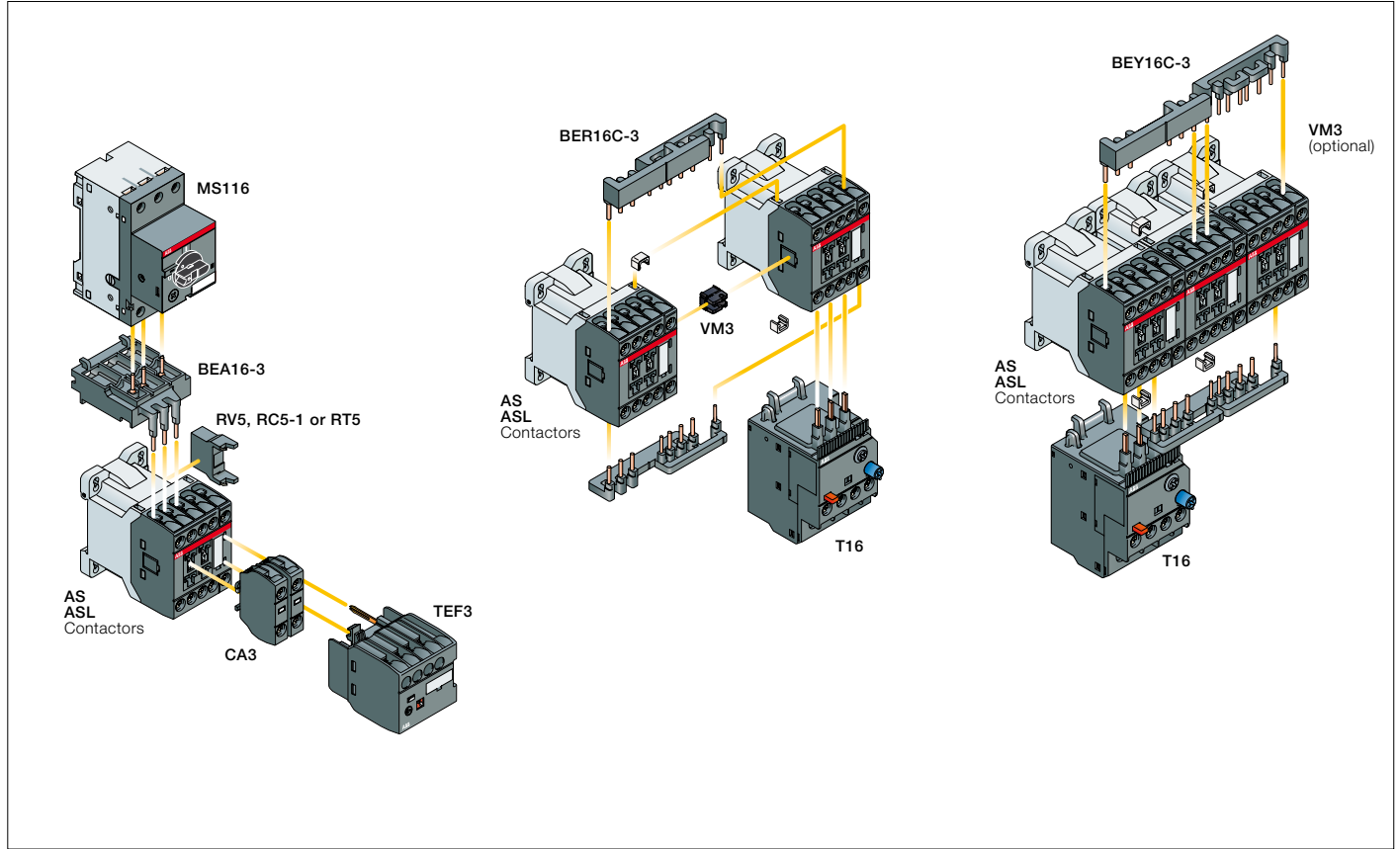

### Main accessory fitting details

Many configurations of accessories are possible depending on whether these are front-mounted or side-mounted.

Contactor types	Main poles	Built-in auxiliary contacts	Front-mounted accessories			Side-mounted accessories	
			Auxiliary contact blocks	Electronic timer	Mechanical interlock unit (between 2 contactors)	Surge suppressors	
AS09 ... AS16	3 0	1 0	2 max.	or 1	+ 1	+ RV5	or RC5-1
	3 0	0 1	-	-	1	+ RV5	or RC5-1
ASL09 ... ASL16	3 0	1 0	2 max.	or 1	+ 1	+ RV5	or RT5
	3 0	0 1	-	-	1	+ RV5	or RT5

### Overload relays fitting details (1)

Contactor types	Thermal overload relays
AS09 ... AS16	T16 (0.10...16 A)
ASL09 ... ASL16	

The addition of an overload relay on the contactor does not prevent fitting of many other accessories as shown above.

(1) Direct mounting - No kit required.



# AS09 ... AS16 and ASL09 ... ASL16 3-pole contactors

## Main accessories



CA3-10

### Front-mounted instantaneous auxiliary contact blocks

For contactors	Auxiliary contacts	Type	Order code	Pkg qty	Weight (1 pce) kg
AS09 ... AS16	1 0	CA3-10	1SBN011010T1010	10	0.011
ASL09 ... ASL16	0 1	CA3-01	1SBN011010T1001	10	0.011



TEF3-ON

### Front-mounted electronic timer

For contactors	Rated control circuit voltage - Uc V	Type	Order code	Pkg qty	Weight (1 pce) kg
<b>ON-delay</b>					
AS09 ... AS16, ASL09 ... ASL16	24...240 V AC/DC	TEF3-ON	1SBN021012R1000	1	0.065
<b>OFF-delay</b>					
AS09 ... AS16, ASL09 ... ASL16	24...240 V AC/DC	TEF3-OFF	1SBN021014R1000	1	0.065



VM3

### Mechanical interlock unit

For contactors	Type	Order code	Pkg qty	Weight (1 pce) kg
AS09 ... AS16, ASL09 ... ASL16	VM3	1SBN031005T1000	10	0.002



RV5

### Surge suppressors

For contactors	Rated control circuit voltage - Uc		Type	Order code	Pkg qty	Weight (1 pce) kg
	V	AC DC				
AS09 ... AS16, ASL09 ... ASL16	24...50	● ●	RV5/50	1SBN050010R1000	2	0.015
	50...133	● ●	RV5/133	1SBN050010R1001	2	0.015
	110...250	● ●	RV5/250	1SBN050010R1002	2	0.015
	250...440	● ●	RV5/440	1SBN050010R1003	2	0.015
AS09 ... AS16	24...50	● -	RC5-1/50	1SBN050100R1000	2	0.012
	50...133	● -	RC5-1/133	1SBN050100R1001	2	0.012
	110...250	● -	RC5-1/250	1SBN050100R1002	2	0.012
	250...440	● -	RC5-1/440	1SBN050100R1003	2	0.012
ASL09 ... ASL16	12...32	- ●	RT5/32	1SBN050020R1000	2	0.015
	25...65	- ●	RT5/65	1SBN050020R1001	2	0.015
	50...90	- ●	RT5/90	1SBN050020R1002	2	0.015
	77...150	- ●	RT5/150	1SBN050020R1003	2	0.015
	150...264	- ●	RT5/264	1SBN050020R1004	2	0.015



BEA16-3

### Connecting links with manual motor starters

For contactors	Manual motor starter	Type	Order code	Pkg qty	Weight (1 pce) kg
AS09 ... AS16	MS116-0.16 ... MS116-16	BEA16-3	1SBN081006T1000	10	0.019
ASL09 ... ASL16	MS132-0.16 ... MS132-16				

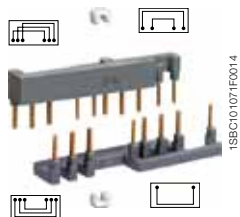

BER16C-3

### Connection sets for reversing contactors

For contactors	Mechanical interlock unit	Type	Order code	Pkg qty	Weight (1 pce) kg
AS09 ... AS16, ASL09 ... ASL16	with or without VM3	BER16C-3	1SBN081012R1000	1	0.035

Note: BER16C-3 connection set includes two BB3 fixing clips, and an electrical interlocking when fitted on contactors with built-in N.C. auxiliary contacts. BER16C-3 can be used with or without VM3 mechanical interlock unit.

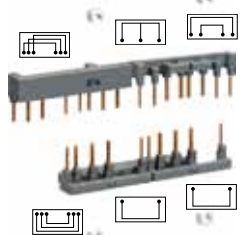

BEY16C-3

### Connection sets for star-delta starting

For contactors	Mech. interlock unit between Star & Delta contactors	Type	Order code	Pkg qty	Weight (1 pce) kg
AS09 ... AS12, ASL09 ... ASL12	with or without VM3	BEY16C-3	1SBN081018R2000	1	0.041

Note: BEY16C-3 connection set includes two BB3 fixing clips, and an electrical interlocking when fitted on Star and Delta contactors with built-in N.C. auxiliary contacts. BEY16C-3 can be used with or without VM3 mechanical interlock unit.

# AS09 ... AS16 and ASL09 ... ASL16 3-pole contactors

## Technical data

### Main pole - Utilization characteristics according to IEC

Contactor types	AC operated	AS09	AS12	AS16
	DC operated	ASL09	ASL12	ASL16
<b>Standards</b>	IEC 60947-1 / 60947-4-1 and EN 60947-1 / 60947-4-1			
<b>Rated operational voltage U<sub>e</sub> max.</b>	690 V			
<b>Rated frequency (without derating)</b>	50 / 60 Hz			
<b>Conventional free-air thermal current I<sub>th</sub></b>				
acc. to IEC 60947-4-1, open contactors, $\theta \leq 40\text{ °C}$		22 A	25 A	25 A
With conductor cross-sectional area		2.5 mm <sup>2</sup>	4 mm <sup>2</sup>	4 mm <sup>2</sup>
<b>AC-1 Utilization category</b>				
For air temperature close to contactor				
<b>I<sub>e</sub> / Rated operational current AC-1</b>	$\theta \leq 40\text{ °C}$	22 A	24 A	24 A
U <sub>e</sub> max. $\leq 690\text{ V}$ , 50/60 Hz	$\theta \leq 60\text{ °C}$	18 A	20 A	20 A
	$\theta \leq 70\text{ °C}$	15 A	16 A	16 A
With conductor cross-sectional area		2.5 mm <sup>2</sup>		
<b>AC-3 Utilization category</b>				
For air temperature close to contactor $\theta \leq 60\text{ °C}$				
<b>I<sub>e</sub> / Max. rated operational current AC-3 (1)</b>				
	220-230-240 V	9 A	12 A	15.7 A
	400 V	9 A	12 A	15.5 A
	415 V	9 A	12 A	15.5 A
	440 V	8 A	11 A	13.6 A
	500 V	8 A	11 A	12.5 A
	690 V	5 A	7 A	9 A
	220-230-240 V	2.2 kW	3 kW	4 kW
	400 V	4 kW	5.5 kW	7.5 kW
	415 V	4 kW	5.5 kW	7.5 kW
	440 V	4 kW	5.5 kW	7.5 kW
	500 V	4 kW	5.5 kW	7.5 kW
	690 V	4 kW	5.5 kW	7.5 kW
<b>Rated making capacity AC-3</b>	10 x I <sub>e</sub> AC-3 acc. to IEC 60947-4-1			
<b>Rated breaking capacity AC-3</b>	8 x I <sub>e</sub> AC-3 acc. to IEC 60947-4-1			
<b>AC-8a Utilization category</b>				
(without thermal overload relay - U <sub>e</sub> 400 V 50/60 Hz - $\theta \leq 40\text{ °C}$ )				
<b>I<sub>e</sub> / Rated operational current AC-8a</b>		12 A	16 A	22 A
<b>Rated operational power AC-8a</b>		5.5 kW	7.5 kW	11 kW
<b>Short-circuit protection device for contactors</b>				
without thermal overload relay - Motor protection excluded (2)				
U <sub>e</sub> $\leq 500\text{ V AC}$ - gG type fuse		25 A		
<b>Rated short-time withstand current I<sub>cw</sub></b>	<b>1 s</b>	230 A	250 A	250 A
at 40 °C ambient temperature,	<b>10 s</b>	100 A	124 A	124 A
in free air from a cold state	<b>30 s</b>	65 A	75 A	75 A
	<b>1 min</b>	50 A	55 A	55 A
	<b>15 min</b>	22 A	24 A	24 A
<b>Maximum breaking capacity</b>				
cos $\phi = 0.45$	<b>at 440 V</b>	155 A		
	<b>at 690 V</b>	90 A		
<b>Power dissipation per pole</b>	<b>I<sub>e</sub> / AC-1</b>	1 W	1.2 W	1.2 W
	<b>I<sub>e</sub> / AC-3</b>	0.16 W	0.3 W	0.5 W
<b>Max. electrical switching frequency</b>	<b>AC-1</b>	600 cycles/h		
	<b>AC-3</b>	1200 cycles/h		
	<b>AC-4</b>	300 cycles/h		

(1) For the corresponding kW/A or hp/A values of 1500 r.p.m., 50 Hz or 1800 r.p.m., 60 Hz, 3-phase motors, see "Motor rated operational powers and currents".

(2) For the protection of motor starters against short circuits, see "Coordination with short-circuit protection devices".

# AS09 ... AS16 and ASL09 ... ASL16 3-pole contactors

## Technical data

### Main pole - Utilization characteristics according to UL / NEMA / CSA

Contactor types	AC operated	AS09	AS12	AS16
	DC operated	ASL09	ASL12	ASL16
Standards	UL 508, CSA C22.2 N°14			
Max. operational voltage	690 V			
NEMA size	00		00	0
NEMA continuous amp rating	Thermal current	9 A	9 A	18 A
NEMA maximum horse power ratings 1-phase, 60 Hz	115 V AC	1/3 hp	1/3 hp	1 hp
	230 V AC	1 hp	1 hp	2 hp
NEMA maximum horse power ratings 3-phase, 60 Hz	200 V AC	1 1/2 hp	1 1/2 hp	3 hp
	230 V AC	1 1/2 hp	1 1/2 hp	3 hp
	460 V AC	2 hp	2 hp	5 hp
	575 V AC	2 hp	2 hp	5 hp
UL / CSA general use rating	600 V AC	20 A	20 A	20 A
	With conductor cross-sectional area	AWG 12	AWG 12	AWG 12
UL / CSA maximum 1-phase motor rating	Full load current	120 V AC	7.2 A	13.8 A
		240 V AC	8 A	12 A
	Horse power rating	120 V AC	1/3 hp	3/4 hp
		240 V AC	1 hp	2 hp
UL / CSA maximum 3-phase motor rating	Full load current (1)	200-208 V AC	7.8 A	11 A
		220-240 V AC	6.8 A	15.2 A
		440-480 V AC	7.6 A	14 A
		550-600 V AC	9 A	11 A
	Horse power rating (1)	200-208 V AC	2 hp	3 hp
		220-240 V AC	2 hp	5 hp
		440-480 V AC	5 hp	10 hp
		550-600 V AC	7-1/2 hp	10 hp
Short-circuit protection device for contactors without thermal overload relay - Motor protection excluded	Fuse rating	40 A	50 A	60 A
	Fuse type, 600 V	J		
	Max. electrical switching frequency	For general use	600 cycles/h	
For motor use		1200 cycles/h		

(1) For the corresponding kW/A or hp/A values of 1500 r.p.m, 50 Hz or 1800 r.p.m, 60 Hz, 3-phase motors, see "Motor rated operational powers and currents".

### General technical data

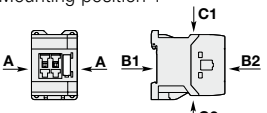
Contactor types	AC operated	AS09	AS12	AS16	
	DC operated	ASL09	ASL12	ASL16	
Rated insulation voltage Ui	acc. to IEC 60947-4-1	690 V			
	acc. to UL / CSA	600 V			
Rated impulse withstand voltage Uimp.	6 kV				
Ambient air temperature close to contactor	Operation	Fitted with thermal overload relay	-25...+60 °C		
		Without thermal overload relay	-40...+70 °C		
	Storage	-60...+80 °C			
Climatic withstand	Category B according to IEC 60947-1 Annex Q				
Maximum operating altitude (without derating)	3000 m				
Mechanical durability	Number of operating cycles	10 millions operating cycles			
	Max. switching frequency	3600 cycles/h			
Shock withstand acc. to IEC 60068-2-27 and EN 60068-2-27	Shock direction	AS contactors - AC operated	ASL contactors - DC operated		
	Mounting position 1	A	20 g		
	B1	10 g closed position / 5 g open position	20 g closed position / 10 g open position		
	B2	15 g	15 g closed position / 5 g open position		
	C1	20 g closed position / 9 g open position	10 g		
	C2	20 g closed position / 14 g open position	15 g closed position / 8 g open position		
				14 g closed position / 8 g open position	
				14 g closed position / 8 g open position	
Vibration withstand acc. to IEC 60068-2-6		5...300 Hz / 3 g closed position / 2 g open position			

# AS09 ... AS16 and ASL09 ... ASL16 3-pole contactors

## Technical data

### Magnet system characteristics for AS09 ... AS16 contactors

Contactor types	AC operated	AS09	AS12	AS16
<b>Coil operating limits</b>	AC supply	0.85...1.1 x U <sub>c</sub> (at $\theta \leq 60$ °C); U <sub>c</sub> (at $\theta \leq 70$ °C)		
acc. to IEC 60947-4-1	Rated control circuit voltage U <sub>c</sub>	at 50 Hz	24...415 V	
		at 60 Hz	24...415 V	
<b>AC control voltage</b>	Coil consumption	Average pull-in value	50 Hz	33 VA
			60 Hz	33 VA
			50/60 Hz	33 VA
		Average holding value	50 Hz	6.5 VA / 1.5 W
			60 Hz	5 VA / 1.2 W
			50/60 Hz	6.5 VA / 1.5 W
<b>Drop-out voltage</b>		Approx. 30...50 % of U <sub>c</sub>		
<b>Operating time</b>				
Between coil energization and:	N.O. contact closing	9...24 ms		
	N.C. contact opening	6...18 ms		
Between coil de-energization and:	N.O. contact opening (1)	5...19 ms		
	N.C. contact closing (1)	7...22 ms		
(1) The use of RC5-1 surge suppressor increases opening time by a factor of 2 to 3				

### Magnet system characteristics for ASL09 ... ASL16 contactors

Contactor types	DC operated	ASL09	ASL12	ASL16
<b>Coil operating limits</b>	DC supply	0.85...1.1 x U <sub>c</sub> (at $\theta \leq 60$ °C); U <sub>c</sub> (at $\theta \leq 70$ °C)		
acc. to IEC 60947-4-1	Rated control circuit voltage U <sub>c</sub>	12...240 V DC		
<b>DC control voltage</b>	Coil consumption	Average pull-in value	3 W	
		Average holding value	3 W	
<b>Drop-out voltage</b>		Approx. 10...40 % of U <sub>c</sub>		
<b>Coil time constant</b>	Open	L/R	12 ms	
	Closed	L/R	40 ms	
<b>Operating time</b>				
Between coil energization and:	N.O. contact closing	36...59 ms		
	N.C. contact opening	31...53 ms		
Between coil de-energization and:	N.O. contact opening (1)	13...17 ms		
	N.C. contact closing (1)	15...20 ms		
(1) The use of RT5 surge suppressor increases opening time by a factor of 1.1 to 1.2				















### Mounting characteristics and conditions for use

Contactor types	AC operated	AS09	AS12	AS16
	DC operated	ASL09	ASL12	ASL16
<b>Mounting positions</b>				
<b>Mounting distances</b>	The contactors can be assembled side by side.			
<b>Fixing</b>	On rail according to IEC 60715, EN 60715	35 x 7.5 mm or 35 x 15 mm		
	By screws (not supplied)	2 x M4 screws placed diagonally		

# AS09 ... AS16 and ASL09 ... ASL16 3-pole contactors

## Technical data

### Connecting characteristics

Contactor types	AC operated	AS09	AS12	AS16
	DC operated	ASL09	ASL12	ASL16
<b>Main terminals</b>	 Screw terminals with cable clamp			
<b>Connection capacity (min. ... max.)</b>				
<b>Main conductors (poles)</b>				
	Rigid solid	1 x	0.75...4 mm <sup>2</sup>	
		2 x	0.75...4 mm <sup>2</sup>	
	Flexible with non insulated ferrule	1 x	0.75...2.5 mm <sup>2</sup>	
		2 x	0.75...2.5 mm <sup>2</sup>	
	Flexible with insulated ferrule	1 x	0.75...2.5 mm <sup>2</sup>	
		2 x	0.75...1.5 mm <sup>2</sup>	
	Bars or lugs	L ≤	7.7 mm	
		l >	3.2 mm	
Connection capacity acc. to UL / CSA		1 or 2 x	AWG 18...12	
Stripping length			9 mm	
Tightening torque		Recommended	1.00 Nm / 9 lb.in	
		Max.	1.20 Nm	
<b>Auxiliary conductors</b>				
(built-in auxiliary terminals + coil terminals)				
	Rigid solid	1 x	0.75...2.5 mm <sup>2</sup>	
		2 x	0.75...2.5 mm <sup>2</sup>	
	Flexible with non insulated ferrule	1 x	0.75...2.5 mm <sup>2</sup>	
		2 x	0.75...2.5 mm <sup>2</sup>	
	Flexible with insulated ferrule	1 x	0.75...2.5 mm <sup>2</sup>	
		2 x	0.75...1.5 mm <sup>2</sup>	
	Lugs	L ≤	7.7 mm	
		l >	3.2 mm	
Connection capacity acc. to UL / CSA		1 or 2 x	AWG 18...14	
Stripping length				
Tightening torque				
Coil terminals		Recommended	1.00 Nm / 9 lb.in	
		Max.	1.20 Nm	
Built-in auxiliary terminals		Recommended	1.00 Nm / 9 lb.in	
		Max.	1.20 Nm	
<b>Degree of protection</b>				
acc. to IEC 60947-1 / EN 60947-1 and IEC 60529 / EN 60529				
All terminals			IP20	
<b>Screw terminals</b>				
All terminals			Delivered in open position, screws of unused terminals must be tightened	
			M3	
		Screwdriver type	Flat Ø 5.5 / Pozidriv 2	

# AS09 ... AS16 and ASL09 ... ASL16 3-pole contactors

## Technical data

### Built-in auxiliary contacts according to IEC

Contactor types	AC operated	AS09	AS12	AS16
	DC operated	ASL09	ASL12	ASL16
Rated operational voltage U <sub>e</sub> max.		690 V		
Rated frequency (without derating)		50 / 60 Hz		
Conventional free-air thermal current I <sub>th</sub> - θ ≤ 40 °C		10 A		
I <sub>e</sub> / Rated operational current AC-15		6 A		
acc. to IEC 60947-5-1	24-127 V 50/60 Hz	4 A		
	220-240 V 50/60 Hz	3 A		
	400-440 V 50/60 Hz	2 A		
	500 V 50/60 Hz	2 A		
	690 V 50/60 Hz	2 A		
Making capacity AC-15		10 x I <sub>e</sub> AC-15 acc. to IEC 60947-5-1		
Breaking capacity AC-15		10 x I <sub>e</sub> AC-15 acc. to IEC 60947-5-1		
I <sub>e</sub> / Rated operational current DC-13		6 A / 144 W		
acc. to IEC 60947-5-1	24 V DC	2.8 A / 134 W		
	48 V DC	1 A / 72 W		
	72 V DC	0.55 A / 60 W		
	110 V DC	0.55 A / 69 W		
	125 V DC	0.27 A / 60 W		
	220 V DC	0.27 A / 68 W		
	250 V DC	10 A		
Short-circuit protection device gG type fuse		100 A		
Rated short-time withstand current I <sub>cw</sub>	for 1.0 s	140 A		
	for 0.1 s	12 V / 3 mA		
Minimum switching capacity		10 <sup>-7</sup>		
with failure rate acc. to IEC 60947-5-4		1.5 ms		
Non-overlapping time between N.O. and N.C. contacts		0.1 W		
Power dissipation per pole at 6 A		AC-15 1200 cycles/h		
Max. electrical switching frequency	AC-15	DC-13 900 cycles/h		
Mechanically linked contacts		Built-in N.O. or N.C. auxiliary contacts and additional N.O. or N.C. auxiliary contacts (CA3 aux. contact blocks) are mechanically linked contacts.		
acc. to annex L of IEC 60947-5-1		Built-in N.C. auxiliary contacts or additional N.C. auxiliary contacts (CA3 aux. contact blocks) are mirror contacts.		
Mirror contacts		acc. to annex F of IEC 60947-4-1		

### Built-in auxiliary contacts according to UL / CSA

Contactor types	AC operated	AS09	AS12	AS16
	DC operated	ASL09	ASL12	ASL16
Max. operational voltage		600 V AC, 250 V DC		
Pilot duty		A600, Q300		
AC thermal rated current		10 A		
AC maximum volt-ampere making		7200 VA		
AC maximum volt-ampere breaking		720 VA		
DC thermal rated current		2.5 A		
DC maximum volt-ampere making-breaking		69 VA		

# Notes

A series of horizontal dotted lines for writing notes, spanning most of the page width.

# VAS09 ... VAS16 3-pole reversing contactors

## 4 to 7.5 kW

### AC operated



VAS09EM

#### Description

VAS09 ... VAS16 reversing contactors are used for controlling 3-phase motors up to 690 V AC. These reversing contactors include 2 AS09 ... AS16 contactors fitted with 1 N.C. auxiliary contact, 1 VM3 mechanical interlock and BER16C-3 reversing connection set including electrical interlocking.

Up to 2 add-on CA3 1-pole auxiliary contact blocks can be mounted per contactor.

The reversing contactors are available with or without surge suppressor mounted on each contactor.

#### Ordering details

IEC	UL/CSA	Rated control circuit voltage U <sub>c</sub> (1)		Auxiliary contacts fitted	Type	Order code	Pkg qty	Weight (1 pce)
Rated operational power	3-phase motor rating	V 50 Hz	V 60 Hz					kg
400 V AC-3 kW	480 V hp							

#### Reversing contactors without integrated surge suppressor

4	5	24	24	0	2	VAS09EM-20M	1SBK103600M2000	18	0.480
		-	120	0	2	VAS09EM-16M	1SBK103600M1600	18	0.480
		230	230	0	2	VAS09EM-26M	1SBK103600M2600	18	0.480
		400	400	0	2	VAS09EM-28M	1SBK103600M2800	18	0.480
5.5	7.5	24	24	0	2	VAS12EM-20M	1SBK113600M2000	18	0.480
		-	120	0	2	VAS12EM-16M	1SBK113600M1600	18	0.480
		230	230	0	2	VAS12EM-26M	1SBK113600M2600	18	0.480
		400	400	0	2	VAS12EM-28M	1SBK113600M2800	18	0.480
7.5	10	24	24	0	2	VAS16EM-20M	1SBK123600M2000	18	0.480
		-	120	0	2	VAS16EM-16M	1SBK123600M1600	18	0.480
		230	230	0	2	VAS16EM-26M	1SBK123600M2600	18	0.480
		400	400	0	2	VAS16EM-28M	1SBK123600M2800	18	0.480

#### Reversing contactors with RC5-1 integrated surge suppressor

4	5	24	24	0	2	VAS09SEM-20M	1SBK103800M2000	18	0.510
		-	120	0	2	VAS09SEM-16M	1SBK103800M1600	18	0.510
		230	230	0	2	VAS09SEM-26M	1SBK103800M2600	18	0.510
		400	400	0	2	VAS09SEM-28M	1SBK103800M2800	18	0.510
5.5	7.5	24	24	0	2	VAS12SEM-20M	1SBK113800M2000	18	0.510
		-	120	0	2	VAS12SEM-16M	1SBK113800M1600	18	0.510
		230	230	0	2	VAS12SEM-26M	1SBK113800M2600	18	0.510
		400	400	0	2	VAS12SEM-28M	1SBK113800M2800	18	0.510
7.5	10	24	24	0	2	VAS16SEM-20M	1SBK123800M2000	18	0.510
		-	120	0	2	VAS16SEM-16M	1SBK123800M1600	18	0.510
		230	230	0	2	VAS16SEM-26M	1SBK123800M2600	18	0.510
		400	400	0	2	VAS16SEM-28M	1SBK123800M2800	18	0.510

(1) Other control voltages see voltage code table.

Note: Minimum switchover delay of 50 ms must be introduced between respective opening and closing of AC operated reversing contactors.

#### Main dimensions mm, inches

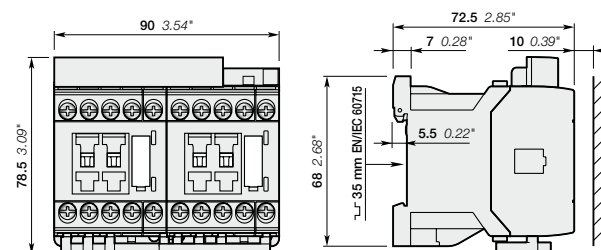

VAS09, VAS12, VAS16



# VASL09 ... VASL16 3-pole reversing contactors

## 4 to 7.5 kW

### DC operated



VASL09EM

#### Description

VASL09 ... VASL16 reversing contactors are used for controlling 3-phase motors up to 690 V AC. These reversing contactors include 2 ASL09 ... ASL16 contactors fitted with 1 N.C. auxiliary contact, 1 VM3 mechanical interlock and BER16C-3 reversing connection set including electrical interlocking.

Up to 2 add-on CA3 1-pole auxiliary contact blocks can be mounted per contactor.

The reversing contactors are available with or without surge suppressor mounted on each contactor.

#### Ordering details

IEC Rated operational power	UL/CSA 3-phase motor rating 480 V	Rated control circuit voltage Uc (1)	Auxiliary contacts fitted	Type	Order code	Pkg qty	Weight (1 pce)
400 V AC-3 kW	hp	V DC					kg

#### Reversing contactors without integrated surge suppressor

4	5	24	0 2	VASL09EM-81M	1SBK103700M8100	18	0.600
		48	0 2	VASL09EM-83M	1SBK103700M8300	18	0.600
		110	0 2	VASL09EM-86M	1SBK103700M8600	18	0.600
		220	0 2	VASL09EM-88M	1SBK103700M8800	18	0.600
5.5	7.5	24	0 2	VASL12EM-81M	1SBK113700M8100	18	0.600
		48	0 2	VASL12EM-83M	1SBK113700M8300	18	0.600
		110	0 2	VASL12EM-86M	1SBK113700M8600	18	0.600
		220	0 2	VASL12EM-88M	1SBK113700M8800	18	0.600
7.5	10	24	0 2	VASL16EM-81M	1SBK123700M8100	18	0.600
		48	0 2	VASL16EM-83M	1SBK123700M8300	18	0.600
		110	0 2	VASL16EM-86M	1SBK123700M8600	18	0.600
		220	0 2	VASL16EM-88M	1SBK123700M8800	18	0.600

#### Reversing contactors with RV5 integrated surge suppressor

4	5	24	0 2	VASL09SEM-81M	1SBK103900M8100	18	0.630
		48	0 2	VASL09SEM-83M	1SBK103900M8300	18	0.630
		110	0 2	VASL09SEM-86M	1SBK103900M8600	18	0.630
		220	0 2	VASL09SEM-88M	1SBK103900M8800	18	0.630
5.5	7.5	24	0 2	VASL12SEM-81M	1SBK113900M8100	18	0.630
		48	0 2	VASL12SEM-83M	1SBK113900M8300	18	0.630
		110	0 2	VASL12SEM-86M	1SBK113900M8600	18	0.630
		220	0 2	VASL12SEM-88M	1SBK113900M8800	18	0.630
7.5	10	24	0 2	VASL16SEM-81M	1SBK123900M8100	18	0.630
		48	0 2	VASL16SEM-83M	1SBK123900M8300	18	0.630
		110	0 2	VASL16SEM-86M	1SBK123900M8600	18	0.630
		220	0 2	VASL16SEM-88M	1SBK123900M8800	18	0.630

(1) Other control voltages see voltage code table.

#### Main dimensions mm, inches

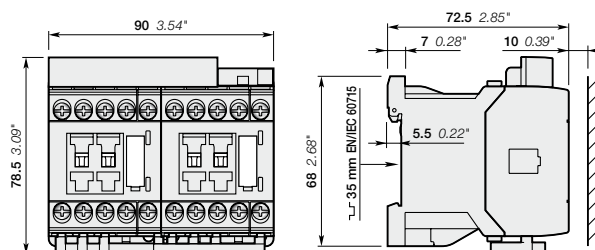

VASL09, VASL12, VASL16

# VAS09 ... VAS16 and VASL09 ... VASL16 3-pole reversing contactors

## Technical data

### Main pole - Utilization characteristics according to IEC

Contractor types	AC operated	VAS09	VAS12	VAS16
	DC operated	VASL09	VASL12	VASL16
<b>Standards</b>	IEC 60947-1 / 60947-4-1 and EN 60947-1 / 60947-4-1			
<b>Rated operational voltage U<sub>e</sub> max.</b>	690 V			
<b>Rated frequency (without derating)</b>	50 / 60 Hz			
<b>Conventional free-air thermal current I<sub>th</sub></b>				
acc. to IEC 60947-4-1, open contactors, $\theta \leq 40$ °C		22 A	25 A	25 A
With conductor cross-sectional area		2.5 mm <sup>2</sup>	4 mm <sup>2</sup>	4 mm <sup>2</sup>
<b>AC-3 Utilization category</b>				
For air temperature close to contactor $\theta \leq 60$ °C				
<b>I<sub>e</sub> / Max. rated operational current AC-3 (1)</b>				
	<b>220-230-240 V</b>	9 A	12 A	15.7 A
	<b>400 V</b>	9 A	12 A	15.5 A
	<b>415 V</b>	9 A	12 A	15.5 A
	<b>440 V</b>	8 A	11 A	13.6 A
	<b>500 V</b>	8 A	11 A	12.5 A
	<b>690 V</b>	5 A	7 A	9 A
<b>Rated operational power AC-3 (1)</b>				
	<b>220-230-240 V</b>	2.2 kW	3 kW	4 kW
	<b>400 V</b>	4 kW	5.5 kW	7.5 kW
	<b>415 V</b>	4 kW	5.5 kW	7.5 kW
	<b>440 V</b>	4 kW	5.5 kW	7.5 kW
	<b>500 V</b>	4 kW	5.5 kW	7.5 kW
	<b>690 V</b>	4 kW	5.5 kW	7.5 kW
<b>Rated making capacity AC-3</b>	10 x I <sub>e</sub> AC-3 acc. to IEC 60947-4-1			
<b>Rated breaking capacity AC-3</b>	8 x I <sub>e</sub> AC-3 acc. to IEC 60947-4-1			
<b>Short-circuit protection device for contactors</b>				
without thermal overload relay - Motor protection excluded (2)				
U <sub>e</sub> ≤ 500 V AC - gG type fuse		25 A		
<b>Rated short-time withstand current I<sub>cw</sub></b>				
at 40 °C ambient temperature,	<b>1 s</b>	230 A	250 A	250 A
in free air from a cold state	<b>10 s</b>	100 A	124 A	124 A
	<b>30 s</b>	65 A	75 A	75 A
	<b>1 min</b>	50 A	55 A	55 A
	<b>15 min</b>	22 A	24 A	24 A
<b>Maximum breaking capacity</b>				
cos $\phi$ = 0.45	<b>at 440 V</b>	155 A		
	<b>at 690 V</b>	90 A		
<b>Power dissipation per pole</b>				
	<b>I<sub>e</sub> / AC-3</b>	0.16 W	0.3 W	0.5 W
<b>Max. electrical switching frequency</b>	<b>AC-3</b>	600 cycles/h		

4



3-phase motors



1500 r.p.m. 50 Hz  
1800 r.p.m. 60 Hz  
3-phase motors

(1) For the corresponding kW/A or hp/A values of 1500 r.p.m, 50 Hz or 1800 r.p.m, 60 Hz, 3-phase motors, see "Motor rated operational powers and currents".

(2) For the protection of motor starters against short circuits, see "Coordination with short-circuit protection devices".

# VAS09 ... VAS16 and VASL09 ... VASL16 3-pole reversing contactors

## Technical data

### Main pole - Utilization characteristics according to UL / NEMA / CSA

Contactor types	AC operated	VAS09	VAS12	VAS16
	DC operated	VASL09	VASL12	VASL16
Standards	UL 508, CSA C22.2 N°14			
Max. operational voltage	690 V			
NEMA size	00		00	0
NEMA continuous amp rating	Thermal current	9 A	9 A	18 A
NEMA maximum horse power ratings 1-phase, 60 Hz	115 V AC	1/3 hp	1/3 hp	1 hp
	230 V AC	1 hp	1 hp	2 hp
NEMA maximum horse power ratings 3-phase, 60 Hz	200 V AC	1 1/2 hp	1 1/2 hp	3 hp
	230 V AC	1 1/2 hp	1 1/2 hp	3 hp
	460 V AC	2 hp	2 hp	5 hp
	575 V AC	2 hp	2 hp	5 hp
UL / CSA maximum 1-phase motor rating	Full load current			
	120 V AC	7.2 A	9.8 A	13.8 A
	240 V AC	8 A	10 A	12 A
	Horse power rating			
	120 V AC	1/3 hp	1/2 hp	3/4 hp
	240 V AC	1 hp	1-1/2 hp	2 hp
UL / CSA maximum 3-phase motor rating	Full load current (1)			
	200-208 V AC	7.8 A	7.8 A	11 A
	220-240 V AC	6.8 A	9.6 A	15.2 A
	440-480 V AC	7.6 A	11 A	14 A
	550-600 V AC	9 A	11 A	11 A
	Horse power rating (1)			
	200-208 V AC	2 hp	2 hp	3 hp
	220-240 V AC	2 hp	3 hp	5 hp
	440-480 V AC	5 hp	7-1/2 hp	10 hp
	550-600 V AC	7-1/2 hp	10 hp	10 hp
Short-circuit protection device for contactors				
without thermal overload relay - Motor protection excluded				
Fuse rating		40 A	50 A	60 A
Fuse type, 600 V		J		
Max. electrical switching frequency				
For motor use		600 cycles/h		

(1) For the corresponding kW/A or hp/A values of 1500 r.p.m, 50 Hz or 1800 r.p.m, 60 Hz, 3-phase motors, see "Motor rated operational powers and currents".

### General technical data

Contactor types	AC operated	VAS09	VAS12	VAS16
	DC operated	VASL09	VASL12	VASL16
Rated insulation voltage Ui				
acc. to IEC 60947-4-1		690 V		
acc. to UL / CSA		600 V		
Rated impulse withstand voltage Uimp.				
6 kV				
Ambient air temperature close to contactor				
Operation	Fitted with thermal overload relay	-25...+60 °C		
	Without thermal overload relay	-40...+70 °C		
Storage		-60...+80 °C		
Climatic withstand				
Category B according to IEC 60947-1 Annex Q				
Maximum operating altitude (without derating)				
3000 m				
Mechanical durability				
Number of operating cycles		5 millions operating cycles		
Max. switching frequency		1800 cycles/h		

# VAS09 ... VAS16 and VASL09 ... VASL16 3-pole reversing contactors

## Technical data

### Magnet system characteristics for VAS09 ... VAS16 contactors

Contactor types	AC operated	VAS09	VAS12	VAS16
<b>Coil operating limits</b>	AC supply	0.85...1.1 x U <sub>c</sub> (at $\theta \leq 60$ °C); U <sub>c</sub> (at $\theta \leq 70$ °C)		
acc. to IEC 60947-4-1				
<b>AC control voltage</b>	Rated control circuit voltage U <sub>c</sub>	at 50 Hz	24...415 V	
		at 60 Hz	24...415 V	
Coil consumption	Average pull-in value	50 Hz	33 VA	
		60 Hz	33 VA	
		50/60 Hz	33 VA	
	Average holding value	50 Hz	6.5 VA / 1.5 W	
		60 Hz	5 VA / 1.2 W	
		50/60 Hz	6.5 VA / 1.5 W	
<b>Drop-out voltage</b>		Approx. 30...50 % of U <sub>c</sub>		
<b>Operating time</b>				
Between coil energization and:	N.O. contact closing	9...24 ms		
	N.C. contact opening	6...18 ms		
Between coil de-energization and:	N.O. contact opening (1)	5...19 ms		
	N.C. contact closing (1)	7...22 ms		
		(1) The use of RC5-1 surge suppressor increases opening time by a factor of 2 to 3.		

### Magnet system characteristics for VASL09 ... VASL16 contactors

Contactor types	DC operated	VASL09	VASL12	VASL16
<b>Coil operating limits</b>	DC supply	0.85...1.1 x U <sub>c</sub> (at $\theta \leq 60$ °C); U <sub>c</sub> (at $\theta \leq 70$ °C)		
acc. to IEC 60947-4-1				
<b>DC control voltage</b>	Rated control circuit voltage U <sub>c</sub>	12...240 V DC		
	Coil consumption	Average pull-in value	3 W	
		Average holding value	3 W	
<b>Drop-out voltage</b>		Approx. 10...40 % of U <sub>c</sub>		
<b>Coil time constant</b>	Open	L/R	12 ms	
	Closed	L/R	40 ms	
<b>Operating time</b>				
Between coil energization and:	N.O. contact closing	36...59 ms		
	N.C. contact opening	31...53 ms		
Between coil de-energization and:	N.O. contact opening (1)	13...17 ms		
	N.C. contact closing (1)	15...20 ms		
		(1) The use of RT5 surge suppressor increases opening time by a factor of 1.1 to 1.2		







### Mounting characteristics and conditions for use

Contactor types	AC operated	VAS09	VAS12	VAS16
	DC operated	VASL09	VASL12	VASL16
<b>Mounting positions</b>				
<b>Mounting distances</b>	The reversing contactors can be assembled side by side.			
<b>Fixing</b>	On rail according to IEC 60715, EN 60715	35 x 7.5 mm or 35 x 15 mm		
	By screws (not supplied)	2 x M4 screws placed diagonally		

# VAS09 ... VAS16 and VASL09 ... VASL16 3-pole reversing contactors

## Technical data

### Connecting characteristics

Contactor types	AC operated	VAS09	VAS12	VAS16
	DC operated	VASL09	VASL12	VASL16
Main terminals	 <p>Screw terminals with cable clamp</p>			
<b>Connection capacity (min. ... max.)</b>				
<b>Main conductors (poles)</b>				
	Rigid solid	1 x	0.75...4 mm <sup>2</sup>	
	Flexible with non insulated ferrule	1 x	0.75...2.5 mm <sup>2</sup>	
	Flexible with insulated ferrule	1 x	0.75...1.5 mm <sup>2</sup>	
	Connection capacity acc. to UL / CSA	1 x	AWG 18...12	
	Stripping length		9 mm	
	Tightening torque		Recommended	
			1.00 Nm / 9 lb.in	
			Max.	
			1.20 Nm	
<b>Auxiliary conductors</b>				
(built-in auxiliary terminals + coil terminals)				
	Rigid solid	1 x	0.75...2.5 mm <sup>2</sup>	
	Flexible with non insulated ferrule	1 x	0.75...2.5 mm <sup>2</sup>	
	Flexible with insulated ferrule	1 x	0.75...1.5 mm <sup>2</sup>	
	Connection capacity acc. to UL / CSA	1 x	AWG 18...14	
	Stripping length		9 mm	
	Tightening torque		Recommended	
	Coil terminals		1.00 Nm / 9 lb.in	
			Max.	
			1.20 Nm	
	Built-in auxiliary terminals		Recommended	
			1.00 Nm / 9 lb.in	
			Max.	
			1.20 Nm	
<b>Degree of protection</b>				
acc. to IEC 60947-1 / EN 60947-1 and IEC 60529 / EN 60529				
	All terminals		IP20	
<b>Screw terminals</b>				
	All terminals		Delivered in open position, screws of unused terminals must be tightened	
			M3	
	Screwdriver type		Flat Ø 5.5 / Pozidriv 2	

# AS09 ... AS16 3-pole contactors

## Terminal marking and positioning

### AS contactors - AC operated

Standard devices without addition of auxiliary contacts

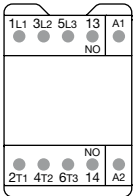

AS09 ... AS16-30-10

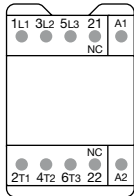

AS09 ... AS16-30-01



AS09 ... AS16-30-10

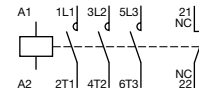

AS09 ... AS16-30-01

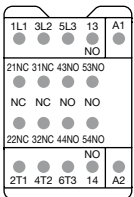

AS09 ... AS16-30-32

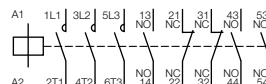

AS09 ... AS16-30-32

4

Other possible contact combinations with auxiliary contact blocks added by the user

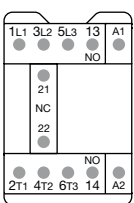

Combination 11

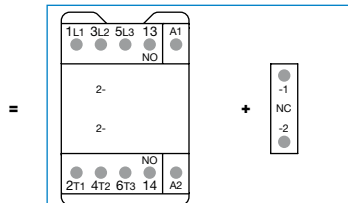

AS09 ... AS16-30-10 + CA3-01

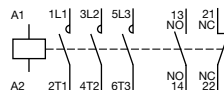

Combination 11

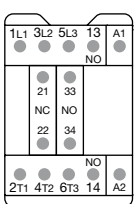

Combination 21

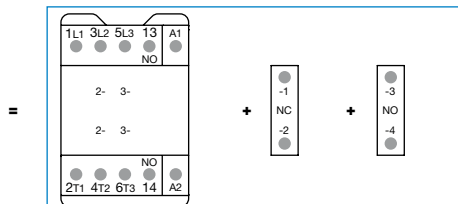

AS09 ... AS16-30-10 + CA3-01 + CA3-10

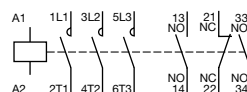

Combination 21

CA3 1-pole auxiliary contact blocks

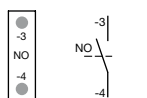

CA3-10

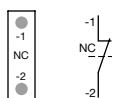

CA3-01

TEF3 front-mounted electronic timer

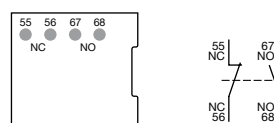

TEF3

# ASL09 ... ASL16 3-pole contactors

## Terminal marking and positioning

### ASL contactors - DC operated (the polarity A1+, A2- must be respected)

Standard devices without addition of auxiliary contacts

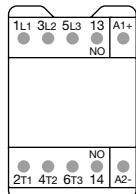

ASL09 ... ASL16-30-10

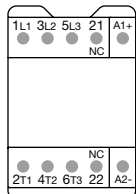

ASL09 ... ASL16-30-01

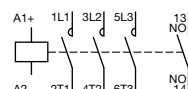

ASL09 ... ASL16-30-10

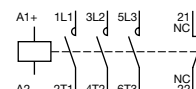

ASL09 ... ASL16-30-01

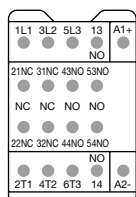

ASL09 ... ASL16-30-32

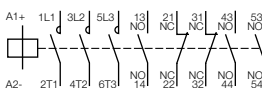

ASL09 ... ASL16-30-32

Other possible contact combinations with auxiliary contact blocks added by the user

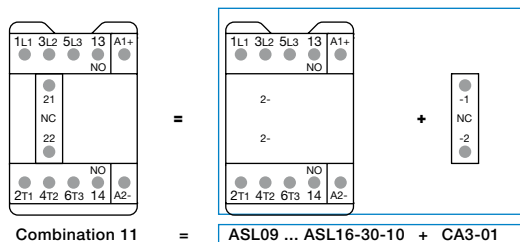

Combination 11

ASL09 ... ASL16-30-10 + CA3-01

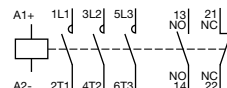

Combination 11

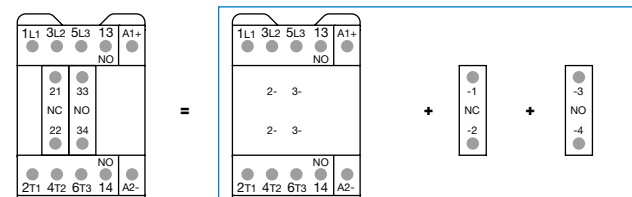

Combination 21

ASL09 ... ASL16-30-10 + CA3-01 + CA3-10

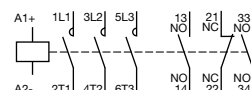

Combination 21

CA3 1-pole auxiliary contact blocks

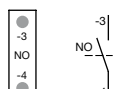

CA3-10



CA3-01

TEF3 front-mounted electronic timer

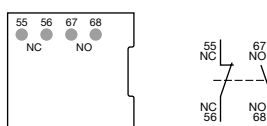

TEF3

# AS09 ... AS16 3-pole contactors

## Main dimensions mm, inches

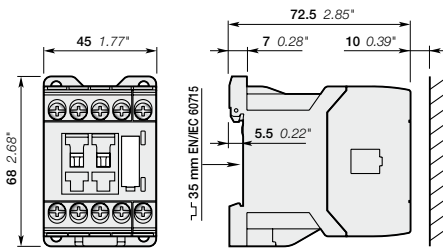

AS09, AS12, AS16

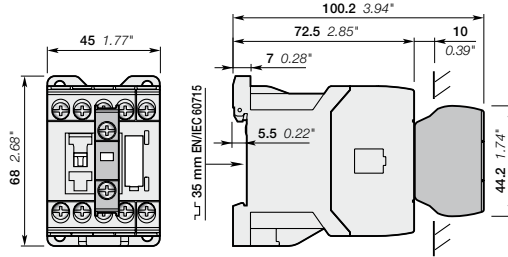

AS09, AS12, AS16  
+ CA3 front-mounted 1-pole auxiliary contact block

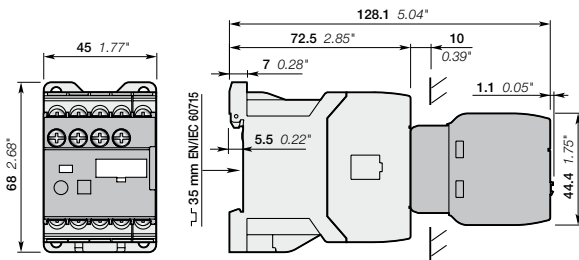
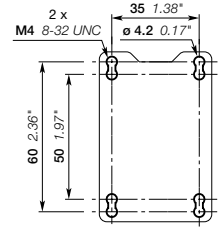

AS09, AS12, AS16  
+ TEF3 electronic timer

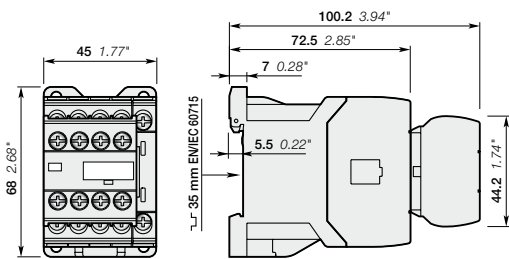

AS09 ... 16-30-32



# AS09 ... AS16 3-pole contactors

## Main dimensions mm, inches

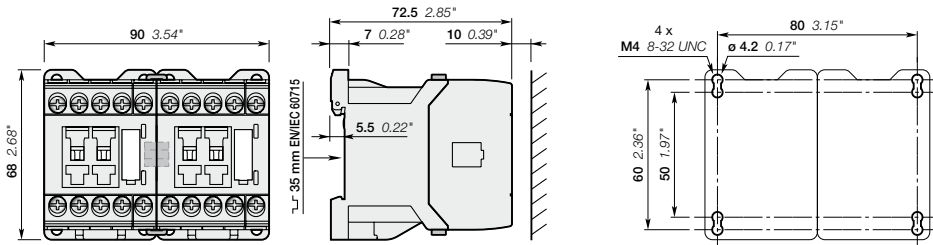

AS09, AS12, AS16  
+ VM3 mechanical interlock unit including two BB3 fixing clips

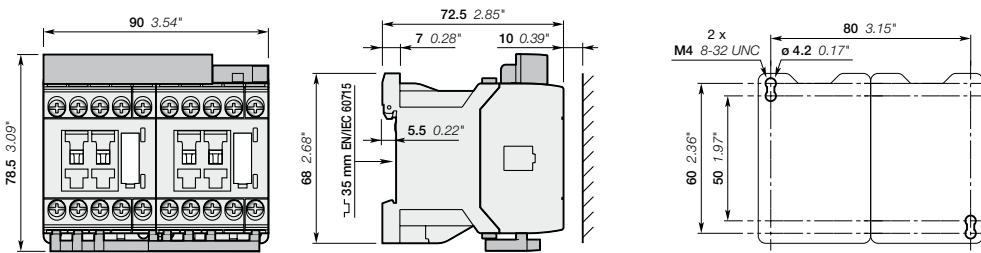

AS09, AS12, AS16  
+ BER16C-3 connection set for reversing starter including two BB3 fixing clips

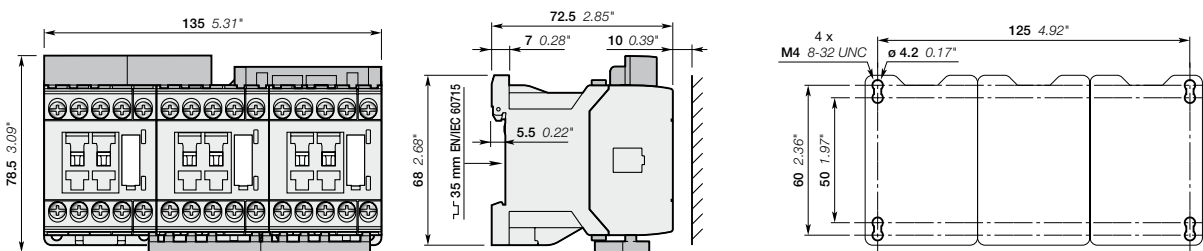

AS09, AS12, AS16  
+ BEY16C-3 connection set for star-delta starter including four BB3 fixing clips

# ASL09 ... ASL16 3-pole contactors

## Main dimensions mm, inches

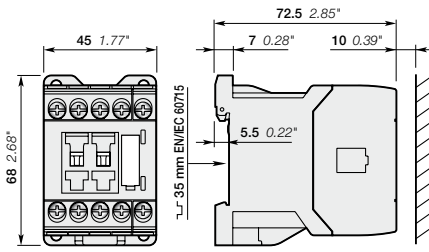

ASL09, ASL12, ASL16

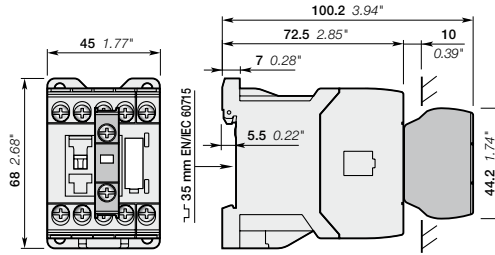

ASL09, ASL12, ASL16  
+ CA3 front-mounted 1-pole auxiliary contact block

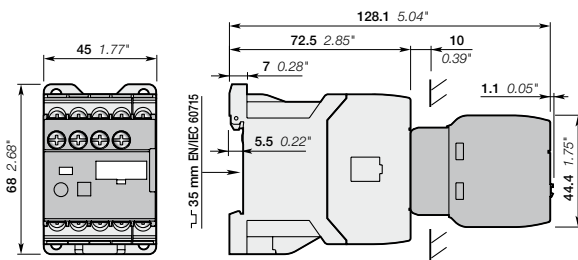
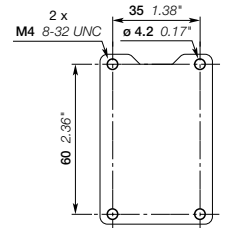

ASL09, ASL12, ASL16  
+ TEF3 electronic timer

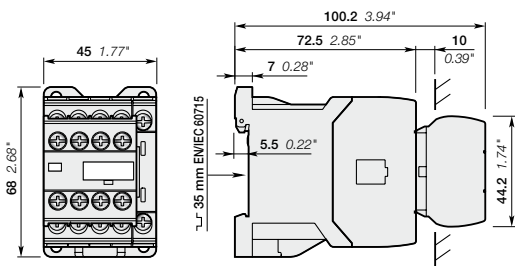

ASL09 ... 16-30-32

# ASL09 ... ASL16 3-pole contactors

## Main dimensions mm, inches

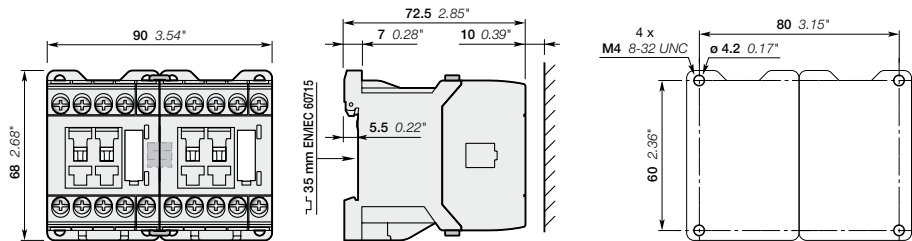

ASL09, ASL12, ASL16  
+ VM3 mechanical interlock unit including two BB3 fixing clips

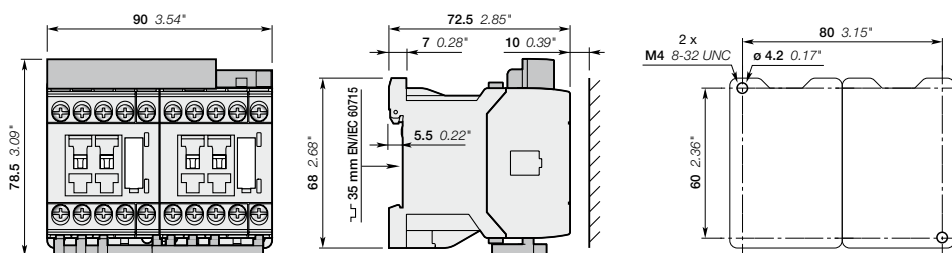

ASL09, ASL12, ASL16  
+ BER16C-3 connection set for reversing starter including two BB3 fixing clips

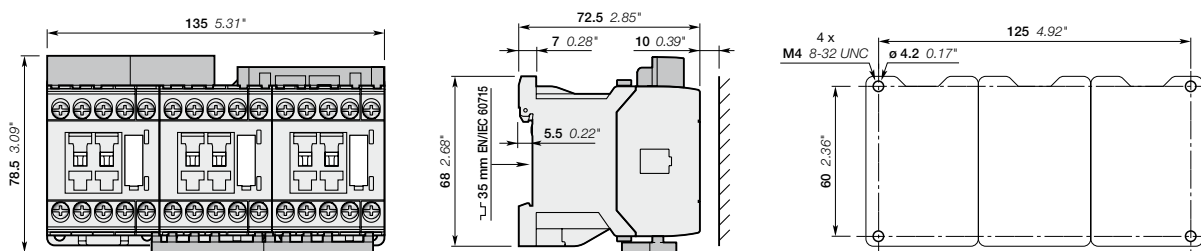

ASL09, ASL12, ASL16  
+ BEY16C-3 connection set for star-delta starter including four BB3 fixing clips

# VAS09 ... VAS16 reversing contactors

## Main dimensions mm, inches

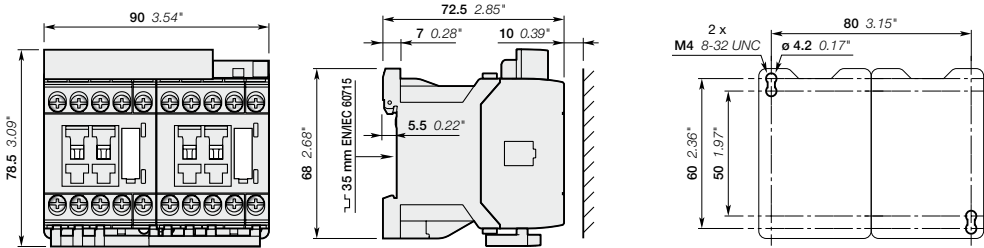

VAS09, VAS12, VAS16

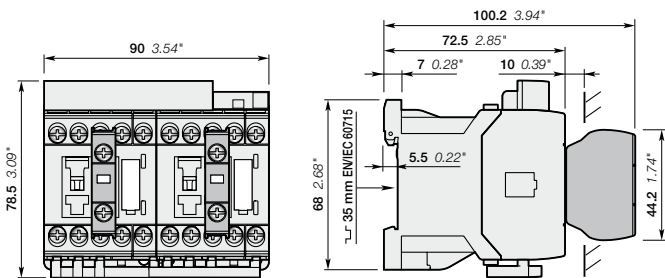

VAS09, VAS12, VAS16  
+ CA3 front-mounted 1-pole auxiliary contact block

# VASL09 ... VASL16 reversing contactors

## Main dimensions mm, inches

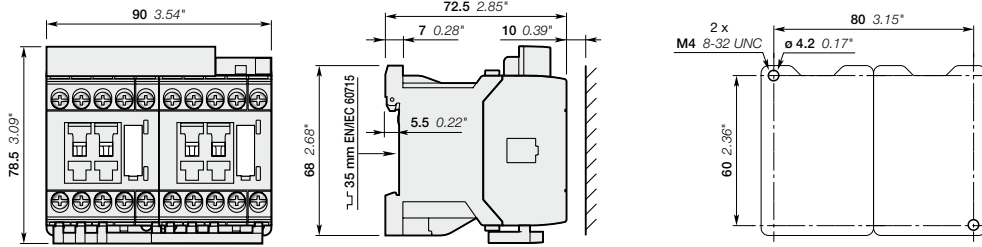

VASL09, VASL12, VASL16

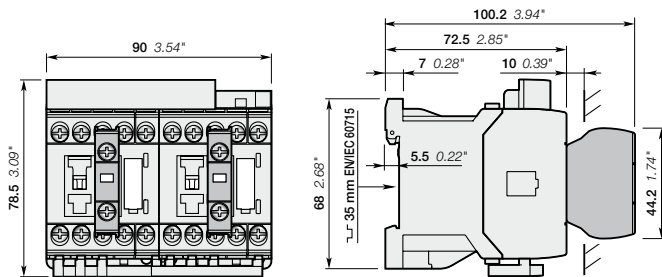

VASL09, VASL12, VASL16  
+ CA3 front-mounted 1-pole auxiliary contact block

# Contactor relays

## Main accessories

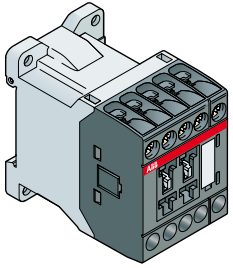

**NS, NSL**  
Contactor relays

4

### 4-pole contactor relays

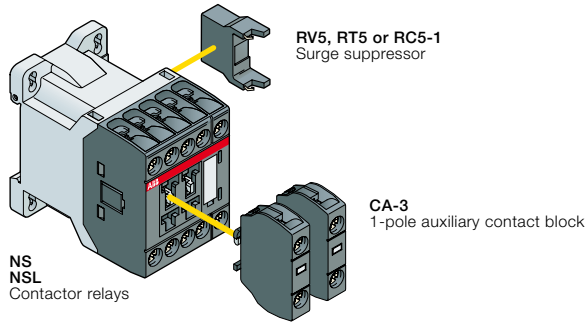

### 8-pole contactor relays

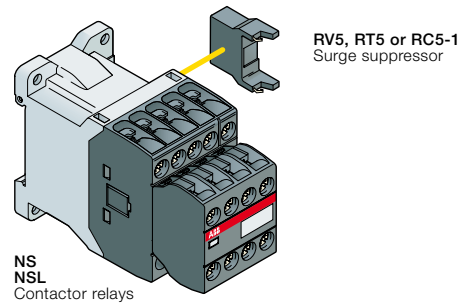

# Contactors relays



Screw terminals



NS



NSL

	AC control voltage	NS22E	NS31E	NS40E
	DC control voltage	NSL22E	NSL31E	NSL40E
		2 N.O. + 2 N.C.	3 N.O. + 1 N.C.	4 N.O.

4



NS



NSL

	AC control voltage	NS44E	NS53E	NS62E	NS71E	NS80E
	DC control voltage	NSL44E	NSL53E	NSL62E	NSL71E	NSL80E
		4 N.O. + 4 N.C.	5 N.O. + 3 N.C.	6 N.O. + 2 N.C.	7 N.O. + 1 N.C.	8 N.O.

## Control circuit switching

	Rated operational current		
IEC	AC-15	240 V	4 A
		400 V	3 A
		690 V	2 A
	DC-13	24 V	6 A / 144 W
		250 V	0.27 A / 68 W
UL / CSA	Pilot Duty	A600, Q300	

## Main accessories

Auxiliary contact blocks	Front mounting		1-pole CA3-10 or CA3-01
	Surge suppressors	Side-mounted (without additional width)	 <b>RV5</b> (Varistor) AC / DC <b>RC5-1</b> (Capacitor) AC <b>RT5</b> (Transil diode) DC

1SBC101409S0201

# NS contactor relays

## AC operated



NS22E

1SBC101012F0014

### Description

NS contactor relays are used for switching auxiliary and control circuits.

These contactor relays are designed with:

- 4 poles or 8 poles. Contactor relays have mechanically linked auxiliary contact elements (side-marked symbol)
- control circuit: AC operated
- add-on auxiliary contact blocks for front mounting and a comprehensive range of accessories.

### Ordering details

Number of contacts 1st stack	2nd stack	Rated control circuit voltage Uc (1)		Type	Order code	Weight  Pkg (1 pce) kg
		V 50 Hz	V 60 Hz			
		24	24	NS22E-20	1SBH101001R2022	0.220
		-	120	NS22E-16	1SBH101001R1622	0.220
		230	230	NS22E-26	1SBH101001R2622	0.220
		400	400	NS22E-28	1SBH101001R2822	0.220
		24	24	NS31E-20	1SBH101001R2031	0.220
		-	120	NS31E-16	1SBH101001R1631	0.220
		230	230	NS31E-26	1SBH101001R2631	0.220
		400	400	NS31E-28	1SBH101001R2831	0.220
		24	24	NS40E-20	1SBH101001R2040	0.220
		-	120	NS40E-16	1SBH101001R1640	0.220
		230	230	NS40E-26	1SBH101001R2640	0.220
		400	400	NS40E-28	1SBH101001R2840	0.220
		24	24	NS44E-20	1SBH101001R2044	0.260
		-	120	NS44E-16	1SBH101001R1644	0.260
		230	230	NS44E-26	1SBH101001R2644	0.260
		400	400	NS44E-28	1SBH101001R2844	0.260
		24	24	NS53E-20	1SBH101001R2053	0.260
		-	120	NS53E-16	1SBH101001R1653	0.260
		230	230	NS53E-26	1SBH101001R2653	0.260
		400	400	NS53E-28	1SBH101001R2853	0.260
		24	24	NS62E-20	1SBH101001R2062	0.260
		-	120	NS62E-16	1SBH101001R1662	0.260
		230	230	NS62E-26	1SBH101001R2662	0.260
		400	400	NS62E-28	1SBH101001R2862	0.260
		24	24	NS71E-20	1SBH101001R2071	0.260
		-	120	NS71E-16	1SBH101001R1671	0.260
		230	230	NS71E-26	1SBH101001R2671	0.260
		400	400	NS71E-28	1SBH101001R2871	0.260
		24	24	NS80E-20	1SBH101001R2080	0.260
		-	120	NS80E-16	1SBH101001R1680	0.260
		230	230	NS80E-26	1SBH101001R2680	0.260
		400	400	NS80E-28	1SBH101001R2880	0.260

Note: for multiple packaging, please contact your ABB local sales organization.

(1) Other control voltages see voltage code table.

### Main dimensions mm, inches

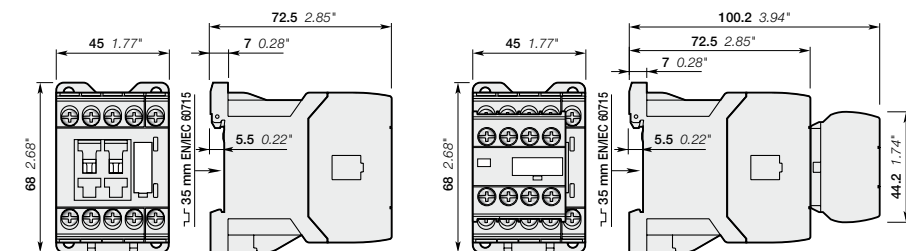

NS22E, NS31E, NS40E

NS44E, NS53E, NS62E, NS71E, NS80E

1SBC101475S0201



# NSL contactor relays

## DC operated



NSL22E

1SBC1018F0014

### Description

NSL contactor relays are used for switching auxiliary and control circuits.

These contactor relays are designed with:

- 4 poles or 8 poles. Contactor relays have mechanically linked auxiliary contact elements (side-marked symbol)
- control circuit: low coil consumption (3 W at pull-in and holding) DC operated with solid core magnet. Suitable for direct control by PLC outputs (the polarity on the coil terminals A1+ and A2- must be respected)
- add-on auxiliary contact blocks for front mounting and a comprehensive range of accessories.

### Ordering details

Number of contacts 1st stack	2nd stack	Rated control circuit voltage U <sub>c</sub> (1) V DC	Type	Order code	Weight
					Pkg (1 pce) kg
		24	NSL22E-81	1SBH103001R8122	0.280
		48	NSL22E-83	1SBH103001R8322	0.280
		110	NSL22E-86	1SBH103001R8622	0.280
		220	NSL22E-88	1SBH103001R8822	0.280
		24	NSL31E-81	1SBH103001R8131	0.280
		48	NSL31E-83	1SBH103001R8331	0.280
		110	NSL31E-86	1SBH103001R8631	0.280
		220	NSL31E-88	1SBH103001R8831	0.280
		24	NSL40E-81	1SBH103001R8140	0.280
		48	NSL40E-83	1SBH103001R8340	0.280
		110	NSL40E-86	1SBH103001R8640	0.280
		220	NSL40E-88	1SBH103001R8840	0.280
		24	NSL44E-81	1SBH103001R8144	0.320
		48	NSL44E-83	1SBH103001R8344	0.320
		110	NSL44E-86	1SBH103001R8644	0.320
		220	NSL44E-88	1SBH103001R8844	0.320
		24	NSL53E-81	1SBH103001R8153	0.320
		48	NSL53E-83	1SBH103001R8353	0.320
		110	NSL53E-86	1SBH103001R8653	0.320
		220	NSL53E-88	1SBH103001R8853	0.320
		24	NSL62E-81	1SBH103001R8162	0.320
		48	NSL62E-83	1SBH103001R8362	0.320
		110	NSL62E-86	1SBH103001R8662	0.320
		220	NSL62E-88	1SBH103001R8862	0.320
		24	NSL71E-81	1SBH103001R8171	0.320
		48	NSL71E-83	1SBH103001R8371	0.320
		110	NSL71E-86	1SBH103001R8671	0.320
		220	NSL71E-88	1SBH103001R8871	0.320
		24	NSL80E-81	1SBH103001R8180	0.320
		48	NSL80E-83	1SBH103001R8380	0.320
		110	NSL80E-86	1SBH103001R8680	0.320
		220	NSL80E-88	1SBH103001R8880	0.320

Note: for multiple packaging, please contact your ABB local sales organization.

(1) Other control voltages see voltage code table.

### Main dimensions mm, inches

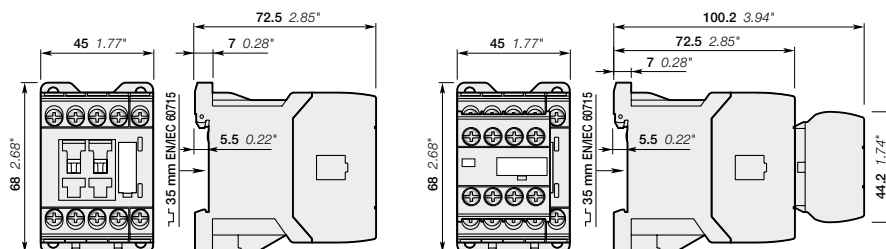

NSL22E, NSL31E, NSL40E

NSL44E, NSL53E, NSL62E, NSL71E, NSL80E

# NS and NSL contactor relays

## Main accessories

### Contactor relays and main accessories (other accessories available)

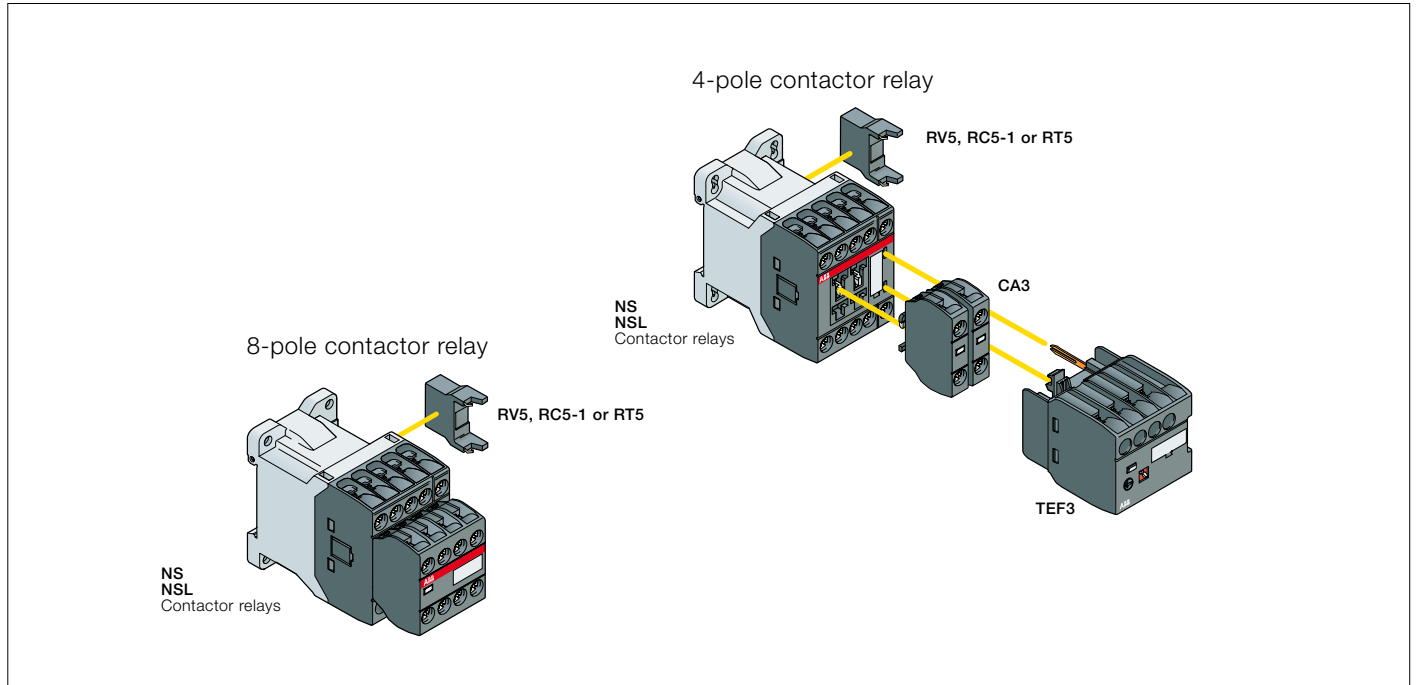

### Main accessory fitting details

Contactor types	Main poles	Front-mounted accessories		Side-mounted accessories	
		Auxiliary contact blocks	Electronic timer	Surge suppressors	
		1-pole CA3	TEF3		
NS..	2 2 E	2 max.	or 1	+	RV5 or RC5-1
NS..	3 1 E				
NS..	4 0 E				
NS..	4 4 E	-	-		RV5 or RC5-1
NS..	5 3 E				
NS..	6 2 E				
NS..	7 1 E				
NS..	8 0 E				
NSL..	2 2 E	2 max.	or 1	+	RV5 or RT5
NSL..	3 1 E				
NSL..	4 0 E				
NSL..	4 4 E	-	-		RV5 or RT5
NSL..	5 3 E				
NSL..	6 2 E				
NSL..	7 1 E				
NSL..	8 0 E				

# NS and NSL contactor relays

## Main accessories



CA3-10

1SBC101038F0014



TEF3-ON

1SBC101337F0014



RV5

1SBC574001F0301

### Front-mounted instantaneous auxiliary contact blocks

For contactor relays	Auxiliary contacts	Type	Order code	Pkg qty	Weight (1 pce)
					kg
NS, NSL	1 0	CA3-10	1SBN011010T1010	10	0.011
	0 1	CA3-01	1SBN011010T1001	10	0.011

### Front-mounted electronic timer

For contactors	Rated control circuit voltage - Uc	Type	Order code	Pkg qty	Weight (1 pce)
	V				kg
<b>ON-delay</b>					
NS, NSL	24...240 V AC/DC	TEF3-ON	1SBN021012R1000	1	0.065
<b>OFF-delay</b>					
NS, NSL	24...240 V AC/DC	TEF3-OFF	1SBN021014R1000	1	0.065

### Surge suppressors

For contactor relays	Rated control circuit voltage - Uc		Type	Order code	Pkg qty	Weight (1 pce)
	V	AC DC				
NS, NSL	24...50	● ●	RV5/50	1SBN050010R1000	2	0.015
	50...133	● ●	RV5/133	1SBN050010R1001	2	0.015
	110...250	● ●	RV5/250	1SBN050010R1002	2	0.015
	250...440	● ●	RV5/440	1SBN050010R1003	2	0.015
NS	24...50	● -	RC5-1/50	1SBN050100R1000	2	0.012
	50...133	● -	RC5-1/133	1SBN050100R1001	2	0.012
	110...250	● -	RC5-1/250	1SBN050100R1002	2	0.012
	250...440	● -	RC5-1/440	1SBN050100R1003	2	0.012
NSL	12...32	- ●	RT5/32	1SBN050020R1000	2	0.015
	25...65	- ●	RT5/65	1SBN050020R1001	2	0.015
	50...90	- ●	RT5/90	1SBN050020R1002	2	0.015
	77...150	- ●	RT5/150	1SBN050020R1003	2	0.015
	150...264	- ●	RT5/264	1SBN050020R1004	2	0.015

# NS and NSL contactor relays

## Technical data

### Contact utilization characteristics according to IEC

Contactor relay types	AC operated	NS
	DC operated	NSL
Standards	IEC 60947-5-1 and EN 60947-5-1	
Rated operational voltage U <sub>e</sub> max.	690 V	
Rated frequency (without derating)	50 / 60 Hz	
Conventional free-air thermal current I <sub>th</sub> - θ ≤ 40 °C	10 A	
I <sub>e</sub> / Rated operational current AC-15		
acc. to IEC 60947-5-1	24-127 V 50/60 Hz	6 A
	220-240 V 50/60 Hz	4 A
	400-440 V 50/60 Hz	3 A
	500 V 50/60 Hz	2 A
	690 V 50/60 Hz	2 A
Making capacity AC-15	10 x I <sub>e</sub> AC-15 acc. to IEC 60947-5-1	
Breaking capacity AC-15	10 x I <sub>e</sub> AC-15 acc. to IEC 60947-5-1	
I <sub>e</sub> / Rated operational current DC-13		
acc. to IEC 60947-5-1	24 V DC	6 A / 144 W
	48 V DC	2.8 A / 134 W
	72 V DC	1 A / 72 W
	110 V DC	0.55 A / 60 W
	125 V DC	0.55 A / 69 W
	220 V DC	0.27 A / 60 W
	250 V DC	0.27 A / 68 W
Short-circuit protection device for contactors		
U <sub>e</sub> ≤ 500 V AC - gG type fuse	10 A	
Rated short-time withstand current I <sub>cw</sub>	for 1.0 s	100 A
	for 0.1 s	140 A
Minimum switching capacity	12 V / 3 mA	
with failure rate acc. to IEC 60947-5-4	10 <sup>-7</sup>	
Non-overlapping time between N.O. and N.C. contacts	1.5 ms	
Power dissipation per pole at 6 A	0.1 W	
Max. electrical switching frequency	AC-15	1200 cycles/h
	DC-13	900 cycles/h
Mechanically linked contacts	Built-in N.O. or N.C. auxiliary contacts and additional N.O. or N.C. auxiliary contacts (CA3 aux. contact blocks) are mechanically linked contacts.	
acc. to annex L of IEC 60947-5-1		

### Contact utilization characteristics according to UL / CSA

Contactor relay types	AC operated	NS
	DC operated	NSL
Standards	UL 508, CSA C22.2 N°14	
Max. operational voltage	600 V AC, 250 V DC	
Pilot duty	A600, Q300	
AC thermal rated current	10 A	
AC maximum volt-ampere making	7200 VA	
AC maximum volt-ampere breaking	720 VA	
DC thermal rated current	2.5 A	
DC maximum volt-ampere making-breaking	69 VA	

# NS and NSL contactor relays

## Technical data

### Magnet system characteristics for NS contactor relays

Contactor relay types	AC operated	NS
Coil operating limits	AC supply	0.85...1.1 x U <sub>c</sub> (at $\theta \leq 60$ °C); U <sub>c</sub> (at $\theta \leq 70$ °C)
acc. to IEC 60947-5-1		
AC control voltage	Rated control circuit voltage U <sub>c</sub>	at 50 Hz : 24...415 V
		at 60 Hz : 24...415 V
Coil consumption	Average pull-in value	50 Hz : 33 VA
		60 Hz : 33 VA
		50/60 Hz : 33 VA
	Average holding value	50 Hz : 6.5 VA / 1.5 W
		60 Hz : 5 VA / 1.2 W
50/60 Hz : 6.5 VA / 1.5 W		
Drop-out voltage		Approx. 30...50 % of U <sub>c</sub>
Operating time		
Between coil energization and:	N.O. contact closing	9...24 ms
	N.C. contact opening	6...18 ms
Between coil de-energization and:	N.O. contact opening (1)	5...19 ms
	N.C. contact closing (1)	7...22 ms
		(1) The use of RC5-1 surge suppressor increases opening time by a factor of 2 to 3.

### Magnet system characteristics for NSL contactor relays

Contactor relay types	DC operated	NSL
Coil operating limits	DC supply	0.85...1.1 x U <sub>c</sub> (at $\theta \leq 60$ °C); U <sub>c</sub> (at $\theta \leq 70$ °C)
acc. to IEC 60947-5-1		
DC control voltage	Rated control circuit voltage U <sub>c</sub>	12...240 V DC
	Coil consumption	
	Average pull-in value	3 W
	Average holding value	3 W
Drop-out voltage		Approx. 10...40 % of U <sub>c</sub>
Coil time constant	Open	L/R : 12 ms
	Closed	L/R : 40 ms
Operating time		
Between coil energization and:	N.O. contact closing	36...59 ms
	N.C. contact opening	31...53 ms
Between coil de-energization and:	N.O. contact opening (1)	13...17 ms
	N.C. contact closing (1)	15...20 ms
		(1) The use of RT5 surge suppressor increases opening time by a factor of 1.1 to 1.2.

### Mounting characteristics and conditions for use

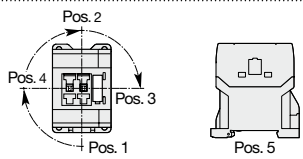
Contactor relay types	AC operated	NS
	DC operated	NSL
Mounting positions		
Mounting distances	The contactor relays can be assembled side by side.	
Fixing	On rail according to IEC 60715, EN 60715	35 x 7.5 mm or 35 x 15 mm
	By screws (not supplied)	2 x M4 screws placed diagonally



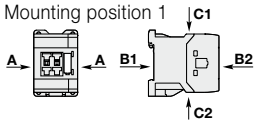

# NS and NSL contactor relays

## Technical data

### General technical data

Contactor relay types	AC operated	NS
	DC operated	NSL
Rated insulation voltage $U_i$		690 V
acc. to IEC 60947-5-1		600 V
acc. to UL / CSA		6 kV
Rated impulse withstand voltage $U_{imp}$		
Ambient air temperature close to contactor relay		
Operation in free air		-40...+70 °C
Storage		-60...+80 °C
Climatic withstand		Category B according to IEC 60947-1 Annex Q
Maximum operating altitude (without derating)		3000 m
Mechanical durability		
Number of operating cycles		20 millions operating cycles
Max. switching frequency		3600 cycles/h
Shock withstand		1/2 sinusoidal shock for 11 ms: no change in contact position, closed or open position
acc. to IEC 60068-2-27 and EN 60068-2-27		
Mounting position 1	Shock direction	NS contactor relays - AC operated
	A	20 g
	B1	5 g
	B2	15 g
	C1	19 g closed position / 8 g open position
	C2	16 g closed position / 13 g open position
		NSL contactor relays - DC operated
		20 g closed position / 10 g open position
		15 g closed position / 5 g open position
		10 g
		19 g closed position / 8 g open position
		14 g closed position / 8 g open position
Vibration withstand acc. to IEC 60068-2-6		5...300 Hz / 3 g closed position / 2 g open position

### Connecting characteristics

Contactor relay types	AC operated	NS
	DC operated	NSL
Main terminals		
		Screw terminals with cable clamp
Connection capacity (min. ... max.)		
Pole and coil terminals		
 Rigid solid	1 x	0.75...2.5 mm <sup>2</sup>
	2 x	0.75...2.5 mm <sup>2</sup>
 Flexible with non insulated ferrule	1 x	0.75...2.5 mm <sup>2</sup>
	2 x	0.75...2.5 mm <sup>2</sup>
 Flexible with insulated ferrule	1 x	0.75...2.5 mm <sup>2</sup>
	2 x	0.75...1.5 mm <sup>2</sup>
 Lugs	L ≤	7.7 mm
	L >	3.2 mm
Connection capacity acc. to UL / CSA	1 or 2 x	AWG 18...14
Stripping length		9 mm
Tightening torque	Recommended	1.00 Nm / 9 lb.in
	Max.	1.20 Nm
Degree of protection		
acc. to IEC 60947-1 / EN 60947-1 and IEC 60529 / EN 60529		
All terminals		IP20
Screw terminals		Delivered in open position, screws of unused terminals must be tightened
All terminals		M3
	Screwdriver type	Flat Ø 5.5 / Pozidriv 2

# Notes

A series of horizontal dotted lines for taking notes, spanning the width of the page.

# NS contactor relays

## Terminal marking and positioning

### NS contactor relays - AC operated

Standard devices without addition of auxiliary contact blocks

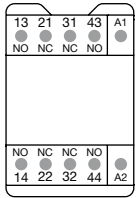

NS22E

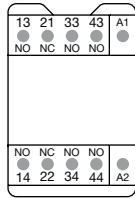

NS31E

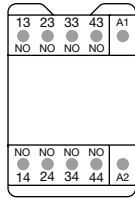

NS40E

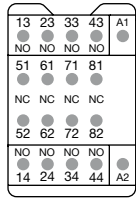

NS44E

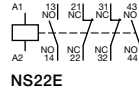

NS22E



NS40E

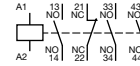

NS31E

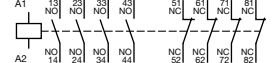

NS44E

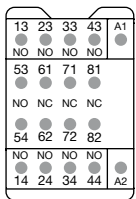

NS53E

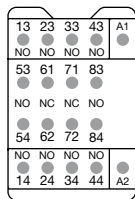

NS62E

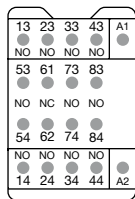

NS71E

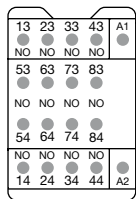

NS80E

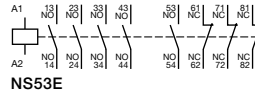

NS53E



NS71E



NS62E



NS80E

Other possible contact combinations with auxiliary contact blocks added by the user

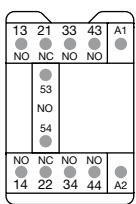

Combination 41E

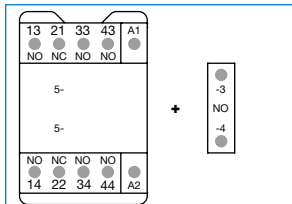

NS31E + CA3-10

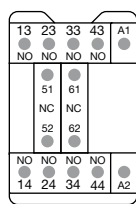

Combination 42E

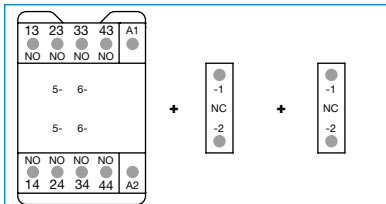

NS40E + CA3-01 + CA3-01

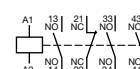

Combination 41E



Combination 42E

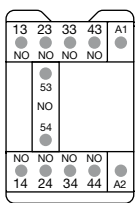

Combination 50E

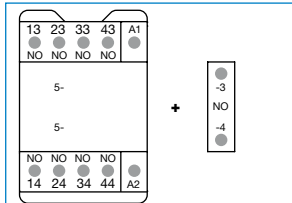

NS40E + CA3-10

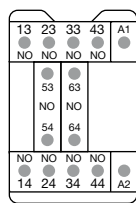

Combination 60E

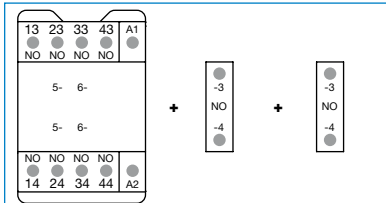

NS40E + CA3-10 + CA3-10

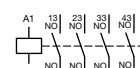

Combination 50E

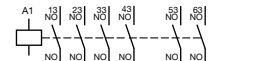

Combination 60E

CA3 1-pole auxiliary contact blocks

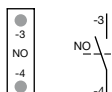

CA3-10

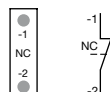

CA3-01

TEF3 front-mounted electronic timer

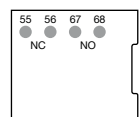

TEF3





# NSL contactor relays

## Terminal marking and positioning

**NSL contactor relays - DC operated** (the polarity A1+, A2- must be respected)

Standard devices without addition of auxiliary contact blocks

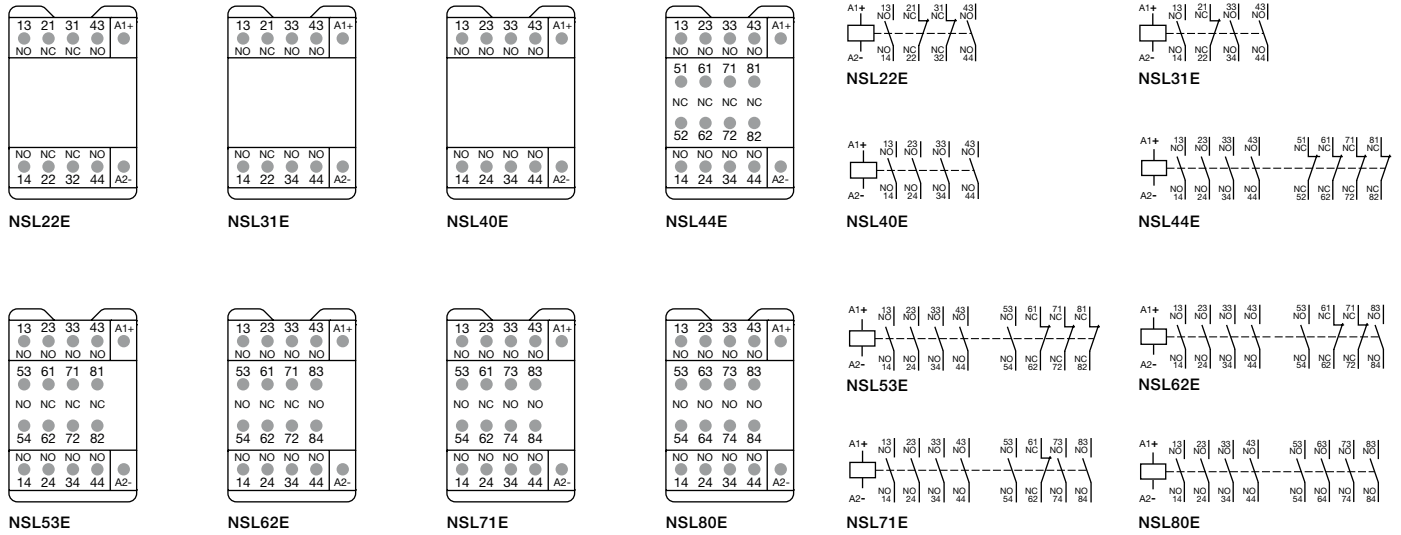

Other possible contact combinations with auxiliary contact blocks added by the user

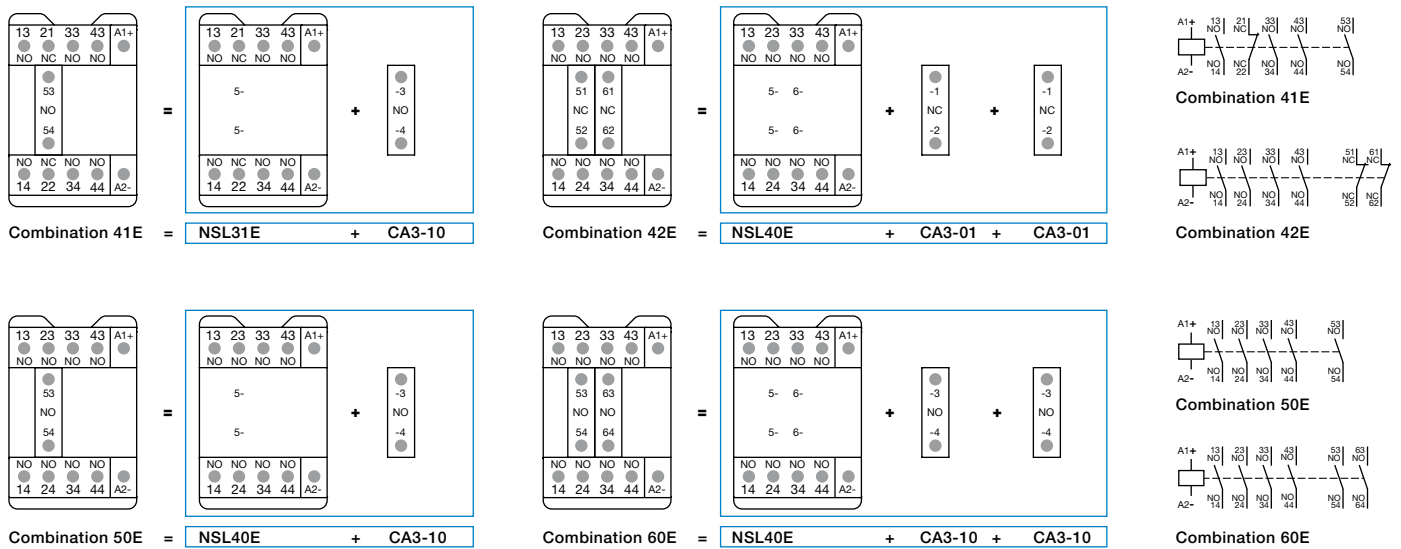

CA3 1-pole auxiliary contact blocks

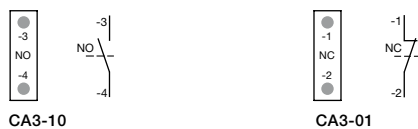

TEF3 front-mounted electronic timer

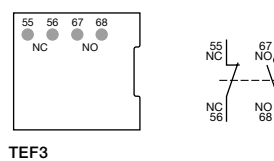

# NS contactor relays

## Main dimensions mm, inches

### 4-pole contactor relays

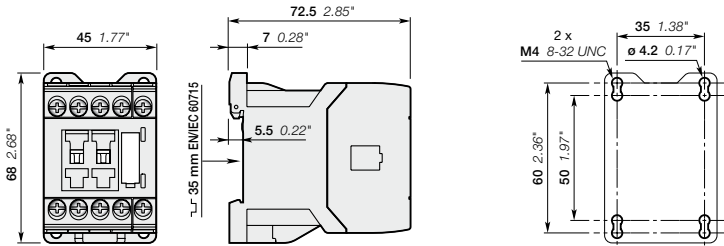

NS22E, NS31E, NS40E

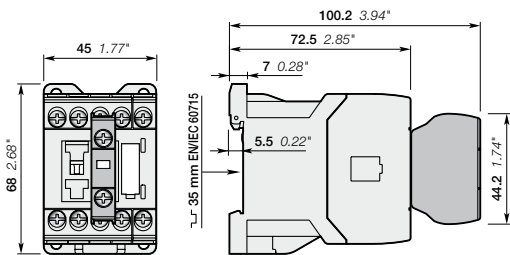

NS22E, NS31E, NS40E

+ CA3 front-mounted 1-pole auxiliary contact block

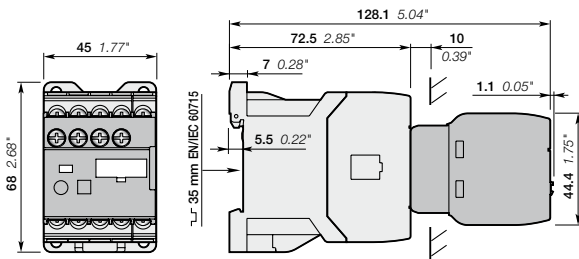

NS22E, NS31E, NS40E

+ TEF3 electronic timer

### 8-pole contactor relays

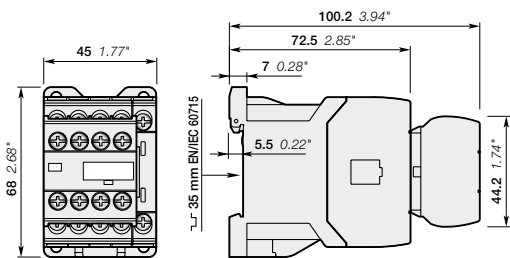

NS44E, NS53E, NS62E, NS71E, NS80E

# NSL contactor relays

## Main dimensions mm, inches

### 4-pole contactor relays

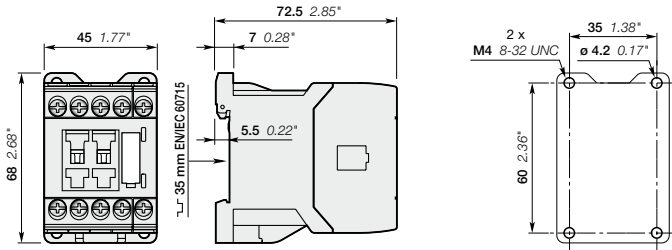

NSL22E, NSL31E, NSL40E

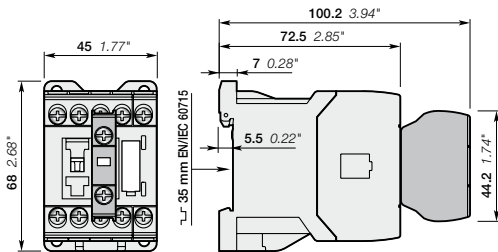

NSL22E, NSL31E, NSL40E

+ CA3 front-mounted 1-pole auxiliary contact block

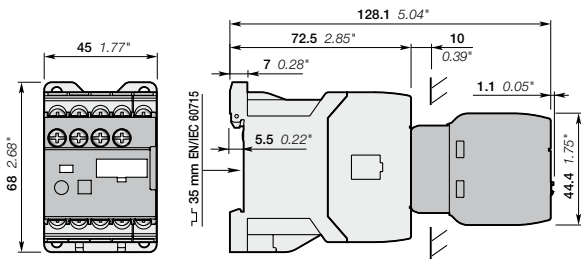

NSL22E, NSL31E, NSL40E

+ TEF3 electronic timer

### 8-pole contactor relays

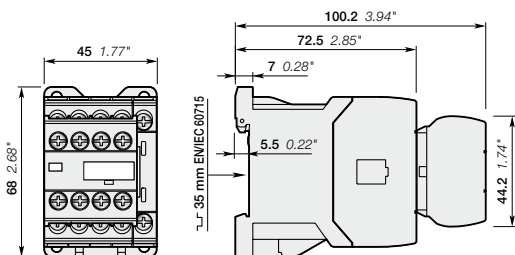

NSL44E, NSL53E, NSL62E, NSL71E, NSL80E

# Auxiliary contact blocks

## Accessories



1SBC101036F0014

CA3-10

### Description

The auxiliary contact blocks are used for the operation of auxiliary circuits and control circuits. CA3 1-pole auxiliary contact blocks, designed for standard industrial environments, are equipped with:

- N.O. or N.C. contacts.
- Screw-type connecting terminals with cage clamp delivered open.

All 1-pole auxiliary contact blocks are protected against accidental direct contact and bear the corresponding function marking.

A maximum of two 1-pole auxiliary contact blocks can be front-mounted on 1-stack contactors or 1-stack contactor relays.

### Ordering details

For contactors	For contactor relays	Contact blocks	Type	Order code	Pkg qty	Weight (1 pce)
						kg

#### 1-pole auxiliary contact blocks with screw terminals

AS09 ... AS16	NS, NSL	1 -	CA3-10	1SBN011010T1010	10	0.011
ASL09 ... ASL16		- 1	CA3-01	1SBN011010T1001	10	0.011

### Main dimensions mm, inches

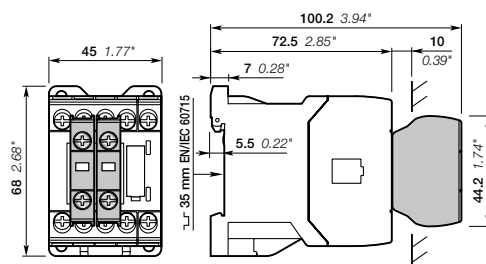

# Auxiliary contact blocks

## Technical data







### Contact utilization characteristics according to IEC

Types	1-pole CA3	
Standards	IEC 60947-5-1 and EN 60947-5-1	
Rated insulation voltage $U_i$ acc. to IEC 60947-5-1	690 V	
Rated impulse withstand voltage $U_{imp}$	6 kV	
Rated operational voltage $U_e$ max.	690 V	
Conventional thermal current $I_{th} - \theta \leq 40^\circ\text{C}$	10 A	
le / Rated operational current AC-15 acc. to IEC 60947-5-1	24-127 V 50/60 Hz	6 A
	220-240 V 50/60 Hz	4 A
	400-440 V 50/60 Hz	3 A
	500 V 50/60 Hz	2 A
	690 V 50/60 Hz	2 A
Making capacity	10 x $I_e$ AC-15 acc. to IEC 60947-5-1	
Breaking capacity	10 x $I_e$ AC-15 acc. to IEC 60947-5-1	
le / Rated operational current DC-13 acc. to IEC 60947-5-1	24 V DC	6 A / 144 W
	48 V DC	2.8 A / 134 W
	72 V DC	1 A / 72 W
	110 V DC	0.55 A / 60 W
	125 V DC	0.55 A / 69 W
	220 V DC	0.27 A / 60 W
	250 V DC	0.27 A / 68 W
Short-circuit protection device gG type fuse	10 A	
Rated short-time withstand current $I_{cw}$ $\theta = 40^\circ\text{C}$	for 1.0 s	100 A
	for 0.1 s	140 A
Minimum switching capacity with failure rate acc. to IEC 60947-5-4	12 V / 3 mA	
Power dissipation per pole at 6 A	0.1 W	
Mechanical durability	10 millions operating cycles	
Number of operating cycles	3600 cycles/h	
Max. switching frequency		
Max. electrical switching frequency	AC-15	1200 cycles/h
	DC-13	900 cycles/h
Mechanically linked contacts acc. to annex L of IEC 60947-5-1	Additional N.O. or N.C. auxiliary contacts (CA3) are mechanically linked contacts	
Mirror contacts acc. to annex F of IEC 60947-4-1	Additional N.C. auxiliary contacts (CA3) are mirror contacts	

### Contact utilization characteristics according to UL / CSA

Standards	UL 508, CSA C22.2 N°14	
Max. operational voltage	690 V AC, 250 V DC	
Pilot duty	A600, Q300	
AC thermal rated current	10 A	
AC maximum volt-ampere making	7200 VA	
AC maximum volt-ampere breaking	720 VA	
DC thermal rated current	2.5 A	
DC maximum volt-ampere making-breaking	69 VA	

### Connecting characteristics

Connection capacity (min. ... max.)		
	Rigid solid	1 x 0.75...2.5 mm <sup>2</sup>
	Flexible with non insulated ferrule	2 x 0.75...2.5 mm <sup>2</sup>
		1 x 0.75...2.5 mm <sup>2</sup>
	Flexible with insulated ferrule	2 x 0.75...2.5 mm <sup>2</sup>
		1 x 0.75...2.5 mm <sup>2</sup>
	Lugs	L ≤ 7.7 mm
		I > 3.2 mm
Connection capacity acc. to UL / CSA		1 or 2 x AWG 18...14
Stripping length		9 mm
Tightening torque		Recommended 1 Nm / 9 lb.in
		Max. 1.20 Nm
Degree of protection		
acc. to IEC 60947-1 / EN 60947-1 and IEC 60529 / EN 60529		IP20
Screw terminals		
All terminals		Delivered in open position, screws of unused terminals must be tightened
		M3
Screwdriver type		
		Flat Ø 5.5 / Pozidriv 2

# Notes

4

A series of horizontal dotted lines for writing notes.

# Electronic timers



TEF3-ON

1SBC101337F0010



TEF3-OFF

1SBC101336F0010

## Description

TEF3 frontal electronic timers are used for realizing timing function and are available in ON-delay and OFF-delay versions.

### Compact solution in cabinet compared to separate timers

TEF3 electronic timers are front-mounted and locked on AS/ASL contactors or NS/NSL contactor relays. A mechanical indicator allows to show the state of the contactor.

### Safe and cost-reduced wiring

TEF3 electronic timers are supplied by a direct plug-in parallel connection to the coil terminals A1 - A2 of the contactor or contactor relay. A varistor is integrated on the timer to offer a built-in protection against surges in the contactor coil.

### Available for a wide control voltage range 24...240 V AC/DC

TEF3-ON or TEF3-OFF allow time-delayed functions up to 100 s in 3 distinct time ranges, independently of the control system. The time delay ranges are selected by a switch and the time delay can be adjusted by means of a rotary switch. The timing function is activated by closing or opening the device on which the timer is mounted. The OFF-delay version operates without additional control supply.

## Ordering details

For contactors, contactor relays	Time delay range selected by switch	Delay type	Rated control circuit voltage Uc	Auxiliary contacts	Type	Order code	Weight Pkg (1 pce) kg
AS09 ... AS16	0.1...1 s	ON-delay	24...240	1 1	TEF3-ON	1SBN021012R1000	0.065
ASL09 ... ASL16	1...10 s						
NS, NSL	10...100 s	OFF-delay	24...240	1 1	TEF3-OFF	1SBN021014R1000	0.065

## Main dimensions mm, inches

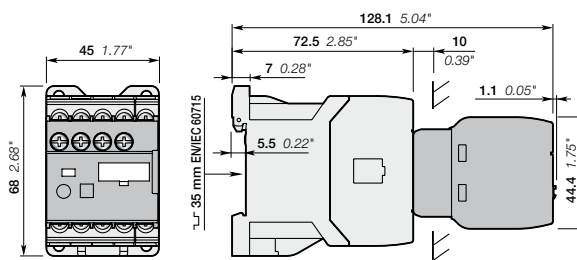

1SBC10150450201

# Electronic timers

## Technical data

### Contact utilization characteristics according to IEC

Types	TEF3-ON	TEF3-OFF
<b>Standards</b>	IEC 60947-5-1 and EN 60947-5-1	
<b>Rated insulation voltage <math>U_i</math></b> acc. to IEC 60947-5-1	400 V	
<b>Rated impulse withstand voltage <math>U_{imp}</math></b>	4 kV	
<b>Rated operational voltage <math>U_e</math> max.</b>	240 V	
<b>Rated frequency (without derating)</b>	50 / 60 Hz	
<b>Conventional thermal current <math>I_{th} - \theta \leq 40^\circ\text{C}</math></b>	5 A	
<b><math>I_e</math> / Rated operational current AC-15</b> acc. to IEC 60947-5-1	24-127 V 50/60 Hz	3 A
	220-240 V 50/60 Hz	1.5 A
<b>Making capacity</b> acc. to IEC 60947-5-1	10 x $I_e$ AC-15	
<b>Breaking capacity</b> acc. to IEC 60947-5-1	10 x $I_e$ AC-15	
<b><math>I_e</math> / Rated operational current DC-13</b> acc. to IEC 60947-5-1	24 V DC	1 A / 24 W
<b>Short-circuit protection device gG type fuse</b>	6 A	
<b>Rated short-time withstand current <math>I_{cw}</math></b> $\theta = 40^\circ\text{C}$	for 1.0 s	8 A
	for 0.1 s	8 A
<b>Minimum switching capacity</b> with failure rate acc. to IEC 60947-5-4	24 V DC	12 V / 3 mA
<b>Power dissipation per pole at 3 A</b>	0.1 W	
<b>Function diagram</b>	ON-delay	OFF-delay
	Bistable relay inside. Before use, once apply $U_c$ then switch it off in order to initialize position of the contacts.	
<b>Control circuit voltage</b>		
<b>AC control voltage</b>	Rated control circuit voltage $U_c$	24...240 V AC
50/60 Hz	Average consumption	1.5 mA RMS
<b>DC control voltage</b>	Rated control circuit voltage $U_c$	24...240 V DC
	Average consumption	1.5 mA
		1 mA
<b>Rated frequency limits</b>	50 / 60 Hz	
<b>Supply voltage range</b>	0.85...1.1 x $U_c$ (at $\theta \leq 70^\circ\text{C}$ )	
<b>Overvoltage protection</b>	Varistor included	
<b>Time delay range (t) selected by switch</b>	0.1...1 s	<input type="checkbox"/>
	1...10 s	<input type="checkbox"/>
	10...100 s	<input type="checkbox"/>
<b>On-load reiteration accuracy under constant conditions</b>	$\leq 1\%$	
<b>Minimum ON period</b>	0.1 s	
<b>Recovery time</b>	0.15 s	0.1 s
<b>Ambient air temperature</b>	Operation	-25 °C ... +70 °C
	Storage	-40 °C ... +80 °C
<b>Climatic withstand</b>	Category B according to IEC 60947-1 Annex Q	
<b>Maximum operating altitude</b>	2000 m	
<b>Mounting positions</b>	Mounting positions 1, 1 +/- 30°, 2, 3, 4, 5	
<b>Shock withstand</b> acc. to IEC 60068-2-27 and EN 60068-2-27	1/2 sinusoidal shock for 11 ms: no change in contact position	
(Mounting position 1)	Same as contactor or contactor relay	
<b>Vibration withstand</b> acc. to IEC 60068-2-6	5...300 Hz	
	3 g closed position / 2 g open position	
<b>Mechanical durability</b>	Number of operating cycles	5 millions operating cycles
	Max. switching frequency	3600 cycles/h
<b>Max. electrical switching frequency</b>		1800 cycles/h
	AC-15	1200 cycles/h
	DC-13	900 cycles/h







# Electronic timers

## Technical data

### Contact utilization characteristics according to UL / CSA

Types	TEF3-ON	TEF3-OFF
Standards	UL 508, CSA C22.2 N°14	
Rated insulation voltage $U_i$ acc. to UL / CSA	300 V	
Max. operational voltage	240 V	
Pilot duty	B300, R300	
AC thermal rated current	5 A	
AC maximum volt-ampere making	3600 VA	
AC maximum volt-ampere breaking	360 VA	
DC thermal rated current	1 A	
DC maximum volt-ampere making-breaking	28 VA	

### Connecting characteristics

Connection capacity (min. ... max.)		
 Rigid solid	1 x	0.75...2.5 mm <sup>2</sup>
	2 x	0.75...2.5 mm <sup>2</sup>
 Flexible with non insulated ferrule	1 x	0.75...2.5 mm <sup>2</sup>
	2 x	0.75...2.5 mm <sup>2</sup>
 Flexible with insulated ferrule	1 x	0.75...2.5 mm <sup>2</sup>
	2 x	0.75...1.5 mm <sup>2</sup>
 Lugs	L ≤	7.7 mm
	L >	3.2 mm
Connection capacity acc. to UL / CSA	1 or 2 x	AWG 18...14
Stripping length		9 mm
Tightening torque	Recommended	1 N.m / 9 lb.in
	Max.	1.20 N.m
Degree of protection		IP20
acc. to IEC 60947-1 / EN 60947-1 and IEC 60529 / EN 60529		
Screw terminals	Delivered in open position, screws of unused terminals should be tightened	
All terminals	M3	
Screwdriver type	Flat Ø 5.5 / Pozidriv 2	
Terminal Marking		

# Surge suppressors for contactor coils

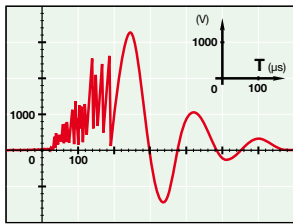

## Description

The operation of inductive circuits causes overvoltages, in particular on opening the contactor coil. The electromagnetic energy stored in the coil during contactor closing is restored on opening in the form of surges, the slope and amplitude of which may rise to several kilovolts. A number of drawbacks are observed ranging from interference on the electronic devices to the breakdown of insulators and even the destruction of certain sensitive components.

The graph opposite reproduces the oscillogram showing voltage discharges at the terminals of a 42 V / 50 Hz coil without peak clipping. The coil was switched by 8 series-connected poles of a contactor relay.

Following a burst of discharges with a very steep slope, a damped oscillation emerges with a peak value of 3500 V.

## Overvoltage Factor

The overvoltage factor  $k$  is defined as the ratio of the maximum overvoltage peak value  $\hat{U}_s$  to the peak value  $\hat{U}_c$  of the coil rated control voltage  $U_c$ :

$$k = \frac{\hat{U}_s \text{ max.}}{\hat{U}_c} \quad \text{in DC} \quad k = \frac{\hat{U}_s \text{ max.}}{U_c} \quad \text{in AC} \quad k = \frac{\hat{U}_s \text{ max.}}{U_c \sqrt{2}}$$

For example the following is obtained for the above graph:  $k = \frac{3500}{42 \sqrt{2}} \approx 60$

To reduce the harmful effects of these overvoltages, ABB has developed a range of surge suppressors designed to reduce the  $k$  factor defined above and to limit or even completely eliminate the high pre-damping voltage frequencies.

Each case is different, but the technical data tolerances and generous sizing of parts have enabled us to reduce the number of variants.

We have chosen the following solutions: transil diodes, varistors and RC blocks.

Note: A varistor is a resistor whose value decreases to a very large extent when a certain voltage is applied at its terminals.

## Ordering details

For contactors	For contactor relays	Rated control circuit voltage - $U_c$			Type	Order code	Pkg qty	Weight (1 pce) kg
		V	AC	DC				
AS, ASL	NS, NSL	24...50	●	●	RV5/50	1SBN050010R1000	2	0.015
		50...133	●	●	RV5/133	1SBN050010R1001	2	0.015
		110...250	●	●	RV5/250	1SBN050010R1002	2	0.015
		250...440	●	●	RV5/440	1SBN050010R1003	2	0.015
AS	NS	24...50	●	-	RC5-1/50	1SBN050100R1000	2	0.012
		50...133	●	-	RC5-1/133	1SBN050100R1001	2	0.012
		110...250	●	-	RC5-1/250	1SBN050100R1002	2	0.012
		250...440	●	-	RC5-1/440	1SBN050100R1003	2	0.012
ASL	NSL	12...32	-	●	RT5/32	1SBN050020R1000	2	0.015
		25...65	-	●	RT5/65	1SBN050020R1001	2	0.015
		50...90	-	●	RT5/90	1SBN050020R1002	2	0.015
		77...150	-	●	RT5/150	1SBN050020R1003	2	0.015
		150...264	-	●	RT5/264	1SBN050020R1004	2	0.015

## Main dimensions mm, inches

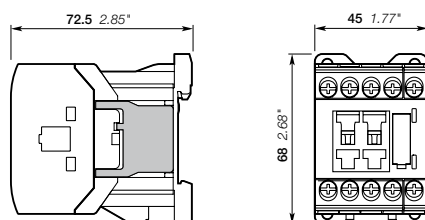

**Easy connection to the coil terminals**  
(parallel mounting)  
Clip-on for both fixing and connection.

**No additional space**  
Clipped onto the right side part of the contactor base without changing contactor overall dimensions and keeping a free access to coil terminals.

1SBC101494S0201



RV5



RC5-1



RT5

# Surge suppressors for contactor coils

## Technical data

<b>Varistor</b>	<b>RV5/50</b>	<b>RV5/133</b>	<b>RV5/250</b>	<b>RV5/440</b>
Rated control circuit voltage $U_c$	24...50 V AC	50...133 V AC	110...250 V AC	250...440 V AC
Residual overvoltage (clipping voltage)	24...50 V DC	50...133 V DC	110...250 V DC	250...440 V DC
	132 V AC	270 V AC	480 V AC	825 V AC
	132 V DC	270 V DC	480 V DC	825 V DC
Opening time growth factor	none			
Operating temperature	-20...+70 °C			
Advantages	High energy absorption: good damping - Unpolarized system			
Drawback	Clipping as from $U_{vdr}^*$ , thus voltage front up to this point			
	* $U_{vdr}$ = Varistor operating voltage (voltage dependent resistor), tolerance $\pm 10\%$			

<b>RC type</b>	<b>RC5-1/50</b>	<b>RC5-1/133</b>	<b>RC5-1/250</b>	<b>RC5-1/440</b>
Rated control circuit voltage $U_c$	24...50 V AC	50...133 V AC	110...250 V AC	250...440 V AC
Residual overvoltage (clipping voltage)	2 to 3 x $U_c$ max.			
Opening time growth factor	2...3			
Operating temperature	-20...+70 °C			
Advantages	Very fast clipping - Attenuation of steep fronts and thus of high frequencies			

<b>Transil diode</b>	<b>RT5/32</b>	<b>RT5/65</b>	<b>RT5/90</b>	<b>RT5/150</b>	<b>RT5/264</b>
Rated control circuit voltage $U_c$	12...32 V DC	25...65 V DC	50...90 V DC	77...150 V DC	150...264 V DC
Residual overvoltage (clipping voltage)	50 V DC	100 V DC	150 V DC	210 V DC	390 V DC
Opening time growth factor	1.1...1.2				
Operating temperature	-20...+70 °C				
Advantages	Good energy absorption - Unpolarized system - Simple, reliable system				
Drawback	Delay on drop out which does not however reduce contactor breaking capacity				

### Wiring diagrams

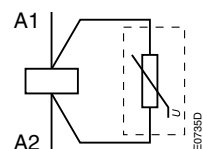

**Varistor**

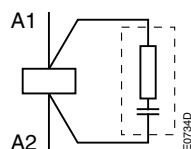

**RC type**

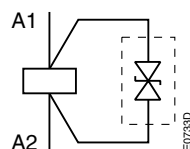

**Transil diode**

# Mechanical interlock unit and other accessories



VM3



## Mechanical interlock unit

When mounted between two contactors without additional width, the VM3 mechanical interlock unit prevents one of the contactors from closing as long as the other contactor is closed. The mechanical interlock unit includes 2 fixing clips.

### Ordering details

For contactors		Type	Order code	Pkg qty	Weight (1 pce)
<b>Left</b>	<b>Right</b>				<b>kg</b>
AS	AS	VM3	1SBN031005T1000	10	0.002
ASL	ASL				

Note : VM3 mechanical durability, 5 millions of operating cycles on both reversing contactors.

## Fixing clips

BB3 is a set of 50 fixing clips.

### Ordering details

For contactors	Type	Order code	Pkg qty	Weight (1 pce)
AS, ASL	BB3	1SBN111020R1000	1	0.009

## Test block

BDT4 test block is suitable for switching on contactor off-load. Marking on the block indicates the contactor type to fit with.

### Ordering details

For contactors	Type	Order code	Pkg qty	Weight (1 pce)
AS, ASL, NS, NSL	BDT4	1SBN110122T1000	10	0.007

## Function markers

Box of 16 blank cards (16 markers by card) printable on HTP500 thermal transfer printer and AMS 500 marking table to identify your contactors, overload relays or manual motor starters. Marker dimensions: 7 x 20 mm (.276" x .787").

### Ordering details

For contactors	Type	Order code	Pkg qty	Weight (1 pce)
AS, ASL, NS, NSL	BA4	1SNA235156R2700	16	0.011
AMS 500 support plate for 8 BA4	SPRC 1	1SNA360010R1500	1	0.220
HTP500 support plate	HTP500-BA4	1SNA235712R2400	1	0.290



BDT4



BA4

1SNC160101F0014

# Connection accessories for starting solutions

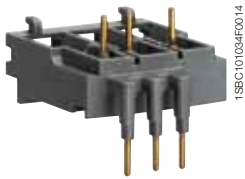

BEA16-3

1SBC101034F0014

## Connecting links

The BEA16-3 insulated 3-pole connecting links are used to connect an AC or DC operated contactors with manual motor starters.

The connecting links ensure the electrical and mechanical connection between the contactor and the manual motor starter.

## Ordering details

For contactors	Manual motor starter	Type	Order code	Pkg qty	Weight (1 pce) kg
AS09 ... AS16 ASL09 ... ASL16	MS116-0.16 ... MS116-16 MS132-0.16 ... MS132-16	BEA16-3	1SBN081006T1000	10	0.019

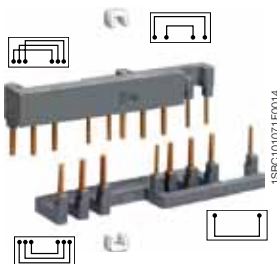

BER16C-3

1SBC101071F0014

## Connection sets for reversing contactors

The BER16C-3 connection sets are used for the connections between the main poles of two 3-pole contactors mounted side by side as reversing contactors, including electrical interlocking between built-in N.C. auxiliary contact and coil terminals.

The connection sets are made up of:

- 1 upstream and 1 downstream connections: insulated, solid copper bars,
- 2 connections to realize electrical interlocking between contactors equipped with built-in N.C. auxiliary contacts,
- 2 fixing clips.

## Ordering details

For contactors	Mechanical interlock unit	Type	Order code	Pkg qty	Weight (1 pce) kg
2 x AS09 ... AS16 2 x ASL09 ... ASL16	with or without VM3	BER16C-3	1SBN081012R1000	1	0.035

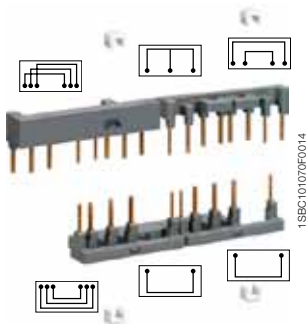

BEY16C-3

1SBC101070F0014

## Connection sets for star-delta starting

BEY16C-3 connection sets are designed for star-delta starters whose contactors are assembled according to line delta star mounting.

The connection sets are made up of:

- Line contactor / delta contactor: upstream phase-to-phase connection,
- Delta contactor / star contactor: downstream connection in parallel,
- Star contactor: star point upstream,
- An electrical interlocking between delta and star contactors equipped with built-in N.C. auxiliary contacts,
- 4 fixing clips.

## Ordering details

For contactors	Mech. interlock unit between star & delta contactors	Type	Order code	Pkg qty	Weight (1 pce) kg									
<table border="1"> <thead> <tr> <th>Line</th> <th>Delta</th> <th>Star</th> </tr> </thead> <tbody> <tr> <td>AS09</td> <td>AS09</td> <td>AS09</td> </tr> <tr> <td>AS12</td> <td>AS12</td> <td>AS09</td> </tr> </tbody> </table>	Line	Delta	Star	AS09	AS09	AS09	AS12	AS12	AS09	with or without VM3	BEY16C-3	1SBN081018R2000	1	0.041
Line	Delta	Star												
AS09	AS09	AS09												
AS12	AS12	AS09												

# Voltage code table

The below tables indicate the available coil voltages and corresponding digits for order codes. When placing an order, please give either type or order code. Select a standard contactor from ordering detail pages. Change the **coil voltage code** in the type or in the order code according to the table below. Example: for contactor AS09-30-10 and coil 42 V 50/60 Hz, type is AS09-30-10-21 and order code is 1SBL101001R2110.

## 3-pole contactors

**Type**

AS16 - 30 - 10 - 26

Auxiliary contacts  
N.O. N.C.

Main contacts  
N.O. N.C.

**Contactor type**  
AS AC operated  
ASL DC operated

**Order code**

1SBL121001R 26 10

**AC coil code**

	50 Hz	60 Hz
20	24 V	24 V
21	42 V	42 V
22	48 V	48 V
23	110 V	110 V
24	115 V	115 V
16	-	120 V
25	220 V	220 V
26	230 V	230 V
27	240 V	240 V
17	-	277 V
13	380 V	-
28	400 V	400 V
29	415 V	415 V

**DC coil code**

80	12 V
81	24 V
83	48 V
84	60 V
86	110 V
87	125 V
88	220 V
89	240 V

## 3-pole reversing contactors

**Type**

VAS12 S EM - 26 M

Surge suppressor

**Contactor type**  
VAS AC operated  
VASL DC operated

**Order code**

1SBK113800M 26 00

**AC coil code**

	50 Hz	60 Hz
20	24 V	24 V
21	42 V	42 V
22	48 V	48 V
23	110 V	110 V
24	115 V	115 V
16	-	120 V
25	220 V	220 V
26	230 V	230 V
27	240 V	240 V
17	-	277 V
13	380 V	-
28	400 V	400 V
29	415 V	415 V

**DC coil code**

80	12 V (1)
81	24 V
83	48 V
84	60 V
86	110 V
87	125 V
88	220 V
89	240 V

(1) Not for VASL..SEM

## Contactor relays

**Type**

NS 40 E - 26

N.O. N.C.  
Number contacts

**Contactor type**  
NS AC operated  
NSL DC operated

**Order code**

1SBH101001R 26 40

**AC coil code**

	50 Hz	60 Hz
20	24 V	24 V
21	42 V	42 V
22	48 V	48 V
23	110 V	110 V
24	115 V	115 V
16	-	120 V
25	220 V	220 V
26	230 V	230 V
27	240 V	240 V
17	-	277 V
13	380 V	-
28	400 V	400 V
29	415 V	415 V

**DC coil code**

80	12 V
81	24 V
83	48 V
84	60 V
86	110 V
87	125 V
88	220 V
89	240 V

# Notes

Handwriting practice area consisting of multiple horizontal dotted lines for writing.





# A, AF, EK contactors and NF contactor relays

## AF, A 3-pole contactors

Contents	5/3
Overview 3-pole contactors	5/4
Ordering details 3-pole contactors	5/6
Technical data 3-pole contactors	5/38
Terminal marking and positioning	5/55
Main dimensions	5/58

## AF, A and EK 4-pole contactors

Contents	5/91
Overview 4-pole contactors	5/92
Ordering details 4-pole contactors	5/94
Technical data 4-pole contactors	5/120
Terminal marking and positioning	5/138
Main dimensions	5/142

## Contactors for capacitor switching

Contents	5/155
Overview	5/156
UA16..RA up to UA110..RA - Unlimited peak $\hat{I}$	5/158
UA16 up to UA110 - Peak current $\hat{I} \leq 100$ times the rms current	5/167

## NF contactor relays

Contents	5/179
Ordering details	5/180
Technical data	5/188
Terminal marking and positioning	5/191
Main dimensions	5/193

## Accessories for A, AF, EK contactors and NF contactor relays

Accessories for AF09 ... AF38 contactors and NF contactor relays	5/197
Accessories for A40 ... AF2050 contactors	5/227
Accessories for EK100 ... EK1000 contactors	5/253

Voltage code table	5/267
--------------------	-------

Questionnaire for product specifications	5/270
--	-------

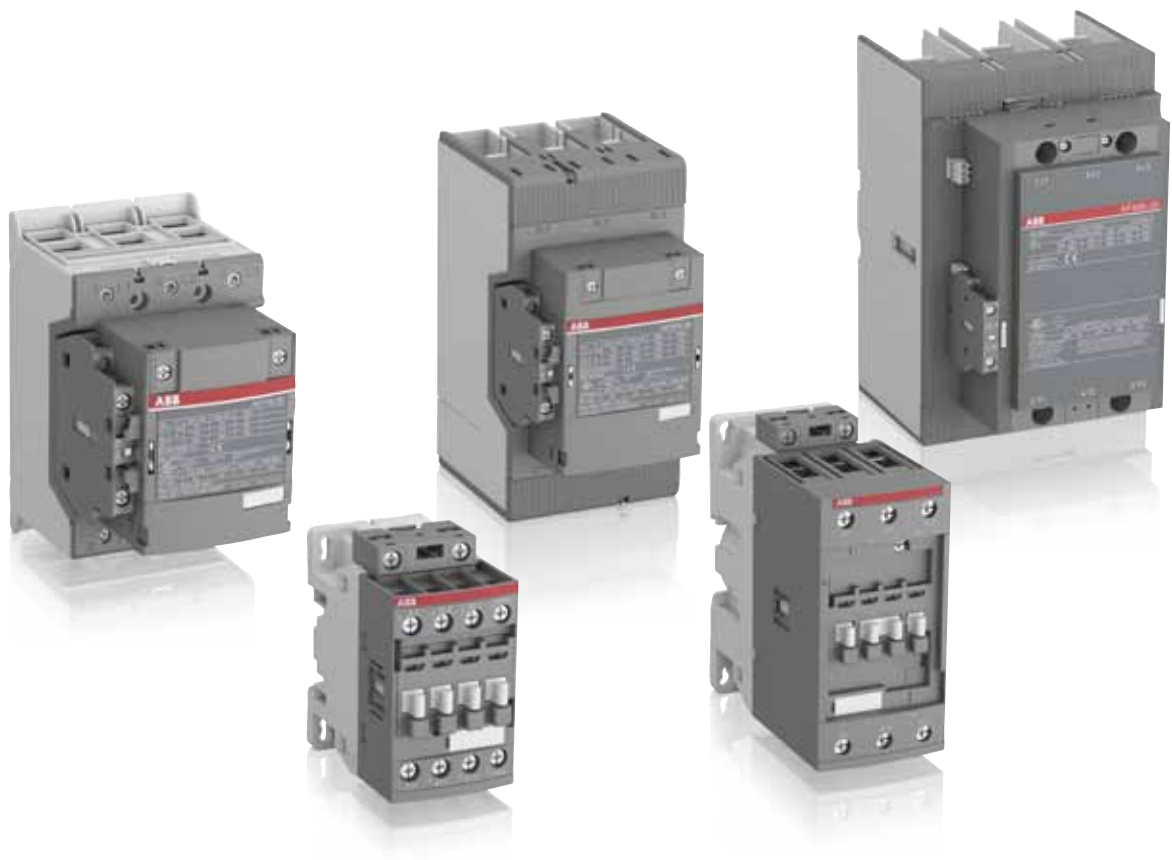

# AF, A 3-pole contactors

[Overview](#) 5/4

---

## Ordering details

### 4 to 45 kW / 5 to 60 hp

AF09 ... AF38	AC / DC operated	5/6
AF09Z ... AF38Z	AC / DC operated - low consumption	5/7
AF40 ... AF96	AC / DC operated	5/8
Main accessories		5/10

### 55 to 200 kW / 75 to 300 hp

AF116 ... AF146	AC / DC operated	5/12
AF190 ... AF370	AC / DC operated	5/13
Main accessories		5/14
AF116 ... AF146	AC / DC operated with 1 N.O. + 1 N.C.	5/16
AF190 ... AF370	AC / DC operated with 1 N.O. + 1 N.C.	5/17
Main accessories		5/18

### 200 to 560 kW / 300 to 900 hp

AF400 ... AF750	AC / DC operated with 1 N.O. + 1 N.C.	5/20
AF1250 ... AF2650	AC / DC operated with 1 N.O. + 1 N.C.	5/21
Main accessories		5/22

### 4 to 45 kW / 5 to 60 hp - 2-stack

AF09 ... AF38	AC / DC operated	5/24
AF09Z ... AF38Z	AC / DC operated - low consumption	5/25
AF40 ... AF65	AC / DC operated	5/26
AF80 ... AF96	AC / DC operated	5/27
Main accessories		5/28

### 55 to 560 kW / 75 to 900 hp

AF116 ... AF146	AC / DC operated with 2 N.O. + 2 N.C.	5/30
AF190 ... AF370	AC / DC operated with 2 N.O. + 2 N.C.	5/31
Main accessories		5/32
AF400 ... AF750	AC / DC operated with 2 N.O. + 2 N.C.	5/34
AF1250 ... AF2650	AC / DC operated with 2 N.O. + 2 N.C.	5/35
Main accessories		5/36

[Technical data](#) 5/38

---

[Terminal marking and positioning](#) 5/55

---

[Main dimensions](#) 5/58

---

[Voltage code table](#) 5/267

---

# 3-pole contactors, for motor control and power switching

5



IEC (1)	AC-3 Rated operational power	$\theta \leq 60^\circ\text{C}$ (2), 400 V	<b>kW</b>	4	5.5	7.5	11	15	18.5	18.5	22	30	37	45
UL/CSA	3-phase motor rating	480 V	<b>hp</b>	5	7.5	10	15	20	20	30	40	50	60	60
<b>AC / DC Control supply</b>														
				Type										
IEC	AC-3 Rated operational current	$\theta \leq 60^\circ\text{C}$ (2), 400 V	<b>A</b>	9	12	18	26	32	38	40	53	65	80	96
	AC-1 Rated operational current	$\theta \leq 40^\circ\text{C}$ , 690 V	<b>A</b>	25	28	30	45	50	50	70	100	105	125	130
UL/CSA	General use rating	600 V	<b>A</b>	25	28	30	45	50	50	60	80	90	105	115
NEMA	NEMA Size			00	0	—	1	—	—	2	—	—	3	—

(1) 1000 V IEC ratings available for AF146 ... AF2650 contactors.  
 (2)  $\theta \leq 55^\circ\text{C}$  for AF400 ... AF2650 contactors.

## Main accessories

<b>Auxiliary contact blocks</b>	Front mounting	<b>CA4-10</b> (1 x N.O.) <b>CA4-01</b> (1 x N.C.)
	Side mounting	<b>CAL4-11</b> (1 x N.O. + 1 x N.C.)
<b>Timers</b>	Electronic	<b>TEF4-ON</b> <b>TEF4-OFF</b>
<b>Interlocking units</b>	Mechanical	<b>VM4</b> <span style="float: right;"><b>VM96-4</b></span>
	Mechanical / Electrical	<b>VEM4</b>
<b>Connection sets</b>	For reversing contactors	<b>BER16-4</b> <span style="float: right;"><b>BER38-4</b> <b>BER65-4</b> <b>BER96-4</b></span>
<b>Surge suppressors</b>		Built-in surge protection

## Overload relays

<b>Thermal relays</b>	Class 10 (Class 10A for TF140, TA200DU)	<b>TF42</b> (0.10...32 A)	<b>TF65</b> (22...67 A)	<b>TF96</b> (40...96 A)
<b>Electronic relays</b>	Class 10E, 20E, 30E	<b>EF19</b> (0.10...19 A)	<b>EF19</b> (0.10...19 A) <b>EF45</b> (9...45 A)	<b>EF65</b> (25...70 A) <b>EF96</b> (36...100 A)

## Manual motor starters



	Thermal / magnetic protection Class 10	<b>MS116</b> (0.10...32 A) lcs up to 50 kA for class 10 A	<b>MS450</b> (28...50 A) lcs up to 50 kA
		<b>MS132</b> (0.10...32 A) lcs up to 100 kA	<b>MS495</b> (45...100 A) lcs up to 50 kA
	Magnetic only types		<b>MS497</b> (22...100 A) lcs up to 100 kA
		<b>MO132</b> (0.16...32 A) lcs up to 100 kA	<b>MO496</b> (16...100 A) lcs up to 100 kA
			<b>MO450</b> (40...50 A) lcs up to 50 kA
<b>Accessories</b>	For contactor mounting	<b>BEA16-4</b> <span style="float: right;"><b>BEA38-4</b></span>	



55	75	75	90	110	132	160	200	200	250	315	400	—	475	560	—	—
75	100	100	125	150	200	250	300	350	400	500	600	—	800	900	—	—
AF116	AF140	AF146	AF190	AF205	AF265	AF305	AF370	AF400	AF460	AF580	AF750	AF1250	AF1350	AF1650	AF2050	AF2650
116	140	146	190	205	265	305	370	400	460	580	750	—	860	1050	—	—
160	200	225	275	350	400	500	600	600	700	800	1050	1260	1350	1650	2050	2650
160	200	200	250	300	350	400	520	550	650	750	900	1210	1350	1650	2100	2700
—	4	—	—	—	5	—	—	—	6	—	7	—	—	8	—	—

5

CAL19				CAL18									
VM19 (for same size contactors)				VM750H VM750V				VM1650H					
BER140-4		BER205-4		BER370-4		BEM460-30		BEM750-30					

TF140DU (66...142 A) $\theta \leq 55^\circ\text{C}$	TA200DU (66...200 A) $\theta \leq 55^\circ\text{C}$	EF370 (115...380 A)	E500DU (150...500 A)	E800DU (250...800 A)	E1250DU (375...1250 A)
EF146 (54...150 A)	EF205 (63...210 A)				

### Short-circuit protection devices

Tmax Circuit breaker and accessories



18BEC101739S0201

# AF09 ... AF38 3-pole contactors

## 4 to 18.5 kW

### AC / DC operated



AF09-30-10



AF26-30-00

#### Description

AF09 ... AF38 contactors are mainly used for controlling 3-phase motors and power circuits up to 690 V AC and 220 V DC. These contactors are of the block type design with 3 main poles.

- control circuit: AC or DC operated with electronic coil interface accepting a wide control voltage range (e.g. 100...250 V AC and DC), only 4 control voltage ranges covering 24...500V 50/60 Hz and 20...500 V DC
- can manage large control voltage variations
- reduced panel energy consumption
- very distinct closing and opening.
- built-in surge suppression
- add-on auxiliary contact blocks for front or side mounting and a wide range of accessories.

#### Ordering details

IEC		UL/CSA		Rated control circuit voltage		Auxiliary contacts fitted	Type	Order code	Weight	
Rated operational power	current	3-phase motor rating	General use rating	Uc min. ... Uc max.						Pkg (1 pce)
400 V AC-3	$\theta \leq 40^\circ\text{C}$	480 V	600 V AC	V 50/60 Hz	V DC				kg	
4	25	5	25	24...60	-	(1)	1 0	AF09-30-10-41	1SBL137001R4110	0.270
				48...130	48...130	1 0	0 1	AF09-30-01-41	1SBL137001R4101	0.270
						1 0	0 1	AF09-30-10-12	1SBL137001R1210	0.270
						1 0	0 1	AF09-30-01-12	1SBL137001R1201	0.270
						1 0	0 1	AF09-30-10-13	1SBL137001R1310	0.270
5.5	28	7.5	28	24...60	-	(1)	1 0	AF12-30-10-41	1SBL157001R4110	0.270
				48...130	48...130	1 0	0 1	AF12-30-01-41	1SBL157001R4101	0.270
						1 0	0 1	AF12-30-10-12	1SBL157001R1210	0.270
						1 0	0 1	AF12-30-01-12	1SBL157001R1201	0.270
						1 0	0 1	AF12-30-10-13	1SBL157001R1310	0.270
7.5	30	10	30	24...60	-	(1)	1 0	AF16-30-10-41	1SBL177001R4110	0.270
				48...130	48...130	1 0	0 1	AF16-30-01-41	1SBL177001R4101	0.270
						1 0	0 1	AF16-30-10-12	1SBL177001R1210	0.270
						1 0	0 1	AF16-30-01-12	1SBL177001R1201	0.270
						1 0	0 1	AF16-30-10-13	1SBL177001R1310	0.270
11	45	15	45	24...60	-	(1)	0 0	AF26-30-00-41	1SBL237001R4100	0.310
				48...130	48...130	0 0	0 0	AF26-30-00-12	1SBL237001R1200	0.310
						0 0	0 0	AF26-30-00-13	1SBL237001R1300	0.310
						0 0	0 0	AF26-30-00-14	1SBL237001R1400	0.350
						0 0	0 0	AF26-30-00-14	1SBL237001R1400	0.350
15	50	20	50	24...60	-	(1)	0 0	AF30-30-00-41	1SBL277001R4100	0.310
				48...130	48...130	0 0	0 0	AF30-30-00-12	1SBL277001R1200	0.310
						0 0	0 0	AF30-30-00-13	1SBL277001R1300	0.310
						0 0	0 0	AF30-30-00-14	1SBL277001R1400	0.350
						0 0	0 0	AF30-30-00-14	1SBL277001R1400	0.350
18.5	50	20	50	24...60	-	(1)	0 0	AF38-30-00-41	1SBL297001R4100	0.310
				48...130	48...130	0 0	0 0	AF38-30-00-12	1SBL297001R1200	0.310
						0 0	0 0	AF38-30-00-13	1SBL297001R1300	0.310
						0 0	0 0	AF38-30-00-14	1SBL297001R1400	0.350
						0 0	0 0	AF38-30-00-14	1SBL297001R1400	0.350

(1) For 24...60 V 50/60 Hz - 20...60 V DC, use AF.-30-...-11 (see voltage code table).  
AF.-30-...-11 not suitable for direct control by PLC-output.

#### Main dimensions mm, inches

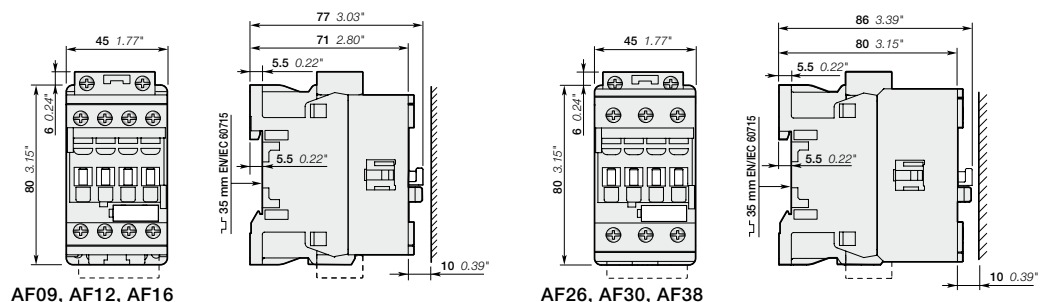

# AF09Z ... AF38Z 3-pole contactors

## 4 to 18.5 kW

### AC / DC operated - low consumption



AF09Z-30-10

1SBC101011W014



AF26Z-30-00



1SBC101001W014

#### Description

AF09Z ... AF38Z contactors are mainly used for controlling 3-phase motors and power circuits up to 690 V AC and 220 V DC. These contactors are of the block type design with 3 main poles.

- control circuit: AC or DC operated with electronic coil interface accepting a wide control voltage range (e.g. 100...250 V AC and DC), only 4 control voltage ranges covering 24...250 V 50/60 Hz and 12...250 V DC
- can manage large control voltage variations
- allow direct control by PLC-output  $\geq 24$  V DC 500 mA
- reduced panel energy consumption
- very distinct closing and opening
- can withstand short voltage dips and voltage sags (SEMI F47-0706 conditions of use on request).
- built-in surge suppression
- add-on auxiliary contact blocks for front or side mounting and a wide range of accessories.

#### Ordering details

IEC Rated power kW	operational current A $\theta \leq 40^\circ\text{C}$	UL/CSA 3-phase motor rating 480 V hp	General use rating 600 V AC A	Rated control circuit voltage Uc min. ... Uc max.		Auxiliary contacts fitted		Type	Order code	Weight Pkg (1 pce) kg						
				V 50/60 Hz	V DC											
4	25	5	25	-	12...20	1	0	AF09Z-30-10-20	1SBL136001R2010	0.310						
						0	1	AF09Z-30-01-20	1SBL136001R2001	0.310						
						1	0	AF09Z-30-10-21	1SBL136001R2110	0.310						
						0	1	AF09Z-30-01-21	1SBL136001R2101	0.310						
						1	0	AF09Z-30-10-22	1SBL136001R2210	0.310						
						0	1	AF09Z-30-01-22	1SBL136001R2201	0.310						
						1	0	AF09Z-30-10-23	1SBL136001R2310	0.310						
						0	1	AF09Z-30-01-23	1SBL136001R2301	0.310						
						5.5	28	7.5	28	-	12...20	1	0	AF12Z-30-10-20	1SBL156001R2010	0.310
												0	1	AF12Z-30-01-20	1SBL156001R2001	0.310
1	0	AF12Z-30-10-21	1SBL156001R2110	0.310												
0	1	AF12Z-30-01-21	1SBL156001R2101	0.310												
1	0	AF12Z-30-10-22	1SBL156001R2210	0.310												
0	1	AF12Z-30-01-22	1SBL156001R2201	0.310												
1	0	AF12Z-30-10-23	1SBL156001R2310	0.310												
0	1	AF12Z-30-01-23	1SBL156001R2301	0.310												
7.5	30	10	30	-	12...20							1	0	AF16Z-30-10-20	1SBL176001R2010	0.310
												0	1	AF16Z-30-01-20	1SBL176001R2001	0.310
						1	0	AF16Z-30-10-21	1SBL176001R2110	0.310						
						0	1	AF16Z-30-01-21	1SBL176001R2101	0.310						
						1	0	AF16Z-30-10-22	1SBL176001R2210	0.310						
						0	1	AF16Z-30-01-22	1SBL176001R2201	0.310						
						1	0	AF16Z-30-10-23	1SBL176001R2310	0.310						
						0	1	AF16Z-30-01-23	1SBL176001R2301	0.310						
						11	45	15	45	-	12...20	0	0	AF26Z-30-00-20	1SBL236001R2000	0.350
												0	0	AF26Z-30-00-21	1SBL236001R2100	0.350
0	0	AF26Z-30-00-22	1SBL236001R2200	0.350												
0	0	AF26Z-30-00-23	1SBL236001R2300	0.350												
15	50	20	50	-	12...20	0	0	AF30Z-30-00-20	1SBL276001R2000	0.350						
						0	0	AF30Z-30-00-21	1SBL276001R2100	0.350						
						0	0	AF30Z-30-00-22	1SBL276001R2200	0.350						
						0	0	AF30Z-30-00-23	1SBL276001R2300	0.350						
18.5	50	20	50	-	12...20	0	0	AF38Z-30-00-20	1SBL296001R2000	0.350						
						0	0	AF38Z-30-00-21	1SBL296001R2100	0.350						
						0	0	AF38Z-30-00-22	1SBL296001R2200	0.350						
						0	0	AF38Z-30-00-23	1SBL296001R2300	0.350						

Note: Only AF.Z contactors with DC control voltage 12...20 V DC need to respect the connection polarities indicated close to the coil terminals: A1+ for the positive pole and A2- for the negative pole.

#### Main dimensions mm, inches

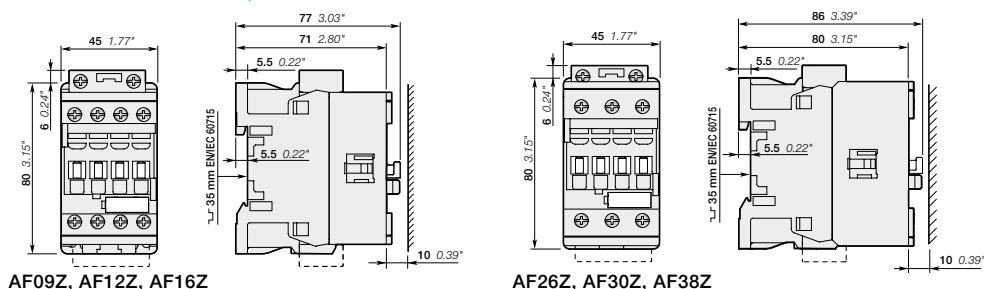

AF09Z, AF12Z, AF16Z

AF26Z, AF30Z, AF38Z

1SBC101372S0201 - Rev. A



# AF40 ... AF96 3-pole contactors

## 18.5 to 45 kW

### AC / DC operated



AF40-30-00

1SBC101014V0014

#### Description

AF40 ... AF96 contactors are mainly used for controlling 3-phase motors and power circuits up to 690 V AC and 220 V DC. These contactors are of the block type design with 3 main poles.

- control circuit: AC or DC operated with electronic coil interface accepting a wide control voltage range (e.g. 100...250 V AC and DC), only 4 control voltage ranges covering 24...500 V 50/60 Hz and 20...500 V DC
- can manage large control voltage variations
- reduced panel energy consumption
- very distinct closing and opening.
- built-in surge suppression
- add-on auxiliary contact blocks for front or side mounting and a wide range of accessories.

#### Ordering details

IEC Rated operational power 400 V AC-3 kW	UL / CSA 3-phase motor rating 480 V AC-1 A	General use rating 600 V AC hp	General use rating 600 V AC A	Rated control circuit voltage Uc min. ... Uc max.		Auxiliary contacts fitted	Type	Order code	Weight Pkg (1 pce) kg
				V 50/60 Hz	V DC				
18.5	70	30	60	24...60	-	0 0	AF40-30-00-41	1SBL347001R4100	0.970
				24...60	20...60 (1)	0 0	AF40-30-00-11	1SBL347001R1100	0.970
				48...130	48...130	0 0	AF40-30-00-12	1SBL347001R1200	0.970
				100...250	100...250	0 0	AF40-30-00-13	1SBL347001R1300	0.950
				250...500	250...500	0 0	AF40-30-00-14	1SBL347001R1400	0.950
22	100	40	80	24...60	-	0 0	AF52-30-00-41	1SBL367001R4100	0.970
				24...60	20...60 (1)	0 0	AF52-30-00-11	1SBL367001R1100	0.970
				48...130	48...130	0 0	AF52-30-00-12	1SBL367001R1200	0.970
				100...250	100...250	0 0	AF52-30-00-13	1SBL367001R1300	0.950
				250...500	250...500	0 0	AF52-30-00-14	1SBL367001R1400	0.950
30	105	50	90	24...60	-	0 0	AF65-30-00-41	1SBL387001R4100	0.970
				24...60	20...60 (1)	0 0	AF65-30-00-11	1SBL387001R1100	0.970
				48...130	48...130	0 0	AF65-30-00-12	1SBL387001R1200	0.970
				100...250	100...250	0 0	AF65-30-00-13	1SBL387001R1300	0.950
				250...500	250...500	0 0	AF65-30-00-14	1SBL387001R1400	0.950
37	125	60	105	24...60	-	0 0	AF80-30-00-41	1SBL397001R4100	1.220
				24...60	20...60 (1)	0 0	AF80-30-00-11	1SBL397001R1100	1.220
				48...130	48...130	0 0	AF80-30-00-12	1SBL397001R1200	1.220
				100...250	100...250	0 0	AF80-30-00-13	1SBL397001R1300	1.170
				250...500	250...500	0 0	AF80-30-00-14	1SBL397001R1400	1.170
45	130	60	115	24...60	-	0 0	AF96-30-00-41	1SBL407001R4100	1.220
				24...60	20...60 (1)	0 0	AF96-30-00-11	1SBL407001R1100	1.220
				48...130	48...130	0 0	AF96-30-00-12	1SBL407001R1200	1.220
				100...250	100...250	0 0	AF96-30-00-13	1SBL407001R1300	1.170
				250...500	250...500	0 0	AF96-30-00-14	1SBL407001R1400	1.170

(1) AF.-30-...-11 not suitable for direct control by PLC-output.

#### Main dimensions mm, inches

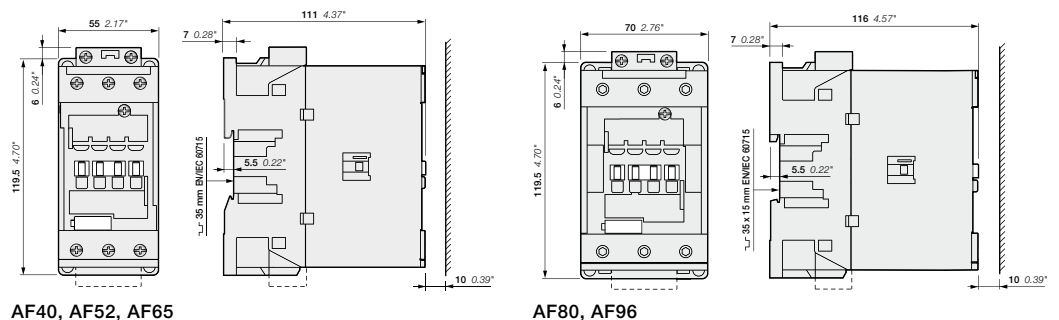

AF40, AF52, AF65

AF80, AF96

1SBC101740S0201



# Notes

A series of horizontal dotted lines for writing notes, spanning the width of the page.

# AF09 ... AF96 3-pole contactors

## Main accessories

### Contactor and main accessories (other accessories available)

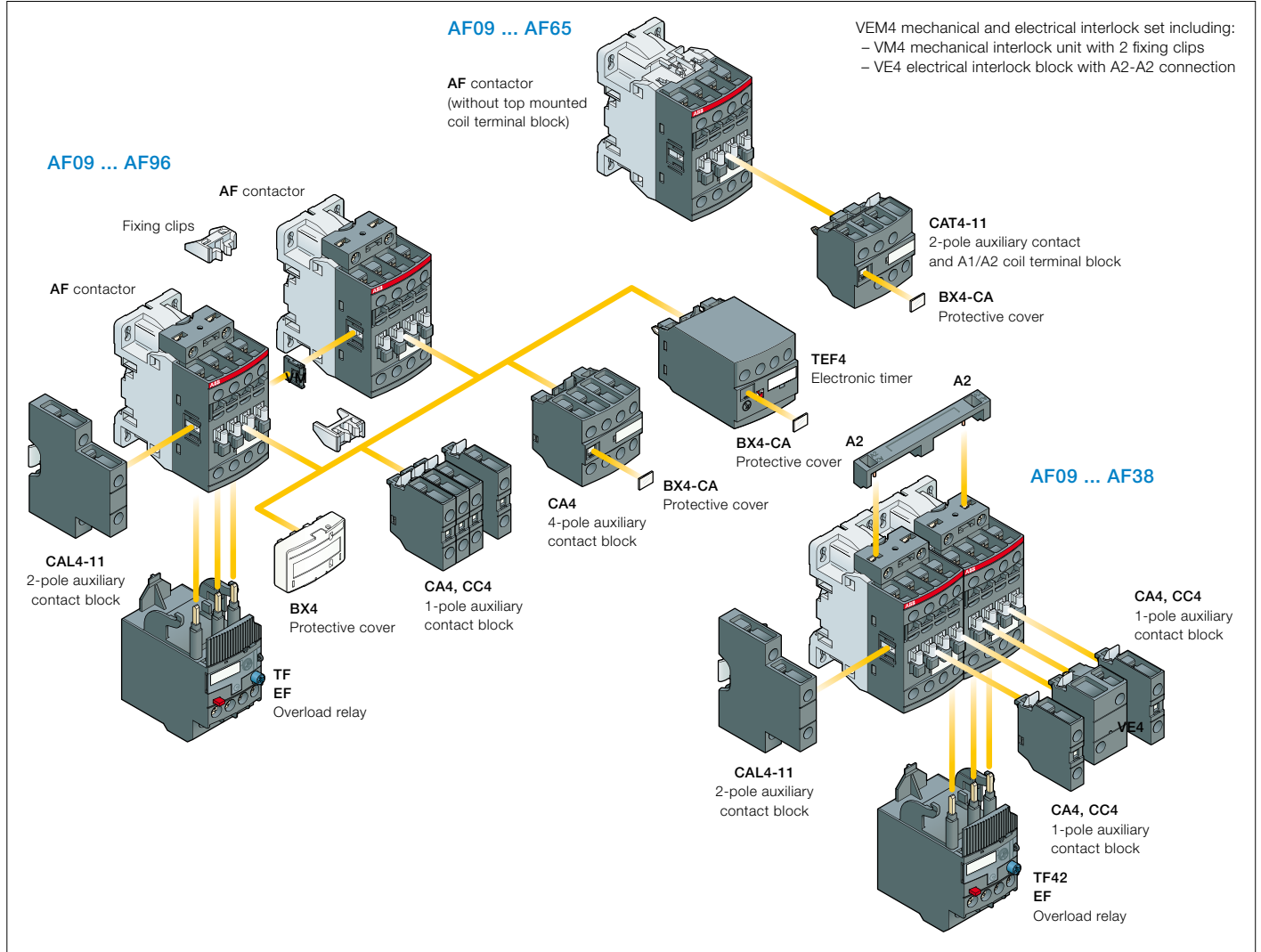

### Main accessory fitting details

Many configurations of accessories are possible depending on whether these are front-mounted or side-mounted.

Contactor types	Main poles	Built-in auxiliary contacts	Front-mounted accessories				Electronic timer	Electrical and mechanical interlock set (between 2 contactors)	Side-mounted accessories		
			Auxiliary contact blocks			TEF4			VEM4	Left side	Right side
			1-pole CA4	1-pole CC4	2-pole CAT4-11	4-pole CA4			2-pole CAL4-11		
Max. N.C. built-in and add-on N.C. auxiliary contacts: 4 N.C. max. on positions 1, 2, 3, 4 and 3 N.C. max. on positions 1 ±30°, 5											
AF09 ... AF16	3	0	0	1	4 max.	or 1	or 1	or 1	-	+ 1	-
AF09 ... AF16	3	0	1	0	2 max.	or 1	-	or 1	-	+ 1	+ 1
AF26 ... AF38	3	0	0	0	3 max.	-	-	-	+ 1	+ 1	or 1
AF40 ... AF65	3	0	0	0	4 max.	or 1	or 1	or 1	-	+ 1	+ 1
AF80, AF96	3	0	0	0	4 max.	-	or 1	or 1	-	+ 1	+ 1

### Overload relays fitting details (1)

Contactor types	Thermal overload relays	Electronic overload relays
AF09 ... AF38	TF42 (0.10...38 A)	EF19 (0.10...19 A)
AF26 ... AF38	TF42 (0.10...38 A)	EF45 (9...45 A)
AF40 ... AF65	TF65 (22...67 A)	EF65 (25...70 A)
AF80, AF96	TF96 (40...96 A)	EF96 (36...100 A)

The addition of an overload relay on the contactor does not prevent fitting of many other accessories as shown above.

(1) Direct mounting - No kit required.

# AF09 ... AF96 3-pole contactors

## Main accessories



CA4-10



CAL4-11



CA4-22E



CAT4-11E



VEM4

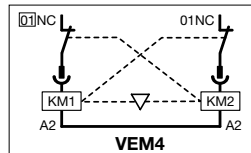

TEF4-ON



BEA16-4

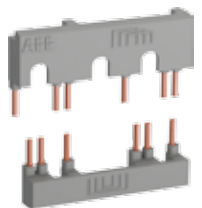

BER16-4

### Ordering details (1)

For contactors	Auxiliary contacts	Type	Order code	Pkg qty	Weight (1 pce)
					kg

#### Front-mounted instantaneous auxiliary contact blocks

AF09 ... AF96	1 0	--	CA4-10	1SBN010110R1010	1	0.014
	1 0	--	CA4-10-T	1SBN010110T1010	10	0.014
	0 1	--	CA4-01	1SBN010110R1001	1	0.014
	0 1	--	CA4-01-T	1SBN010110T1001	10	0.014
AF09 ... AF16...-30-10	2 2	--	CA4-22M	1SBN010140R1122	1	0.055
AF26 ... AF96...-30-00	2 2	--	CA4-22E	1SBN010140R1022	1	0.055
AF09 ... AF16...-30-01	2 2	--	CA4-22U	1SBN010140R1322	1	0.055

#### Front-mounted auxiliary contact blocks with N.O. leading contact and N.C. lagging contact

AF09 ... AF96	--	1 0	CC4-10	1SBN010111R1010	1	0.014
	--	0 1	CC4-01	1SBN010111R1001	1	0.014

#### Side-mounted instantaneous auxiliary contact blocks

AF09 ... AF96	1 1	--	CAL4-11	1SBN010120R1011	1	0.040
	1 1	--	CAL4-11-T	1SBN010120T1011	10	0.040

#### Front-mounted instantaneous auxiliary contact and A1/A2 coil terminal blocks

AF09 ... AF16...-30-10	1 1	--	CAT4-11M	1SBN010151R1111	1	0.040
AF26 ... AF65...-30-00	1 1	--	CAT4-11E	1SBN010151R1011	1	0.040
AF09 ... AF16...-30-01	1 1	--	CAT4-11U	1SBN010151R1311	1	0.040

Note: CAT4 not suitable for AF...Z contactors with DC control voltage 12...20 V DC.

#### Mechanical interlock unit

AF09 ... AF38			VM4	1SBN030105T1000	10	0.005
AF40 ... AF96			VM96-4	1SBN033405T1000	10	0.006

Note: VM4 and VM96-4 include 2 fixing clips (BB4) to maintain together both contactors.

#### Mechanical and electrical interlock set

AF09 ... AF16	0 2	--	VEM4	1SBN030111R1000	1	0.035
AF26 ... AF38						

Note: - VEM4 includes a VM4 mechanical interlock unit with 2 fixing clips (BB4), a VE4 electrical interlock block. VE4 block must be used with A2-A2 connection to respect the electrical connection diagram.  
- VEM4 not suitable for AF...Z contactors with DC control voltage 12...20 V DC.

For contactors	Time delay range	Delay type	Auxiliary contacts	Type	Order code	Pkg qty	Weight (1 pce)
	selected by switch						kg

#### Electronic timers

AF09 ... AF96	0.1...1 s 1...10 s 10...100 s	ON-delay	1 1	TEF4-ON	1SBN020112R1000	1	0.065
		OFF-delay	1 1	TEF4-OFF	1SBN020114R1000	1	0.065

Note: Rated control circuit voltage U<sub>c</sub> 24...240 V 50/60 Hz or DC.

#### Connecting links with manual motor starters

AF09 ... AF16	with	MS116-0.16 ... MS116-25, MS132-0.16 ... MS132-25		BEA16-4	1SBN081306T1000	10	0.025
AF26 ... AF38	with	MS116-0.16 ... MS116-16, MS132-0.16 ... MS132-10		BEA26-4	1SBN082306T1000	10	0.025
		MS116-20 ... MS116-32, MS132-12 ... MS132-32		BEA38-4	1SBN082306T2000	10	0.030

#### Connection sets for reversing contactors

AF09 ... AF16				BER16-4	1SBN081311R1000	1	0.045
AF26 ... AF38				BER38-4	1SBN082311R1000	1	0.100
AF40 ... AF65				BER65-4	1SBN083411R1000	1	0.175
AF80 ... AF96				BER96-4	1SBN083911R1000	1	0.250

#### Connection sets for star-delta starting

AF09 ... AF16	With or without VM4			BEY16-4	1SBN081313R2000	1	0.050
AF26 ... AF38	With or without VM4			BEY38-4	1SBN082713R2000	1	0.110
AF40 ... AF65	With or without VM96-4			BEY65-4	1SBN083413R2000	1	0.200
AF80 ... AF96	With or without VM96-4			BEY96-4	1SBN083913R2000	1	0.250

(1) For more information, refer to "Accessories" section.

# AF116 ... AF146 3-pole contactors

## 55 to 75 kW

### AC / DC operated



AF146-30-00

1SFC101008V0001



AF146-30-00B

1SFC101008V0001

#### Description

AF116 ... AF140 contactors are mainly used for controlling 3-phase motors and power circuits up to 690 V AC, AF146 up to 1000 V AC. These contactors are of the block type design with 3 main poles.

- control circuit: AC or DC operated with electronic coil interface accepting a wide control voltage range (e.g. 100...250 V AC and DC), only 3 coils to cover control voltages between 24...250 V 50/60 Hz and 20...250 V DC
- can manage large control voltage variations
- reduced panel energy consumption
- very distinct closing and opening
- can withstand short voltage dips and voltage sags (SEMI F47 conditions of use on request).
- built-in surge suppression
- add-on auxiliary contact blocks for side mounting and a wide range of accessories.

#### Ordering details

IEC	UL / CSA		Rated control circuit voltage		Auxiliary contacts fitted	Type	Order code	Weight
Rated operational power	current	3-phase motor rating	General use rating	Uc min. ... Uc max.				Pkg (1 pce)
400 V AC-3	AC-1	480 V	600 V AC	V 50/60 Hz; V DC				kg
kW	A	hp	A		Y Y			

#### For connection with built-in cable clamps

55	160	75	160	24...60	20...60	0 0	AF116-30-00-11	1SFL427001R1100	1.750
				48...130	48...130	0 0	AF116-30-00-12	1SFL427001R1200	1.750
				100...250	100...250	0 0	AF116-30-00-13	1SFL427001R1300	1.750
75	200	100	200	24...60	20...60	0 0	AF140-30-00-11	1SFL447001R1100	1.750
				48...130	48...130	0 0	AF140-30-00-12	1SFL447001R1200	1.750
				100...250	100...250	0 0	AF140-30-00-13	1SFL447001R1300	1.750
75	225	100	200	24...60	20...60	0 0	AF146-30-00-11	1SFL467001R1100	1.750
				48...130	48...130	0 0	AF146-30-00-12	1SFL467001R1200	1.750
				100...250	100...250	0 0	AF146-30-00-13	1SFL467001R1300	1.750

#### With bar connections

55	160	75	160	24...60	20...60	0 0	AF116-30-00B-11	1SFL427002R1100	1.500
				48...130	48...130	0 0	AF116-30-00B-12	1SFL427002R1200	1.500
				100...250	100...250	0 0	AF116-30-00B-13	1SFL427002R1300	1.500
75	200	100	200	24...60	20...60	0 0	AF140-30-00B-11	1SFL447002R1100	1.500
				48...130	48...130	0 0	AF140-30-00B-12	1SFL447002R1200	1.500
				100...250	100...250	0 0	AF140-30-00B-13	1SFL447002R1300	1.500
75	225	100	200	24...60	20...60	0 0	AF146-30-00B-11	1SFL467002R1100	1.500
				48...130	48...130	0 0	AF146-30-00B-12	1SFL467002R1200	1.500
				100...250	100...250	0 0	AF146-30-00B-13	1SFL467002R1300	1.500

#### Main dimensions mm, inches

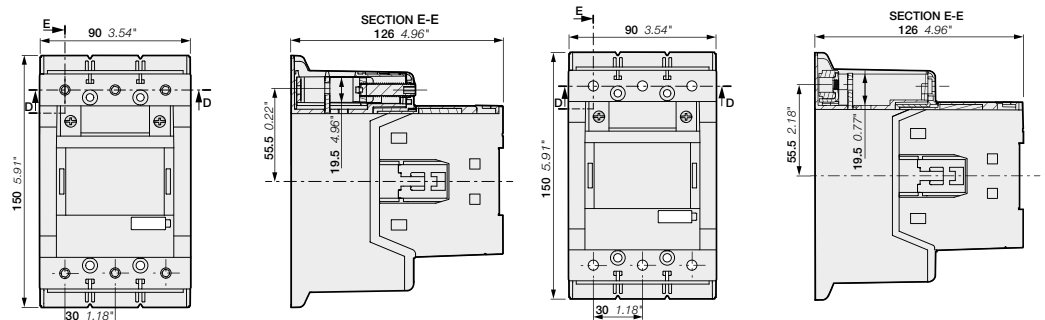

AF116, AF140, AF146-30-00

AF116, AF140, AF146-30-00B

# AF190 ... AF370 3-pole contactors

## 90 to 200 kW

### AC / DC operated



1SFC101095X0001

AF205-30-00



1SFC101097V0001

AF370-30-00

#### Description

AF190 ... AF370 contactors are mainly used for controlling 3-phase motors and power circuits up to 1000 V AC. These contactors are of the block type design with 3 main poles.

- control circuit: AC or DC operated with electronic coil interface accepting a wide control voltage range (e.g. 100...250 V AC and DC), only 3 coils to cover control voltages between 24...250 V 50/60 Hz and 20...250 V DC
- can manage large control voltage variations
- reduced panel energy consumption
- very distinct closing and opening
- can withstand short voltage dips and voltage sags (SEMI F47 conditions of use on request).
- built-in surge suppression
- add-on auxiliary contact blocks for side mounting and a wide range of accessories.

#### Ordering details

IEC	UL / CSA		Rated control circuit voltage Uc min. ... Uc max.	Auxiliary contacts fitted	Type	Order code	Weight		
	Rated operational power	Rated current $\theta \leq 40^\circ\text{C}$						3-phase motor rating 480 V	General use rating 600 V AC
400 V AC-3	AC-1	hp	A	V 50/60 Hz	V DC		kg		
90	275	125	250	24...60	20...60	0 0	AF190-30-00-11	1SFL487002R1100	3.000
				48...130	48...130	0 0	AF190-30-00-12	1SFL487002R1200	3.000
				100...250	100...250	0 0	AF190-30-00-13	1SFL487002R1300	3.000
110	350	150	300	24...60	20...60	0 0	AF205-30-00-11	1SFL527002R1100	3.000
				48...130	48...130	0 0	AF205-30-00-12	1SFL527002R1200	3.000
				100...250	100...250	0 0	AF205-30-00-13	1SFL527002R1300	3.000
140	400	200	350	24...60	20...60	0 0	AF265-30-00-11	1SFL547002R1100	4.605
				48...130	48...130	0 0	AF265-30-00-12	1SFL547002R1200	4.605
				100...250	100...250	0 0	AF265-30-00-13	1SFL547002R1300	4.605
160	50	250	400	24...60	20...60	0 0	AF305-30-00-11	1SFL587002R1100	4.605
				48...130	48...130	0 0	AF305-30-00-12	1SFL587002R1200	4.605
				100...250	100...250	0 0	AF305-30-00-13	1SFL587002R1300	4.605
200	600	350	520	24...60	20...60	0 0	AF370-30-00-11	1SFL607002R1100	4.605
				48...130	48...130	0 0	AF370-30-00-12	1SFL607002R1200	4.605
				100...250	100...250	0 0	AF370-30-00-13	1SFL607002R1300	4.605

#### Main dimensions mm, inches

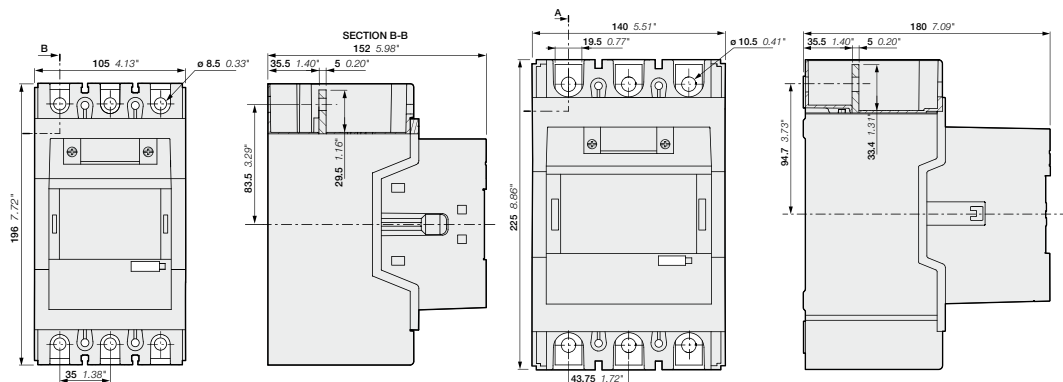

AF190, AF205

AF265, AF305, AF370

1SFC101089C0201

# AF116 ... AF370 3-pole contactors

## Main accessories

Main accessories (other accessories available)

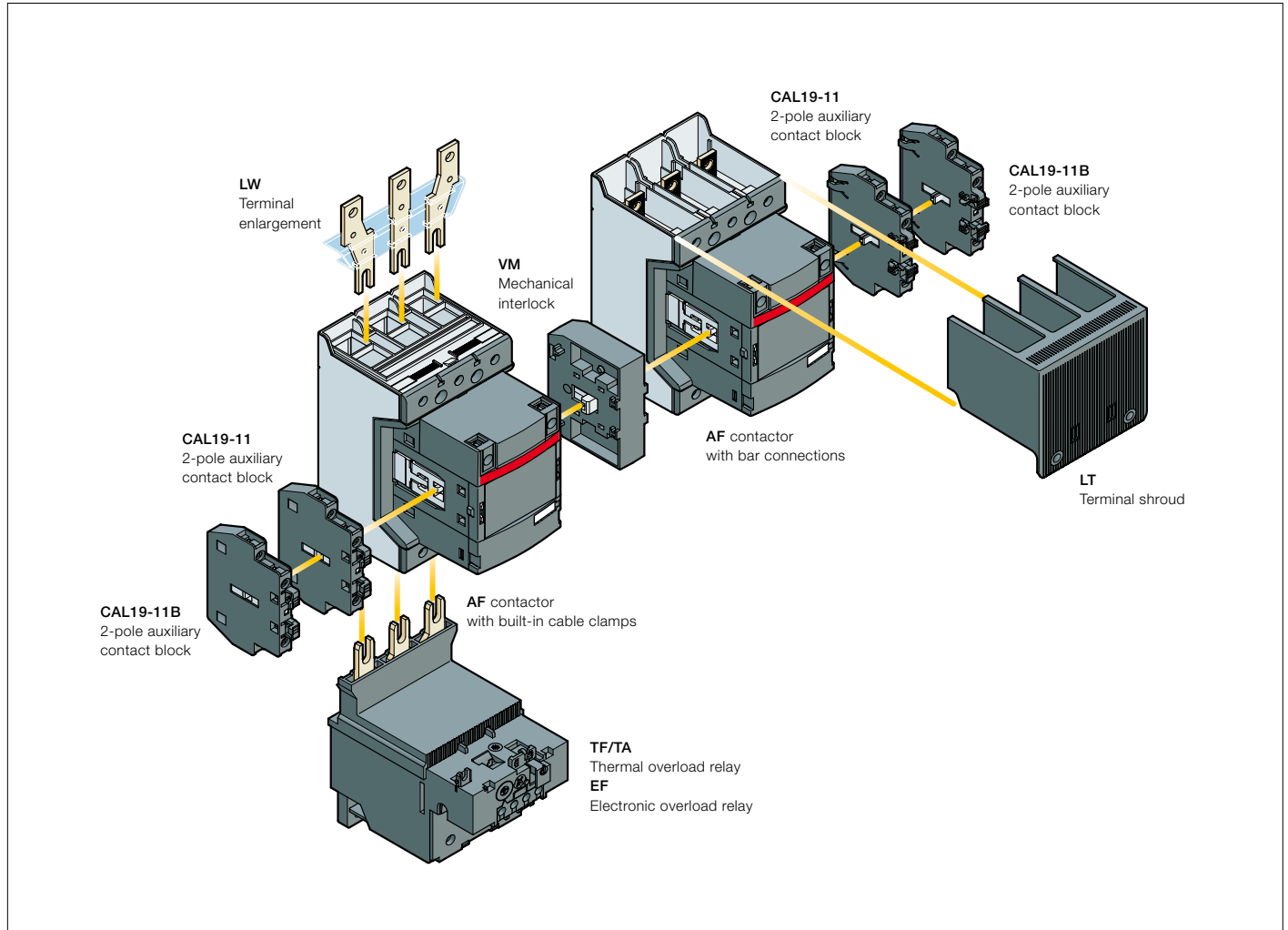

### Main accessory fitting details

Contactor types	Main poles	Available auxiliary contacts	Side-mounted accessories		
			Auxiliary contact blocks		Mechanical interlock units (between two contactors)
			CAL19-11	CAL19-11B	
AF116 ... AF370	3	0 0 0	2 x CAL19-11	+ 2 x CAL19-11B	-
AF116 ... AF370	3	0 0 0	2 x CAL19-11 (1)	+ 2 x CAL19-11B (1)	+ VM... (2)

(1) Total number of auxiliary contact blocks for the two contactors.

(2) Interlock type, according to the contactor ratings (see "Accessories").

### Overload relays fitting details (1)

Contactor types	Thermal overload relays	Electronic overload relays
	AF116 ... AF140	TF140DU (66...142 A)
AF146	-	EF146 (54...150 A)
AF190, AF205	TA200DU (66...200 A)	EF205 (63...210 A)
AF265 ... AF370	-	EF370 (115...380 A)

The addition of a thermal or electronic overload relay on the contactor does not prevent fitting of many other accessories as shown in "Main accessory fitting details" table.

(1) Direct mounting - No kit required.

# AF116 ... AF370 3-pole contactors

## Main accessories



1SFC101071V0001

CAL19-11



1SFC101035V0001

VM19



1SFC101041V0001

LT370-30C



1SFC101049V0001

LX140

### Ordering details (1)

For contactors	Auxiliary contacts	Type	Order code	Pkg qty	Weight (1 pce)
					kg

### Side-mounted instantaneous auxiliary contact blocks

AF116 ... AF370	1	1	CAL19-11	1SFN010820R1011	2	0.050
	1	1	CAL19-11B	1SFN010820R3311	2	0.050

### Mechanical interlock unit

AF116 ... AF370		VM19	1SFN030300R1000	1	0.054
AF116 ... AF146 and AF190, AF205		VM140/190	1SFN034403R1000	1	0.088
AF190, AF205 and AF265 ... AF370		VM205/265	1SFN035203R1000	1	0.090

### Terminal shrouds

AF116 ... AF146, with compression lugs		LT140-30L	1SFN124203R1000	2	0.070
AF190, AF205, with cable clamps		LT205-30C	1SFN124801R1000	2	0.050
AF190, AF205, with compression lugs		LT205-30L	1SFN124803R1000	2	0.220
AF190, AF205, with shorting bar or between contactor and TOL/EOL in DOL-starters		LT205-30Y	1SFN124804R1000	1	0.050
AF265 ... AF370, with cable clamps		LT370-30C	1SFN125401R1000	2	0.035
AF265 ... AF370, with compression lugs		LT370-30L	1SFN125403R1000	2	0.280
AF265 ... AF370, with shorting bar or between contactor and TOL/EOL in DOL-starters		LT370-30Y	1SFN125404R1000	1	0.075
AF265 ... AF370, for use with extending cable clamps, ATK300/2 and OZXB4		LT370-30D	1SFN125406R1000	1	0.150

For contactors	Dimensions		Type	Order code	Pkg qty	Weight (1 pce)
	hole Ø mm	bar mm				kg

### Terminal enlargements

AF116...AF146	6.5	13 x 3	LW140	1SFN074207R1000	1	0.115
AF190...AF205	10.5	17.5 x 5	LW205	1SFN074807R1000	1	0.260
AF265...AF370	10.5	20 x 5	LW370	1SFN075407R1000	1	0.340

### Terminal extension

AF116...AF146	6.5	13 x 3	LX140	1SFN074210R1000	1	0.072
AF190...AF250	8.5	17.5 x 5	LX205	1SFN074810R1000	1	0.180
AF265...AF370	10.5	20 x 5	LX370	1SFN075410R1000	1	0.234

(1) For more information, refer to "Accessories" section.



# AF116 ... AF146 3-pole contactors

55 to 75 kW

AC / DC operated with 1 N.O. + 1 N.C. auxiliary contacts



AF146-30-11

1SFC101008V0001



AF146-30-11B

1SFC101008V0001

## Description

AF116 ... AF140 contactors are mainly used for controlling 3-phase motors and power circuits up to 690 V AC, AF146 up to 1000 V AC. These contactors are of the block type design with 3 main poles.

- control circuit: AC or DC operated with electronic coil interface accepting a wide control voltage range (e.g. 100...250 V AC and DC), only 3 coils to cover control voltages between 24...250 V 50/60 Hz and 20...250 V DC
- can manage large control voltage variations
- reduced panel energy consumption
- very distinct closing and opening
- can withstand short voltage dips and voltage sags (SEMI F47 conditions of use on request).
- built-in surge suppression
- add-on auxiliary contact blocks for side mounting and a wide range of accessories.

## Ordering details

IEC	UL / CSA		Rated control circuit voltage		Auxiliary contacts fitted	Type	Order code	Weight
Rated operational power	3-phase motor rating	General use rating	Uc min. ... Uc max.					Pkg (1 pce)
400 V AC-3 kW	480 V AC-1 hp	600 V AC A	V 50/60 Hz	V DC				kg

### For connection with built-in cable clamps

55	160	75	160	24...60	20...60	1	1	AF116-30-11-11	1SFL427001R1111	1.750
				48...130	48...130	1	1	AF116-30-11-12	1SFL427001R1211	1.750
				100...250	100...250	1	1	AF116-30-11-13	1SFL427001R1311	1.750
75	200	100	200	24...60	20...60	1	1	AF140-30-11-11	1SFL447001R1111	1.750
				48...130	48...130	1	1	AF140-30-11-12	1SFL447001R1211	1.750
				100...250	100...250	1	1	AF140-30-11-13	1SFL447001R1311	1.750
75	225	100	200	24...60	20...60	1	1	AF146-30-11-11	1SFL467001R1111	1.750
				48...130	48...130	1	1	AF146-30-11-12	1SFL467001R1211	1.750
				100...250	100...250	1	1	AF146-30-11-13	1SFL467001R1311	1.750

### With bar connections

55	160	75	160	24...60	20...60	1	1	AF116-30-11B-11	1SFL427002R1111	1.500
				48...130	48...130	1	1	AF116-30-11B-12	1SFL427002R1211	1.500
				100...250	100...250	1	1	AF116-30-11B-13	1SFL427002R1311	1.500
75	200	100	200	24...60	20...60	1	1	AF140-30-11B-11	1SFL447002R1111	1.500
				48...130	48...130	1	1	AF140-30-11B-12	1SFL447002R1211	1.500
				100...250	100...250	1	1	AF140-30-11B-13	1SFL447002R1311	1.500
75	225	100	200	24...60	20...60	1	1	AF146-30-11B-11	1SFL467002R1111	1.500
				48...130	48...130	1	1	AF146-30-11B-12	1SFL467002R1211	1.500
				100...250	100...250	1	1	AF146-30-11B-13	1SFL467002R1311	1.500

## Main dimensions mm, inches

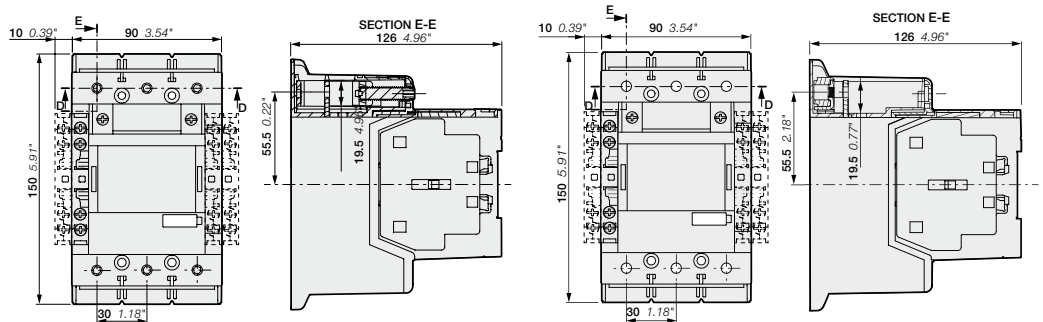

AF116, AF140, AF146-30-11

AF116, AF140, AF146-30-11B

1SFC101090C0201



# AF190 ... AF370 3-pole contactors

## 90 to 200 kW

### AC / DC operated with 1 N.O. + 1 N.C. auxiliary contacts



1SFC10109W0001

AF205-30-11



1SFC10109W0001

AF370-30-11

#### Description

AF190 ... AF370 contactors are mainly used for controlling 3-phase motors and power circuits up to 1000 V AC. These contactors are of the block type design with 3 main poles.

- control circuit: AC or DC operated with electronic coil interface accepting a wide control voltage range (e.g. 100...250 V AC and DC), only 3 coils to cover control voltages between 24...250 V 50/60 Hz and 20...250 V DC
- can manage large control voltage variations
- reduced panel energy consumption
- very distinct closing and opening
- can withstand short voltage dips and voltage sags (SEMI F47 conditions of use on request).
- built-in surge suppression
- add-on auxiliary contact blocks for side mounting and a wide range of accessories.

#### Ordering details

IEC Rated operational power 400 V AC-3 kW	UL / CSA 3-phase motor rating 480 V AC-1 A	General use rating 600 V AC hp	General use rating A	Rated control circuit voltage Uc min. ... Uc max.		Auxiliary contacts fitted 	Type	Order code	Weight Pkg (1 pce) kg
				V 50/60 Hz	V DC				
90	275	125	250	24...60	20...60	1 1	AF190-30-11-11	1SFL487002R1111	3.000
				48...130	48...130	1 1	AF190-30-11-12	1SFL487002R1211	3.000
				100...250	100...250	1 1	AF190-30-11-13	1SFL487002R1311	3.000
110	350	150	300	24...60	20...60	1 1	AF205-30-11-11	1SFL527002R1111	3.000
				48...130	48...130	1 1	AF205-30-11-12	1SFL527002R1211	3.000
				100...250	100...250	1 1	AF205-30-11-13	1SFL527002R1311	3.000
140	400	200	350	24...60	20...60	1 1	AF265-30-11-11	1SFL547002R1111	4.640
				48...130	48...130	1 1	AF265-30-11-12	1SFL547002R1211	4.640
				100...250	100...250	1 1	AF265-30-11-13	1SFL547002R1311	4.640
160	50	250	400	24...60	20...60	1 1	AF305-30-11-11	1SFL587002R1111	4.640
				48...130	48...130	1 1	AF305-30-11-12	1SFL587002R1211	4.640
				100...250	100...250	1 1	AF305-30-11-13	1SFL587002R1311	4.640
200	600	350	520	24...60	20...60	1 1	AF370-30-11-11	1SFL607002R1111	4.640
				48...130	48...130	1 1	AF370-30-11-12	1SFL607002R1211	4.640
				100...250	100...250	1 1	AF370-30-11-13	1SFL607002R1311	4.640

#### Main dimensions mm, inches

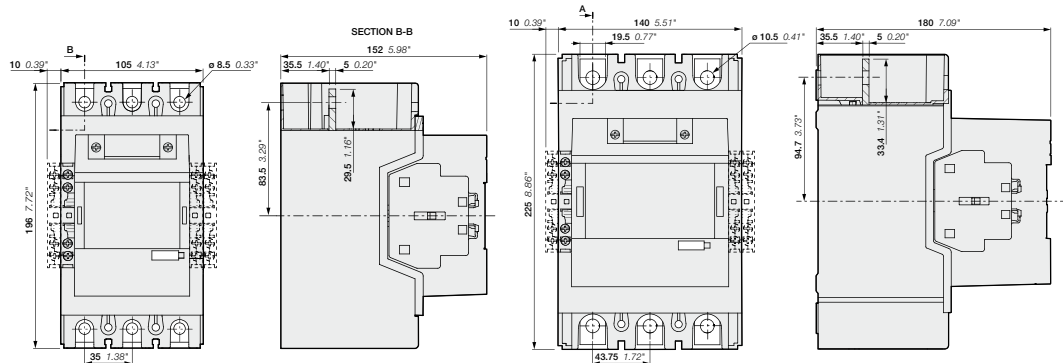

AF190, AF205

AF265, AF305, AF370

1SFC101091C0201

# AF116 ... AF370 3-pole contactors with 1 N.O. + 1 N.C. auxiliary contacts Main accessories

Main accessories (other accessories available)

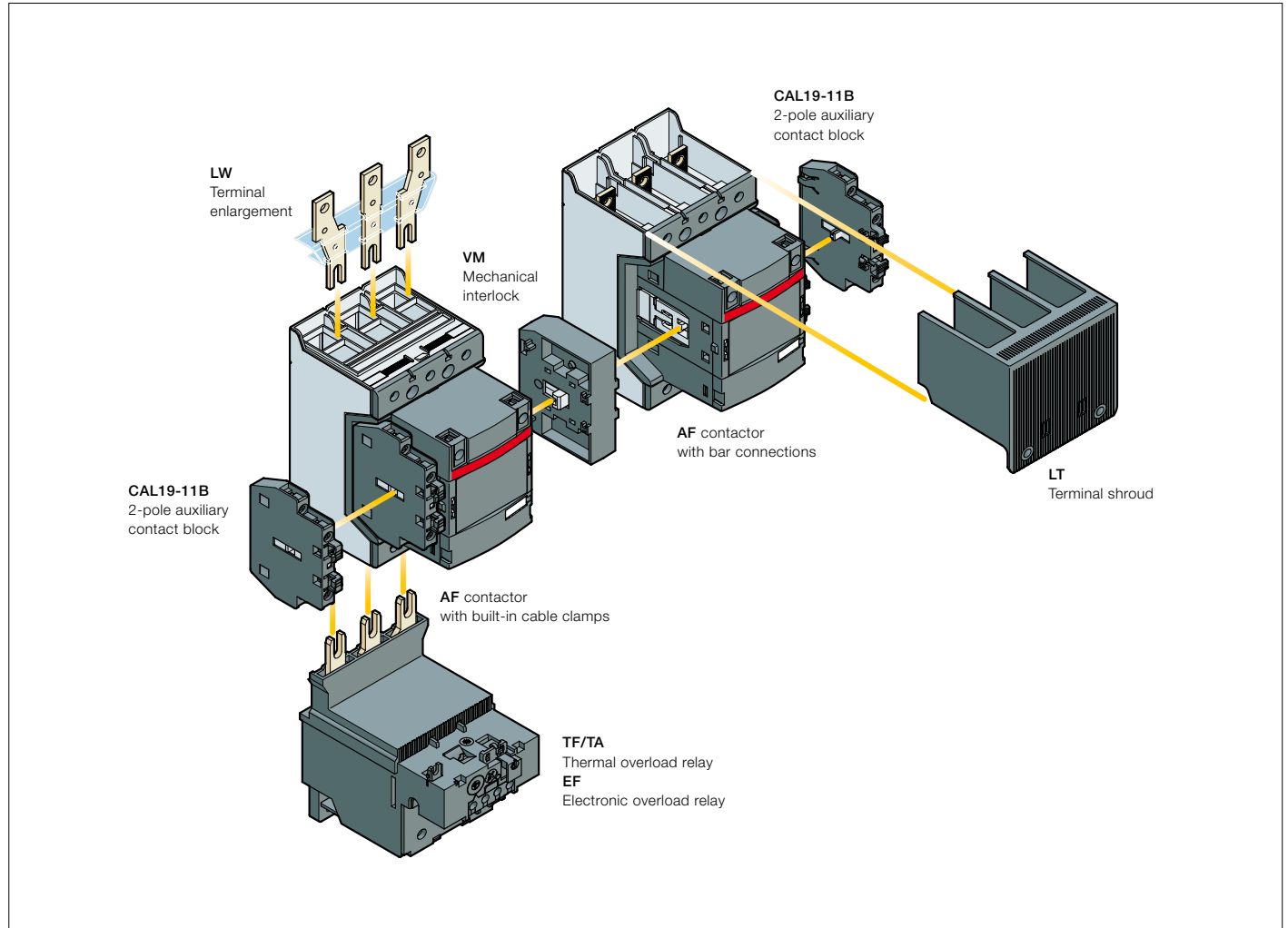

## Main accessory fitting details

Contactor types	Main poles	Available auxiliary contacts	Side-mounted accessories		
			Auxiliary contact blocks		Mechanical interlock units (between two contactors)
			CAL19-11	CAL19-11B	
AF116 ... AF370	3	0 1 1	1 x CAL19-11	+ 2 x CAL19-11B	-
AF116 ... AF370	3	0 1 1	-	+ 2 x CAL19-11B (1)	+ VM... (2)

(1) Total number of auxiliary contact blocks for the two contactors.

(2) Interlock type, according to the contactor ratings (see "Accessories").

## Overload relays fitting details (1)

Contactor types	Thermal overload relays	Electronic overload relays
AF116 ... AF140	TF140DU (66...142 A)	EF146 (54...150 A)
AF146	-	EF146 (54...150 A)
AF190, AF205	TA200DU (66...200 A)	EF205 (63...210 A)
AF265 ... AF370	-	EF370 (115...380 A)

The addition of a thermal or electronic overload relay on the contactor does not prevent fitting of many other accessories as shown in "Main accessory fitting details" table.

(1) Direct mounting - No kit required.

# AF116 ... AF370 3-pole contactors with 1 N.O. + 1 N.C. auxiliary contacts Main accessories



1SFC101071V0001

CAL19-11



1SFC101035V0001

VM19



1SFC101041V0001

LT370-30C



1SFC101049V0001

LX140

## Ordering details (1)

For contactors	Auxiliary contacts	Type	Order code	Pkg qty	Weight (1 pce)
					kg

## Side-mounted instantaneous auxiliary contact blocks

AF116 ... AF370	1	1	CAL19-11	1SFN010820R1011	2	0.050
	1	1	CAL19-11B	1SFN010820R3311	2	0.050

## Mechanical interlock unit

AF116 ... AF370	VM19	1SFN030300R1000	1	0.054
AF116 ... AF146 and AF190, AF205	VM140/190	1SFN034403R1000	1	0.088
AF190, AF205 and AF265 ... AF370	VM205/265	1SFN035203R1000	1	0.090

## Terminal shrouds

AF116 ... AF146, with compression lugs	LT140-30L	1SFN124203R1000	2	0.070
AF190, AF205, with cable clamps	LT205-30C	1SFN124801R1000	2	0.050
AF190, AF205, with compression lugs	LT205-30L	1SFN124803R1000	2	0.220
AF190, AF205, with shorting bar or between contactor and TOL/EOL in DOL-starters	LT205-30Y	1SFN124804R1000	1	0.050
AF265 ... AF370, with cable clamps	LT370-30C	1SFN125401R1000	2	0.035
AF265 ... AF370, with compression lugs	LT370-30L	1SFN125403R1000	2	0.280
AF265 ... AF370, with shorting bar or between contactor and TOL/EOL in DOL-starters	LT370-30Y	1SFN125404R1000	1	0.075
AF265 ... AF370, for use with extending cable clamps, ATK300/2 and OZXB4	LT370-30D	1SFN125406R1000	1	0.150

For contactors	Dimensions		Type	Order code	Pkg qty	Weight (1 pce)
	hole Ø mm	bar mm				kg

## Terminal enlargements

AF116...AF146	6.5	13 x 3	LW140	1SFN074207R1000	1	0.115
AF190...AF205	10.5	17.5 x 5	LW205	1SFN074807R1000	1	0.260
AF265...AF370	10.5	20 x 5	LW370	1SFN075407R1000	1	0.340

## Terminal extension

AF116...AF146	6.5	13 x 3	LX140	1SFN074210R1000	1	0.072
AF190...AF250	8.5	17.5 x 5	LX205	1SFN074810R1000	1	0.180
AF265...AF370	10.5	20 x 5	LX370	1SFN075410R1000	1	0.234

(1) For more information, refer to "Accessories" section.

# AF400 ... AF750 3-pole contactors

## 200 to 400 kW

### AC / DC operated with 1 N.O. + 1 N.C. auxiliary contacts



1SFC101023W0001

AF460-30-11



1SFC101026W0001

AF750-30-11

#### Description

AF400 ... AF750 contactors are mainly used for controlling 3-phase motors and power circuits up to 1000 V AC or 600 V DC (2). These contactors are of the block type design with 3 main poles.

- control circuit: AC or DC operated with electronic coil interface accepting a wide control voltage range (e.g. 100...250 V AC and DC), only 4 coils to cover control voltages between 48...500 V 50/60 Hz and 24...500 V DC
- can manage large control voltage variations
- reduced panel energy consumption
- very distinct closing and opening
- can withstand short voltage dips and voltages sags (SEMI F47 conditions of use on request).
- built-in surge suppression
- add-on auxiliary contact blocks for side mounting and a wide range of accessories.

#### Ordering details

IEC		UL/CSA		Rated control circuit voltage		Auxiliary contacts fitted	Type	Order code	Weight
Rated operational power	current $\theta \leq 40^\circ\text{C}$	3-phase motor rating	General use rating	Uc min. ... Uc max.					
400 V AC-3	690 V AC-1	hp	600 V AC	V 50/60 Hz	V DC				kg
200	600	350	550	-	24...60	1 1	AF400-30-11	1SFL577001R6811 (1)	12.000
				48...130	48...130	1 1	AF400-30-11	1SFL577001R6911	12.000
				100...250	100...250	1 1	AF400-30-11	1SFL577001R7011	12.000
				250...500	250...500	1 1	AF400-30-11	1SFL577001R7111	12.000
250	700	400	650	-	24...60	1 1	AF460-30-11	1SFL597001R6811 (1)	12.000
				48...130	48...130	1 1	AF460-30-11	1SFL597001R6911	12.000
				100...250	100...250	1 1	AF460-30-11	1SFL597001R7011	12.000
				250...500	250...500	1 1	AF460-30-11	1SFL597001R7111	12.000
315	800	500	750	-	24...60	1 1	AF580-30-11	1SFL617001R6811 (1)	15.000
				48...130	48...130	1 1	AF580-30-11	1SFL617001R6911	15.000
				100...250	100...250	1 1	AF580-30-11	1SFL617001R7011	15.000
				250...500	250...500	1 1	AF580-30-11	1SFL617001R7111	15.000
400	1050	600	900	-	24...60	1 1	AF750-30-11	1SFL637001R6811 (1)	15.000
				48...130	48...130	1 1	AF750-30-11	1SFL637001R6911	15.000
				100...250	100...250	1 1	AF750-30-11	1SFL637001R7011	15.000
				250...500	250...500	1 1	AF750-30-11	1SFL637001R7111	15.000

(1) The connection polarities indicated close to the coil terminals must be respected: A1 for the positive pole and A2 for the negative pole.

(2) Up to 850 V DC for AF580, AF750.

AF400 ... AF750 are equipped with low voltage inputs for control, for example by a PLC.

#### Control inputs

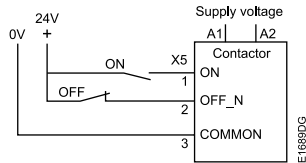

#### Main dimensions mm, inches

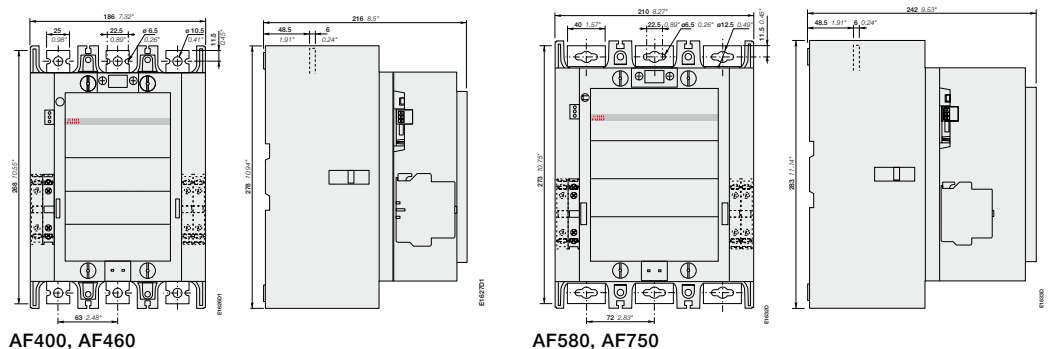

AF400, AF460

AF580, AF750

1SFC101013C0201

# AF1250 ... AF2650 3-pole contactors

## 475 to 560 kW and 1260 to 2650 A AC-1

### AC / DC operated with 1 N.O. + 1 N.C. auxiliary contacts



AF1250-30-11

1SFC101027V0001



AF2650-30-11

1SFC101031V0001

#### Description

AF1250 ... AF2050 contactors are mainly used for controlling power circuits up to 1000 V AC or 850 V DC, AF2650 for controlling power up to 1000 V AC. These contactors are of the block type design with 3 main poles.

- control circuit: AC or DC operated with electronic coil interface accepting a wide control voltage range (e.g. 100...250 V AC and DC)
- only 4 coils for AF1250 to cover control voltages between 48...500 V 50/60 Hz and 24...500 V DC
- only 1 coil for AF1350 ... AF2650 to cover control voltages between 100...250 V 50/60 Hz and 100...250 V DC
- can manage large control voltage variations
- reduced panel energy consumption
- very distinct closing and opening
- can withstand short voltage dips and voltages sags (SEMI F47 conditions of use on request).
- built-in surge suppression
- add-on auxiliary contact blocks for side mounting and a wide range of accessories.

#### Ordering details

IEC		UL/CSA		Rated control circuit voltage U <sub>c</sub>		Auxiliary contacts fitted		Type	Order code	Weight
Rated operational power	Rated current I <sub>n</sub> at θ ≤ 40 °C	3-phase motor rating	General use rating	(1)		1 1				Pkg (1 pce)
kW	A	hp	A	V 50/60 Hz	V DC	1 1				kg
-	1260	-	1210	-	24...60	1	1	AF1250-30-11	1SFL647001R6811 (1)	16.000
				48...130	48...130	1	1	AF1250-30-11	1SFL647001R6911	16.000
				100...250	100...250	1	1	AF1250-30-11	1SFL647001R7011	16.000
				250...500	250...500	1	1	AF1250-30-11	1SFL647001R7111	16.000
475	1350	800	1350	100...250	100...250	1	1	AF1350-30-11	1SFL657001R7011	34.000
560	1650	900	1650	100...250	100...250	1	1	AF1650-30-11	1SFL677001R7011	35.000
-	2050	-	2100	100...250	100...250	1	1	AF2050-30-11	1SFL707001R7011	35.000
-	2650	-	2700	100...250	100...250	1	1	AF2650-30-11	1SFL667001R7011	45.000

(1) The connection polarities indicated close to the coil terminals must be respected: A1 for the positive pole and A2 for the negative pole.  
 (2) AF2650 : Maximum operational voltage = 1000 V according to UL / CSA.

AF1250 ... AF2650 are equipped with low voltage inputs for control, for example by a PLC

#### Control inputs

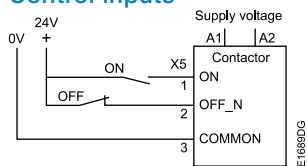

	AF1350, AF1650, AF2050	AF2650
A	392 mm / 15.43"	422 mm / 16.61"
B	47 mm / 1.85"	53.5 mm / 2.11"
C	10 mm / 0.39"	25 mm / 0.98"
D	3 mm / 0.12"	-

#### Main dimensions mm, inches

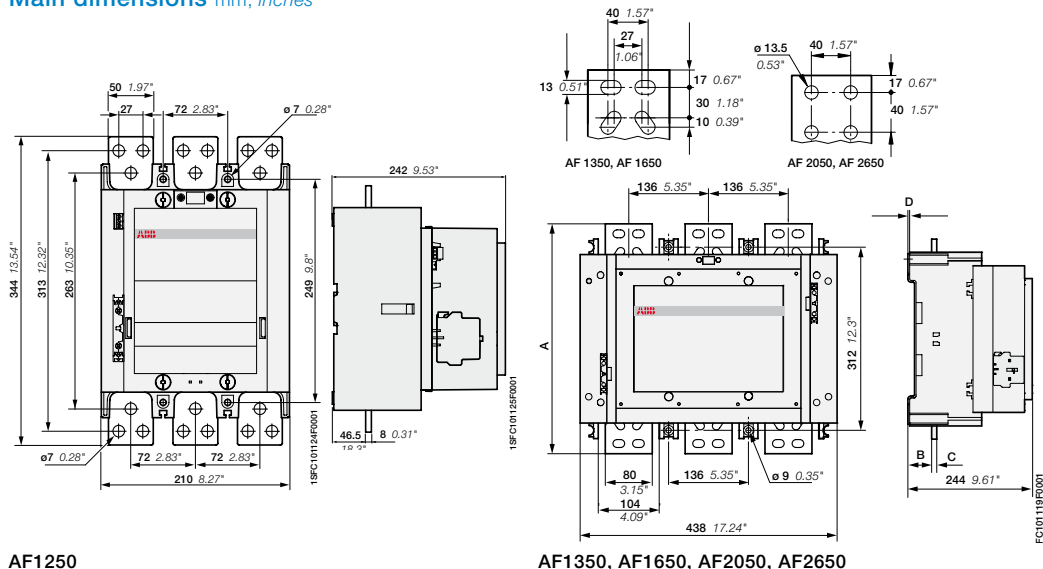

AF1250

AF1350, AF1650, AF2050, AF2650

# AF400 ... AF2650 3-pole contactors with 1 N.O. + 1 N.C. auxiliary contacts

## Main accessories

Main accessories (other accessories available)

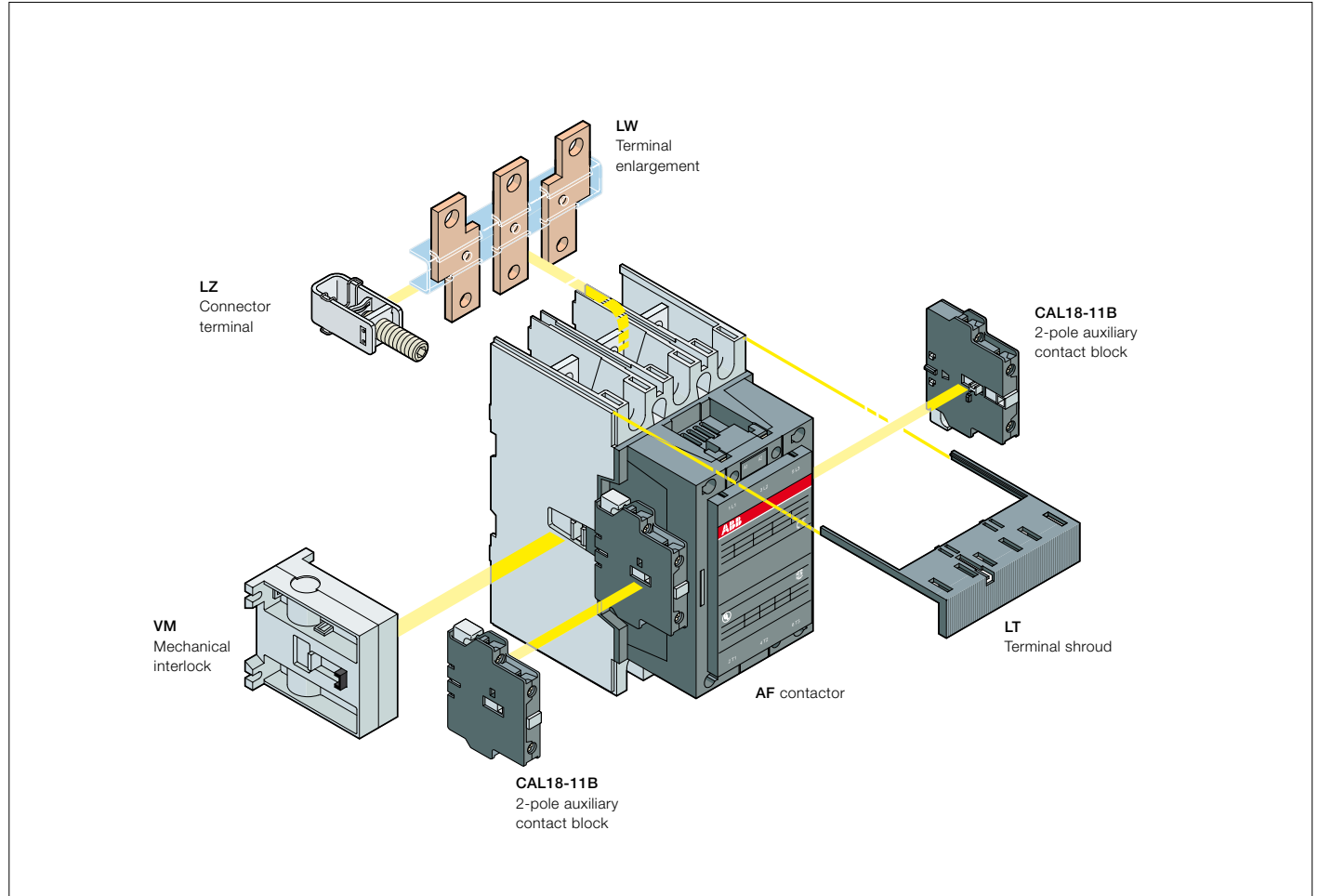

### Main accessory fitting details

Contactor types	Main poles	Available auxiliary contacts	Side-mounted accessories		Mechanical interlock units (between two contactors)
			Auxiliary contact blocks		
			CAL18-11	CAL18-11B (3)	

#### Contactors + auxiliary contact blocks

AF400 ... AF2650	3	0	1	1	1 x CAL18-11	+	2 x CAL18-11B	-
------------------	---	---	---	---	--------------	---	---------------	---

#### Contactors with mechanical interlocking + auxiliary contact blocks

AF400 ... AF2650	3	0	1	1	2 x CAL18-11 (1)	+	4 x CAL18-11B (1)	+	VM...H (2)
------------------	---	---	---	---	------------------	---	-------------------	---	------------

(1) Total number of auxiliary contact blocks for the two contactors.

(2) Interlock type, according to the contactor ratings (see "Accessories").

(3) The CEL18-.. auxiliary contact blocks can replace the CAL18-11 and CAL18-11B. Though, no auxiliary contact block can be mounted outside the CEL18-..

### Overload relays fitting details

Contactor types	Thermal overload relays	Electronic overload relays
	AF400, AF460	-
AF580, AF750	-	E800DU (250...800 A) (4)
AF1350, AF1650	-	E1250DU (375...1250 A) (4)

The addition of a thermal or electronic overload relay on the contactor does not prevent fitting of many other accessories as shown in "Main accessory fitting details" table.

(4) Mounting kit required (see "Motor protection").

# AF400 ... AF2650 3-pole contactors with 1 N.O. + 1 N.C. auxiliary contacts Main accessories



CAL18-11



VM750H



LT460-AC

## Ordering details (1)

For contactors	Auxiliary contacts	Type	Order code	Pkg qty	Weight (1 pce)
					kg

### Side-mounted instantaneous auxiliary contact blocks

AF400 ... AF2650	1	1	CAL18-11	1SFN010720R1011	2	0.050
	1	1	CAL18-11B	1SFN010720R3311	2	0.050

### Mechanical interlock unit

AF400 ... AF1250			VM750H	1SFN035700R1000	1	0.200
AF1350 ... AF2650			VM1650H	1SFN036503R1000	1	6.000

### Terminal shrouds

AF400, AF460 with connectors			LT460-AC	1SFN125701R1000	2	0.100
AF400, AF460 with lugs			LT460-AL	1SFN125703R1000	2	0.800
AF580 ... AF750 with connectors			LT750-AC	1SFN126101R1000	2	0.120
AF580 ... AF750 with lugs			LT750-AL	1SFN126103R1000	2	0.825

For contactors	Dimensions		Type	Order code	Pkg qty	Weight (1 pce)
	hole Ø	bar				kg
	mm	mm				

### Terminal enlargements

AF400, AF460	10.5	25 x 5	LW460	1SFN075707R1000	1	0.730
AF580, AF750	13	40 x 6	LW750	1SFN076107R1000	1	1.230
AF1250	13	50 x 10	LW1250	1SFN076407R1000	1	2.000

### Terminal extension

AF400, AF460	10.5	25 x 5	LX460	1SFN075710R1000	1	0.500
AF580, AF750	13	40 x 6	LX750	1SFN076110R1000	1	0.850

(1) For more information, refer to "Accessories" section.



# AF09 ... AF38 2-stack 3-pole contactors

## 4 to 18.5 kW

### AC / DC operated



AF09-30-22

1SBC101002V0014



AF26-30-11

1SBC101003V0014



AF26-30-22

1SBC101004V0014

### Description

AF09 ... AF38 contactors are mainly used for controlling 3-phase motors and power circuits up to 690 V AC and 220 V DC. These contactors are of the block type design with 3 main poles (1st stack):

- 2nd stack with permanently fixed auxiliary contact block. The built-in auxiliary contact elements are mechanically linked (side-marked symbol) and the N.C. auxiliary contacts are mirror contacts
- control circuit: AC or DC operated with electronic coil interface accepting a wide control voltage range (e.g. 100...250 V AC and DC), only 4 control voltage ranges covering 24...500 V 50/60 Hz and 20...500 V DC
- can manage large control voltage variations
- reduced panel energy consumption
- very distinct closing and opening.
- built-in surge suppression
- add-on auxiliary contact blocks for side mounting and a wide range of accessories.

### Ordering details

IEC Rated operational power	UL/CSA 3-phase motor rating 480 V	General use rating 600 V AC	Rated control circuit voltage Uc min. ... Uc max.		Auxiliary contacts fitted	Type	Order code	Weight Pkg (1 pce)	
			V 50/60 Hz	V DC					
4 kW AC-3	25 A AC-1	5 hp	25 A	24...60	-	(1) 2 2	AF09-30-22-41	1SBL137001R4122	0.320
				48...130	48...130	2 2	AF09-30-22-12	1SBL137001R1222	0.320
				100...250	100...250	2 2	AF09-30-22-13	1SBL137001R1322	0.320
				250...500	250...500	2 2	AF09-30-22-14	1SBL137001R1422	0.360
5.5	28	7.5	28	24...60	-	(1) 2 2	AF12-30-22-41	1SBL157001R4122	0.320
				48...130	48...130	2 2	AF12-30-22-12	1SBL157001R1222	0.320
				100...250	100...250	2 2	AF12-30-22-13	1SBL157001R1322	0.320
				250...500	250...500	2 2	AF12-30-22-14	1SBL157001R1422	0.360
7.5	30	10	30	24...60	-	(1) 2 2	AF16-30-22-41	1SBL177001R4122	0.320
				48...130	48...130	2 2	AF16-30-22-12	1SBL177001R1222	0.320
				100...250	100...250	2 2	AF16-30-22-13	1SBL177001R1322	0.320
				250...500	250...500	2 2	AF16-30-22-14	1SBL177001R1422	0.360
11	45	15	45	24...60	-	(1) 1 1	AF26-30-11-41	1SBL237001R4111	0.350
				48...130	48...130	2 2	AF26-30-22-41	1SBL237001R4122	0.360
				48...130	48...130	1 1	AF26-30-11-12	1SBL237001R1211	0.350
				48...130	48...130	2 2	AF26-30-22-12	1SBL237001R1222	0.360
				100...250	100...250	1 1	AF26-30-11-13	1SBL237001R1311	0.350
				100...250	100...250	2 2	AF26-30-22-13	1SBL237001R1322	0.360
				250...500	250...500	1 1	AF26-30-11-14	1SBL237001R1411	0.390
				250...500	250...500	2 2	AF26-30-22-14	1SBL237001R1422	0.400
15	50	20	50	24...60	-	(1) 1 1	AF30-30-11-41	1SBL277001R4111	0.350
				48...130	48...130	2 2	AF30-30-22-41	1SBL277001R4122	0.360
				48...130	48...130	1 1	AF30-30-11-12	1SBL277001R1211	0.350
				48...130	48...130	2 2	AF30-30-22-12	1SBL277001R1222	0.360
				100...250	100...250	1 1	AF30-30-11-13	1SBL277001R1311	0.350
				100...250	100...250	2 2	AF30-30-22-13	1SBL277001R1322	0.360
				250...500	250...500	1 1	AF30-30-11-14	1SBL277001R1411	0.390
				250...500	250...500	2 2	AF30-30-22-14	1SBL277001R1422	0.400
18.5	50	20	50	24...60	-	(1) 1 1	AF38-30-11-41	1SBL297001R4111	0.350
				48...130	48...130	2 2	AF38-30-22-41	1SBL297001R4122	0.360
				48...130	48...130	1 1	AF38-30-11-12	1SBL297001R1211	0.350
				48...130	48...130	2 2	AF38-30-22-12	1SBL297001R1222	0.360
				100...250	100...250	1 1	AF38-30-11-13	1SBL297001R1311	0.350
				100...250	100...250	2 2	AF38-30-22-13	1SBL297001R1322	0.360
				250...500	250...500	1 1	AF38-30-11-14	1SBL297001R1411	0.390
				250...500	250...500	2 2	AF38-30-22-14	1SBL297001R1422	0.400

(1) For 24...60 V 50/60 Hz - 20...60 V DC, use AF.-30-...-11 (see voltage code table).  
AF.-30-...-11 not suitable for direct control by PLC-output.

### Main dimensions mm, inches

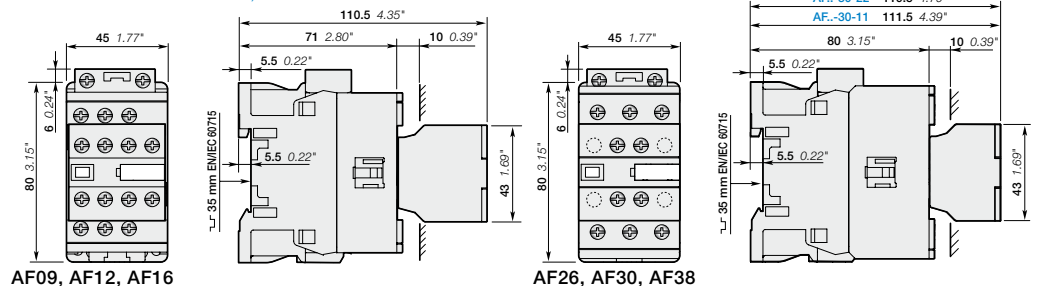



# AF09Z ... AF38Z 2-stack 3-pole contactors

## 4 to 18.5 kW

### AC / DC operated - Low consumption



AF09Z-30-22

1SBC101002V0014



AF26Z-30-11

1SBC101003V0014



AF26Z-30-22

1SBC101004V0014

#### Description

AF09Z ... AF38Z contactors are mainly used for controlling 3-phase motors and power circuits up to 690 V AC and 220 V DC. These contactors are of the block type design with 3 main poles (1st stack):

- 2nd stack with permanently fixed auxiliary contact block. The built-in auxiliary contact elements are mechanically linked (side-marked symbol) and the N.C. auxiliary contacts are mirror contacts
- control circuit: AC or DC operated with electronic coil interface accepting a wide control voltage range (e.g. 100...250 V AC and DC), only 4 control voltage ranges covering 24...250 V 50/60 Hz and 12...250 V DC
- can manage large control voltage variations, allow direct control by PLC-output  $\geq 24$  V DC 500 mA, reduced panel energy consumption, very distinct closing and opening,
- can withstand short voltage dips and voltage sags (SEMI F47-0706 conditions of use on request).
- built-in surge suppression
- add-on auxiliary contact blocks for side mounting and a wide range of accessories.

#### Ordering details

IEC		UL/CSA		Rated control circuit voltage		Auxiliary contacts fitted		Type	Order code	Weight
Rated operational power	Rated operational current	3-phase motor rating	General use rating	Uc min. ... Uc max.	Uc min. ... Uc max.	Type				Pkg (1 pce)
kW	A	hp	A	V 50/60 Hz	V DC	Type				kg
4	25	5	25	-	12...20	2	2	AF09Z-30-22-20	1SBL136001R2022	0.360
				24...60	20...60	2	2	AF09Z-30-22-21	1SBL136001R2122	0.360
				48...130	48...130	2	2	AF09Z-30-22-22	1SBL136001R2222	0.360
				100...250	100...250	2	2	AF09Z-30-22-23	1SBL136001R2322	0.360
				-	12...20	2	2	AF12Z-30-22-20	1SBL156001R2022	0.360
5.5	28	7.5	28	24...60	20...60	2	2	AF12Z-30-22-21	1SBL156001R2122	0.360
				48...130	48...130	2	2	AF12Z-30-22-22	1SBL156001R2222	0.360
				100...250	100...250	2	2	AF12Z-30-22-23	1SBL156001R2322	0.360
				-	12...20	2	2	AF16Z-30-22-20	1SBL176001R2022	0.360
				24...60	20...60	2	2	AF16Z-30-22-21	1SBL176001R2122	0.360
7.5	30	10	30	48...130	48...130	2	2	AF16Z-30-22-22	1SBL176001R2222	0.360
				100...250	100...250	2	2	AF16Z-30-22-23	1SBL176001R2322	0.360
				-	12...20	1	1	AF26Z-30-11-20	1SBL236001R2011	0.390
				24...60	20...60	2	2	AF26Z-30-22-20	1SBL236001R2022	0.400
				48...130	48...130	1	1	AF26Z-30-11-21	1SBL236001R2111	0.390
11	45	15	45	100...250	100...250	2	2	AF26Z-30-22-21	1SBL236001R2122	0.400
				-	12...20	1	1	AF26Z-30-11-22	1SBL236001R2211	0.390
				24...60	20...60	2	2	AF26Z-30-22-22	1SBL236001R2222	0.400
				48...130	48...130	1	1	AF26Z-30-11-23	1SBL236001R2311	0.390
				100...250	100...250	2	2	AF26Z-30-22-23	1SBL236001R2322	0.400
15	50	20	50	-	12...20	1	1	AF30Z-30-11-20	1SBL276001R2011	0.390
				24...60	20...60	2	2	AF30Z-30-22-20	1SBL276001R2022	0.400
				48...130	48...130	1	1	AF30Z-30-11-21	1SBL276001R2111	0.390
				100...250	100...250	2	2	AF30Z-30-22-21	1SBL276001R2122	0.400
				-	12...20	1	1	AF30Z-30-11-22	1SBL276001R2211	0.390
18.5	50	20	50	48...130	48...130	2	2	AF30Z-30-22-22	1SBL276001R2222	0.400
				100...250	100...250	1	1	AF30Z-30-11-23	1SBL276001R2311	0.390
				-	12...20	2	2	AF30Z-30-22-23	1SBL276001R2322	0.400
				24...60	20...60	1	1	AF38Z-30-11-20	1SBL296001R2011	0.390
				48...130	48...130	2	2	AF38Z-30-22-20	1SBL296001R2022	0.400
				100...250	100...250	1	1	AF38Z-30-11-21	1SBL296001R2111	0.390
				-	12...20	2	2	AF38Z-30-22-21	1SBL296001R2122	0.400
				24...60	20...60	1	1	AF38Z-30-11-22	1SBL296001R2211	0.390
				48...130	48...130	2	2	AF38Z-30-22-22	1SBL296001R2222	0.400
				100...250	100...250	1	1	AF38Z-30-11-23	1SBL296001R2311	0.390
						2	2	AF38Z-30-22-23	1SBL296001R2322	0.400

Note: Only AF.Z contactors with DC control voltage 12...20 V DC need to respect the connection polarities indicated close to the coil terminals: A1+ for the positive pole and A2- for the negative pole

#### Main dimensions mm, inches

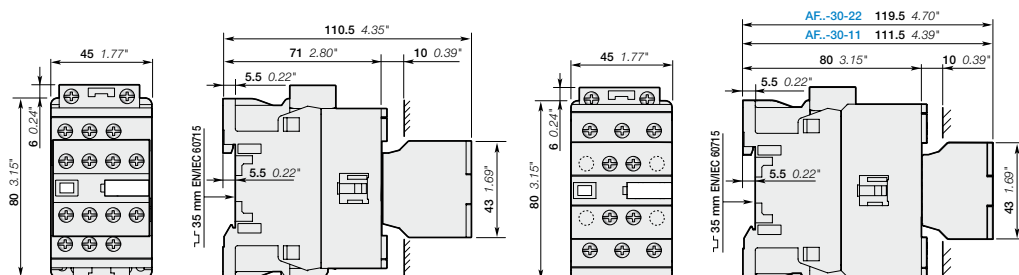

AF09Z, AF12Z, AF16Z

AF26Z, AF30Z, AF38Z

1SBC10137450201 - Rev. A

# AF40 ... AF65 2-stack 3-pole contactors

## 18.5 to 30 kW

### AC / DC operated



1SBC101005V0014

AF40-30-11

#### Description

AF40 ... AF65 contactors are mainly used for controlling 3-phase motors and power circuits up to 690 V AC and 220 V DC. These contactors are of the block type design with 3 main poles (1st stack):

- 2nd stack with permanently fixed auxiliary contact block. The built-in auxiliary contact elements are mechanically linked (side-marked symbol) and the N.C. auxiliary contacts are mirror contacts
- control circuit: AC or DC operated with electronic coil interface accepting a wide control voltage range (e.g. 100...250 V AC and DC), only 4 control voltage ranges covering 24...500 V 50/60 Hz and 20...500 V DC
- can manage large control voltage variations
- reduced panel energy consumption
- very distinct closing and opening.
- built-in surge suppression
- add-on auxiliary contact blocks for side mounting and a wide range of accessories.

#### Ordering details

IEC	Rated operational power 400 V AC-3 kW	Rated operational current $\theta \leq 40^\circ\text{C}$ AC-1 A	UL / CSA 3-phase motor rating 480 V hp	General use rating 600 V AC A	Rated control circuit voltage Uc min. ... Uc max.		Auxiliary contacts fitted	Type	Order code	Weight Pkg (1 pce) kg																																																												
					V 50/60 Hz	V DC																																																																
18.5	70	30	60	24...60	-	-	1 1	AF40-30-11-41	1SBL347001R4111	1.010																																																												
											24...60	20...60 (1)	1 1	AF40-30-11-11	1SBL347001R1111	1.010																																																						
																	48...130	48...130	1 1	AF40-30-11-12	1SBL347001R1211	1.010																																																
																							100...250	100...250	1 1	AF40-30-11-13	1SBL347001R1311	0.990																																										
																													250...500	250...500	1 1	AF40-30-11-14	1SBL347001R1411	0.990																																				
																																			24...60	-	2 2	AF40-30-22-41	1SBL347001R4122	1.020																														
																																									24...60	20...60 (1)	2 2	AF40-30-22-11	1SBL347001R1122	1.020																								
																																															48...130	48...130	2 2	AF40-30-22-12	1SBL347001R1222	1.020																		
																																																					100...250	100...250	2 2	AF40-30-22-13	1SBL347001R1322	1.000												
																																																											250...500	250...500	2 2	AF40-30-22-14	1SBL347001R1422	1.000						
																																																																	24...60	-	1 1	AF52-30-11-41	1SBL367001R4111	1.010
48...130	48...130	1 1	AF52-30-11-12	1SBL367001R1211	1.010																																																																	
						100...250	100...250	1 1	AF52-30-11-13	1SBL367001R1311	0.990																																																											
												250...500	250...500	1 1	AF52-30-11-14	1SBL367001R1411	0.990																																																					
																		24...60	-	2 2	AF52-30-22-41	1SBL367001R4122	1.020																																															
																								24...60	20...60 (1)	2 2	AF52-30-22-11	1SBL367001R1122	1.020																																									
																														48...130	48...130	2 2	AF52-30-22-12	1SBL367001R1222	1.020																																			
																																				100...250	100...250	2 2	AF52-30-22-13	1SBL367001R1322	1.000																													
																																										250...500	250...500	2 2	AF52-30-22-14	1SBL367001R1422	1.000																							
																																																24...60	-	1 1	AF65-30-11-41	1SBL387001R4111	1.010																	
																																																						24...60	20...60 (1)	1 1	AF65-30-11-11	1SBL387001R1111	1.010											
																																																												48...130	48...130	1 1	AF65-30-11-12	1SBL387001R1211	1.010					
																																																																		100...250	100...250	1 1	AF65-30-11-13	1SBL387001R1311
250...500	250...500	1 1	AF65-30-11-14	1SBL387001R1411	0.990																																																																	
						24...60	-	2 2	AF65-30-22-41	1SBL387001R4122	1.020																																																											
												24...60	20...60 (1)	2 2	AF65-30-22-11	1SBL387001R1122	1.020																																																					
																		48...130	48...130	2 2	AF65-30-22-12	1SBL387001R1222	1.020																																															
																								100...250	100...250	2 2	AF65-30-22-13	1SBL387001R1322	1.000																																									
																														250...500	250...500	2 2	AF65-30-22-14	1SBL387001R1422	1.000																																			

(1) AF.-30...-11 not suitable for direct control by PLC-output.

#### Main dimensions mm, inches

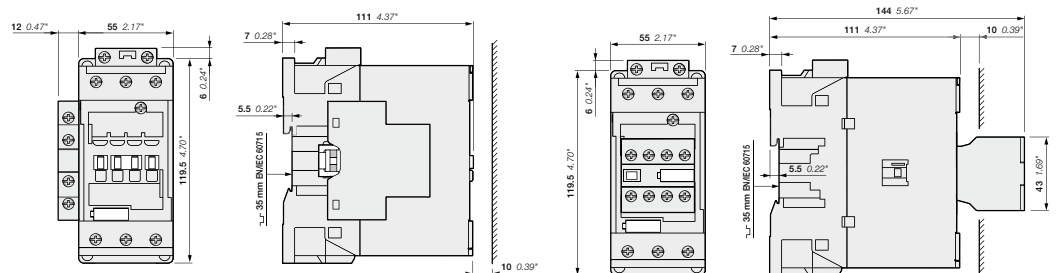

AF40, AF52, AF65-30-11-...

AF40, AF52, AF65-30-22-...

1SBC101741S0201

# AF80 ... AF96 2-stack 3-pole contactors

## 37 to 45 kW

### AC / DC operated



AF80-30-11

1SBC101017V0014



AF80-30-22

1SBC101007V0014

#### Description

AF80 ... AF96 contactors are mainly used for controlling 3-phase motors and power circuits up to 690 V AC and 220 V DC. These contactors are of the block type design with 3 main poles (1st stack):

- 2nd stack with permanently fixed auxiliary contact block. The built-in auxiliary contact elements are mechanically linked (side-marked symbol) and the N.C. auxiliary contacts are mirror contacts
- control circuit: AC or DC operated with electronic coil interface accepting a wide control voltage range (e.g. 100...250 V AC and DC), only 4 control voltage ranges covering 24...500 V 50/60 Hz and 20...500 V DC
- can manage large control voltage variations
- reduced panel energy consumption
- very distinct closing and opening.
- built-in surge suppression
- add-on auxiliary contact blocks for side mounting and a wide range of accessories.

#### Ordering details

IEC		UL / CSA		Rated control circuit voltage		Auxiliary contacts fitted	Type	Order code	Weight
Rated power	operational current	3-phase motor rating	General use rating	Uc min. ... Uc max.					
400 V AC-3	$\theta \leq 40^\circ\text{C}$ AC-1	480 V	600 V AC	V 50/60 Hz	V DC				Pkg (1 pce)
kW	A	hp	A						kg
37	125	60	105	24...60	-	1 1	AF80-30-11-41	1SBL397001R4111	1.260
							AF80-30-22-41	1SBL397001R4122	1.270
				24...60	20...60 (1)	1 1	AF80-30-11-11	1SBL397001R1111	1.260
							AF80-30-22-11	1SBL397001R1122	1.270
				48...130	48...130	1 1	AF80-30-11-12	1SBL397001R1211	1.260
							AF80-30-22-12	1SBL397001R1222	1.270
				100...250	100...250	1 1	AF80-30-11-13	1SBL397001R1311	1.210
							AF80-30-22-13	1SBL397001R1322	1.220
				250...500	250...500	1 1	AF80-30-11-14	1SBL397001R1411	1.210
							AF80-30-22-14	1SBL397001R1422	1.220
45	130	60	115	24...60	-	1 1	AF96-30-11-41	1SBL407001R4111	1.260
							AF96-30-22-41	1SBL407001R4122	1.270
				24...60	20...60 (1)	1 1	AF96-30-11-11	1SBL407001R1111	1.260
							AF96-30-22-11	1SBL407001R1122	1.270
				48...130	48...130	1 1	AF96-30-11-12	1SBL407001R1211	1.260
							AF96-30-22-12	1SBL407001R1222	1.270
				100...250	100...250	1 1	AF96-30-11-13	1SBL407001R1311	1.210
							AF96-30-22-13	1SBL407001R1322	1.220
				250...500	250...500	1 1	AF96-30-11-14	1SBL407001R1411	1.210
							AF96-30-22-14	1SBL407001R1422	1.220

(1) AF...-30...-11 not suitable for direct control by PLC-output.

#### Main dimensions mm, inches

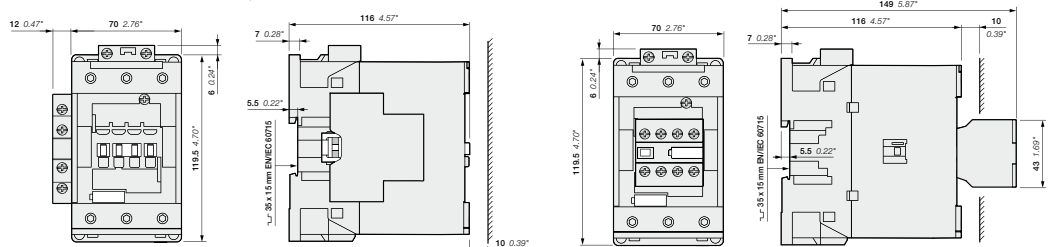

AF80, AF96-30-11-..

AF80, AF96-30-22-..

1SBC101742S0201

# AF09 ... AF96 2-stack 3-pole contactors

## Main accessories

### Contactor and main accessories (other accessories available)

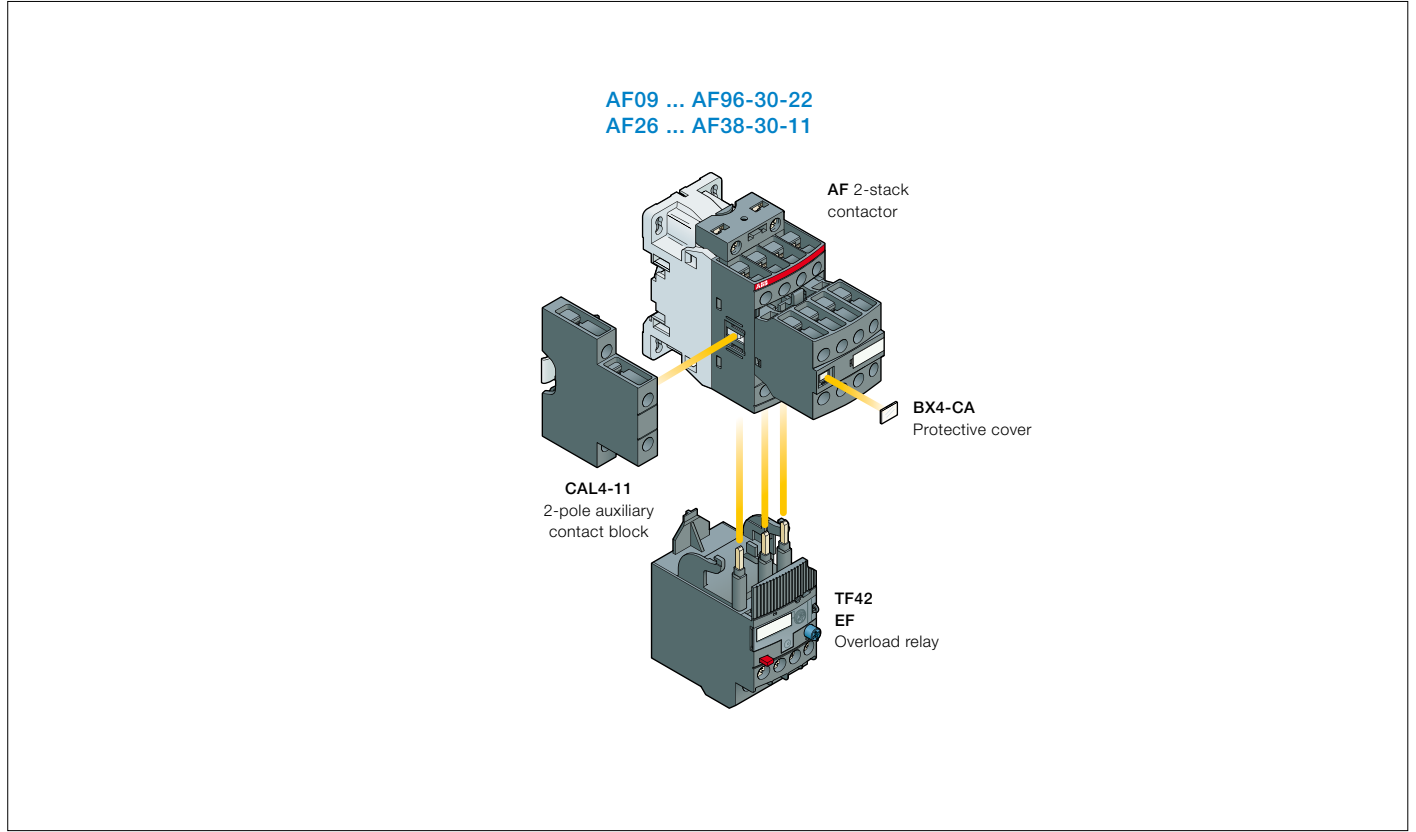

### Main accessory fitting details

Many configurations of accessories are possible depending on whether these are front-mounted or side-mounted.

Contactor types	Main poles		Built-in auxiliary contacts		Front-mounted accessories				Electronic timer		Electrical and mechanical interlock set (between 2 contactors)		Side-mounted accessories	
	I	L	I	L	Auxiliary contact blocks			TEF4		VEM4		Left side	Right side	
					1-pole CA4	1-pole CC4	2-pole CAT4-11	4-pole CA4				2-pole CAL4-11		
AF26 ... AF38	3	0	1	1	-	-	-	-	-	-	-	+	1	+ 1
AF40 ... AF65	3	0	1	1	4 max.	or 1	or 1	or 1	or 1	-	-	-	-	+ 1
AF80 ... AF96	3	0	1	1	4 max.	-	or 1	-	or 1	-	-	-	-	+ 1
AF09 ... AF96	3	0	2	2	-	-	-	-	-	-	-	+	1	-
AF40 ... AF96	3	0	2	2	-	-	-	-	-	-	-	+	1	+ 1

### Overload relays fitting details (1)

Contactor types	Thermal overload relays	Electronic overload relays
AF09 ... AF38	TF42 (0.10...38 A)	EF19 (0.10...19 A)
AF26 ... AF38	TF42 (0.10...38 A)	EF45 (9...45 A)
AF40 ... AF65	TF65 (22...67 A)	EF65 (25...70 A)
AF80, AF96	TF96 (40...96 A)	EF96 (36...100 A)

The addition of an overload relay on the contactor does not prevent fitting of many other accessories as shown above.

(1) Direct mounting - No kit required.

# AF09 ... AF96 2-stack 3-pole contactors

## Main accessories

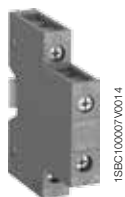

CAL4-11

1SBC100007V0014



VM4

1SBC100010V0014

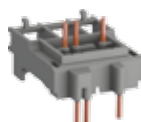

BEA16-4

1SBC100014V0014



TEF4-ON

1SBC100004V0014

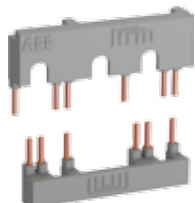

BER16-4

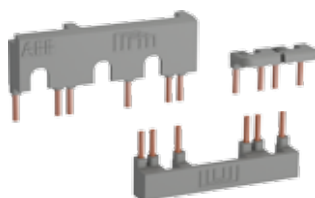

1SBC100016V0014



BEY16-4

1SBC100018V0014

### Ordering Details (1)

For contactors	Auxiliary contacts	Type	Order code	Pkg qty	Weight (1 pce)
	 				kg

### Side-mounted instantaneous auxiliary contact blocks

AF09 ... AF96	1 1	- -	CAL4-11	1SBN010120R1011	1	0.040
	1 1	- -	CAL4-11-T	1SBN010120T1011	10	0.040

### Mechanical interlock unit

AF09 ... AF38			VM4	1SBN030105T1000	10	0.005
AF40 ... AF96			VM96-4	1SBN033405T1000	10	0.006

Note: VM4 and VM96-4 include 2 fixing clips (BB4) to maintain together both contactors.

For contactors	Time delay range selected by switch	Delay type	Auxiliary contacts	Type	Order code	Pkg qty	Weight (1 pce)
							kg

### Electronic timers

AF40 ... AF96-30-11	0.1...1 s	ON-delay	1 1	TEF4-ON	1SBN020112R1000	1	0.065
	1...10 s	OFF-delay	1 1	TEF4-OFF	1SBN020114R1000	1	0.065
	10...100 s						

Note: Rated control circuit voltage Uc 24...240 V 50/60 Hz or DC.

### Connecting links with manual motor starters

AF09 ... AF16	with	MS116-0.16 ... MS116-25, MS132-0.16 ... MS132-25	BEA16-4	1SBN081306T1000	10	0.025
AF26 ... AF38	with	MS116-0.16 ... MS116-16, MS132-0.16 ... MS132-10	BEA26-4	1SBN082306T1000	10	0.025
	with	MS116-20 ... MS116-32, MS132-12 ... MS132-32	BEA38-4	1SBN082306T2000	10	0.030

### Connection sets for reversing contactors

AF09 ... AF16		BER16-4	1SBN081311R1000	1	0.045
AF26 ... AF38		BER38-4	1SBN082311R1000	1	0.100
AF40 ... AF65		BER65-4	1SBN083411R1000	1	0.175
AF80 ... AF96		BER96-4	1SBN083911R1000	1	0.250

### Connection sets for star-delta starting

AF09 ... AF16	with or without VM4	BEY16-4	1SBN081313R2000	1	0.050
AF26 ... AF38	with or without VM4	BEY38-4	1SBN082713R2000	1	0.110
AF40 ... AF65	with or without VM96-4	BEY65-4	1SBN083413R2000	1	0.200
AF80 ... AF96	with or without VM96-4	BEY96-4	1SBN083913R2000	1	0.250

(1) For more information, refer to "Accessories" section.

# AF116 ... AF146 3-pole contactors

## 55 to 75 kW

### AC / DC operated with 2 N.O. + 2 N.C. auxiliary contacts



AF146-30-22

1SFC101009W0001



AF146-30-22B

1SFC101010W0001

#### Description

AF116 ... AF140 contactors are mainly used for controlling 3-phase motors and power circuits up to 690 V AC, AF146 up to 1000 V AC. These contactors are of the block type design with 3 main poles.

- control circuit: AC or DC operated with electronic coil interface accepting a wide control voltage range (e.g. 100...250 V AC and DC), only 3 coils to cover control voltages between 24...250 V 50/60 Hz and 20...250 V DC
- can manage large control voltage variations
- reduced panel energy consumption
- very distinct closing and opening
- can withstand short voltage dips and voltage sags (SEMI F47 conditions of use on request).
- built-in surge suppression
- add-on auxiliary contact blocks for side mounting and a wide range of accessories.

#### Ordering details

IEC	UL / CSA	Rated control circuit voltage	Auxiliary contacts fitted	Type	Order code	Weight
Rated operational power	3-phase motor rating	General use rating				Pkg (1 pce)
400 V AC-3	480 V	600 V AC	Uc min. ... Uc max.			kg
kW	hp	A	V 50/60 Hz; V DC			
				1 1		

#### For connection with built-in cable clamps

Rated power (kW)	Rated current (A)	Motor rating (hp)	General use rating (A)	Uc min. (V)	Uc max. (V)	No. N.O. contacts	No. N.C. contacts	Type	Order code	Weight (kg)
55	160	75	160	24...60	20...60	2	2	AF116-30-22-11	1SFL427001R1122	1.750
				48...130	48...130	2	2	AF116-30-22-12	1SFL427001R1222	1.750
				100...250	100...250	2	2	AF116-30-22-13	1SFL427001R1322	1.750
75	200	100	200	24...60	20...60	2	2	AF140-30-22-11	1SFL447001R1122	1.750
				48...130	48...130	2	2	AF140-30-22-12	1SFL447001R1222	1.750
				100...250	100...250	2	2	AF140-30-22-13	1SFL447001R1322	1.750
75	225	100	200	24...60	20...60	2	2	AF146-30-22-11	1SFL467001R1122	1.750
				48...130	48...130	2	2	AF146-30-22-12	1SFL467001R1222	1.750
				100...250	100...250	2	2	AF146-30-22-13	1SFL467001R1322	1.750
				250...500	250...500	2	2	AF146-30-22-14 <sup>1)</sup>	1SFL467001R1422	1.750

#### With bar connections

Rated power (kW)	Rated current (A)	Motor rating (hp)	General use rating (A)	Uc min. (V)	Uc max. (V)	No. N.O. contacts	No. N.C. contacts	Type	Order code	Weight (kg)
55	160	75	160	24...60	20...60	2	2	AF116-30-22B-11	1SFL427002R1122	1.500
				48...130	48...130	2	2	AF116-30-22B-12	1SFL427002R1222	1.500
				100...250	100...250	2	2	AF116-30-22B-13	1SFL427002R1322	1.500
75	200	100	200	24...60	20...60	2	2	AF140-30-22B-11	1SFL447002R1122	1.500
				48...130	48...130	2	2	AF140-30-22B-12	1SFL447002R1222	1.500
				100...250	100...250	2	2	AF140-30-22B-13	1SFL447002R1322	1.500
75	225	100	200	24...60	20...60	2	2	AF146-30-22B-11	1SFL467002R1122	1.500
				48...130	48...130	2	2	AF146-30-22B-12	1SFL467002R1222	1.500
				100...250	100...250	2	2	AF146-30-22B-13	1SFL467002R1322	1.500

#### Main dimensions mm, inches

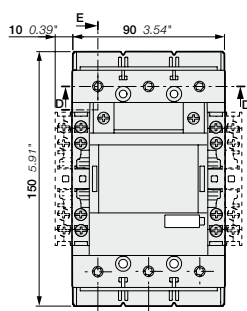

AF116, AF140, AF146-30-22

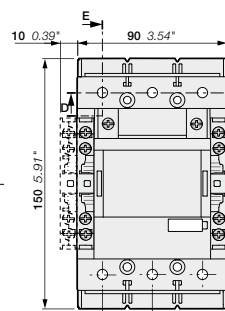
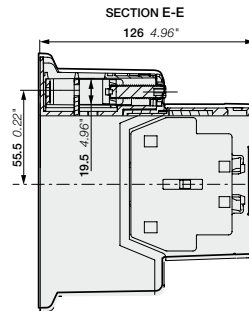

AF116, AF140, AF146-30-22B

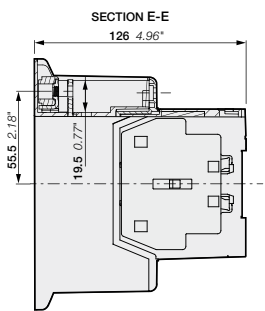



# AF190 ... AF370 3-pole contactors

## 90 to 200 kW

### AC / DC operated with 2 N.O. + 2 N.C. auxiliary contacts



AF205-30-22

1SFC101098V0001



AF370-30-22

1SFC101098V0001

#### Description

AF190 ... AF370 contactors are mainly used for controlling 3-phase motors and power circuits up to 1000 V AC. These contactors are of the block type design with 3 main poles.

- control circuit: AC or DC operated with electronic coil interface accepting a wide control voltage range (e.g. 100...250 V AC and DC), only 3 coils to cover control voltages between 24...250 V 50/60 Hz and 20...250 V DC
- can manage large control voltage variations
- reduced panel energy consumption
- very distinct closing and opening
- can withstand short voltage dips and voltage sags (SEMI F47 conditions of use on request).
- built-in surge suppression
- add-on auxiliary contact blocks for side mounting and a wide range of accessories.

#### Ordering details

IEC		UL / CSA		Rated control circuit voltage		Auxiliary contacts fitted		Type	Order code	Weight
Rated operational power	current $\theta \leq 40^\circ\text{C}$	3-phase motor rating	General use rating	Uc min. ... Uc max.						Pkg (1 pce)
				400 V AC-3	AC-1					
kW	A	hp	A							
90	275	125	250	24...60	20...60	2	2	AF190-30-22-11	1SFL487002R1122	3.000
				48...130	48...130	2	2	AF190-30-22-12	1SFL487002R1222	3.000
				100...250	100...250	2	2	AF190-30-22-13	1SFL487002R1322	3.000
110	350	150	300	24...60	20...60	2	2	AF205-30-22-11	1SFL527002R1122	3.000
				48...130	48...130	2	2	AF205-30-22-12	1SFL527002R1222	3.000
				100...250	100...250	2	2	AF205-30-22-13	1SFL527002R1322	3.000
140	400	200	350	24...60	20...60	2	2	AF265-30-22-11	1SFL547002R1122	4.675
				48...130	48...130	2	2	AF265-30-22-12	1SFL547002R1222	4.675
				100...250	100...250	2	2	AF265-30-22-13	1SFL547002R1322	4.675
160	50	250	400	24...60	20...60	2	2	AF305-30-22-11	1SFL587002R1122	4.675
				48...130	48...130	2	2	AF305-30-22-12	1SFL587002R1222	4.675
				100...250	100...250	2	2	AF305-30-22-13	1SFL587002R1322	4.675
200	600	350	520	24...60	20...60	2	2	AF370-30-22-11	1SFL607002R1122	4.675
				48...130	48...130	2	2	AF370-30-22-12	1SFL607002R1222	4.675
				100...250	100...250	2	2	AF370-30-22-13	1SFL607002R1322	4.675

#### Main dimensions mm, inches

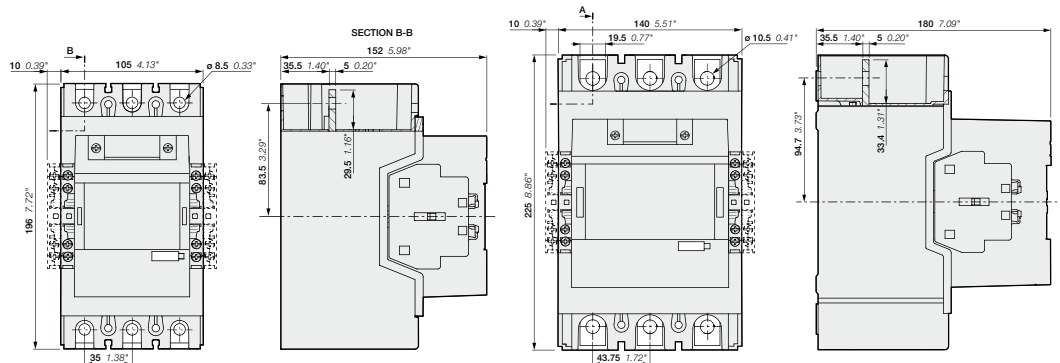

AF190, AF205

AF265, AF305, AF370

1SFC101098C0201

# AF116 ... AF370 3-pole contactors with 2 N.O. + 2 N.C. auxiliary contacts Main accessories

Main accessories (other accessories available)

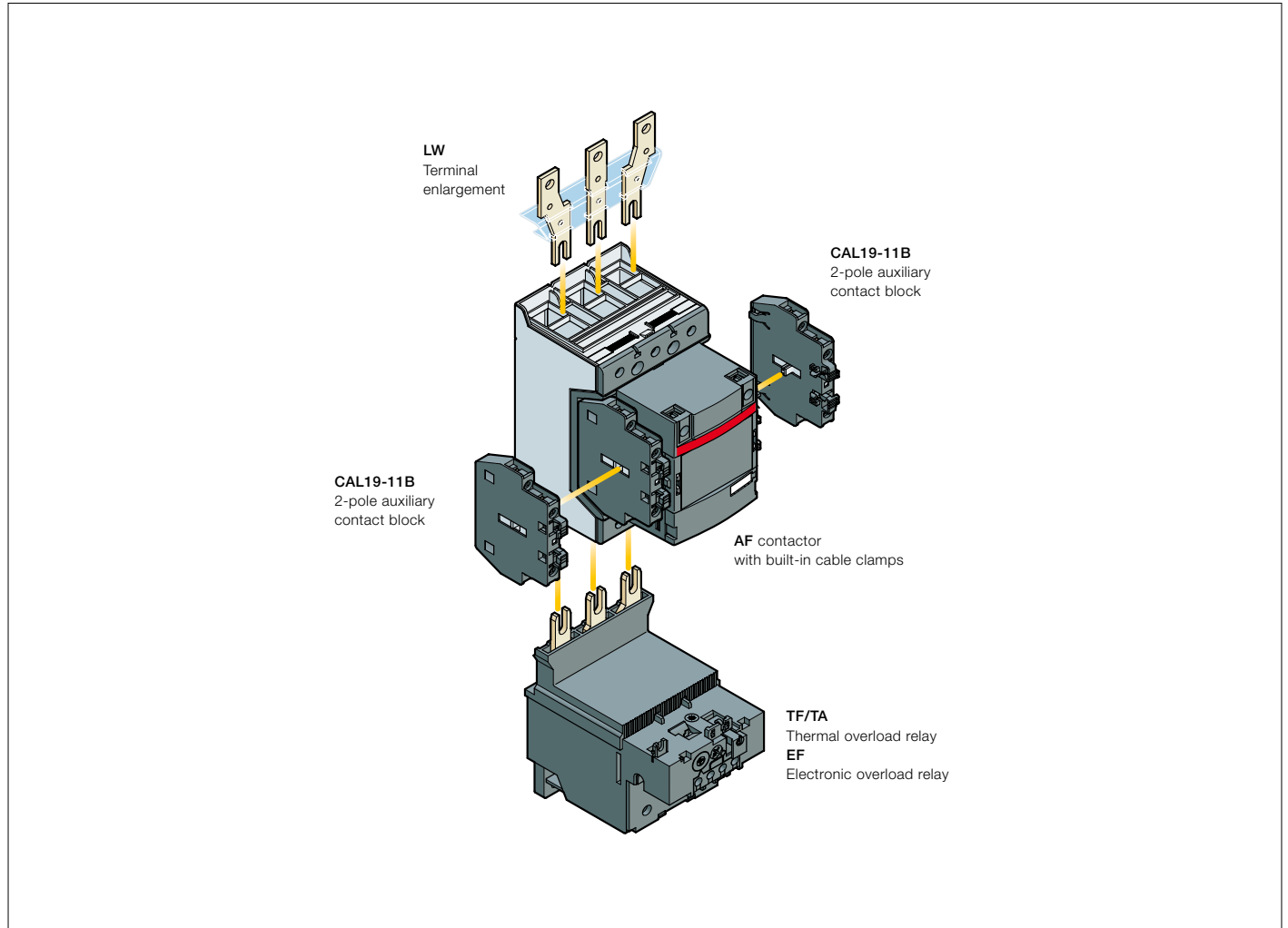

## Main accessory fitting details

Contactor types	Main poles	Available auxiliary contacts	Side-mounted accessories		
			Auxiliary contact blocks		Mechanical interlock units (between two contactors)
			CAL19-11	CAL19-11B	
AF116 ... AF370	3	0 2 2	-	+ 2 x CAL19-11B	-

## Overload relays fitting details (1)

Contactor types	Thermal overload relays	Electronic overload relays
AF116 ... AF140	TF140DU (66...142 A)	EF146 (54...150 A)
AF146	-	EF146 (54...150 A)
AF190, AF205	TA200DU (66...200 A)	EF205 (63...210 A)
AF265 ... AF370	-	EF370 (115...380 A)

The addition of a thermal or electronic overload relay on the contactor does not prevent fitting of many other accessories as shown in "Main accessory fitting details" table.

(1) Direct mounting - No kit required.



# AF116 ... AF370 3-pole contactors with 2 N.O. + 2 N.C. auxiliary contacts Main accessories



1SFC101071V0001

CAL19-11



1SFC101041V0001

LT370-30C



1SFC101048V0001

LX140

## Ordering details (1)

For contactors	Auxiliary contacts	Type	Order code	Pkg qty	Weight (1 pce)
					kg

## Side-mounted instantaneous auxiliary contact blocks

AF116 ... AF370	1	1	CAL19-11B	1SFN010820R3311	2	0.050
-----------------	---	---	-----------	-----------------	---	-------

## Terminal shrouds

AF116 ... AF146, with compression lugs	LT140-30L	1SFN124203R1000	2	0.070
AF190, AF205, with cable clamps	LT205-30C	1SFN124801R1000	2	0.050
AF190, AF205, with compression lugs	LT205-30L	1SFN124803R1000	2	0.220
AF190, AF205, with shorting bar or between contactor and TOL/EOL in DOL-starters	LT205-30Y	1SFN124804R1000	1	0.050
AF265 ... AF370, with cable clamps	LT370-30C	1SFN125401R1000	2	0.035
AF265 ... AF370, with compression lugs	LT370-30L	1SFN125403R1000	2	0.280
AF265 ... AF370, with shorting bar or between contactor and TOL/EOL in DOL-starters	LT370-30Y	1SFN125404R1000	1	0.075
AF265 ... AF370, for use with extending cable clamps, ATK300/2 and OZXB4	LT370-30D	1SFN125406R1000	1	0.150

For contactors	Dimensions		Type	Order code	Pkg qty	Weight (1 pce)
	hole Ø mm	bar mm				

## Terminal enlargements

AF116...AF146	6.5	13 x 3	LW140	1SFN074207R1000	1	0.115
AF190...AF205	10.5	17.5 x 5	LW205	1SFN074807R1000	1	0.260
AF265...AF370	10.5	20 x 5	LW370	1SFN075407R1000	1	0.340

## Terminal extension

AF116...AF146	6.5	13 x 3	LX140	1SFN074210R1000	1	0.072
AF190...AF250	8.5	17.5 x 5	LX205	1SFN074810R1000	1	0.180
AF265...AF370	10.5	20 x 5	LX370	1SFN075410R1000	1	0.234

(1) For more information, refer to "Accessories" section.

# AF400 ... AF750 3-pole contactors

## 200 to 400 kW

### AC / DC operated with 2 N.O. + 2 N.C. auxiliary contacts



1SFC101095W0001

AF460-30-22



1SFC101100W0001

AF750-30-22

#### Description

AF400 ... AF750 contactors are mainly used for controlling 3-phase motors and power circuits up to 690 V AC or 600 V DC (2). These contactors are of the block type design with 3 main poles.

- control circuit: AC or DC operated with electronic coil interface accepting a wide control voltage range (e.g. 100...250 V AC and DC), only 4 coils to cover control voltages between 48...500 V 50/60 Hz and 24...500 V DC
- can manage large control voltage variations
- reduced panel energy consumption
- very distinct closing and opening
- can withstand short voltage dips and voltages sags (SEMI F47 conditions of use on request).
- built-in surge suppression
- add-on auxiliary contact blocks for side mounting and a wide range of accessories.

#### Ordering details

IEC Rated operational power 400 V AC-3 kW	UL/CSA 3-phase motor rating hp	General use rating A	Rated control circuit voltage Uc		Auxiliary contacts fitted		Type	Order code	Weight Pkg (1 pce) kg	
			Rated operational current $\theta \leq 40^\circ\text{C}$ 690 V AC-1 A	3-phase motor rating 480 V	V 50/60 Hz	V DC				1
200	350	550	-	24...60	24...60	2	2	AF400-30-22	1SFL577001R6822 (1)	12.000
				48...130	48...130	2	2	AF400-30-22	1SFL577001R6922	12.000
				100...250	100...250	2	2	AF400-30-22	1SFL577001R7022	12.000
				250...500	250...500	2	2	AF400-30-22	1SFL577001R7122	12.000
250	400	650	-	24...60	24...60	2	2	AF460-30-22	1SFL597001R6822 (1)	12.000
				48...130	48...130	2	2	AF460-30-22	1SFL597001R6922	12.000
				100...250	100...250	2	2	AF460-30-22	1SFL597001R7022	12.000
				250...500	250...500	2	2	AF460-30-22	1SFL597001R7122	12.000
315	500	750	-	24...60	24...60	2	2	AF580-30-22	1SFL617001R6822 (1)	15.000
				48...130	48...130	2	2	AF580-30-22	1SFL617001R6922	15.000
				100...250	100...250	2	2	AF580-30-22	1SFL617001R7022	15.000
				250...500	250...500	2	2	AF580-30-22	1SFL617001R7122	15.000
400	600	900	-	24...60	24...60	2	2	AF750-30-22	1SFL637001R6822 (1)	15.000
				48...130	48...130	2	2	AF750-30-22	1SFL637001R6922	15.000
				100...250	100...250	2	2	AF750-30-22	1SFL637001R7022	15.000
				250...500	250...500	2	2	AF750-30-22	1SFL637001R7122	15.000

(1) The connection polarities indicated close to the coil terminals must be respected: A1 for the positive pole and A2 for the negative pole.

(2) Up to 850 V DC for AF580, AF750.

AF400...AF750 are equipped with low voltage inputs for control, for example by a PLC.

#### Control inputs

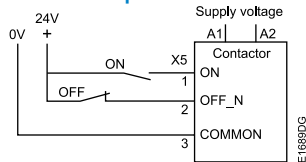

#### Main dimensions mm, inches

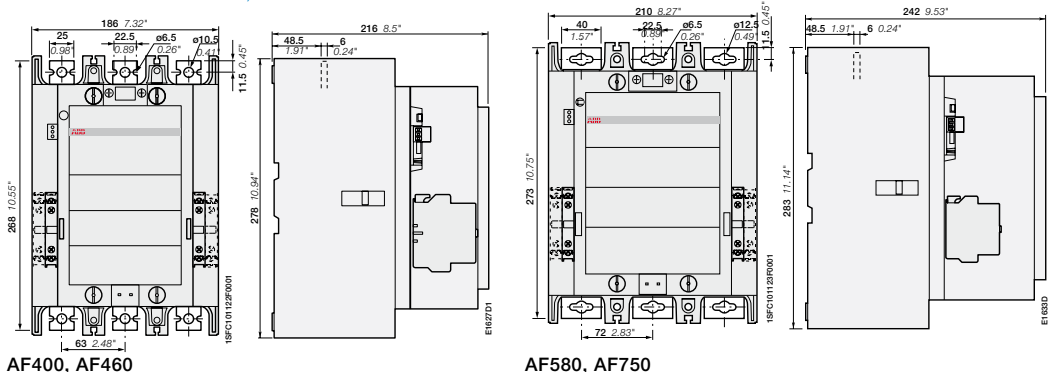

AF400, AF460

AF580, AF750

1SFC101014C0201

# AF1250 ... AF2650 3-pole contactors

## 475 to 560 kW and 1260 to 2650 A AC-1

### AC / DC operated with 2 N.O. + 2 N.C. auxiliary contacts



AF1250-30-22



AF2650-30-22

#### Description

AF1250 ... AF2050 contactors are mainly used for controlling power circuits up to 1000 V AC or 850 V DC, AF2650 for controlling power up to 1000 V AC. These contactors are of the block type design with 3 main poles.

- control circuit: AC or DC operated with electronic coil interface accepting a wide control voltage range (e.g. 100...250 V AC and DC)
- only 4 coils for AF1250 to cover control voltages between 48...500 V 50/60 Hz and 24...500 V DC
- only 1 coil for AF1350 ... AF2650 to cover control voltages between 100...250 V 50/60 Hz and 100...250 V DC
- can manage large control voltage variations
- reduced panel energy consumption
- very distinct closing and opening
- can withstand short voltage dips and voltages sags (SEMI F47 conditions of use on request).
- built-in surge suppression
- add-on auxiliary contact blocks for side mounting and a wide range of accessories.

#### Ordering details

IEC Rated operational power	UL/CSA 3-phase motor rating 480 V	General use rating 600 V AC	Rated control circuit voltage Uc (1)		Auxiliary contacts fitted	Type	Order code	Weight Pkg (1 pce) kg
			V 50/60 Hz	V DC				
400 V AC-3	690 V AC-1	hp	A	-	2 2	AF1250-30-22	1SFL647001R6822 (1)	16.000
KW	A	hp	A	-	2 2	AF1250-30-22	1SFL647001R6922	16.000
-	1260	-	1210	48...130	48...130	AF1250-30-22	1SFL647001R7022	16.000
-	-	-	-	100...250	100...250	AF1250-30-22	1SFL647001R7122	16.000
-	-	-	-	250...500	250...500	AF1250-30-22	1SFL647001R7122	16.000
475	1350	800	1350	100...250	100...250	AF1350-30-22	1SFL657001R7022	34.000
560	1650	900	1650	100...250	100...250	AF1650-30-22	1SFL677001R7022	35.000
-	2050	-	2100	100...250	100...250	AF2050-30-22	1SFL707001R7022	35.000
-	2650	-	2700	100...250	100...250	AF2650-30-22	1SFL667001R7022	45.000

(1) The connection polarities indicated close to the coil terminals must be respected: A1 for the positive pole and A2 for the negative pole.  
 (2) AF2650 : Maximum operational voltage = 1000 V according to UL / CSA.

AF1250 ... AF2650 are equipped with low voltage inputs for control, for example by a PLC.

#### Control inputs

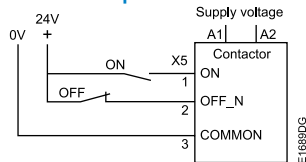

	AF1350, AF1650, AF2050	AF2650
A	392 mm / 15.43"	422 mm / 16.61"
B	47 mm / 1.85"	53.5 mm / 2.11"
C	10 mm / 0.39"	25 mm / 0.98"
D	3 mm / 0.12"	-

#### Main dimensions mm, inches

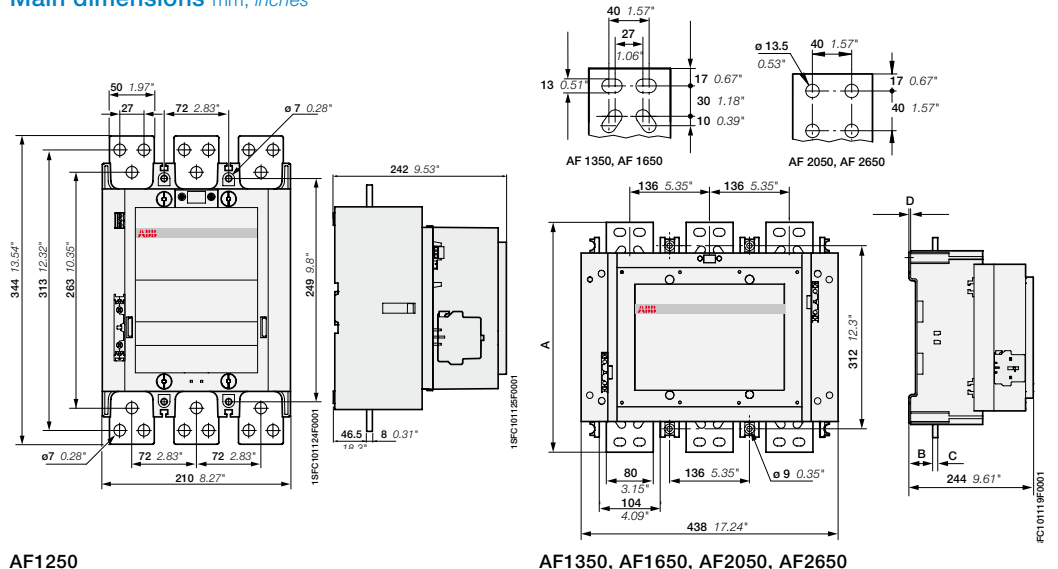

AF1250

AF1350, AF1650, AF2050, AF2650

# AF400... AF2650 3-pole contactors with 2 N.O. + 2 N.C. auxiliary contacts Main accessories

**Main accessories** (other accessories available)

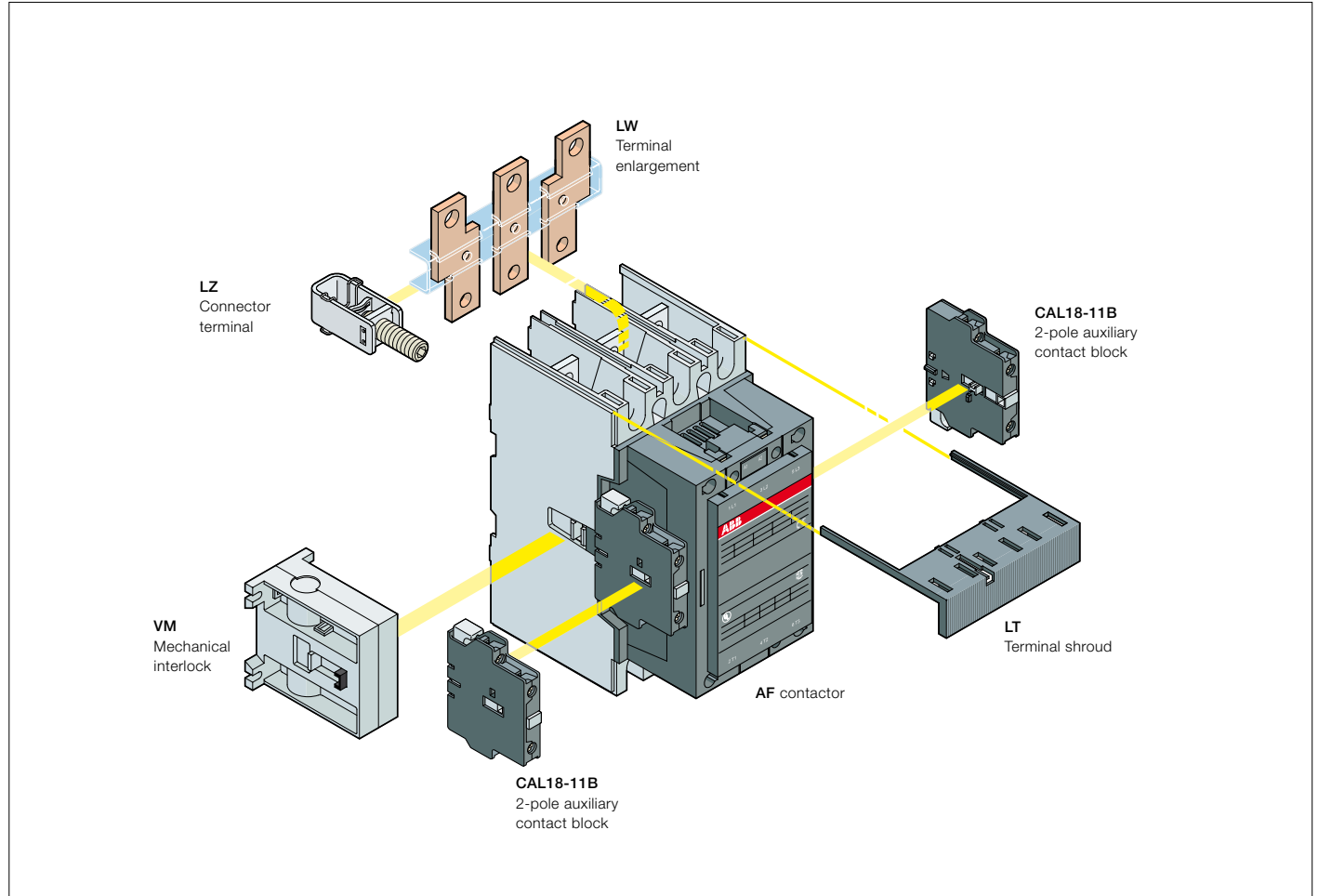

## Main accessory fitting details

Contactor types	Main poles	Available auxiliary contacts	Side-mounted accessories		Mechanical interlock units (between two contactors)
			Auxiliary contact blocks		
			CAL18-11	CAL18-11B (2)	

### Contactors + auxiliary contact blocks

Contactor types	Main poles	Available auxiliary contacts	Auxiliary contact blocks	Mechanical interlock units
AF145 ... AF2650	3	0 2 2	2 x CAL18-11B	-

### Contactors with mechanical interlocking + auxiliary contact blocks

Contactor types	Main poles	Available auxiliary contacts	Auxiliary contact blocks	Mechanical interlock units
AF400 ... AF2650	3	0 2 2	4 x CAL18-11B	+ VM...H (1)

(1) Interlock type, according to the contactor ratings (see "Accessories").

(2) The CEL18-... auxiliary contact blocks can replace the CAL18-11 and CAL18-11B. Though, no auxiliary contact block can be mounted outside the CEL18-...

## Overload relays fitting details

Contactor types	Thermal overload relays	Electronic overload relays
AF400, AF460	-	E500DU (150...500 A) (3)
AF580, AF750	-	E800DU (250...800 A) (3)
AF1350, AF1650	-	E1250DU (375...1250 A) (3)

The addition of a thermal or electronic overload relay on the contactor does not prevent fitting of many other accessories as shown in "Main accessory fitting details" table.

(3) Mounting kit required (see "Motor protection").

# AF400 ... AF2650 3-pole contactors with 2 N.O. + 2 N.C. auxiliary contacts Main accessories



CAL18-11

1SFC101082V0001

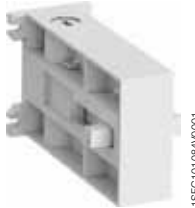

VM750H

1SFC101084V0001



LT460-AC

1SFC101089V0001

## Ordering details (1)

For contactors	Auxiliary contacts	Type	Order code	Pkg qty	Weight (1 pce)
					kg

## Side-mounted instantaneous auxiliary contact blocks

AF400 ... AF2650	1	1	CAL18-11B	1SFN010720R3311	2	0.050
------------------	---	---	-----------	-----------------	---	-------

## Mechanical interlock unit

AF400 ... AF1250			VM750H	1SFN035700R1000	1	0.200
AF1350 ... AF2650			VM1650H	1SFN036503R1000	1	6.000

## Terminal shrouds

AF400, AF460 with connectors			LT460-AC	1SFN125701R1000	2	0.100
AF400, AF460 with lugs			LT460-AL	1SFN125703R1000	2	0.800
AF580 ... AF750 with connectors			LT750-AC	1SFN126101R1000	2	0.120
AF580 ... AF750 with lugs			LT750-AL	1SFN126103R1000	2	0.825

For contactors	Dimensions		Type	Order code	Pkg qty	Weight (1 pce)
	hole Ø mm	bar mm				

## Terminal enlargements

AF400, AF460	10.5	25 x 5	LW460	1SFN075707R1000	1	0.730
AF580, AF750	13	40 x 6	LW750	1SFN076107R1000	1	1.230
AF1250	13	50 x 10	LW1250	1SFN076407R1000	1	2.000

## Terminal extension

AF400, AF460	10.5	25 x 5	LX460	1SFN075710R1000	1	0.500
AF580, AF750	13	40 x 6	LX750	1SFN076110R1000	1	0.850

(1) For more information, refer to "Accessories" section.

# AF09 ... AF38 3-pole contactors

## Technical data

### Main pole - Utilization characteristics according to IEC

Contactor types	AC / DC operated	AF09	AF12	AF16	AF26	AF30	AF38
Standards		IEC 60947-1 / 60947-4-1 and EN 60947-1 / 60947-4-1					
Rated operational voltage $U_e$ max.		690 V					
Rated frequency (without derating)		50 / 60 Hz					
Conventional free-air thermal current $I_{th}$							
acc. to IEC 60947-4-1, open contactors, $\theta \leq 40^\circ\text{C}$		35 A	35 A	35 A	50 A	50 A	50 A
With conductor cross-sectional area		6 mm <sup>2</sup>	6 mm <sup>2</sup>	6 mm <sup>2</sup>	10 mm <sup>2</sup>	10 mm <sup>2</sup>	10 mm <sup>2</sup>
<b>AC-1 Utilization category</b>							
For air temperature close to contactor							
<b><math>I_e</math> / Rated operational current AC-1</b>	$\theta \leq 40^\circ\text{C}$	25 A	28 A	30 A	45 A	50 A	50 A
$U_e$ max. $\leq 690$ V, 50/60 Hz	$\theta \leq 60^\circ\text{C}$	25 A	28 A	30 A	40 A	42 A	42 A
	$\theta \leq 70^\circ\text{C}$	22 A	24 A	26 A	32 A	37 A	37 A
With conductor cross-sectional area		4 mm <sup>2</sup>	6 mm <sup>2</sup>	6 mm <sup>2</sup>	10 mm <sup>2</sup>	10 mm <sup>2</sup>	10 mm <sup>2</sup>
<b>AC-3 Utilization category</b>							
For air temperature close to contactor $\theta \leq 60^\circ\text{C}$							
<b><math>I_e</math> / Max. rated operational current AC-3 (1)</b>							
	220-230-240 V	9 A	12 A	18 A	26 A	33 A	40 A
	380-400 V	9 A	12 A	18 A	26 A	32 A	38 A
	415 V	9 A	12 A	18 A	26 A	32 A	38 A
	440 V	9 A	12 A	18 A	26 A	32 A	38 A
	500 V	9.5 A	12.5 A	15 A	23 A	28 A	33 A
	690 V	7 A	9 A	10.5 A	17 A	21 A	24 A
<b>Rated operational power AC-3 (1)</b>							
	220-230-240 V	2.2 kW	3 kW	4 kW	6.5 kW	9 kW	11 kW
	380-400 V	4 kW	5.5 kW	7.5 kW	11 kW	15 kW	18.5 kW
	415 V	4 kW	5.5 kW	9 kW	11 kW	15 kW	18.5 kW
	440 V	4 kW	5.5 kW	9 kW	15 kW	18.5 kW	22 kW
	500 V	5.5 kW	7.5 kW	9 kW	15 kW	18.5 kW	22 kW
	690 V	5.5 kW	7.5 kW	9 kW	15 kW	18.5 kW	22 kW
<b>Rated making capacity AC-3</b>		10 x $I_e$ AC-3 acc. to IEC 60947-4-1					
<b>Rated breaking capacity AC-3</b>		8 x $I_e$ AC-3 acc. to IEC 60947-4-1					
<b>AC-8a Utilization category</b>							
(without thermal overload relay - $U_e$ 400 V 50/60 Hz - $\theta \leq 40^\circ\text{C}$ )							
<b><math>I_e</math> / Rated operational current AC-8a</b>		12 A	16 A	22 A	30 A	40 A	50 A
<b>Rated operational power AC-8a</b>		5.5 kW	7.5 kW	11 kW	15 kW	20 kW	25 kW
<b>Short-circuit protection device for contactors</b>							
without thermal overload relay - Motor protection excluded (2)							
$U_e \leq 500$ V AC - gG type fuse		25 A	32 A	32 A	50 A	63 A	63 A
<b>Rated short-time withstand current <math>I_{cw}</math></b>							
at 40 °C ambient temperature, in free air from a cold state							
	1 s	300 A	300 A	300 A	700 A	700 A	700 A
	10 s	150 A	150 A	150 A	350 A	350 A	350 A
	30 s	80 A	80 A	80 A	225 A	225 A	225 A
	1 min	60 A	60 A	60 A	150 A	150 A	150 A
	15 min	35 A	35 A	35 A	50 A	50 A	50 A
<b>Maximum breaking capacity</b>							
$\cos \varphi = 0.45$							
	at 440 V	250 A	250 A	250 A	500 A	500 A	500 A
	at 690 V	106 A	106 A	106 A	200 A	200 A	200 A
<b>Power dissipation per pole</b>							
	$I_e$ / AC-1	0.8 W	1 W	1.2 W	1.8 W	2.4 W	2.4 W
	$I_e$ / AC-3	0.1 W	0.2 W	0.35 W	0.6 W	0.9 W	1.3 W
<b>Max. electrical switching frequency</b>							
	AC-1	600 cycles/h					
	AC-3	1200 cycles/h					
	AC-2, AC-4	300 cycles/h				150 cycles/h	

(1) For the corresponding kW/A or hp/A values of 1500 r.p.m. 50 Hz or 1800 r.p.m. 60 Hz, 3-phase motors, see "Motor rated operational powers and currents".

(2) For the protection of motor starters against short circuits, see "Coordination with short-circuit protection devices".



3-phase motors



1500 r.p.m. 50 Hz  
1800 r.p.m. 60 Hz  
3-phase motors

# AF40 ... AF96 3-pole contactors

## Technical data

### Main pole - Utilization characteristics according to IEC

Contactors types	AC / DC operated	AF40	AF52	AF65	AF80	AF96
Standards		IEC 60947-1 / 60947-4-1 and EN 60947-1 / 60947-4-1				
Rated operational voltage $U_e$ max.		690 V				
Rated frequency (without derating)		50 / 60 Hz				
Conventional free-air thermal current $I_{th}$						
acc. to IEC 60947-4-1, open contactors, $\theta \leq 40$ °C		105 A	105 A	105 A	130 A	130 A
With conductor cross-sectional area		35 mm <sup>2</sup>	35 mm <sup>2</sup>	35 mm <sup>2</sup>	50 mm <sup>2</sup>	50 mm <sup>2</sup>
<b>AC-1 Utilization category</b>						
For air temperature close to contactor						
<b><math>I_e</math> / Rated operational current AC-1</b>	$\theta \leq 40$ °C	70 A	100 A	105 A	125 A	130 A
$U_e$ max. $\leq 690$ V, 50/60 Hz	$\theta \leq 60$ °C	60 A	80 A	90 A	100 A	105 A
	$\theta \leq 70$ °C	50 A	70 A	80 A	85 A	90 A
With conductor cross-sectional area		25 mm <sup>2</sup>	35 mm <sup>2</sup>	35 mm <sup>2</sup>	50 mm <sup>2</sup>	50 mm <sup>2</sup>
<b>AC-3 Utilization category</b>						
For air temperature close to contactor $\theta \leq 60$ °C						
<b><math>I_e</math> / Max. rated operational current AC-3 (1)</b>						
	220-230-240 V	40 A	53 A	65 A	80 A	96 A
	380-400 V	40 A	53 A	65 A	80 A	96 A
	415 V	40 A	53 A	65 A	80 A	96 A
	440 V	40 A	53 A	65 A	80 A	96 A
	500 V	35 A	45 A	55 A	65 A	80 A
	690 V	25 A	35 A	39 A	49 A	57 A
<b>Rated operational power AC-3 (1)</b>						
	220-230-240 V	11 kW	15 kW	18.5 kW	22 kW	25 kW
	380-400 V	18.5 kW	22 kW	30 kW	37 kW	45 kW
	415 V	22 kW	30 kW	37 kW	45 kW	55 kW
	440 V	22 kW	30 kW	37 kW	45 kW	55 kW
	500 V	22 kW	30 kW	37 kW	45 kW	55 kW
	690 V	22 kW	30 kW	37 kW	45 kW	55 kW
<b>Rated making capacity AC-3</b>		10 x $I_e$ AC-3 acc. to IEC 60947-4-1				
<b>Rated breaking capacity AC-3</b>		8 x $I_e$ AC-3 acc. to IEC 60947-4-1				
<b>AC-8a Utilization category</b>						
(without thermal overload relay - $U_e$ 400 V 50/60 Hz - $\theta \leq 40$ °C)						
<b><math>I_e</math> / Rated operational current AC-8a</b>		53 A	70 A	85 A	105 A	120 A
<b>Rated operational power AC-8a</b>		25 kW	37 kW	45 kW	55 kW	65 kW
<b>Short-circuit protection device for contactors</b>						
without thermal overload relay - Motor protection excluded (2)						
$U_e \leq 500$ V AC - gG type fuse		100 A	125 A	160 A	160 A	200 A
<b>Rated short-time withstand current <math>I_{cw}</math></b>						
at 40 °C ambient temperature,	1 s	1000 A	1000 A	1000 A	1200 A	1200 A
in free air from a cold state	10 s	600 A	600 A	600 A	780 A	780 A
	30 s	350 A	350 A	350 A	450 A	450 A
	1 min	250 A	250 A	250 A	300 A	300 A
	15 min	110 A	110 A	110 A	140 A	140 A
<b>Maximum breaking capacity</b>						
$\cos \varphi = 0.45$	at 440 V	(3)				
	at 690 V	(3)				
<b>Power dissipation per pole</b>						
	$I_e$ / AC-1	3 W	6.3 W	7 W	7.6 W	8.2 W
	$I_e$ / AC-3	1 W	1.7 W	2.7 W	3 W	4.5 W
<b>Max. electrical switching frequency</b>						
	AC-1	600 cycles/h				
	AC-3	1200 cycles/h				
	AC-2, AC-4	150 cycles/h				



3-phase motors



1500 r.p.m. 50 Hz  
1800 r.p.m. 60 Hz  
3-phase motors

(1) For the corresponding kW/A or hp/A values of 1500 r.p.m, 50 Hz or 1800 r.p.m, 60 Hz, 3-phase motors, see "Motor rated operational powers and currents".

(2) For the protection of motor starters against short circuits, see "Coordination with short-circuit protection devices".

(3) On request.



# AF116 ... AF370 3-pole contactors

## Technical data

### Main pole - Utilization characteristics according to IEC

Contactor types	AC / DC operated	AF116	AF140	AF146	AF190	AF205	AF265	AF305	AF370
Standards		IEC 60947-1 / 60947-4-1 and EN 60947-1 / 60947-4-1							
Rated operational voltage $U_e$ max.		690 V	690 V	1000 V	1000 V	1000 V	1000 V	1000 V	1000 V
Rated frequency (without derating)		50 / 60 Hz							
Conventional free-air thermal current $I_{th}$									
acc. to IEC 60947-4-1, open contactors, $\theta \leq 40^\circ\text{C}$		160 A	200 A	225 A	275 A	350 A	400 A	500 A	600 A
With conductor cross-sectional area		70 mm <sup>2</sup>	95 mm <sup>2</sup>	95 mm <sup>2</sup>	150 mm <sup>2</sup>	240 mm <sup>2</sup>	240 mm <sup>2</sup> (3)	300 mm <sup>2</sup>	2 x 185 mm <sup>2</sup> (4)
<b>AC-1 Utilization category</b>									
For air temperature close to contactor									
<b><math>I_e</math> / Rated operational current AC-1</b>	$\theta \leq 40^\circ\text{C}$	160 A	200 A	225 A	275 A	350 A	400 A	500 A	600 A
$U_e$ max. $\leq 690\text{ V}$ , 50/60 Hz	$\theta \leq 60^\circ\text{C}$	145 A	175 A	200 A	250 A	300 A	350 A	400 A	500 A
	$\theta \leq 70^\circ\text{C}$	130 A	160 A	175 A	200 A	240 A	290 A	325 A	400 A
<b><math>I_e</math> / Rated operational current AC-1</b>	$\theta \leq 40^\circ\text{C}$	—	—	225 A	250 A	275 A	350 A	375 A	400 A
$U_e$ max. $\leq 1000\text{ V}$ , 50/60 Hz	$\theta \leq 60^\circ\text{C}$	—	—	200 A	225 A	250 A	300 A	325 A	350 A
	$\theta \leq 70^\circ\text{C}$	—	—	175 A	185 A	200 A	240 A	260 A	290 A
With conductor cross-sectional area		70 mm <sup>2</sup>	95 mm <sup>2</sup>	95 mm <sup>2</sup>	150 mm <sup>2</sup>	240 mm <sup>2</sup>	240 mm <sup>2</sup> (3)	300 mm <sup>2</sup>	2 x 185 mm <sup>2</sup> (4)
<b>AC-3 Utilization category</b>									
For air temperature close to contactor $\theta \leq 60^\circ\text{C}$									
<b><math>I_e</math> / Max. rated operational current AC-3 (1)</b>									
	220-230-240 V	116 A	140 A	146 A	190 A	205 A	265 A	305 A	370 A
	380-400 V	116 A	140 A	146 A	190 A	205 A	265 A	305 A	370 A
	415 V	116 A	140 A	146 A	190 A	205 A	265 A	305 A	370 A
	440 V	116 A	140 A	146 A	190 A	205 A	265 A	305 A	370 A
	500 V	110 A	130 A	130 A	160 A	185 A	260 A	290 A	350 A
	690 V	65 A	80 A	93 A	135 A	165 A	250 A	290 A	315 A
	1000 V	—	—	60 A	85 A	100 A	100 A	100 A	100 A
<b>Rated operational power AC-3 (1)</b>									
	220-230-240 V	30 kW	37 kW	45 kW	55 kW	55 kW	75 kW	90 kW	110 kW
	380-400 V	55 kW	75 kW	75 kW	90 kW	110 kW	132 kW	160 kW	200 kW
	415 V	55 kW	75 kW	75 kW	90 kW	110 kW	132 kW	160 kW	200 kW
	440 V	75 kW	90 kW	90 kW	110 kW	132 kW	160 kW	160 kW	200 kW
	500 V	75 kW	90 kW	90 kW	110 kW	132 kW	160 kW	200 kW	250 kW
	690 V	55 kW	75 kW	90 kW	132 kW	160 kW	200 kW	250 kW	315 kW
	1000 V	—	—	75 kW	110 kW	132 kW	132 kW	132 kW	132 kW
<b>Rated making capacity AC-3</b>		10 x $I_e$ AC-3 acc. to IEC 60947-4-1							
<b>Rated breaking capacity AC-3</b>		8 x $I_e$ AC-3 acc. to IEC 60947-4-1							
<b>Short-circuit protection device for contactors</b>									
without thermal overload relay - Motor protection excluded (2)									
$U_e \leq 500\text{ V AC}$ - gG type fuse		250 A	315 A	315 A	355 A	400 A	500 A	500 A	630 A
<b>Rated short-time withstand current <math>I_{cw}</math></b>									
at $40^\circ\text{C}$ ambient temperature,	1 s	1300 A	1460 A	1460 A	1900 A	2050 A	2650 A	3050 A	3700 A
in free air from a cold state	10 s	928 A	1168 A	1168 A	1520 A	1640 A	2120 A	2440 A	2960 A
	30 s	536 A	674 A	674 A	878 A	947 A	1224 A	1409 A	1709 A
	1 min	379 A	477 A	477 A	621 A	670 A	865 A	996 A	1208 A
	15 min	160 A	200 A	225 A	275 A	350 A	400 A	500 A	600 A
<b>Maximum breaking capacity</b>									
$\cos \varphi = 0.45$	at 440 V	2000 A	3000 A	3000 A	3300 A	3500 A	3800 A	4600 A	5000 A
( $\cos \varphi = 0.35$ for $I_e > 100\text{ A}$ )	at 690 V	1000 A	1500 A	1500 A	2200 A	2500 A	3300 A	3800 A	4000 A
<b>Power dissipation per pole</b>									
	$I_e$ / AC-1	12 W	18 W	23 W	15 W	25 W	32 W	50 W	72 W
	$I_e$ / AC-3	6 W	9 W	10 W	7 W	8 W	14 W	19 W	27 W
<b>Maximum electrical switching frequency</b>									
	AC-1	300 cycles/h							
	AC-3	300 cycles/h							
	AC-2, AC-4	150 cycles/h							



3-phase motors



1500 r.p.m. 50 Hz  
1800 r.p.m. 60 Hz  
3-phase motors

(1) For the corresponding kW/A or hp/A values of 1500 r.p.m., 50 Hz or 1800 r.p.m., 60 Hz, 3-phase motors, see "Motor rated operational powers and currents".

(2) For the protection of motor starters against short circuits, see "Coordination with short-circuit protection devices".

(3) For currents above 275A use terminal enlargements or terminal extensions.

(4) For currents above 450A use terminal enlargements or terminal extensions.



# AF400 ... AF2650 3-pole contactors

## Technical data

### Main pole - Utilization characteristics according to IEC

Contactor types	AC / DC operated	AF400	AF460	AF580	AF750	AF1250	AF1350	AF1650	AF2050	AF2650
Standards		IEC 60947-1 / 60947-4-1 and EN 60947-1 / 60947-4-1								
Rated operational voltage U <sub>e</sub> max.		1000 V								
Rated frequency (without derating)		50/60 Hz								
Conventional free-air thermal current I <sub>th</sub>										
acc. to IEC 60947-4-1, open contactors, $\theta \leq 40^\circ\text{C}$		600 A	700 A	800 A	1050 A	1260 A	1350 A	1650 A	2050 A	2650 A
With conductor cross-sectional area (3)		2x185 mm <sup>2</sup>	2x240 mm <sup>2</sup>	2x240 mm <sup>2</sup>	800 mm <sup>2</sup> (4)	1000 mm <sup>2</sup> (4)	1000 mm <sup>2</sup> (5)	1500 mm <sup>2</sup> (5)	2000 mm <sup>2</sup> (5)	3000 mm <sup>2</sup> (5)
<b>AC-1 Utilization category</b>										
For air temperature close to contactor										
<b>I<sub>e</sub> / Rated operational current AC-1</b>	$\theta \leq 40^\circ\text{C}$	600 A	700 A	800 A	1050 A	1260 A	1350 A	1650 A	2050 A	2650 A
U <sub>e</sub> max. $\leq 690\text{ V}$ , 50/60 Hz	$\theta \leq 55^\circ\text{C}$	500 A	600 A	700 A	875 A	1040 A	1150 A	1450 A	1750 A	2350 A
	$\theta \leq 70^\circ\text{C}$	400 A	480 A	580 A	720 A	875 A	1000 A	1270 A	1500 A	2120 A
<b>I<sub>e</sub> / Rated operational current AC-1</b>	$\theta \leq 40^\circ\text{C}$	600 A	700 A	800 A	1000 A	1260 A	1350 A	1650 A	2050 A	2650 A
U <sub>e</sub> max. $\leq 1000\text{ V}$ , 50/60 Hz	$\theta \leq 55^\circ\text{C}$	500 A	600 A	700 A	875 A	1040 A	1150 A	1450 A	1750 A	2350 A
	$\theta \leq 70^\circ\text{C}$	400 A	480 A	580 A	720 A	875 A	1000 A	1270 A	1500 A	2120 A
With conductor cross-sectional area		2x185 mm <sup>2</sup>	2x240 mm <sup>2</sup>	2x240 mm <sup>2</sup>	800 mm <sup>2</sup> (4)	1000 mm <sup>2</sup> (4)	1000 mm <sup>2</sup> (5)	1500 mm <sup>2</sup> (5)	2000 mm <sup>2</sup> (5)	3000 mm <sup>2</sup> (5)
<b>AC-3 Utilization category</b>										
For air temperature close to contactor $\theta \leq 55^\circ\text{C}$										
<b>I<sub>e</sub> / Max. rated operational current AC-3 (1)</b>										
	220-230-240 V	400 A	460 A	580 A	750 A	–	860 A	1050 A	–	–
	380-400 V	400 A	460 A	580 A	750 A	–	860 A	1050 A	–	–
	415 V	400 A	460 A	580 A	750 A	–	860 A	1050 A	–	–
	440 V	400 A	460 A	580 A	750 A	–	860 A	1050 A	–	–
	500 V	400 A	460 A	580 A	750 A	–	800 A	950 A	–	–
	690 V	350 A	400 A	500 A	650 A	–	800 A	950 A	–	–
	1000 V	155 A	200 A	250 A	300 A	–	–	–	–	–
<b>Rated operational power AC-3 (1)</b>										
	220-230-240 V	110 kW	132 kW	160 kW	220 kW	–	257 kW	315 kW	–	–
	380-400 V	200 kW	250 kW	315 kW	400 kW	–	475 kW	560 kW	–	–
	415 V	220 kW	250 kW	355 kW	425 kW	–	500 kW	600 kW	–	–
	440 V	220 kW	250 kW	355 kW	450 kW	–	560 kW	670 kW	–	–
	500 V	250 kW	315 kW	400 kW	520 kW	–	560 kW	700 kW	–	–
	690 V	315 kW	355 kW	500 kW	600 kW	–	750 kW	900 kW	–	–
	1000 V	220 kW	280 kW	355 kW	400 kW	–	–	–	–	–
<b>Rated making capacity AC-3</b>		10 x I <sub>e</sub> AC-3 acc. to IEC 60947-4-1								
<b>Rated breaking capacity AC-3</b>		8 x I <sub>e</sub> AC-3 acc. to IEC 60947-4-1								
<b>Short-circuit protection device for contactors</b>										
without thermal overload relay										
Motor protection excluded (2)										
U <sub>e</sub> $\leq 500\text{ V}$ AC - gG type fuse		630 A	800 A	1000 A	1000 A	Please consult us for coordination with circuit-breaker				
<b>Rated short-time withstand current I<sub>sw</sub></b>	1 s	4600 A	4600 A	7000 A	7000 A	8000 A	10000 A	12000 A	12000 A	12000 A
	10 s	4400 A	4400 A	6400 A	6400 A	7200 A	8000 A	10000 A	10000 A	10000 A
	30 s	3100 A	3100 A	4500 A	4500 A	5200 A	6000 A	7500 A	7500 A	7500 A
	1 min	2500 A	2500 A	3500 A	3500 A	4000 A	4500 A	5500 A	5500 A	5500 A
	15 min	840 A	840 A	1300 A	1300 A	1500 A	1600 A	2200 A	2200 A	2800 A
<b>Maximum breaking capacity</b>										
cos $\phi = 0.45$	at 440 V	4000 A	5000 A	6000 A	7500 A	–	10000 A	12000 A	8400 A	8400 A
(cos $\phi = 0.35$ for I <sub>e</sub> > 100 A)	at 690 V	3500 A	4500 A	5000 A	7000 A	–	–	–	–	–
<b>Power dissipation per pole</b>										
	I <sub>e</sub> / AC-1	30 W	42 W	32 W	50 W	80 W	80 W	80 W	125 W	200 W
	I <sub>e</sub> / AC-3	16 W	21 W	17 W	28 W	–	50 W	50 W	–	–
<b>Max. electrical switching frequency</b>										
	AC-1	300 cycles/h			300 cycles/h		300 cycles/h		60 cycles/h	
	AC-3	300 cycles/h			300 cycles/h		–		60 cycles/h	
	AC-2, AC-4	60 cycles/h			60 cycles/h		–		60 cycles/h	

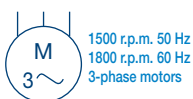

(1) For the corresponding kW/A or hp/A values of 1500 r.p.m, 50 Hz or 1800 r.p.m, 60 Hz, 3-phase motors, see "Motor rated operational powers and currents".

(2) For the protection of motor starters against short circuits, see "Coordination with short-circuit protection devices".

(3) Conductors with preparation.

(4) Max. connection bar width 50 mm.

(5) Max. connection bar width 100 mm.

# AF09 ... AF38 3-pole contactors

## Technical data

### Main pole - Utilization characteristics according to UL / NEMA / CSA

Contactors types	AC / DC operated	AF09	AF12	AF16	AF26	AF30	AF38
Standards		UL 508, CSA C22.2 N°14					
Max. operational voltage		600 V					
NEMA size		00	0	-	1	-	-
NEMA continuous amp rating	Thermal current	9 A	18 A		27 A		
NEMA maximum horse power ratings							
1-phase, 60 Hz	115 V AC	1/3 hp	1 hp		2 hp		
	230 V AC	1 hp	2 hp		3 hp		
NEMA maximum horse power ratings							
3-phase, 60 Hz	200 V AC	1-1/2 hp	3 hp		7-1/2 hp		
	230 V AC	1-1/2 hp	3 hp		7-1/2 hp		
	460 V AC	2 hp	5 hp		10 hp		
	575 V AC	2 hp	5 hp		10 hp		
UL / CSA general use rating							
600 V AC		25 A	28 A	30 A	45 A	50 A	50 A
With conductor cross-sectional area		AWG 10	AWG 10	AWG 10	AWG 8	AWG 8	AWG 8
UL / CSA maximum 1-phase motor rating							
Full load current	120 V AC	13.8 A	16 A	20 A	24 A	24 A	24 A
	240 V AC	10 A	12 A	17 A	17 A	28 A	28 A
Horse power rating	120 V AC	3/4 hp	1 hp	1-1/2 hp	2 hp	2 hp	2 hp
	240 V AC	1-1/2 hp	2 hp	3 hp	3 hp	5 hp	5 hp
UL / CSA maximum 3-phase motor rating							
Full load current (1)	200-208 V AC	7.8 A	11 A	17.5 A	25.3 A	32.2 A	32.2 A
	220-240 V AC	6.8 A	9.6 A	15.2 A	22 A	28 A	28 A
	440-480 V AC	7.6 A	11 A	14 A	21 A	27 A	27 A
	550-600 V AC	9 A	11 A	17 A	22 A	27 A (2)	27 A (2)
Horse power rating (1)	200-208 V AC	2 hp	3 hp	5 hp	7-1/2 hp	10 hp	10 hp
	220-240 V AC	2 hp	3 hp	5 hp	7-1/2 hp	10 hp	10 hp
	440-480 V AC	5 hp	7-1/2 hp	10 hp	15 hp	20 hp	20 hp
	550-600 V AC	7-1/2 hp	10 hp	15 hp	20 hp	25 hp (2)	25 hp (2)
Short-circuit protection device for contactors							
without thermal overload relay - Motor protection excluded							
High fault current		100 kA					
Fuse rating		30 A	30 A	60 A	60 A	100 A	100 A
Fuse type, 600 V		J					
Max. electrical switching frequency							
For general use		600 cycles/h					
For motor use		1200 cycles/h					

(1) For the corresponding kW/A or hp/A values of 1500 r.p.m, 50 Hz or 1800 r.p.m, 60 Hz, 3-phase motors, see "Motor rated operational powers and currents".

(2) For contactors produced since week 49-2011.

### General technical data

Contactors types	AC / DC operated	AF09	AF12	AF16	AF26	AF30	AF38
Rated insulation voltage Ui		690 V					
acc. to IEC 60947-4-1		600 V					
acc. to UL / CSA		6 kV					
Rated impulse withstand voltage Uimp.		6 kV					
Electromagnetic compatibility		Devices complying with IEC 60947-1 / EN 60947-1 - Environment A					
Ambient air temperature close to contactor							
Operation	Fitted with thermal overload relay	-25...+60 °C					
	Without thermal overload relay	-40...+70 °C					
Storage		-60...+80 °C					
Climatic withstand		Category B according to IEC 60947-1 Annex Q					
Maximum operating altitude (without derating)		3000 m					
Mechanical durability							
Number of operating cycles		10 millions operating cycles					
Max. switching frequency		3600 cycles/h					
Shock withstand							
acc. to IEC 60068-2-27 and EN 60068-2-27							
Mounting position 1							
	Shock direction	1/2 sinusoidal shock for 11 ms: no change in contact position, closed or open position					
	A	30 g					
	B1	25 g closed position / 5 g open position					
	B2	15 g					
	C1	25 g					
	C2	25 g					
Vibration withstand							
acc. to IEC 60068-2-6		5...300 Hz					
		4 g closed position / 2 g open position					

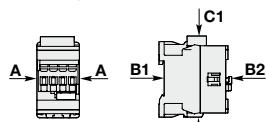

# AF40 ... AF96 3-pole contactors

## Technical data

### Main pole - Utilization characteristics according to UL / NEMA / CSA

Contactor types	AC / DC operated	AF40	AF52	AF65	AF80	AF96
Standards		UL 508, CSA C22.2 N°14				
Maximum operational voltage		600 V				
NEMA size		2	-	-	3	-
NEMA continuous amp rating	Thermal current	45 A	-	-	90 A	-
NEMA maximum horse power ratings 1-phase, 60 Hz	115 V AC	3 hp	-	-	-	-
	230 V AC	7.5 hp	-	-	-	-
NEMA maximum horse power ratings 3-phase, 60 Hz	200 V AC	10 hp	-	-	25 hp	-
	230 V AC	15 hp	-	-	30 hp	-
	460 V AC	25 hp	-	-	50 hp	-
	575 V AC	25 hp	-	-	50 hp	-
UL / CSA general use rating						
600 V AC		60 A	80 A	90 A	105 A	115 A
With conductor cross-sectional area		AWG 6	AWG 4	AWG 3	AWG 2	AWG 2
UL / CSA maximum 1-phase motor rating						
Full load current	120 V AC	34 A	34 A	56 A	80 A	80 A
	240 V AC	40 A	50 A	68 A	68 A	88 A
Horse power rating	120 V AC	3 hp	3 hp	5 hp	7-1/2 hp	7-1/2 hp
	240 V AC	7-1/2 hp	10 hp	15 hp	15 hp	20 hp
UL / CSA maximum 3-phase motor rating						
Full load current (1)	200-208 V AC	32.2 A	48.3 A	62.1 A	78.2 A	92 A
	220-240 V AC	42 A	54 A	68 A	80 A	80 A
	440-480 V AC	40 A	52 A	65 A	77 A	77 A
	550-600 V AC	41 A	52 A	62 A	77 A	77 A
Horse power rating (1)	200-208 V AC	10 hp	15 hp	20 hp	25 hp	30 hp
	220-240 V AC	15 hp	20 hp	25 hp	30 hp	30 hp
	440-480 V AC	30 hp	40 hp	50 hp	60 hp	60 hp
	550-600 V AC	40 hp	50 hp	60 hp	75 hp	75 hp
Short-circuit protection device for contactors						
without thermal overload relay - Motor protection excluded						
High fault current		100 kA				
Fuse rating		150 A	150 A	150 A	200 A	200 A
Fuse type, 600 V		J				
Maximum electrical switching frequency						
For general use		600 cycles/h				
For motor use		1200 cycles/h				

(1) For the corresponding kW/A or hp/A values of 1500 r.p.m, 50 Hz or 1800 r.p.m, 60 Hz, 3-phase motors, see "Motor rated operational powers and currents".

### General technical data

Contactor types	AC / DC operated	AF40	AF52	AF65	AF80	AF96
Rated insulation voltage Ui		690 V			1000 V	
acc. to IEC 60947-4-1						
acc. to UL / CSA		600 V				
Rated impulse withstand voltage Uimp.		6 kV			8 kV	
Electromagnetic compatibility		Devices complying with IEC 60947-1 / EN 60947-1				
Ambient air temperature close to contactor						
Operation	Fitted with thermal overload relay	(2)				
	Without thermal overload relay	-40...+70 °C				
Storage		-60...+80 °C				
Climatic withstand		Category B according to IEC 60947-1 Annex Q				
Maximum operating altitude (without derating)		3000 m				
Mechanical durability						
Number of operating cycles		10 millions operating cycles				
Maximum switching frequency		3600 cycles/h				
Shock withstand						
acc. to IEC 60068-2-27 and EN 60068-2-27						
Mounting position 1						
	Shock direction	1/2 sinusoidal shock for 11 ms: no change in contact position, closed or open position				

(2) On request.

# AF116 ... AF370 3-pole contactors

## Technical data

### Main pole - Utilization characteristics according to UL / NEMA / CSA

Contactor types	AC / DC operated	AF116	AF140	AF146	AF190	AF205	AF265	AF305	AF370
Standards		UL 60947-1 / 60947-4-1A and CSA 60947-1 / 60947-4-1A							
Maximum operational voltage		600V							
NEMA size		—	4	—	—	—	5	—	—
NEMA continuous amp rating	Thermal current	—	135 A	—	—	—	270 A	—	—
NEMA maximum horse power ratings									
1-phase, 60 Hz	115 V AC	—	—	—	—	—	—	—	—
	230 V AC	—	—	—	—	—	—	—	—
NEMA maximum horse power ratings									
3-phase, 60 Hz	200 V AC	—	40 hp	—	—	—	75 hp	—	—
	230 V AC	—	50hp	—	—	—	100 hp	—	—
	460 V AC	—	100 hp	—	—	—	200 hp	—	—
	575 V AC	—	100 hp	—	—	—	200 hp	—	—
UL / CSA general use rating									
600 V AC		160 A	200 A	200 A	250 A	300 A	350 A	400 A	520 A
With conductor cross-sectional area		AWG 2/0	AWG 3/0	AWG 3/0	MCM 250	MCM 350 (2)	MCM 500	2//AWG 3/0	2//MCM 300
UL / CSA maximum 1-phase motor rating									
Full load current	120 V AC	—	—	—	—	—	—	—	—
	240 V AC	—	—	—	—	—	—	—	—
Horse power rating	120 V AC	—	—	—	—	—	—	—	—
	240 V AC	—	—	—	—	—	—	—	—
UL / CSA maximum 3-phase motor rating									
Full load current (1)	200-208 V AC	92 A	120 A	120 A	150 A	177 A	221 A	285 A	359 A
	220-240 V AC	104 A	130 A	130 A	154 A	192 A	248 A	312 A	360 A
	440-480 V AC	96 A	124 A	124 A	156 A	180 A	240 A	302 A	361 A
	550-600 V AC	99 A	125 A	125 A	144 A	192 A	242 A	289 A	336 A
Horse power rating (1)	200-208 V AC	30 hp	40 hp	40 hp	50 hp	60 hp	75 hp	100 hp	125 hp
	220-240 V AC	40 hp	50 hp	50 hp	60 hp	75 hp	100 hp	125 hp	150 hp
	440-480 V AC	75 hp	100 hp	100 hp	125 hp	150 hp	200 hp	250 hp	300 hp
	550-600 V AC	100 hp	125 hp	125 hp	150 hp	200 hp	250 hp	300 hp	350 hp
Short-circuit protection device for contactors									
without thermal overload relay - Motor protection excluded									
High fault current		100 kA							
Fuse rating		225 A	250 A	250 A	450 A	400 A	500 A	600 A	800 A
Fuse type, 600 V		J							
Maximum electrical switching frequency									
For general use		300 cycles/h							
For motor use		300 cycles/h							

(1) For the corresponding kW/A or hp/A values of 1500 r.p.m, 50 Hz or 1800 r.p.m, 60 Hz, 3-phase motors, see "Motor rated operational powers and currents".

(2) For conductor cross-sectional area above MCM 300 use terminal enlargements LW205.

### General technical data

Contactor types	AC / DC operated	AF116	AF140	AF146	AF190	AF205	AF265	AF305	AF370
Rated insulation voltage Ui									
acc. to IEC 60947-4-1		1000 V							
acc. to UL / CSA		600 V							
Rated impulse withstand voltage Uimp.		8 kV							
Electromagnetic compatibility		AF contactors comply with IEC 60947-1 / EN 60947-1 - Environment A							
Ambient air temperature close to contactor									
Operation	Fitted with thermal overload relay	-25 to +55 °C							
	Without thermal overload relay	-40 to +70 °C							
Storage		-40 to +70 °C							
Maximum operating altitude (without derating)		3000 m							
Mechanical durability									
Number of operating cycles		5 million operating cycles							
Maximum switching frequency		300 cycles/h							

# AF400 ... AF2650 3-pole contactors

## Technical data

### Main pole - Utilization characteristics according to UL / NEMA / CSA

Contactor types	AC / DC operated	AF400	AF460	AF580	AF750	AF1250	AF1350	AF1650	AF2050	AF2650
Standards		UL 508, CSA C22.2 N°14								
Maximum operational voltage		600 V								
NEMA size		-	6	-	7	-	8	-	-	-
NEMA maximum horse power ratings										
1-phase, 60 Hz	115 V AC	-	-	-	-	-	-	-	-	-
	230 V AC	-	-	-	-	-	-	-	-	-
NEMA maximum horse power ratings										
3-phase, 60 Hz	200 V AC	-	150 hp	-	-	-	-	-	-	-
	230 V AC	-	200 hp	-	300 hp	-	450 hp	-	-	-
	460 V AC	-	400 hp	-	600 hp	-	900 hp	-	-	-
	575 V AC	-	400 hp	-	600 hp	-	900 hp	-	-	-
UL / CSA general use rating										
600 V AC		550 A	650 A	750 A	900 A	1210 A	1350 A	1650 A	2100 A	2700 A
UL / CSA maximum 1-phase motor rating										
Full load current	120 V AC	-	-	-	-	-	-	-	-	-
	240 V AC	-	-	-	-	-	-	-	-	-
Horse power rating	120 V AC	-	-	-	-	-	-	-	-	-
	240 V AC	-	-	-	-	-	-	-	-	-
UL / CSA maximum 3-phase motor rating										
Full load current (1)	200-208 V AC	358.8 A	414 A	552 A	692.3 A	-	954 A	1030 A	-	-
	220-240 V AC	360 A	480 A	604 A	722 A	-	954 A	1030 A	-	-
	440-480 V AC	414 A	477 A	590 A	722 A	-	954 A	1030 A	-	-
	550-600 V AC	382 A	472 A	578 A	672 A	-	944 A	1050 A	-	-
Horse power rating (1)	200-208 V AC	125 hp	150 hp	200 hp	250 hp	-	-	-	-	-
	220-240 V AC	150 hp	200 hp	250 hp	300 hp	-	400 hp	450 hp	-	-
	440-480 V AC	350 hp	400 hp	500 hp	600 hp	-	800 hp	900 hp	-	-
	550-600 V AC	400 hp	500 hp	600 hp	700 hp	-	1000 hp	1150 hp	-	-
Short-circuit protection device for contactors										
without thermal overload relay - Motor protection excluded										
Fuse rating		1000 A		1200 A		Please consult us for coordination with circuit-breaker				
Fuse type, 600 V		L								
Maximum electrical switching frequency										
For general use		300 cycles/h					60 cycles/h		15 cycles/h	
For motor use		300 cycles/h					60 cycles/h		-	

(1) For the corresponding kW/A or hp/A values of 1500 r.p.m, 50 Hz or 1800 r.p.m, 60 Hz, 3-phase motors, see "Motor rated operational powers and currents".

### General technical data

Contactor types	AC / DC operated	AF400	AF460	AF580	AF750	AF1250	AF1350	AF1650	AF2050	AF2650
Rated insulation voltage $U_i$										
acc. to IEC 60947-4-1		1000 V								
acc. to UL		600 V								
Rated impulse withstand voltage $U_{imp}$		8 kV								
Electromagnetic compatibility		AF contactors complying with IEC 60947-1 / EN 60947-1 - Environment A								
Ambient air temperature close to contactor										
Operation	Fitted with electronic overload relay	-25 to +70 °C								
	Without electronic overload relay	-40 to +70 °C								
Storage		-40 to +70 °C								
Maximum operating altitude (without derating)		3000 m								
Mechanical durability										
Number of operating cycles		3 millions operating cycles				0.5 million operating cycles			0.3 million operating cycles	
Max. switching frequency		300 cycles/h					60 cycles/h			
Shock withstand										
acc. to IEC 60068-2-27 and EN 60068-2-27										
Mounting position 1										
	Shock direction	1/2 sinusoidal shock for 30 ms: no change in contact position, closed or open position								
	A	5 g				-			-	
	B1	5 g				-			-	
	B2	5 g				-			-	
	C1	5 g				-			-	
	C2	5 g				-			-	

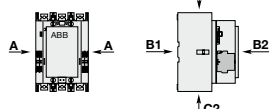

# AF09 ... AF38 3-pole contactors

## Technical data

### Magnet system characteristics

Contactor types	AC / DC operated	AF09	AF12	AF16	AF26	AF30	AF38
Coil operating limits acc. to IEC 60947-4-1	AC supply	At $\theta \leq 60^\circ\text{C}$ $0.85 \times U_c \text{ min...} 1.1 \times U_c \text{ max.}$ At $\theta \leq 70^\circ\text{C}$ $0.85 \times U_c \text{ min...} U_c \text{ max.}$					
	DC supply	At $\theta \leq 60^\circ\text{C}$ $0.85 \times U_c \text{ min...} 1.1 \times U_c \text{ max.}$ At $\theta \leq 70^\circ\text{C}$ (AF) $0.85 \times U_c \text{ min...} U_c \text{ max.}$ - (AF..Z) $0.85 \times U_c \text{ min...} 1.1 \times U_c \text{ max.}$					
AC control voltage 50/60 Hz		24...500 V AC					
Rated control circuit voltage $U_c$	Average pull-in value	(AF) 50 VA - (AF..Z) 16 VA					
Coil consumption	Average holding value	(AF) 2.2 VA / 2 W - (AF..Z) 1.7 VA / 1.5 W					
DC control voltage		12...500 V DC					
Rated control circuit voltage $U_c$	Average pull-in value	(AF) 50 W - (AF..Z) 12...16 W					
Coil consumption	Average holding value	(AF) 2 W - (AF..Z) 1.7 W					
PLC-output control		(AF..Z) $\geq 500 \text{ mA}$ 24 V DC					
Drop-out voltage		$\leq 60\%$ of $U_c \text{ min.}$					
Voltage sag immunity acc. to SEMI F47-0706		(AF..Z) conditions of use on request					
Dips withstand $-20^\circ\text{C} \leq \theta \leq +60^\circ\text{C}$		(AF..Z) 22 ms average for $U_c \geq 24 \text{ V}$ 50/60 Hz or $U_c \geq 20 \text{ V}$ DC					
Operating time							
Between coil energization and:	N.O. contact closing	40...95 ms					
	N.C. contact opening	38...90 ms					
Between coil de-energization and:	N.O. contact opening	11...95 ms					
	N.C. contact closing	13...98 ms					

### Mounting characteristics and conditions for use

Contactor types	AC / DC operated	AF09	AF12	AF16	AF26	AF30	AF38
Mounting positions							
Mounting distances		Max. N.C. built-in and add-on N.C. auxiliary contacts: see accessory fitting details for a 3-pole contactor AF09 ... AF38					
Fixing		The contactors can be assembled side by side					
On rail according to IEC 60715, EN 60715		35 x 7.5 mm or 35 x 15 mm					
	By screws (not supplied)	2 x M4 screws placed diagonally					

# AF40 ... AF96 3-pole contactors

## Technical data

### Magnet system characteristics

Contactors types	AC / DC operated	AF40	AF52	AF65	AF80	AF96
Coil operating limits acc. to IEC 60947-4-1	AC supply	At $\theta \leq 70^\circ\text{C}$ $0.85 \times U_c \text{ min} \dots 1.1 \times U_c \text{ max}$ .				
	DC supply	At $\theta \leq 70^\circ\text{C}$ $0.85 \times U_c \text{ min} \dots 1.1 \times U_c \text{ max}$ .				
<b>AC control voltage 50/60 Hz</b>						
Rated control circuit voltage $U_c$		24...500 V AC				
Coil consumption	Average pull-in value	25 VA				40 VA
	Average holding value	4 VA / 2 W				
<b>DC control voltage</b>						
Rated control circuit voltage $U_c$		20...500 V DC				
Coil consumption	Average pull-in value	25 W				40 W
	Average holding value	2 W				
PLC-output control		-				
Drop-out voltage		$\leq 60\%$ of $U_c \text{ min}$ .				
Voltage sag immunity acc. to SEMI F47-0706		conditions of use on request				
Dips withstand $-20^\circ\text{C} \leq \theta \leq +60^\circ\text{C}$		24 ms average				
<b>Operating time</b>						
Between coil energization and:	N.O. contact closing	42...100 ms				
	N.C. contact opening	38...95 ms				
Between coil de-energization and:	N.O. contact opening	17...100 ms				
	N.C. contact closing	19...105 ms				

### Mounting characteristics and conditions for use

Contactors types	AC / DC operated	AF40	AF52	AF65	AF80	AF96
Mounting positions						
Mounting distances		Max. N.C. built-in and add-on N.C. auxiliary contacts: see accessory fitting details for a 3-pole contactor AF40 ... AF96				
Fixing		The contactors can be assembled side by side				
On rail according to IEC 60715, EN 60715		35 x 7.5 mm or 35 x 15 mm				35 x 15 mm
	By screws (not supplied)	2 x M4 or 2 x M6 screws placed diagonally				



# AF116 ... AF370 3-pole contactors

## Technical data

### Magnet system characteristics

Contactor types	AC / DC operated	AF116	AF140	AF146	AF190	AF205	AF265	AF305	AF370
Coil operating limits acc. to IEC 60947-4-1	AC supply	At $\theta \leq 70^\circ\text{C}$ $0.85 \times U_c \text{ min} \dots 1.1 \times U_c \text{ max}$							
	DC supply	At $\theta \leq 70^\circ\text{C}$ $0.80 \times U_c \text{ min} \dots 1.1 \times U_c \text{ max}$							
Rated control circuit voltage $U_c$									
Coil consumption									
AC control voltage 50/60 Hz									
24...60 V AC	Average pull-in value	225 VA			165 VA		475 VA		
	Average holding value	5.5 VA			6 VA		8.5 VA		
48...130 V AC	Average pull-in value	170 VA			175 VA		340 VA		
	Average holding value	4 VA			4 VA		17 VA		
100...250 V AC	Average pull-in value	130 VA			220 VA		385 VA		
	Average holding value	6 VA			7 VA		17.5 VA		
DC control voltage									
20...60 V DC	Average pull-in value	210 W			205 W		400 W		
	Average holding value	2.5 W			2.5 W		3 W		
48...130 V DC	Average pull-in value	130 W			130 W		360 W		
	Average holding value	2.5 W			2.5 W		2.5 W		
100...250 V DC	Average pull-in value	135 W			190 W		410 W		
	Average holding value	3 W			2.5 W		4.5 W		
Drop-out voltage		55 % of $U_c \text{ min}$							
Operating time									
Coil supply between A1 - A2									
Between coil energization and:		N.O. contact closing	20...55 ms		25...60 ms		30...60 ms		
Between coil de-energization and:		N.O. contact opening	40...70 ms		45...80 ms		45...80 ms		

### Mounting characteristics and conditions for use

Contactor types	AC / DC operated	AF116	AF140	AF146	AF190	AF205	AF265	AF305	AF370
Mounting positions									
Max. add-on N.O. or N.C. auxiliary contacts: see accessory fitting details for 3-pole contactor AF116 ... AF370									
Mounting distances									
The contactors can be assembled side by side									
Fixing									
On rail acc. to IEC 60715, EN 60715		-							
By screws (not supplied)		4 x M5							



# AF400 ... AF2650 3-pole contactors

## Technical data

### Magnet system characteristics

Contactor types	AC / DC operated	AF400	AF460	AF580	AF750	AF1250	AF1350	AF1650	AF2050	AF2650		
Coil operating limits acc. to IEC 60947-4-1	AC supply	At $\theta \leq 70^\circ\text{C}$ $0.85 \times U_c \text{ min} \dots 1.1 \times U_c \text{ max}$										
	DC supply	At $\theta \leq 70^\circ\text{C}$ $0.80 \times U_c \text{ min} \dots 1.1 \times U_c \text{ max}$										
Rated control circuit voltage $U_c$												
Coil consumption												
AC control voltage 50/60 Hz												
24...60 V AC	Average pull-in value	900 VA			780 VA			-				
	Average holding value	12 VA			12 VA			-				
48...130 V AC	Average pull-in value	1215 VA			1100 VA			-				
	Average holding value	12 VA			12 VA			-				
100...250 V AC	Average pull-in value	955 VA			880 VA			2450 VA				
	Average holding value	12 VA			12 VA			48 VA				
250 ... 500 V AC	Average pull-in value	950 VA			985 VA			-				
	Average holding value	12 VA			12 VA			-				
DC control voltage												
20...60 V DC	Average pull-in value	900 VA			785 VA			-				
	Average holding value	5 VA			5.5 VA			-				
48...130 V DC	Average pull-in value	1150 VA			1020 VA			-				
	Average holding value	5 VA			5 VA			-				
100...250 V DC	Average pull-in value	895 VA			880 VA			2290 VA				
	Average holding value	5 VA			5 VA			20.5 VA				
250 ... 500 V AC	Average pull-in value	885 VA			910 VA			-				
	Average holding value	7.5 VA			7.5 VA			-				
Drop-out voltage	55 % of $U_c \text{ min.}$											
Voltage sag immunity acc. to SEMI F47	Conditions of use on request											
Dips withstand	$\geq 20 \text{ ms}$											
Operating time												
Coil supply between A1 - A2												
Between coil energization and:	Main contact closing	50...120 ms				50...80 ms						
Between coil de-energization and:	Main contact opening	33...70 ms				35...55 ms						
Control input for PLC's												
Between coil energization and:	Main contact closing	40...60 ms			40...90 ms			40...65 ms				
Between coil de-energization and:	Main contact opening	10...30 ms						10...30 ms				

5















### Mounting characteristics and conditions for use

Contactor types	AC / DC operated	AF400	AF460	AF580	AF750	AF1250	AF1350	AF1650	AF2050	AF2650
Mounting positions										
Max. add-on N.O. or N.C. auxiliary contacts: see accessory fitting details for 3-pole contactor AF400 ... AF2650										
Mounting distances										
The contactors can be assembled side by side										
Fixing										
On rail according to IEC 60715, EN 60715		-								
By screws (not supplied)		4 x M5			4 x M6			4 x M8		

# AF09 ... AF38 3-pole contactors

## Technical data











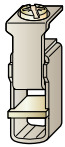
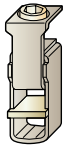



### Connecting characteristics

Contactor types	AC / DC operated	AF09	AF12	AF16	AF26	AF30	AF38	
<b>Main terminals</b>		 Screw terminals with cable clamp						
<b>Connection capacity (min. ... max.)</b>								
<b>Main conductors (poles)</b>								
 Rigid	Solid ( $\leq 4 \text{ mm}^2$ )	} <b>1 x</b>	1...6 mm <sup>2</sup>			2.5...10 mm <sup>2</sup>		
 Stranded ( $\geq 6 \text{ mm}^2$ )			<b>2 x</b> 1...6 mm <sup>2</sup>			2.5...10 mm <sup>2</sup>		
 Flexible with non insulated ferrule		<b>1 x</b>	0.75...6 mm <sup>2</sup>			1.5...10 mm <sup>2</sup>		
 Flexible with insulated ferrule		<b>2 x</b>	0.75...6 mm <sup>2</sup>			1.5...10 mm <sup>2</sup>		
 Flexible with insulated ferrule		<b>1 x</b>	0.75...4 mm <sup>2</sup>			1.5...10 mm <sup>2</sup>		
 Flexible with insulated ferrule		<b>2 x</b>	0.75...2.5 mm <sup>2</sup>			1.5...4 mm <sup>2</sup>		
 Bars or lugs		<b>L &lt;</b>	9.6 mm			12.5 mm		
Connection capacity acc. to UL/CSA		<b>1 or 2 x</b>	AWG 16...10			AWG 14...8		
Stripping length			10 mm			14 mm		
Tightening torque			1.5 Nm / 13 lb.in			2.5 Nm / 22 lb.in		
<b>Auxiliary conductors</b>								
(built-in auxiliary terminals + coil terminals)								
 Rigid solid		<b>1 x</b>	1...2.5 mm <sup>2</sup>					
 Rigid solid		<b>2 x</b>	1...2.5 mm <sup>2</sup>					
 Flexible with non insulated ferrule		<b>1 x</b>	0.75...2.5 mm <sup>2</sup>					
 Flexible with non insulated ferrule		<b>2 x</b>	0.75...2.5 mm <sup>2</sup>					
 Flexible with insulated ferrule		<b>1 x</b>	0.75...2.5 mm <sup>2</sup>					
 Flexible with insulated ferrule		<b>2 x</b>	0.75...1.5 mm <sup>2</sup>					
 Lugs		<b>L &lt;</b>	8 mm					
Connection capacity acc. to UL/CSA		<b>1 or 2 x</b>	AWG 18...14					
Stripping length			10 mm					
Tightening torque								
Coil terminals			1.2 Nm / 11 lb.in					
Built-in auxiliary terminals			1.2 Nm / 11 lb.in					
<b>Degree of protection</b>								
acc. to IEC 60947-1 / EN 60947-1 and IEC 60529 / EN 60529								
Main terminals			IP20					
Coil terminals			IP20					
Built-in auxiliary terminals			IP20					
<b>Screw terminals</b>								
Main terminals			Delivered in open position, screws of unused terminals must be tightened					
			M3.5			M4		
		<b>Screwdriver type</b>	Flat Ø 5.5 / Pozidriv 2			Flat Ø 6.5 / Pozidriv 2		
Coil terminals			M3.5					
		<b>Screwdriver type</b>	Flat Ø 5.5 / Pozidriv 2					
Built-in auxiliary terminals			M3.5					
		<b>Screwdriver type</b>	Flat Ø 5.5 / Pozidriv 2					

# AF40 ... AF96 3-pole contactors

## Technical data

### Connecting characteristics

Contactor types	AC / DC operated	AF40	AF52	AF65	AF80	AF96
<b>Main terminals</b>						
		Screw terminals with double connector 2 x (9.3 width x 7.9/10.3 depth)			Screw terminals with double connector 2 x (12.4 width x 9.3/11.1 depth)	
<b>Connection capacity (min. ... max.)</b>						
<b>Main conductors (poles)</b>						
	Rigid	Solid ( $\leq 4 \text{ mm}^2$ )	} <b>1 x</b>	6...35 mm <sup>2</sup>		6...70 mm <sup>2</sup>
		Stranded ( $\geq 6 \text{ mm}^2$ )		<b>2 x</b>	6...35 mm <sup>2</sup>	
	Flexible with non insulated ferrule		<b>1 x</b>	4...35 mm <sup>2</sup>		6...50 mm <sup>2</sup>
			<b>2 x</b>	4...35 mm <sup>2</sup>		6...50 mm <sup>2</sup>
	Flexible with insulated ferrule		<b>1 x</b>	4...35 mm <sup>2</sup>		6...50 mm <sup>2</sup>
			<b>2 x</b>	4...35 mm <sup>2</sup>		6...50 mm <sup>2</sup>
	Bars or lugs		<b>L &lt;</b>	9.2 mm		12.2 mm
Connection capacity acc. to UL/CSA			<b>1 or 2 x</b>	AWG 10...2		AWG 6...1
Stripping length				16 mm		17 mm
Tightening torque				4 Nm / 35 lb.in		6 Nm / 53 lb.in
<b>Auxiliary conductors</b> (built-in auxiliary terminals + coil terminals)						
	Rigid solid		<b>1 x</b>	1...2.5 mm <sup>2</sup>		
			<b>2 x</b>	1...2.5 mm <sup>2</sup>		
	Flexible with non insulated ferrule		<b>1 x</b>	0.75...2.5 mm <sup>2</sup>		
			<b>2 x</b>	0.75...2.5 mm <sup>2</sup>		
	Flexible with insulated ferrule		<b>1 x</b>	0.75...2.5 mm <sup>2</sup>		
			<b>2 x</b>	0.75...1.5 mm <sup>2</sup>		
	Lugs		<b>L &lt;</b>	8 mm		
Connection capacity acc. to UL/CSA			<b>1 or 2 x</b>	AWG 18...14		
Stripping length				10 mm		
Tightening torque				1.2 Nm / 11 lb.in		
Coil terminals				1.2 Nm / 11 lb.in		
Built-in auxiliary terminals				1.2 Nm / 11 lb.in		
<b>Degree of protection</b> acc. to IEC 60947-1 / EN 60947-1 and IEC 60529 / EN 60529						
Main terminals				IP10		
Coil terminals				IP20		
Built-in auxiliary terminals				IP20		
<b>Screw terminals</b>						
Main terminals				Delivered in open position, screws of unused terminals must be tightened		
				M6	M8	
		<b>Screwdriver type</b>		Flat Ø 6.5 / Pozidriv 2		Hexagon socket (s = 4 mm)
Coil terminals				M3.5		
		<b>Screwdriver type</b>		Flat Ø 5.5 / Pozidriv 2		
Built-in auxiliary terminals				M3.5		
		<b>Screwdriver type</b>		Flat Ø 5.5 / Pozidriv 2		

# AF116 ... AF370 3-pole contactors

## Technical data

### Connecting characteristics

Contactor types	AC / DC operated	AF116	AF140	AF146	AF190	AF205	AF265	AF305	AF370
<b>Main terminals</b>									
Flat type									
<b>Connection capacity (min. ... max.)</b>									
<b>Main conductors (poles)</b>									
	Cu cable - Stranded	1 x	10...95 mm <sup>2</sup>		6...150 mm <sup>2</sup>		16...300 mm <sup>2</sup>		
	Clamp type		LD... included (1)		1SDA066917R1		1SDA055016R1		
	Tightening torque		8 Nm		14 Nm		25 Nm		
	Cu cable - Stranded	2 x	10...95 mm <sup>2</sup>		50...120 mm <sup>2</sup>		70...185 mm <sup>2</sup>		
	Clamp type		LD... included (1)		1SFN074709R1000, LZ185-2C/120		1SCA022194R0890, OZXB4		
	Tightening torque		8 Nm		16 Nm		22 Nm		
	Al cable - Stranded	1 x	-		95...185 mm <sup>2</sup>		185...240 mm <sup>2</sup>		
	Clamp type		-		1SDA054988R1		1SDA055020R1		
	Tightening torque		-		31 Nm		43 Nm		
	Cu cable - Flexible	1 x	10...70 mm <sup>2</sup>		6...120 mm <sup>2</sup>		16...240 mm <sup>2</sup>		
	Clamp type		LD... included (1)		1SDA066917R1		1SDA055016R1		
	Tightening torque		8 Nm		14 Nm		25 Nm		
	Cu cable - Flexible	2 x	10...70 mm <sup>2</sup>		50...95 mm <sup>2</sup>		70...185 mm <sup>2</sup>		
	Clamp type		LD... included (1)		1SFN074709R1000, LZ185-2C/120		1SCA022194R0890, OZXB4		
	Tightening torque		8 Nm		16 Nm		22 Nm		
	Lugs	W ≤	22 mm (.866 in)		24 mm (.945 in)		32 mm (1.260 in)		
		Ø >	6 mm (.236 in)		8 mm (.315 in)		10 mm (.394 in)		
	Socket type		LL... included		LL... included		LL... included		
	Tightening torque		9 Nm / 80 lb.in		18 Nm / 160 lb.in		28 Nm / 248 lb.in		
Connection capacity acc. to UL / CSA		1 x	AWG 6...3/0		6...300 MCM		4...400 MCM		
	Clamp type		LD... included (1)		ATK185 (2)		ATK300 (2)		
	Tightening torque		8 Nm / 71 lb.in		34 Nm / 301 lb.in		42 Nm / 372 lb.in		
Connection capacity acc. to UL / CSA		2 x	AWG 6...3/0		-		4...500 MCM		
	Clamp type		LD... included (1)		-		ATK300/2 (2)		
	Tightening torque		8 Nm / 71 lb.in		-		42 Nm / 372 lb.in		
<b>Auxiliary conductors</b>									
(coil terminals)									
	Solid / stranded	1 x	1...4 mm <sup>2</sup>						
		2 x	1...4 mm <sup>2</sup>						
	Flexible	1 x	0.75...2.5 mm <sup>2</sup>						
		2 x	0.75...2.5 mm <sup>2</sup>						
	Flexible with non insulated ferrule	1 x	0.75...2.5 mm <sup>2</sup>						
		2 x	0.75...2.5 mm <sup>2</sup>						
	Flexible with insulated ferrule	1 x	0.75...2.5 mm <sup>2</sup>						
		2 x	0.75...2.5 mm <sup>2</sup>						
	Lugs	L <	8 mm						
		l >	3.5 mm						
Connection capacity acc. to UL / CSA		1 or 2 x	AWG 18...14						
	Stripping length		9 mm						
	Tightening torque		1.00 Nm / 9 lb.in						
<b>Degree of protection</b>									
acc. to IEC 60947-1 / EN 60947-1 and IEC 60529 / EN 60529									
	Main terminals		IP00						
	Coil terminals		IP20						
<b>Screw terminals</b>									
	Main terminals		M6		M8		M10		
		Screwdriver type	Screws and bolts						
	Coil terminals (delivered in open position)		M3.5						
		Screwdriver type	Flat Ø 5.5 mm / Pozidriv 2						









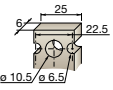
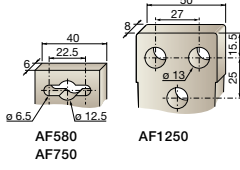
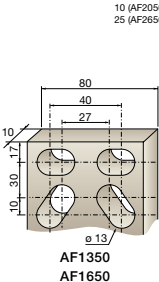
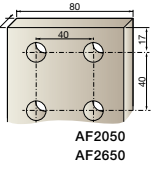

(1) LD... not included for AF116 ... AF146-30...B.

(2) Available in North America only.

# AF400 ... AF2650 3-pole contactors

## Technical data

### Connecting characteristics

Contactor types	AC / DC operated	AF400	AF460	AF580	AF750	AF1250	AF1350	AF1650	AF2050	AF2650
<b>Main terminals</b>										
Flat type										
										
<b>Connection capacity (min. ... max.)</b>										
<b>Main conductors (poles)</b>										
	Cu cable - Stranded	2 x	240 mm <sup>2</sup>							
	Clamp type		1SDA013922R1							
	Tightening torque		35 Nm							
	Cu cable - Stranded	3 x		185 mm <sup>2</sup>						
	Clamp type			1SDA013956R1						
	Tightening torque		35 Nm	45 Nm						
	Al cable - Stranded	2 x	240 mm <sup>2</sup>							
	Clamp type		1SDA013922R1							
	Tightening torque		35 Nm							
		3 x		185 mm <sup>2</sup>						
	Clamp type			1SDA013956R1						
	Tightening torque		35 Nm	45 Nm						
	Lugs	W ≤	47 mm	50 mm			100 mm			
		Ø >	10 mm	12 mm						
	Tightening torque		35 Nm / 310 lb.in	45 Nm / 398 lb.in						
Connection capacity acc. to UL / CSA		2 x	250-500 MCM alt. 2/0 AWG-400 MCM	-		2// 3 x 0.25 in	4/0 AWG - 500 MCM	4//4 x 0.25 in		
	Clamp type		K6TH alt. ATK580	-		bars, use LW1250	K7TK ATK1350/4	K7TK bars		
	Tightening torque		275 lb.in	-			375 lb.in	-		
Connection capacity acc. to UL / CSA		3 x	2/0 AWG-400 MCM	2/0 AWG-500 MCM			1/0-750 MCM	-		
	Clamp type		K6TJ	ATK750/3			K8TL, K8TM, ATK1650/4	K8TL, K8TM, ATK1650/4, ATK1650/6		
	Tightening torque		275 lb.in	375 lb.in			500 lb.in	-		
<b>Auxiliary conductors</b>										
(coil terminals)										
	Solid / stranded	1 x	1...4 mm <sup>2</sup>							
		2 x	1...4 mm <sup>2</sup>							
	Flexible	1 x	0.75...2.5 mm <sup>2</sup>							
		2 x	0.75...2.5 mm <sup>2</sup>							
	Flexible with non insulated ferrule	1 x	0.75...2.5 mm <sup>2</sup>							
		2 x	0.75...2.5 mm <sup>2</sup>							
	Flexible with insulated ferrule	1 x	0.75...2.5 mm <sup>2</sup>							
		2 x	0.75...2.5 mm <sup>2</sup>							
	Lugs	L ≤	8 mm							
		L >	3.7 mm							
Connection capacity acc. to UL / CSA		1 or 2 x	AWG 18...14							
	Tightening torque	Recommended	1.00 Nm / 9 lb.in							
		Max.	1.20 Nm							
<b>Degree of protection</b>										
acc. to IEC 60947-1 / EN 60947-1 and IEC 60529 / EN 60529										
Main terminals			IP00							
Coil terminals			IP20							
<b>Screw terminals</b>										
Main terminals			M10	M12						
			Screws and bolts							
Coil terminals (delivered in open position)			M3.5							
		<b>Screwdriver type</b>	Flat Ø 5.5 mm / Pozidriv 2							

# AF09 ... AF96 3-pole contactors

## Technical data

### Built-in auxiliary contacts according to IEC

Contactor types	AC / DC operated	AF09	AF12	AF16	AF26	AF30	AF38	AF40	AF52	AF65	AF80	AF96
Rated operational voltage U <sub>e</sub> max.		690 V										
Rated frequency (without derating)		50 / 60 Hz										
Conventional free air thermal current I <sub>th</sub> - θ ≤ 40 °C		16 A										
le / Rated operational current AC-15		16 A										
acc. to IEC 60947-5-1		16 A										
	24-127 V 50/60 Hz	6 A										
	220-240 V 50/60 Hz	4 A										
	400-440 V 50/60 Hz	3 A										
	500 V 50/60 Hz	2 A										
	690 V 50/60 Hz	2 A										
Making capacity AC-15		10 x I <sub>e</sub> AC-15 acc. to IEC 60947-5-1										
Breaking capacity AC-15		10 x I <sub>e</sub> AC-15 acc. to IEC 60947-5-1										
le / Rated operational current DC-13		16 A										
acc. to IEC 60947-5-1		16 A										
	24 V DC	6 A / 144 W										
	48 V DC	2.8 A / 134 W										
	72 V DC	1 A / 72 W										
	110 V DC	0.55 A / 60 W										
	125 V DC	0.55 A / 69 W										
	220 V DC	0.27 A / 60 W										
	250 V DC	0.27 A / 68 W										
	400 V DC	0.15 A / 60 W										
	500 V DC	0.13 A / 65 W										
	600 V DC	0.1 A / 60 W										
Short-circuit protection device gG type fuse		10 A										
Rated short-time withstand current I <sub>cw</sub>	for 1.0 s	100 A										
	for 0.1 s	140 A										
Minimum switching capacity		12 V / 3 mA										
with failure rate acc. to IEC 60947-5-4		10 <sup>-7</sup>										
Non-overlapping time between N.O. and N.C. contacts		≥ 2 ms										
Power dissipation per pole at 6 A		0.1 W										
Max. electrical switching frequency	AC-15	1200 cycles/h										
	DC-13	900 cycles/h										
Mechanically linked contacts		Built-in N.O. or N.C. auxiliary contacts and additional N.O. or N.C. auxiliary contacts (CA4, CAL4, CAT4 aux. contact blocks) are mechanically linked contacts.										
acc. to annex L of IEC 60947-5-1												
Mirror contacts		Built-in N.C. auxiliary contacts or additional N.C. auxiliary contacts (CA4, CAL4, CAT4 aux. contact blocks) are mirror contacts.										
acc. to annex F of IEC 60947-4-1												

### Built-in auxiliary contacts according to UL / CSA

Contactor types	AC / DC operated	AF09	AF12	AF16	AF26	AF30	AF38	AF40	AF52	AF65	AF80	AF96
Max. operational voltage		600 V AC, 600 V DC										
Pilot duty		A600, Q600										
AC thermal rated current		10 A										
AC maximum volt-ampere making		7200 VA										
AC maximum volt-ampere breaking		720 VA										
DC thermal rated current		2.5 A										
DC maximum volt-ampere making-breaking		69 VA										

# AF09 ... AF96 3-pole contactors

## Terminal marking and positioning

### AF09 ... AF96 contactors - AC / DC operated

Standard devices without addition of auxiliary contacts

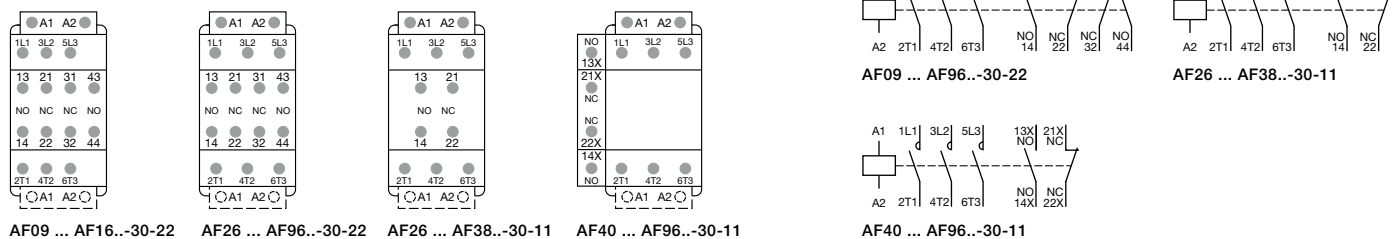
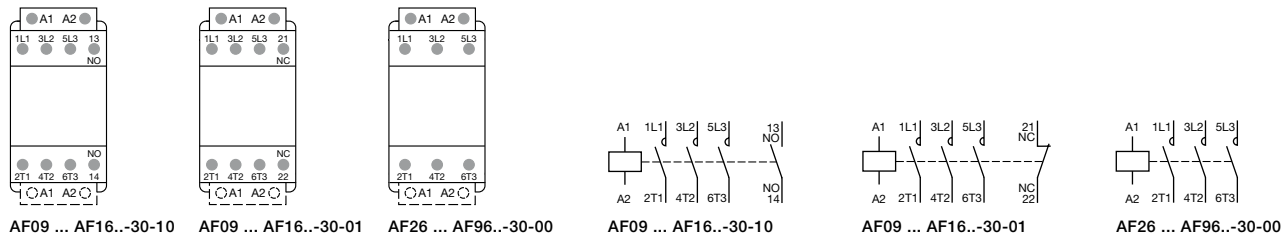

5

Other possible contact combinations with auxiliary contacts added by the user

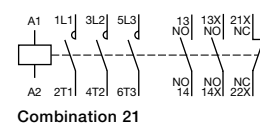
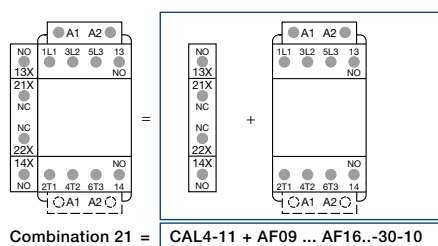
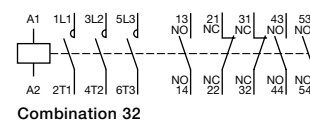
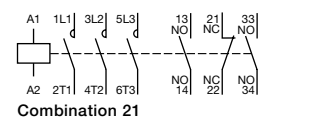
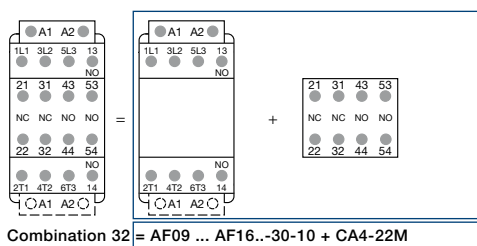
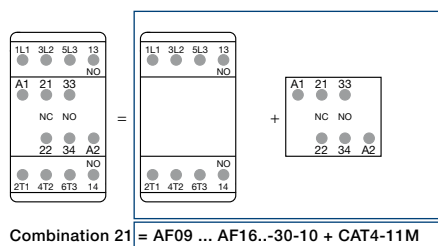
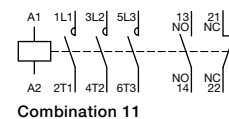
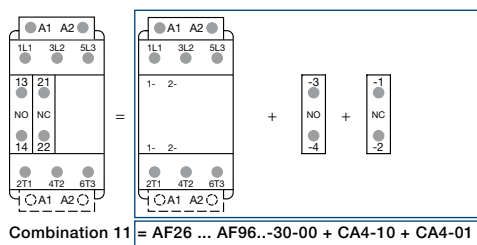
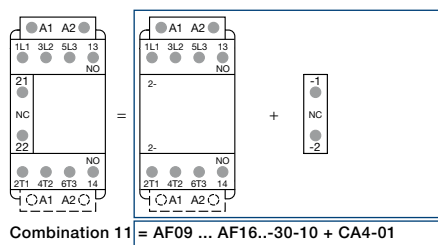

Note: Only AF.Z contactor with DC control voltage 12...20 V DC need to respect the connection polarities indicated close to the coil terminals: A1+ for the positive pole and A2- for the negative pole

# AF116 ... AF370 3-pole contactors

## Terminal marking and positioning

### AF116 ... AF370 contactors - AC / DC operated

Standard devices without addition of auxiliary contacts

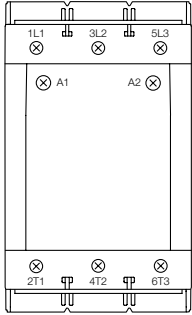

AF116 ... AF370-30-00

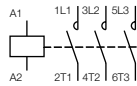

AF116 ... AF370-30-00

5

Standard devices with factory mounted auxiliary contacts

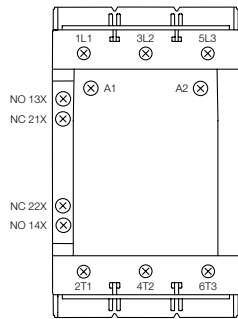

AF116 ... AF370-30-11

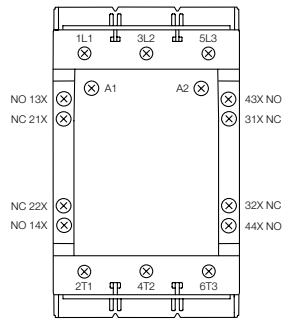

AF116 ... AF370-30-22

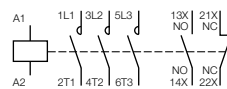

AF116 ... AF370-30-11

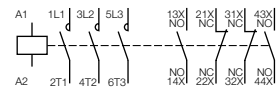

AF116 ... AF370-30-22



# AF400 ... AF2650 3-pole contactors

## Terminal marking and positioning

### AF400 ... AF1250 contactors - AC / DC operated

Standard devices with factory mounted auxiliary contacts

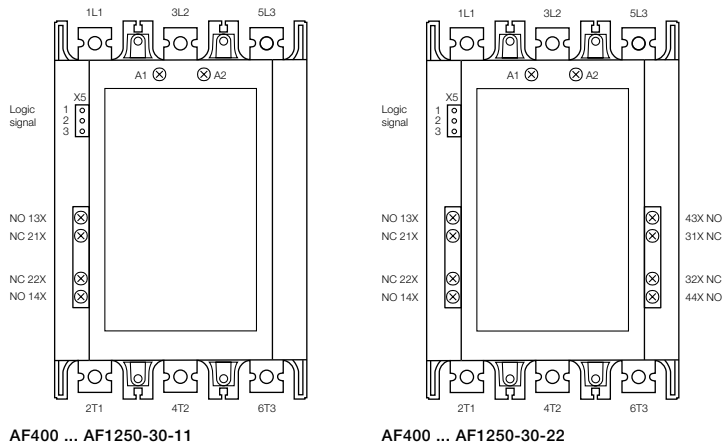

AF400 ... AF1250-30-11

AF400 ... AF1250-30-22

### Control with logic signal

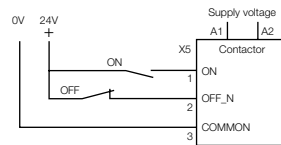

AF400 ... AF1250-30-11, AF400 ... AF1250-30-22

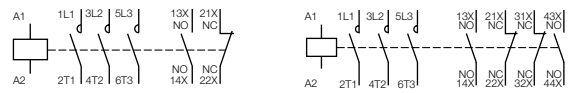

AF400 ... AF1250-30-11

AF400 ... AF1250-30-22

### AF1350 ... AF2650 contactors - AC / DC operated

Standard devices with factory mounted auxiliary contacts

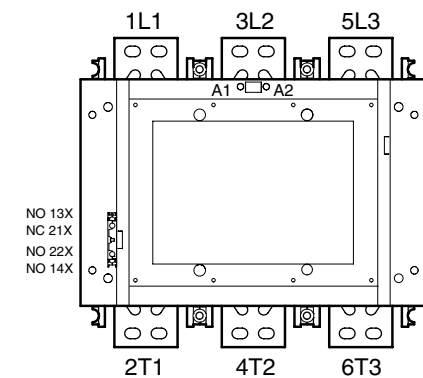

AF1350 ... AF2650-30-11

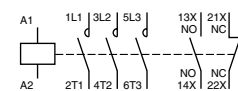

AF1350 ... AF2650-30-11

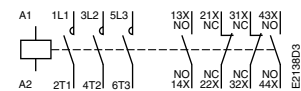

AF1350 ... AF2650-30-22

### Wiring diagrams

when used with transistor output

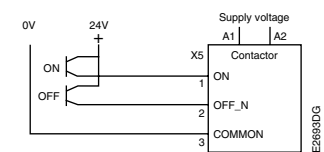

AF1350, AF1650

when used with transistor output

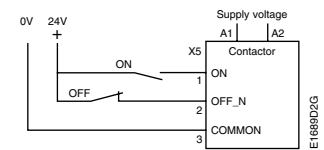

AF1350 ... AF2650-30-22

# AF09, AF12, AF16 3-pole contactors

## Main dimensions mm, inches

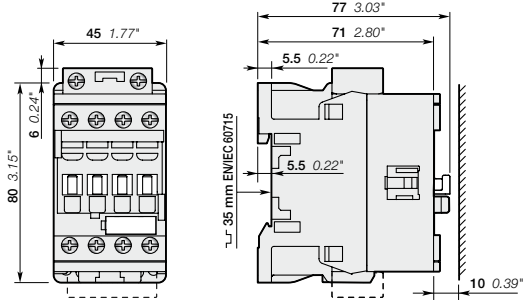

AF09, AF12, AF16

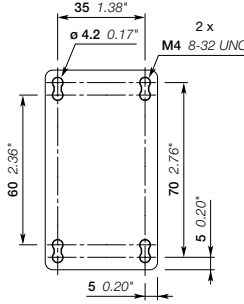

AF09, AF12, AF16

5

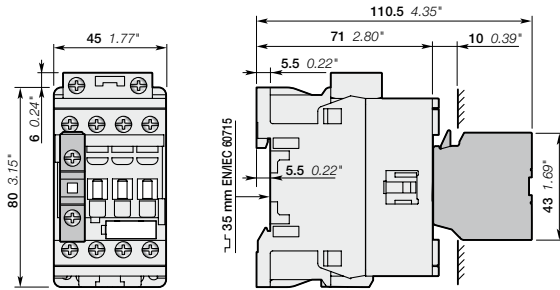

AF09, AF12, AF16  
+ CA4, CC4 1-pole auxiliary contact block

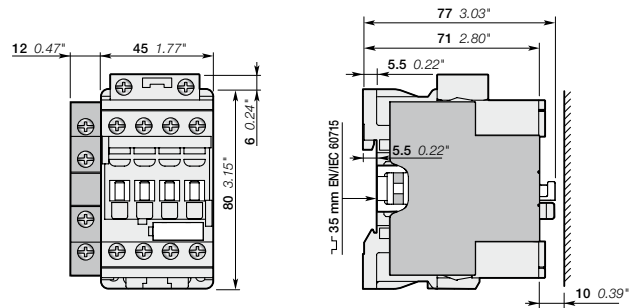

AF09, AF12, AF16  
+ CAL4-11 2-pole auxiliary contact block

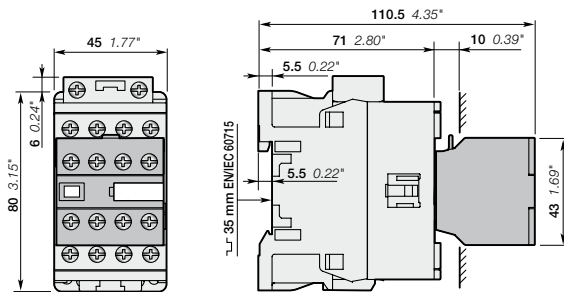

AF09, AF12, AF16  
+ CA4 4-pole auxiliary contact block

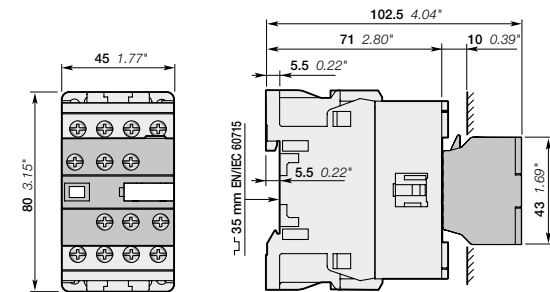

AF09, AF12, AF16  
+ CAT4 2-pole auxiliary contact and coil terminal block

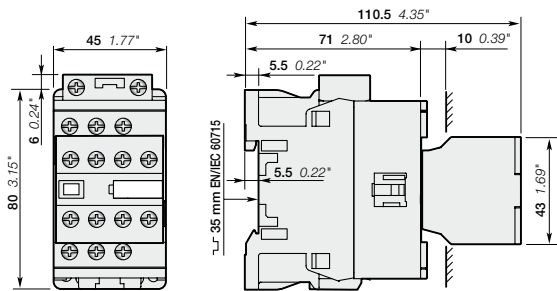

AF09, AF12, AF16...-30-22

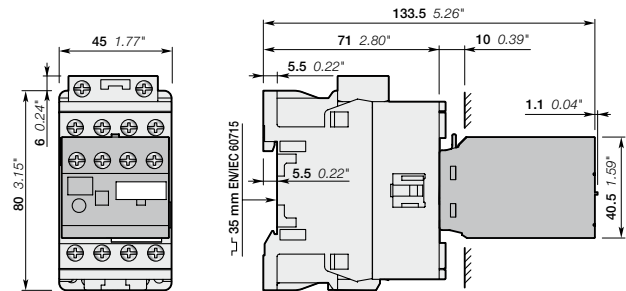

AF09, AF12, AF16  
+ TEF4 electronic timer

Note: contactor lateral distance to grounded component 2 mm 0.08" min.

# AF09, AF12, AF16 3-pole contactors

## Main dimensions mm, inches

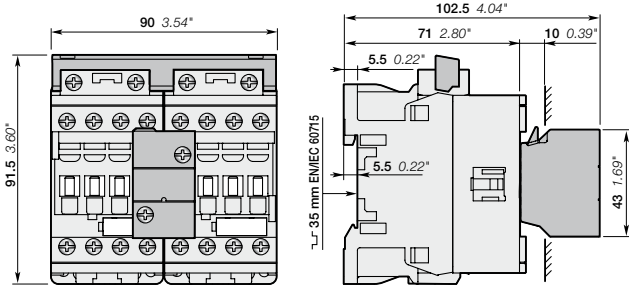

AF09, AF12, AF16  
+ VEM4 mechanical and electrical interlock set

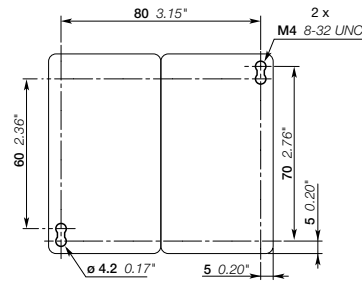

AF09, AF12, AF16  
+ VEM4 mechanical and electrical interlock set

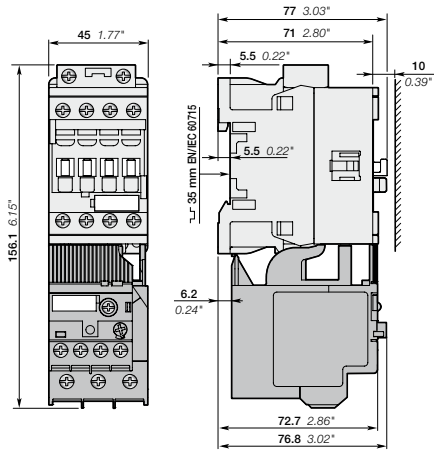

AF09, AF12, AF16  
+ TF42 thermal overload relay

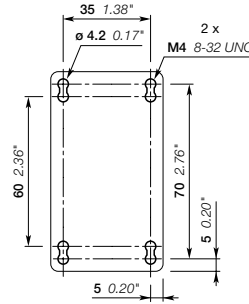

AF09, AF12, AF16  
+ TF42, EF19

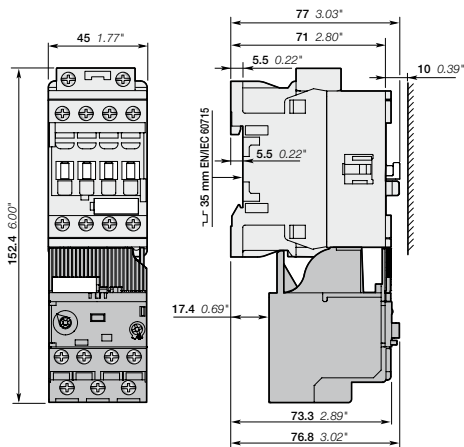

AF09, AF12, AF16 3-pole contactors  
+ EF19 electronic overload relay

Note: contactor lateral distance to grounded component 2 mm 0.08" min.

# AF26, AF30, AF38 3-pole contactors

## Main dimensions mm, inches

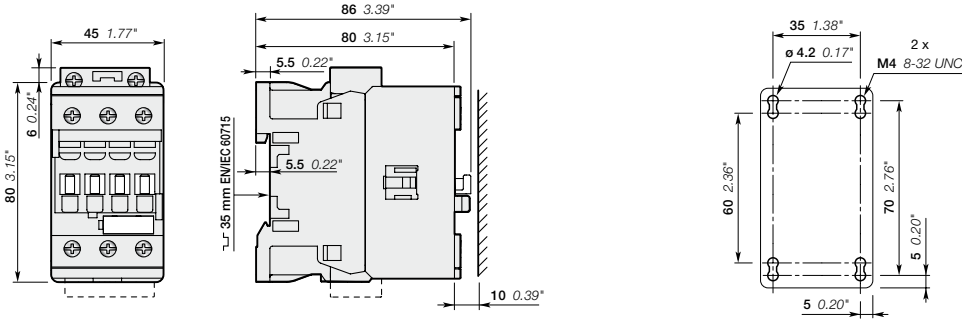

AF26, AF30, AF38

AF26, AF30, AF38

5

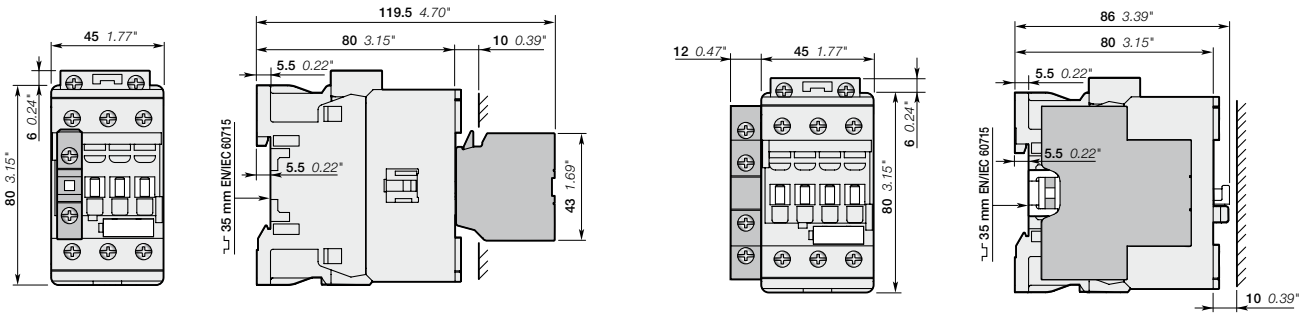

AF26, AF30, AF38  
+ CA4, CC4 1-pole auxiliary contact block

AF26, AF30, AF38  
+ CAL4-11 2-pole auxiliary contact block

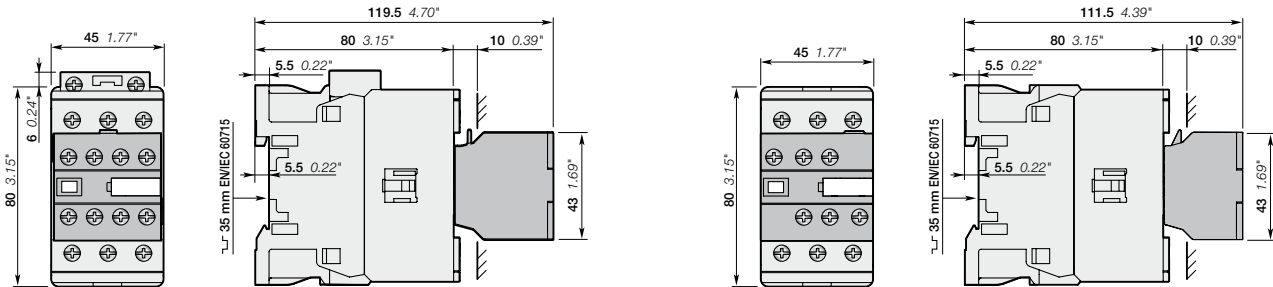

AF26, AF30, AF38  
+ CA4 4-pole auxiliary contact block

AF26, AF30, AF38  
+ CAT4 2-pole auxiliary contact and coil terminal block

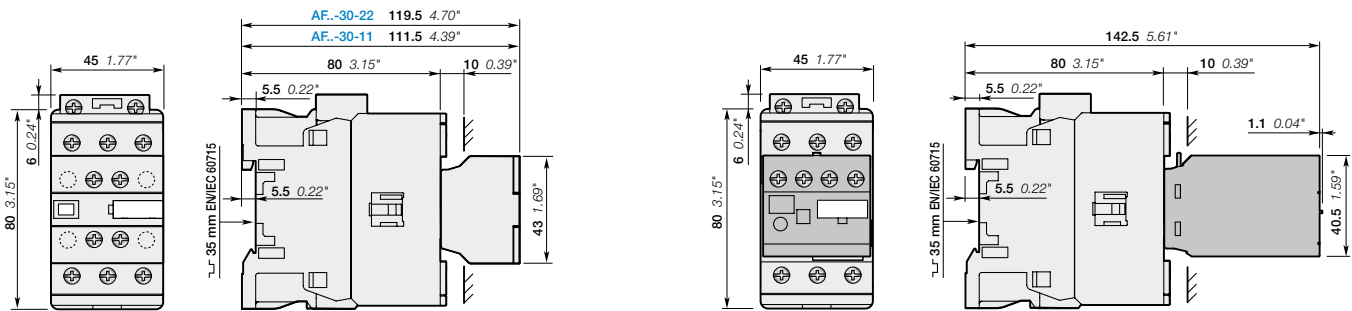

AF26, AF30, AF38...-30-11  
AF26, AF30, AF38...-30-22

AF26, AF30, AF38  
+ TEF4 electronic timer

Note: contactor lateral distance to grounded component 2 mm 0.08" min.

# AF26, AF30, AF38 3-pole contactors

## Main dimensions mm, inches

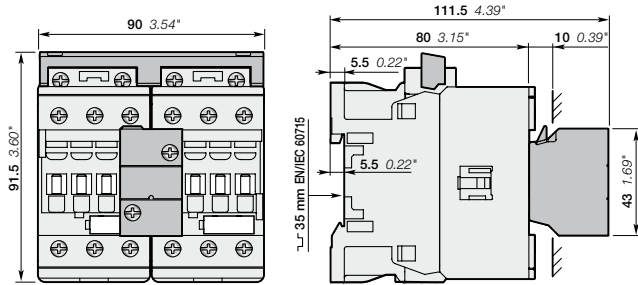

AF26, AF30, AF38  
+ VEM4 mechanical and electrical interlock set

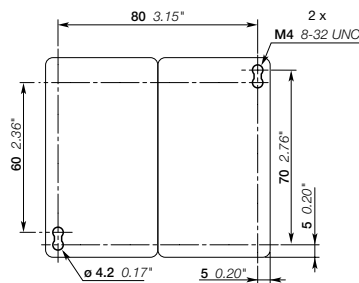

AF26, AF30, AF38  
+ VEM4 mechanical and electrical interlock set

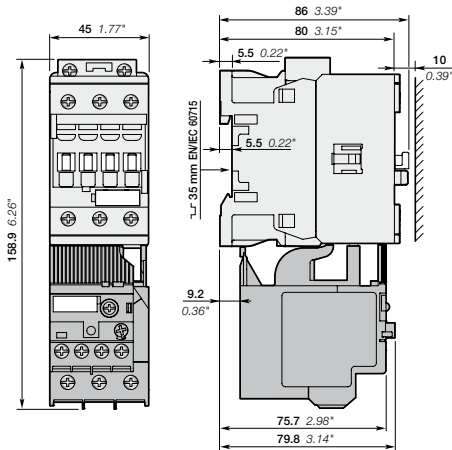

AF26, AF30, AF38  
+ TF42 thermal overload relay

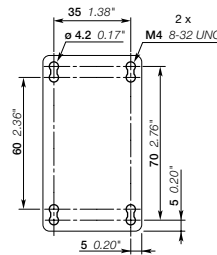

AF26, AF30, AF38  
+ TF42, EF19, EF45

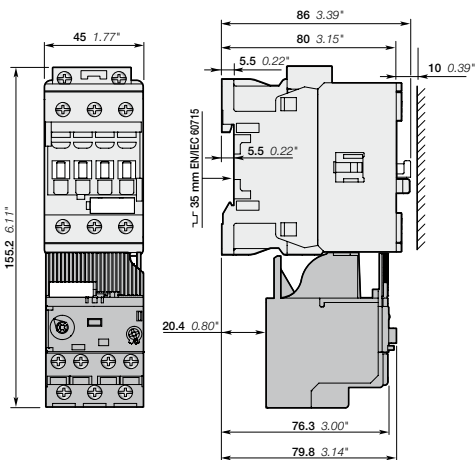

AF26 3-pole contactors  
+ EF19 electronic overload relay

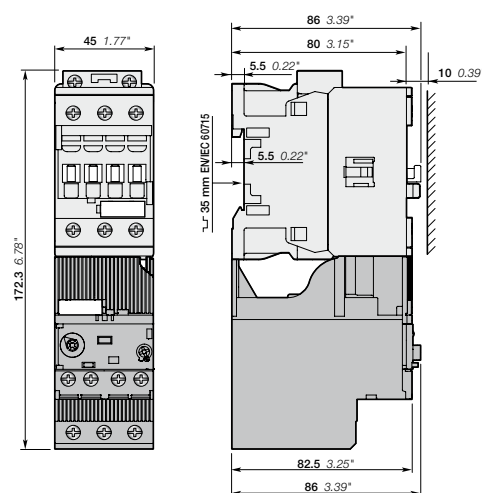

AF26, AF30, AF38 3-pole contactors  
+ EF45 electronic overload relay

Note: contactor lateral distance to grounded component 2 mm 0.08" min.

# AF40 ... AF65 3-pole contactors

## Main dimensions mm, inches

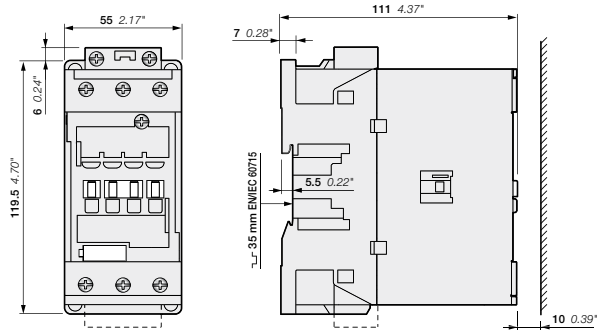

5 AF40, AF52, AF65

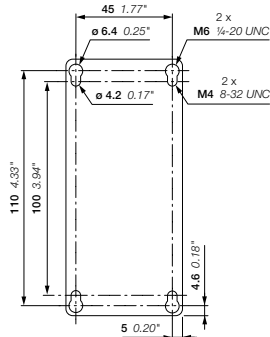

AF40, AF52, AF65

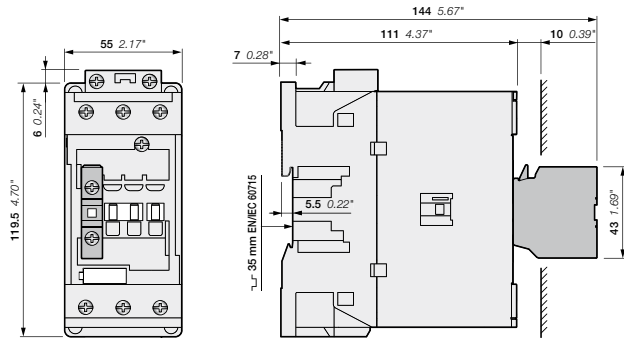

AF40, AF52, AF65 + CA4, CC4 1-pole auxiliary contact block

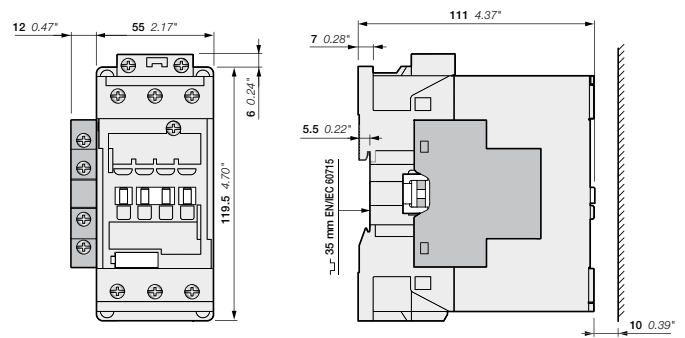

AF40, AF52, AF65-30-00 + CAL4-11 2-pole auxiliary contact block  
AF40, AF52, AF65-30-11

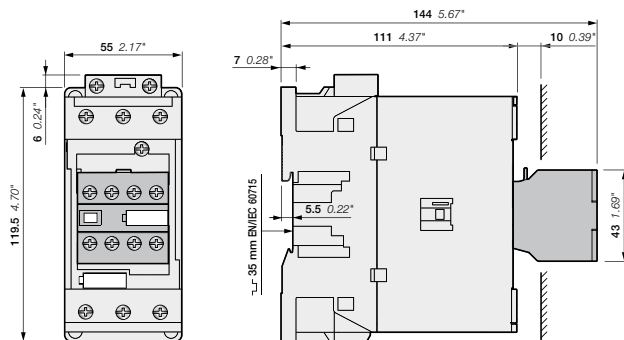

AF40, AF52, AF65 + CA4 4-pole auxiliary contact block

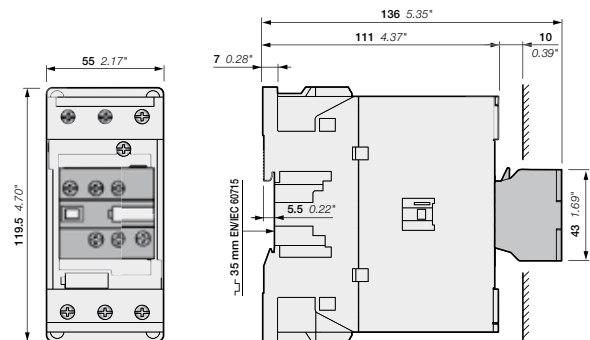

AF40, AF52, AF65 + CAT4 2-pole auxiliary contact and coil terminal block

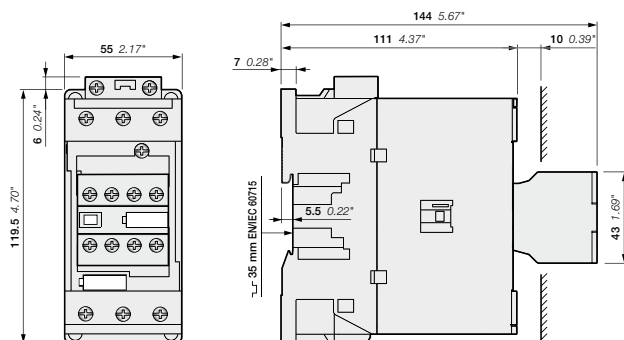

AF40, AF52, AF65...-30-22

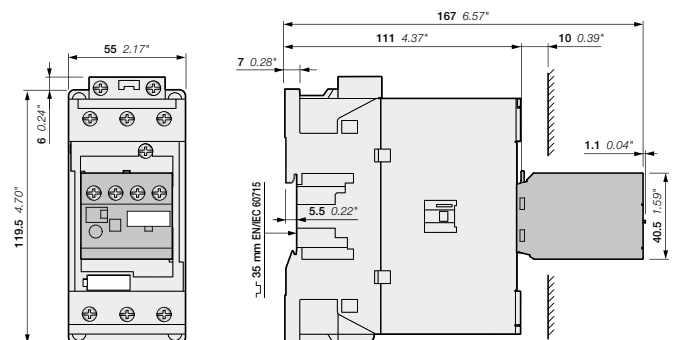

AF40, AF52, AF65 + TEF4 electronic timer

# AF40 ... AF65 3-pole contactors

## Main dimensions mm, inches

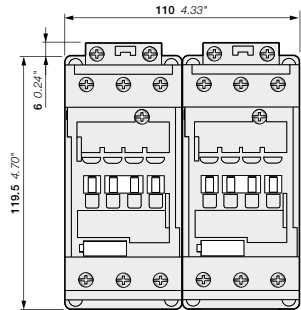

AF40, AF52, AF65  
+ VM96-4 mechanical interlock set

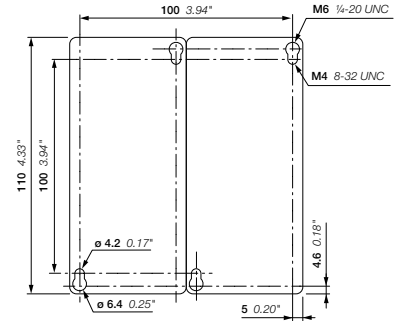
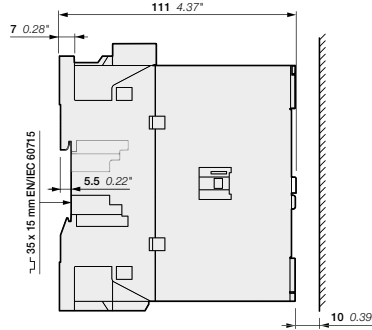

AF40, AF52, AF65  
+ VM96-4 mechanical interlock set

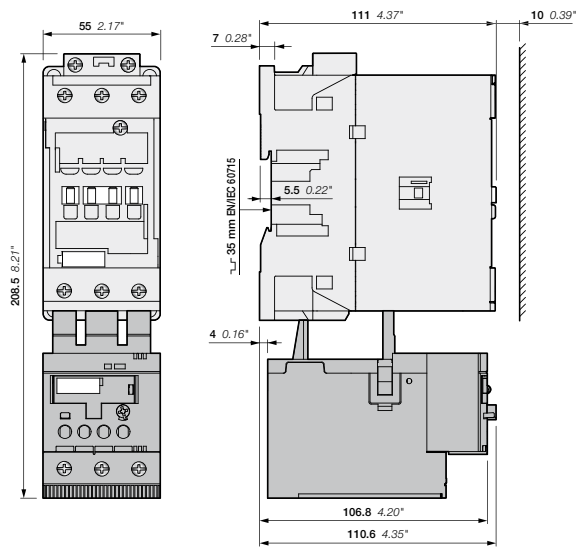

AF40, AF52, AF65  
+ TF65 thermal overload relay

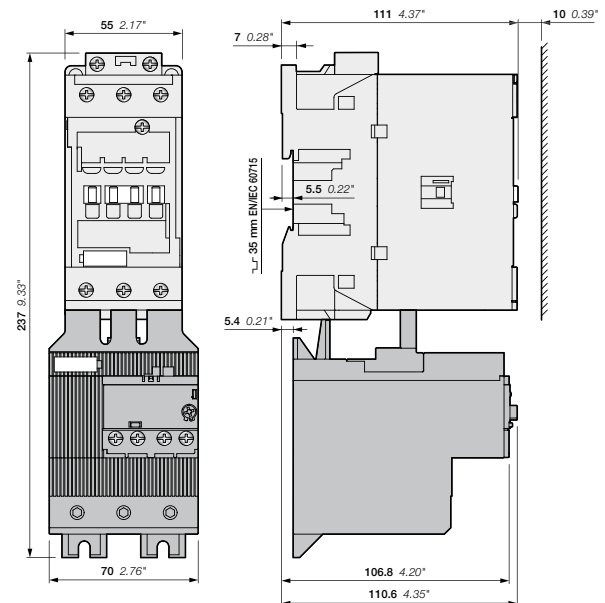

AF40, AF52, AF65  
+ EF65 electronic overload relay

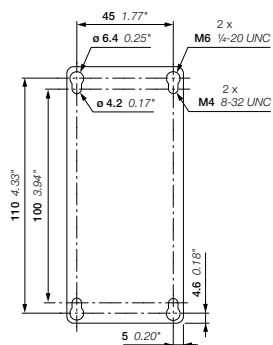

AF40, AF52, AF65  
+ TF65, EF65

# AF80 ... AF96 3-pole contactors

## Main dimensions mm, inches

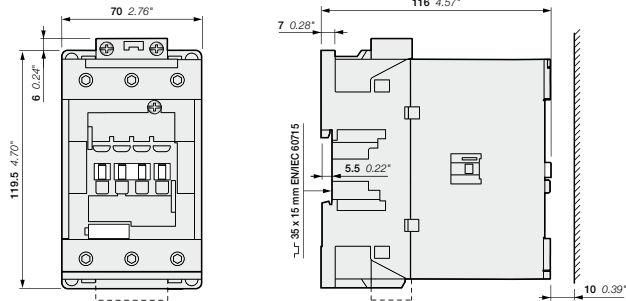

AF80, AF96

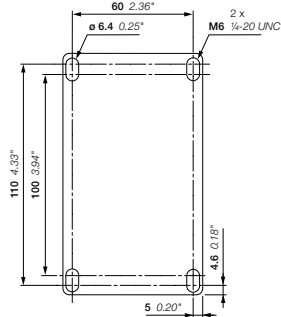

AF80, AF96

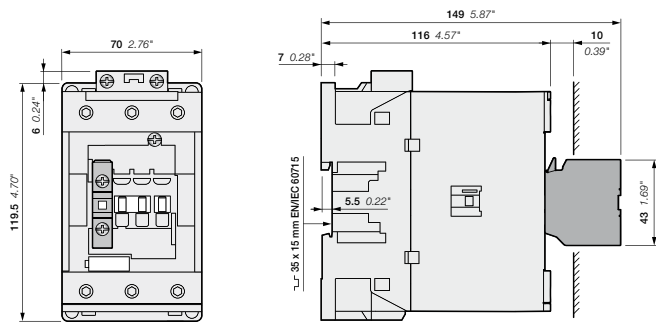

AF80, AF96  
+ CA4, CC4 1-pole auxiliary contact block

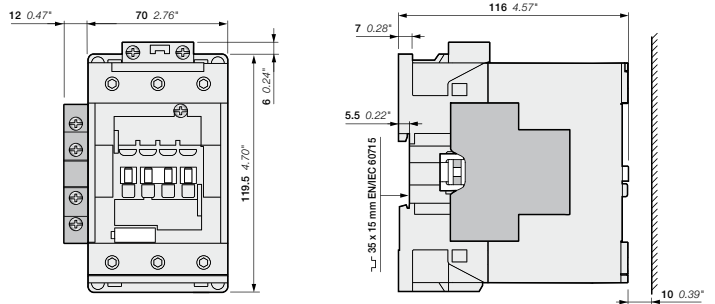

AF80, AF96-30-00 + CAL4-11 2-pole auxiliary contact block  
AF80, AF96-30-11

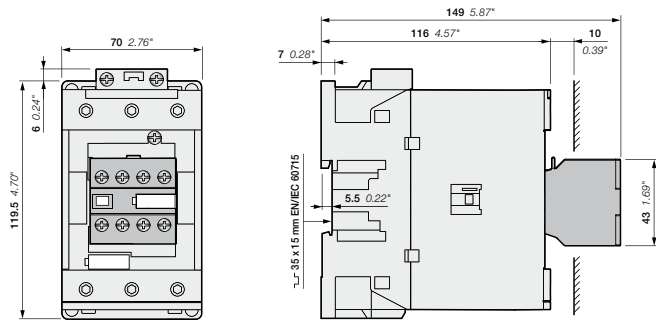

AF80, AF96  
+ CA4 4-pole auxiliary contact block

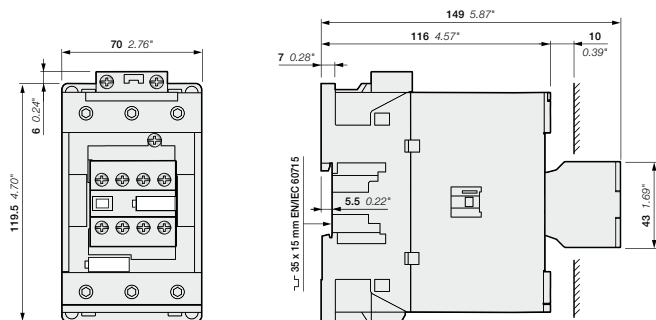

AF80, AF96...-30-22

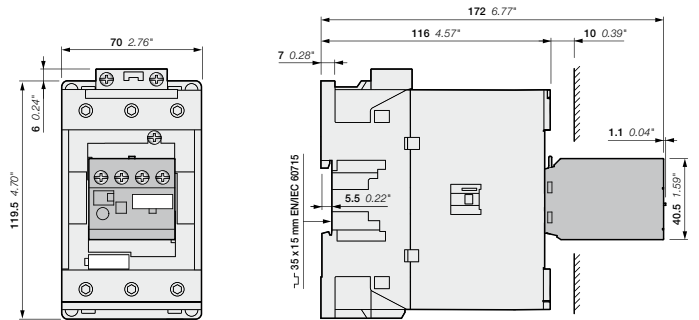

AF80, AF96  
+ TEF4 electronic timer



# AF80 ... AF96 3-pole contactors

## Main dimensions mm, inches

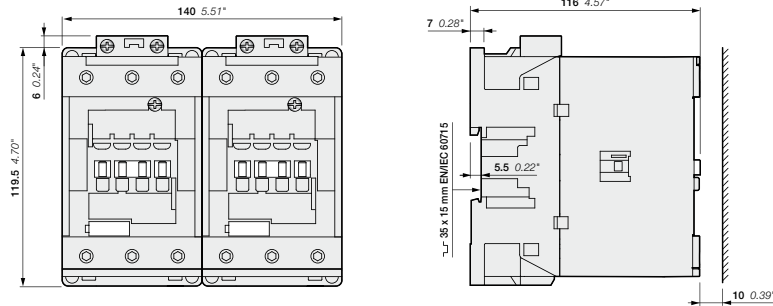

AF80, AF96  
+ VM96-4 mechanical interlock set

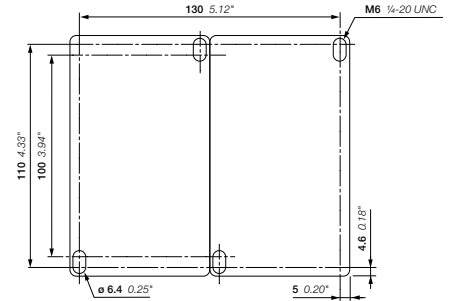

AF80, AF96  
+ VM96-4 mechanical interlock set

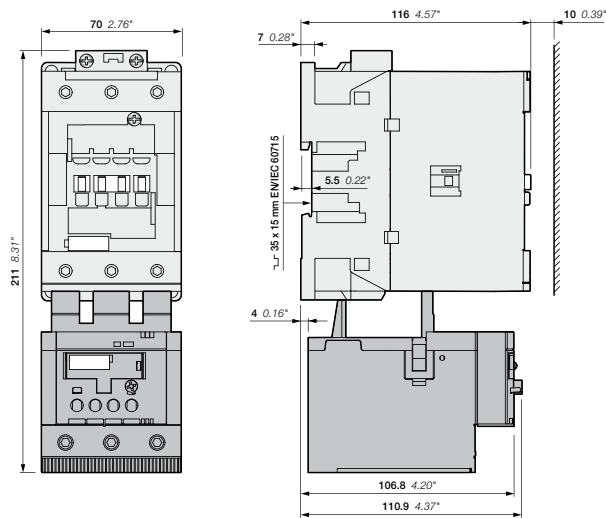

AF80, AF96  
+ TF96 thermal overload relay

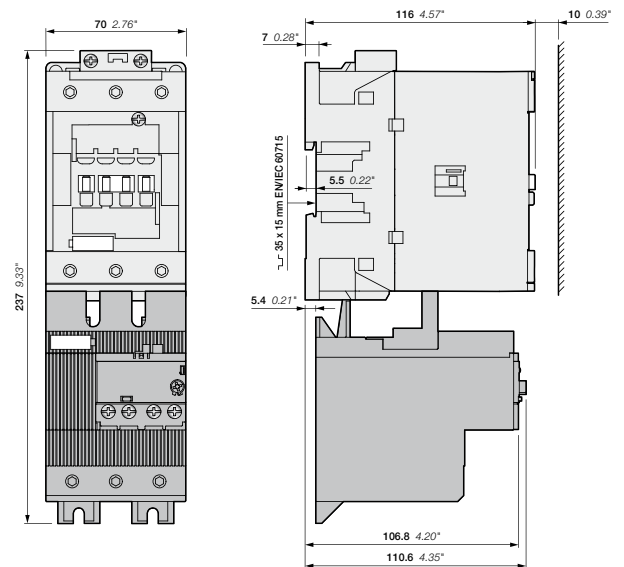

AF80, AF96  
+ EF96 electronic overload relay

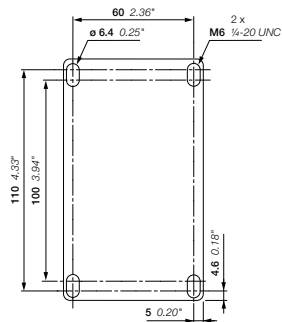

AF80, AF96  
+ TF96, EF96

# AF116, AF140, AF146 3-pole contactors

## Main dimensions mm, inches

SECTION D-D

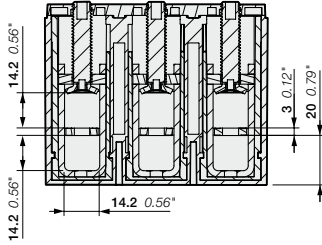

SECTION E-E

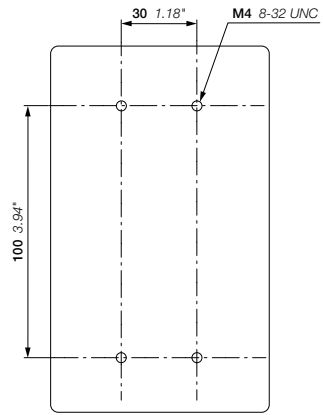
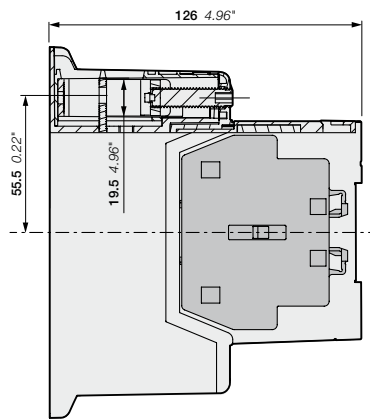

AF116, AF140, AF146-30-00 + CAL19 2-pole auxiliary contact block  
AF116, AF140, AF146-30-11

AF116, AF140, AF146-30...(B)

SECTION D-D

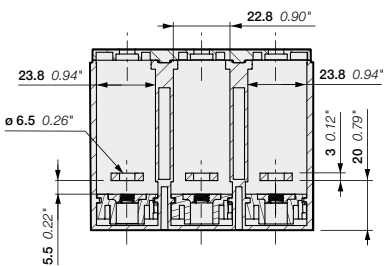

SECTION E-E

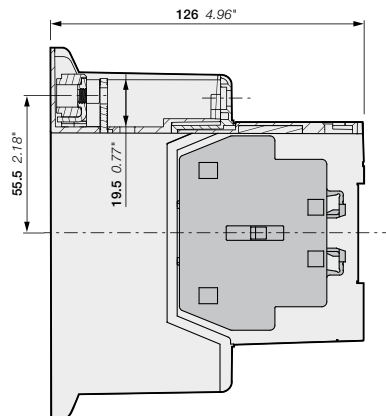

AF116, AF140, AF146-30-00B + CAL19 2-pole auxiliary contact block  
AF116, AF140, AF146-30-11B

# AF116, AF140, AF146 3-pole contactors

## Main dimensions mm, inches

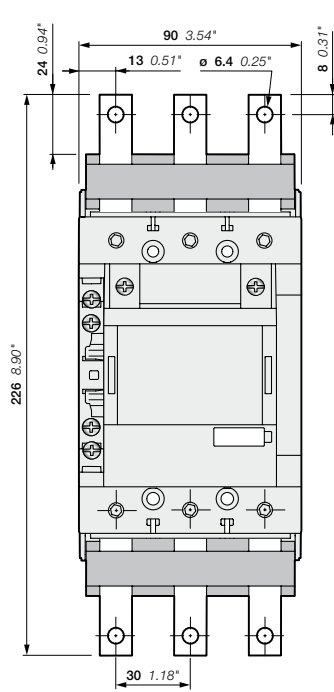

AF116, AF140, AF146-30-11  
+ LX140 terminal extension

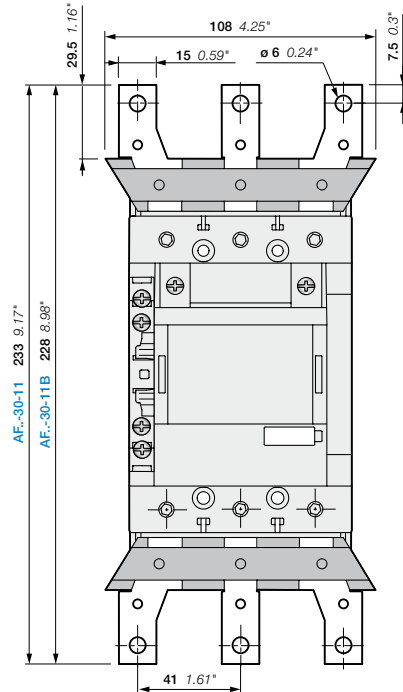

AF116, AF140, AF146-30-11(B)  
+ LW140(B) terminal enlargement

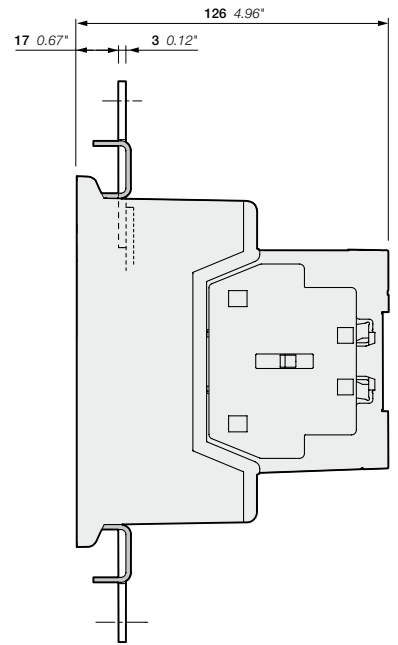

5

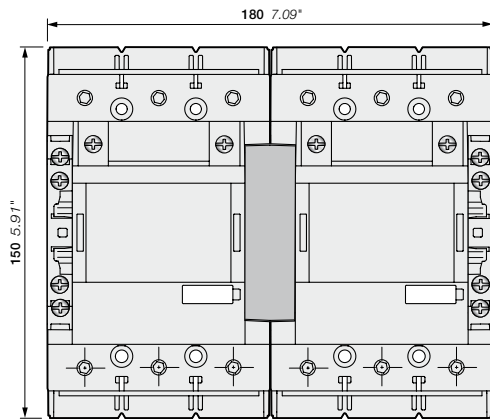

AF116, AF140, AF146-30-11(B)  
+ VM19 mechanical interlocking unit

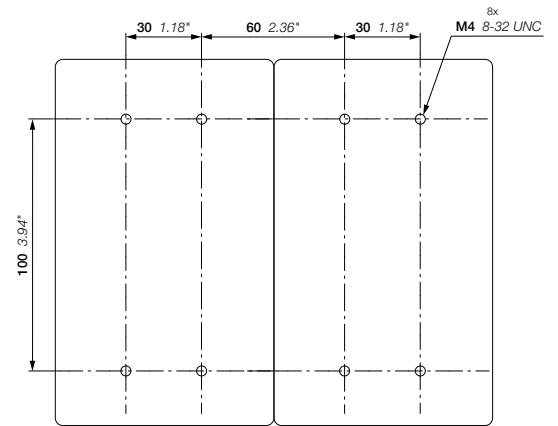
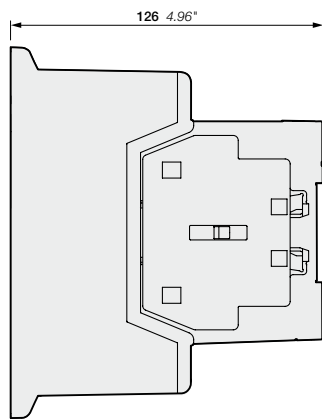

AF116, AF140, AF146-30-11(B)  
+ VM19 mechanical interlocking unit

# AF116, AF140, AF146 3-pole contactors

## Main dimensions mm, inches

5

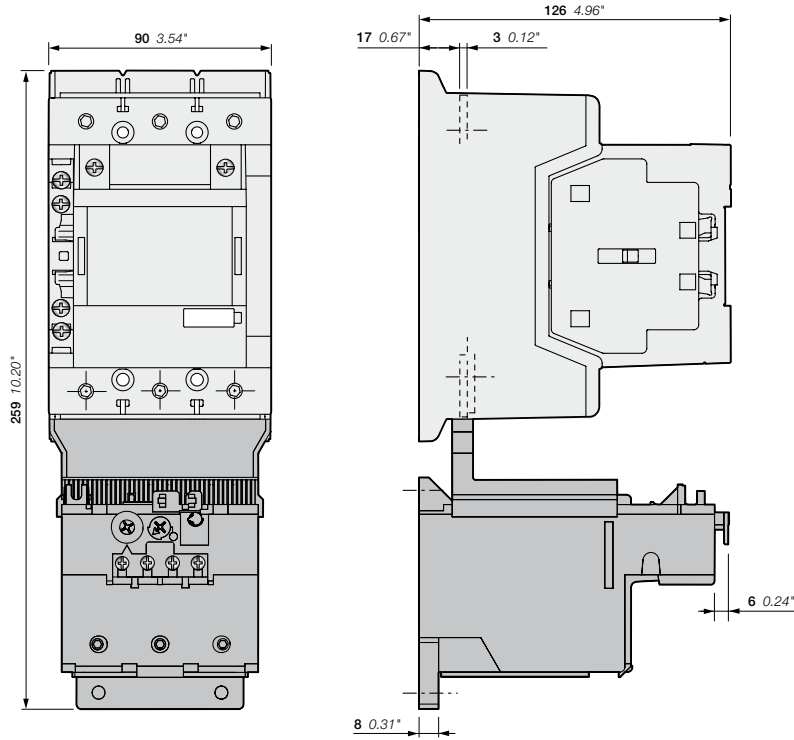

AF116, AF140-30-11(B)  
+ TF140 thermal overload relay

AF116, AF140-30-11(B)  
+ TF140 thermal overload relay

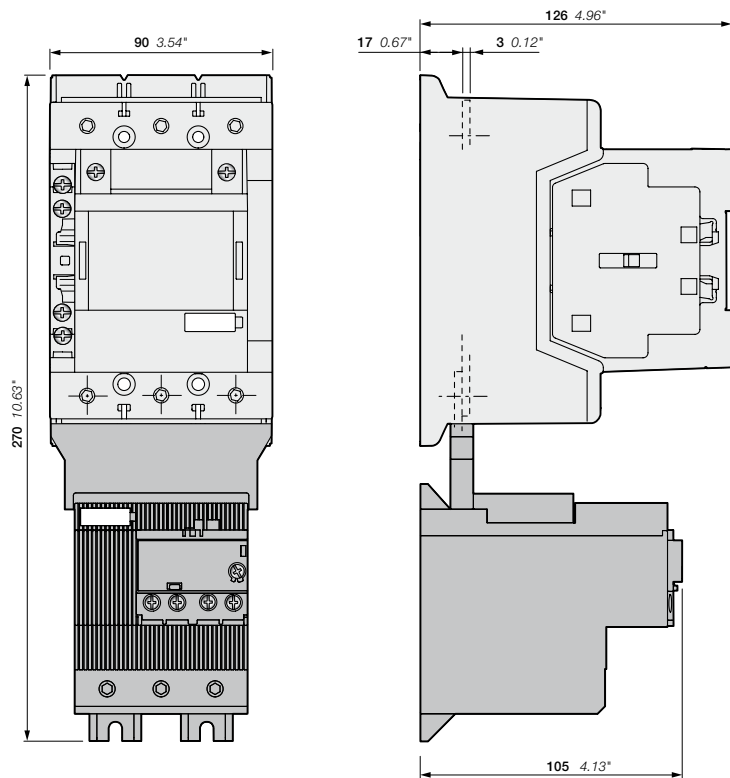

AF116, AF140, AF146-30-11(B)  
+ EF146 electronic overload relay

AF116, AF140, AF146-30-11(B)  
+ EF146 electronic overload relay

# AF190, AF205 3-pole contactors

## Main dimensions mm, inches

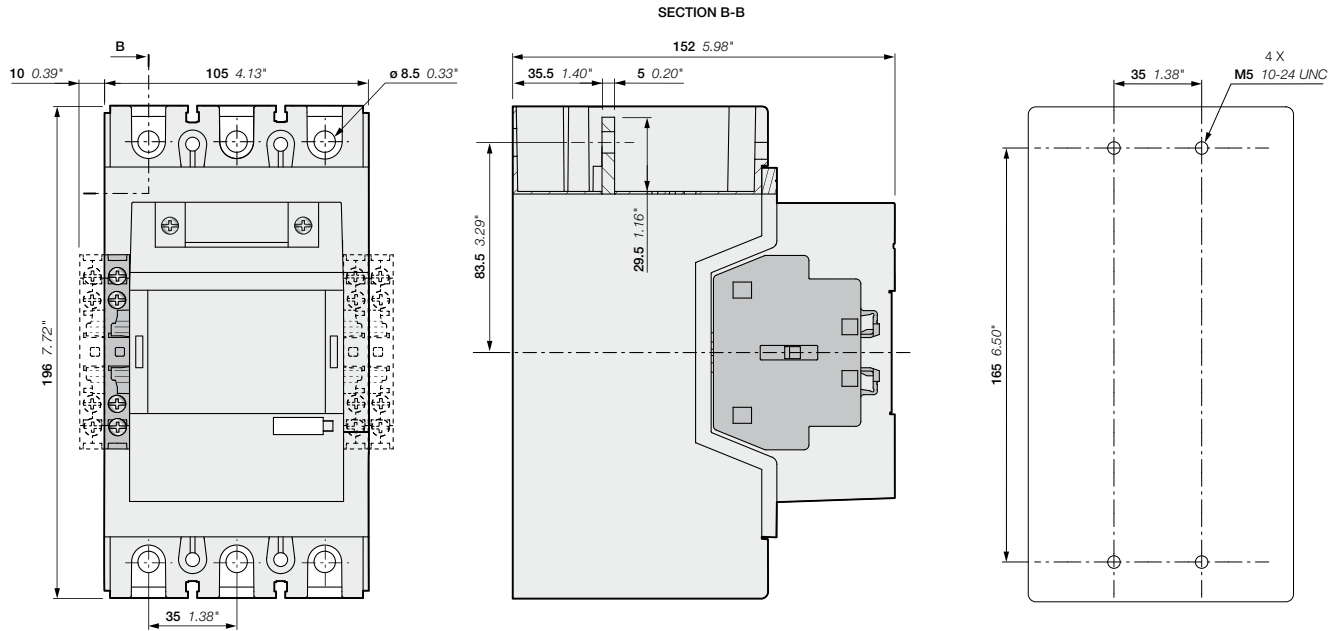

AF190, AF205-30-00 + CAL19 2-pole auxiliary contact block  
AF190, AF205-30-11

AF190, AF205

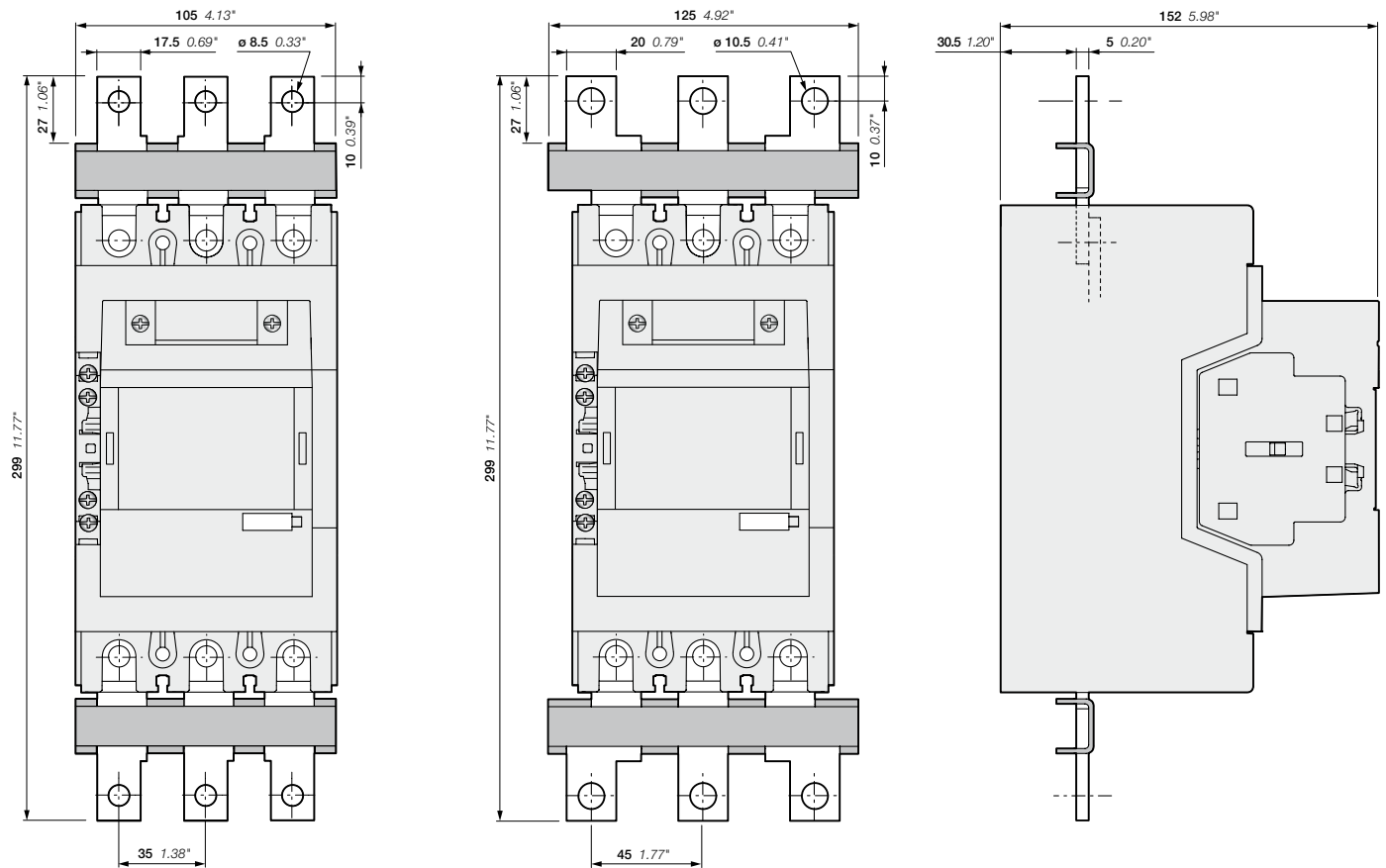

AF190, AF205-30-11  
+ LX185 terminal extension

AF190, AF205-30-11  
+ LW185 terminal enlargement

# AF190, AF205 3-pole contactors

## Main dimensions mm, inches

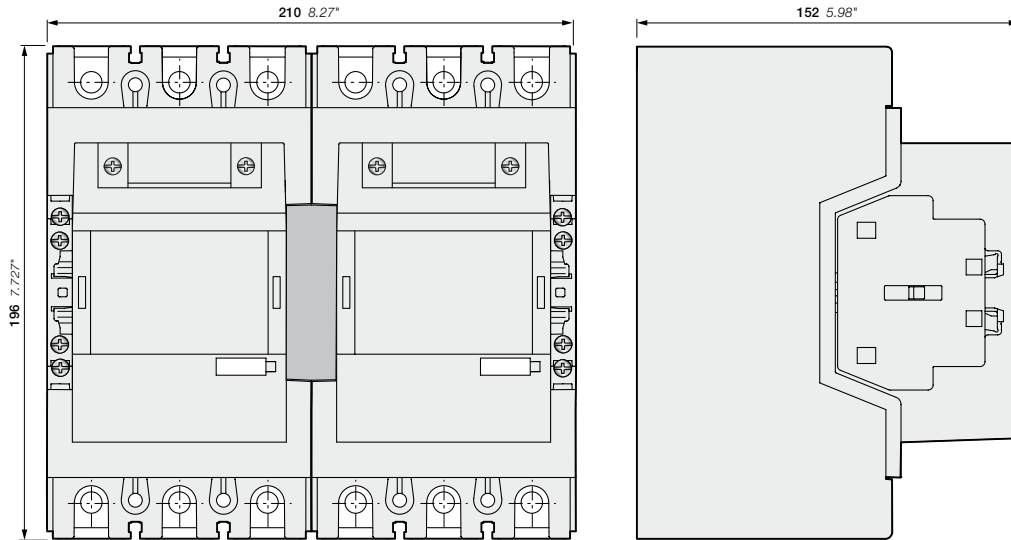

5

AF190, AF205-30-11  
+ VM19 mechanical interlocking unit

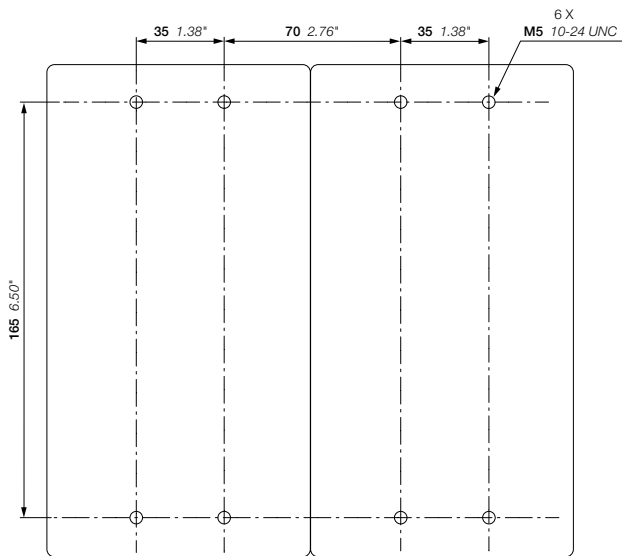

AF190, AF205  
+ VM19 mechanical interlocking unit

# AF190, AF205 3-pole contactors

## Main dimensions mm, inches

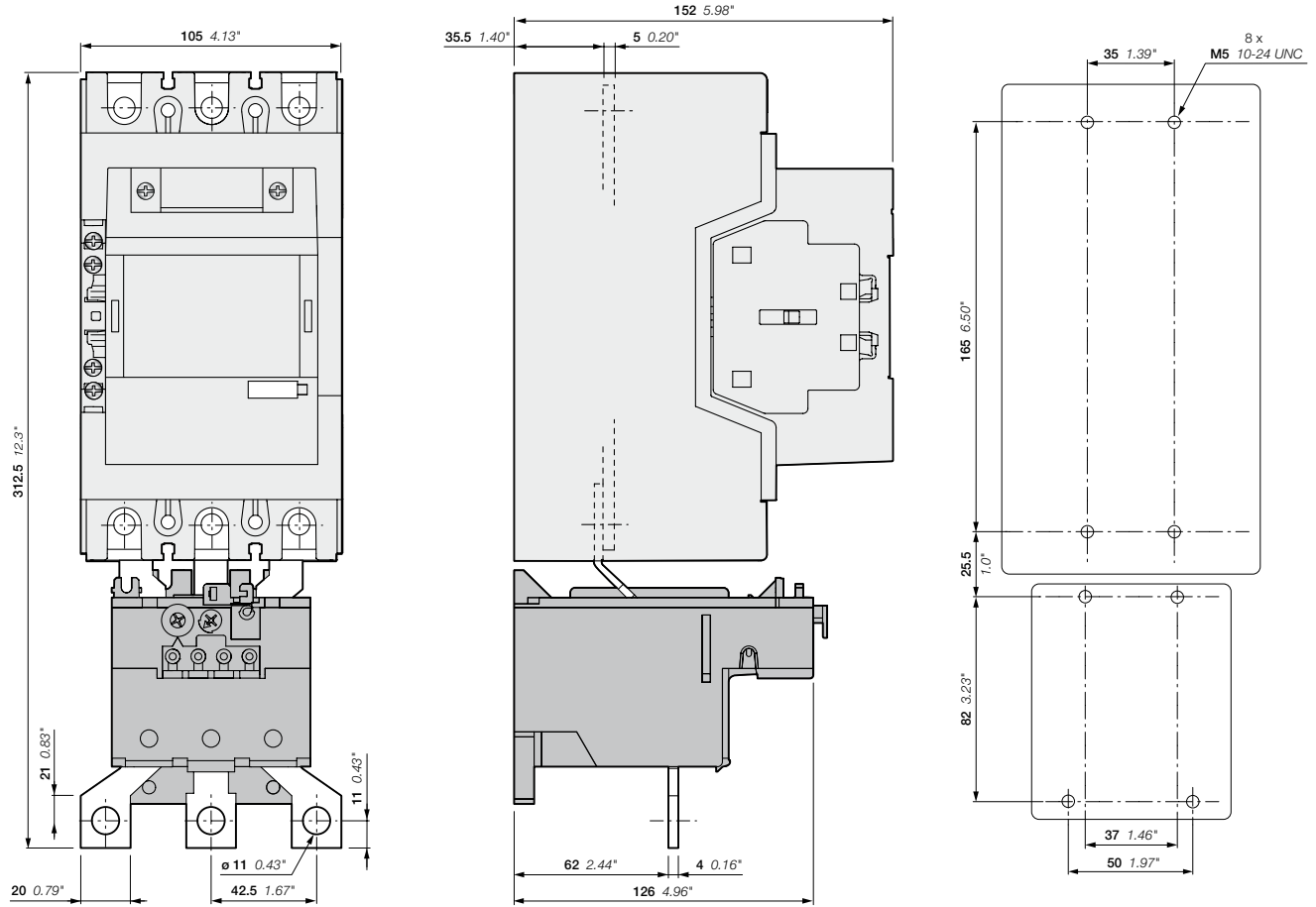

AF190, AF205-30-11  
+ TA200DU thermal overload relay

AF190, AF205  
+ TA200DU thermal overload relay

# AF190, AF205 3-pole contactors

## Main dimensions mm, inches

5

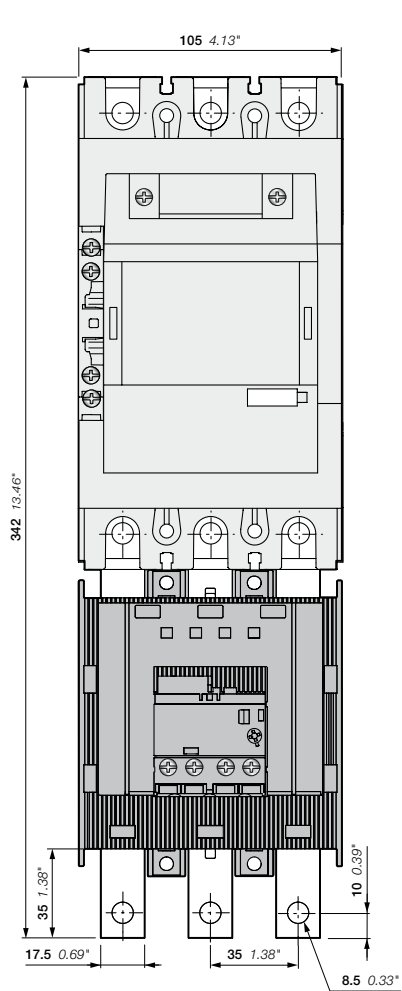

AF190, AF205-30-11  
+ EF205 electronic overload relay

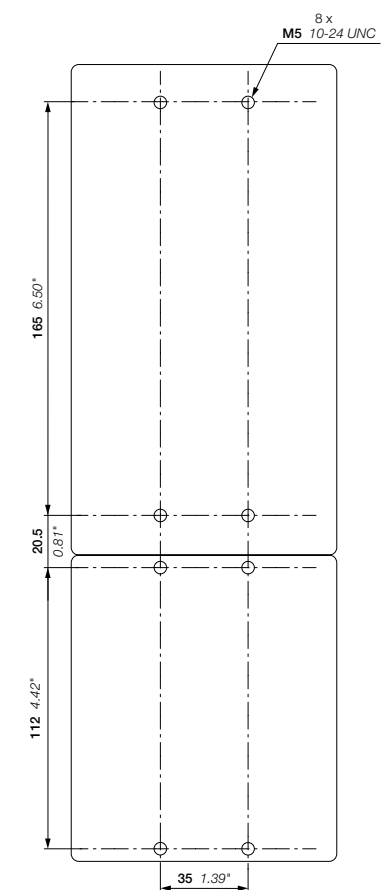
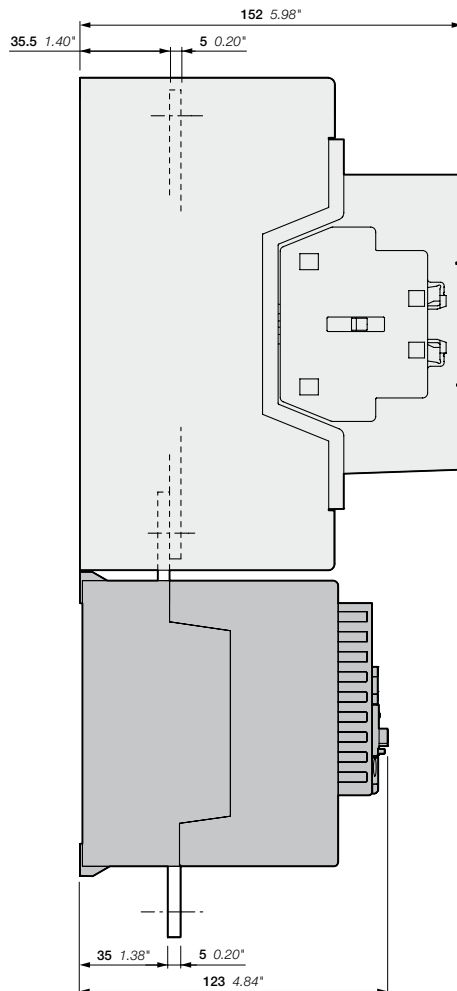

AF190, AF205  
+ EF205 electronic overload relay



# AF265, AF305, AF370 3-pole contactors

## Main dimensions mm, inches

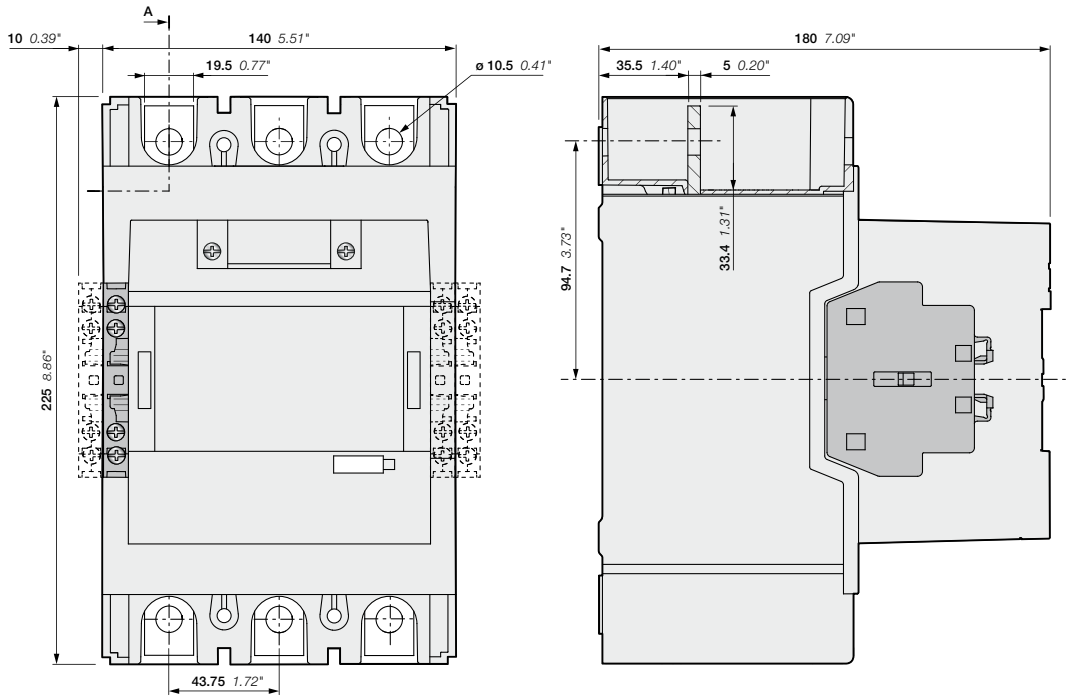

AF265, AF305, AF370-30-00 + CAL19 2-pole contact block  
 AF265, AF305, AF370-30-11

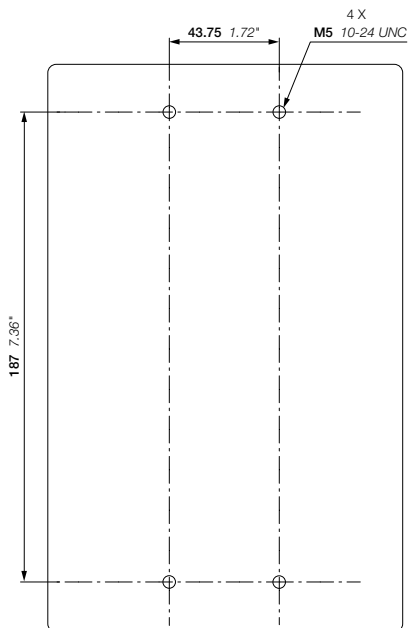

AF265, AF305, AF370

# AF265, AF305, AF370 3-pole contactors

## Main dimensions mm, inches

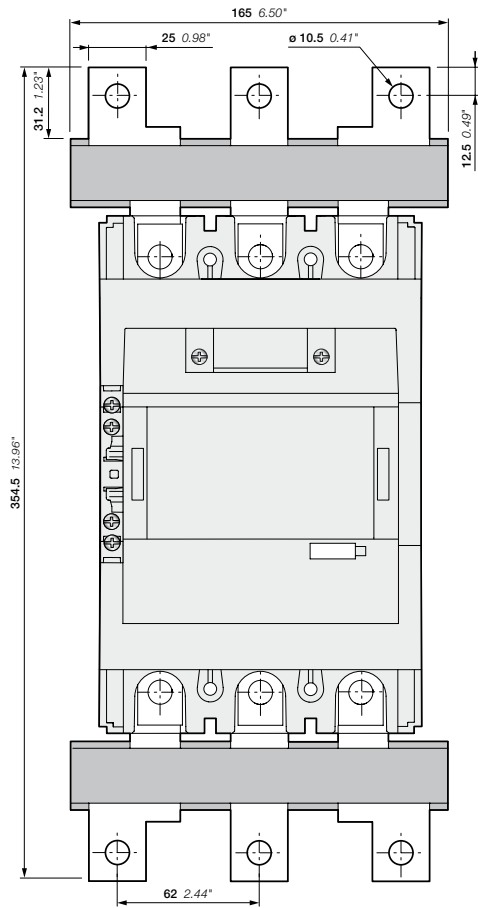

AF265, AF305, AF370-30-11  
+ LX300 terminal extension

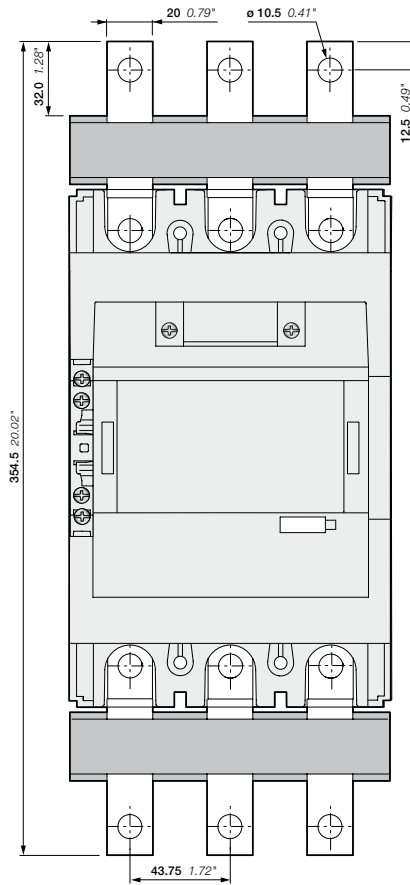

AF265, AF305, AF370-30-11  
+ LW300 terminal enlargement

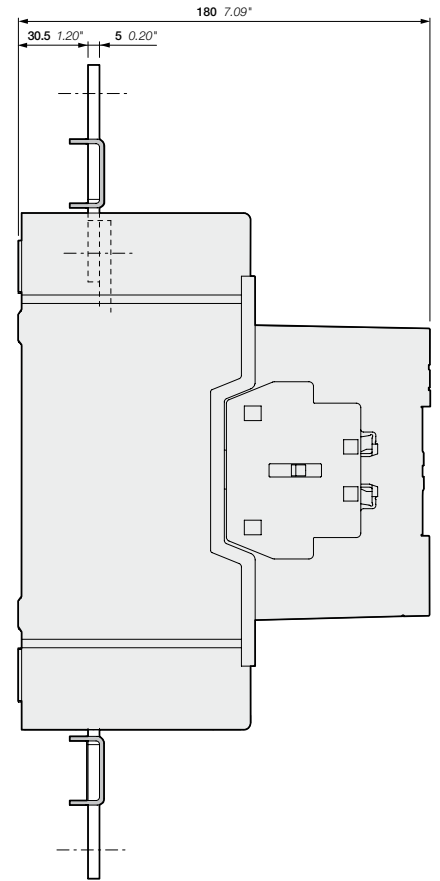

5

# AF265, AF305, AF370 3-pole contactors

## Main dimensions mm, inches

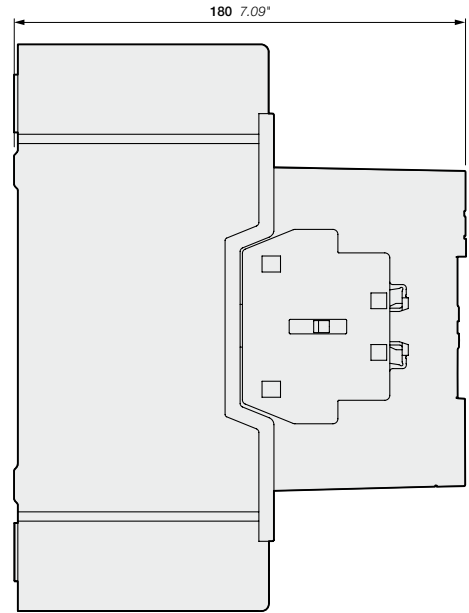
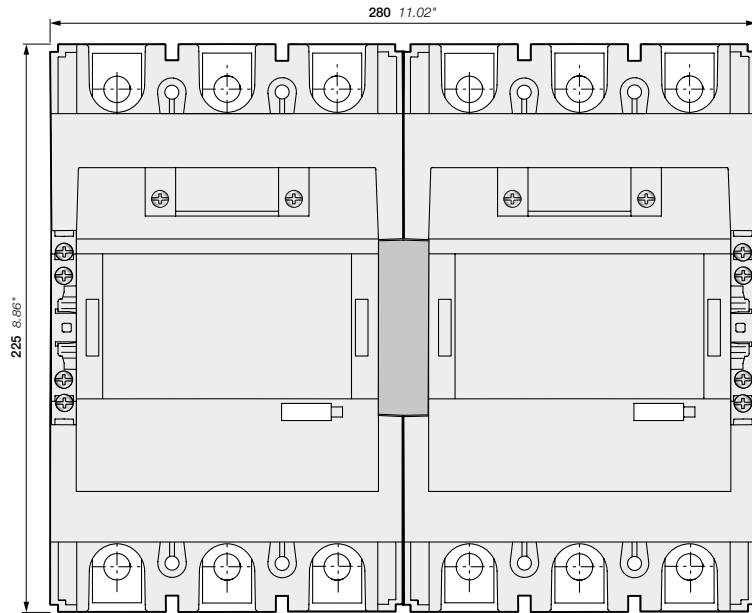

AF265, AF305, AF370-30-11  
+ VM19 mechanical interlocking unit

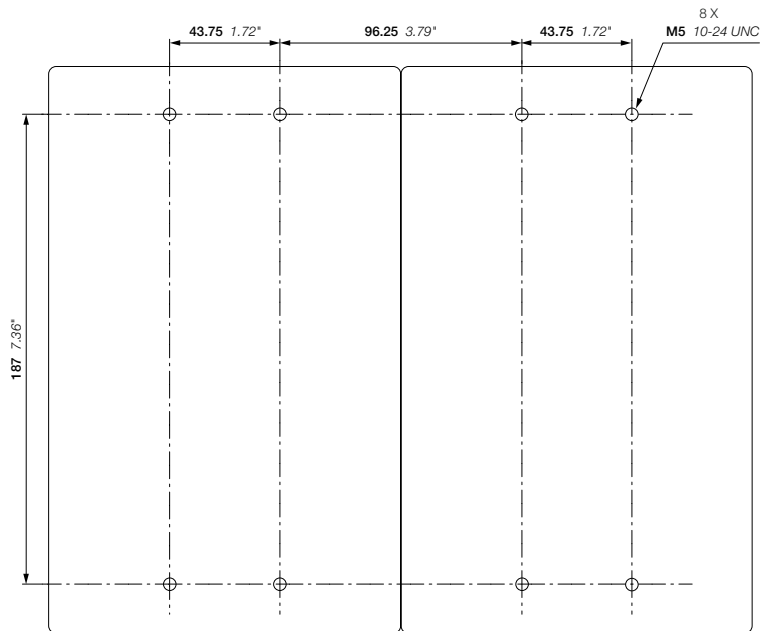

AF265, AF305, AF370  
+ VM19 mechanical interlocking unit

# AF265, AF305, AF370 3-pole contactors

Main dimensions mm, inches

5

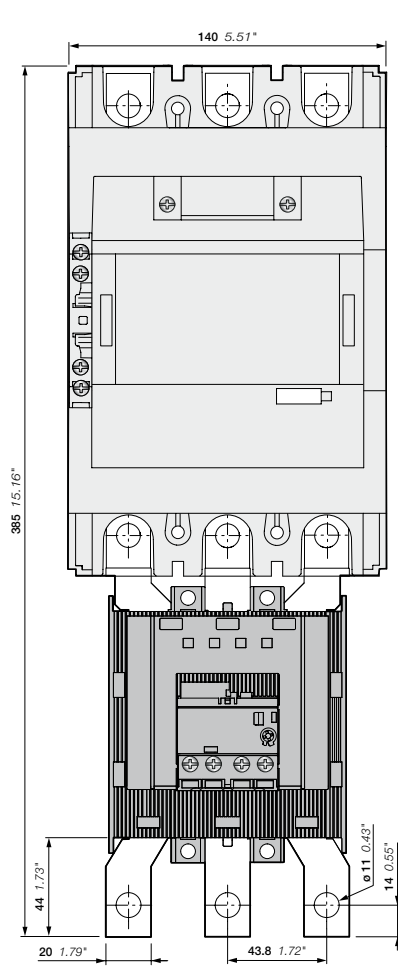

AF265, AF305, AF370-30-11  
+ EF370 electronic overload relay

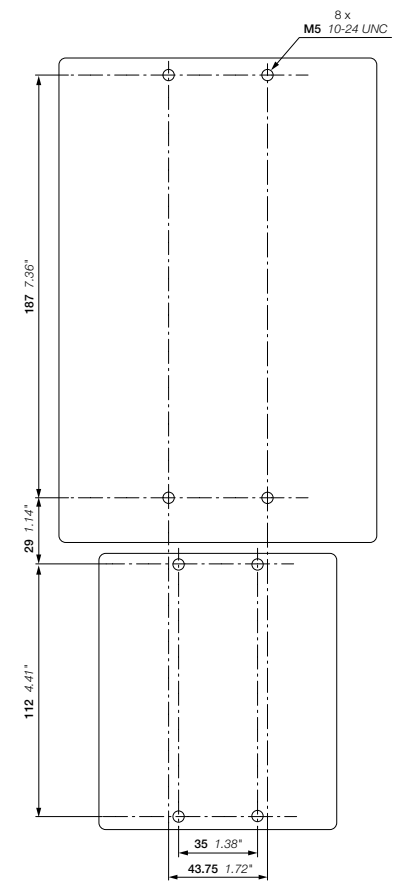
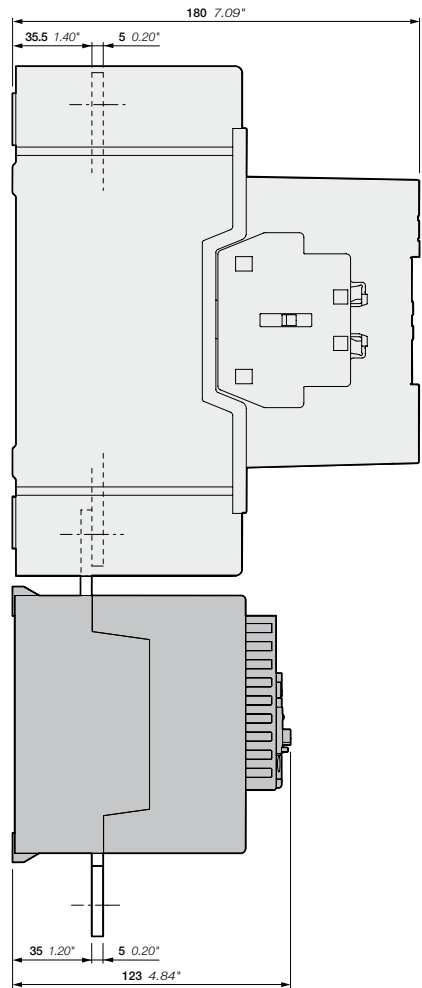

AF265, AF305, AF370  
+ EF370 electronic overload relay

# AF400 and AF460 3-pole contactors

## Main dimensions mm, inches

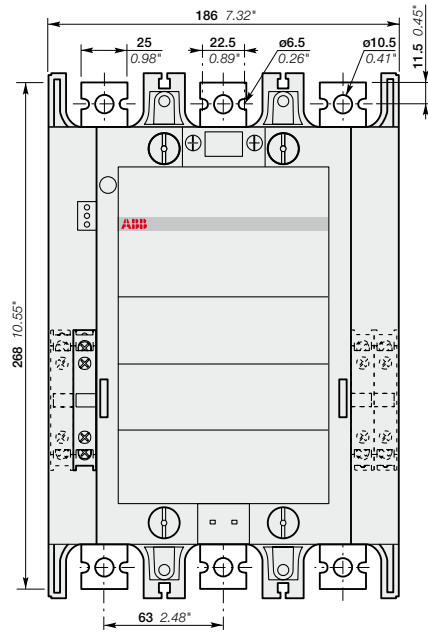

AF400, AF460-30-11

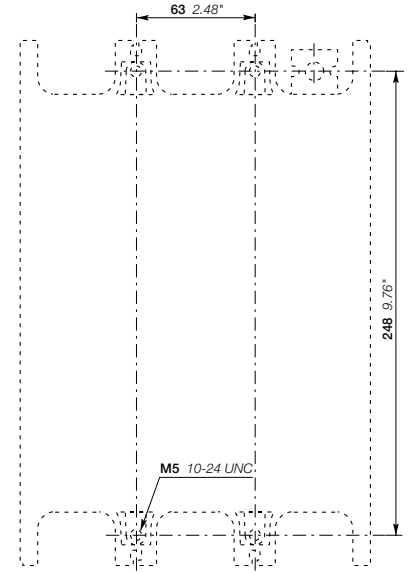
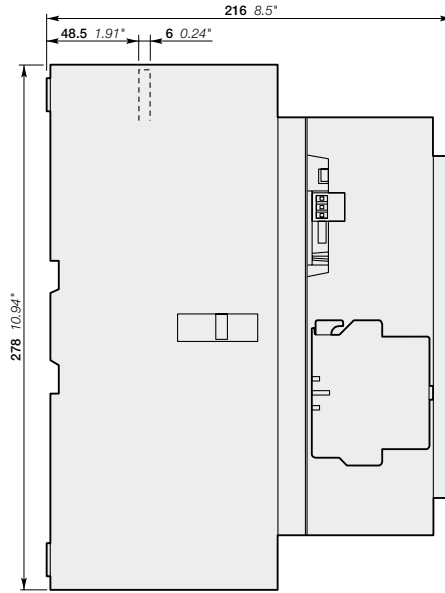

AF400, AF460

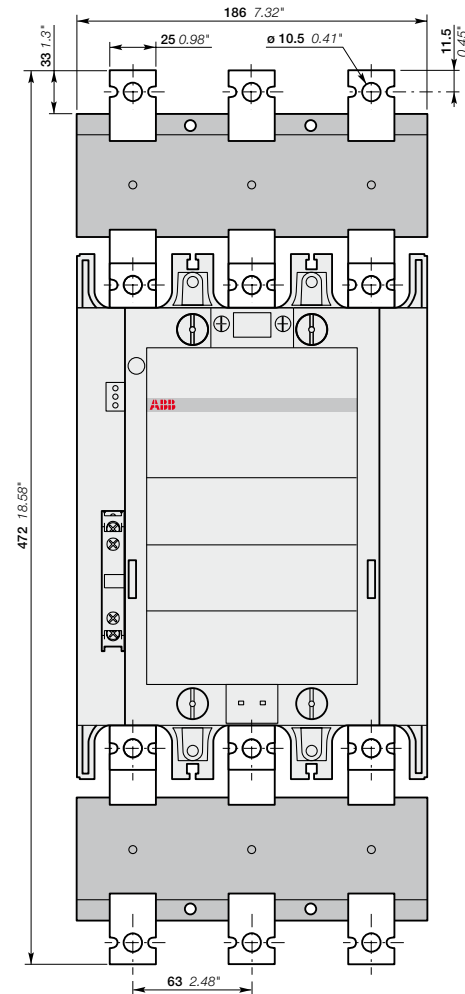

AF400, AF460-30-11  
+ LX460 terminal extension

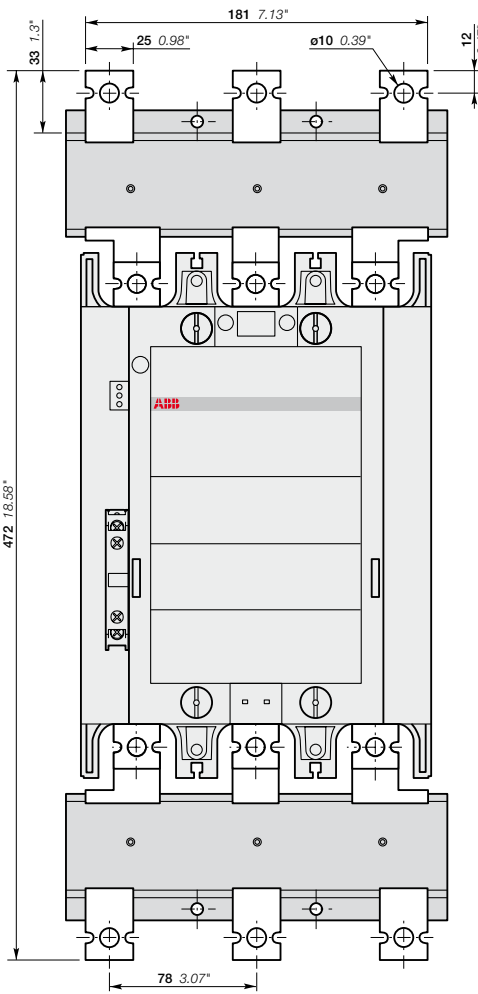

AF400, AF460-30-11  
+ LW460 terminal enlargement

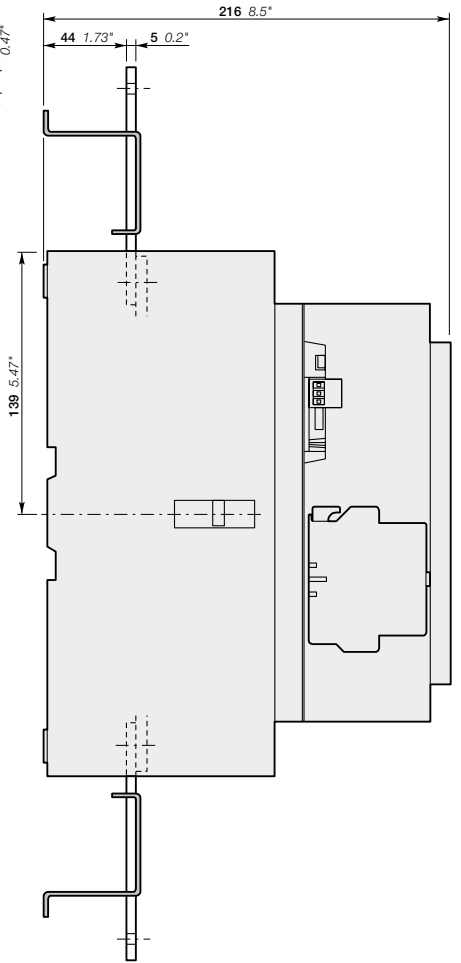

# AF400 and AF460 3-pole contactors

## Main dimensions mm, inches

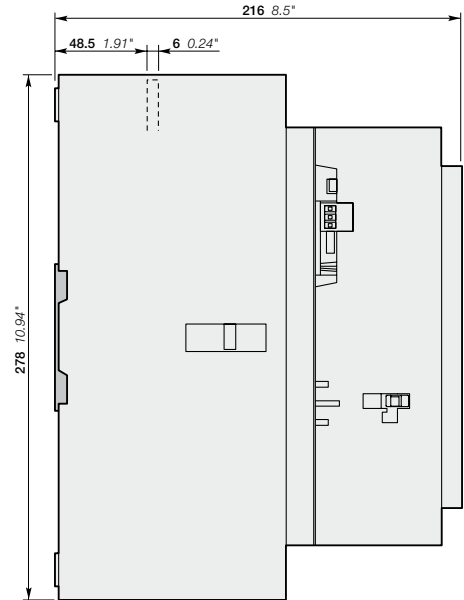
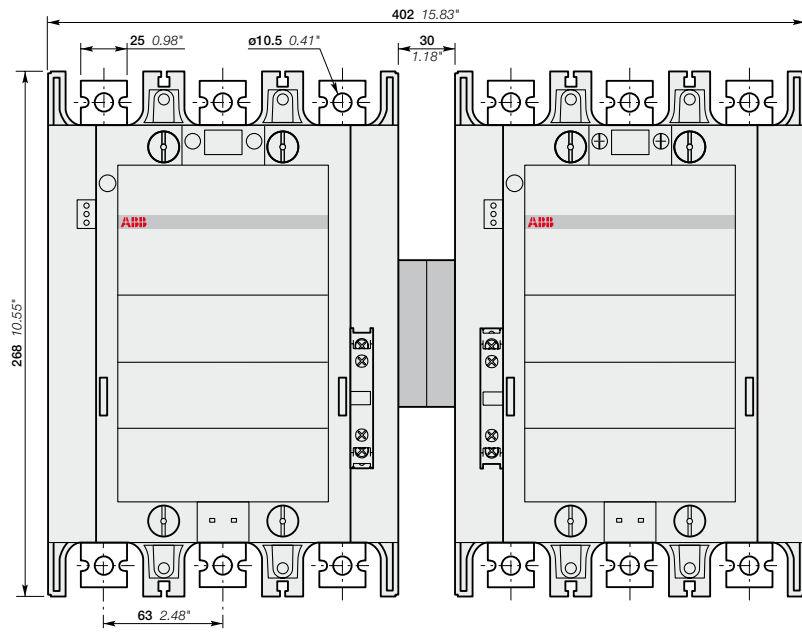

AF400, AF460-30-11  
+ VM750H mechanical interlock unit

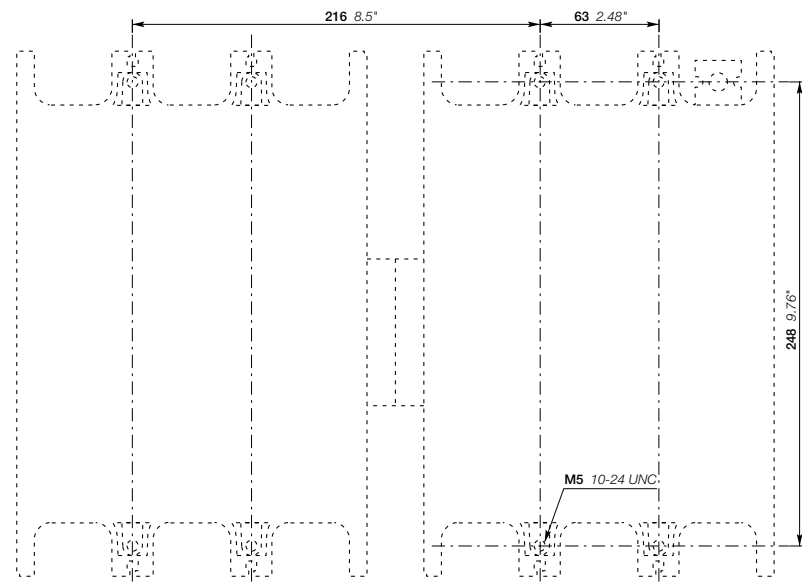

AF400, AF460  
+ VM750H mechanical interlock unit

# AF400 and AF460 3-pole contactors

## Main dimensions mm, inches

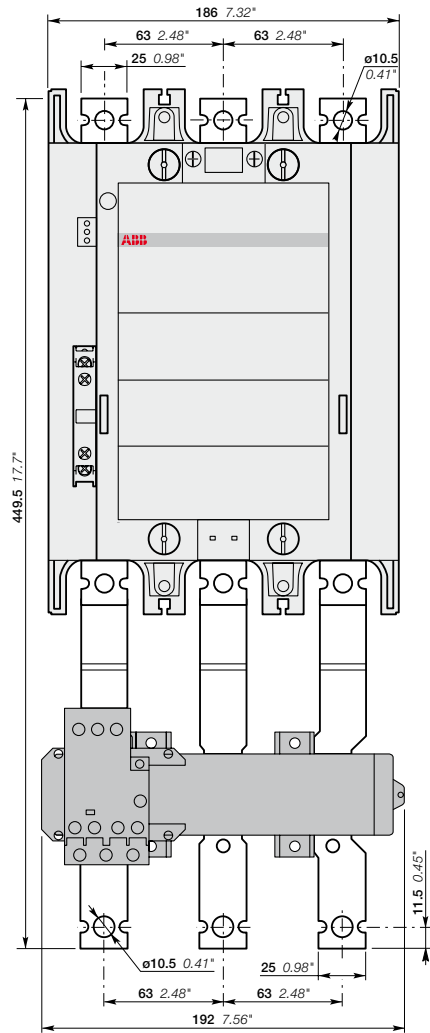

AF400, AF460-30-11  
+ E500DU electronic O/L relay

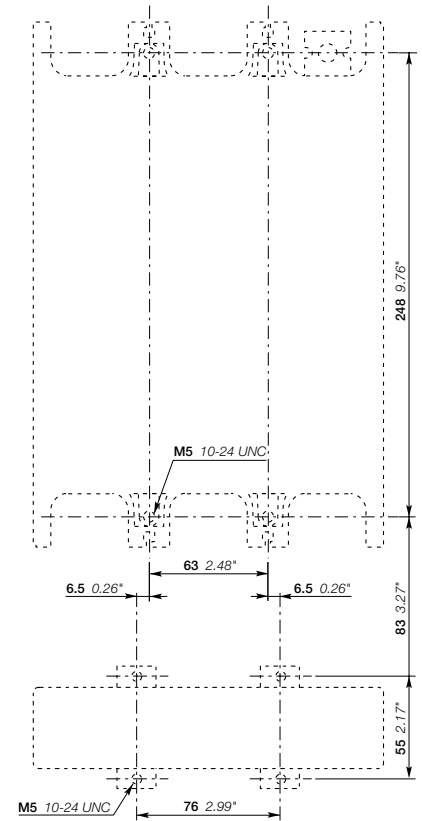
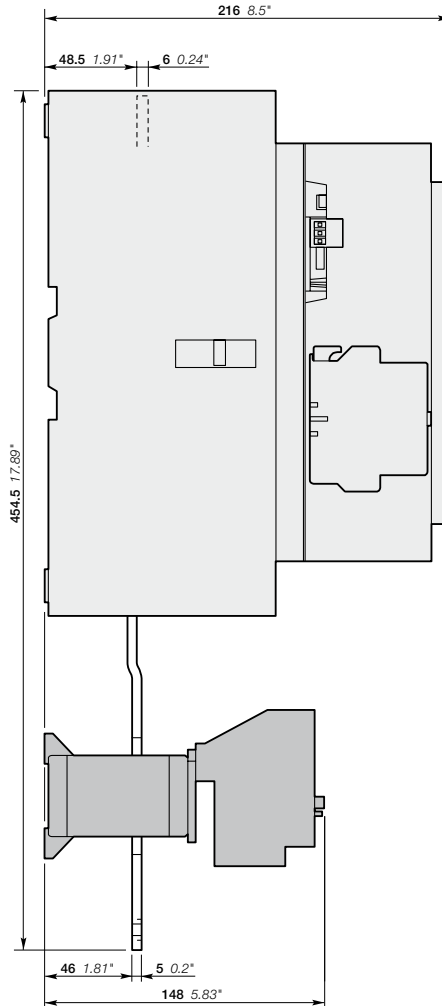

AF400, AF460  
+ E500DU electronic O/L relay

# AF580 and AF750 3-pole contactors

## Main dimensions mm, inches

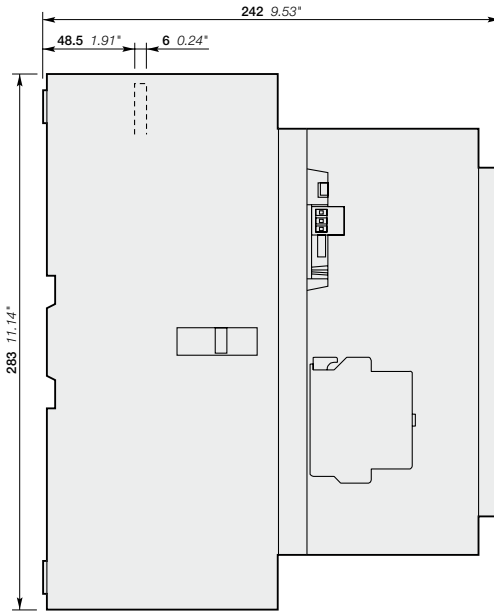
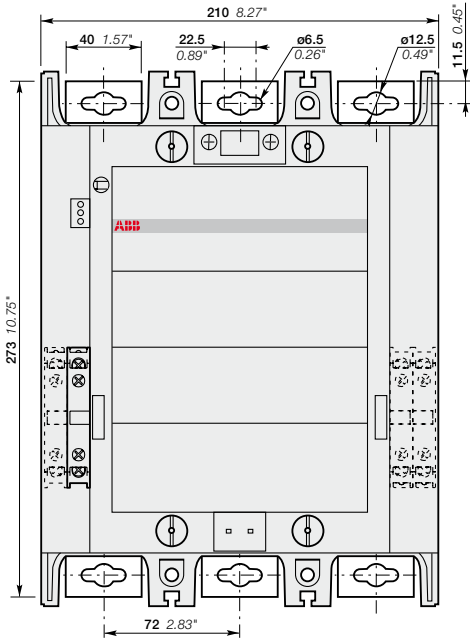

AF580 and AF750-30-11

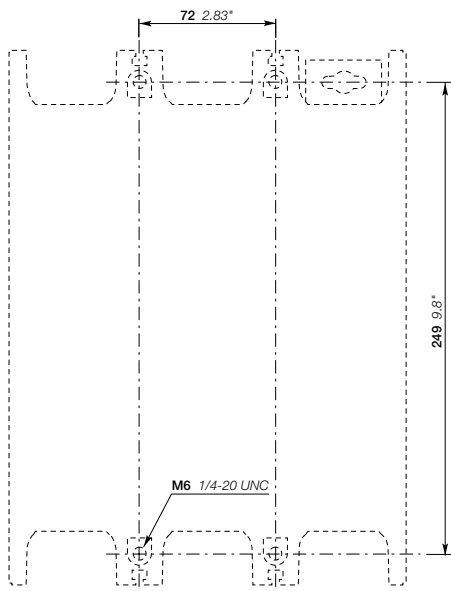

AF580 and AF750



# AF580 and AF750 3-pole contactors

## Main dimensions mm, inches

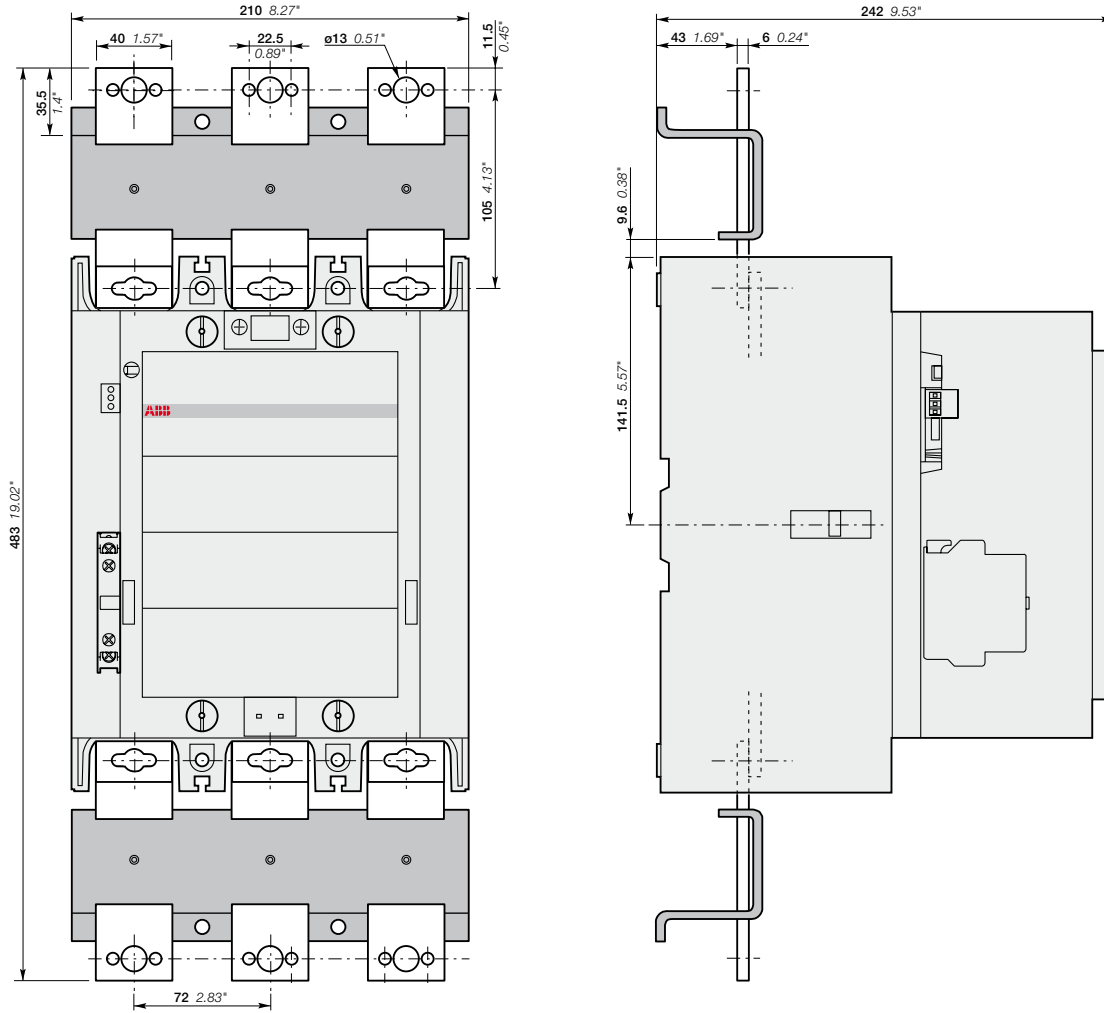

AF580 and AF750-30-11  
+ LX750 terminal extension

# AF580 and AF750 3-pole contactors

## Main dimensions mm, inches

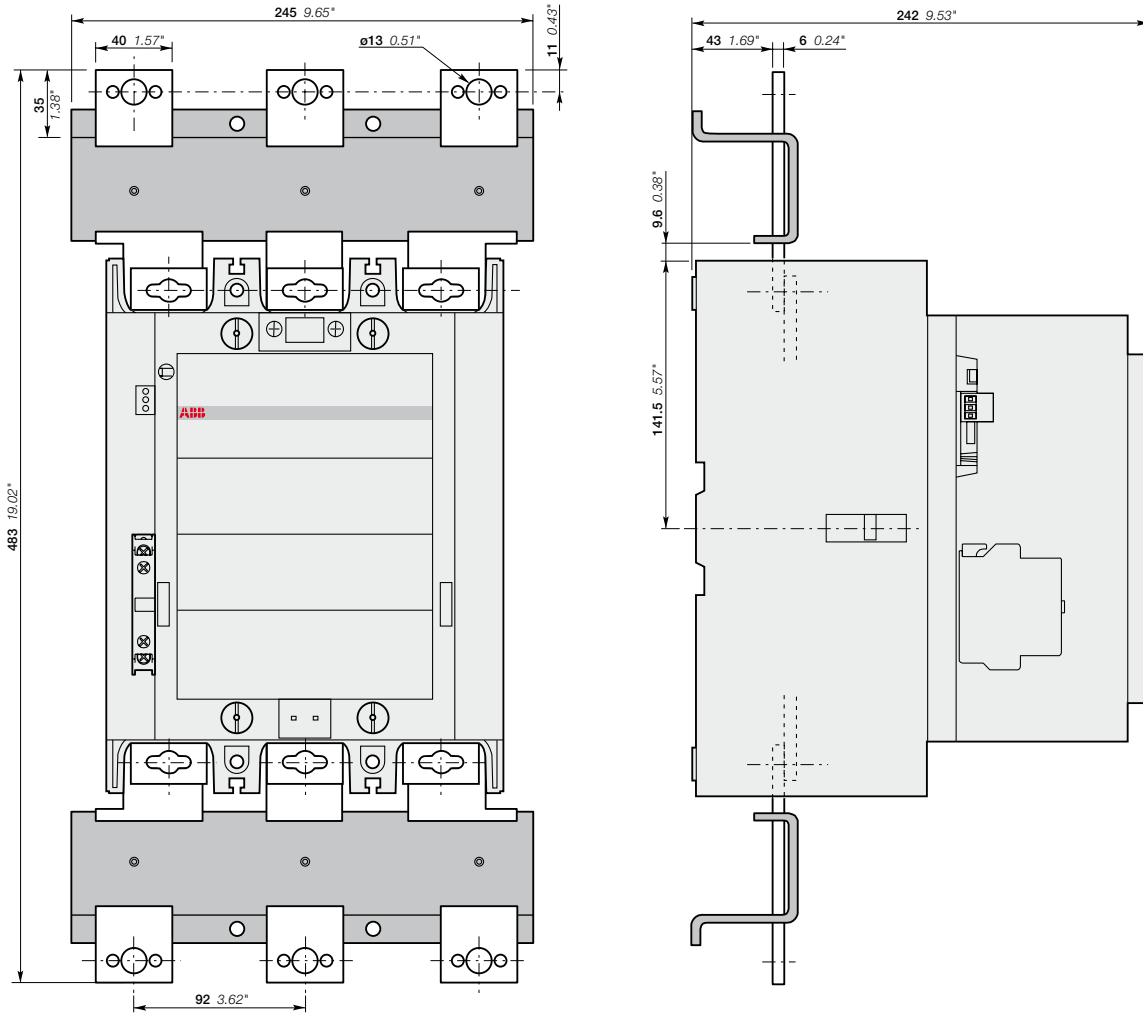

AF580 and AF750-30-11  
+ LW750 terminal enlargement

# AF580 and AF750 3-pole contactors

## Main dimensions mm, inches

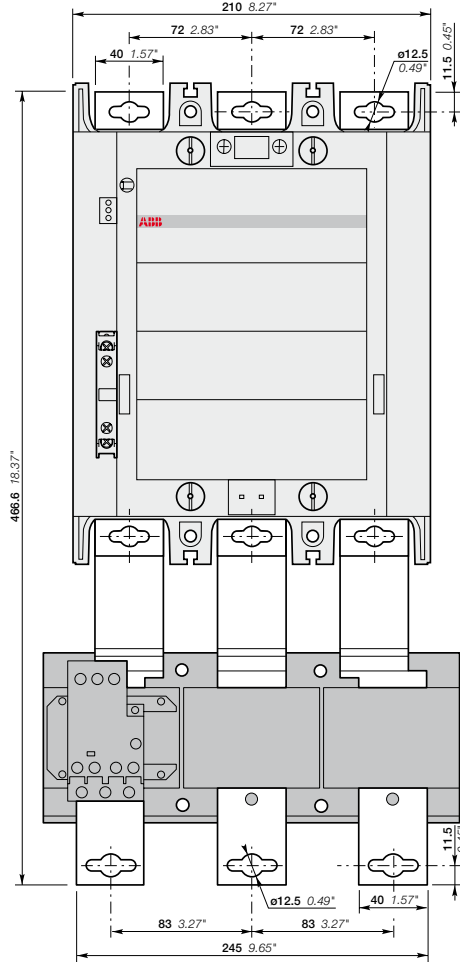

AF580 and AF750-30-11  
+ E800DU electronic O/L relay

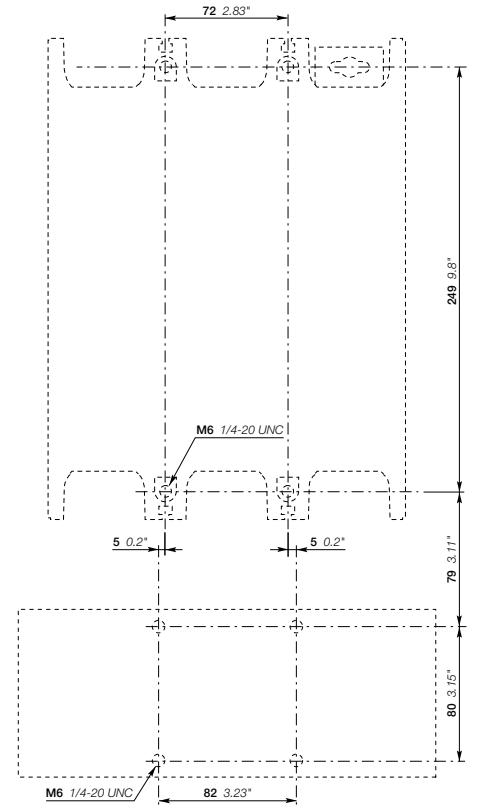
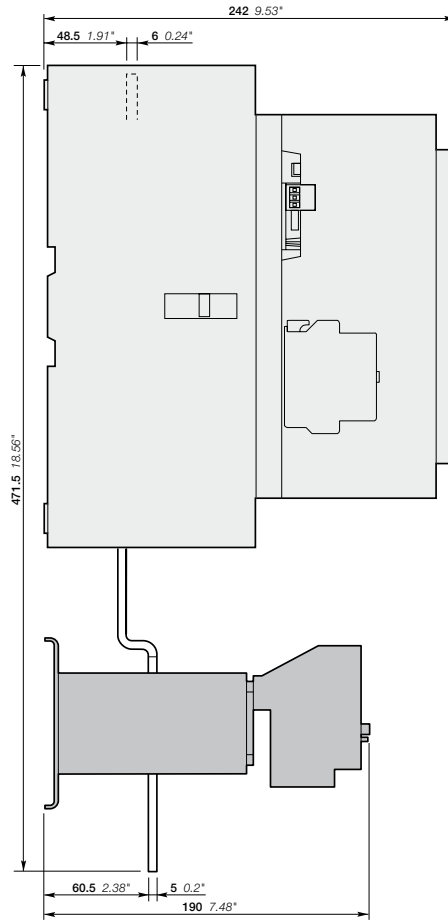

AF580 and AF750  
+ E800DU electronic O/L relay

# AF580 and AF750 3-pole contactors

## Main dimensions mm, inches

5

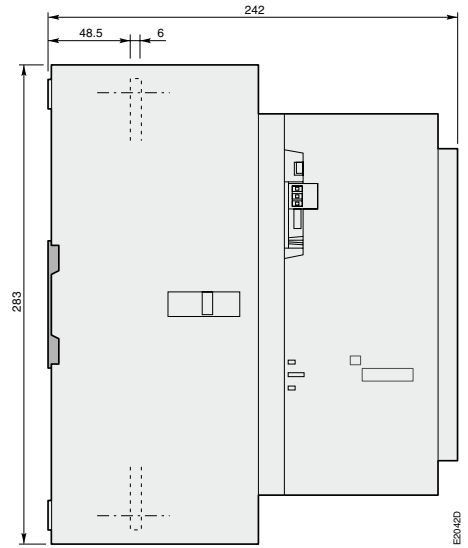
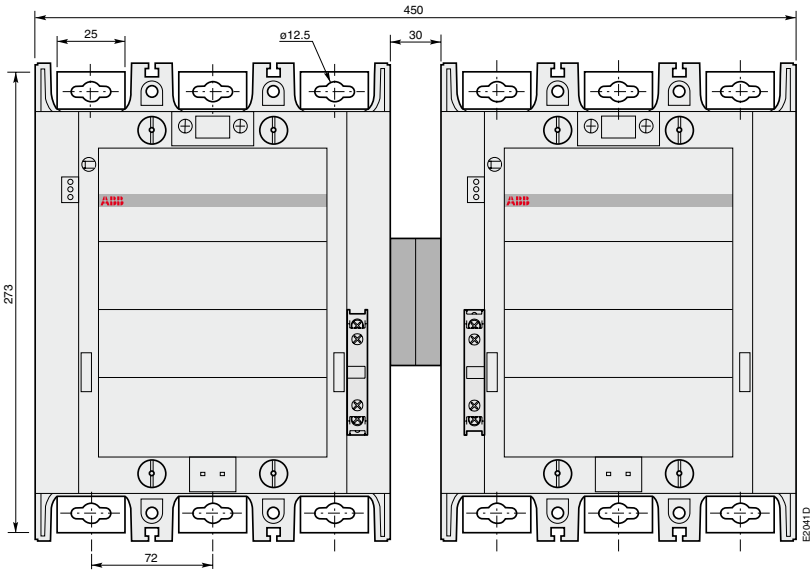

AF580 and AF750-30-11  
+ VM 750H mechanical interlock unit

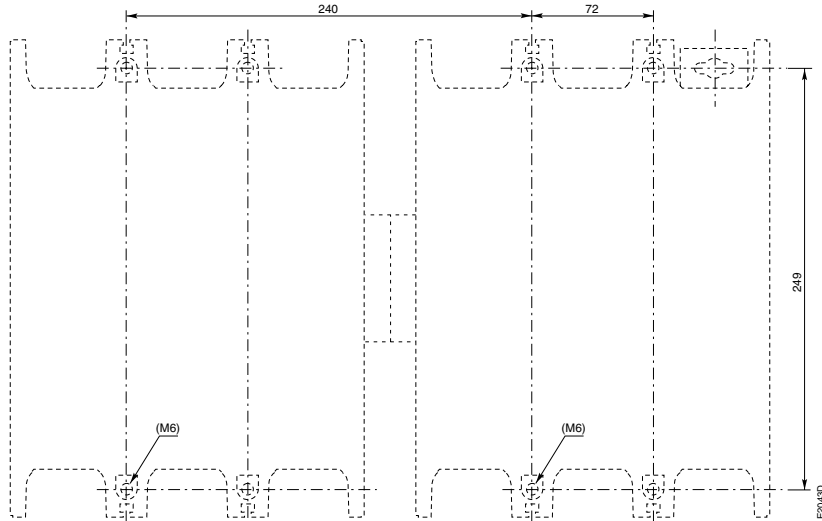

AF580 and AF750  
+ VM 750H mechanical interlock unit

# AF1250 3-pole contactors

## Main dimensions mm, inches

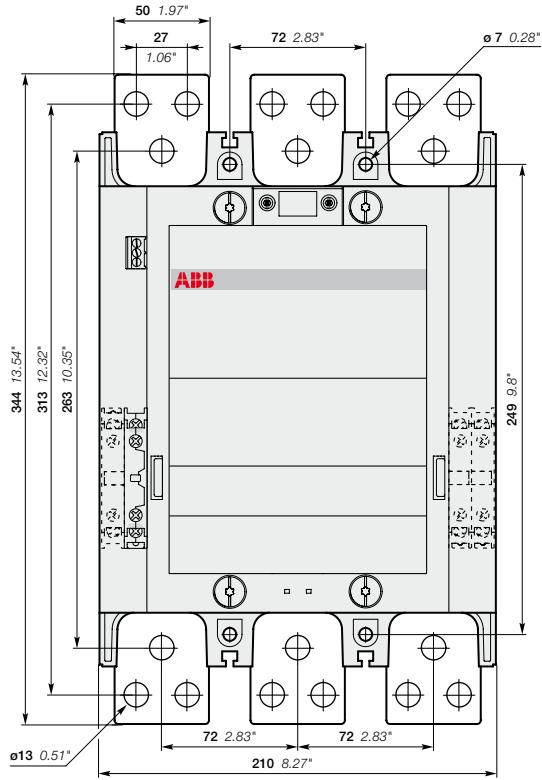

AF1250-30-11

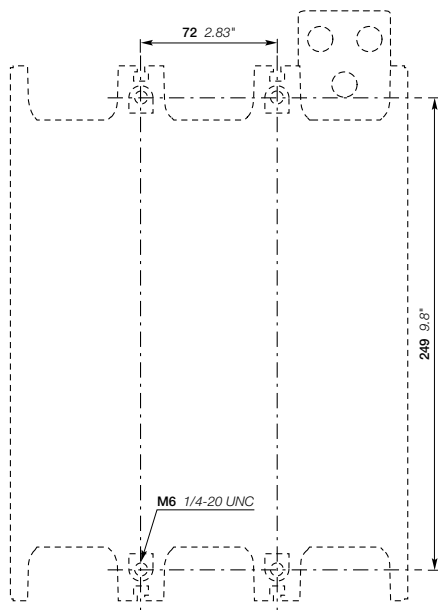
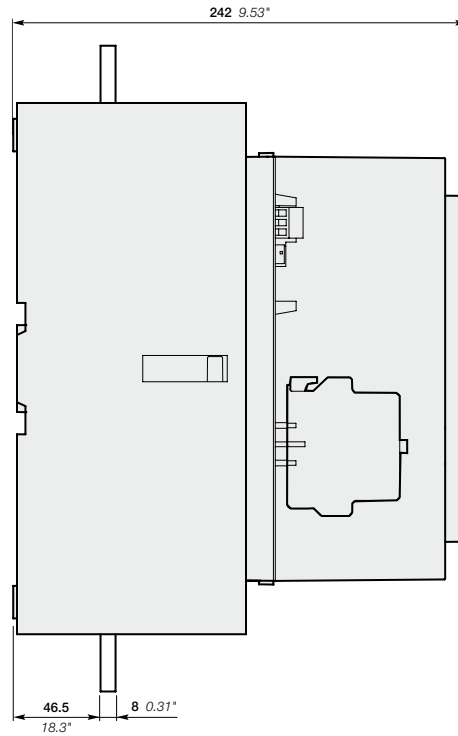

AF1250

# AF1250 3-pole contactors

## Main dimensions mm, inches

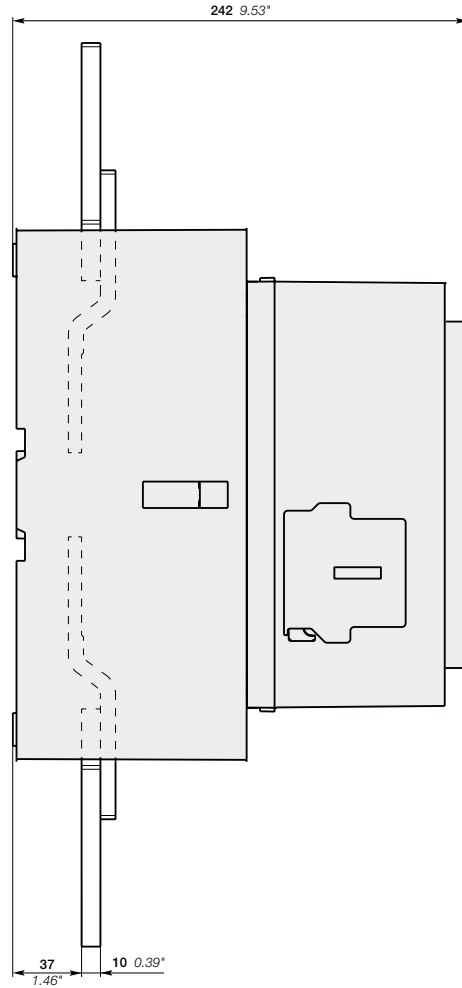
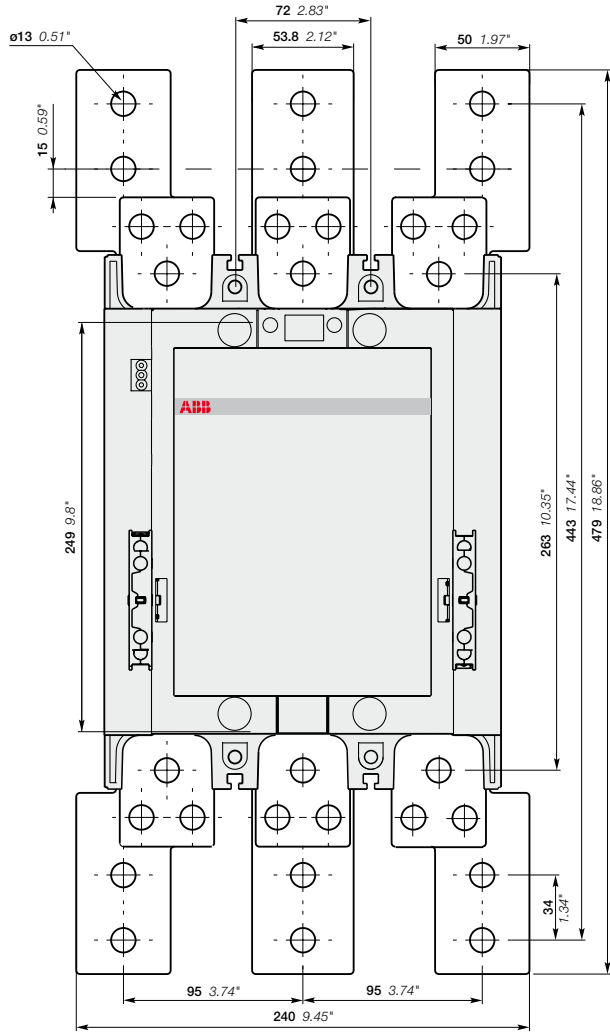

AF1250-30-11  
+ LW1250 terminal enlargement

5

# AF1350, AF1650, AF2050 and AF2650 3-pole contactors

## Main dimensions mm, inches

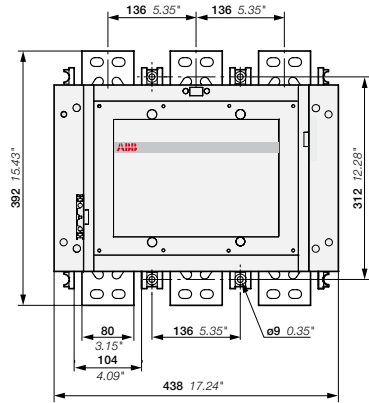
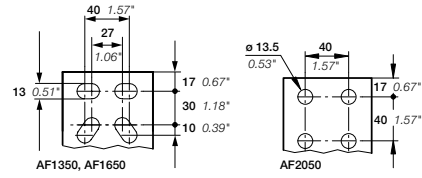

AF1350, AF1650, AF2050-30-11

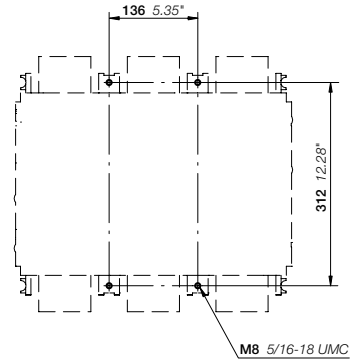
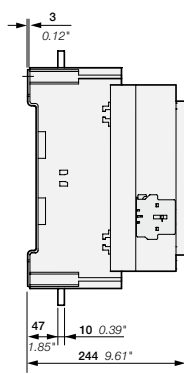

AF1350, AF1650, AF2050

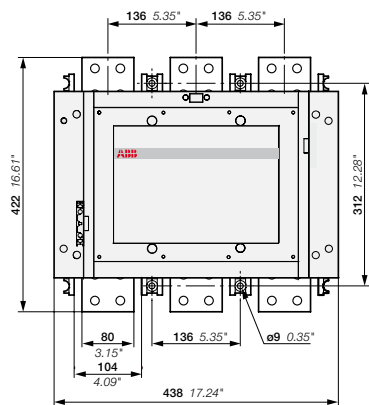
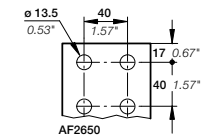

AF2650-30-11

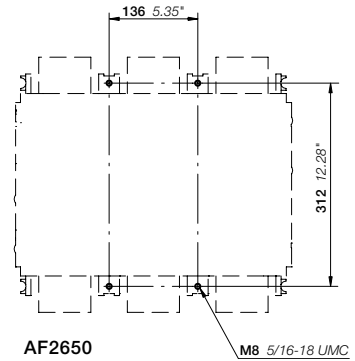
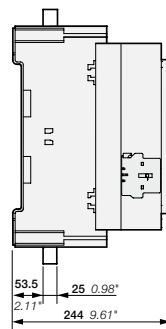

AF2650

# AF1350, AF1650, AF2050 and AF2650 3-pole contactors

## Main dimensions mm, inches

5

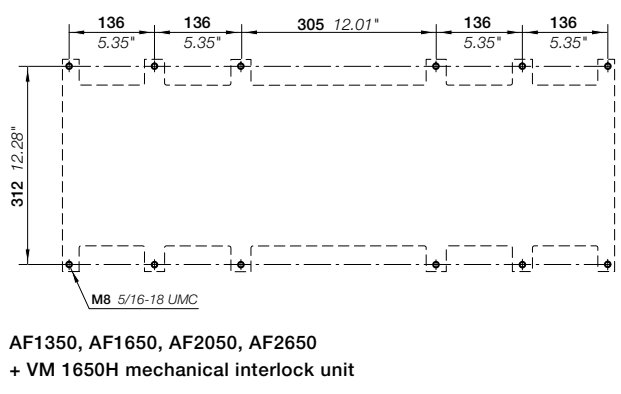
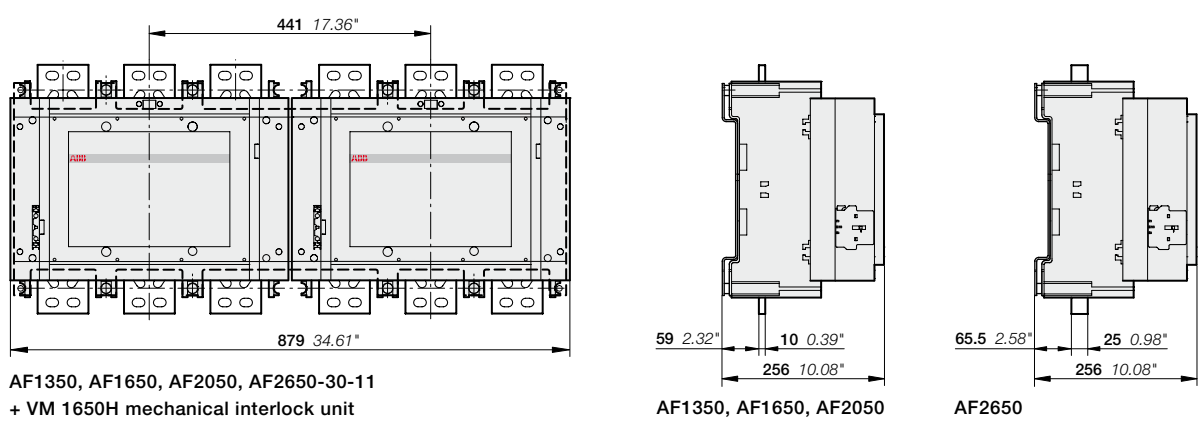
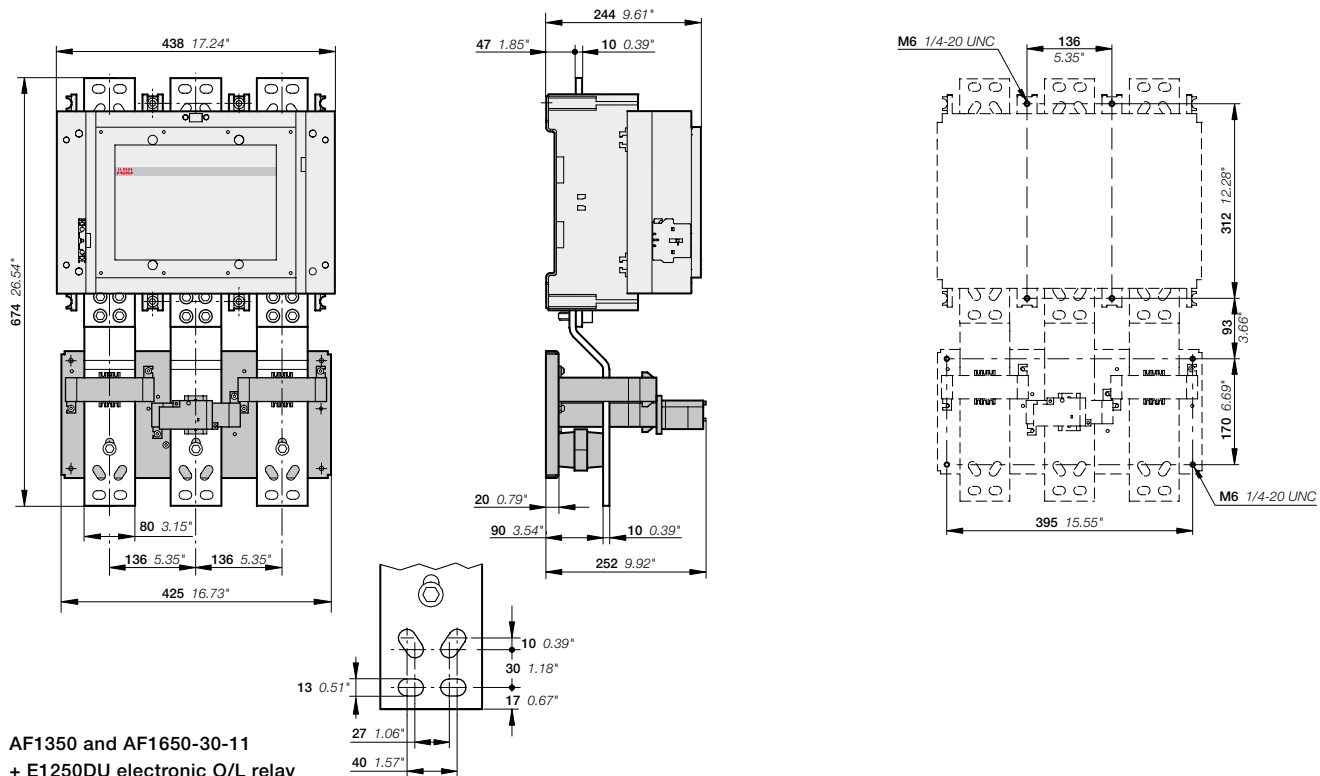



# Notes

A series of horizontal dotted lines for taking notes.



# AF, A and EK 4-pole contactors

[Overview](#) 5/92

---

## Ordering details

### 25 to 55 A AC-1

AF09 ... AF38	AC / DC operated	5/94
AF09Z ... AF38Z	AC / DC operated - low consumption	5/95
Main accessories		5/96

### 70 to 125 A AC-1

A45 ... A75	AC operated	5/99
AE45 ... AE75	DC operated	5/100
AF45 ... AF75	AC / DC operated	5/101
Main accessories		5/102
TAE45 ... TAE75	DC operated - large coil voltage range	5/104
Main accessories		5/106

### 200 to 1000 A AC-1

EK110 ... EK150	AC operated - with 1 N.O. + 1 N.C.	5/108
EK110 ... EK150	DC operated - with 2 N.O. + 1 N.C.	5/109
EK175 ... EK550	AC operated - with 1 N.O. + 1 N.C.	5/110
EK175 ... EK550	DC operated - with 2 N.O. + 1 N.C.	5/111
EK1000	AC operated - with 1 N.O. + 1 N.C.	5/112
EK1000	DC operated - with 2 N.O. + 1 N.C.	5/113
EK110 ... EK150	AC operated - with 2 N.O. + 2 N.C.	5/114
EK175 ... EK550	AC operated - with 2 N.O. + 2 N.C.	5/115
EK1000	AC operated - with 2 N.O. + 2 N.C.	5/116
Main accessories		5/118

[Technical data](#) 5/120

[Electrical durability](#) 5/136

---

[Terminal marking and positioning](#) 5/138

---

[Main dimensions](#) 5/142



---

[Voltage code table](#) 5/267

---

# 4-pole contactors



<b>IEC</b>	<b>AC-1 Rated operational current</b>	$\theta \leq 40\text{ °C}$ , 690 V	<b>A</b>	<b>25</b>	<b>30</b>	<b>45</b>	<b>55</b>	<b>70</b>	<b>100</b>	<b>125</b>
<b>UL/CSA</b>	<b>General use rating</b>	600 V	<b>A</b>	<b>25</b>	<b>30</b>	<b>45</b>	<b>55</b>	<b>80</b>	<b>80</b>	<b>105</b>
<b>AC Control supply</b>		Type		<b>AF09</b>	<b>AF16</b>	<b>AF26</b>	<b>AF38</b>	<b>A45</b>	<b>A50</b>	<b>A75</b>
<b>DC Control supply</b>		Type		<b>AF09</b>	<b>AF16</b>	<b>AF26</b>	<b>AF38</b>	<b>AE45</b>	<b>AE50</b>	<b>AE75</b>
<b>AC / DC Control supply</b>		Type		<b>AF09</b>	<b>AF16</b>	<b>AF26</b>	<b>AF38</b>	<b>AF45</b>	<b>AF50</b>	<b>AF75</b>
<b>IEC</b>	<b>AC-1 Rated operational current</b>	$\theta \leq 40\text{ °C}$	<b>A</b>	<b>25</b>	<b>30</b>	<b>45</b>	<b>55</b>	<b>70</b>	<b>100</b>	<b>125</b>
		$\theta \leq 55\text{ °C}$ (1)	<b>A</b>	<b>25</b>	<b>30</b>	<b>40</b>	<b>45</b>	<b>60</b>	<b>85</b>	<b>105</b>
		$\theta \leq 70\text{ °C}$	<b>A</b>	<b>22</b>	<b>26</b>	<b>32</b>	<b>37</b>	<b>50</b>	<b>70</b>	<b>85</b>
	<b>With conductor cross sectional area</b>		<b>mm<sup>2</sup></b>	<b>4</b>	<b>6</b>	<b>10</b>	<b>16</b>	<b>25</b>	<b>35</b>	<b>50</b>
	<b>Rated operational voltage U<sub>e</sub> max.</b>		<b>V</b>	<b>690</b>	<b>690</b>	<b>690</b>	<b>690</b>	<b>690</b>	<b>690</b>	<b>690</b>
<b>UL/CSA</b>	<b>General use rating</b>	600 V	<b>A</b>	<b>25</b>	<b>30</b>	<b>45</b>	<b>55</b>	<b>65</b>	<b>80</b>	<b>105</b>

(1)  $\theta \leq 60\text{ °C}$  for AF09 ... AF38 contactors

## Main accessories

<b>Auxiliary contact blocks</b>	Front mounting	<b>CA4-10</b> (1 x N.O.), <b>CA4-01</b> (1 x N.C.)	<b>CA5-10</b> (1 x N.O.), <b>CA5-01</b> (1 x N.C.)
	Side mounting	<b>CAL4-11</b> (1 x N.O. + 1 x N.C.)	<b>CAL5-11</b> (1 x N.O. + 1 x N.C.)
<b>Timers</b>	Electronic	<b>TEF4-ON</b> <b>TEF4-OFF</b>	<b>TEF5-ON</b> <b>TEF5-OFF</b>
		<b>VM4</b>	
<b>Interlocking units</b>	Mechanical	<b>VEM4</b>	<b>VE5-2</b>
	Mechanical / Electrical		
<b>Surge suppressors</b>	Varistor (AC / DC)	Built-in surge protection	<b>RV5</b> (24...440 V)
	RC Type (AC)		<b>RC5-2</b> (24...440 V)
	Transil diode (DC)		<b>RT5</b> (12...264 V)



	200	250	300	350	550	800	1000
	170	200	250	300	420	540	—
	EK110	EK150	EK175	EK210	EK370	EK550	EK1000
	EK110	EK150	EK175	EK210	EK370	EK550	EK1000
	—	—	—	—	—	—	—
	200	250	300	350	550	800	1000
	180	230	270	310	470	650	800
	155	200	215	250	400	575	720
	95	150	185	240	2 x 185	2 x 240	2 x 300
	1000	1000	1000	1000	1000	1000	1000
	170	200	250	300	420	540	—

CAL16-11 (1 x N.O. + 1 x N.C.)	
VH145	VH300
RC-EH300	RC-EH800
	VH800

# AF09 ... AF38 4-pole contactors

## 25 to 55 A AC-1

### AC / DC operated



AF09-40-00

1SBC101096FF014

#### Description

AF09 ... AF38 4-pole contactors are mainly used for controlling non-inductive or slightly inductive loads (i.e. resistance furnaces...) and generally for controlling power circuits up to 690 V AC and 440 V DC. These contactors are of the block type design with 4 main poles.

- control circuit: AC or DC operated with electronic coil interface accepting a wide control voltage range (e.g. 100...250 V AC and DC), only 4 control voltage ranges covering 24...500 V 50/60 Hz and 20...500 V DC
- can manage large control voltage variations
- reduced panel energy consumption
- very distinct closing and opening.
- built-in surge suppression
- add-on auxiliary contact blocks for front or side mounting and a wide range of accessories.

#### Ordering details

IEC Rated operational current $\theta \leq 40^\circ\text{C}$ AC-1	UL/CSA General use rating 600 V AC	Rated control circuit voltage Uc min. ... Uc max.		Auxiliary contacts fitted	Type	Order code	Weight Pkg (1 pce) kg
		V 50/60 Hz	V DC				
<b>4 N.O. main poles</b>							
25	25	24...60	-	(1) 0 0	AF09-40-00-41	1SBL137201R4100	0.270
		48...130	48...130	0 0	AF09-40-00-12	1SBL137201R1200	0.270
		100...250	100...250	0 0	AF09-40-00-13	1SBL137201R1300	0.270
		250...500	250...500	0 0	AF09-40-00-14	1SBL137201R1400	0.310
30	30	24...60	-	(1) 0 0	AF16-40-00-41	1SBL177201R4100	0.270
		48...130	48...130	0 0	AF16-40-00-12	1SBL177201R1200	0.270
		100...250	100...250	0 0	AF16-40-00-13	1SBL177201R1300	0.270
		250...500	250...500	0 0	AF16-40-00-14	1SBL177201R1400	0.310
45	45	24...60	-	(1) 0 0	AF26-40-00-41	1SBL237201R4100	0.360
		48...130	48...130	0 0	AF26-40-00-12	1SBL237201R1200	0.360
		100...250	100...250	0 0	AF26-40-00-13	1SBL237201R1300	0.360
		250...500	250...500	0 0	AF26-40-00-14	1SBL237201R1400	0.400
55	55	24...60	-	(1) 0 0	AF38-40-00-41	1SBL297201R4100	0.360
		48...130	48...130	0 0	AF38-40-00-12	1SBL297201R1200	0.360
		100...250	100...250	0 0	AF38-40-00-13	1SBL297201R1300	0.360
		250...500	250...500	0 0	AF38-40-00-14	1SBL297201R1400	0.400
<b>2 N.O. + 2 N.C. main poles</b>							
25	25	24...60	-	(1) 0 0	AF09-22-00-41	1SBL137501R4100	0.270
		48...130	48...130	0 0	AF09-22-00-12	1SBL137501R1200	0.270
		100...250	100...250	0 0	AF09-22-00-13	1SBL137501R1300	0.270
		250...500	250...500	0 0	AF09-22-00-14	1SBL137501R1400	0.310
30	30	24...60	-	(1) 0 0	AF16-22-00-41	1SBL177501R4100	0.270
		48...130	48...130	0 0	AF16-22-00-12	1SBL177501R1200	0.270
		100...250	100...250	0 0	AF16-22-00-13	1SBL177501R1300	0.270
		250...500	250...500	0 0	AF16-22-00-14	1SBL177501R1400	0.310
45	45	24...60	-	(1) 0 0	AF26-22-00-41	1SBL237501R4100	0.360
		48...130	48...130	0 0	AF26-22-00-12	1SBL237501R1200	0.360
		100...250	100...250	0 0	AF26-22-00-13	1SBL237501R1300	0.360
		250...500	250...500	0 0	AF26-22-00-14	1SBL237501R1400	0.400
55	55	24...60	-	(1) 0 0	AF38-22-00-41	1SBL297501R4100	0.360
		48...130	48...130	0 0	AF38-22-00-12	1SBL297501R1200	0.360
		100...250	100...250	0 0	AF38-22-00-13	1SBL297501R1300	0.360
		250...500	250...500	0 0	AF38-22-00-14	1SBL297501R1400	0.400

(1) For 24...60 V 50/60 Hz - 20...60 V DC, use AF...-...-11 (see voltage code table).  
AF...-...-11 not suitable for direct control by PLC-output.

#### Main dimensions mm, inches

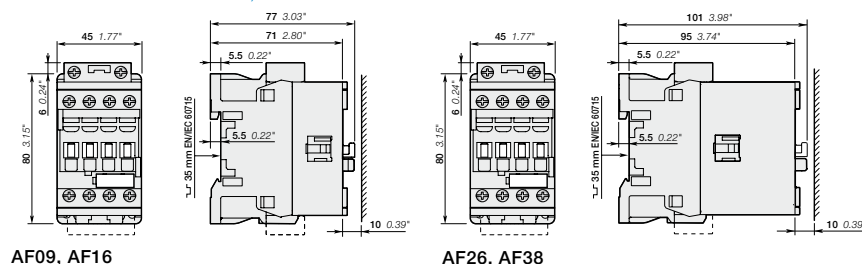

AF09, AF16

AF26, AF38

# AF09Z ... AF38Z 4-pole contactors

## 25 to 55 A AC-1

### AC / DC operated - low consumption



AF09Z-40-00





AF26Z-40-00

#### Description

AF09Z ... AF38Z 4-pole contactors are mainly used for controlling non-inductive or slightly inductive loads (i.e. resistance furnaces...) and generally for controlling power circuits up to 690 V AC and 440 V DC. These contactors are of the block type design with 4 main poles.

- control circuit: AC or DC operated with electronic coil interface accepting a wide control voltage range (e.g. 100...250 V AC and DC), only 4 control voltage ranges covering 24...250 V 50/60 Hz and 12...250 V DC
- can manage large control voltage variations
- allow direct control by PLC-output  $\geq 24$  V DC 500 mA
- reduced panel energy consumption
- very distinct closing and opening
- can withstand short voltage dips and voltage sags (SEMI F47-0706 conditions of use on request).
- built-in surge suppression
- add-on auxiliary contact blocks for front or side mounting and a wide range of accessories.

#### Ordering details

IEC	UL/CSA	Rated control circuit voltage		Auxiliary contacts fitted	Type	Order code	Weight
Rated operational current $\theta \leq 40^\circ\text{C}$ AC-1	General use rating 600 V AC	Uc min. ...	Uc max.				Pkg (1 pce)
A	A	V 50/60 Hz	V DC	 			kg

#### 4 N.O. main poles

Rated current (A)	General use rating (A)	Uc min. (V 50/60 Hz)	Uc max. (V DC)	NO	NC	Type	Order code	Weight (kg)
25	25	-	12...20	0	0	AF09Z-40-00-20	1SBL136201R2000	0.310
		24...60	20...60	0	0	AF09Z-40-00-21	1SBL136201R2100	0.310
		48...130	48...130	0	0	AF09Z-40-00-22	1SBL136201R2200	0.310
		100...250	100...250	0	0	AF09Z-40-00-23	1SBL136201R2300	0.310
30	30	-	12...20	0	0	AF16Z-40-00-20	1SBL176201R2000	0.310
		24...60	20...60	0	0	AF16Z-40-00-21	1SBL176201R2100	0.310
		48...130	48...130	0	0	AF16Z-40-00-22	1SBL176201R2200	0.310
		100...250	100...250	0	0	AF16Z-40-00-23	1SBL176201R2300	0.310
45	45	-	12...20	0	0	AF26Z-40-00-20	1SBL236201R2000	0.400
		24...60	20...60	0	0	AF26Z-40-00-21	1SBL236201R2100	0.400
		48...130	48...130	0	0	AF26Z-40-00-22	1SBL236201R2200	0.400
		100...250	100...250	0	0	AF26Z-40-00-23	1SBL236201R2300	0.400
55	55	-	12...20	0	0	AF38Z-40-00-20	1SBL296201R2000	0.400
		24...60	20...60	0	0	AF38Z-40-00-21	1SBL296201R2100	0.400
		48...130	48...130	0	0	AF38Z-40-00-22	1SBL296201R2200	0.400
		100...250	100...250	0	0	AF38Z-40-00-23	1SBL296201R2300	0.400

#### 2 N.O. + 2 N.C. main poles

Rated current (A)	General use rating (A)	Uc min. (V 50/60 Hz)	Uc max. (V DC)	NO	NC	Type	Order code	Weight (kg)
25	25	-	12...20	0	0	AF09Z-22-00-20	1SBL136501R2000	0.310
		24...60	20...60	0	0	AF09Z-22-00-21	1SBL136501R2100	0.310
		48...130	48...130	0	0	AF09Z-22-00-22	1SBL136501R2200	0.310
		100...250	100...250	0	0	AF09Z-22-00-23	1SBL136501R2300	0.310
30	30	-	12...20	0	0	AF16Z-22-00-20	1SBL176501R2000	0.310
		24...60	20...60	0	0	AF16Z-22-00-21	1SBL176501R2100	0.310
		48...130	48...130	0	0	AF16Z-22-00-22	1SBL176501R2200	0.310
		100...250	100...250	0	0	AF16Z-22-00-23	1SBL176501R2300	0.310
45	45	-	12...20	0	0	AF26Z-22-00-20	1SBL236501R2000	0.400
		24...60	20...60	0	0	AF26Z-22-00-21	1SBL236501R2100	0.400
		48...130	48...130	0	0	AF26Z-22-00-22	1SBL236501R2200	0.400
		100...250	100...250	0	0	AF26Z-22-00-23	1SBL236501R2300	0.400
55	55	-	12...20	0	0	AF38Z-22-00-20	1SBL296501R2000	0.400
		24...60	20...60	0	0	AF38Z-22-00-21	1SBL296501R2100	0.400
		48...130	48...130	0	0	AF38Z-22-00-22	1SBL296501R2200	0.400
		100...250	100...250	0	0	AF38Z-22-00-23	1SBL296501R2300	0.400

Note: Only AF.Z contactors with DC control voltage 12...20 V DC need to respect the connection polarities indicated close to the coil terminals: A1+ for the positive pole and A2- for the negative pole.

#### Main dimensions mm, inches

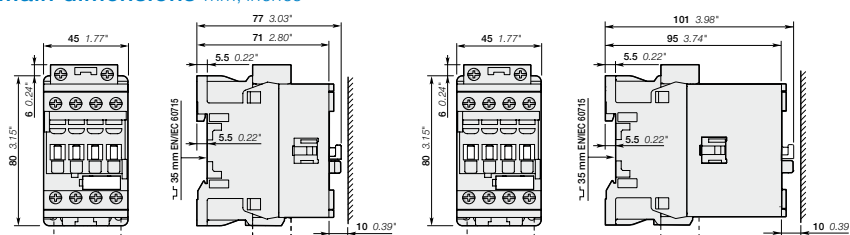

AF09Z, AF16Z

AF26Z, AF38Z

# AF09 ... AF38 4-pole contactors

## Main accessories

### Contactor and main accessories (other accessories available)

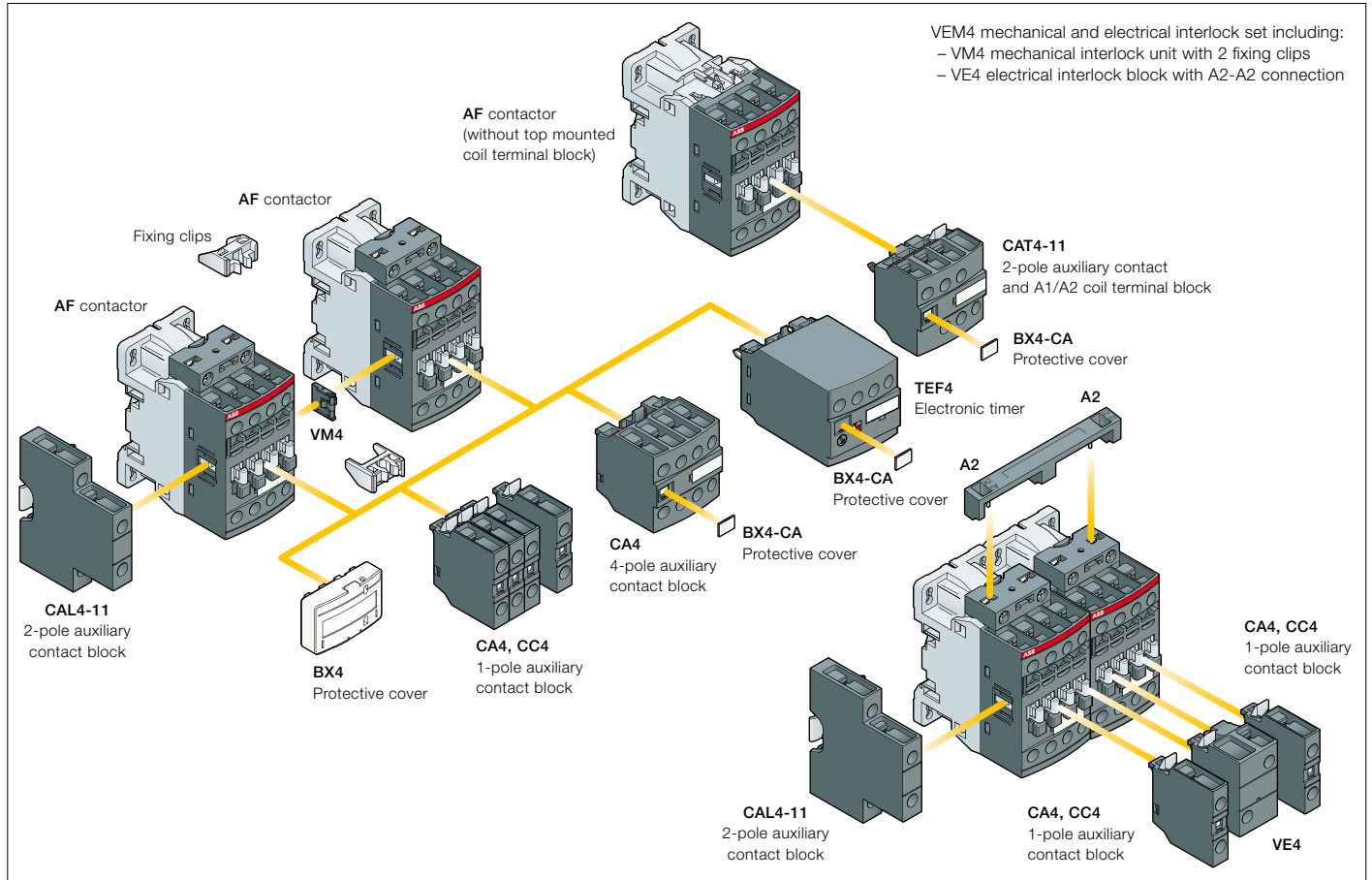

### Main accessory fitting details

Many configurations of accessories are possible depending on whether these are front-mounted or side-mounted.

Contactor types	Main poles	Built-in auxiliary contacts	Front-mounted accessories				Electronic timer	Electrical and mechanical interlock set (between 2 contactors)	Side-mounted accessories	
			Auxiliary contact blocks			TEF4			VEM4	Left side
			1-pole CA4 1-pole CC4	2-pole CAT4-11	4-pole CA4			2-pole CAL4-11		
Max. add-on N.C. auxiliary contacts: 4 N.C. max. on positions 1, 2, 3, 4 and 3 N.C. max. on positions 1 ±30°, 5										
AF09 ... AF16	4	0	0	0	4 max. or 1	or 1	or 1	-	+ 1	-
					2 max. or 1	-	or 1	-	+ 1	+ 1
					3 max. -	-	-	+ 1	+ 1	or 1
Max. add-on N.C. auxiliary contacts: 3 N.C. max. on positions 1, 2, 3, 4 and 2 N.C. max. on positions 1 ±30°, 5										
AF26 ... AF38	4	0	0	0	4 max. or 1	or 1	or 1	-	+ 1	-
					2 max. or 1	-	or 1	-	+ 1	+ 1
					3 max. -	-	-	+ 1	+ 1	or 1
AF09 ... AF16	2	2	0	0	4 max. or 1	or 1	or 1	-	+ 1	-
AF26 ... AF38	2	2	0	0	2 max. or 1	-	or 1	-	+ 1	+ 1



# AF09 ... AF38 4-pole contactors

## Main accessories



CA4-10



CAL4-11



CA4-22E



CAT4-11E



VEM4

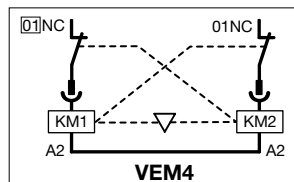

TEF4-ON

### Ordering details (1)

For contactors	Auxiliary contacts	Type	Order code	Pkg qty	Weight (1 pce)
					kg

#### Front-mounted instantaneous auxiliary contact blocks

AF09 ... AF38...-40-00	1 0	- -	CA4-10	1SBN010110R1010	1	0.014
AF09 ... AF38...-22-00	1 0	- -	CA4-10-T	1SBN010110T1010	10	0.014
	0 1	- -	CA4-01	1SBN010110R1001	1	0.014
	0 1	- -	CA4-01-T	1SBN010110T1001	10	0.014
	2 2	- -	CA4-22E	1SBN010140R1022	1	0.055
	3 1	- -	CA4-31E	1SBN010140R1031	1	0.055
	4 0	- -	CA4-40E	1SBN010140R1040	1	0.055
AF09 ... AF16...-40-00	0 4	- -	CA4-04E	1SBN010140R1004	1	0.055

#### Front-mounted auxiliary contact blocks with N.O. leading contact and N.C. lagging contact

AF09 ... AF38...-40-00	- -	1 0	CC4-10	1SBN010111R1010	1	0.014
AF09 ... AF38...-22-00	- -	0 1	CC4-01	1SBN010111R1001	1	0.014

#### Side-mounted instantaneous auxiliary contact blocks

AF09 ... AF38...-40-00	1 1	- -	CAL4-11	1SBN010120R1011	1	0.040
AF09 ... AF38...-22-00	1 1	- -	CAL4-11-T	1SBN010120T1011	10	0.040

#### Front-mounted instantaneous auxiliary contact and A1/A2 coil terminal blocks

AF09 ... AF38...-40-00	1 1	- -	CAT4-11E	1SBN010151R1011	1	0.040
AF09 ... AF38...-22-00						

Note: CAT4 not suitable for AF..Z contactors with DC control voltage 12...20 V DC.

#### Mechanical interlock unit

AF09 ... AF38...-40-00			VM4	1SBN030105T1000	10	0.005
------------------------	--	--	-----	-----------------	----	-------

Note: VM4 includes 2 fixing clips (BB4) to maintain together both contactors.

#### Mechanical and electrical interlock set

AF09, AF16...-40-00	0 2	- -	VEM4	1SBN030111R1000	1	0.035
AF26, AF38...-40-00						

Note: - VEM4 includes a VM4 mechanical interlock unit with 2 fixing clips (BB4), a VE4 electrical interlock block. VE4 block must be used with A2-A2 connection to respect the electrical connection diagram.  
- VEM4 not suitable for AF..Z contactors with DC control voltage 12...20 V DC.

For contactors	Time delay range selected by switch	Delay type	Auxiliary contacts	Type	Order code	Pkg qty	Weight (1 pce)
							kg

#### Electronic timers

AF09 ... AF38	0.1...1 s	ON-delay	1 1	TEF4-ON	1SBN020112R1000	1	0.065
	1...10 s						
	10...100 s	OFF-delay	1 1	TEF4-OFF	1SBN020114R1000	1	0.065

Note: Rated control circuit voltage U<sub>c</sub> 24...240 V 50/60 Hz or DC.

(1) For more information, refer to "Accessories" section.

# Notes

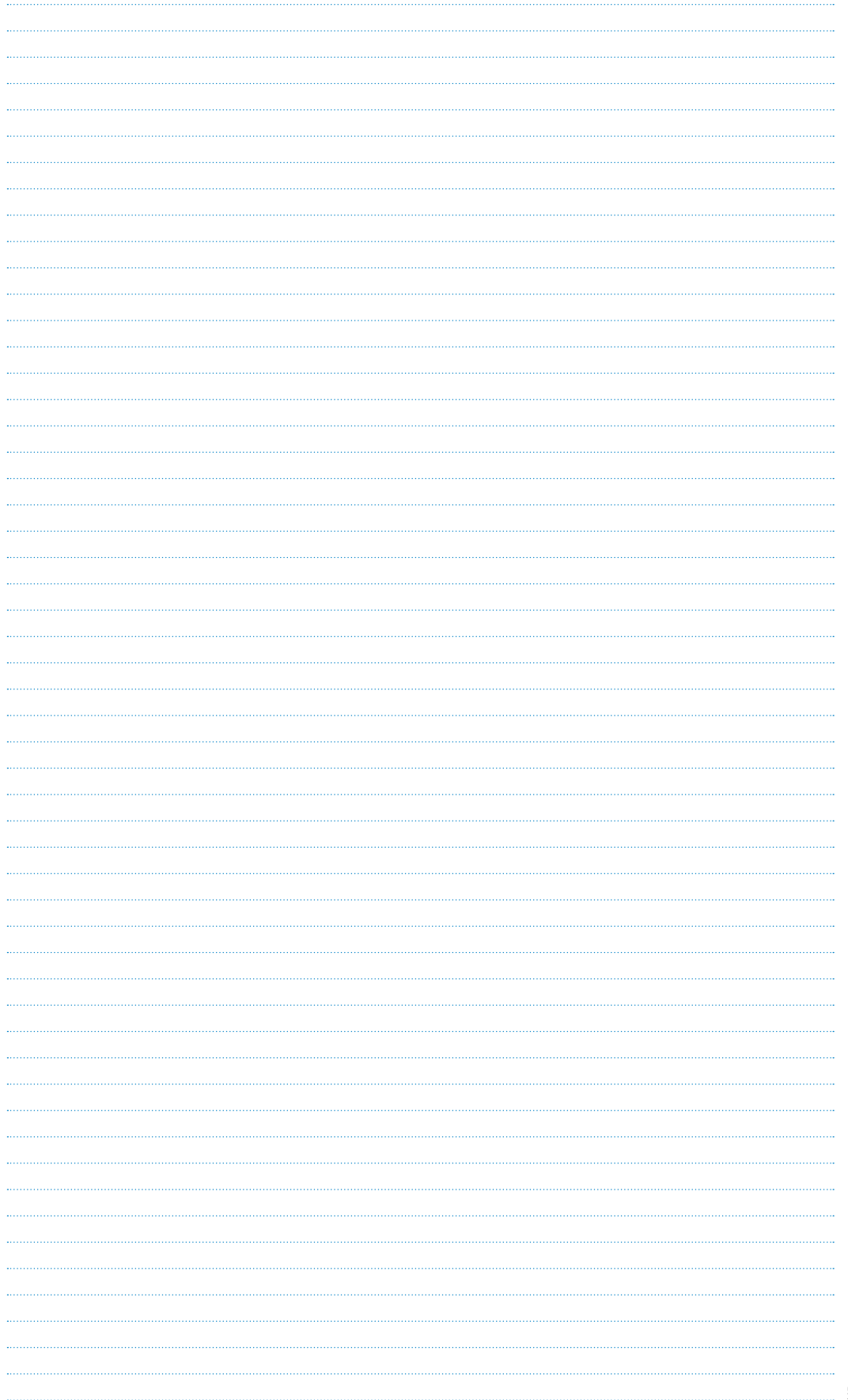
A large area of horizontal dotted lines for writing notes, spanning most of the page width and height.

# A45 ... A75 4-pole contactors

## 70 to 125 A AC-1

### AC operated



A45-40-00

#### Description

A45 ... A75 4-pole contactors are mainly used for controlling non-inductive or slightly inductive loads (i.e. resistance furnaces...) and generally for controlling power circuits up to 690 V AC and 220 V DC.

These contactors are of the block type design with:

- 4 main poles
- control circuit: AC operated
- add-on auxiliary contact blocks for front or side mounting and a wide range of accessories.

#### Ordering details

IEC	UL/CSA	Rated control circuit voltage $U_c$		Auxiliary contacts fitted	Type	Order code	Weight
Rated operational current $\theta \leq 40^\circ\text{C}$ AC-1	General use rating 600 V AC	V 50 Hz	V 60 Hz				Pkg (1 pce) kg

#### 4 N.O. main poles

Rated operational current	General use rating	V 50 Hz	V 60 Hz	Auxiliary contacts fitted	Type	Order code	Weight
70	80	24	24	0 0	A45-40-00	1SBL331201R8100	1.390
		48	48	0 0	A45-40-00	1SBL331201R8300	1.390
		110	110...120	0 0	A45-40-00	1SBL331201R8400	1.390
		220...230	230...240	0 0	A45-40-00	1SBL331201R8000	1.390
		230...240	240...260	0 0	A45-40-00	1SBL331201R8800	1.390
		380...400	400...415	0 0	A45-40-00	1SBL331201R8500	1.390
		400...415	415...440	0 0	A45-40-00	1SBL331201R8600	1.390
100	80	24	24	0 0	A50-40-00	1SBL351201R8100	1.390
		48	48	0 0	A50-40-00	1SBL351201R8300	1.390
		110	110...120	0 0	A50-40-00	1SBL351201R8400	1.390
		220...230	230...240	0 0	A50-40-00	1SBL351201R8000	1.390
		230...240	240...260	0 0	A50-40-00	1SBL351201R8800	1.390
		380...400	400...415	0 0	A50-40-00	1SBL351201R8500	1.390
		400...415	415...440	0 0	A50-40-00	1SBL351201R8600	1.390
125	105	24	24	0 0	A75-40-00	1SBL411201R8100	1.390
		48	48	0 0	A75-40-00	1SBL411201R8300	1.390
		110	110...120	0 0	A75-40-00	1SBL411201R8400	1.390
		220...230	230...240	0 0	A75-40-00	1SBL411201R8000	1.390
		230...240	240...260	0 0	A75-40-00	1SBL411201R8800	1.390
		380...400	400...415	0 0	A75-40-00	1SBL411201R8500	1.390
		400...415	415...440	0 0	A75-40-00	1SBL411201R8600	1.390

#### 2 N.O. + 2 N.C. main poles (2)

Rated operational current	General use rating	V 50 Hz	V 60 Hz	Auxiliary contacts fitted	Type	Order code	Weight
70	80	24	24	0 0	A45-22-00	1SBL331501R8100	1.400
		48	48	0 0	A45-22-00	1SBL331501R8300	1.400
		110	110...120	0 0	A45-22-00	1SBL331501R8400	1.400
		220...230	230...240	0 0	A45-22-00	1SBL331501R8000	1.400
		230...240	240...260	0 0	A45-22-00	1SBL331501R8800	1.400
		380...400	400...415	0 0	A45-22-00	1SBL331501R8500	1.400
		400...415	415...440	0 0	A45-22-00	1SBL331501R8600	1.400
125	105	24	24	0 0	A75-22-00	1SBL411501R8100	1.400
		48	48	0 0	A75-22-00	1SBL411501R8300	1.400
		110	110...120	0 0	A75-22-00	1SBL411501R8400	1.400
		220...230	230...240	0 0	A75-22-00	1SBL411501R8000	1.400
		230...240	240...260	0 0	A75-22-00	1SBL411501R8800	1.400
		380...400	400...415	0 0	A75-22-00	1SBL411501R8500	1.400
		400...415	415...440	0 0	A75-22-00	1SBL411501R8600	1.400

(1) Other control voltages see voltage code table.

(2) These contactors are not suitable for a reversing starter or star-delta starter or for controlling a single load from 2 separate supplies. Please see technical data.

#### Main dimensions mm, inches

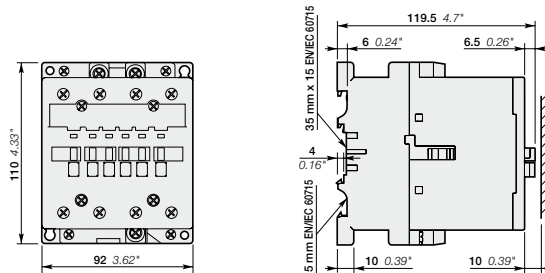

A45, A50, A75 4-pole

1SBC101377S0201

# AE45 ... AE75 4-pole contactors

## 70 to 125 A AC-1

### DC operated



AE50-40-00

1SBC3519 1RFO003

#### Description

AE45 ... AE75 4-pole contactors are mainly used for controlling non-inductive or slightly inductive loads (i.e. resistance furnaces...) and generally for controlling power circuits up to 690 V AC and 220 V DC.

These contactors are of the block type design with:

- 4 main poles
- control circuit: DC operated with double winding coil (and factory-mounted lagging contact for "holding" winding insertion)
- add-on auxiliary contact blocks for front or side mounting and a wide range of accessories.

#### Ordering details

IEC	UL/CSA	Rated control circuit voltage Uc (1)	Auxiliary contacts fitted	Type	Order code	Weight
Rated operational current $\theta \leq 40^\circ\text{C}$ AC-1	General use rating 600 V AC					Pkg (1 pce)
A	A	V DC				kg
<b>4 N.O. main poles</b>						
70	80	12	0 0	AE45-40-00	1SBL339201R8000	1.430
		24	0 0	AE45-40-00	1SBL339201R8100	1.430
		48	0 0	AE45-40-00	1SBL339201R8300	1.430
		60	0 0	AE45-40-00	1SBL339201R8400	1.430
		110	0 0	AE45-40-00	1SBL339201R8600	1.430
		125	0 0	AE45-40-00	1SBL339201R8700	1.430
		220	0 0	AE45-40-00	1SBL339201R8800	1.430
		240	0 0	AE45-40-00	1SBL339201R8900	1.430
100	80	12	0 0	AE50-40-00	1SBL359201R8000	1.430
		24	0 0	AE50-40-00	1SBL359201R8100	1.430
		48	0 0	AE50-40-00	1SBL359201R8300	1.430
		60	0 0	AE50-40-00	1SBL359201R8400	1.430
		110	0 0	AE50-40-00	1SBL359201R8600	1.430
		125	0 0	AE50-40-00	1SBL359201R8700	1.430
		220	0 0	AE50-40-00	1SBL359201R8800	1.430
		240	0 0	AE50-40-00	1SBL359201R8900	1.430
125	105	12	0 0	AE75-40-00	1SBL419201R8000	1.430
		24	0 0	AE75-40-00	1SBL419201R8100	1.430
		48	0 0	AE75-40-00	1SBL419201R8300	1.430
		60	0 0	AE75-40-00	1SBL419201R8400	1.430
		110	0 0	AE75-40-00	1SBL419201R8600	1.430
		125	0 0	AE75-40-00	1SBL419201R8700	1.430
		220	0 0	AE75-40-00	1SBL419201R8800	1.430
		240	0 0	AE75-40-00	1SBL419201R8900	1.430
<b>2 N.O. + 2 N.C. main poles (2)</b>						
70	80	12	0 0	AE45-22-00	1SBL339501R8000	1.440
		24	0 0	AE45-22-00	1SBL339501R8100	1.440
		48	0 0	AE45-22-00	1SBL339501R8300	1.440
		60	0 0	AE45-22-00	1SBL339501R8400	1.440
		110	0 0	AE45-22-00	1SBL339501R8600	1.440
		125	0 0	AE45-22-00	1SBL339501R8700	1.440
		220	0 0	AE45-22-00	1SBL339501R8800	1.440
		240	0 0	AE45-22-00	1SBL339501R8900	1.440
125	105	12	0 0	AE75-22-00	1SBL419501R8000	1.440
		24	0 0	AE75-22-00	1SBL419501R8100	1.440
		48	0 0	AE75-22-00	1SBL419501R8300	1.440
		60	0 0	AE75-22-00	1SBL419501R8400	1.440
		110	0 0	AE75-22-00	1SBL419501R8600	1.440
		125	0 0	AE75-22-00	1SBL419501R8700	1.440
		220	0 0	AE75-22-00	1SBL419501R8800	1.440
		240	0 0	AE75-22-00	1SBL419501R8900	1.440

(1) Other control voltages see voltage code table.

(2) These contactors are not suitable for a reversing starter or star-delta starter or for controlling a single load from 2 separate supplies. Please see technical data.

#### Main dimensions mm, inches

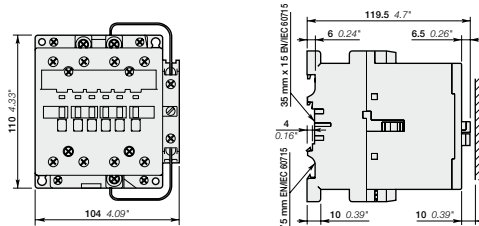

AE45, AE50, AE75 4-pole

1SBC101378S0201

# AF45 ... AF75 4-pole contactors

## 70 to 125 A AC-1

### AC / DC operated



AF45-40-00

#### Description

AF45 ... AF75 4-pole contactors are mainly used for controlling non-inductive or slightly inductive loads (i.e. resistance furnaces...) and generally for controlling power circuits up to 690 V AC and 220 V DC.

These contactors are of the block type design with:

- 4 main poles
- control circuit: AC or DC operated with electronic coil interface accepting a wide control voltage range (e.g. 100...250 V AC and DC)
  - can manage large control voltage variations
  - only 3 coils to cover control voltages between 48...250 V 50/60 Hz and 20...250 V DC
  - reduced panel energy consumption
  - very distinct closing and opening
  - can withstand short voltage dips and voltage sags (SEMI F47 conditions of use on request).
- built-in surge suppression
- add-on auxiliary contact blocks for front or side mounting and a wide range of accessories.

#### Ordering details

IEC	UL/CSA	Rated control circuit voltage		Auxiliary contacts fitted	Type	Order code	Weight
Rated operational current $\theta \leq 40^\circ\text{C}$ AC-1	General use rating 600 V AC	Uc min. ... Uc max.					Pkg (1 pce)
A	A	V 50/60 Hz	V DC				kg
<b>4 N.O. main poles</b>							
70	80	-	20...60	0 0	AF45-40-00	1SBL337201R7200 (1)	1.420
		48...130	48...130	0 0	AF45-40-00	1SBL337201R6900	1.420
		100...250	100...250	0 0	AF45-40-00	1SBL337201R7000	1.420
100	80	-	20...60	0 0	AF50-40-00	1SBL357201R7200 (1)	1.420
		48...130	48...130	0 0	AF50-40-00	1SBL357201R6900	1.420
		100...250	100...250	0 0	AF50-40-00	1SBL357201R7000	1.420
125	105	-	20...60	0 0	AF75-40-00	1SBL417201R7200 (1)	1.420
		48...130	48...130	0 0	AF75-40-00	1SBL417201R6900	1.420
		100...250	100...250	0 0	AF75-40-00	1SBL417201R7000	1.420
<b>2 N.O. + 2 N.C. main poles (2)</b>							
70	80	-	20...60	0 0	AF45-22-00	1SBL337501R7200 (1)	1.420
		48...130	48...130	0 0	AF45-22-00	1SBL337501R6900	1.420
		100...250	100...250	0 0	AF45-22-00	1SBL337501R7000	1.420
125	105	-	20...60	0 0	AF75-22-00	1SBL417501R7200 (1)	1.420
		48...130	48...130	0 0	AF75-22-00	1SBL417501R6900	1.420
		100...250	100...250	0 0	AF75-22-00	1SBL417501R7000	1.420

(1) The connection polarities indicated close to the coil terminals must be respected: A1 for the positive pole and A2 for the negative pole.

(2) These contactors are not suitable for a reversing starter or star-delta starter or for controlling a single load from 2 separate supplies.

Please see technical data.

#### Main dimensions mm, inches

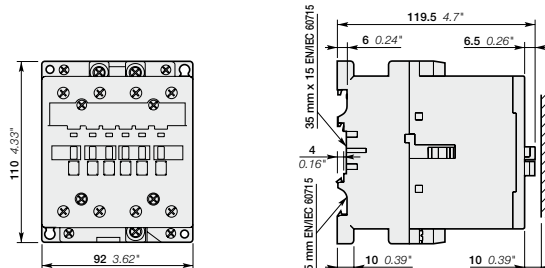

AF45, AF50, AF75 4-pole

# A45 ... A75, AE and AF45 ... AF75 4-pole contactors

## Main accessories

Contactor and main accessories (other accessories available)

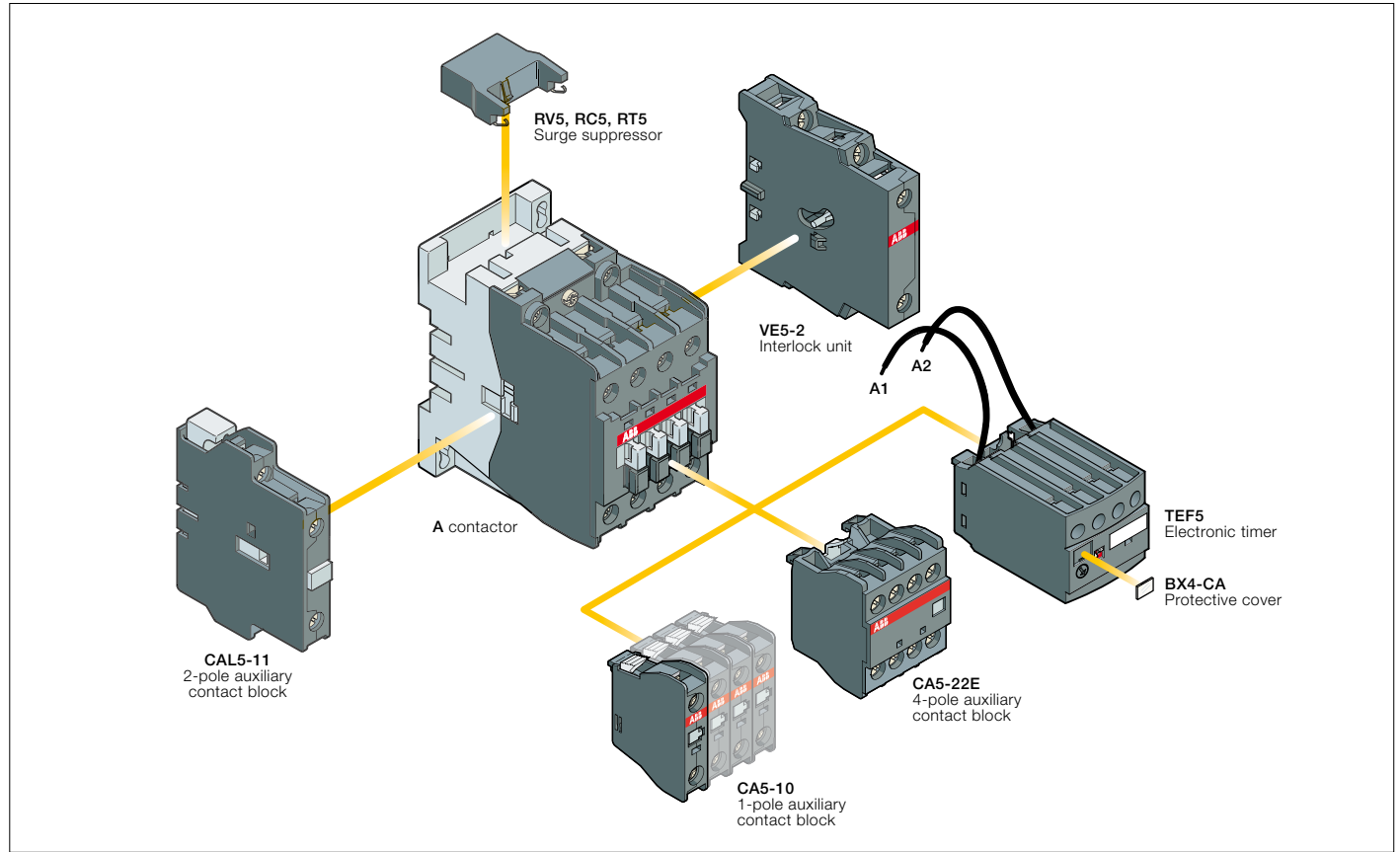

### Main accessory fitting details

Many configurations of accessories are possible depending on whether these are front-mounted or side-mounted.

Contactor types	Main poles	Available auxiliary contacts	Front-mounted accessories			Side-mounted accessories	
			Auxiliary contact blocks		Electronic timer	Auxiliary contact blocks	Interlock unit
			<b>1-pole CA5</b>	<b>4-pole CA5</b>	<b>TEF5</b>	<b>2-pole CAL5-11</b>	<b>VE5</b>
A45, A50, A75	4 0 0 0	0 0 0 0	1 to 6 x CA5	or 1 x CA5 (4-pole) + 2 x 1-pole CA5	or 1 x TEF5 + 2 x CA5 (1-pole)	+	1 to 2 x CAL5-11 or 1 x VE5-2 + 1 x CAL5-11
	2 2 0 0 (1)	0 0 (1)	1 to 6 x CA5	or 1 x CA5 (4-pole) + 2 x 1-pole CA5	or 1 x TEF5 + 2 x CA5 (1-pole)	+	1 to 2 x CAL5-11 -
AE45, AE50, AE75	4 0 0 0	0 0 0 0	1 to 6 x CA5	or 1 x CA5 (4-pole) + 2 x 1-pole CA5	or 1 x TEF5 + 2 x CA5 (1-pole)	+	1 x CAL5-11 or 1 x VE5-2
	2 2 0 0 (1)	0 0 (1)	1 to 6 x CA5	or 1 x CA5 (4-pole) + 2 x 1-pole CA5	or 1 x TEF5 + 2 x CA5 (1-pole)	+	1 x CAL5-11 -
AF45, AF50, AF75	4 0 0 0	0 0 0 0	1 to 6 x CA5	or 1 x CA5 (4-pole) + 2 x 1-pole CA5	or 1 x TEF5 + 2 x CA5 (1-pole)	+	1 to 2 x CAL5-11 or 1 x VE5-2 + 1 x CAL5-11
	2 2 0 0 (1)	0 0 (1)	1 to 6 x CA5	or 1 x CA5 (4-pole) + 2 x 1-pole CA5	or 1 x TEF5 + 2 x CA5 (1-pole)	+	1 to 2 x CAL5-11 -

(1) 2 x N.C. CA 5 auxiliary contacts maximum.

# A45 ... A75, AE and AF50 ... AF75 4-pole contactors

## Main accessories



CA5-10



CAL5-11

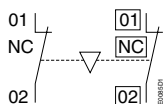

VE5-2  
Terminal marking and positioning



TEF5-OFF



RV5/50

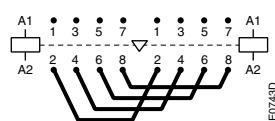

BES  
Changeover connections

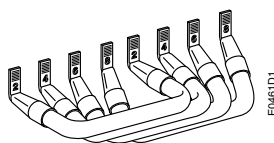

BES75-40

### Ordering details (1)

For contactors	Auxiliary contacts	Type	Order code	Pkg qty	Weight (1 pce)
					kg

### Front-mounted instantaneous auxiliary contact blocks

A45, A50, A75	1 -	CA5-10	1SBN010010R1010	10	0.014
AE45, AE50, AE75	- 1	CA5-01	1SBN010010R1001	10	0.014
AF45, AF50, AF75					
A45, A50, A75	2 2	CA5-22E	1SBN010040R1022	2	0.060
AE45, AE50, AE75					
AF45, AF50, AF75					

### Side-mounted instantaneous auxiliary contact blocks

A45, A50, A75	1 1	CAL5-11	1SBN010020R1011	2	0.050
AE45, AE50, AE75					
AF45, AF50, AF75					

### Interlock unit

A45, A50, A75-40-00	Mechanical and electrical	- 2	VE5-2	1SBN030210R1000	1	0.146
AE45, AE50, AE75-40-00						
AF45, AF50, AF75-40-00						

For contactors	Time delay range selected by switch	Delay type	Auxiliary contacts	Type	Order code	Pkg qty	Weight (1 pce)
							kg

### Electronic timers

A45, A50, A75	0.1...1 s	ON-delay	1 1	TEF5-ON	1SBN020312R1000	1	0.065
AE45, AE50, AE75	1...10 s						
AF45, AF50, AF75	10...100 s	OFF-delay	1 1	TEF5-OFF	1SBN020314R1000	1	0.065

Note: Rated control circuit voltage  $U_c$  24...240 V 50/60 Hz or DC.

For contactors	Rated control circuit voltage $U_c$		Type	Order code	Pkg qty	Weight (1 pce)
	V	AC DC				

### Surge suppressors

A45, A50, A75	24...50	● ●	RV5/50	1SBN050010R1000	2	0.015
AE45, AE50, AE75	50...133	● ●	RV5/133	1SBN050010R1001	2	0.015
	110...250	● ●	RV5/250	1SBN050010R1002	2	0.015
	250...440	● ●	RV5/440	1SBN050010R1003	2	0.015
A45, A50, A75	24...50	● -	RC5-2/50	1SBN050200R1000	2	0.015
	50...133	● -	RC5-2/133	1SBN050200R1001	2	0.015
	110...250	● -	RC5-2/250	1SBN050200R1002	2	0.015
	250...440	● -	RC5-2/440	1SBN050200R1003	2	0.015
AE45, AE50, AE75	12...32	- ●	RT5/32	1SBN050020R1000	2	0.015
	25...65	- ●	RT5/65	1SBN050020R1001	2	0.015
	50...90	- ●	RT5/90	1SBN050020R1002	2	0.015
	77...150	- ●	RT5/150	1SBN050020R1003	2	0.015
	150...264	- ●	RT5/264	1SBN050020R1004	2	0.015

### Connection sets for 4-pole changeover contactors

A45, A50, A75-40-00	BES75-40	1SBN083302R1000	1	0.400
AE45, AE50, AE75-40-00				
AF45, AF50, AF75-40-00				

(1) For more information, refer to "Accessories" section.



# TAE45 ... TAE75 4-pole contactors

## 70 to 125 A AC-1

### DC operated - Large coil voltage range



TAE50-40-00

#### Description

TAE45 ... TAE75 4-pole contactors are mainly used for controlling non-inductive or slightly inductive loads (i.e. resistance furnaces...) and generally for controlling power circuits up to 690 V AC and 440 V DC.

These contactors are of the block type design with:

- 4 main poles
- control circuit: large voltage range DC operated with double winding coil (and factory-mounted lagging contact for "holding" winding insertion)
- add-on auxiliary contact blocks for front or side mounting and a wide range of accessories.

#### Ordering details

IEC Rated operational current $\theta \leq 40^\circ\text{C}$ AC-1	UL/CSA General use rating 600 V AC	Rated control circuit voltage Uc min... Uc max	Auxiliary contacts fitted	Type	Order code	Weight Pkg (1 pce) kg
A	A	V DC				
<b>4 N.O. main poles</b>						
70	80	17...32	0 0	TAE45-40-00	1SBL339261R5100	1.430
		25...45	0 0	TAE45-40-00	1SBL339261R5200	1.430
		36...65	0 0	TAE45-40-00	1SBL339261R5400	1.430
		42...78	0 0	TAE45-40-00	1SBL339261R5800	1.430
		50...90	0 0	TAE45-40-00	1SBL339261R5500	1.430
		77...143	0 0	TAE45-40-00	1SBL339261R6200	1.430
		90...150	0 0	TAE45-40-00	1SBL339261R6600	1.430
100	80	152...264	0 0	TAE45-40-00	1SBL339261R6800	1.430
		17...32	0 0	TAE50-40-00	1SBL359261R5100	1.430
		25...45	0 0	TAE50-40-00	1SBL359261R5200	1.430
		36...65	0 0	TAE50-40-00	1SBL359261R5400	1.430
		42...78	0 0	TAE50-40-00	1SBL359261R5800	1.430
		50...90	0 0	TAE50-40-00	1SBL359261R5500	1.430
		77...143	0 0	TAE50-40-00	1SBL359261R6200	1.430
125	105	90...150	0 0	TAE50-40-00	1SBL359261R6600	1.430
		152...264	0 0	TAE50-40-00	1SBL359261R6800	1.430
		17...32	0 0	TAE75-40-00	1SBL419261R5100	1.430
		25...45	0 0	TAE75-40-00	1SBL419261R5200	1.430
		36...65	0 0	TAE75-40-00	1SBL419261R5400	1.430
		42...78	0 0	TAE75-40-00	1SBL419261R5800	1.430
		50...90	0 0	TAE75-40-00	1SBL419261R5500	1.430
77...143	0 0	TAE75-40-00	1SBL419261R6200	1.430		
90...150	0 0	TAE75-40-00	1SBL419261R6600	1.430		
152...264	0 0	TAE75-40-00	1SBL419261R6800	1.430		

#### Main dimensions mm, inches

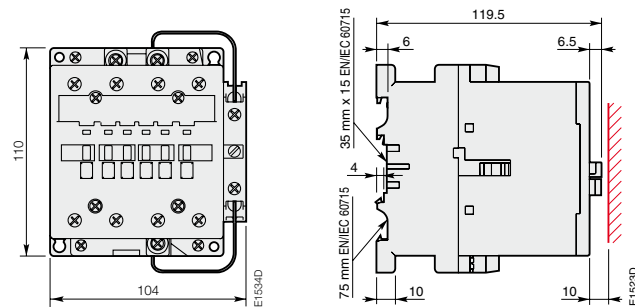

TAE45, TAE50, TAE75 4-pole



# Notes

A series of horizontal dotted lines for taking notes, spanning the width of the page.

# TAE45 ... TAE75 4-pole contactors

## Main accessories

### Contactor and main accessories (other accessories available)

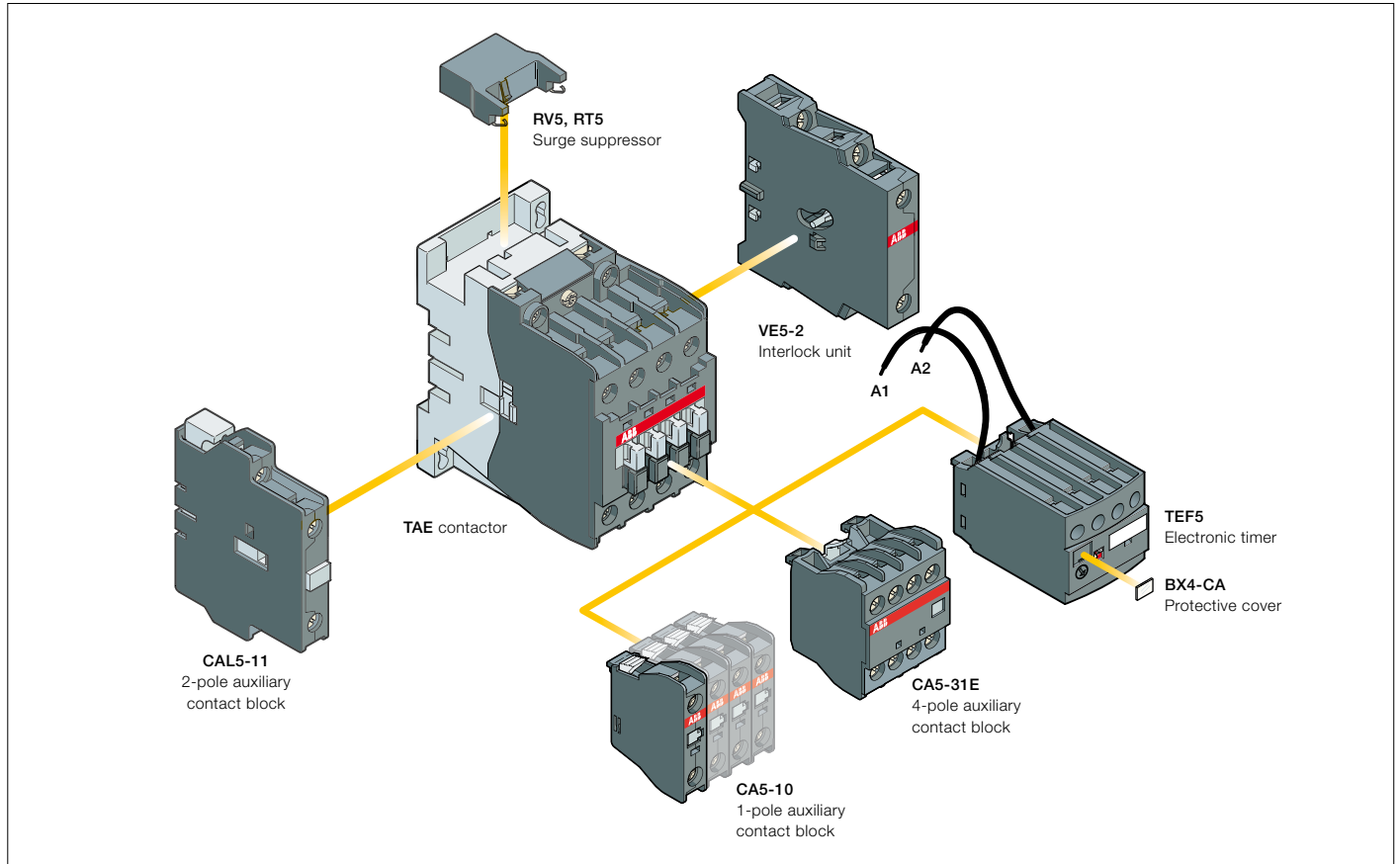

### Main accessories fitting details

Many configurations of accessories are possible depending on whether these are front-mounted or side-mounted.

Contactor types	Main poles	Available auxiliary contacts	Front-mounted accessories			Side-mounted accessories	
			Auxiliary contact blocks		Electronic timer	Auxiliary contact blocks	Interlock unit
TAE45, TAE50, TAE75	4	0 0 0	1-pole CA5	4-pole CA5	TEF5	2-pole CAL5-11	VE5
			1 to 6 x CA5	or 1 x CA5 (4-pole) + 2 x 1-pole CA5	or 1 x TEF5 + 2 x 1-pole CA5	+	or 1 x VE5-2

# TAE45 ... TAE75 4-pole contactors

## Main accessories



CA5-10



CAL5-11

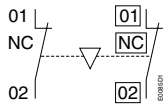

VE5-2

Terminal marking and positioning



TEF5-OFF



RV5/50

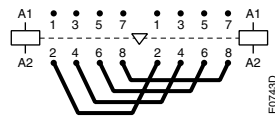

BES

Changeover connections

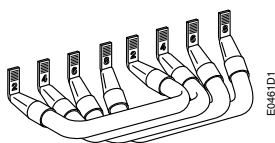

BES75-40

### Ordering details (1)

For contactors	Auxiliary contacts	Type	Order code	Pkg qty	Weight (1 pce)
					kg

### Front-mounted instantaneous auxiliary contact blocks

TAE45, TAE50, TAE75	1 -	CA5-10	1SBN010010R1010	10	0.014
	- 1	CA5-01	1SBN010010R1001	10	0.014
	2 2	CA5-22E	1SBN010040R1022	2	0.060

### Side-mounted instantaneous auxiliary contact blocks

TAE45, TAE50, TAE75	1 1	CAL5-11	1SBN010020R1011	2	0.050
---------------------	-----	---------	-----------------	---	-------

### Interlock unit

TAE45, TAE50, TAE75	Mechanical and electrical	- 2	VE5-2	1SBN030210R1000	1	0.146
---------------------	---------------------------	-----	-------	-----------------	---	-------

For contactors	Time delay range selected by switch	Delay type	Auxiliary contacts	Type	Order code	Pkg qty	Weight (1 pce)
							kg

### Electronic timers

TAE45, TAE50, TAE75	0.1...1 s	ON-delay	1 1	TEF5-ON	1SBN020312R1000	1	0.065
	1...10 s						
	10...100 s	OFF-delay	1 1	TEF5-OFF	1SBN020314R1000	1	0.065

Note: Rated control circuit voltage  $U_c$  24...240 V 50/60 Hz or DC.

For contactors	Rated control circuit voltage $U_c$	Type	Order code	Pkg qty	Weight (1 pce)
	V	AC DC			kg

### Surge suppressors

TAE45, TAE50, TAE75	24...50	● ●	RV5/50	1SBN050010R1000	2	0.015
	50...133	● ●	RV5/133	1SBN050010R1001	2	0.015
	110...250	● ●	RV5/250	1SBN050010R1002	2	0.015
	250...440	● ●	RV5/440	1SBN050010R1003	2	0.015
TAE45, TAE50, TAE75	12...32	- ●	RT5/32	1SBN050020R1000	2	0.015
	25...65	- ●	RT5/65	1SBN050020R1001	2	0.015
	50...90	- ●	RT5/90	1SBN050020R1002	2	0.015
	77...150	- ●	RT5/150	1SBN050020R1003	2	0.015
	150...264	- ●	RT5/264	1SBN050020R1004	2	0.015

### Connection sets for 4-pole changeover contactors

TAE45, TAE50, TAE75	BES75-40	1SBN083302R1000	1	0.400
---------------------	----------	-----------------	---	-------

(1) For more information, refer to "Accessories" section.

# EK110 ... EK150 4-pole contactors

## 200 to 250 A AC-1

### AC operated - with 1 N.O. + 1 N.C. auxiliary contacts



18BC57340 F0301



EK150-40-11

#### Description

EK110 ... EK150 4-pole contactors are mainly used for controlling non-inductive or slightly inductive loads (i.e. resistance furnaces...) and for controlling power circuits up to 1000 V AC and 440 V DC. These contactors are of the block type design with:

- 4 main poles
- control circuit: AC operated
- add-on auxiliary contact blocks for side mounting and a wide range of accessories.

#### Ordering details

IEC Rated operational current $\theta \leq 40^\circ\text{C}$ AC-1 A	UL/CSA General use rating 600 V AC A	Rated control circuit voltage Uc (1)		Auxiliary contacts fitted		Type	Order code	Weight Pkg (1 pce) kg
		V 50 Hz	V 60 Hz					
200	170	48	-	1	1	EK110-40-11	SK824440-AD	4,300
		-	110	1	1	EK110-40-11	SK824440-AE	4,300
		110	120	1	1	EK110-40-11	SK824440-AF	4,300
		220...230	-	1	1	EK110-40-11	SK824440-AL	4,300
		230...240	-	1	1	EK110-40-11	SK824440-AM	4,300
		-	380	1	1	EK110-40-11	SK824440-AN	4,300
		380...400	440	1	1	EK110-40-11	SK824440-AP	4,300
		400...415	-	1	1	EK110-40-11	SK824440-AR	4,300
250	200	48	-	1	1	EK150-40-11	SK824441-AD	4,350
		-	110	1	1	EK150-40-11	SK824441-AE	4,350
		110	120	1	1	EK150-40-11	SK824441-AF	4,350
		220...230	-	1	1	EK150-40-11	SK824441-AL	4,350
		230...240	-	1	1	EK150-40-11	SK824441-AM	4,350
		-	380	1	1	EK150-40-11	SK824441-AN	4,350
		380...400	440	1	1	EK150-40-11	SK824441-AP	4,350
		400...415	-	1	1	EK150-40-11	SK824441-AR	4,350

(1) Other control voltages see voltage code table.

#### Main dimensions mm, inches

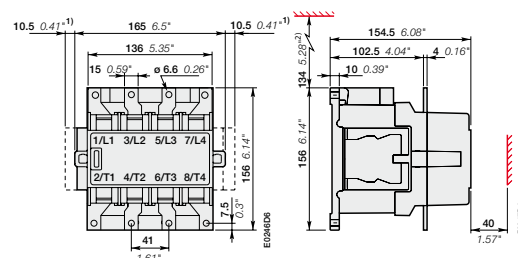

EK110

- 1) Dimension for extra auxiliary contact block.
- 2) Min. distance to uninsulated wall.

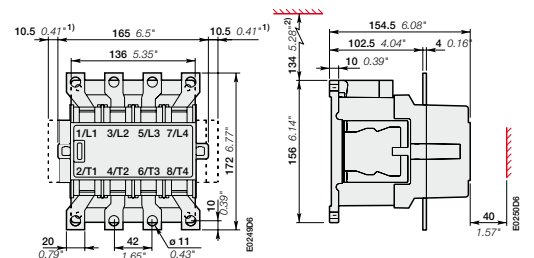

EK150

# EK110 ... EK150 4-pole contactors

## 200 to 250 A AC-1

### DC operated - with 2 N.O. + 1 N.C. auxiliary contacts



EK150-40-21

#### Description

EK110 ... EK150 4-pole contactors are mainly used for controlling non-inductive or slightly inductive loads (i.e. resistance furnaces...) and for controlling power circuits up to 1000 V AC and 440 V DC.

These contactors are of the block type design with:

- 4 main poles
- control circuit: DC operated
- add-on auxiliary contact blocks for side mounting and a wide range of accessories.

#### Ordering details

IEC Rated operational current $\theta \leq 40^\circ\text{C}$ AC-1 A	UL/CSA General use rating 600 V AC A	Rated control circuit voltage Uc VDC	Auxiliary contacts fitted 	Type	Order code	Weight Pkg (1 pce) kg
200	170	12	2 1	EK110-40-21	SK824440-DA	4.350
		24	2 1	EK110-40-21	SK824440-DB	4.350
		36	2 1	EK110-40-21	SK824440-DC	4.350
		48	2 1	EK110-40-21	SK824440-DD	4.350
		60	2 1	EK110-40-21	SK824440-DT	4.350
		75	2 1	EK110-40-21	SK824440-DG	4.350
		110	2 1	EK110-40-21	SK824440-DE	4.350
		125	2 1	EK110-40-21	SK824440-DU	4.350
250	200	12	2 1	EK150-40-21	SK824441-DA	4.400
		24	2 1	EK150-40-21	SK824441-DB	4.400
		36	2 1	EK150-40-21	SK824441-DC	4.400
		48	2 1	EK150-40-21	SK824441-DD	4.400
		60	2 1	EK150-40-21	SK824441-DT	4.400
		75	2 1	EK150-40-21	SK824441-DG	4.400
		110	2 1	EK150-40-21	SK824441-DE	4.400
		125	2 1	EK150-40-21	SK824441-DU	4.400
		220	2 1	EK150-40-21	SK824441-DF	4.400

#### Main dimensions mm, inches

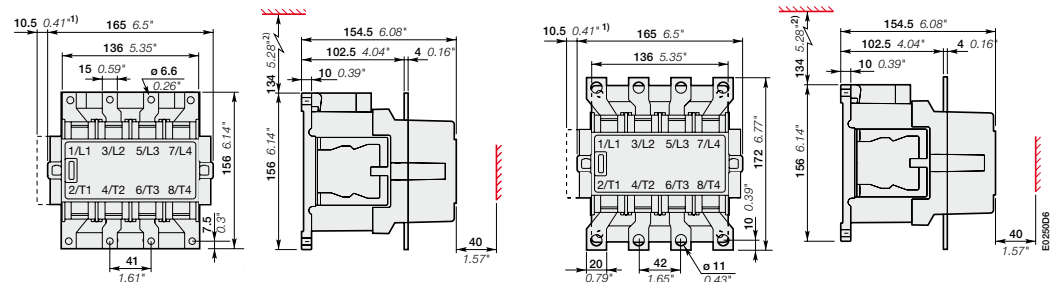

#### EK110

- 1) Dimension for extra auxiliary contact block.
- 2) Min. distance to uninsulated wall.

#### EK150

# EK175 ... EK550 4-pole contactors

## 300 to 800 A AC-1

### AC operated - with 1 N.O. + 1 N.C. auxiliary contacts





EK370-40-11

#### Description

EK175 ... EK550 4-pole contactors are mainly used for controlling non-inductive or slightly inductive loads (i.e. resistance furnaces...) and for controlling power circuits up to 1000 V AC and 600 V DC. These contactors are of the block type design with:

- 4 main poles
- control circuit: AC operated
- add-on auxiliary contact blocks for side mounting and a wide range of accessories.

#### Ordering details

IEC Rated operational current $\theta \leq 40^\circ\text{C}$ AC-1 A	UL/CSA General use rating 600 V AC A	Rated control circuit voltage $U_c$ (1)		Auxiliary contacts fitted		Type	Order code	Weight  Pkg (1 pce)  kg
		V 50 Hz	V 60 Hz					
300	250	48	-	1	1	EK175-40-11	SK825440-AD	6.600
		-	110	1	1	EK175-40-11	SK825440-AE	6.600
		110	120	1	1	EK175-40-11	SK825440-AF	6.600
		220...230	-	1	1	EK175-40-11	SK825440-AL	6.600
		230...240	-	1	1	EK175-40-11	SK825440-AM	6.600
		-	380	1	1	EK175-40-11	SK825440-AN	6.600
		380...400	440	1	1	EK175-40-11	SK825440-AP	6.600
		400...415	-	1	1	EK175-40-11	SK825440-AR	6.600
350	300	48	-	1	1	EK210-40-11	SK825441-AD	6.600
		-	110	1	1	EK210-40-11	SK825441-AE	6.600
		110	120	1	1	EK210-40-11	SK825441-AF	6.600
		220...230	-	1	1	EK210-40-11	SK825441-AL	6.600
		230...240	-	1	1	EK210-40-11	SK825441-AM	6.600
		-	380	1	1	EK210-40-11	SK825441-AN	6.600
		380...400	440	1	1	EK210-40-11	SK825441-AP	6.600
		400...415	-	1	1	EK210-40-11	SK825441-AR	6.600
550	420	48	-	1	1	EK370-40-11	SK827040-AD	17.200
		110	110...120	1	1	EK370-40-11	SK827040-EF	17.200
		110...115	115...127	1	1	EK370-40-11	SK827040-EG	17.200
		220	220...240	1	1	EK370-40-11	SK827040-EL	17.200
		220...230	230...255	1	1	EK370-40-11	SK827040-EM	17.200
		380	380...415	1	1	EK370-40-11	SK827040-EP	17.200
		380...400	400...440	1	1	EK370-40-11	SK827040-ER	17.200
		400...415	-	1	1	EK370-40-11	SK827040-AR	17.200
800	540	48	-	1	1	EK550-40-11	SK827041-AD	17.200
		110	110...120	1	1	EK550-40-11	SK827041-EF	17.200
		110...115	115...127	1	1	EK550-40-11	SK827041-EG	17.200
		220	220...240	1	1	EK550-40-11	SK827041-EL	17.200
		220...230	230...255	1	1	EK550-40-11	SK827041-EM	17.200
		380	380...415	1	1	EK550-40-11	SK827041-EP	17.200
		380...400	400...440	1	1	EK550-40-11	SK827041-ER	17.200
		400...415	-	1	1	EK550-40-11	SK827041-AR	17.200

(1) Other control voltages see voltage code table.

#### Main dimensions mm, inches

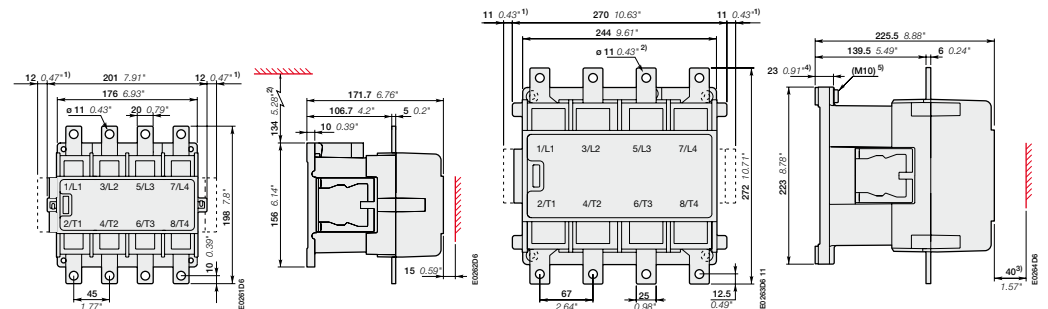

#### EK175, EK210

- 1) Dimension for extra auxiliary contact block.
- 2) Min. distance to uninsulated wall.

#### EK370, EK550

- 1) Dimension for extra auxiliary contact block.
- 2) Screw, nut and washer by-packed.
- 3) Min. distance to uninsulated wall.
- 4) Damping elements are included.
- 5) Earthing screw.

# EK175 ... EK550 4-pole contactors

## 300 to 800 A AC-1

### DC operated - with 2 N.O. + 1 N.C. auxiliary contacts



EK370-40-21

#### Description

EK175 ... EK550 4-pole contactors are mainly used for controlling non-inductive or slightly inductive loads (i.e. resistance furnaces...) and generally for controlling power circuits up to 1000 V AC and 600 V DC. These contactors are of the block type design with:

- 4 main poles
- control circuit: DC operated with
- add-on auxiliary contact blocks for side mounting and a wide range of accessories.

#### Ordering details

IEC Rated operational current $\theta \leq 40^\circ\text{C}$ AC-1 A	UL/CSA General use rating 600 V AC A	Rated control circuit voltage Uc V DC	Auxiliary contacts fitted 	Type	Order code	Weight Pkg (1 pce) kg		
300	250	12	2 1	EK175-40-21	SK825440-DA	6.650		
		24	2 1	EK175-40-21	SK825440-DB	6.650		
		36	2 1	EK175-40-21	SK825440-DC	6.650		
		48	2 1	EK175-40-21	SK825440-DD	6.650		
		60	2 1	EK175-40-21	SK825440-DT	6.650		
		75	2 1	EK175-40-21	SK825440-DG	6.650		
		110	2 1	EK175-40-21	SK825440-DE	6.650		
		125	2 1	EK175-40-21	SK825440-DU	6.650		
		220	2 1	EK175-40-21	SK825440-DF	6.650		
		350	300	12	2 1	EK210-40-21	SK825441-DA	6.650
24	2 1			EK210-40-21	SK825441-DB	6.650		
36	2 1			EK210-40-21	SK825441-DC	6.650		
48	2 1			EK210-40-21	SK825441-DD	6.650		
60	2 1			EK210-40-21	SK825441-DT	6.650		
75	2 1			EK210-40-21	SK825441-DG	6.650		
110	2 1			EK210-40-21	SK825441-DE	6.650		
125	2 1			EK210-40-21	SK825441-DU	6.650		
220	2 1			EK210-40-21	SK825441-DF	6.650		
550	420			24	2 1	EK370-40-21	SK827040-DB	17.200
		36	2 1	EK370-40-21	SK827040-DC	17.200		
		48	2 1	EK370-40-21	SK827040-DD	17.200		
		60	2 1	EK370-40-21	SK827040-DT	17.200		
		75	2 1	EK370-40-21	SK827040-DG	17.200		
		110	2 1	EK370-40-21	SK827040-DE	17.200		
		125	2 1	EK370-40-21	SK827040-DU	17.200		
		220	2 1	EK370-40-21	SK827040-DF	17.200		
		800	540	24	2 1	EK550-40-21	SK827041-DB	17.200
				36	2 1	EK550-40-21	SK827041-DC	17.200
48	2 1			EK550-40-21	SK827041-DD	17.200		
60	2 1			EK550-40-21	SK827041-DT	17.200		
75	2 1			EK550-40-21	SK827041-DG	17.200		
110	2 1			EK550-40-21	SK827041-DE	17.200		
125	2 1			EK550-40-21	SK827041-DU	17.200		
220	2 1			EK550-40-21	SK827041-DF	17.200		

#### Main dimensions mm, inches

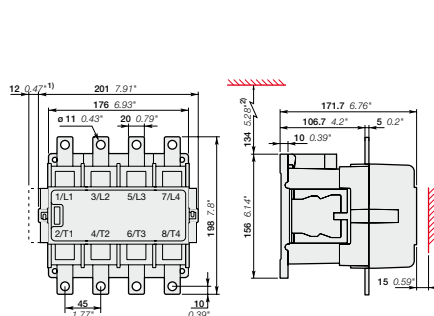

EK175 ... EK210

- 1) Dimension for extra auxiliary contact block.
- 2) Min. distance to uninsulated wall.

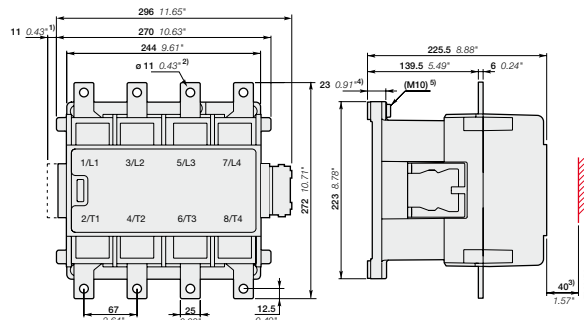

EK370 ... EK550

- 1) Dimension for extra auxiliary contact block.
- 2) Screw, nut and washer by-packed.
- 3) Min. distance to uninsulated wall.
- 4) Damping elements are included.
- 5) Earthing screw.

# EK1000 4-pole contactors

## 1000 A AC-1

### AC operated - with 1 N.O. + 1 N.C. auxiliary contacts



EK1000-40-11



#### Description

EK1000 4-pole contactors are mainly used for controlling non-inductive or slightly inductive loads (i.e. resistance furnaces...) and generally for controlling power circuits up to 1000 V AC.

These contactors are of the block type design with:

- 4 main poles
- control circuit: AC operated
- add-on auxiliary contact blocks for side mounting and a wide range of accessories.

#### Ordering details

IEC	UL/CSA	Rated control circuit voltage U <sub>c</sub>		Auxiliary contacts fitted		Type	Order code	Weight
Rated operational current	General use rating	(1)						Pkg (1 pce)
θ ≤ 40 °C AC-1	600 V AC	V 50 Hz	V 60 Hz					kg
1000	-	48	-	1	1	EK1000-40-11	SK827044-AD	17.500
		110	110...120	1	1	EK1000-40-11	SK827044-EF	17.500
		110...115	115...127	1	1	EK1000-40-11	SK827044-EG	17.500
		220	220...240	1	1	EK1000-40-11	SK827044-EL	17.500
		220...230	230...255	1	1	EK1000-40-11	SK827044-EM	17.500
		380	380...415	1	1	EK1000-40-11	SK827044-EP	17.500
		380...400	400...440	1	1	EK1000-40-11	SK827044-ER	17.500
		400...415	-	1	1	EK1000-40-11	SK827044-AR	17.500

(1) Other control voltages see voltage code table.

#### Main dimensions mm, inches

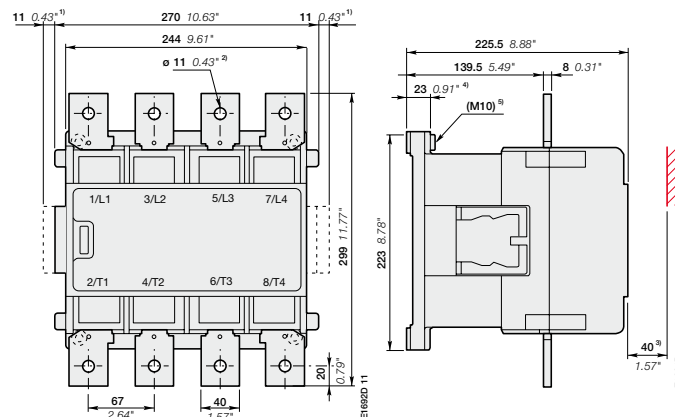

#### EK1000

- 1) Dimension for extra auxiliary contact block.
- 2) Screw, nut and washer by-packed.
- 3) Min. distance to uninsulated wall.
- 4) Damping elements are included.
- 5) Earthing screw.



# EK1000 4-pole contactors

## 1000 A AC-1

### DC operated - with 2 N.O. + 1 N.C. auxiliary contacts



EK1000-40-21

1SFC8039-009

#### Description

EK1000 4-pole contactors are mainly used for controlling non-inductive or slightly inductive loads (i.e. resistance furnaces...) and generally for controlling power circuits up to 1000 V AC. These contactors are of the block type design with:

- 4 main poles
- control circuit: DC operated
- add-on auxiliary contact blocks for side mounting and a wide range of accessories.

#### Ordering details

IEC Rated operational current $\theta \leq 40^\circ\text{C}$ AC-1 A	UL/CSA General use rating 600 V AC A	Rated control circuit voltage Uc V DC	Auxiliary contacts fitted 	Type	Order code	Weight Pkg (1 pce) kg
1000	-	24	2 1	EK1000-40-21	SK827044-DB	17.500
		36	2 1	EK1000-40-21	SK827044-DC	17.500
		48	2 1	EK1000-40-21	SK827044-DD	17.500
		60	2 1	EK1000-40-21	SK827044-DT	17.500
		75	2 1	EK1000-40-21	SK827044-DG	17.500
		110	2 1	EK1000-40-21	SK827044-DE	17.500
		125	2 1	EK1000-40-21	SK827044-DU	17.500
		220	2 1	EK1000-40-21	SK827044-DF	17.500

#### Main dimensions mm, inches

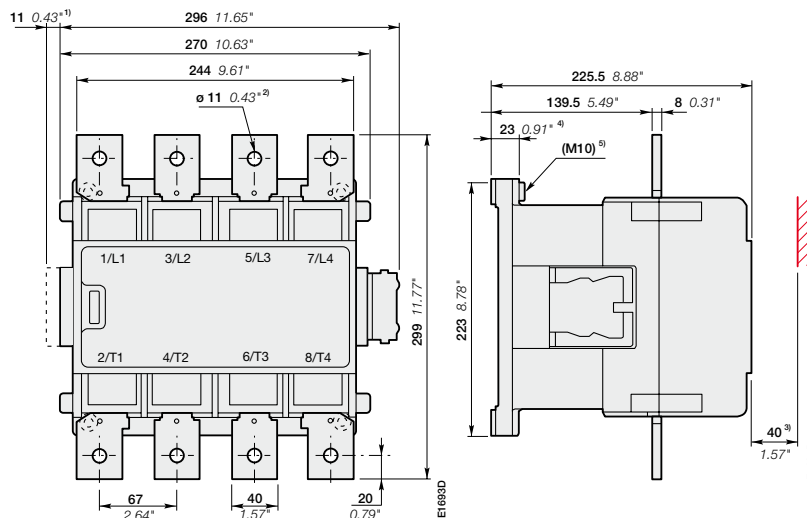

#### EK1000

- 1) Dimension for extra auxiliary contact block.
- 2) Screw, nut and washer by-packed.
- 3) Min. distance to uninsulated wall.
- 4) Damping elements are included.
- 5) Earthing screw.

1SFC101063C0201

# EK110 ... EK150 4-pole Contactors

## 200 to 250 A AC-1

### AC Operated - with 2 N.O. + 2 N.C. auxiliary contacts



1SFC50087 3FC001



EK150-40-22

#### Description

EK110 ... EK150 4-pole contactors are mainly used for controlling non-inductive or slightly inductive loads (i.e. resistance furnaces...) and for controlling power circuits up to 1000 V AC and 440 V DC. These contactors are of the block type design with:

- 4 main poles
- control circuit: AC operated
- add-on auxiliary contact blocks for side mounting and a wide range of accessories

#### Ordering details

IEC Rated operational current $\theta \leq 40^\circ\text{C}$ AC-1 A	UL/CSA General use rating 600 V AC A	Rated control circuit voltage Uc (1)		Auxiliary contacts fitted		Type	Order code	Weight Pkg (1 pce) kg
		V 50 Hz	V 60 Hz					
200	170	48	-	2	2	EK110-40-22	SK824450-AD	4.350
		-	110	2	2	EK110-40-22	SK824450-AE	4.350
		110	120	2	2	EK110-40-22	SK824450-AF	4.350
		220 ... 230	-	2	2	EK110-40-22	SK824450-AL	4.350
		230 ... 240	-	2	2	EK110-40-22	SK824450-AM	4.350
		-	380	2	2	EK110-40-22	SK824450-AN	4.350
		380 ... 400	440	2	2	EK110-40-22	SK824450-AP	4.350
250	200	48	-	2	2	EK150-40-22	SK824451-AD	4.400
		-	110	2	2	EK150-40-22	SK824451-AE	4.400
		110	120	2	2	EK150-40-22	SK824451-AF	4.400
		220 ... 230	-	2	2	EK150-40-22	SK824451-AL	4.400
		230 ... 240	-	2	2	EK150-40-22	SK824451-AM	4.400
		-	380	2	2	EK150-40-22	SK824451-AN	4.400
		380 ... 400	440	2	2	EK150-40-22	SK824451-AP	4.400
400 ... 415	-	2	2	EK150-40-22	SK824451-AR	4.400		

(1) Other control voltages see voltage code table.

#### Main dimensions mm, inches

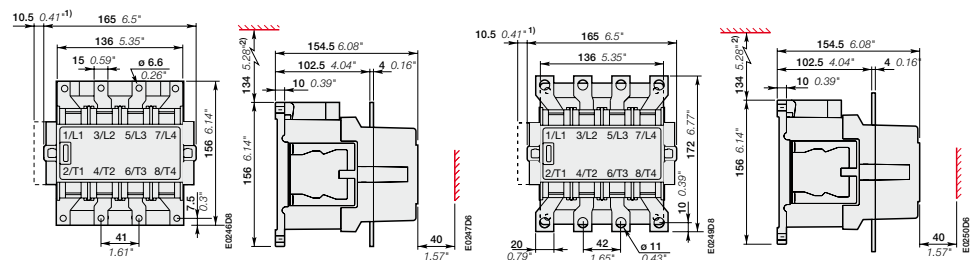

EK110

- 1) Dimension for extra auxiliary contact block
- 2) Min. distance to uninsulated wall

EK150

# EK175 ... EK550 4-pole Contactors

## 300 to 800 A AC-1

### AC Operated - with 2 N.O. + 2 N.C. auxiliary contacts



EK370-40-22

19B25794-02F0001

#### Description

EK175 ... EK550 4-pole contactors are mainly used for controlling non-inductive or slightly inductive loads (i.e. resistance furnaces...) and for controlling power circuits up to 1000 V AC and 600 V DC.

These contactors are of the block type design with:

- 4 main poles
- control circuit: AC operated
- add-on auxiliary contact blocks for side mounting and a wide range of accessories

#### Ordering details

IEC Rated operational current $\theta \leq 40^\circ\text{C}$ AC-1 A	UL/CSA General use rating 600 V AC A	Rated control circuit voltage $U_c$ (1)		Auxiliary contacts fitted 	Type	Order code	Weight Pkg (1 pce) kg
		V 50 Hz	V 60 Hz				
300	250	48	-	2 2	EK175-40-22	SK825448-AD	6.650
		-	110	2 2	EK175-40-22	SK825448-AE	6.650
		110	120	2 2	EK175-40-22	SK825448-AF	6.650
		220 ... 230	-	2 2	EK175-40-22	SK825448-AL	6.650
		230 ... 240	-	2 2	EK175-40-22	SK825448-AM	6.650
		-	380	2 2	EK175-40-22	SK825448-AN	6.650
		380 ... 400	440	2 2	EK175-40-22	SK825448-AP	6.650
		400 ... 415	-	2 2	EK175-40-22	SK825448-AR	6.650
350	300	48	-	2 2	EK210-40-22	SK825451-AD	6.650
		-	110	2 2	EK210-40-22	SK825451-AE	6.650
		110	120	2 2	EK210-40-22	SK825451-AF	6.650
		220 ... 230	-	2 2	EK210-40-22	SK825451-AL	6.650
		230 ... 240	-	2 2	EK210-40-22	SK825451-AM	6.650
		-	380	2 2	EK210-40-22	SK825451-AN	6.650
		380 ... 400	440	2 2	EK210-40-22	SK825451-AP	6.650
		400 ... 415	-	2 2	EK210-40-22	SK825451-AR	6.650
550	420	48	-	2 2	EK370-40-22	SK827042-AD	17.200
		110	110 ... 120	2 2	EK370-40-22	SK827042-EF	17.200
		110 ... 115	115 ... 127	2 2	EK370-40-22	SK827042-EG	17.200
		220	220 ... 240	2 2	EK370-40-22	SK827042-EL	17.200
		220 ... 230	230 ... 255	2 2	EK370-40-22	SK827042-EM	17.200
		380	380 ... 415	2 2	EK370-40-22	SK827042-EP	17.200
		380 ... 400	400 ... 440	2 2	EK370-40-22	SK827042-ER	17.200
		400 ... 415	-	2 2	EK370-40-22	SK827042-AR	17.200
800	540	48	-	2 2	EK550-40-22	SK827043-AD	17.200
		110	110 ... 120	2 2	EK550-40-22	SK827043-EF	17.200
		110 ... 115	115 ... 127	2 2	EK550-40-22	SK827043-EG	17.200
		220	220 ... 240	2 2	EK550-40-22	SK827043-EL	17.200
		220 ... 230	230 ... 255	2 2	EK550-40-22	SK827043-EM	17.200
		380	380 ... 415	2 2	EK550-40-22	SK827043-EP	17.200
		380 ... 400	400 ... 440	2 2	EK550-40-22	SK827043-ER	17.200
		400 ... 415	-	2 2	EK550-40-22	SK827043-AR	17.200

(1) Other control voltages see voltage code table.

#### Main dimensions mm, inches

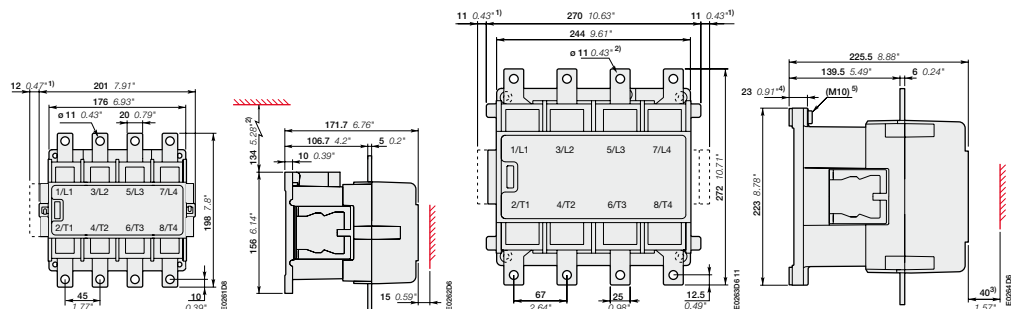

#### EK175

- 1) Dimension for extra auxiliary contact block.
- 2) Min. distance to uninsulated wall.

#### EK370, EK550

- 1) Dimension for extra auxiliary contact block.
- 2) Screw, nut and washer by-packed.
- 3) Min. distance to uninsulated wall.
- 4) Damping elements are included.
- 5) Earthing screw.

# EK1000 4-pole Contactors

## 1000 A AC-1

### AC Operated - with 2 N.O. + 2 N.C. auxiliary contacts



1SFC8093-009

EK1000-40-22



#### Description

EK1000 4-pole contactors are mainly used for controlling non-inductive or slightly inductive loads (i.e. resistance furnaces...) and for controlling power circuits up to 1000 V AC.

These contactors are of the block type design with:

- 4 main poles
- control circuit: AC operated
- add-on auxiliary contact blocks for side mounting and a wide range of accessories

#### Ordering details

IEC	UL/CSA	Rated control circuit voltage $U_c$		Auxiliary contacts fitted		Type	Order code	Weight
Rated operational current $\theta \leq 40^\circ\text{C}$ AC-1	General use rating 600 V AC	(1)						Pkg (1 pce)
A	A	V 50 Hz	V 60 Hz					kg
1000	-	48	-	2	2	EK1000-40-22	SK827045-AD	17.500
		110	110 ... 120	2	2	EK1000-40-22	SK827045-EF	17.500
		110 ... 115	115 ... 127	2	2	EK1000-40-22	SK827045-EG	17.500
		220	220 ... 240	2	2	EK1000-40-22	SK827045-EL	17.500
		220 ... 230	230 ... 255	2	2	EK1000-40-22	SK827045-EM	17.500
		380	380 ... 415	2	2	EK1000-40-22	SK827045-EP	17.500
		380 ... 400	400 ... 440	2	2	EK1000-40-22	SK827045-ER	17.500
		400 ... 415	-	2	2	EK1000-40-22	SK827045-AR	17.500

(1) Other control voltages see voltage code table

#### Main dimensions mm, inches

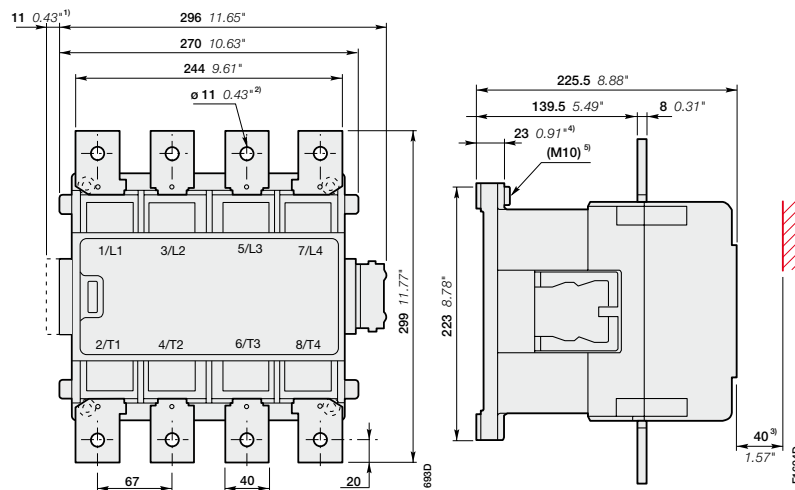

#### EK1000

- 1) Dimension for extra auxiliary contact block
- 2) Screw, nut and washer by-packed
- 3) Min. distance to uninsulated wall
- 4) Damping elements are included
- 5) Earthing screw

# Notes

A series of horizontal dotted lines for taking notes.

# EK110 ... EK1000 4-pole contactors with 1 N.O. + 1 N.C. auxiliary contacts and 2 N.O. + 1 N.C. auxiliary contacts

## Main accessory fitting details

### Mounting positions of the auxiliary contact

### Auxiliary contact types and connecting diagrams

(1) Contact 35-36 used for some types of EK... contactors

## EK... 4-pole contactors

Contactor types	Main poles	Available auxiliary contacts	Add-on auxiliary contact blocks	Mounting and positioning
			2-pole CAL16-11 ...	<div style="display: flex; justify-content: space-around;"> <span><span style="background-color: yellow; border: 1px solid black; padding: 2px;"> </span> Factory mounted auxiliary contacts</span> <span><span style="background-color: orange; border: 1px solid black; padding: 2px;"> </span> Add-on CAL16-11 auxiliary contacts</span> </div>
<b>AC operated, 50 Hz, 60 Hz or 50/60 Hz</b>				
EK110 ... EK1000	4 0 1 1		+ 1 x CAL16-11B + 1 x CAL16-11C + 1 x CAL16-11D	
<b>AC operated, 40...400 Hz</b>				
EK110 ... EK210	4 0 2 1		+ 1 x CAL16-11C	
<b>DC operated</b>				
EK110 ... EK1000	4 0 2 1		+ 1 x CAL16-11C	

## EK ... 4-pole reversing contactors with VH145 / VH300 mechanical and electrical interlock units

"Left hand" contactors	Interlocking	"Right hand" contactors	Add-on auxiliary contact blocks	Mounting and positioning
			2-pole CAL16-11 ...	<div style="display: flex; justify-content: space-around;"> <span><span style="background-color: yellow; border: 1px solid black; padding: 2px;"> </span> Factory mounted auxiliary contacts</span> <span><span style="background-color: orange; border: 1px solid black; padding: 2px;"> </span> Add-on CAL16-11 auxiliary contacts</span> </div>
<b>AC operated, 50 Hz, 60 Hz or 50/60 Hz</b>				
EK110 ... EK150 EK175, EK210 EK370 ... EK1000	VH145 VH300 VH800	EK110, EK150 EK175, EK210 EK370 ... EK1000	+ 1 x CAL16-11C + 1 x CAL16-11D	
<b>AC operated, 40...400 Hz</b>				
EK110 ... EK150 EK175, EK210 EK370 ... EK1000	VH145 VH300 VH800	EK110, EK150 EK175, EK210 EK370 ... EK1000	—	
<b>DC operated, 50 Hz, 60 Hz or 50/60 Hz</b>				
EK110 ... EK150 EK175, EK210 EK370 ... EK1000	VH145 VH300 VH800	EK110, EK150 EK175, EK210 EK370 ... EK1000	—	

# EK110 ... EK1000 4-pole contactors with 1 N.O. + 1 N.C. auxiliary contacts and 2 N.O. + 1 N.C. auxiliary contacts

## Ordering details (1)

For contactors	Auxiliary contacts	Type	Order code	Pkg qty	Weight (1 pce)
					kg



VH145

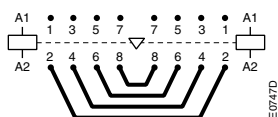

BSS100 ... BSS100



RC-EH300/48

## Side-mounted auxiliary contact blocks

EK...	1	1	CAL16-11B	SK829002-B	1	0.050
	1	1	CAL16-11C	SK829002-C	1	0.050
	1	1	CAL16-11D	SK829002-D	1	0.050
	1	1	CCL16-11E (2)	SK829002-E	1	0.050

(2) Mounting of CCL16-11E blocks does not allow an additional second block to be added on top of it. All DC operated EK... contactors are equipped with one CCL16-11E on the right side.

## Mechanical and electrical interlock unit for two horizontal mounted contactors

EK110, EK150	VH145	SK829071-A	1	0.130
EK175, EK210	VH300	SK829071-B	1	0.130

## Mechanical interlock unit for two horizontal mounted contactors

EK370 ... EK1000	VH800	SK829070-F	1	6.000
------------------	-------	------------	---	-------

## Connecting sets

EK110	BSS100	SK829090-B	1	0.400
EK150	BSS145	SK829090-F	1	0.700
EK175, EK210	BSS210	SK829090-G	1	1.000
EK370, EK550	BSS550	SK829090-E	1	3.300
EK1000	BSS1000	SK829090-H	1	5.500

## Surge suppressors

For contactors	Rated control circuit voltage U <sub>c</sub>		Type	Order code	Pkg qty	Weight (1 pce)	
	V	AC					DC
EK110 ... EK210	24...48	●	-	RC-EH300/48	SK829007-A	1	0.015
	110...415	●	-	RC-EH300/415	SK829007-B	1	0.015
EK370 ... EK1000	48...110	●	-	RC-EH800/110	SK829007-C	1	0.015
EK110 ... EK1000	24...125	-	●	RC-EH800/110	SK829007-C	1	0.015
EK370 ... EK1000	220...600	●	-	RC-EH800/600	SK829007-D	1	0.015

(1) See "Main accessory fitting details" table.

# AF09 ... AF38 4-pole contactors

## Technical data

### Main pole - Utilization characteristics according to IEC

Contactor types	AC / DC operated	AF09	AF16	AF26	AF38
Standards		IEC 60947-1 / 60947-4-1 and EN 60947-1 / 60947-4-1			
Rated operational voltage $U_e$ max.		690 V			
Rated frequency (without derating)		50 / 60 Hz			
Conventional free-air thermal current $I_{th}$					
acc. to IEC 60947-4-1, open contactors, $\theta \leq 40^\circ\text{C}$		35 A	35 A	55 A	55 A
With conductor cross-sectional area		6 mm <sup>2</sup>	6 mm <sup>2</sup>	16 mm <sup>2</sup>	16 mm <sup>2</sup>
<b>AC-1 Utilization category</b>					
For air temperature close to contactor					
<b><math>I_e</math> / Rated operational current AC-1</b>	$\theta \leq 40^\circ\text{C}$	25 A	30 A	45 A	55 A
$U_e$ max. $\leq 690$ V, 50/60 Hz	$\theta \leq 60^\circ\text{C}$	25 A	30 A	40 A	45 A
	$\theta \leq 70^\circ\text{C}$	22 A	26 A	32 A	37 A
With conductor cross-sectional area		4 mm <sup>2</sup>	6 mm <sup>2</sup>	10 mm <sup>2</sup>	16 mm <sup>2</sup>
<b>AC-3 Utilization category</b>					
For air temperature close to contactor $\theta \leq 60^\circ\text{C}$					
<b><math>I_e</math> / Max. rated operational current AC-3 (1)</b>					
	220-230-240 V	9 A	18 A	23.2 A	23.2 A
	380-400 V	9 A	18 A	22 A	22 A
	415 V	9 A	18 A	21.2 A	21.2 A
	440 V	9 A	18 A	20 A	20 A
	500 V	9.5 A	15 A	17.6 A	17.6 A
	690 V	7 A	10.5 A	10.5 A	10.5 A
<b>Rated operational power AC-3 (1)</b>					
	220-230-240 V	2.2 kW	4 kW	5.5 kW	5.5 kW
	380-400 V	4 kW	7.5 kW	11 kW (2)	11 kW (2)
	415 V	4 kW	9 kW	11 kW	11 kW
	440 V	4 kW	9 kW	11 kW	11 kW
	500 V	5.5 kW	9 kW	11 kW	11 kW
	690 V	5.5 kW	9 kW	9 kW	9 kW
<b>Rated making capacity AC-3</b>		10 x $I_e$ AC-3 acc. to IEC 60947-4-1			
<b>Rated breaking capacity AC-3</b>		8 x $I_e$ AC-3 acc. to IEC 60947-4-1			
<b>Short-circuit protection device for contactors</b>					
Without thermal overload relay - Motor protection excluded					
$U_e \leq 500$ V AC - gG type fuse		25 A	32 A	50 A	63 A
<b>Rated short-time withstand current <math>I_{cw}</math></b>					
	1 s	300 A	300 A	450 A	450 A
At 40 °C ambient temperature,	10 s	150 A	150 A	300 A	300 A
in free air from a cold state	30 s	80 A	80 A	225 A	225 A
	1 min	60 A	60 A	150 A	150 A
	15 min	35 A	35 A	55 A	55 A
<b>Power dissipation per pole</b>					
	$I_e$ / AC-1	0.8 W	1.2 W	1.6 W	2.3 W
	$I_e$ / AC-3	0.1 W	0.35 W	0.42 W	0.42 W
<b>Max. electrical switching frequency</b>					
	AC-1	600 cycles/h			
	AC-3	600 cycles/h			

(1) For the corresponding kW/A or hp/A values of 1500 r.p.m. 50 Hz or 1800 r.p.m. 60 Hz, 3-phase motors, see "Motor rated operational powers and currents".

(2) 400V 3-phase motor only.

### Main pole - Utilization characteristics according to UL / CSA

Contactor types	AC / DC operated	AF09	AF16	AF26	AF38
Standards		UL 508, CSA C22.2 N°14			
Max. operational voltage		600 V			
<b>UL / CSA general use rating</b>					
600 V AC		25 A	30 A	45 A	55 A
With conductor cross-sectional area		AWG 10	AWG 10	AWG 8	AWG 6
<b>Max. electrical switching frequency</b>					
For general use		600 cycles/h			

Note: 4-pole contactors fitted with 2 N.O. + 2 N.C. main poles, see "General technical data".



# A45 ... A75, AE, TAE and AF45 ... AF75 4-pole contactors

## Technical data

### Main pole - Utilization characteristics according to IEC

Contactor types	AC operated	A45	A50	A75
	DC operated	AE45	AE50	AE75
		TAE45	TAE50	TAE75
	AC / DC operated	AF45	AF50	AF75
<b>Standards</b>		IEC 60947-1 / 60947-4-1 and EN 60947-1 / 60947-4-1		
<b>Rated operational voltage U<sub>e</sub> max.</b>		1000 V (690 V for AF contactors)		
<b>Rated frequency (without derating)</b>		50 / 60 Hz		
<b>Conventional free-air thermal current I<sub>th</sub></b>				
acc. to IEC 60947-4-1, open contactors, $\theta \leq 40^\circ\text{C}$		100 A	100 A	125 A
With conductor cross-sectional area		35 mm <sup>2</sup>	35 mm <sup>2</sup>	50 mm <sup>2</sup>
<b>AC-1 Utilization category</b>				
For air temperature close to contactor				
<b>I<sub>e</sub> / Rated operational current AC-1</b>	$\theta \leq 40^\circ\text{C}$	70 A	100 A	125 A
U <sub>e</sub> max. $\leq 690\text{ V}$ , 50/60 Hz	$\theta \leq 55^\circ\text{C}$	60 A	85 A	105 A
	$\theta \leq 70^\circ\text{C}$ (2)	50 A	70 A	85 A
With conductor cross-sectional area		25 mm <sup>2</sup>	35 mm <sup>2</sup>	50 mm <sup>2</sup>
<b>AC-3 Utilization category</b>				
For air temperature close to contactor $\theta \leq 55^\circ\text{C}$				
<b>I<sub>e</sub> / Max. rated operational current AC-3 (1)</b>				
	220-230-240 V	40 A	53 A	75 A
	380-400 V	37 A	50 A	75 A
	415 V	37 A	50 A	75 A
	440 V	37 A	45 A	70 A
	500 V	33 A	45 A	65 A
	690 V	25 A	35 A	46 A
	1000 V	-	23 A (3)	28 A (3)
<b>Rated operational power AC-3 (1)</b>				
	220-230-240 V	11 kW	15 kW	22 kW
	380-400 V	18.5 kW	22 kW	37 kW
	415 V	18.5 kW	25 kW	40 kW
	440 V	22 kW	25 kW	40 kW
	500 V	22 kW	30 kW	45 kW
	690 V	22 kW	30 kW	40 kW
	1000 V	-	30 kW (3)	37 kW (3)
<b>Rated making capacity AC-3</b>		10 x I <sub>e</sub> AC-3 acc. to IEC 60947-4-1		
<b>Rated breaking capacity AC-3</b>		8 x I <sub>e</sub> AC-3 acc. to IEC 60947-4-1		
<b>Short-circuit protection device for contactors</b>				
without thermal overload relay - Motor protection excluded				
U <sub>e</sub> $\leq 500\text{ V AC}$ - gG type fuse		80 A	100 A	160 A
<b>Rated short-time withstand current I<sub>cw</sub></b>				
At 40 °C ambient temperature, in free air from a cold state				
	1 s	1000 A		
	10 s	650 A		
	30 s	370 A		
	1 min	250 A		
	15 min	110 A	110 A	135 A
<b>Power dissipation per pole</b>				
	I <sub>e</sub> / AC-1	2.5 W	5 W	7 W
	I <sub>e</sub> / AC-3	0.65 W	1.3 W	2 W
<b>Max. electrical switching frequency</b>				
	AC-1	600 cycles/h (300 for AF, AE, TAE)		
	AC-3	600 cycles/h (300 for AF, AE, TAE)		



3-phase motors



1500 r.p.m. 50 Hz  
1800 r.p.m. 60 Hz  
3-phase motors

(1) For the corresponding kW/A or hp/A values of 1500 r.p.m, 50 Hz or 1800 r.p.m, 60 Hz, 3-phase motors, see "Motor rated operational powers and currents".

(2) Unauthorized for TAE contactors.

(3) AF contactors excluded.

### Main pole - Utilization characteristics according to UL / CSA

Contactor types	AC operated	A45	A50	A75
	DC operated	AE45	AE50	AE75
		TAE45	TAE50	TAE75
	AC / DC operated	AF45	AF50	AF75
<b>Standards</b>		UL 508, CSA C22.2 N°14		
<b>Max. operational voltage</b>		600 V		
<b>UL / CSA general use rating</b>				
600 V AC		65 A	80 A	105 A
With conductor cross-sectional area		AWG 6	AWG 4	AWG 2
<b>Max. electrical switching frequency</b>				
For general use		600 cycles/h (300 for AF, AE, TAE)		

Note: 4-pole contactors fitted with 2 N.O. + 2 N.C. main poles, see "General technical data".

# EK110 ... EK1000 4-pole contactors

## Technical data

### Main pole - Utilization characteristics according to IEC

Contactor types	AC or DC operated	EK110	EK150	EK175	EK210	EK370	EK550	EK1000
Standards		IEC 60947-1 / 60947-4-1 and EN 60947-1 / 60947-4-1						
Rated operational voltage U <sub>e</sub> max.		1000 V						
Rated frequency (without derating)		50 / 60 Hz						
Conventional free-air thermal current I <sub>th</sub>								
acc. to IEC 60947-4-1, open contactors, $\theta \leq 40\text{ °C}$		200 A	250 A	300 A	350 A	550 A	800 A	1000 A
With conductor cross-sectional area		95 mm <sup>2</sup>	150 mm <sup>2</sup>	185 mm <sup>2</sup>	240 mm <sup>2</sup>	2x 185 mm <sup>2</sup>	2x 240 mm <sup>2</sup>	2x 300 mm <sup>2</sup>
<b>AC-1 Utilization category</b>								
For air temperature close to contactor								
<b>I<sub>e</sub> / Rated operational current AC-1</b>	$\theta \leq 40\text{ °C}$	200 A	250 A	300 A	360 A	550 A	800 A	1000 A
U <sub>e</sub> max. $\leq 1000\text{ V}$ , 50/60 Hz	$\theta \leq 55\text{ °C}$	180 A	230 A	270 A	310 A	470 A	650 A	800 A
	$\theta \leq 70\text{ °C}$	155 A	200 A	215 A	250 A	400 A	575 A	720 A
With conductor cross-sectional area		95 mm <sup>2</sup>	150 mm <sup>2</sup>	185 mm <sup>2</sup>	240 mm <sup>2</sup>	2x 185 mm <sup>2</sup>	2x 240 mm <sup>2</sup>	2x 300 mm <sup>2</sup>
<b>AC-3 Utilization category</b>								
For air temperature close to contactor $\theta \leq 55\text{ °C}$								
<b>I<sub>e</sub> / Max. rated operational current AC-3 (1)</b>								
	<b>220-230-240 V</b>	120 A	145 A	210 A	210 A	400 A	550 A	-
	<b>380-400 V</b>	120 A	145 A	210 A	210 A	400 A	550 A	-
	<b>415 V</b>	120 A	145 A	210 A	210 A	400 A	550 A	-
	<b>440 V</b>	120 A	145 A	210 A	210 A	370 A	550 A	-
	<b>500 V</b>	120 A	145 A	210 A	210 A	370 A	550 A	-
	<b>690 V</b>	120 A	120 A	210 A	210 A	370 A	550 A	-
	<b>1000 V</b>	64 A	80 A	113 A	113 A	155 A	175 A	-
<b>Rated operational power AC-3 (1)</b>								
	<b>220-230-240 V</b>	30 kW	45 kW	59 kW	59 kW	110 kW	160 kW	-
	<b>380-400 V</b>	55 kW	75 kW	110 kW	110 kW	200 kW	280 kW	-
	<b>415 V</b>	55 kW	75 kW	110 kW	110 kW	220 kW	315 kW	-
	<b>440 V</b>	59 kW	75 kW	110 kW	110 kW	220 kW	315 kW	-
	<b>500 V</b>	75 kW	90 kW	132 kW	132 kW	250 kW	400 kW	-
	<b>690 V</b>	110 kW	110 kW	160 kW	160 kW	355 kW	500 kW	-
	<b>1000 V</b>	90 kW	110 kW	160 kW	160 kW	220 kW	250 A	-
<b>Rated making capacity AC-3</b>		10 x I <sub>e</sub> AC-3 acc. to IEC 60947-4-1						
<b>Rated breaking capacity AC-3</b>		8 x I <sub>e</sub> AC-3 acc. to IEC 60947-4-1						
<b>Short-circuit protection device for contactors</b>								
without thermal overload relay - Motor protection excluded								
U <sub>e</sub> $\leq 500\text{ V AC}$ - gG type fuse		250 A	250 A	355 A	355 A	630 A	800 A	1000 A
<b>Rated short-time withstand current I<sub>cw</sub></b>								
at 40 °C ambient temperature,	<b>1 s</b>	1700 A	1800 A	2300 A	2300 A	5500 A	5500 A	6800 A
in free air from a cold state	<b>10 s</b>	900 A	1200 A	1680 A	1680 A	5300 A	5300 A	6400 A
	<b>30 s</b>	600 A	700 A	1000 A	1000 A	3700 A	3700 A	4400 A
	<b>1 min</b>	450 A	550 A	800 A	800 A	3000 A	3000 A	3400 A
	<b>15 min</b>	210 A	250 A	320 A	320 A	1000 A	1000 A	1200 A
<b>Maximum breaking capacity</b>								
cos $\phi = 0.45$	<b>at 440 V</b>	1400 A	1500 A	2000 A	2000 A	5000 A	5400 A	-
(cos $\phi = 0.35$ for I <sub>e</sub> > 100 A)	<b>at 690 V</b>	1100 A	1200 A	1700 A	1700 A	5000 A	5400 A	-
<b>Power dissipation per pole</b>								
	<b>I<sub>e</sub> / AC-1</b>	10 W	13 W	18 W	18 W	40 W	60 W	80 W
	<b>I<sub>e</sub> / AC-3</b>	3 W	5 W	9 W	9 W	15 W	25 W	-
<b>Max. electrical switching frequency</b>								
	<b>AC-1</b>	300 cycles/h						
	<b>AC-3</b>	300 cycles/h						
	<b>AC-2, AC-4</b>	150 cycles/h		120 cycles/h				



3-phase motors



1500 r.p.m. 50 Hz  
1800 r.p.m. 60 Hz  
3-phase motors

### Main pole - Utilization characteristics according to UL / CSA

Contactor types	AC or DC operated	EK110	EK150	EK175	EK210	EK370	EK550	EK1000
Standards		UL 508, CSA C22.2 N°14						
Max. operational voltage		600 V						
UL / CSA general use rating								
600 V AC		170 A	200 A	250 A	300 A	420 A	540 A	-
<b>Short-circuit protection device for contactors</b>								
without thermal overload relay - Motor protection excluded								
Fuse rating		400 A				1200 A		
Fuse type, 600 V		J				L		
<b>Max. electrical switching frequency</b>								
For general use		300 cycles/h						

(1) For the corresponding kW/A or hp/A values of 1500 r.p.m, 50 Hz or 1800 r.p.m, 60 Hz, 3-phase motors, see "Motor rated operational powers and currents".

# AF09 ... AF38 4-pole contactors

## Technical data

### Magnet system characteristics

Contactor types	AC / DC operated	AF09	AF16	AF26	AF38
Coil operating limits acc. to IEC 60947-4-1	AC supply	At $\theta \leq 60^\circ\text{C}$ $0.85 \times U_c \text{ min} \dots 1.1 \times U_c \text{ max.}$ At $\theta \leq 70^\circ\text{C}$ $0.85 \times U_c \text{ min} \dots U_c \text{ max.}$			
	DC supply	At $\theta \leq 60^\circ\text{C}$ $0.85 \times U_c \text{ min} \dots 1.1 \times U_c \text{ max.}$ At $\theta \leq 70^\circ\text{C}$ (AF) $0.85 \times U_c \text{ min} \dots U_c \text{ max.}$ - (AF.Z) $0.85 \times U_c \text{ min} \dots 1.1 \times U_c \text{ max.}$			
AC control voltage 50/60 Hz		24...500 V AC			
Rated control circuit voltage $U_c$		24...500 V AC			
Coil consumption	Average pull-in value	(AF) 50 VA - (AF.Z) 16 VA			
	Average holding value	(AF) 2.2 VA / 2 W - (AF.Z) 1.7 VA / 1.5 W			
DC control voltage		12...500 V DC			
Rated control circuit voltage $U_c$		12...500 V DC			
Coil consumption	Average pull-in value	(AF) 50 W - (AF.Z) 12...16 W			
	Average holding value	(AF) 2 W - (AF.Z) 1.7 W			
PLC-output control		(AF.Z) $\geq 500 \text{ mA}$ 24 V DC			
Drop-out voltage		$\leq 60\%$ of $U_c \text{ min.}$			
Voltage sag immunity acc. to SEMI F47-0706		(AF.Z) conditions of use on request			
Dips withstand $-20^\circ\text{C} \leq \theta \leq +60^\circ\text{C}$		(AF.Z) 22 ms average for $U_c \geq 24 \text{ V}$ 50/60 Hz or $U_c \geq 20 \text{ V}$ DC			
Operating time					
Between coil energization and:	N.O. contact closing	40...95 ms			
	N.C. contact opening	38...90 ms			
Between coil de-energization and:	N.O. contact opening	11...95 ms			
	N.C. contact closing	13...98 ms			

5

### Mounting characteristics and conditions for use

Contactor types	AF09	AF16	AF26	AF38
Mounting positions				
Mounting distances	Max. add-on N.C. auxiliary contacts: see accessory fitting details for a 4-pole contactor AF09 ... AF38			
Fixing	The contactors can be assembled side by side			
On rail according to IEC 60715, EN 60715	35 x 7.5 mm or 35 x 15 mm			
By screws (not supplied)	2 x M4 screws placed diagonally			

# A45 ... A75 4-pole contactors

## Technical data

### Magnet system characteristics

Contactor types		AC operated	A45	A50	A75
Coil operating limits acc. to IEC 60947-4-1		AC supply	At $\theta \leq 55\text{ °C}$ $0.85...1.1 \times U_c$ Please also refer to "Mounting characteristics and conditions for use"		
AC control voltage					
Rated control circuit voltage $U_c$		at 50 Hz	24...690 V		
		at 60 Hz	24...690 V		
Coil consumption	Average pull-in value	50 Hz	180 VA		
		60 Hz	210 VA		
		50/60 Hz (1)	190 VA / 180 VA		
Average holding value		50 Hz	18 VA / 5.5 W		
		60 Hz	18 VA / 5.5 W		
		50/60 Hz (1)	18 VA / 5.5 W		
Drop-out voltage			approx. 40...65 % of $U_c$		
Operating time					
Between coil energization and:		N.O. contact closing	8...27 ms		
		N.C. contact opening	7...22 ms		
Between coil de-energization and:		N.O. contact opening	4...11 ms		
		N.C. contact closing	7...14 ms		

(1) 50/60 Hz coils: see "Coil voltage code table".

### Mounting characteristics and conditions for use

Contactor types		AC operated	A45	A50	A75
Mounting positions					
Control voltage / Ambient temperature			Pos. 5 unauthorized for A45-22-00, A75-22-00 Max. add-on N.O. or N.C. auxiliary contacts: see accessory fitting details for 4-pole contactor A45 ... A75		
Mounting positions (1)	1, $1 \pm 30^\circ$ , 2, 3, 4, 5	at $\theta \leq 55\text{ °C}$	$0.85...1.1 \times U_c$		
		at $\theta \leq 70\text{ °C}$	$U_c$		
	6	at $\theta \leq 55\text{ °C}$	$0.95...1.1 \times U_c$		
		at $\theta \leq 70\text{ °C}$	Unauthorized		
Mounting distances			The contactors can be assembled side by side		
Fixing					
On rail according to IEC 60715, EN 60715			35 x 15 mm or 75 x 25 mm		
By screws (not supplied)			2 x M6 screws placed diagonally		

(1) For 60 Hz coil voltage: (only for devices fitted with CA 5... and CAL 5-11 auxiliary contacts or TP timer).

– A45-40-00, A50-40-00 and A75-40-00 contactors.

– Mounting positions 1 to 5 and ambient temperature  $\leq 55\text{ °C}$ : tolerance reduced to  $0.9...1.1 U_c$  (instead of  $0.85...1.1 U_c$ ) for coil voltage codes 70 to 79 and 80 to 89.

– A45-22-00 and A75-22-00 contactors.

– Mounting positions 1 to 4 and ambient temperature  $\leq 55\text{ °C}$ : tolerance reduced to  $0.9...1.1 U_c$  (instead of  $0.85...1.1 U_c$ ) for coil voltage codes 70 to 79 and 80 to 89.

For mounting position 6 or ambient temperature of 55 to 70 °C the information given on this page remains applicable.

# AE45 ... AE75 4-pole contactors

## Technical data

### Magnet system characteristics

Contactor types	DC operated	AE45	AE50	AE75
<b>Coil operating limits</b> acc. to IEC 60947-4-1	DC supply	At $\theta \leq 55\text{ °C}$ $0.85 \dots 1.1 \times U_c$ Please also refer to "Mounting characteristics and conditions for use"		
<b>DC control voltage</b>		Rated control circuit voltage $U_c$ 12...250 V DC		
	Average pull-in value	200 W		
	Average holding value	4 W		
<b>Drop-out voltage</b>		approx. 15...40 % of $U_c$		
<b>Coil time constant</b>				
Open	L/R	3 ms		
Closed	L/R	15 ms		
<b>Operating time</b>				
Between coil energization and:	N.O. contact closing	13...30 ms		
	N.C. contact opening	10...27 ms		
Between coil de-energization and:	N.O. contact opening (1)	5...15 ms		
	N.C. contact closing (1)	8...18 ms		

(1) The use of surge suppressors increases the opening time with a factor of 1.1 to 1.5 for RV5 surge suppressor and a factor of 1.5 to 3 for RT5 surge suppressor.

### Mounting characteristics and conditions for use

Contactor types	DC operated	AE45	AE50	AE75
<b>Mounting positions</b>		<p>Pos. 5 unauthorized for AE45-22-00, AE75-22-00</p>		
<b>Control voltage / Ambient temperature</b>		Max. add-on N.O. or N.C. auxiliary contacts: see accessory fitting details for 4-pole contactor AE45 ... AE75 (1)(2)		
Mounting positions	1, 1±30°, 2, 3, 4, 5	at $\theta \leq 55\text{ °C}$	0.85...1.1 x $U_c$	
		at $\theta \leq 70\text{ °C}$	$U_c$	
	6	at $\theta \leq 55\text{ °C}$	0.95...1.1 x $U_c$	
		at $\theta \leq 70\text{ °C}$	Unauthorized	
<b>Mounting distances</b>		The contactors can be assembled side by side		
<b>Fixing</b>				
On rail according to IEC 60715, EN 60715		35 x 15 mm or 75 x 25 mm		
By screws (not supplied)		2 x M6 screws placed diagonally		

# AF45 ... AF75 4-pole contactors

## Technical data

### Magnet system characteristics

Contactor types	AC / DC operated	AF45	AF50	AF75
Coil operating limits acc. to IEC 60947-4-1	AC or DC supply	At $\theta \leq 70^\circ\text{C}$ $0.85 \times U_c \text{ min} \dots 1.1 \times U_c \text{ max}$ . Please also refer to "Mounting characteristics and conditions for use"		
<b>AC control voltage 50/60 Hz</b>				
Rated control circuit voltage $U_c$		48...250 V		
Coil consumption	Average pull-in value	210 VA		
	Average holding value	7 VA / 2.8 W		
<b>DC control voltage</b>				
Rated control circuit voltage $U_c$		20...250 V DC		
Coil consumption	Average pull-in value	190 W		
	Average holding value	2.8 W		
Drop-out voltage		55 % of $U_c$ min.		
Voltage sag immunity acc. to SEMI F47		Conditions of use on request		
Dips withstand		$\geq 20$ ms		
<b>Operating time</b>				
Between coil energization and:	N.O. contact closing	30...100 ms		
	N.C. contact opening	27...95 ms		
Between coil de-energization and:	N.O. contact closing	30...110 ms		
	N.C. contact opening	35...115 ms		

### Mounting characteristics and conditions for use

Contactor types	AC / DC operated	AF45	AF50	AF75
Mounting positions		<p>Pos. 5 unauthorized for AF45-22-00, AF75-22-00 contactors Max. and add-on N.O. or N.C. auxiliary contacts: see accessory fitting details for 4-pole contactor AF45 ... AF110</p>		
<b>Control voltage / Ambient temperature</b>				
Mounting positions	1, $1 \pm 30^\circ$ , 2, 3, 4, 5 6	at $\theta \leq 70^\circ\text{C}$	$0.85 \times U_c \text{ min} \dots 1.1 \times U_c \text{ max}$ . Unauthorized	
Mounting distances		The contactors can be assembled side by side		
<b>Fixing</b>				
On rail according to IEC 60715, EN 60715		35 x 15 mm or 75 x 25 mm		
By screws (not supplied)		2 x M6 screws placed diagonally		

# TAE45 ... TAE75 4-pole contactors

## Technical data

### Magnet system characteristics

Contactor types	DC Operated	TAE45	TAE50	TAE75
<b>Coil operating limits</b> acc. to IEC 60947-4-1	DC supply	At $\theta \leq 55^\circ\text{C}$ $U_c \text{ min} \dots U_c \text{ max}$ Please also refer to "Mounting characteristics and conditions for use"		
<b>DC control voltage</b>		17...264 V DC		
Rated control circuit voltage $U_c$		17...264 V DC		
Coil consumption	<b>Average pull-in value</b>	120...250 W		
	<b>Average holding value</b>	1.7...6.5 W		
<b>Drop-out voltage</b>		approx. 10...35 % of $U_c \text{ max}$ .		
<b>Coil time constant</b>				
Open	L/R	3 ms		
Closed	L/R	15 ms		
<b>Operating time</b>				
Between coil energization and:	<b>N.O. contact closing</b>	13...30 ms		
	<b>N.C. contact opening</b>	10...27 ms		
Between coil de-energization and:	<b>N.O. contact closing (1)</b>	5...15 ms		
	<b>N.C. contact opening (1)</b>	8...18 ms		

(1) The use of surge suppressors increases the opening time with a factor of 1.1 to 1.5 for a varistor suppressor and a factor of 1.5 to 3 for a diode suppressor.

### Mounting characteristics and conditions for use

Contactor types	DC Operated	TAE45	TAE50	TAE75
<b>Mounting positions</b>				
<b>Control voltage / Ambient temperature</b>		Max. add-on N.O. or N.C. auxiliary contacts: see accessory fitting details for 4-pole contactor TAE45 ... TAE75		
Mounting positions	1, $1 \pm 30^\circ$ , 2, 3, 4, 5	at $\theta \leq 55^\circ\text{C}$ $U_c \text{ min} \dots U_c \text{ max}$		
		at $\theta \leq 70^\circ\text{C}$ unauthorized		
	6	unauthorized		
<b>Mounting distances</b>		The contactors can be assembled side by side		
<b>Fixing</b>				
On rail according to IEC 60715, EN 60715		35 x 15 mm or 75 x 25 mm		
By screws (not supplied)		2 x M6 screws placed diagonally		

# EK110 ... EK1000 4-pole contactors

## Technical data

### Magnet system characteristics

Contactor types	AC operated	EK110	EK150	EK175	EK210	EK370	EK550	EK1000
<b>Coil operating limits</b> acc. to IEC 60947-4-1	AC supply	At $\theta \leq 70^\circ\text{C}$ $0.85 \times U_c \text{ min} \dots 1.1 \times U_c \text{ max}$ . Please also refer to "Mounting characteristics and conditions for use"						
<b>AC control voltage</b>								
Rated control circuit voltage	50 Hz	24...500 V				48...500 V		
	60 Hz	24...600 V				110...600 V		
Coil consumption	Average pull-in value	50 Hz	800 VA		1100 VA		3500 VA	
		60 Hz	900 VA		1200 VA		4000 VA	
	Average holding value	50/60 Hz (1)	500 / 500 VA		630 / 630 VA		3800 / 3400 VA	
		50 Hz	44 VA / 15 W		52 VA / 18 W		125 VA / 50 W	
	60 Hz	52 VA / 18 W		65 VA / 22 W		140 VA / 60 W		
	50/60 Hz (1)	2.5 VA / 2.5 W		2.5 VA / 2.5 W		140 VA / 60 W		
<b>Drop-out voltage in % of <math>U_c</math> min.</b>		approx. 45...65 % (20...50 % for "E" coil voltage codes)					approx. 45...65 %	
<b>Operating time</b>								
Between coil energization and:	N.O. contact closing	20...40 (1) / 30...50 (2) ms					30...60 ms	
	N.C. contact opening	15...35 (1) / 25...45 (2) ms					25...55 ms	
Between coil de-energization and:	N.O. contact opening	7.5...15 (1) / 95...120 (2) ms					10...20 ms	
	N.C. contact closing	10...18 (1) / 100...125 (2) ms					13...23 ms	

(1) "A" coil voltage: see "Coil voltage code table".

(2) 50/60 Hz "E" coil voltage codes, see "Coil voltage code table".

### Magnet system characteristics

Contactor types	DC operated	EK110	EK150	EK175	EK210	EK370	EK550	EK1000
<b>Coil operating limits</b> acc. to IEC 60947-4-1	DC supply	At $\theta \leq 70^\circ\text{C}$ $0.85 \times U_c \text{ min} \dots 1.1 \times U_c \text{ max}$ . Please also refer to "Mounting characteristics and conditions for use"						
<b>DC control voltage</b>								
Rated control circuit voltage		12...220				24...220		
Coil consumption	Average pull-in value	500 W		630 W		1100 W		
	Average holding value	2.5 W		2.5 W		20 W		
<b>Drop-out voltage</b>		approx. 15...50 % of $U_c$ min.						
<b>Coil time constant</b>								
Open	L/R	8 ms				12 ms		
Closed	L/R	50 ms				60 ms		
<b>Operating time</b>								
Between coil energization and:	N.O. contact closing	30...50 ms				60...80 ms		
	N.C. contact opening	27...47 ms				55...75 ms		
Between coil de-energization and:	N.O. contact opening	10...35 ms				13...38 ms		
	N.C. contact closing	13...38 ms						

### Mounting characteristics and conditions for use

Contactor types	AC / DC operated	EK110	EK150	EK175	EK210	EK370	EK550	EK1000
<b>Mounting positions</b>								
		Max. N.O. or N.C. built-in and add-on N.O. or N.C. auxiliary contacts: see accessory fitting details for 4-pole contactor EK110 ... EK1000						
<b>Control voltage / Ambient temperature</b>								
Mounting positions	1, 1±30°, 2, 3, 4, 5	at $\theta \leq 70^\circ\text{C}$		0.85...1.1 x $U_c$				
	2	at $\theta \leq 70^\circ\text{C}$		Unauthorized		0.85...1.1 x $U_c$		
	6	at $\theta \leq 70^\circ\text{C}$		Unauthorized				
<b>Mounting distances</b>		The contactors can be assembled side by side						
<b>Fixing</b>								
On rail according to IEC 60715, EN 60715		-						
By screws (supplied)		4 x M6				4 x M6 (1)		

(1) Damping elements are supplied.



# AF09 ... AF38 4-pole contactors

## Technical data

### General technical data

Contactor types	AC / DC operated	AF09	AF16	AF26	AF38		
<b>Rated insulation voltage <math>U_i</math></b>							
acc. to IEC 60947-4-1		690 V					
acc. to UL / CSA		600 V					
<b>Rated impulse withstand voltage <math>U_{imp}</math></b>							
		6 kV					
<b>Electromagnetic compatibility</b>							
		Devices complying with IEC 60947-1 / EN 60947-1 - Environment A					
<b>Ambient air temperature close to contactor</b>							
Operation		-40...+70 °C					
Storage		-60...+80 °C					
<b>Climatic withstand</b>							
<b>Maximum operating altitude (without derating)</b>		3000 m					
<b>Mechanical durability</b>							
Number of operating cycles		10 millions operating cycles					
Max. switching frequency		3600 cycles/h					
<b>Shock withstand</b>							
acc. to IEC 60068-2-27 and EN 60068-2-27							
Mounting position 1							
		<b>Shock direction</b>					
		1/2 sinusoidal shock for 11 ms: no change in contact position, closed or open position					
		<b>4 N.O. Main poles</b>					
		<b>A</b>		30 g			
		<b>B1</b>		25 g closed position / 5 g open position			
		<b>B2</b>		15 g			
		<b>C1</b>		25 g			
		<b>C2</b>		25 g			
		<b>2 N.O. + 2 N.C. Main poles</b>		<b>A</b>		30 g closed position / 25 g open position	
				<b>B1</b>		25 g closed position / 5 g open position	
		<b>B2</b>		15 g closed position / 10 g open position			
		<b>C1</b>		25 g closed position / 20 g open position			
		<b>C2</b>		25 g closed position / 20 g open position			
<b>Vibration withstand</b>							
acc. to IEC 60068-2-6		5...300 Hz					
		4 g closed position / 2 g open position					

5

### Remark for 4-pole contactors fitted with 2 N.O. + 2 N.C. main poles

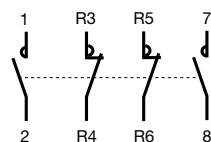

These contactors are suitable for controlling 2 separate circuits, i.e. 2 loads with 2 separate supplies, or 1 circuit comprising 2 separate loads with a single supply (see diagrams below). When the contactor operates there is no mechanical overlapping between the N.O. poles and the N.C. poles: BREAK before MAKE.



These contactors are not suitable for a reversing starter or for controlling a single load from 2 separate supplies.

### Block diagrams

– Single supply and 2 separate loads

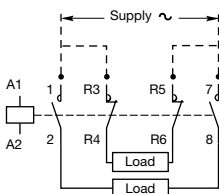

– 2 separate supplies and 2 separate loads

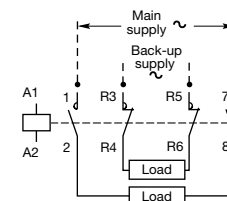

# A45 ... A75, AE, TAE and AF45 ... AF75 4-pole contactors

## Technical data

### General technical data

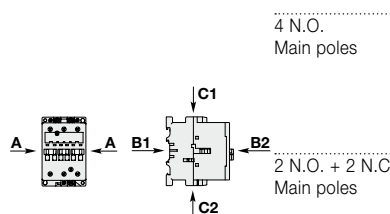
Contactor types	AC operated	A45	A50	A75
	DC operated	AE45	AE50	AE75
		TAE45	TAE50	TAE75
	AC / DC operated	AF45	AF50	AF75
Rated insulation voltage $U_i$	acc. to IEC 60947-4-1	1000 V		
	acc. to UL / CSA	600 V		
Rated impulse withstand voltage $U_{imp}$		8 kV		
Electromagnetic compatibility		AF contactors complying with IEC 60947-1 / EN 60947-1 - Environment A		
Ambient air temperature close to contactor	Operation	-40...+70 °C (1)		
	Storage	-60...+80 °C		
Climatic withstand		acc. to IEC 60068-2-30 and 60068-2-11 - UTE C 63-100 specification II		
Maximum operating altitude (without derating)		3000 m		
Mechanical durability	Number of operating cycles	10 millions operating cycles (5 millions for AE... and TAE... contactors)		
	Max. switching frequency	3600 cycles/h (300 for AF...)		
Shock withstand	acc. to IEC 60068-2-27 and EN 60068-2-27			
Mounting position 1	Shock direction	1/2 sinusoidal shock for 11 ms: no change in contact position, closed or open position		
	A	20 g		
	B1	10 g closed position / 5 g open position		
	B2	15 g		
	C1	20 g		
	C2	20 g		
	A	20 g		
	B1	10 g closed position / 5 g open position (2)		
	B2	15 g (3)		
	C1	20 g		
	C2	20 g		

(1) 55 °C max. for TAE... contactors.

(2) 3 g in open position for AF 45-22, AE 45-22, AF 75-22 and AE 75-22.

(3) 10 g for AF 45-22, AE 45-22, AF 75-22 and AE 75-22.

### Remark for 4-pole contactors fitted with 2 N.O. + 2 N.C. main poles

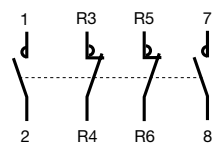

These contactors are suitable for controlling 2 separate circuits, i.e. 2 loads with 2 separate supplies, or 1 circuit comprising 2 separate loads with a single supply (see diagrams below). When the contactor operates there is no mechanical overlapping between the N.O. poles and the N.C. poles: BREAK before MAKE.



These contactors are not suitable for a reversing starter or for controlling a single load from 2 separate supplies.

### Block diagrams

– Single supply and 2 separate loads

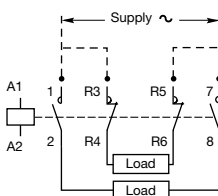

– 2 separate supplies and 2 separate loads

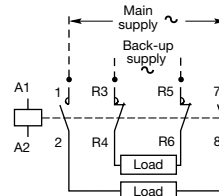

# EK110 ... EK1000 4-pole contactors

## Technical data



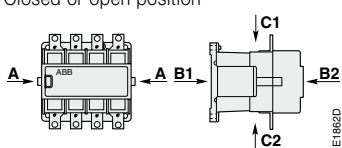





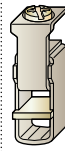

### General technical data

Contactor types	AC or DC operated	EK110	EK150	EK175	EK210	EK370	EK550	EK1000
<b>Rated insulation voltage Ui</b>								
acc. to IEC 60947-4-1		1000 V						
acc. to UL		600 V						
<b>Rated impulse withstand voltage Uimp.</b>		8 kV						
<b>Electromagnetic compatibility</b>		EK contactors complying with IEC 60947-1 / EN 60947-1 - Environment A						
<b>Ambient air temperature close to contactor</b>								
Operation	Fitted with thermal overload relay	-25 to +55 °C					-	
	Without thermal overload relay	-40 to +70 °C					-	
Storage		-50 to +70 °C					-	
<b>Climatic withstand</b>		Category B acc. to IEC 60068-2-30						
<b>Maximum operating altitude (without derating)</b>		≤ 3000 m						
<b>Mechanical durability</b>								
Number of operating cycles		10 millions operating cycles				5 millions operating cycles		3 millions operating cycles
Max. switching frequency		3600 cycles/h				60 cycles/h		
<b>Shock withstand</b>								
acc. to IEC 60068-2-27 and EN 60068-2-27								
Mounting position 1								
Closed or open position								
		<b>Shock direction</b>		1/2 sinusoidal shock for 15 ms: no change in contact position, closed or open position				
		<b>A</b>		10 g				
		<b>B1</b>		10 g				
		<b>B2</b>		10 g				
		<b>C1</b>		10 g				
		<b>C2</b>		10 g				

# AF09 ... AF38 4-pole contactors

## Technical data











### Connecting characteristics

Contactor types	AF09	AF16	AF26	AF38
<b>Main terminals</b>				
	Screw terminals with cable clamp		Screw terminals with double connector 2 x (5.5 width x 6.8 depth)	
<b>Connection capacity (min. ... max.)</b>				
<b>Main conductors (poles)</b>				
 Rigid Solid ( $\leq 4 \text{ mm}^2$ )	<b>1 x</b>	1...6 mm <sup>2</sup>	1.5...16 mm <sup>2</sup>	
 Rigid Stranded ( $\geq 6 \text{ mm}^2$ )	<b>2 x</b>	1...6 mm <sup>2</sup>	1.5...16 mm <sup>2</sup>	
 Flexible with non insulated ferrule	<b>1 x</b>	0.75...6 mm <sup>2</sup>	1.5...16 mm <sup>2</sup>	
	<b>2 x</b>	0.75...6 mm <sup>2</sup>	1.5...16 mm <sup>2</sup>	
 Flexible with insulated ferrule	<b>1 x</b>	0.75...4 mm <sup>2</sup>	1.5...16 mm <sup>2</sup>	
	<b>2 x</b>	0.75...2.5 mm <sup>2</sup>	1.5...16 mm <sup>2</sup>	
 Bars or lugs	<b>L &lt;</b>	9.6 mm	-	
Connection capacity acc. to UL/CSA	<b>1 or 2 x</b>	AWG 16...10	AWG 16...6	
Stripping length		10 mm	12 mm	
Tightening torque		1.5 Nm / 13 lb.in	2.5 Nm / 22 lb.in	
<b>Auxiliary conductors</b> (coil terminals)				
 Rigid solid	<b>1 x</b>	1...2.5 mm <sup>2</sup>		
	<b>2 x</b>	1...2.5 mm <sup>2</sup>		
 Flexible with non insulated ferrule	<b>1 x</b>	0.75...2.5 mm <sup>2</sup>		
	<b>2 x</b>	0.75...2.5 mm <sup>2</sup>		
 Flexible with insulated ferrule	<b>1 x</b>	0.75...2.5 mm <sup>2</sup>		
	<b>2 x</b>	0.75...1.5 mm <sup>2</sup>		
 Lugs	<b>L &lt;</b>	8 mm		
Connection capacity acc. to UL/CSA	<b>1 or 2 x</b>	AWG 18...14		
Stripping length		10 mm		
Tightening torque		1.2 Nm / 11 lb.in		
<b>Degree of protection</b> acc. to IEC 60947-1 / EN 60947-1 and IEC 60529 / EN 60529				
Main terminals	IP20			
Coil terminals	IP20			
<b>Screw terminals</b>	Delivered in open position, screws of unused terminals must be tightened			
Main terminals		M3.5	M4.5	
	<b>Screwdriver type</b>	Flat Ø 5.5 / Pozidriv 2		
Coil terminals		M3.5		
	<b>Screwdriver type</b>	Flat Ø 5.5 / Pozidriv 2		

# A45 ... A75, AE, TAE and AF45 ... AF75 4-pole contactors

## Technical data

### Connecting characteristics

Contactor types	AC operated	A45	A50	A75
	DC operated	AE45	AE50	AE75
		TAE45	TAE50	TAE75
	AC / DC operated	AF45	AF50	AF75
<b>Main terminals</b>		 <p>Screw terminals with single connector (13 x 10 mm)</p>		
<b>Connection capacity</b> (min. ... max.)				
<b>Main conductors</b> (poles)				
 Rigid Solid ( $\leq 4 \text{ mm}^2$ )	}	1 x	6...50 mm <sup>2</sup>	
 Rigid Stranded ( $\geq 6 \text{ mm}^2$ )		2 x	6...25 mm <sup>2</sup>	
 Flexible with ferrule		1 x	6...35 mm <sup>2</sup>	
 Flexible with ferrule		2 x	6...16 mm <sup>2</sup>	
 Bars or lugs		L $\leq$	-	
		L $>$	-	
Connection capacity acc. to UL/CSA		1 or 2 x	AWG 8...1	
Tightening torque	Recommended		4.00 Nm / 35 lb.in	
	Max.		4.50 Nm	
<b>Auxiliary conductors</b> (built-in auxiliary terminals + coil terminals)				
 Rigid solid		1 x	1...4 mm <sup>2</sup>	
 Rigid solid		2 x	1...4 mm <sup>2</sup>	
 Flexible with ferrule		1 x	1...2.5 mm <sup>2</sup>	
 Flexible with ferrule		2 x	0.75...2.5 mm <sup>2</sup>	
 Lugs		L $\leq$	8 mm	
		L $>$	3.7 mm	
Connection capacity acc. to UL/CSA		1 or 2 x	AWG 18...14	
Tightening torque	Recommended		1.00 Nm / 9 lb.in	
	Max.		1.20 Nm	
<b>Degree of protection</b> acc. to IEC 60947-1 / EN 60947-1 and IEC 60529 / EN 60529				
Main terminals			IP10	
Coil terminals			IP20	
<b>Screw terminals</b>			Delivered in open position, screws of unused terminals must be tightened	
Main terminals			M6	
	<b>Screwdriver type</b>		Flat $\varnothing$ 6.5 / Pozidriv 2	
Coil terminals			M3.5	
	<b>Screwdriver type</b>		Flat $\varnothing$ 5.5 / Pozidriv 2	

# EK110 ... EK1000 4-pole contactors

## Technical data

### Connecting characteristics

Contactor types		AC or DC operated	EK110	EK150	EK175	EK210	EK370	EK550	EK1000
Main terminals									
Flat type									
Connection capacity (min. ... max.)									
Main conductors (poles)									
	Rigid with connector	Cu cable	1 x 25...120 mm <sup>2</sup>	25...185 mm <sup>2</sup>	-	-	70...300 mm <sup>2</sup>	-	-
		Al/Cu cable	1 x 10...70 mm <sup>2</sup>	35...120 mm <sup>2</sup>	-	-	70...300 mm <sup>2</sup>	-	95...300 mm <sup>2</sup>
		Al/Cu cable	2 x -	-	-	-	35...185 mm <sup>2</sup>	-	95...300 mm <sup>2</sup>
	Bars or lugs		L ≤ 30 mm	10 mm	33 mm	55 mm			
			Ø > 6 mm						
Connection capacity acc. to UL/CSA			1 or 2 x AWG 8 - 3 / 0		6 - 250 MCM	2 x 4 - 500 MCM	3 x 4 - 500 MCM	-	-
Tightening torque		Recommended	5 Nm / 44 lb.in	18 Nm / 160 lb.in					
		Max.	6 Nm	22 Nm					
Auxiliary conductors (coil terminals)									
	Rigid solid		1 x 0.5...2.5 mm <sup>2</sup>						
			2 x 0.5...2.5 mm <sup>2</sup>						
	Flexible with ferrule		1 x 0.5...2.5 mm <sup>2</sup>						
			2 x 0.5...2.5 mm <sup>2</sup>						
	Bars or lugs		L ≤ 8 mm						
			l > 3.7 mm						
Connection capacity acc. to UL/CSA			1 or 2 x 18...14 AWG						
Tightening torque		Recommended	1.00 Nm / 9 lb.in						
		Max.	1.20 Nm						
Degree of protection									
acc. to IEC 60947-1 / EN 60947-1 and IEC 60529 / EN 60529									
Main terminals			IP00						
Coil terminals			IP20						
Screw terminals									
Main terminals			M6		M10				
			Screws and bolts						
Coil terminals (delivered in open positions)			M3.5						
Screwdriver type			Flat Ø 5.5 mm / Pozidriv 2						

# Notes

A series of horizontal dotted lines for taking notes, spanning the width of the page.

# 4-pole contactors

## Electrical durability and utilization categories

### General

Utilization categories determine the current making and breaking conditions relating to the characteristics of the loads to be controlled by the contactors. International standard IEC 60947-4-1 and European standard EN 60947-4-1 are the standards to be referred to. If  $I_c$  is the current to be broken by the contactor and  $I_e$  the rated operational current normally drawn by the load, then  $I_c = I_e$  for category AC-1. The curve corresponding to category AC-1 represents the electrical durability variation of standard contactors in relation to the breaking current  $I_c$ .

Electrical durability is expressed in millions of operating cycles.

### Curve utilization mode

#### Electrical durability forecast and contactor selection for category AC-1

- Note the characteristics of the load to be controlled:
  - Operational voltage .....  $U_e$
  - Current normally drawn .....  $I_e$
  - Utilization category ..... AC-1
  - Breaking current .....  $I_c = I_e$  for AC-1
- Define the number of operating cycles  $N$  required.
- On the diagram corresponding to the operational category, select the contactor with the curve immediately above the intersection point ( $I_c ; N$ ).

#### Case of uninterrupted duty

For uninterrupted duty, some verifications of preventing maintenance are necessary to check the functionality of the concerned product (consult us). The combined effect of environmental conditions and the proper temperature of the product may require some disposals. As a matter of fact, for this duty, the use duration prevails over the number of operating cycles.



# 4-pole contactors

## Electrical durability

Electrical durability for AC-1 utilization category -  $U_e \leq 690\text{ V}$   
 Ambient temperature  $\leq 60\text{ }^\circ\text{C}$  for AF09 ... AF38,  $\leq 55\text{ }^\circ\text{C}$  for A45 ... EK1000

Switching non-inductive or slightly inductive loads. The breaking current  $I_c$  for AC-1 is equal to the rated operational current of the load.

Maximum electrical switching frequency: see "Technical data".

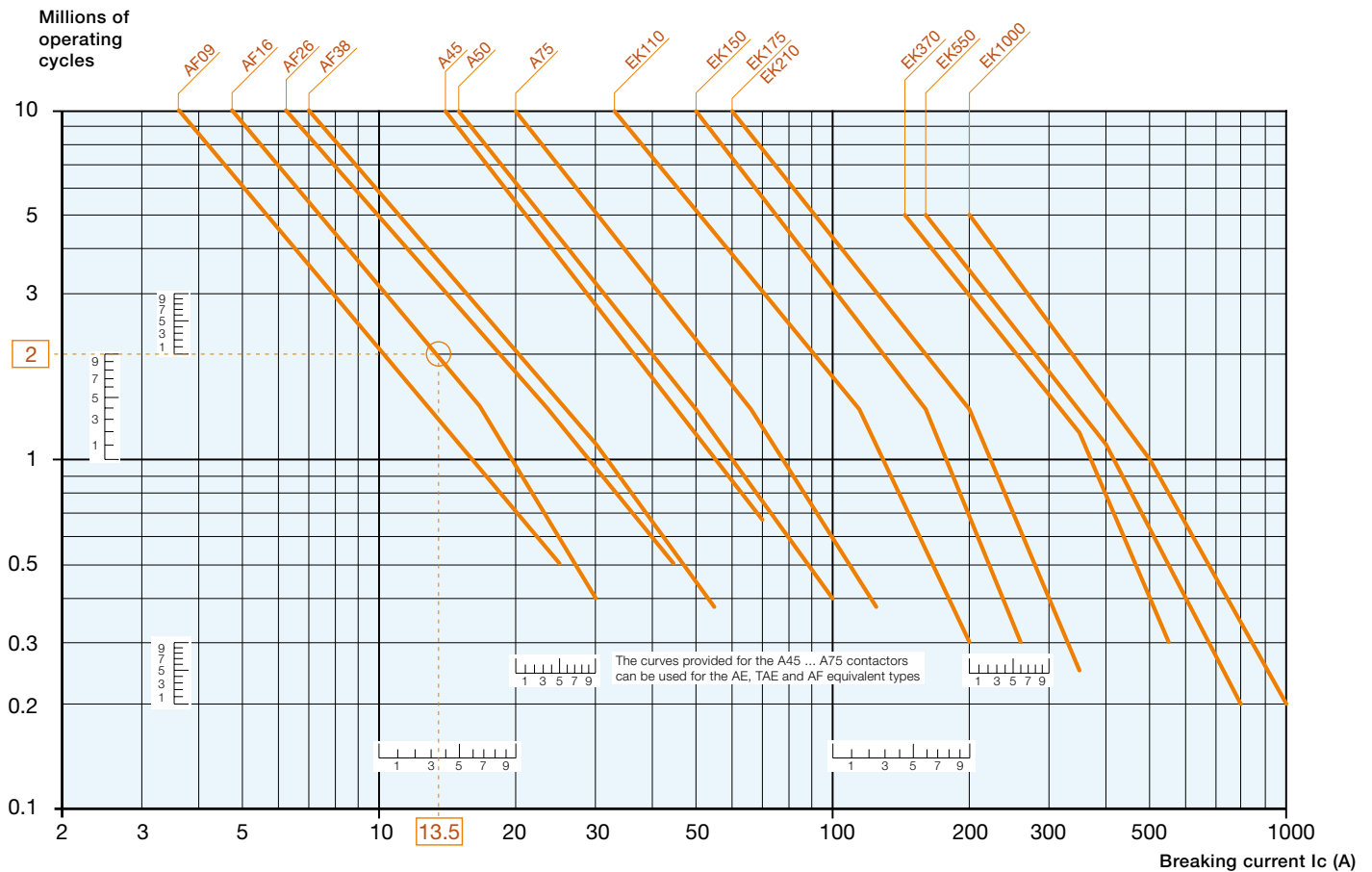

### Example:

$I_c / \text{AC-1} = 13.5\text{ A}$  – Electrical durability required = 2 millions operating cycles.

Using the AC-1 curves above select the AF16 contactor at intersection "○" (13.5 A / 2 millions operating cycles).

# AF09 ... AF38 4-pole contactors

## Terminal marking and positioning

### AF09 ... AF38 contactors - AC / DC operated

Standard devices without addition of auxiliary contacts

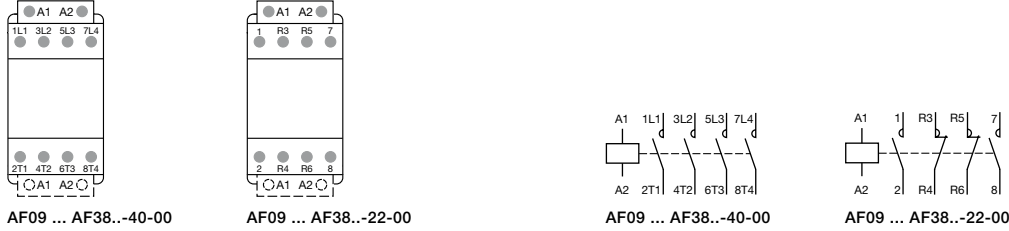

Other possible contact combinations with auxiliary contacts added by the user

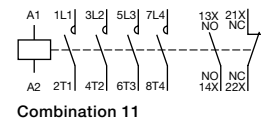
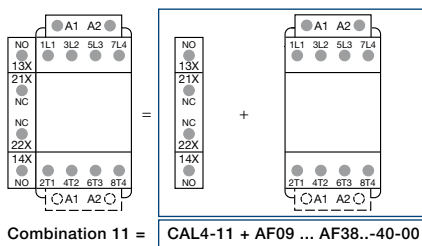
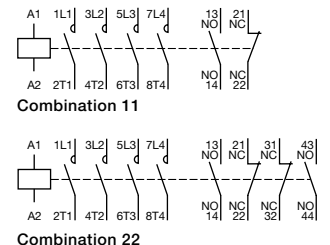
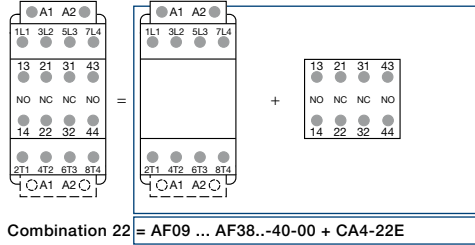
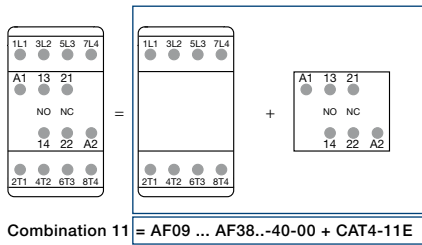
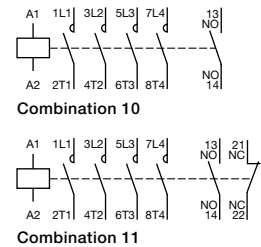
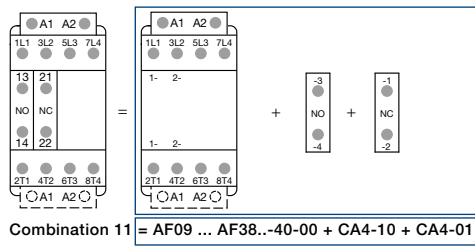
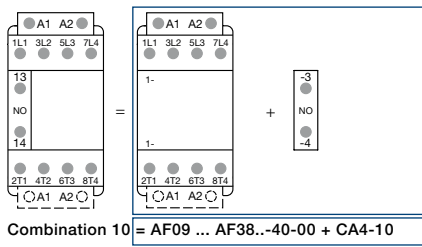

Note: Only AF.Z contactor with DC control voltage 12...20 V DC need to respect the connection polarities indicated close to the coil terminals: A1+ for the positive pole and A2- for the negative pole

# A..., AF..., AL..., AE..., TAE... 4-pole contactors

## Terminal marking and positioning

### A45 ... A75 contactors - AC operated

Standard devices without addition of auxiliary contacts

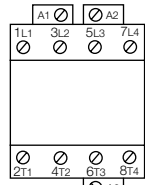

A45 ... A75-40-00

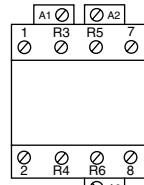

A45/75-22-00

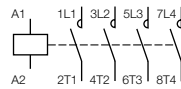

A45 ... A75-40-00

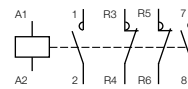

A45/75-22-00

### AF45 ... AF75 contactors - AC / DC operated

Standard devices without addition of auxiliary contacts

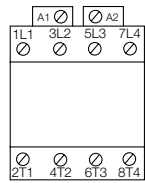

AF45 ... AF75-40-00

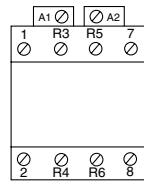

AF45/75-22-00

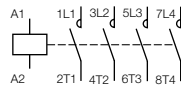

AF45 ... AF75-40-00

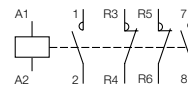

AF45/75-22-00

### AE... and TAE... contactors - DC operated

Standard devices without addition of auxiliary contacts

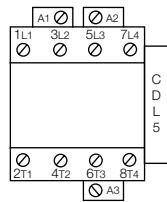

AE45 ... AE75-40-00  
TAE45 ... TAE75-40-00

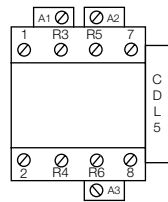

AE45/75-22-00

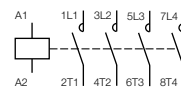

AE45 ... AE75-40-00  
TAE45 ... TAE75-40-00

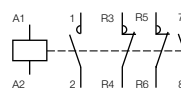

AE45/75-22-00

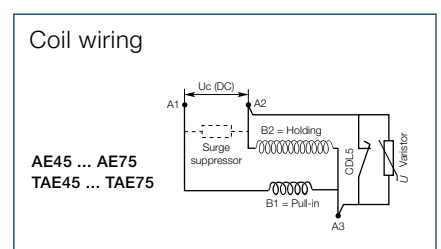

# EK 4-pole contactors

## Terminal marking and positioning

### EK110 ... EK1000 contactors - AC operated

Standard devices

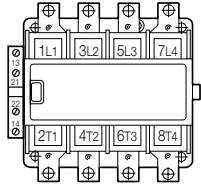

EK110 ... EK1000-40-11

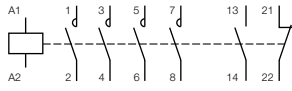

EK110 ... EK1000-40-11

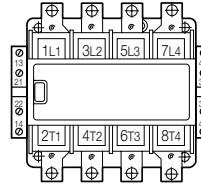

EK110 ... EK1000-40-22

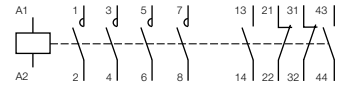

EK110 ... EK1000-40-22

Other possible contact combinations with auxiliary contacts added by the user

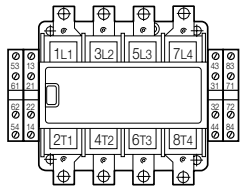

Combination 44

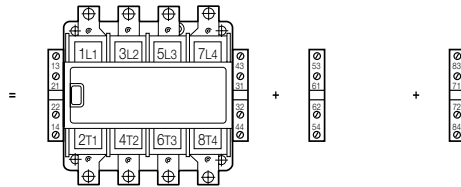

= EK110 ... EK1000-40-22 + CAL16-11C + CAL16-11D

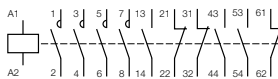

Combination 44

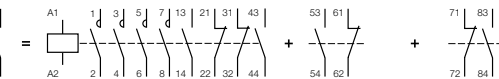

= EK110 ... EK1000-40-22 + CAL16-11C + CAL16-11D

### EK110 ... EK1000 contactors - with multifrequency coil or DC operated

Standard devices

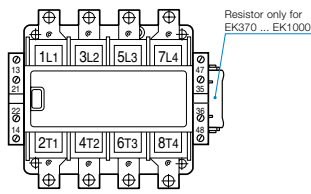

EK110 ... EK1000-40-21

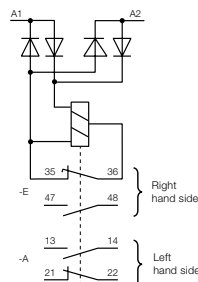

EK110 ... EK210 multifrequency coil

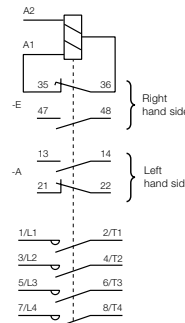

EK110 ... EK210 DC operated

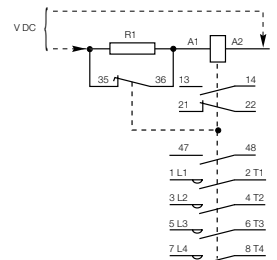

EK370 ... EK1000 DC operated

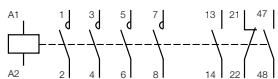

EK110 ... EK1000-40-21

Other possible contact combinations with auxiliary contacts added by the user

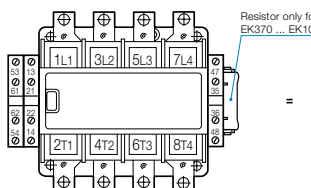

Combination 32

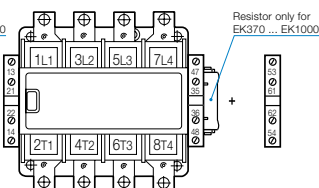

= EK110 ... EK1000-40-21 + CAL16-11C

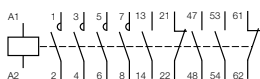

Combination 32



= EK110 ... EK1000-40-21 + CAL16-11C

# Notes

A series of horizontal dotted lines for taking notes, spanning most of the page width.

# AF09, AF16 4-pole contactors

## Main dimensions mm, inches

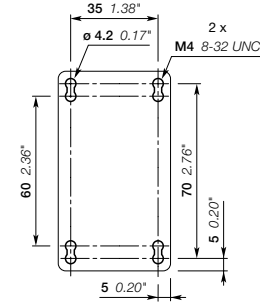
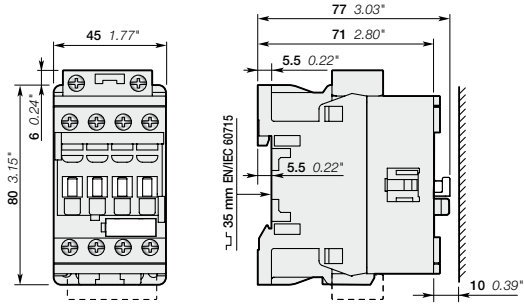

AF09, AF16

AF09, AF16

5

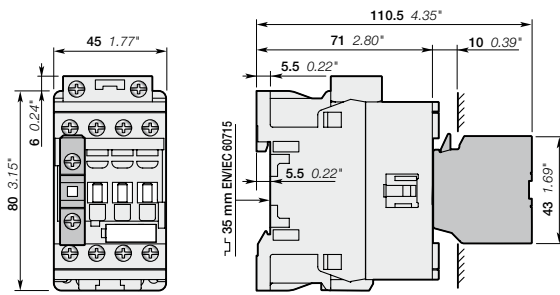

AF09, AF16  
+ CA4, CC4 1-pole auxiliary contact block

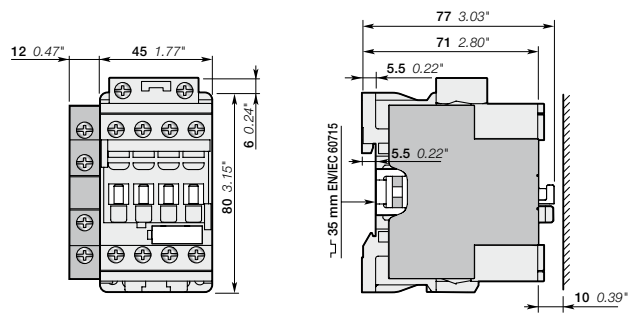

AF09, AF16  
+ CAL4-11 2-pole auxiliary contact block

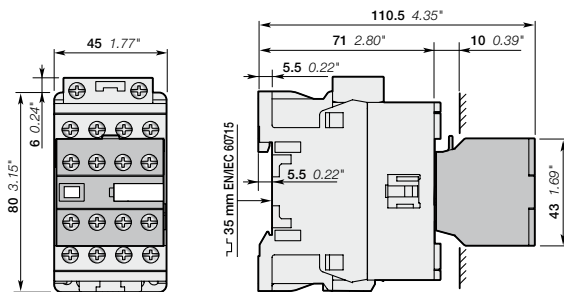

AF09, AF16  
+ CA4 4-pole auxiliary contact block

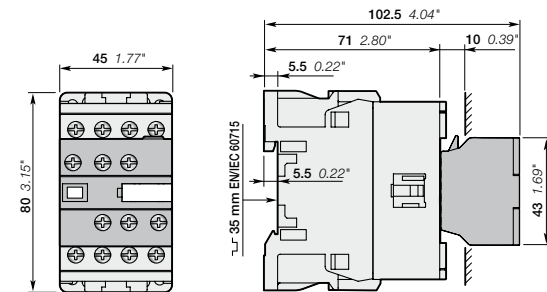

AF09, AF16  
+ CAT4 2-pole auxiliary contact and coil terminal block

Note: contactor lateral distance to grounded component 2 mm 0.08" min.

# AF09, AF16 4-pole contactors

## Main dimensions mm, inches

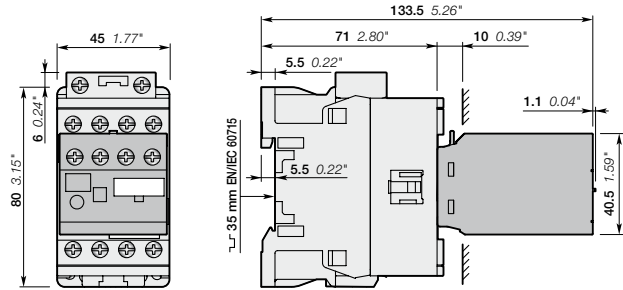

AF09, AF16  
+ TEF4 electronic timer

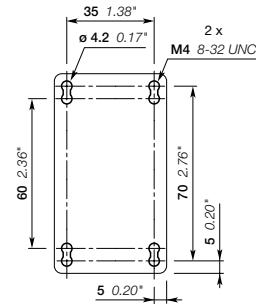

AF09, AF16

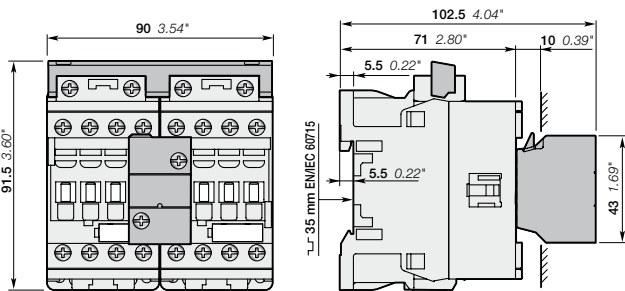

AF09..-40-00, AF16..-40-00  
+ VEM4 mechanical and electrical interlock set

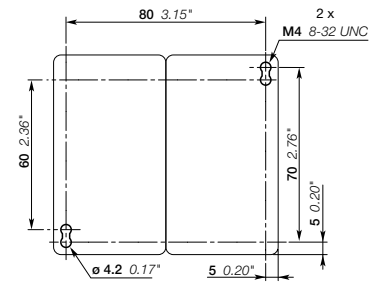

AF09..-40-00, AF16..-40-00  
+ VEM4 mechanical and electrical interlock set

Note: contactor lateral distance to grounded component 2 mm 0.08 inches min.

# AF26, AF38 4-pole contactors

## Main dimensions mm, inches

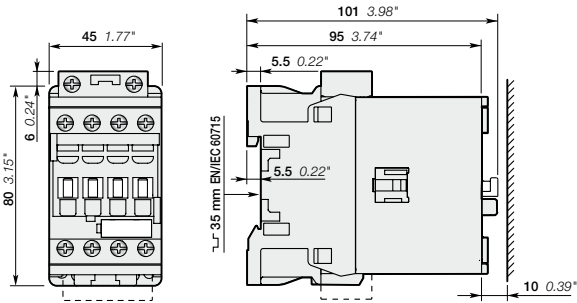

AF26, AF38

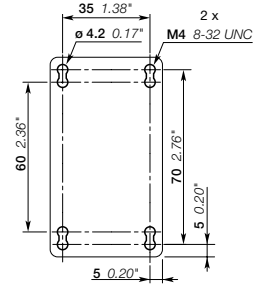

AF26, AF38

5

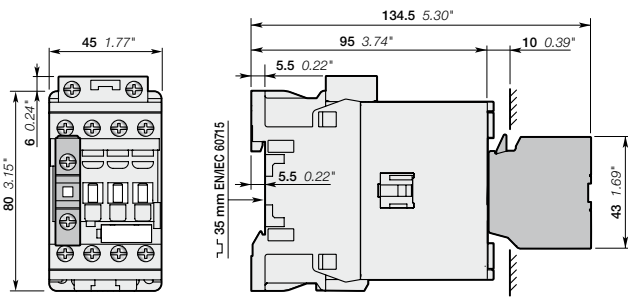

AF26, AF38  
+ CA4, CC4 1-pole auxiliary contact block

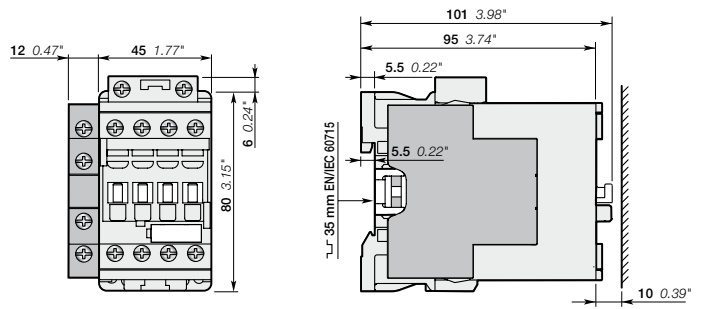

AF26, AF38  
+ CAL4-11 2-pole auxiliary contact block

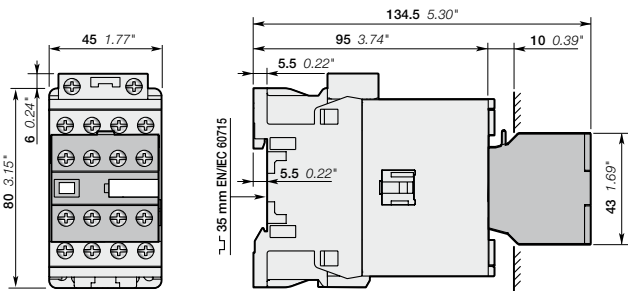

AF26, AF38  
+ CA4 4-pole auxiliary contact block

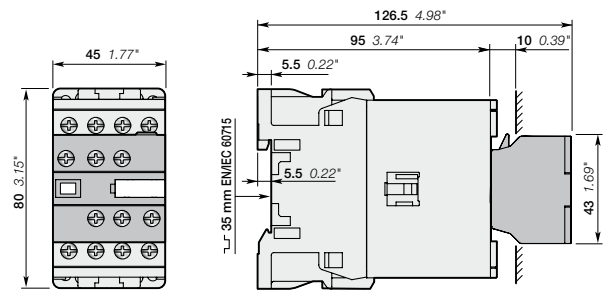

AF26, AF38  
+ CAT4 2-pole auxiliary contact and coil terminal block

Note: contactor lateral distance to grounded component 2 mm 0.08" min.



# AF26, AF38 4-pole contactors

## Main dimensions mm, inches

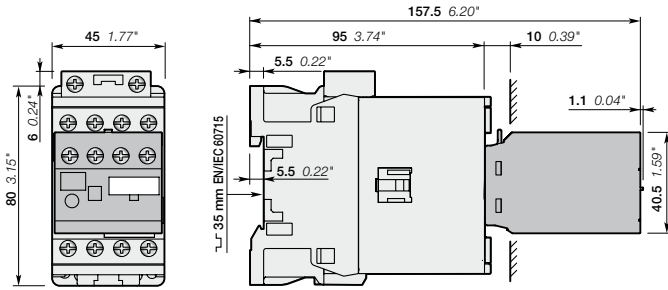

AF26, AF38  
+ TEF4 electronic timer

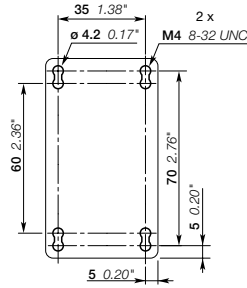

AF26, AF38

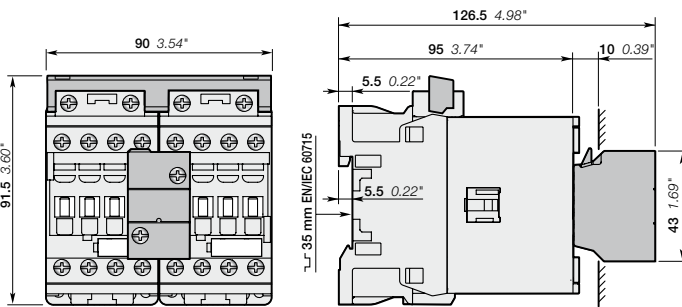

AF26..-40-00, AF38..-40-00  
+ VEM4 mechanical and electrical interlock set

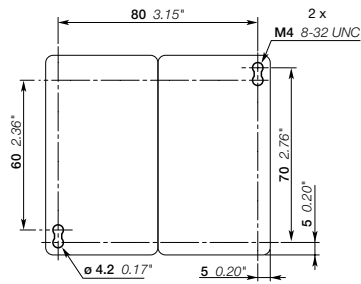

AF26..-40-00, AF38..-40-00  
+ VEM4 mechanical and electrical interlock set

Note: contactor lateral distance to grounded component 2 mm 0.08" min.

# A45, A50 and A75 4-pole contactors AF45, AF50 and AF75 4-pole contactors

## Main dimensions mm, inches

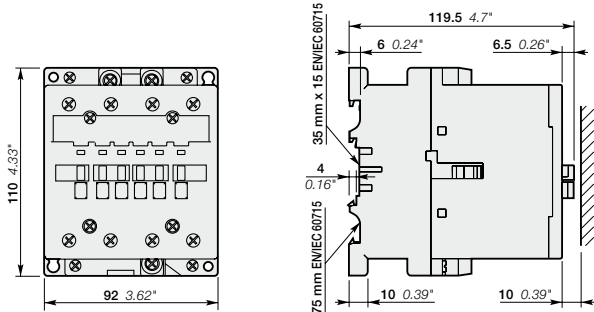

A45, A50, A75, AF45, AF50, AF75

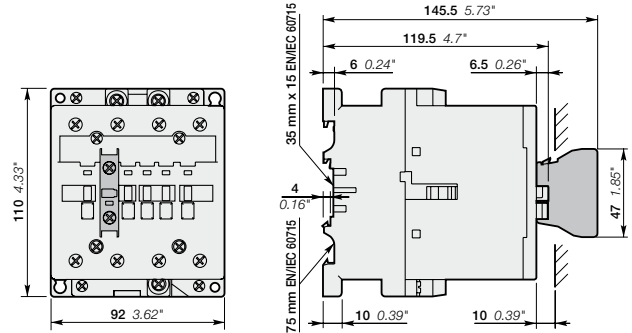

A45, A50, A75, AF45, AF50, AF75  
+ CA5 front-mounted 1-pole auxiliary contact block

5

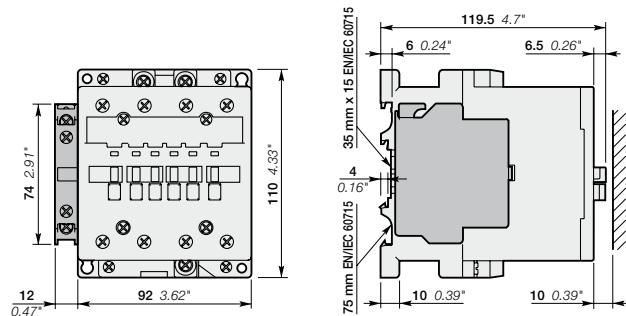

A45, A50, A75, AF45, AF50, AF75  
+ CAL5 side-mounted 2-pole auxiliary contact block

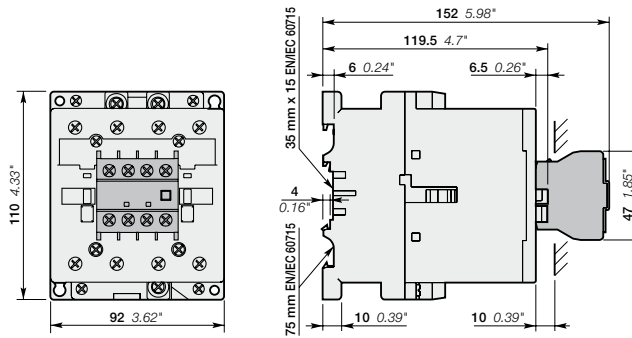

A45, A50, A75, AF45, AF50, AF75  
+ CA5 front-mounted 4-pole auxiliary contact block

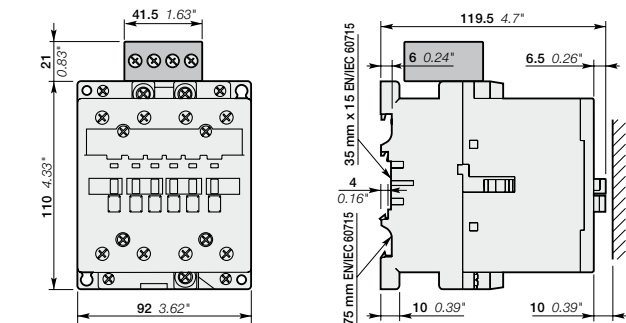

A45, A50, A75, AF45, AF50, AF75  
+ RA5 interface relay

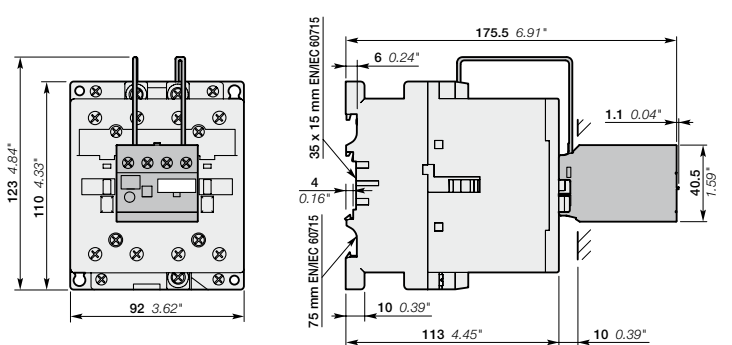

A45, A50, A75, AF45, AF50, AF75  
+ TEF5 electronic timer

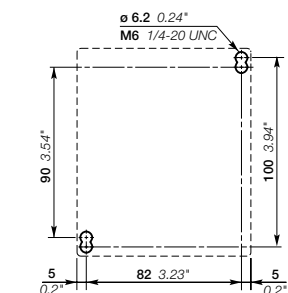

A45, A50, A75, AF45, AF50, AF75

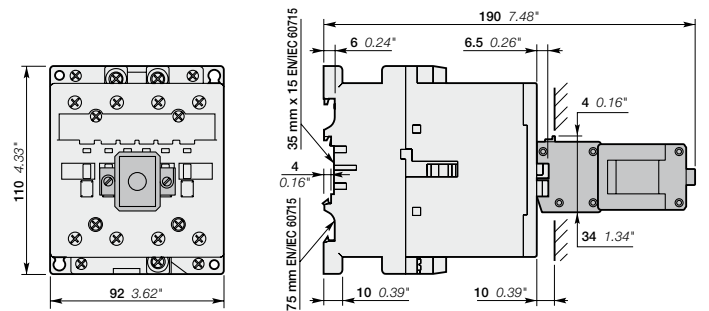

A45, A50, A75, AF45, AF50, AF75  
+ WB75-A on-position latch

# A45, A50 and A75 4-pole contactors AF45, AF50 and AF75 4-pole contactors

## Main dimensions mm, inches

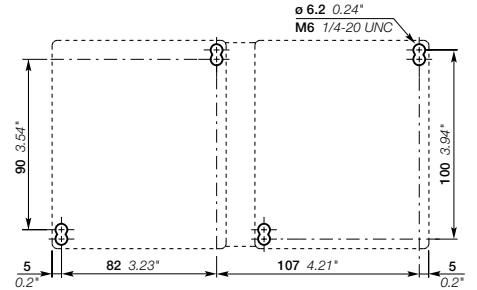
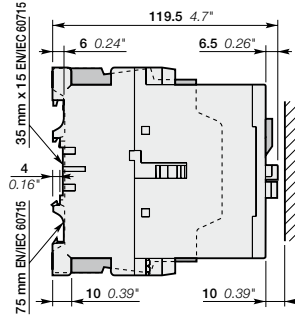
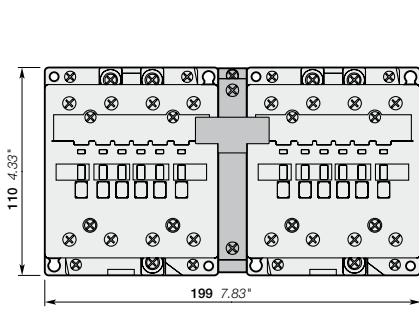

A45-40, A50-40, A75-40, AF45-40, AF50-40, AF75-40  
+ VE5-2 electrical and mechanical interlock unit

# AE45, AE50 and AE75 4-pole contactors TAE45, TAE50 and TAE75 4-pole contactors DC operated

Main dimensions mm, inches

5

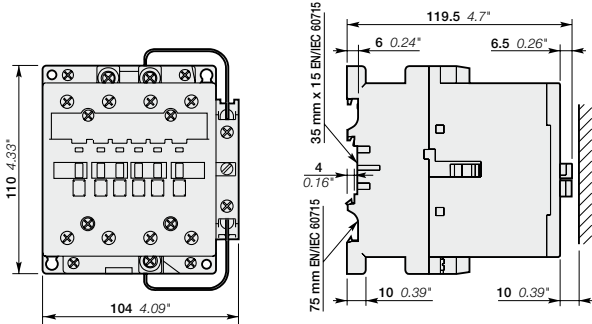

AE45, AE50, AE75, TAE45, TAE50, TAE75

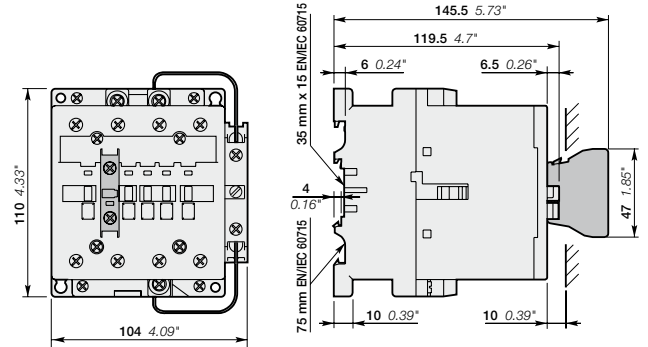

AE45, AE50, AE75, TAE45, TAE50, TAE75  
+ CA5 front-mounted 1-pole auxiliary contact block

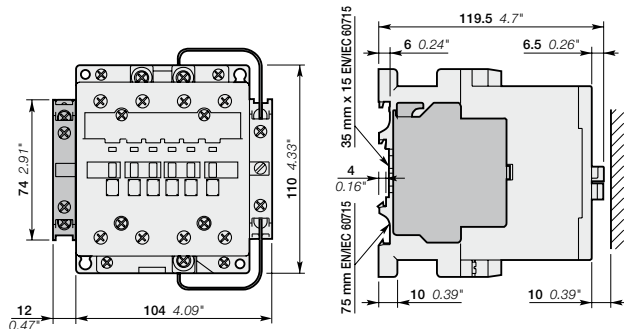

AE45, AE50, AE75, TAE45, TAE50, TAE75  
+ CAL5 side-mounted 2-pole auxiliary contact block

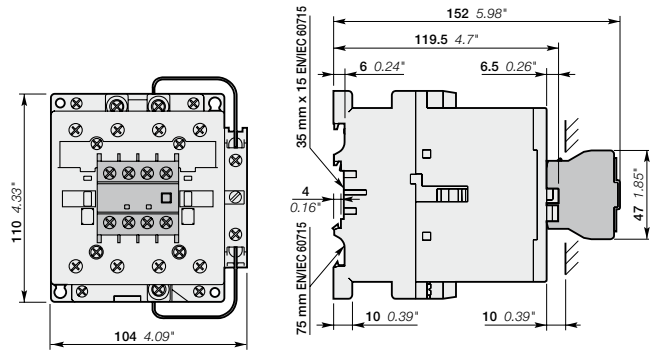

AE45, AE50, AE75, TAE45, TAE50, TAE75  
+ CA5 front-mounted 4-pole auxiliary contact block

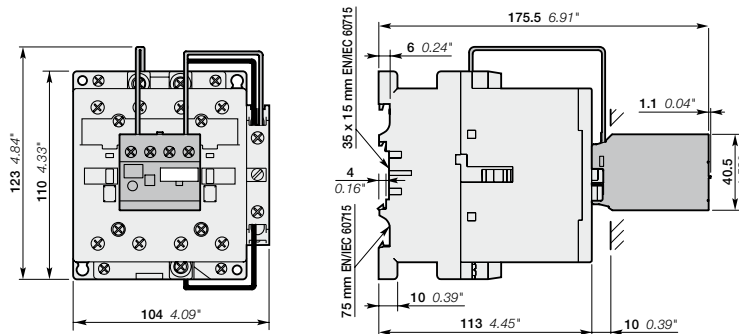

AE45, AE50, AE75, TAE45, TAE50, TAE75  
+ TEF5 electronic timer

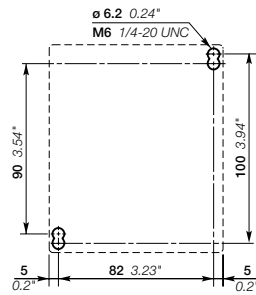

AE45, AE50, AE75, TAE45, TAE50, TAE75

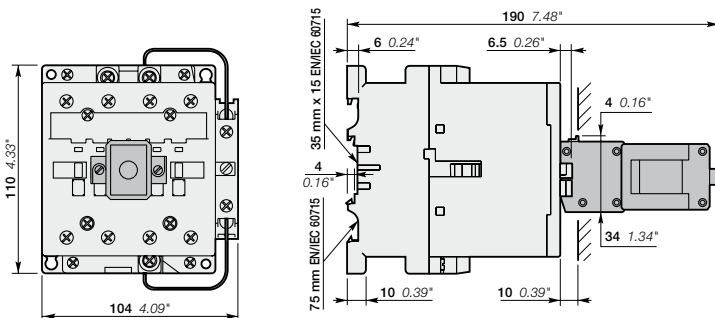

AE45, AE50, AE75, TAE45, TAE50, TAE75  
+ WB75-A on-position latch

# AE45, AE50 and AE75 4-pole contactors TAE45, TAE50 and TAE75 4-pole contactors DC operated

## Main dimensions mm, inches

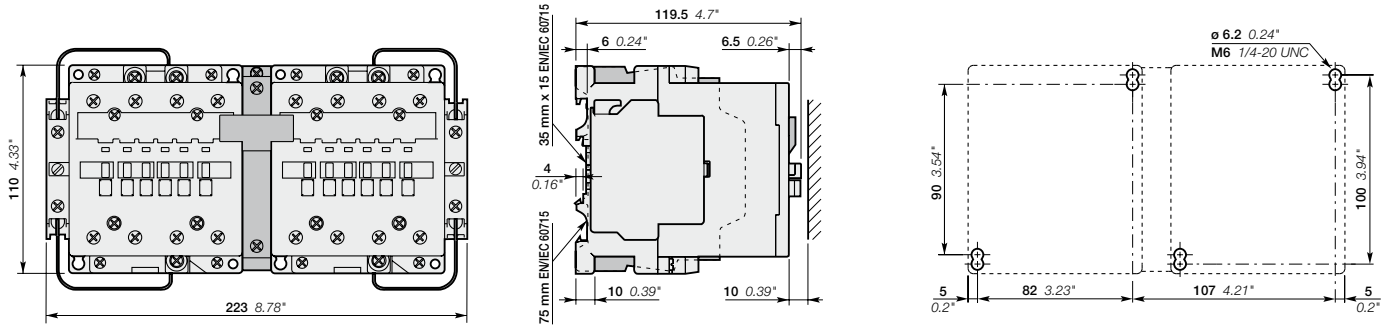

AE45-40, AE50-40, AE75-40, TAE45-40, TAE50-40, TAE75-40  
+ VE5-2 electrical and mechanical interlock unit

# EK110 ... EK210 4-pole contactors

## AC operated

### Main dimensions mm, inches

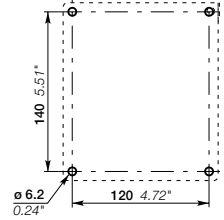
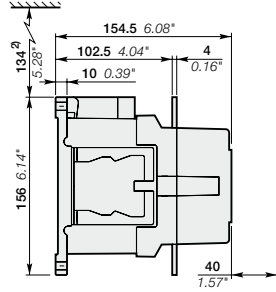
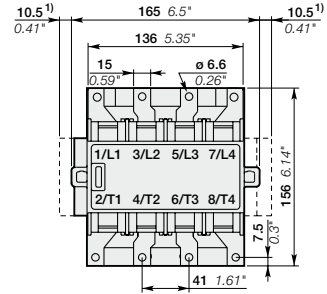

EK110

5

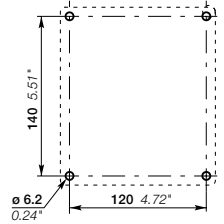
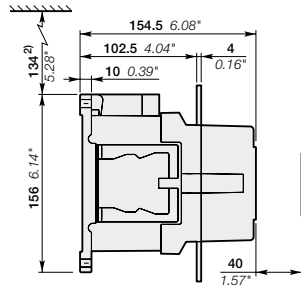
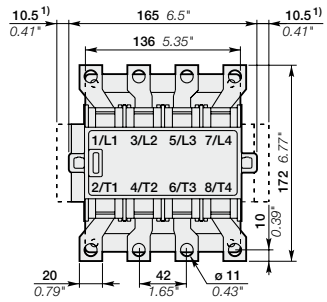

EK150

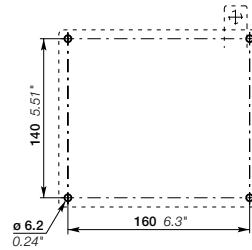
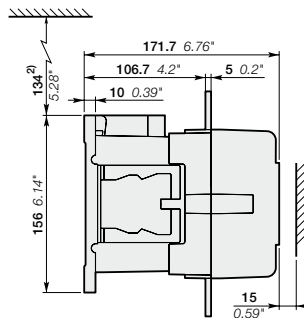
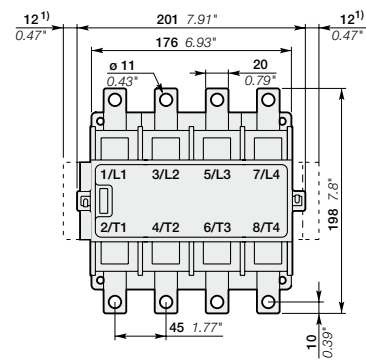

EK175, EK210

- 1) Dimension for extra auxiliary contact block
- 2) Min. distance to uninsulated wall

# EK110 ... EK210 4-pole contactors DC operated

## Main dimensions mm, inches

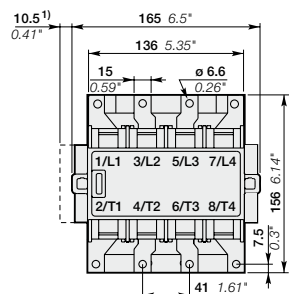

EK110

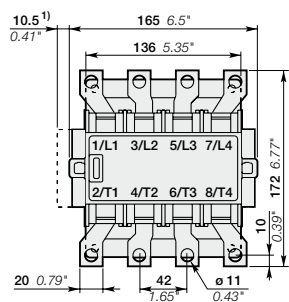
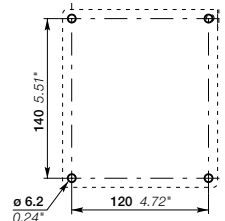
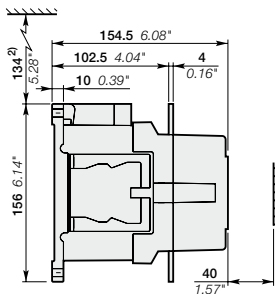

EK150

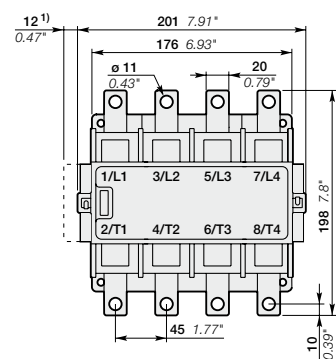
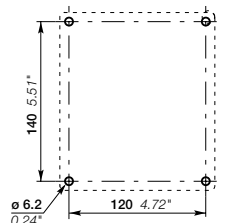
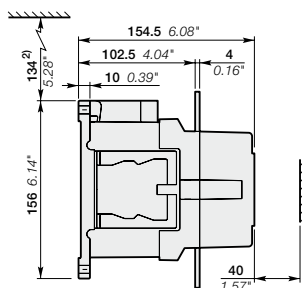

EK175, EK210

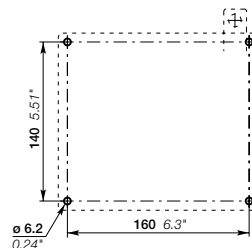
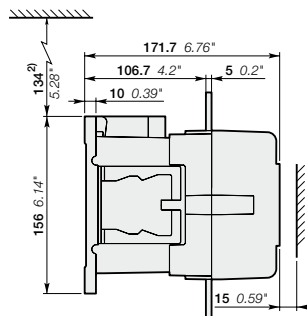

- 1) Dimension for extra auxiliary contact block
- 2) Min. distance to uninsulated wall

# EK370 ... EK1000 4-pole contactors

## AC operated

### Main dimensions mm, inches

5

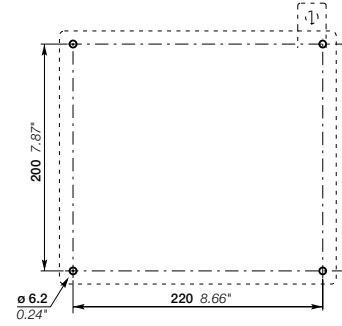
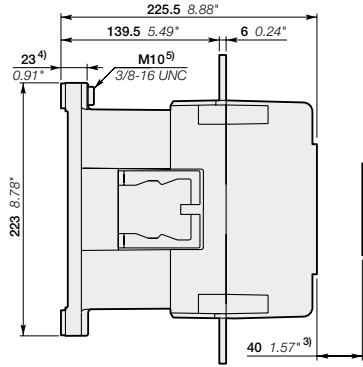
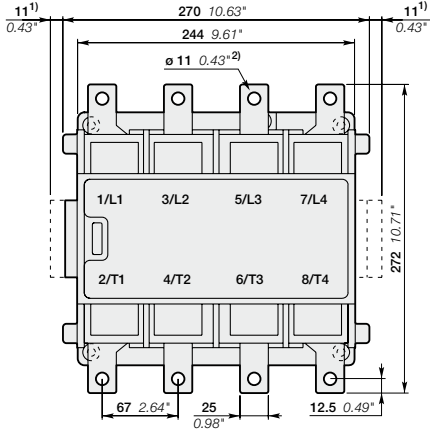

EK370, EK550

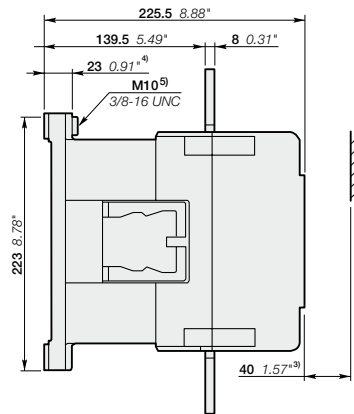
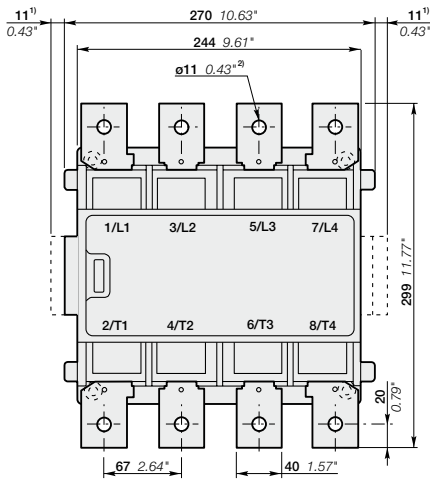

EK1000

- 1) Dimension for extra auxiliary contact block
- 2) Screw, nut and washer by-packed
- 3) Min. distance to uninsulated wall
- 4) Damping elements are included
- 5) Earthing screw

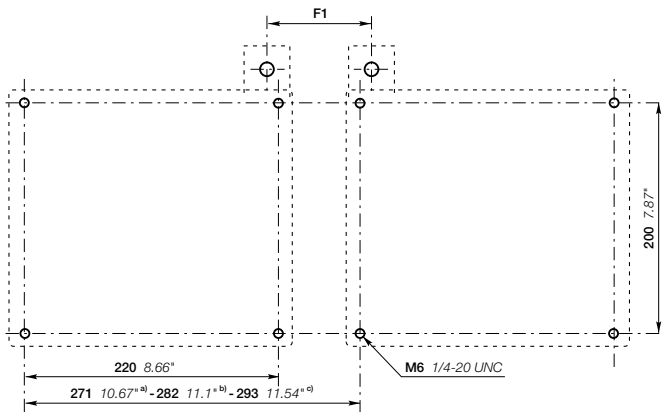

EK1000

- a) Min. dim Makes distance F1 = 70
- b) Includes space for three auxiliary contact blocks between the contactors
- c) Includes space for four auxiliary contact blocks between the contactors



# EK370 ... EK1000 4-pole contactors

## DC operated

### Main dimensions mm, inches

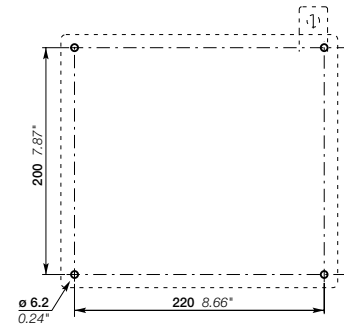
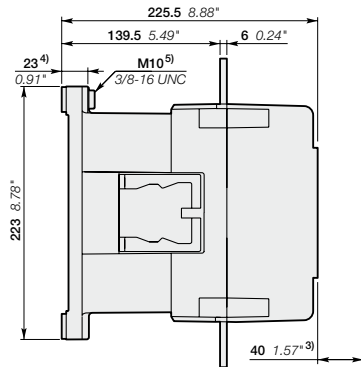
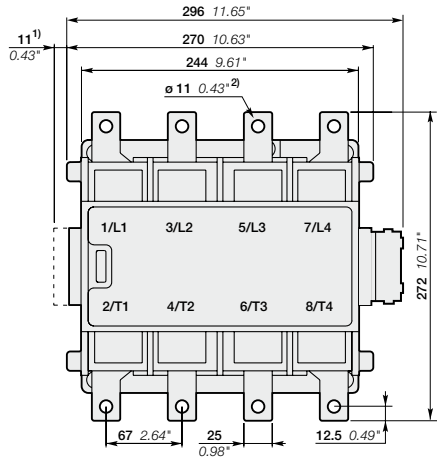

EK370, EK550

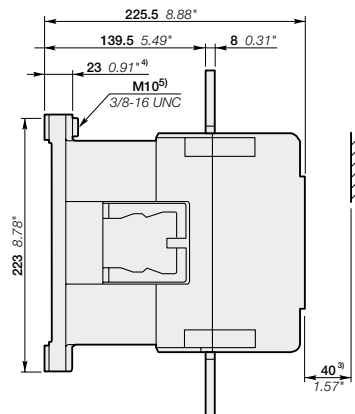
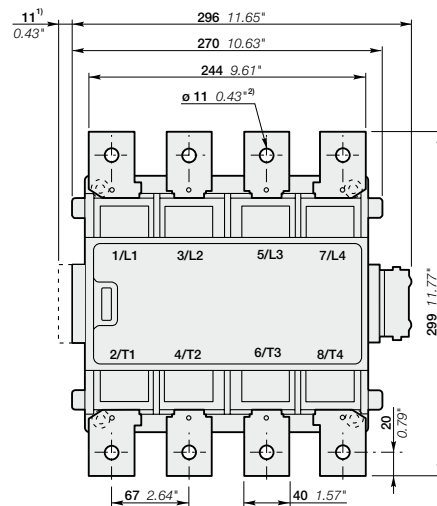

EK1000

- 1) Dimension for extra auxiliary contact block
- 2) Screw, nut and washer by-packed
- 3) Min. distance to uninsulated wall
- 4) Damping elements are included
- 5) Earthing screw

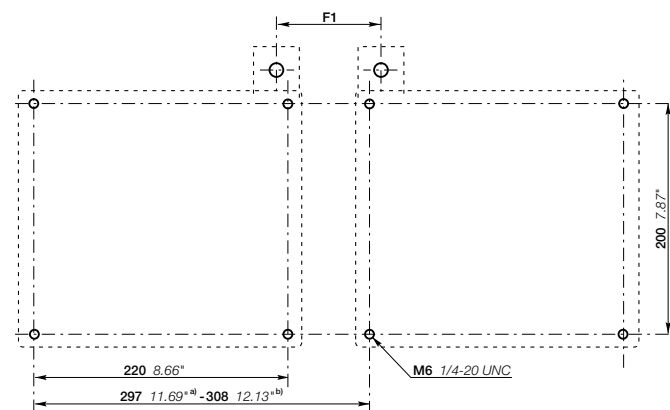

EK1000

- a) Min. dim.
- b) Includes space for two auxiliary contact blocks and the dc-unit between the contactors



# Contactors for capacitor switching

[Overview](#) [5/156](#)

---

## [UA16..RA up to UA110..RA - Unlimited peak \$\hat{I}\$](#)

<a href="#">Ordering details</a>	<a href="#">5/158</a>
<a href="#">Main accessories</a>	<a href="#">5/161</a>
<a href="#">Technical data</a>	<a href="#">5/162</a>
<a href="#">Terminal marking and positioning</a>	<a href="#">5/164</a>
<a href="#">Main dimensions</a>	<a href="#">5/165</a>

---

## [UA16 up to UA110 - Peak current \$\hat{I} \leq 100\$ times the rms current](#)

<a href="#">Ordering details</a>	<a href="#">5/167</a>
<a href="#">Main accessories</a>	<a href="#">5/172</a>
<a href="#">Technical data</a>	<a href="#">5/173</a>
<a href="#">Terminal marking and positioning</a>	<a href="#">5/175</a>
<a href="#">Main dimensions</a>	<a href="#">5/176</a>

---

[Voltage code table](#) [5/269](#)

---

# Contactors for capacitor switching

## AC-6b utilization category according to IEC 60947-4-1

### Capacitor transient conditions

In Low Voltage industrial installations, capacitors are mainly used for reactive energy correction (raising the power factor). When these capacitors are energized, overcurrents of high amplitude and high frequencies (3 to 15 kHz) occur during the transient period (1 to 2 ms).

The amplitude of these current peaks, also known as "inrush current peaks", depends on the following factors:

- The network inductances.
- The transformer power and short-circuit voltage.
- The type of power factor correction.

There are 2 types of power factor correction: fixed or automatic.

**Fixed power factor correction** consists of inserting, in parallel on the network, a capacitor bank whose total power is provided by the assembly of capacitors of identical or different ratings.

The bank is energized by a contactor that simultaneously supplies all the capacitors (a single step).

The inrush current peak, in the case of fixed correction, can reach 30 times the nominal current of the capacitor bank.



**Single-step capacitor bank scheme**  
Use the A/AF... contactor ranges.

**An automatic power factor correction system**, on the other hand, consists of several capacitor banks of identical or different ratings (several steps), energized separately according to the value of the power factor to be corrected.

An electronic device automatically determines the power of the steps to be energized and activates the relevant contactors.

The inrush current peak, in the case of automatic correction, depends on the power of the steps already on duty, and can reach 100 times the nominal current of the step to be energized.

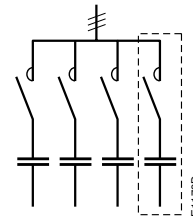

**Multi-step capacitor bank scheme**  
Use the UA... or UA..RA contactor ranges.

### Steady state condition data

The presence of harmonics and the network's voltage tolerance lead to a current, estimated to be 1.3 times the nominal current  $I_n$  of the capacitor, permanently circulating in the circuit.

Taking into account the manufacturing tolerances, the exact power of a capacitor can reach 1.15 times its nominal power.

Standard IEC 60831-1 Edition 2002 specifies that the capacitor must therefore have a maximum thermal current  $I_T$  of:

$$I_T = 1.3 \times 1.15 \times I_n = 1.5 \times I_n$$

### Consequences for the contactors

To avoid malfunctions (welding of main poles, abnormal temperature rise, etc.), contactors for capacitor bank switching must be sized to withstand:

- A permanent current that can reach 1.5 times the nominal current of the capacitor bank.
- The short but high peak current on pole closing (maximum permissible peak current  $\hat{I}$ ).

### Contactor selection tool for capacitor switching

In a given application, if the user does not know the value of the inrush current peak, this value can be approximately calculated using the formulas given on the pages "Calculation and dimensioning".

Alternatively by the **CAPCAL selection tool**, available on the ABB Website:

[www.abb.com/lowvoltage](http://www.abb.com/lowvoltage)

right hand side menu

search: "Online product selection tools"

select: "Contactors: AC-6b capacitor switching"

This program allows the calculation of these peaks and gives the references of the ABB contactors according to the installation specifications. This calculation is valid for one or several capacitor banks.

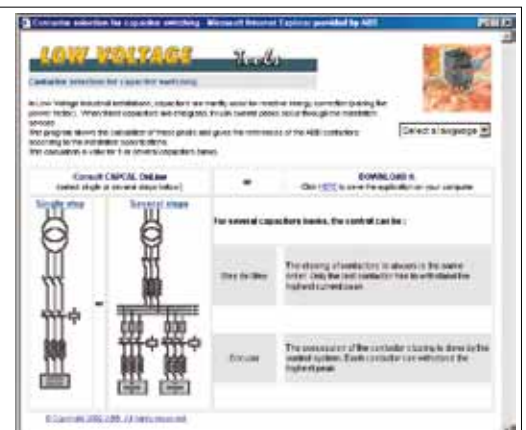

# Contactors for capacitor switching

## The ABB solutions

ABB offers 2 contactor versions according to the value of the inrush current peak and the power of the capacitor bank.

### UA..RA contactors for capacitor switching (UA16..RA to UA110..RA) with insertion of damping resistors

The insertion of damping resistors protects the contactor and the capacitor from the highest inrush currents.



### UA contactors for capacitor switching (UA16 to UA110)

Maximum permissible peak current  $\hat{I} \leq 100$  times the nominal rms current of the switched capacitor.

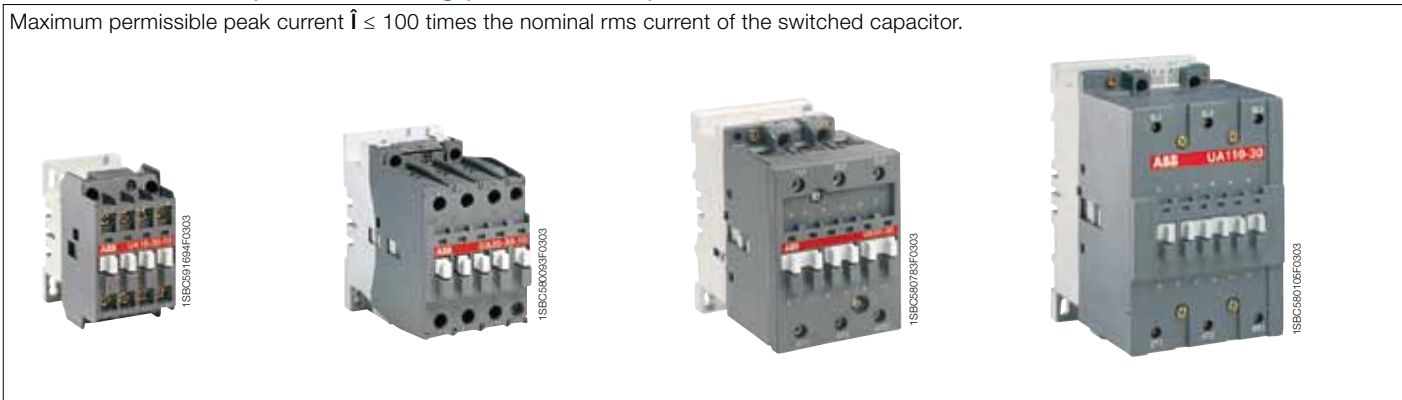

# UA16..RA ... UA30..RA 3-pole contactors for capacitor switching 12.5 to 30 kvar - Unlimited peak current $\hat{I}$ AC operated



UA16-30-10RA

1SBC87794FC001



UA30-30-10RA

1SBC87774FC001

## Description

UA..RA contactors for capacitor switching can be used for installations in which the peak current far exceeds 100 times nominal rms current. The contactors are delivered complete with their damping resistors and must be used without additional inductances.

The capacitors must be discharged (maximum residual voltage at terminals  $\leq 50$  V) before being re-energized when the contactors are making.

These contactors are of the block type design with:

- 3 main poles and 1 built-in auxiliary contact
- the UA..RA contactors are fitted with a special front-mounted block, which ensures the serial insertion of 3 damping resistors into the circuit to limit the current peak on energization of the capacitor bank
- their connection also ensures capacitor precharging in order to limit the second current peak occurring upon making of the main poles
- the insertion of resistors allows to damp the highest current peak of the capacitor when switching on, whatever its level.
- control circuit: AC operated
- add-on auxiliary contact blocks for side mounting and a wide range of accessories.

## Ordering details

IEC Rated operational power $\theta \leq 40^\circ\text{C}$ 400 V AC-6b kvar	UL/CSA Rated operational power $\theta \leq 40^\circ\text{C}$ 480 V kvar	Rated control circuit voltage $U_c$ (1)		Auxiliary contacts fitted	Type	Order code	Weight Pkg (1 pce) kg
		V 50 Hz	V 60 Hz				
12.5	16	24	24	1 0	UA16-30-10RA	1SBL181024R8110	0.460
		48	48	1 0	UA16-30-10RA	1SBL181024R8310	0.460
		110	110...120	1 0	UA16-30-10RA	1SBL181024R8410	0.460
		220...230	230...240	1 0	UA16-30-10RA	1SBL181024R8010	0.460
		230...240	240...260	1 0	UA16-30-10RA	1SBL181024R8810	0.460
		380...400	400...415	1 0	UA16-30-10RA	1SBL181024R8510	0.460
22	22	400...415	415...440	1 0	UA16-30-10RA	1SBL181024R8610	0.460
		24	24	1 0	UA26-30-10RA	1SBL241024R8110	0.710
		48	48	1 0	UA26-30-10RA	1SBL241024R8310	0.710
		110	110...120	1 0	UA26-30-10RA	1SBL241024R8410	0.710
		220...230	230...240	1 0	UA26-30-10RA	1SBL241024R8010	0.710
		230...240	240...260	1 0	UA26-30-10RA	1SBL241024R8810	0.710
30	28	380...400	400...415	1 0	UA26-30-10RA	1SBL241024R8510	0.710
		400...415	415...440	1 0	UA26-30-10RA	1SBL241024R8610	0.710
		24	24	1 0	UA30-30-10RA	1SBL281024R8110	0.810
		48	48	1 0	UA30-30-10RA	1SBL281024R8310	0.810
		110	110...120	1 0	UA30-30-10RA	1SBL281024R8410	0.810
		220...230	230...240	1 0	UA30-30-10RA	1SBL281024R8010	0.810
		230...240	240...260	1 0	UA30-30-10RA	1SBL281024R8810	0.810
		380...400	400...415	1 0	UA30-30-10RA	1SBL281024R8510	0.810
		400...415	415...440	1 0	UA30-30-10RA	1SBL281024R8610	0.810

(1) Other control voltages see voltage code table.

## Main dimensions mm, inches

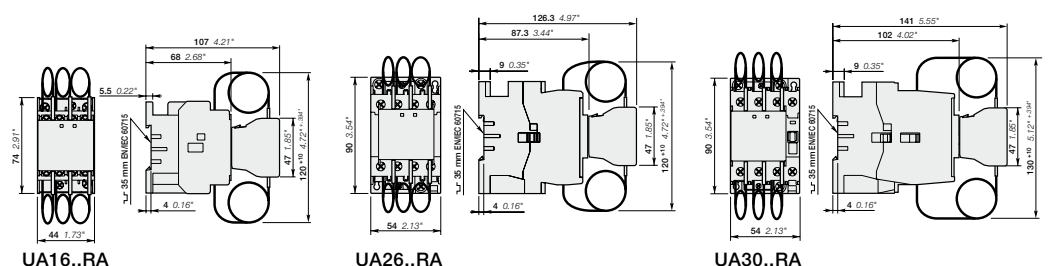

1SBC101507S0201

# UA50..RA ... UA75..RA 3-pole contactors for capacitor switching 40 to 60 kvar - Unlimited peak current $\hat{I}$ AC operated



UA75-30-00 RA

## Description

UA..RA contactors for capacitor switching can be used for installations in which the peak current far exceeds 100 times nominal rms current. The contactors are delivered complete with their damping resistors and must be used without additional inductances.

The capacitors must be discharged (maximum residual voltage at terminals  $\leq 50$  V) before being re-energized when the contactors are making.

These contactors are of the block type design with:

- 3 main poles
- the UA..RA contactors are fitted with a special front-mounted block, which ensures the serial insertion of 3 damping resistors into the circuit to limit the current peak on energization of the capacitor bank
  - their connection also ensures capacitor precharging in order to limit the second current peak occurring upon making of the main poles
  - the insertion of resistors allows to damp the highest current peak of the capacitor when switching on, whatever its level.
- control circuit: AC operated
- add-on auxiliary contact blocks for side mounting and a wide range of accessories.

## Ordering details

IEC Rated operational power $\theta \leq 40^\circ\text{C}$ 400 V AC-6b kvar	UL/CSA Rated operational power $\theta \leq 40^\circ\text{C}$ 480 V kvar	Rated control circuit voltage Uc (1)		Auxiliary contacts fitted	Type	Order code	Weight Pkg (1 pce) kg
		V 50 Hz	V 60 Hz				
40	50	24	24	0 0	UA50-30-00RA	1SBL351024R8100	1.350
		48	48	0 0	UA50-30-00RA	1SBL351024R8300	1.350
		110	110...120	0 0	UA50-30-00RA	1SBL351024R8400	1.350
		220...230	230...240	0 0	UA50-30-00RA	1SBL351024R8000	1.350
		230...240	240...260	0 0	UA50-30-00RA	1SBL351024R8800	1.350
		380...400	400...415	0 0	UA50-30-00RA	1SBL351024R8500	1.350
		400...415	415...440	0 0	UA50-30-00RA	1SBL351024R8600	1.350
50	55	24	24	0 0	UA63-30-00RA	1SBL371024R8100	1.350
		48	48	0 0	UA63-30-00RA	1SBL371024R8300	1.350
		110	110...120	0 0	UA63-30-00RA	1SBL371024R8400	1.350
		220...230	230...240	0 0	UA63-30-00RA	1SBL371024R8000	1.350
		230...240	240...260	0 0	UA63-30-00RA	1SBL371024R8800	1.350
		380...400	400...415	0 0	UA63-30-00RA	1SBL371024R8500	1.350
		400...415	415...440	0 0	UA63-30-00RA	1SBL371024R8600	1.350
60	64	24	24	0 0	UA75-30-00RA	1SBL411024R8100	1.350
		48	48	0 0	UA75-30-00RA	1SBL411024R8300	1.350
		110	110...120	0 0	UA75-30-00RA	1SBL411024R8400	1.350
		220...230	230...240	0 0	UA75-30-00RA	1SBL411024R8000	1.350
		230...240	240...260	0 0	UA75-30-00RA	1SBL411024R8800	1.350
		380...400	400...415	0 0	UA75-30-00RA	1SBL411024R8500	1.350
		400...415	415...440	0 0	UA75-30-00RA	1SBL411024R8600	1.350

(1) Other control voltages see voltage code table.

## Main dimensions mm, inches

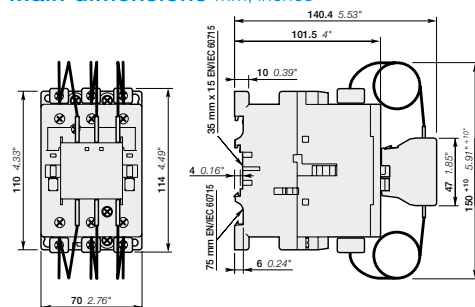

UA50..RA, UA63..RA, UA75..RA

# UA95..RA ... UA110..RA 3-pole contactors for capacitor switching 70 to 80 kvar - Unlimited peak current $\hat{I}$ AC operated



UA110-30-00 RA

1SBC391444F0002

## Description

UA..RA contactors for capacitor switching can be used for installations in which the peak current far exceeds 100 times nominal rms current. The contactors are delivered complete with their damping resistors and must be used without additional inductances.

The capacitors must be discharged (maximum residual voltage at terminals  $\leq 50$  V) before being re-energized when the contactors are making.

These contactors are of the block type design with:

- 3 main poles
- the UA..RA contactors are fitted with a special front-mounted block, which ensures the serial insertion of 3 damping resistors into the circuit to limit the current peak on energization of the capacitor bank
- their connection also ensures capacitor precharging in order to limit the second current peak occurring upon making of the main poles
- the insertion of resistors allows to damp the highest current peak of the capacitor when switching on, whatever its level.
- control circuit: AC operated
- add-on auxiliary contact blocks for side mounting and a wide range of accessories.

## Ordering details

IEC Rated operational power $\theta \leq 40^\circ\text{C}$ 400 V AC-6b	UL/CSA Rated operational power $\theta \leq 40^\circ\text{C}$ 480 V	Rated control circuit voltage Uc (1)		Auxiliary contacts fitted 	Type	Order code	Weight Pkg (1 pce) kg
		V 50 Hz	V 60 Hz				
70	80	24	24	0 0	UA95-30-00RA	1SFL431024R8100	2.000
		48	48	0 0	UA95-30-00RA	1SFL431024R8300	2.000
		110	110...120	0 0	UA95-30-00RA	1SFL431024R8400	2.000
		220...230	230...240	0 0	UA95-30-00RA	1SFL431024R8000	2.000
		230...240	240...260	0 0	UA95-30-00RA	1SFL431024R8800	2.000
		380...400	400...415	0 0	UA95-30-00RA	1SFL431024R8500	2.000
		400...415	415...440	0 0	UA95-30-00RA	1SFL431024R8600	2.000
80	95	24	24	0 0	UA110-30-00RA	1SFL451024R8100	2.000
		48	48	0 0	UA110-30-00RA	1SFL451024R8300	2.000
		110	110...120	0 0	UA110-30-00RA	1SFL451024R8400	2.000
		220...230	230...240	0 0	UA110-30-00RA	1SFL451024R8000	2.000
		230...240	240...260	0 0	UA110-30-00RA	1SFL451024R8800	2.000
		380...400	400...415	0 0	UA110-30-00RA	1SFL451024R8500	2.000
		400...415	415...440	0 0	UA110-30-00RA	1SFL451024R8600	2.000

(1) Other control voltages see voltage code table.

## Main dimensions mm, inches

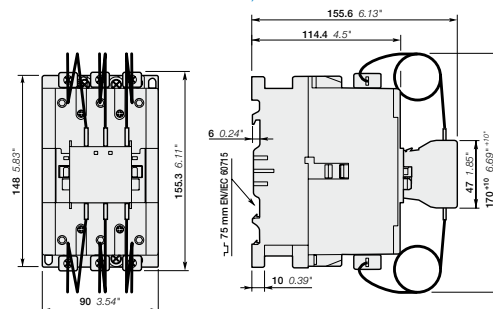

UA95..RA, UA100..RA







# UA..RA 3-pole contactors for capacitor switching

## Unlimited peak current $\hat{I}$

### Main accessory fitting details

Many configurations of accessories are possible depending on whether these are front-mounted or side-mounted.

Contactor types	Main poles		Available auxiliary contacts		Front-mounted accessories	Side-mounted accessories
					Auxiliary contact blocks	Auxiliary contact blocks
					<b>1-pole CA5-...</b>	<b>2-pole CAL...</b>
UA16-30-10RA	3	0	1	0	-	1 x CAL5-11
UA26-30-10RA	3	0	1	0	-	1 to 2 x CAL5-11
UA30-30-10RA	3	0	1	0	1 x CA5-...	+ 1 to 2 x CAL5-11
UA50-30-00RA	3	0	0	0	1 to 2 x CA5-...	+ 1 to 2 x CAL5-11
UA63-30-00RA	3	0	0	0		
UA75-30-00RA	3	0	0	0		
UA95-30-00RA	3	0	0	0	1 to 2 x CA5-...	+ 1 to 2 x CAL18-11
UA110-30-00RA	3	0	0	0		

# UA16..RA ... UA110..RA 3-pole contactors for capacitor switching

## Unlimited peak current $\hat{I}$

### Technical data

#### Main pole - Utilization characteristics according to IEC

Contactor types	AC operated	UA16..RA	UA26..RA	UA30..RA	UA50..RA	UA63..RA	UA75..RA	UA95..RA	UA110..RA	
Standards		IEC 60947-1 / 60947-4-1 and EN 60947-1 / 60947-4-1								
Rated operational voltage $U_e$ max.		690 V								
Rated frequency (without derating)		50 / 60 Hz								
AC-6b Utilization category										
<b>Rated operational power AC-6b</b>										
For air temperature close to contactor	$\theta \leq 40^\circ\text{C}$	230-240 V	8 kvar	12.5 kvar	16 kvar	25 kvar	30 kvar	35 kvar	40 kvar	45 kvar
		400-415 V	12.5 kvar	22 kvar	30 kvar	40 kvar	50 kvar	60 kvar	70 kvar	80 kvar
	$\theta \leq 55^\circ\text{C}$	440 V	15 kvar	24 kvar	32 kvar	50 kvar	55 kvar	65 kvar	75 kvar	85 kvar
		500-550 V	18 kvar	30 kvar	34 kvar	55 kvar	65 kvar	75 kvar	85 kvar	95 kvar
	$\theta \leq 70^\circ\text{C}$	690 V	22 kvar	35 kvar	45 kvar	72 kvar	80 kvar	100 kvar	120 kvar	130 kvar
		230-240 V	7.5 kvar	11.5 kvar	16 kvar	24 kvar	27 kvar	30 kvar	35 kvar	40 kvar
		400-415 V	12.5 kvar	20 kvar	27.5 kvar	40 kvar	45 kvar	50 kvar	60 kvar	70 kvar
		440 V	13 kvar	20 kvar	30 kvar	43 kvar	48 kvar	53 kvar	65 kvar	75 kvar
		500-550 V	16 kvar	25 kvar	34 kvar	50 kvar	60 kvar	65 kvar	75 kvar	82 kvar
		690 V	21 kvar	31 kvar	45 kvar	65 kvar	75 kvar	80 kvar	105 kvar	110 kvar
		230-240 V	6 kvar	9 kvar	11 kvar	20 kvar	23 kvar	25 kvar	30 kvar	35 kvar
		400-415 V	10 kvar	15.5 kvar	19.5 kvar	35 kvar	39 kvar	41 kvar	53 kvar	60 kvar
		440 V	11 kvar	17 kvar	20.5 kvar	37 kvar	42.5 kvar	45 kvar	58 kvar	70 kvar
		500-550 V	12.5 kvar	20 kvar	25 kvar	46 kvar	50 kvar	55 kvar	70 kvar	78 kvar
		690 V	17 kvar	26 kvar	32 kvar	60 kvar	65 kvar	70 kvar	85 kvar	100 kvar
Max. permissible peak current $\hat{I}$		Unlimited								
Short-circuit protection device for contactors		80 A		125 A	200 A	250 A				
gG type fuse (1)		80 A		125 A	200 A	250 A				
Max. electrical switching frequency		240 cycles/h								
Electrical durability AC-6b		$U_e \leq 440\text{ V}$		250 000 operating cycles						
		$500\text{ V} \leq U_e \leq 690\text{ V}$		100 000 operating cycles						

(1) The fuse ratings given represent the maximum ratings ensuring type 1 coordination according to the definition of standard IEC 60947-4-1.

#### Main pole - Utilization characteristics according to UL / CSA

Contactor types	AC operated	UA16..RA	UA26..RA	UA30..RA	UA50..RA	UA63..RA	UA75..RA	UA95..RA	UA110..RA	
<b>Power - 60 Hz</b>										
For air temperature close to contactor	$\theta \leq 40^\circ\text{C}$	240 V	8 kvar	11 kvar	14 kvar	25 kvar	27.5 kvar	32 kvar	40 kvar	45 kvar
		480 V	16 kvar	22 kvar	28 kvar	50 kvar	55 kvar	64 kvar	80 kvar	95 kvar
		600 V	20 kvar	27 kvar	35 kvar	62 kvar	70 kvar	80 kvar	100 kvar	120 kvar
Max. permissible peak Current $\hat{I}$		Unlimited								

#### Operating principle

The front-mounted block mechanism of the UA..RA contactors ensures:

- early making of the auxiliary "PA" poles with respect to the main "PP" poles
- automatic return to the open position of the auxiliary "PA" poles after the main poles are closed.

**When the coil is energized**, the early making auxiliary poles connect the capacitor to the network via the set of 3 resistors. The damping resistors attenuate the first current peak and the second inrush current when the main contacts begin to make. Once the main poles are in the closed position, the auxiliary poles automatically break.

**When the coil is de-energized**, the main poles break ensuring the breaking of the capacitor bank.

The contactor can then begin a new cycle.

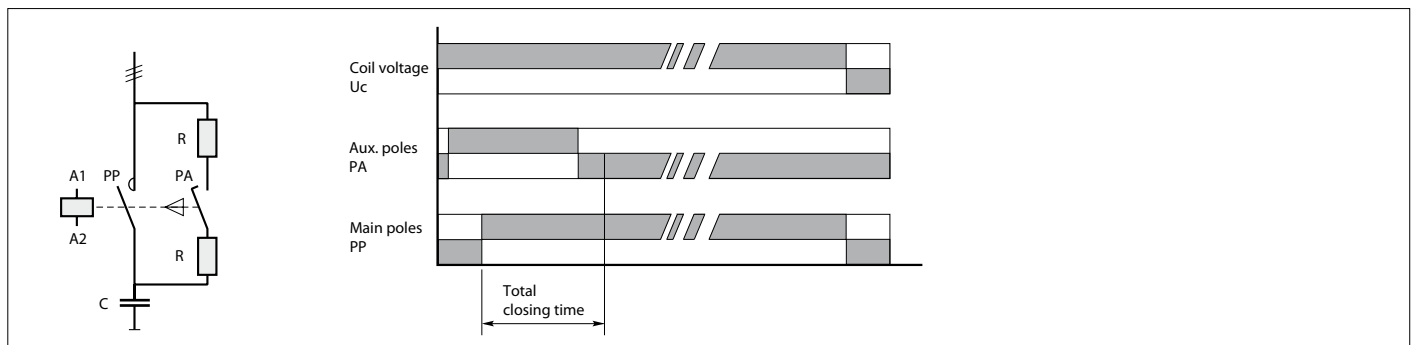







The insertion of resistors allows to damp the highest current peak of the capacitor when switching on, whatever its level.

# UA16..RA ... UA110..RA 3-pole contactors for capacitor switching

## Unlimited peak current $\hat{I}$

### Technical data

#### Connecting characteristics

Contactor types	AC operated	UA16..RA	UA26..RA	UA30..RA	UA50..RA UA63..RA UA75..RA	UA95..RA UA110..RA
<b>Connection capacity (min. ... max.)</b>						
<b>Main conductors (poles)</b>						
 Rigid	Solid ( $\leq 4 \text{ mm}^2$ )	1 x 1...4 mm <sup>2</sup>	1.5...6 mm <sup>2</sup>	2.5...16 mm <sup>2</sup>	6...50 mm <sup>2</sup>	10...95 mm <sup>2</sup>
	Stranded ( $\geq 6 \text{ mm}^2$ )	2 x -	-	2.5...16 + 2.5...6 mm <sup>2</sup>	6...25 + 6...16 mm <sup>2</sup>	6...35 mm <sup>2</sup>
 Flexible with ferrule		1 x 0.75...2.5 mm <sup>2</sup>	1.5...4 mm <sup>2</sup>	2.5...10 mm <sup>2</sup>	6...35 mm <sup>2</sup>	10...70 mm <sup>2</sup>
		2 x -	-	2.5...10 + 2.5...4 mm <sup>2</sup>	6...16 + 6...10 mm <sup>2</sup>	6...35 mm <sup>2</sup>
 Bars or lugs		L $\leq$ 7.7 mm	10 mm	-	-	-
		I $>$ 3.7 mm	4.2 mm	-	-	-
Connection capacity acc. to UL/CSA		1 or 2 x AWG 18...10	AWG 12...8	AWG 8...4	AWG 8...1	AWG 6...2/0
Tightening torque						
	Recommended	1 Nm / 9 lb.in	1.7 Nm / 15 lb.in	2.3 Nm / 20 lb.in	4 Nm / 35 lb.in	8 Nm / 53 lb.in
	Max.	1.2 Nm	2.2 Nm	2.6 Nm	4.5 Nm	9 Nm
<b>Auxiliary conductors</b> (built-in auxiliary terminals + coil terminals)						
 Rigid solid		1 x 1...4 mm <sup>2</sup>				0.75...2.5 mm <sup>2</sup>
		2 x 1...4 mm <sup>2</sup>				0.75...2.5 mm <sup>2</sup>
 Flexible with ferrule		1 x 0.75...2.5 mm <sup>2</sup>			1...2.5 mm <sup>2</sup>	0.75...2.5 mm <sup>2</sup>
		2 x 0.75...2.5 mm <sup>2</sup>				
 Lugs	Coil terminals	L $\leq$ 8 mm				
		I $>$ 3.7 mm				
	Built-in auxiliary terminals	L $\leq$ 7.7 mm	10 mm	8 mm	-	-
		I $>$ 3.7 mm	4.2 mm	3.7 mm	-	-
Connection capacity acc. to UL/CSA		1 or 2 x AWG 18...14				
Tightening torque						
	Coil terminals					
	Recommended	1 Nm / 9 lb.in				
	Max.	1.2 Nm				
	Built-in auxiliary terminals					
	Recommended	1 Nm / 9 lb.in				
	Max.	1.2 Nm				
<b>Degree of protection</b> acc. to IEC 60947-1 / EN 60947-1 and IEC 60529 / EN 60529						
Main terminals		IP20		IP10		
Coil terminals		IP20				
Built-in auxiliary terminals		IP20				
<b>Screw terminals</b>						
Main terminals		Delivered in open position, screws of unused terminals must be tightened				
		M 3.5	M 4	M 5	M 6	M 8
	Screwdriver type	Flat $\varnothing$ 5.5 / Pozidriv 2		Flat $\varnothing$ 6.5 / Pozidriv 2		Hexagon socket (s = 4 mm)
Coil terminals		M 3.5				
	Screwdriver type	Flat $\varnothing$ 5.5 / Pozidriv 2				
Built-in auxiliary terminals		M 3.5	M 4	M 3.5	-	-
	Screwdriver type	Flat $\varnothing$ 5.5 / Pozidriv 2			-	-

Other technical characteristics are the same as those of standard A contactors.

# UA..RA contactors

## Terminal marking and positioning

### UA..RA contactors - AC operated

Standard devices without addition of auxiliary contacts

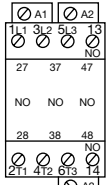

UA16-30-10 RA  
UA26-30-10 RA

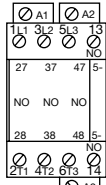

UA30-30-10 RA

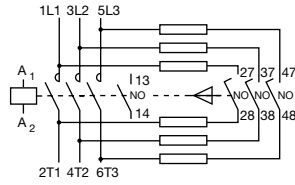

UA16 ... 30-30-10 RA

5

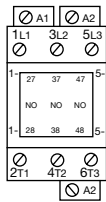

UA50 ... 110-30-00 RA

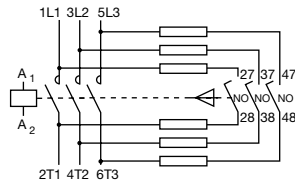

UA50 ... 110-30-00 RA

# UA..RA 3-pole contactors for capacitor switching

## Unlimited peak current $\hat{I}$

Main dimensions mm, inches

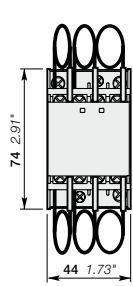

UA16..RA

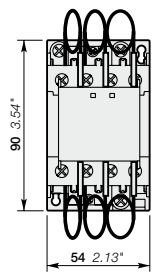
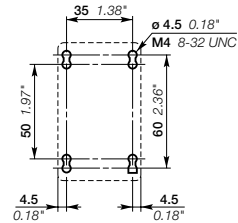
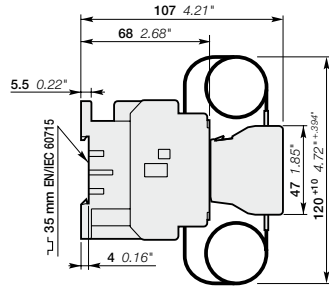

UA26..RA

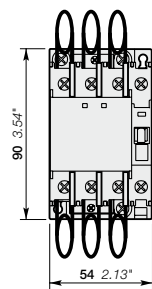
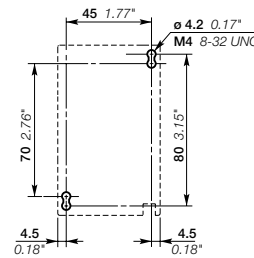
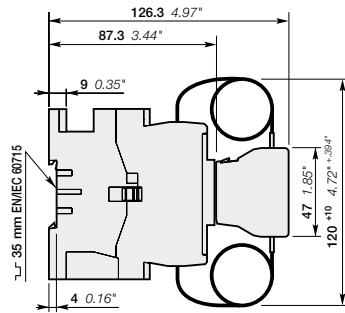

UA30..RA

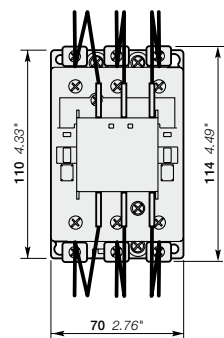
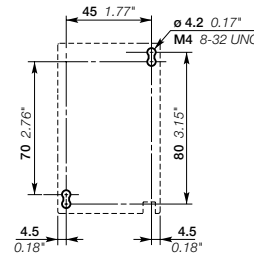
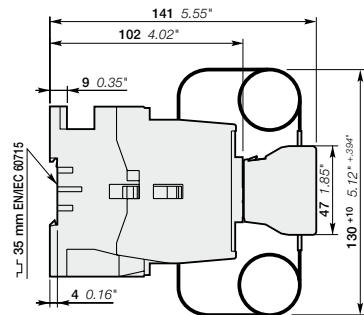

UA50..RA, UA63..RA, UA75..RA

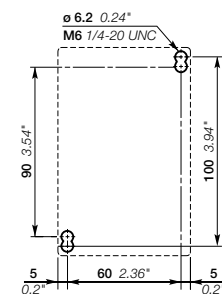
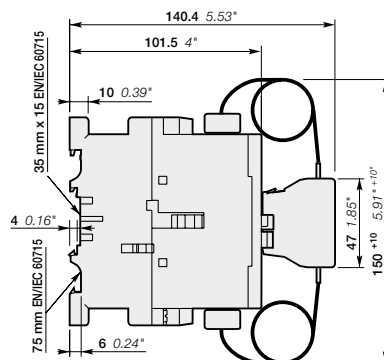

# UA..RA 3-pole contactors for capacitor switching

## Unlimited peak current $\hat{I}$

Main dimensions mm, inches

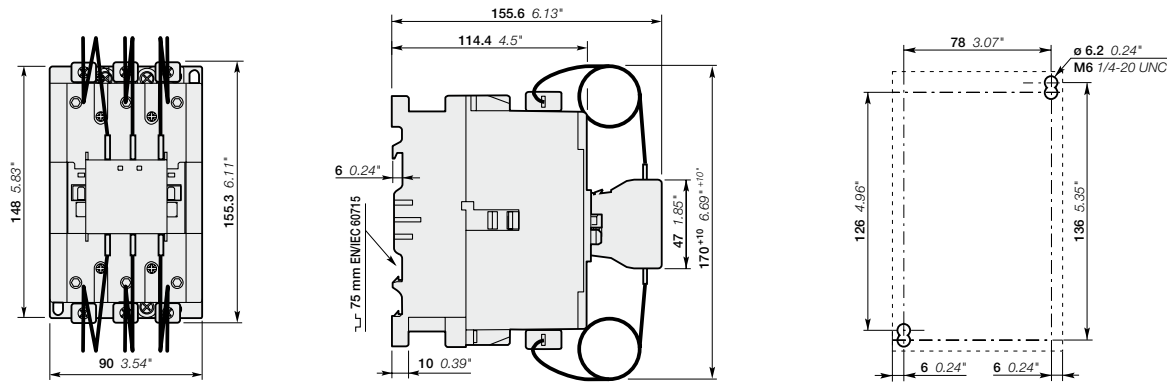

UA95..RA, UA110..RA

5

# UA16 ... UA30 3-pole contactors for capacitor switching

## 12.5 to 27.5 kvar - peak current $\hat{I} \leq 100$ times the rms current

### AC operated



UA16-30-10

1SBC91694F0004



UA30-30-10

1SBC90099F0003

#### Description

UA contactors can be used for the switching of capacitor banks whose inrush current peaks are less than or equal to 100 times nominal rms current.

The capacitors must be discharged (maximum residual voltage at terminals  $\leq 50$  V) before being re-energized when the contactors are making.

These contactors are of the block type design with:

- 3 main poles and 1 built-in auxiliary contact
- control circuit: AC operated
- add-on auxiliary contact blocks for front or side mounting and a wide range of accessories.

#### Ordering details

IEC Rated operational power $\theta \leq 40^\circ\text{C}$ 400 V AC-6b kvar	Max peak current $\hat{I}$ kA	UL/CSA Rated operational power $\theta \leq 40^\circ\text{C}$ 480 V kvar	Rated control circuit voltage Uc (1)		Auxiliary contacts fitted  I L	Type	Order code	Weight  Pkg (1 pce)  kg
			V 50 Hz	V 60 Hz				
12.5	1.8	-	24	24	1 0	UA16-30-10	1SBL181022R8110	0.340
			48	48	1 0	UA16-30-10	1SBL181022R8310	0.340
			110	110...120	1 0	UA16-30-10	1SBL181022R8410	0.340
			220...230	230...240	1 0	UA16-30-10	1SBL181022R8010	0.340
			230...240	240...260	1 0	UA16-30-10	1SBL181022R8810	0.340
			380...400	400...415	1 0	UA16-30-10	1SBL181022R8510	0.340
20	3	25	400...415	415...440	1 0	UA16-30-10	1SBL181022R8610	0.340
			24	24	1 0	UA26-30-10	1SBL241022R8110	0.600
			48	48	1 0	UA26-30-10	1SBL241022R8310	0.600
			110	110...120	1 0	UA26-30-10	1SBL241022R8410	0.600
			220...230	230...240	1 0	UA26-30-10	1SBL241022R8010	0.600
			230...240	240...260	1 0	UA26-30-10	1SBL241022R8810	0.600
27.5	3.5	32	380...400	400...415	1 0	UA26-30-10	1SBL241022R8510	0.600
			400...415	415...440	1 0	UA26-30-10	1SBL241022R8610	0.600
			24	24	1 0	UA30-30-10	1SBL281022R8110	0.710
			48	48	1 0	UA30-30-10	1SBL281022R8310	0.710
			110	110...120	1 0	UA30-30-10	1SBL281022R8410	0.710
			220...230	230...240	1 0	UA30-30-10	1SBL281022R8010	0.710
230...240	240...260	1 0	UA30-30-10	1SBL281022R8810	0.710			
380...400	400...415	1 0	UA30-30-10	1SBL281022R8510	0.710			
400...415	415...440	1 0	UA30-30-10	1SBL281022R8610	0.710			

(1) Other control voltages see voltage code table.

#### Main dimensions mm, inches

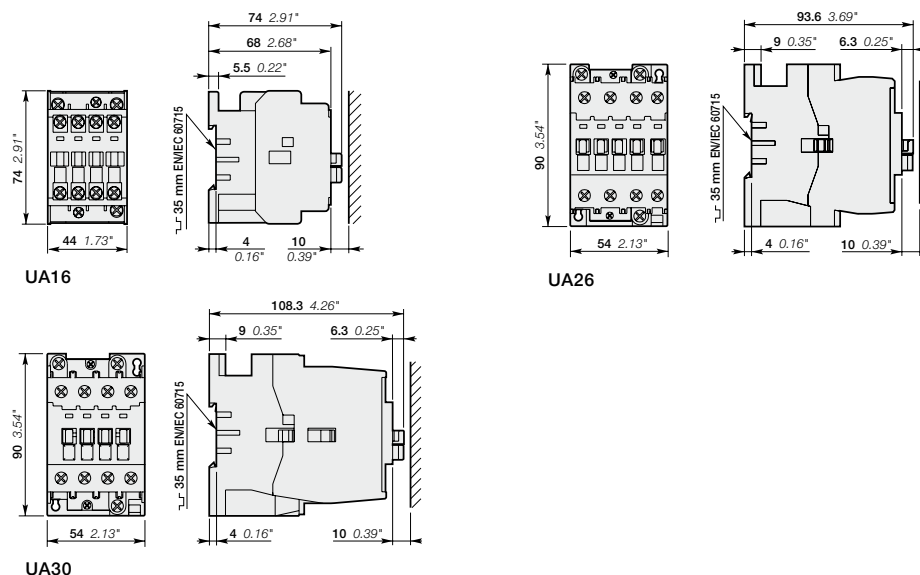

# UA50 ... UA75 3-pole contactors for capacitor switching

## 33 to 50 kvar - peak current $\hat{I} \leq 100$ times the rms current

### AC operated



UA50-30-00

#### Description

UA contactors can be used for the switching of capacitor banks whose inrush current peaks are less than or equal to 100 times nominal rms current.

The capacitors must be discharged (maximum residual voltage at terminals  $\leq 50$  V) before being re-energized when the contactors are making.

These contactors are of the block type design with:

- 3 main poles
- control circuit: AC operated
- add-on auxiliary contact blocks for front or side mounting and a wide range of accessories.

#### Ordering details

IEC Rated operational power $\theta \leq 40^\circ\text{C}$ 400 V AC-6b	Max peak current $\hat{I}$ kA	UL/CSA Rated operational power $\theta \leq 40^\circ\text{C}$ 480 V kvar	Rated control circuit voltage $U_c$ (1)		Auxiliary contacts fitted		Type	Order code	Weight  Pkg (1 pce)  kg
			V 50 Hz	V 60 Hz	$\frac{1}{2}$	$\frac{1}{3}$			
33	5	40	24	24	0	0	UA50-30-00	1SBL351022R8100	1.160
			48	48	0	0	UA50-30-00	1SBL351022R8300	1.160
			110	110...120	0	0	UA50-30-00	1SBL351022R8400	1.160
			220...230	230...240	0	0	UA50-30-00	1SBL351022R8000	1.160
			230...240	240...260	0	0	UA50-30-00	1SBL351022R8800	1.160
			380...400	400...415	0	0	UA50-30-00	1SBL351022R8500	1.160
			400...415	415...440	0	0	UA50-30-00	1SBL351022R8600	1.160
45	6.5	-	24	24	0	0	UA63-30-00	1SBL371022R8100	1.160
			48	48	0	0	UA63-30-00	1SBL371022R8300	1.160
			110	110...120	0	0	UA63-30-00	1SBL371022R8400	1.160
			220...230	230...240	0	0	UA63-30-00	1SBL371022R8000	1.160
			230...240	240...260	0	0	UA63-30-00	1SBL371022R8800	1.160
			380...400	400...415	0	0	UA63-30-00	1SBL371022R8500	1.160
			400...415	415...440	0	0	UA63-30-00	1SBL371022R8600	1.160
50	7.5	55	24	24	0	0	UA75-30-00	1SBL411022R8100	1.160
			48	48	0	0	UA75-30-00	1SBL411022R8300	1.160
			110	110...120	0	0	UA75-30-00	1SBL411022R8400	1.160
			220...230	230...240	0	0	UA75-30-00	1SBL411022R8000	1.160
			230...240	240...260	0	0	UA75-30-00	1SBL411022R8800	1.160
			380...400	400...415	0	0	UA75-30-00	1SBL411022R8500	1.160
			400...415	415...440	0	0	UA75-30-00	1SBL411022R8600	1.160

(1) Other control voltages see voltage code table.

#### Main dimensions mm, inches

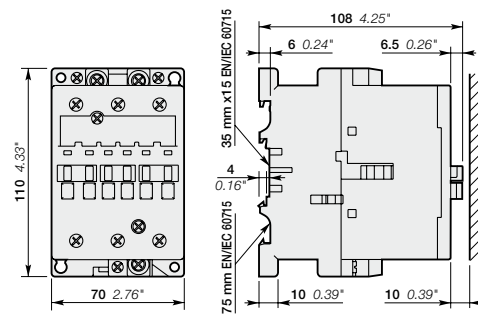

UA50, UA63, UA75



# UA50 ... UA75 3-pole contactors for capacitor switching

## 33 to 50 kvar - Peak current $\hat{I} < 100$ Times the rms current

### AC operated - with 1 N.O. + 1 N.C. auxiliary contacts



UA50-30-11

#### Description

UA contactors can be used for the switching of capacitor banks whose inrush current peaks are less than or equal to 100 times nominal rms current.

The capacitors must be discharged (maximum residual voltage at terminals  $\leq 50$  V) before being re-energized when the contactors are making.

These contactors are of the block type design with:

- 3 main poles
- control circuit: AC operated
- add-on auxiliary contact blocks for front or side mounting and a wide range of accessories.

#### Ordering details

IEC Rated operational power $\theta \leq 40^\circ\text{C}$ 400 V AC-6b kvar	Max peak current $\hat{I}$ kA	UL/CSA Rated operational power $\theta \leq 40^\circ\text{C}$ 400 V kvar	Rated control circuit voltage $U_c$ (1)		Auxiliary contacts fitted 	Type	Order code	Weight Pkg (1 pce) kg
			V 50 Hz	V 60 Hz				
33	5	40	24	24	1 1	UA50-30-11	1SBL351022R8111	1.200
			48	48	1 1	UA50-30-11	1SBL351022R8311	1.200
			110	110...120	1 1	UA50-30-11	1SBL351022R8411	1.200
			220...230	230...240	1 1	UA50-30-11	1SBL351022R8011	1.200
			230...240	240...260	1 1	UA50-30-11	1SBL351022R8811	1.200
			380...400	400...415	1 1	UA50-30-11	1SBL351022R8511	1.200
			400...415	415...440	1 1	UA50-30-11	1SBL351022R8611	1.200
45	6.5	-	24	24	1 1	UA63-30-11	1SBL371022R8111	1.200
			48	48	1 1	UA63-30-11	1SBL371022R8311	1.200
			110	110...120	1 1	UA63-30-11	1SBL371022R8411	1.200
			220...230	230...240	1 1	UA63-30-11	1SBL371022R8011	1.200
			230...240	240...260	1 1	UA63-30-11	1SBL371022R8811	1.200
			380...400	400...415	1 1	UA63-30-11	1SBL371022R8511	1.200
			400...415	415...440	1 1	UA63-30-11	1SBL371022R8611	1.200
50	7.5	55	24	24	1 1	UA75-30-11	1SBL411022R8111	1.200
			48	48	1 1	UA75-30-11	1SBL411022R8311	1.200
			110	110...120	1 1	UA75-30-11	1SBL411022R8411	1.200
			220...230	230...240	1 1	UA75-30-11	1SBL411022R8011	1.200
			230...240	240...260	1 1	UA75-30-11	1SBL411022R8811	1.200
			380...400	400...415	1 1	UA75-30-11	1SBL411022R8511	1.200
			400...415	415...440	1 1	UA75-30-11	1SBL411022R8611	1.200

(1) Other control voltages see voltage code table.

#### Main dimensions mm, inches

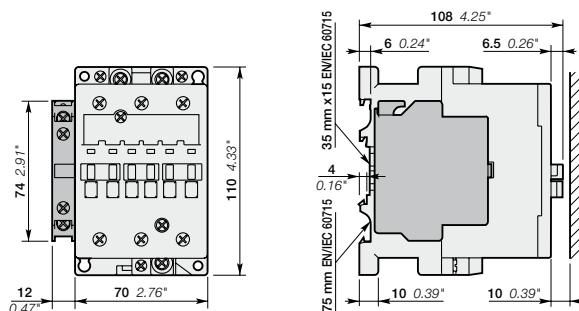

UA50, UA63, UA75 with 1 N.O. + 1 N.C. auxiliary contacts

# UA95 ... UA110 3-pole contactors for capacitor switching 65 to 75 kvar - peak current $\hat{I} \leq 100$ times the rms current AC operated



UA110-30-00

## Description

UA contactors can be used for the switching of capacitor banks whose inrush current peaks are less or equal to 100 times nominal rms current. The capacitors must be discharged (maximum residual voltage at terminals  $\leq 50$  V) before being re-energized when the contactors are making.

These contactors are of the block type design with:

- 3 main poles
- control circuit: AC operated
- add-on auxiliary contact blocks for front or side mounting and a wide range of accessories.

## Ordering details

IEC Rated operational power $\theta \leq 40^\circ\text{C}$ 400 V AC-6b kvar	Max peak current $\hat{I}$ kA	UL/CSA Rated operational power $\theta \leq 40^\circ\text{C}$ 480 V kvar	Rated control circuit voltage $U_c$ (1)		Auxiliary contacts fitted  Y Z	Type	Order code	Weight  Pkg (1 pce)  kg
			V 50 Hz	V 60 Hz				
65	9.3	70	24	24	0 0	UA95-30-00	1SFL431022R8100	2.000
			48	48	0 0	UA95-30-00	1SFL431022R8300	2.000
			110	110...120	0 0	UA95-30-00	1SFL431022R8400	2.000
			220...230	230...240	0 0	UA95-30-00	1SFL431022R8000	2.000
			230...240	240...260	0 0	UA95-30-00	1SFL431022R8800	2.000
			380...400	400...415	0 0	UA95-30-00	1SFL431022R8500	2.000
			400...415	415...440	0 0	UA95-30-00	1SFL431022R8600	2.000
75	10.5	80	24	24	0 0	UA110-30-00	1SFL451022R8100	2.000
			48	48	0 0	UA110-30-00	1SFL451022R8300	2.000
			110	110...120	0 0	UA110-30-00	1SFL451022R8400	2.000
			220...230	230...240	0 0	UA110-30-00	1SFL451022R8000	2.000
			230...240	240...260	0 0	UA110-30-00	1SFL451022R8800	2.000
			380...400	400...415	0 0	UA110-30-00	1SFL451022R8500	2.000
			400...415	415...440	0 0	UA110-30-00	1SFL451022R8600	2.000

(1) Other control voltages see voltage code table.

## Main dimensions mm, inches

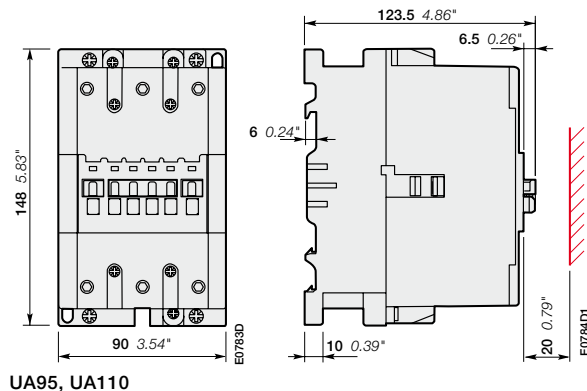

# UA95 ... UA110 3-pole contactors for capacitor switching

65 to 75 kvar - peak current  $\hat{I} < 100$  times the rms current  
AC operated with 1 N.O. + 1 N.C. auxiliary contacts



1SFC580105FC033



UA110-30-11

## Description

UA contactors can be used for the switching of capacitor banks whose inrush current peaks are less or equal to 100 times nominal rms current.  
The capacitors must be discharged (maximum residual voltage at terminals  $\leq 50$  V) before being re-energized when the contactors are making.  
These contactors are of the block type design with:

- 3 main poles
- control circuit: AC operated
- add-on auxiliary contact blocks for front or side mounting and a wide range of accessories

## Ordering details

IEC Rated operational power AC-6b $\theta \leq 40^\circ\text{C}$ 400 V kvar	Max peak current $\hat{I}$ kA	UL/CSA Rated operational power 40 °C 400 V kvar	Rated control circuit voltage Uc (1)		Auxiliary contacts fitted		Type	Order code	Weight Pkg (1 pce) kg
			V 50 Hz	V 60 Hz					
65	9.3	70	24	24	1	1	UA95-30-11	1SFL431022R8111	2.040
			48	48	1	1	UA95-30-11	1SFL431022R8311	2.040
			110	110...120	1	1	UA95-30-11	1SFL431022R8411	2.040
			220...230	230...240	1	1	UA95-30-11	1SFL431022R8011	2.040
			230...240	240...260	1	1	UA95-30-11	1SFL431022R8811	2.040
			380...400	400...415	1	1	UA95-30-11	1SFL431022R8511	2.040
			400...415	415...440	1	1	UA95-30-11	1SFL431022R8611	2.040
75	10.5	80	24	24	1	1	UA110-30-11	1SFL451022R8111	2.040
			48	48	1	1	UA110-30-11	1SFL451022R8311	2.040
			110	110...120	1	1	UA110-30-11	1SFL451022R8411	2.040
			220...230	230...240	1	1	UA110-30-11	1SFL451022R8011	2.040
			230...240	240...260	1	1	UA110-30-11	1SFL451022R8811	2.040
			380...400	400...415	1	1	UA110-30-11	1SFL451022R8511	2.040
			400...415	415...440	1	1	UA110-30-11	1SFL451022R8611	2.040

(1) Other control voltages see voltage code table.

## Main dimensions mm, inches

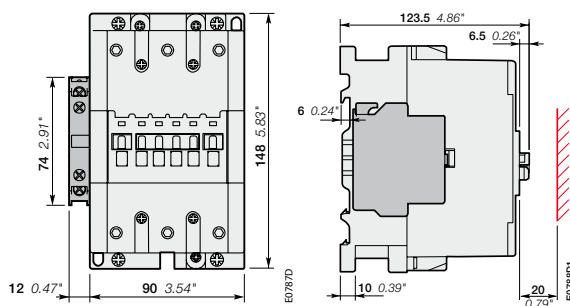

UA95, UA110

# UA... 3-pole contactors for capacitor switching

## Peak current $\hat{I} \leq 100$ times the rms current

### Main accessory fitting details

Many configurations of accessories are possible depending on whether these are front-mounted or side-mounted.

Contactor types	Main poles	Available auxiliary contacts	Front-mounted accessories		Pneumatic timer	Side-mounted accessories			
			Auxiliary contact blocks			Auxiliary contact blocks			
			1-pole CA5-..	4-pole CA5-..	TP.. A	2-pole CAL...			
UA16-30-10	3	0	1	0	1 to 4 x CA5-..	or 1 x CA5-.. (4-pole)	or 1 x TP.. A	+	1 to 2 x CAL5-11
UA26-30-10	3	0	1	0	1 to 4 x CA5-..	or 1 x CA5-.. (4-pole)	or 1 x TP.. A	+	1 to 2 x CAL5-11
UA30-30-10	3	0	1	0	1 to 5 x CA5-..	or 1 x CA5-.. (4-pole) + 1 x 1-pole CA5-..	or 1 x TP.. A + 1 x CA5-.. (1-pole)	+	1 to 2 x CAL5-11
UA50-30-00	3	0	0	0	1 to 6 x CA5-..	or 1 x CA5-.. (4-pole) + 2 x 1-pole CA5-..	or 1 x TP.. A + 2 x CA5-.. (1-pole)	+	1 to 2 x CAL5-11
UA63-30-00	3	0	0	0					
UA75-30-00	3	0	0	0					
UA95-30-00	3	0	0	0	1 to 6 x CA5-..	or 1 x CA5-.. (4-pole) + 2 x 1-pole CA5-..	-	+	1 to 2 x CAL18-11
UA110-30-00	3	0	0	0					

# UA16 ... UA110 3-pole contactors for capacitor switching

## Peak current $\hat{I} \leq 100$ times the rms current

### Technical data

#### Main pole - Utilization characteristics according to IEC

Contactor types	AC operated	UA16	UA26	UA30	UA50	UA63	UA75	UA95	UA110	
Standards		IEC 60947-1 / 60947-4-1 and EN 60947-1 / 60947-4-1								
Rated operational voltage $U_e$ max.		690 V								
Rated frequency (without derating)		50 / 60 Hz								
<b>AC-6b Utilization category</b>										
<b>Rated operational power AC-6b (1)</b>										
For air temperature close to contactor	$\theta \leq 40^\circ\text{C}$	230-240 V	7.5 kvar	12 kvar	16 kvar	20 kvar	25 kvar	30 kvar	35 kvar	40 kvar
		400-415 V	12.5 kvar	20 kvar	27.5 kvar	33 kvar	45 kvar	50 kvar	65 kvar	75 kvar
	$\theta \leq 55^\circ\text{C}$	440 V	13.7 kvar	22 kvar	30 kvar	36 kvar	50 kvar	55 kvar	65 kvar	75 kvar
		500-550 V	15.5 kvar	22 kvar	34 kvar	40 kvar	50 kvar	62 kvar	70 kvar	80 kvar
	$\theta \leq 70^\circ\text{C}$	690 V	21.5 kvar	30 kvar	45 kvar	55 kvar	70 kvar	75 kvar	80 kvar	90 kvar
		230-240 V	6.7 kvar	11 kvar	16 kvar	20 kvar	25 kvar	30 kvar	35 kvar	40 kvar
	$\theta \leq 55^\circ\text{C}$	400-415 V	11.7 kvar	18.5 kvar	27.5 kvar	33 kvar	43 kvar	50 kvar	65 kvar	70 kvar
		440 V	13 kvar	20 kvar	30 kvar	36 kvar	48 kvar	53 kvar	65 kvar	75 kvar
	$\theta \leq 70^\circ\text{C}$	500-550 V	14.7 kvar	22 kvar	34 kvar	40 kvar	50 kvar	62 kvar	70 kvar	80 kvar
		690 V	20 kvar	30 kvar	45 kvar	55 kvar	70 kvar	75 kvar	80 kvar	90 kvar
	$\theta \leq 55^\circ\text{C}$	230-240 V	6 kvar	8.5 kvar	11 kvar	19 kvar	21 kvar	22 kvar	30 kvar	35 kvar
		400-415 V	10 kvar	14.5 kvar	19 kvar	32 kvar	37 kvar	39 kvar	55 kvar	65 kvar
	$\theta \leq 70^\circ\text{C}$	440 V	11 kvar	16 kvar	20 kvar	35 kvar	41 kvar	43 kvar	55 kvar	70 kvar
		500-550 V	12.5 kvar	19.5 kvar	23.5 kvar	40 kvar	45 kvar	47.5 kvar	60 kvar	75 kvar
	$\theta \leq 55^\circ\text{C}$	690 V	17 kvar	25 kvar	32 kvar	52 kvar	60 kvar	65 kvar	70 kvar	85 kvar
		230-240 V	1.8 kA	3 kA	3.5 kA	5 kA	6.5 kA	7.5 kA	9.3 kA	10.5 kA
Max. permissible peak current $\hat{I}$	$U_e \leq 500\text{ V}$	400-415 V	1.6 kA	2.7 kA	3.1 kA	4.5 kA	5.8 kA	6.75 kA	8 kA	9 kA
		690 V	1.6 kA	2.7 kA	3.1 kA	4.5 kA	5.8 kA	6.75 kA	8 kA	9 kA
<b>Short-circuit protection device for contactors</b>										
gG type fuse		sized 1.5...1.8 $I_n$ of the capacitor								
<b>Max. electrical switching frequency</b>										
		240 cycles/h								
<b>Electrical durability AC-6b</b>										
	$U_e \leq 690\text{ V}$	100 000 operating cycles								

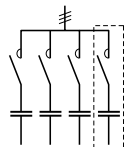

Multi-step capacitor bank scheme

(1) For 220 V and 380 V, multiply by 0.9 the rated values at 230 V and 400 V respectively.  
Example: 50 kvar / 400 V corresponding to  $0.9 \times 50 = 45 \text{ kvar}/380 \text{ V}$ .

If, in an application, the current peak is greater than the maximum peak current  $\hat{I}$  specified in the tables above, select a higher rating, refer to the UA..RA contactors, or add inductances. (see application guide "Contactors for capacitor switching").

#### Main pole - Utilization characteristics according to UL / CSA

Contactor types	AC operated	UA16	UA26	UA30	UA50	UA63	UA75	UA95	UA110	
<b>Power - 60 Hz</b>										
For air temperature close to contactor	$\theta \leq 40^\circ\text{C}$	240 V	-	12.5 kvar	16 kvar	20 kvar	-	27.5 kvar	35 kvar	40 kvar
		480 V	-	25 kvar	32 kvar	40 kvar	-	55 kvar	70 kvar	80 kvar
		600 V	-	30 kvar	40 kvar	50 kvar	-	70 kvar	75 kvar	85 kvar







If, in an application, the current peak is greater than the maximum peak current  $\hat{I}$  specified in the tables above, select a higher rating, refer to the UA..RA contactors, or add inductances. (see application guide "Contactors for capacitor switching").

# UA16 ... UA110 3-pole contactors for capacitor switching

## Peak current $\hat{I} \leq 100$ times the rms current

### Technical data

#### Connecting characteristics

Contactor types		AC operated	UA16	UA26	UA30	UA50 UA63 UA75	UA95 UA110	
<b>Connection capacity (min. ... max.)</b>								
<b>Main conductors (poles)</b>								
	Rigid	Solid ( $\leq 4 \text{ mm}^2$ )	1 x 1...4 mm <sup>2</sup>	1.5...6 mm <sup>2</sup>	2.5...16 mm <sup>2</sup>	6...50 mm <sup>2</sup>	10...95 mm <sup>2</sup>	
		Stranded ( $\geq 6 \text{ mm}^2$ )	2 x 1...4 mm <sup>2</sup>	1.5...6 mm <sup>2</sup>	2.5...16 mm <sup>2</sup>	6...25 mm <sup>2</sup>	6...35 mm <sup>2</sup>	
	Flexible with ferrule		1 x 0.75...2.5 mm <sup>2</sup>	0.75...4 mm <sup>2</sup>	2.5...10 mm <sup>2</sup>	6...35 mm <sup>2</sup>	10...70 mm <sup>2</sup>	
			2 x 0.75...2.5 mm <sup>2</sup>	0.75...4 mm <sup>2</sup>	2.5...10 mm <sup>2</sup>	6...16 mm <sup>2</sup>	6...35 mm <sup>2</sup>	
	Bars or lugs		L $\leq$ 7.7 mm	10 mm	-	-	-	
			I $>$ 3.7 mm	4.2 mm	-	-	-	
Connection capacity acc. to UL/CSA			1 or 2 x AWG 18...10	AWG 12...8	AWG 8...4	AWG 8...1	AWG 6...2/0	
Tightening torque		Recommended	1 Nm / 9 lb.in	1.7 Nm / 15 lb.in	2.3 Nm / 20 lb.in	4 Nm / 35 lb.in	8 Nm / 71 lb.in	
		Max.	1.2 Nm	2.2 Nm	2.6 Nm	4.5 Nm	9 Nm	
<b>Auxiliary conductors</b> (built-in auxiliary terminals + coil terminals)								
	Rigid solid		1 x 1...4 mm <sup>2</sup>				0.75...2.5 mm <sup>2</sup>	
			2 x 1...4 mm <sup>2</sup>				0.75...2.5 mm <sup>2</sup>	
	Flexible with ferrule		1 x 0.75...2.5 mm <sup>2</sup>			1...2.5 mm <sup>2</sup>	0.75...2.5 mm <sup>2</sup>	
			2 x 0.75...2.5 mm <sup>2</sup>					
	Lugs	Coil terminals	L $\leq$ 8 mm					
			I $>$ 3.7 mm					
		Built-in auxiliary terminals	L $\leq$ 7.7 mm	10 mm	8 mm	-	-	
			I $>$ 3.7 mm	4.2 mm	3.7 mm	-	-	
Connection capacity acc. to UL/CSA			AWG 18...14					
Tightening torque								
Coil terminals		Recommended	1 Nm / 9 lb.in					
		Max.	1.2 Nm					
Built-in auxiliary terminals		Recommended	1 Nm / 9 lb.in					
		Max.	1.2 Nm					
<b>Degree of protection</b> acc. to IEC 60947-1 / EN 60947-1 and IEC 60529 / EN 60529								
Main terminals			IP20			IP10		
Coil terminals			IP20					
Built-in auxiliary terminals			IP20					
<b>Screw terminals</b>								
Main terminals			Delivered in open position, screws of unused terminals must be tightened					
			M3.5	M4	M5	M6	M8	
		<b>Screwdriver type</b>	Flat $\varnothing$ 5.5 / Pozidriv 2		Flat $\varnothing$ 6.5 / Pozidriv 2		Hexagon socket (s = 4 mm)	
Coil terminals			M3.5					
		<b>Screwdriver type</b>	Flat $\varnothing$ 5.5 / Pozidriv 2					
Built-in auxiliary terminals			M3.5	M4	M3.5			
		<b>Screwdriver type</b>	Flat $\varnothing$ 5.5 / Pozidriv 2					

Other technical characteristics are the same as those of standard A contactors.

# UA... contactors

## Terminal marking and positioning

### UA... contactors - AC operated

Standard devices without addition of auxiliary contacts

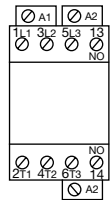

UA16 ... UA30-30-10

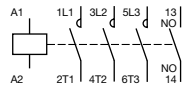

UA16 ... UA30-30-10

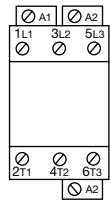

UA50 ... UA110-30-00

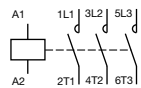

UA50 ... UA110-30-00

Standard devices with factory mounted auxiliary contacts

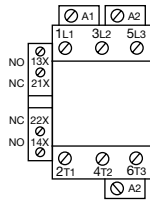

UA50 ... UA110-30-11

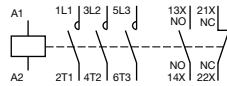

UA50 ... UA110-30-11

# UA.. 3-pole contactors for capacitor switching

## Main dimensions mm, inches

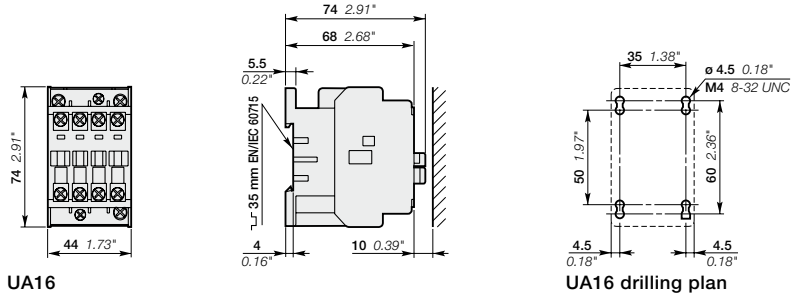

5

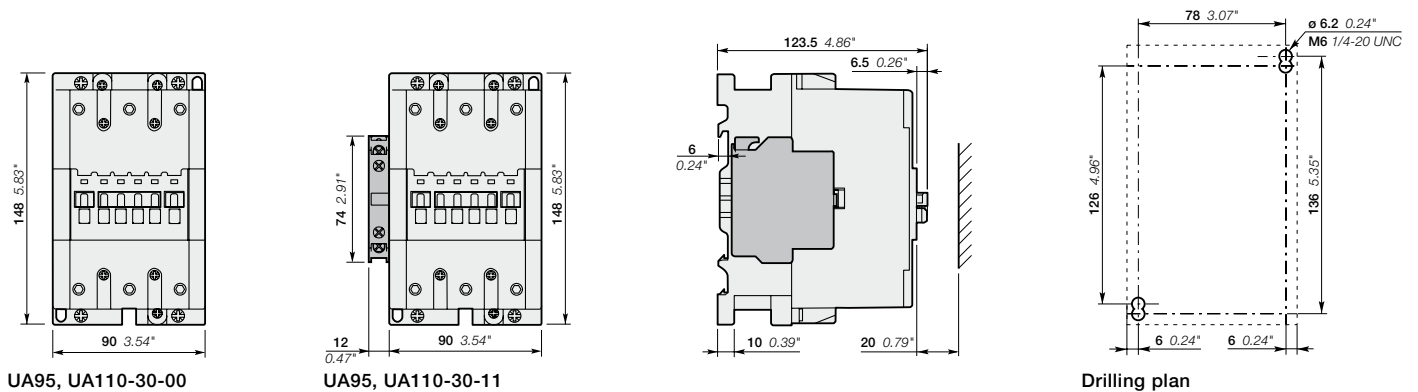
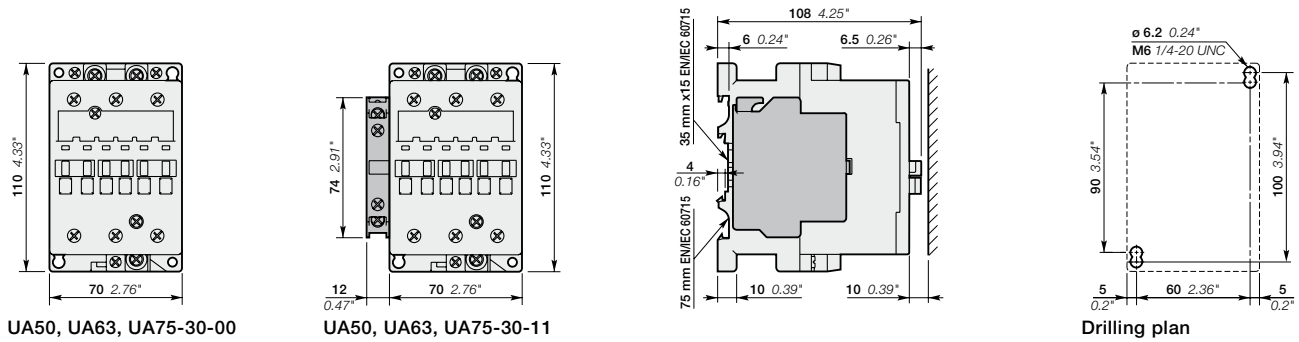
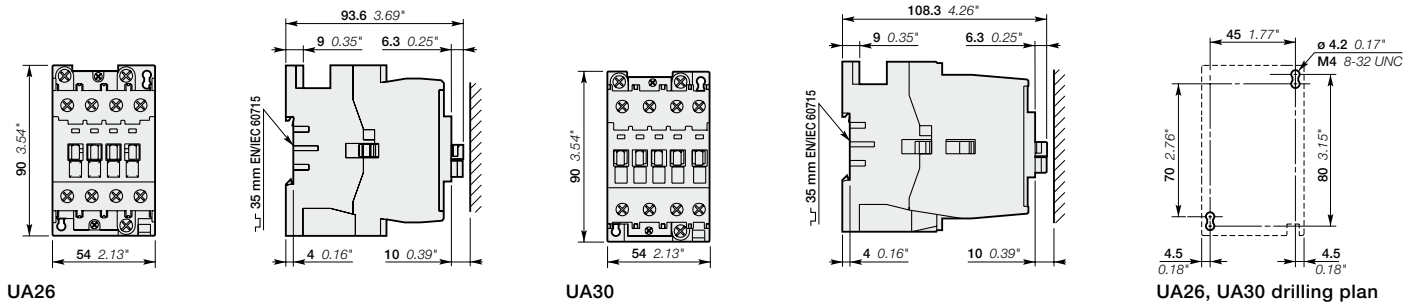

1SBC101572S0201



# Notes

A series of horizontal dotted lines for taking notes, spanning the width of the page.



# NF 4-pole and 8-pole contactor relays

## Ordering details 4-pole contactor relays

NF AC / DC operated	5/180
NFZ AC / DC operated - low consumption	5/181
Main accessories	5/182

## Ordering details 8-pole contactor relays

NF AC / DC operated	5/184
NFZ AC / DC operated - low consumption	5/185
Main accessories	5/186

<b>Technical data</b>	<b>5/188</b>
-----------------------	--------------

<b>Terminal marking and positioning</b>	<b>5/191</b>
---	--------------

<b>Main dimensions</b>	<b>5/193</b>
------------------------	--------------

<b>Voltage code table</b>	<b>5/268</b>
---------------------------	--------------

# NF 4-pole contactor relays

## AC / DC operated



NF22E

1SBCT0104R0014

### Description

NF contactor relays are used for switching auxiliary and control circuits.

These contactor relays are of the block type design with:

- 4 poles. Contactor relays have mechanically linked auxiliary contact elements (side-marked symbol)
- control circuit: AC or DC operated with electronic coil interface accepting a wide control voltage range (e.g. 100...250 V AC and DC)
  - can manage large control voltage variations
  - only 4 control voltage ranges covering 24...500 V 50/60 Hz and 20...500 V DC
  - reduced panel energy consumption
  - very distinct closing and opening.
- built-in surge suppression
- add-on auxiliary contact blocks for front or side mounting and a wide range of accessories.

### Ordering details

Number of contacts	Rated control circuit voltage		Type	Order code	Weight
	Uc min. ... Uc max.				
	V 50/60 Hz	V DC			kg
	24...60	-	(1) NF22E-41	1SBH137001R4122	0.270
	48...130	48...130	NF22E-12	1SBH137001R1222	0.270
	100...250	100...250	NF22E-13	1SBH137001R1322	0.270
	250...500	250...500	NF22E-14	1SBH137001R1422	0.310
	24...60	-	(1) NF31E-41	1SBH137001R4131	0.270
	48...130	48...130	NF31E-12	1SBH137001R1231	0.270
	100...250	100...250	NF31E-13	1SBH137001R1331	0.270
	250...500	250...500	NF31E-14	1SBH137001R1431	0.310
	24...60	-	(1) NF40E-41	1SBH137001R4140	0.270
	48...130	48...130	NF40E-12	1SBH137001R1240	0.270
	100...250	100...250	NF40E-13	1SBH137001R1340	0.270
	250...500	250...500	NF40E-14	1SBH137001R1440	0.310

(1) For 24...60 V 50/60 Hz - 20...60 V DC, use NF..E-11 (see voltage code table).  
NF..E-11 not suitable for direct control by PLC-output.

### Main dimensions mm, inches

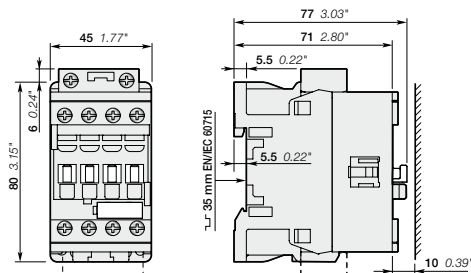

NF22E, NF31E, NF40E

1SBCT01056S0201 - Rev. A

# NFZ 4-pole contactor relays

## AC / DC operated - low consumption



NFZ22E

### Description

NFZ contactor relays are used for switching auxiliary and control circuits.

These contactor relays are of the block type design with:

- 4 poles. Contactor relays have mechanically linked auxiliary contact elements (side-marked symbol)
- control circuit: AC or DC operated with electronic coil interface accepting a wide control voltage range (e.g. 100...250 V AC and DC)
  - can manage large control voltage variations
  - only 4 control voltage ranges covering 24...250 V 50/60 Hz and 12...250 V DC
  - allow direct control by PLC-output  $\geq 24$  V DC 500 mA
  - reduced panel energy consumption
  - very distinct closing and opening
  - can withstand short voltage dips and voltage sags (SEMI F47-0706 conditions of use on request).
- built-in surge suppression
- add-on auxiliary contact blocks for front or side mounting and a wide range of accessories.

### Ordering details

Number of contacts	Rated control circuit voltage Uc min. ... Uc max.		Type	Order code	Weight Pkg (1 pce) kg
	V 50/60 Hz	V DC			
	-	12...20	NFZ22E-20	1SBH136001R2022	0.310
	24...60	20...60	NFZ22E-21	1SBH136001R2122	0.310
	48...130	48...130	NFZ22E-22	1SBH136001R2222	0.310
	100...250	100...250	NFZ22E-23	1SBH136001R2322	0.310
	-	12...20	NFZ31E-20	1SBH136001R2031	0.310
	24...60	20...60	NFZ31E-21	1SBH136001R2131	0.310
	48...130	48...130	NFZ31E-22	1SBH136001R2231	0.310
	100...250	100...250	NFZ31E-23	1SBH136001R2331	0.310
	-	12...20	NFZ40E-20	1SBH136001R2040	0.310
	24...60	20...60	NFZ40E-21	1SBH136001R2140	0.310
	48...130	48...130	NFZ40E-22	1SBH136001R2240	0.310
	100...250	100...250	NFZ40E-23	1SBH136001R2340	0.310

Note: Only NFZ contactor relays with DC control voltage 12...20 V DC need to respect the connection polarities indicated close to the coil terminals: A1+ for the positive pole and A2- for the negative pole.

### Main dimensions mm, inches

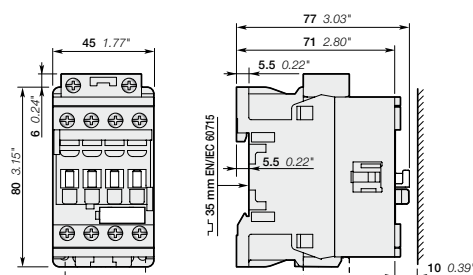

NFZ22E, NFZ31E, NFZ40E

# NF 4-pole contactor relays

## Main accessories

### Contactor relays and main accessories (other accessories available)

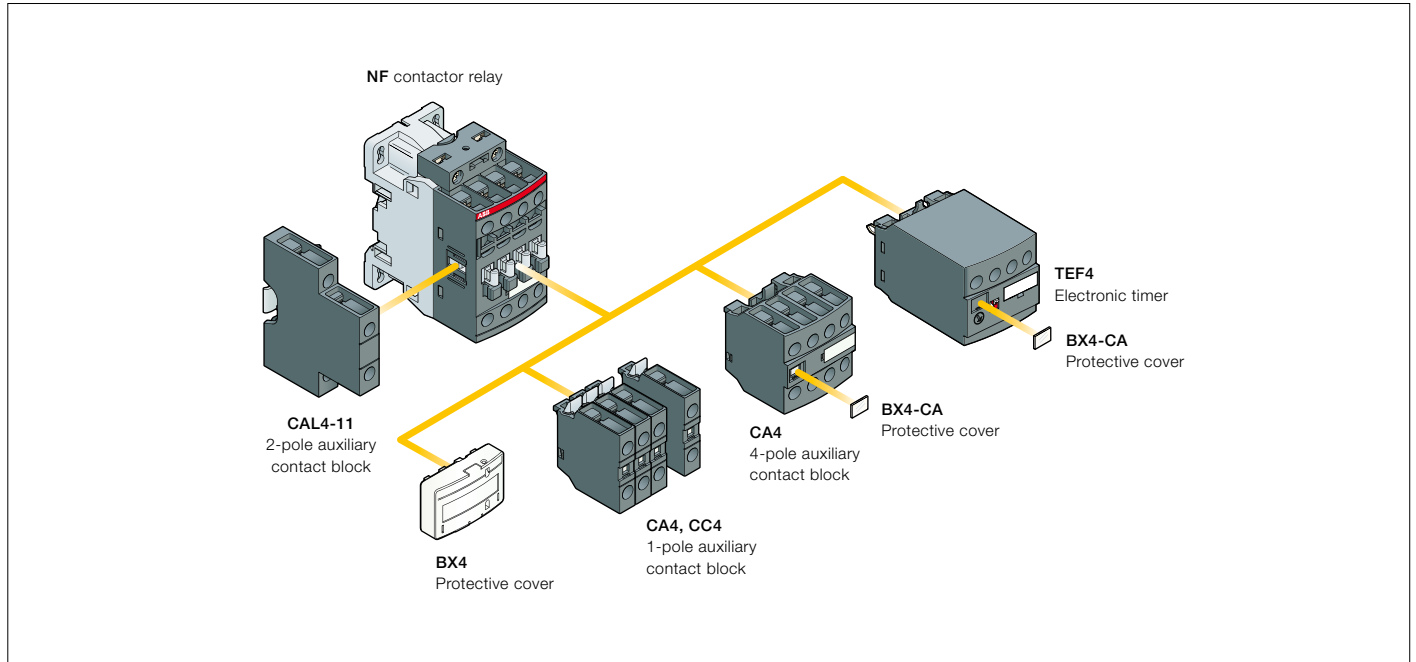

### Main accessory fitting details

Many configurations of accessories are possible depending on whether these are front-mounted or side-mounted.

Contactor relay types	Main poles	Front-mounted accessories			Side-mounted accessories	
		Auxiliary contact blocks		Electronic timer	Auxiliary contact blocks	
		1-pole CA4	4-pole CA4	TEF4	Left side 2-pole CAL4-11	Right side
		Max. add-on N.C. auxiliary contacts: 3 N.C. max. on positions 1, 2, 3, 4 and 2 N.C. max. on positions 1 ±30°, 5				
NF	2 2 E	4 max.	or 1	or 1	+ 1	-
	3 1 E	2 max.	-	or 1	+ 1	+ 1
		Max. add-on N.C. auxiliary contacts: 4 N.C. max. on positions 1, 2, 3, 4 and 3 N.C. max. on positions 1 ±30°, 5				
NF	4 0 E	4 max.	or 1	or 1	+ 1	-
		2 max.	-	or 1	+ 1	+ 1

# NF 4-pole contactor relays

## Main accessories



CA4-10



CA4-22N



CAL4-11



TEF4-ON



LDC4



BX4



BX4-CA

### Ordering details (1)

For contactor relays	Auxiliary contacts	Type	Order code	Pkg qty	Weight (1 pce)
					kg

### Front-mounted instantaneous auxiliary contact blocks

4-pole NF	1 0	- -	CA4-10	1SBN010110R1010	1	0.014
	1 0	- -	CA4-10-T	1SBN010110T1010	10	0.014
	0 1	- -	CA4-01	1SBN010110R1001	1	0.014
	0 1	- -	CA4-01-T	1SBN010110T1001	10	0.014
	4 0	- -	CA4-40N	1SBN010140R1240	1	0.055
	3 1	- -	CA4-31N	1SBN010140R1231	1	0.055
	2 2	- -	CA4-22N	1SBN010140R1222	1	0.055
NF..40E	1 3	- -	CA4-13N	1SBN010140R1213	1	0.055
	0 4	- -	CA4-04N	1SBN010140R1204	1	0.055

### Front-mounted auxiliary contact blocks with N.O. leading contact and N.C. lagging contact

4-pole NF	- -	1 0	CC4-10	1SBN010111R1010	1	0.014
	- -	0 1	CC4-01	1SBN010111R1001	1	0.014

### Side-mounted instantaneous auxiliary contact blocks

NF	1 1	- -	CAL4-11	1SBN010120R1011	1	0.040
	1 1	- -	CAL4-11-T	1SBN010120T1011	10	0.040

For contactors	Time delay range selected by switch	Delay type	Auxiliary contacts	Type	Order code	Pkg qty	Weight (1 pce)
							kg

### Electronic timers

NF	0.1...1 s	ON-delay	1 1	TEF4-ON	1SBN020112R1000	1	0.065
	1...10 s 10...100 s	OFF-delay	1 1	TEF4-OFF	1SBN020114R1000	1	0.065

Note: Rated control circuit voltage  $U_c$  24...240 V 50/60 Hz or DC.

### Additional coil terminal block

NF	LDC4	1SBN070156T1000	10	0.010
----	------	-----------------	----	-------

### Protective covers

All 1-stack contactor relays	BX4	1SBN110108T1000	10	0.006
4-pole CA4 auxiliary contact blocks and TEF4 electronic timer	BX4-CA	1SBN110109W1000	50	0.001

(1) For more information, refer to "Accessories" section.

# NF 8-pole contactor relays

## AC / DC operated



NF44E

### Description

NF contactor relays are used for switching auxiliary and control circuits.

These contactor relays are of the block type design with:

- 8 poles with a permanently fixed 4-pole auxiliary contact block. Contactor relays have mechanically linked auxiliary contact elements (side-marked symbol)
- control circuit: AC or DC operated with electronic coil interface accepting a wide control voltage range (e.g. 100...250 V AC and DC)
  - can manage large control voltage variations
  - only 4 control voltage ranges covering 24...500 V 50/60 Hz and 20...500 V DC
  - reduced panel energy consumption
  - very distinct closing and opening
- built-in surge suppression
- add-on auxiliary contact blocks for side mounting and a wide range of accessories.

### Ordering details

Number of contacts		Rated control circuit voltage Uc min. ... Uc max.	Type	Order code	Weight kg	
1st stack	2nd stack					
		24...60	-	(1): NF44E-41	1SBH137001R4144	0.320
		48...130	48...130	NF44E-12	1SBH137001R1244	0.320
		100...250	100...250	NF44E-13	1SBH137001R1344	0.320
		250...500	250...500	NF44E-14	1SBH137001R1444	0.360
		24...60	-	(1): NF53E-41	1SBH137001R4153	0.320
		48...130	48...130	NF53E-12	1SBH137001R1253	0.320
		100...250	100...250	NF53E-13	1SBH137001R1353	0.320
		250...500	250...500	NF53E-14	1SBH137001R1453	0.360
		24...60	-	(1): NF62E-41	1SBH137001R4162	0.320
		48...130	48...130	NF62E-12	1SBH137001R1262	0.320
		100...250	100...250	NF62E-13	1SBH137001R1362	0.320
		250...500	250...500	NF62E-14	1SBH137001R1462	0.360
		24...60	-	(1): NF71E-41	1SBH137001R4171	0.320
		48...130	48...130	NF71E-12	1SBH137001R1271	0.320
		100...250	100...250	NF71E-13	1SBH137001R1371	0.320
		250...500	250...500	NF71E-14	1SBH137001R1471	0.360
		24...60	-	(1): NF80E-41	1SBH137001R4180	0.320
		48...130	48...130	NF80E-12	1SBH137001R1280	0.320
		100...250	100...250	NF80E-13	1SBH137001R1380	0.320
		250...500	250...500	NF80E-14	1SBH137001R1480	0.360

(1) For 24...60 V 50/60 Hz - 20...60 V DC, use NF..E-11 (see voltage code table).  
NF..E-11 not suitable for direct control by PLC-output.

### Main dimensions mm, inches

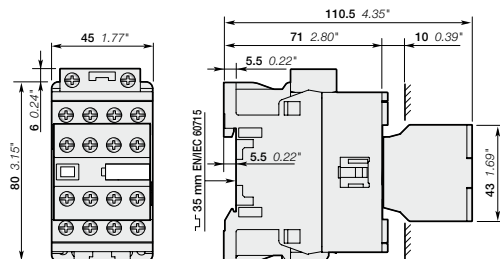

NF44E, NF53E, NF62E, NF71E, NF80E



# NFZ 8-pole contactor relays

## AC / DC operated – Low consumption



NFZ44E

1SBCT0106F0014

### Description

NFZ contactor relays are used for switching auxiliary and control circuits.

These contactor relays are of the block type design with:

- 8 poles with a permanently fixed 4-pole auxiliary contact block. Contactor relays have mechanically linked auxiliary contact elements (side-marked symbol)
- control circuit: AC or DC operated with electronic coil interface accepting a wide control voltage range (e.g. 100...250 V AC and DC)
  - can manage large control voltage variations
  - only 4 control voltage ranges covering 24...250 V 50/60 Hz and 12...250 V DC
  - allow direct control by PLC-output  $\geq 24$  VDC 500 mA
  - reduced panel energy consumption
  - very distinct closing and opening
  - can withstand short voltage dips and voltage sags (SEMI F47-0706 conditions of use on request).
- built-in surge suppression
- add-on auxiliary contact blocks for side mounting and a wide range of accessories.

### Ordering details

Number of contacts		Rated control circuit voltage		Type	Order code	Weight
1st stack	2nd stack	Uc min. ... Uc max.				
		V 50/60 Hz	V DC			
		–	12...20	NFZ44E-20	1SBH136001R2044	0.360
		24...60	20...60	NFZ44E-21	1SBH136001R2144	0.360
		48...130	48...130	NFZ44E-22	1SBH136001R2244	0.360
		100...250	100...250	NFZ44E-23	1SBH136001R2344	0.360
		–	12...20	NFZ53E-20	1SBH136001R2053	0.360
		24...60	20...60	NFZ53E-21	1SBH136001R2153	0.360
		48...130	48...130	NFZ53E-22	1SBH136001R2253	0.360
		100...250	100...250	NFZ53E-23	1SBH136001R2353	0.360
		–	12...20	NFZ62E-20	1SBH136001R2062	0.360
		24...60	20...60	NFZ62E-21	1SBH136001R2162	0.360
		48...130	48...130	NFZ62E-22	1SBH136001R2262	0.360
		100...250	100...250	NFZ62E-23	1SBH136001R2362	0.360
		–	12...20	NFZ71E-20	1SBH136001R2071	0.360
		24...60	20...60	NFZ71E-21	1SBH136001R2171	0.360
		48...130	48...130	NFZ71E-22	1SBH136001R2271	0.360
		100...250	100...250	NFZ71E-23	1SBH136001R2371	0.360
		–	12...20	NFZ80E-20	1SBH136001R2080	0.360
		24...60	20...60	NFZ80E-21	1SBH136001R2180	0.360
		48...130	48...130	NFZ80E-22	1SBH136001R2280	0.360
		100...250	100...250	NFZ80E-23	1SBH136001R2380	0.360

Note: Only NFZ contactor relays with DC control voltage 12...20 V DC need to respect the connection polarities indicated close to the coil terminals: A1+ for the positive pole and A2- for the negative pole.

### Main dimensions mm, inches

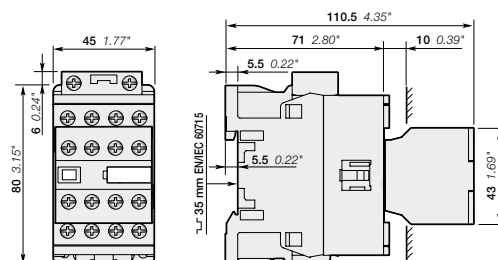

NFZ44E, NFZ53E, NFZ62E, NFZ71E, NFZ80E

# NF 8-pole contactor relays

## Main accessories

### Contactor relays and main accessories (other accessories available)

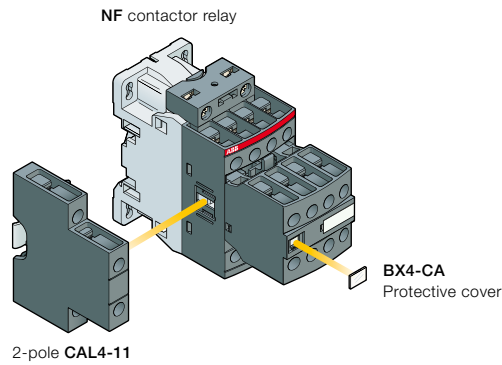

### Main accessory fitting details

Many configurations of accessories are possible depending on whether these are front-mounted or side-mounted.

Contactor relay types	Main poles	Front-mounted accessories		Side-mounted accessories																
		Auxiliary contact blocks		Auxiliary contact blocks																
		1-pole CA4 1-pole CC4	4-pole CA4	Left side 2-pole CAL4-11	Right side															
NF	<table border="0"> <tr><td>4</td><td>4</td><td>E</td></tr> <tr><td>5</td><td>3</td><td>E</td></tr> <tr><td>6</td><td>2</td><td>E</td></tr> <tr><td>7</td><td>1</td><td>E</td></tr> <tr><td>8</td><td>0</td><td>E</td></tr> </table>	4	4	E	5	3	E	6	2	E	7	1	E	8	0	E	-	-	+	1
4	4	E																		
5	3	E																		
6	2	E																		
7	1	E																		
8	0	E																		

# NF 8-pole contactor relays

## Main accessories



CAL4-11

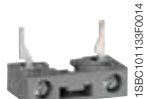

LDC4



BX4-CA

### Ordering details (1)

For contactor relays	Auxiliary contacts	Type	Order code	Pkg qty	Weight (1 pce)
					kg

### Side-mounted instantaneous auxiliary contact blocks

NF	1 1	- -	CAL4-11	1SBN010120R1011	1	0.040
	1 1	- -	CAL4-11-T	1SBN010120T1011	10	0.040

### Additional coil terminal block

NF	LDC4	1SBN070156T1000	10	0.010
----	------	-----------------	----	-------

### Protective covers

NF	BX4-CA	1SBN110109W1000	50	0.001
----	--------	-----------------	----	-------

(1) For more information, refer to "Accessories" section.

# NF contactor relays

## Technical data

### Contact utilization characteristics according to IEC

Contactor relay types	AC / DC operated	NF
Standards		IEC 60947-1 / 60947-5-1 and EN 60947-1 / 60947-5-1
Rated operational voltage $U_e$ max.		690 V
Rated frequency (without derating)		50 / 60 Hz
Conventional free-air thermal current $I_{th}$ $\theta \leq 40$ °C		16 A
le / Rated operational current AC-15		
acc. to IEC 60947-5-1	24-127 V 50/60 Hz	6 A
	220-240 V 50/60 Hz	4 A
	400-440 V 50/60 Hz	3 A
	500 V 50/60 Hz	2 A
	690 V 50/60 Hz	2 A
Rated making capacity AC-15		10 x le AC-15 acc. to IEC 60947-5-1
Rated breaking capacity AC-15		10 x le AC-15 acc. to IEC 60947-5-1
le / Rated operational current DC-13		
acc. to IEC 60947-5-1	24 V DC	6 A / 144 W
	48 V DC	2.8 A / 134 W
	72 V DC	1 A / 72 W
	110 V DC	0.55 A / 60 W
	125 V DC	0.55 A / 69 W
	220 V DC	0.27 A / 60 W
	250 V DC	0.27 A / 68 W
	400 V DC	0.15 A / 60 W
	500 V DC	0.13 A / 65 W
	600 V DC	0.1 A / 60 W
Short-circuit protection device gG type fuse		10 A
Rated short-time withstand current $I_{cw}$	for 1.0 s	100 A
	for 0.1 s	140 A
Minimum switching capacity		12 V / 3 mA
with failure rate acc. to IEC 60947-5-4		$10^{-7}$
Non-overlapping time between N.O. and N.C. contacts		$\geq 2$ ms
Power dissipation per pole at 6 A		0.1 W
Max. electrical switching frequency	AC-15	1200 cycles/h
	DC-13	900 cycles/h
Mechanically linked contacts		Built-in N.O. or N.C. auxiliary contacts and additional N.O. or N.C. auxiliary contacts (CA4, CAL4 aux. contact blocks) are mechanically linked contacts.
acc. to annex L of IEC 60947-5-1		

### Contact utilization characteristics according to UL / CSA

Contactor relay types	AC / DC operated	NF
Standards		UL 508, CSA C22.2 N°14
Max. operational voltage		600 V AC, 600 V DC
Pilot duty		A600, Q600
AC thermal rated current		10 A
AC maximum volt-ampere making		7200 VA
AC maximum volt-ampere breaking		720 VA
DC thermal rated current		2.5 A
DC maximum volt-ampere making-breaking		69 VA

# NF contactor relays

## Technical data

### General technical data

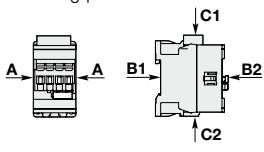
Contactor relay types	AC / DC operated	NF
<b>Rated insulation voltage <math>U_i</math></b> acc. to IEC 60947-5-1 acc. to UL / CSA		690 V 600 V
<b>Rated impulse withstand voltage <math>U_{imp}</math></b>		6 kV
<b>Electromagnetic compatibility</b>		Devices complying with IEC 60947-1 / EN 60947-1 - Environment A
<b>Ambient air temperature</b> close to contactor relay		
Operation in free air		-40...+70 °C
Storage		-60...+80 °C
<b>Climatic withstand</b>		Category B according to IEC 60947-1 Annex Q
<b>Maximum operating altitude (without derating)</b>		3000 m
<b>Mechanical durability</b>		
Number of operating cycles		20 millions operating cycles
Max. switching frequency		6000 cycles/h
<b>Shock withstand</b> acc. to IEC 60068-2-27 and EN 60068-2-27		
Mounting position 1		
	<b>Shock direction</b>	1/2 sinusoidal shock for 11 ms: no change in contact position, closed or open position
	<b>A</b>	30 g
	<b>B1</b>	25 g closed position / 5 g open position
	<b>B2</b>	15 g
	<b>C1</b>	25 g
	<b>C2</b>	25 g
<b>Vibration withstand</b> acc. to IEC 60068-2-6		5...300 Hz 4 g closed position / 2 g open position

5

### Magnet system characteristics

Contactor relay types	AC / DC operated	NF
<b>Coil operating limits</b> acc. to IEC 60947-5-1	<b>AC supply</b>	At $\theta \leq 60^\circ\text{C}$ $0.85 \times U_c \text{ min...} 1.1 \times U_c \text{ max.}$ At $\theta \leq 70^\circ\text{C}$ $0.85 \times U_c \text{ min...} U_c \text{ max.}$
	<b>DC supply</b>	At $\theta \leq 60^\circ\text{C}$ $0.85 \times U_c \text{ min...} 1.1 \times U_c \text{ max.}$ At $\theta \leq 70^\circ\text{C}$ (AF) $0.85 \times U_c \text{ min...} U_c \text{ max.}$ - (NFZ) $0.85 \times U_c \text{ min...} 1.1 \times U_c \text{ max.}$
<b>AC control voltage 50/60 Hz</b>		
Rated control circuit voltage $U_c$		24...500 V AC
Coil consumption	<b>Average pull-in value</b>	(NF) 50 VA - (NFZ) 16 VA
	<b>Average holding value</b>	(NF) 2.2 VA / 2 W - (NFZ) 1.7 VA / 1.5 W
<b>DC control voltage</b>		
Rated control circuit voltage $U_c$		12...500 V DC
Coil consumption	<b>Average pull-in value</b>	(NF) 50 W - (NFZ) 12...16 W
	<b>Average holding value</b>	(NF) 2 W - (NFZ) 1.7 W
<b>PLC-output control</b>		(NFZ) $\geq 500 \text{ mA}$ 24 V DC
<b>Drop-out voltage</b>		$\leq 60\%$ of $U_c \text{ min.}$
<b>Voltage sag immunity</b> acc. to SEMI F47-0706		(NFZ) conditions of use on request
<b>Dips withstand</b> $-20^\circ\text{C} \leq \theta \leq +60^\circ\text{C}$		(NFZ) 22 ms average for $U_c \geq 24 \text{ V}$ 50/60 Hz or $U_c \geq 20 \text{ V}$ DC
<b>Operating time</b>		
Between coil energization and:	<b>N.O. contact closing</b>	40...95 ms
	<b>N.C. contact opening</b>	38...90 ms
Between coil de-energization and:	<b>N.O. contact opening</b>	11...95 ms
	<b>N.C. contact closing</b>	13...98 ms

### Mounting characteristics

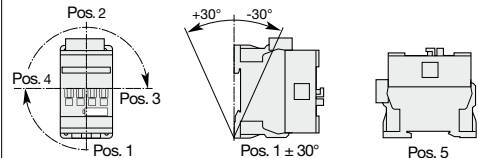







Contactor relay types	AC / DC operated	NF
<b>Mounting positions</b>		
<b>Mounting distances</b>		Max. add-on N.C. auxiliary contacts: see accessory fitting details for a NF contactor relay
<b>Fixing</b>		The contactor relays can be assembled side by side.
On rail according to IEC 60715, EN 60715		35 x 7.5 mm or 35 x 15 mm
By screws (not supplied)		2 x M4 screws placed diagonally

18BC101563S0201 - Rev. A

# NF contactor relays

## Technical data

### Connecting characteristics

<b>Contactor relay types</b>	AC / DC operated	NF
<b>Main terminals</b>		 Screw terminals with cable clamp
<b>Connection capacity (min. ... max.)</b>		
<b>Pole and coil terminals</b>		
 Rigid	1 x	1...2.5 mm <sup>2</sup>
 Rigid	2 x	1...2.5 mm <sup>2</sup>
 Flexible with non insulated ferrule	1 x	0.75...2.5 mm <sup>2</sup>
 Flexible with non insulated ferrule	2 x	0.75...2.5 mm <sup>2</sup>
 Flexible with insulated ferrule	1 x	0.75...2.5 mm <sup>2</sup>
 Flexible with insulated ferrule	2 x	0.75...1.5 mm <sup>2</sup>
 Lugs	L <	8 mm
Connection capacity acc. to UL/CSA	1 or 2 x	AWG 18...14
Stripping length		10 mm
<b>Tightening torque</b>		
Pole terminals		1.2 Nm / 11 lb.in
Coil terminals		1.2 Nm / 11 lb.in
<b>Degree of protection</b>		
acc. to IEC 60947-1 / EN 60947-1 and IEC 60529 / EN 60529		
All terminals		IP20
<b>Screw terminals</b>		
All terminals		Delivered in open position, screws of unused terminals must be tightened
		M3.5
	<b>Screwdriver type</b>	Flat Ø 5.5 / Pozidriv 2

5

# NF contactor relays

## Terminal marking and positioning

Standard devices without addition of auxiliary contacts

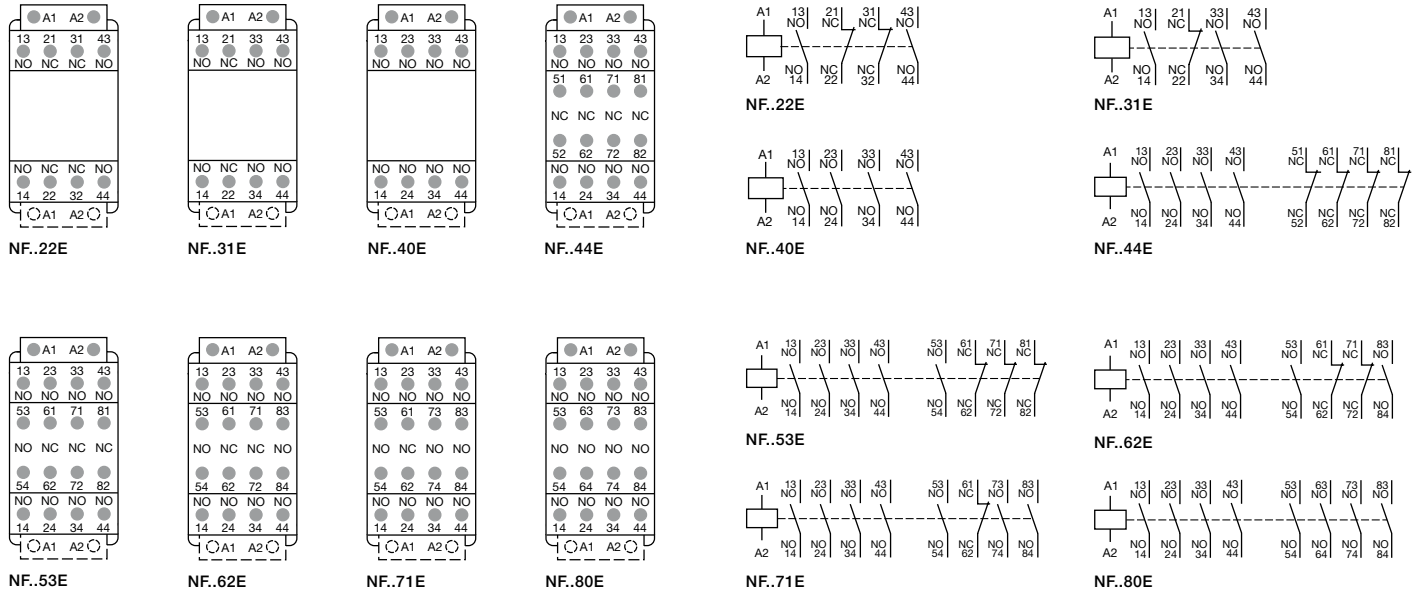

Other possible contact combinations with auxiliary contacts added by the user

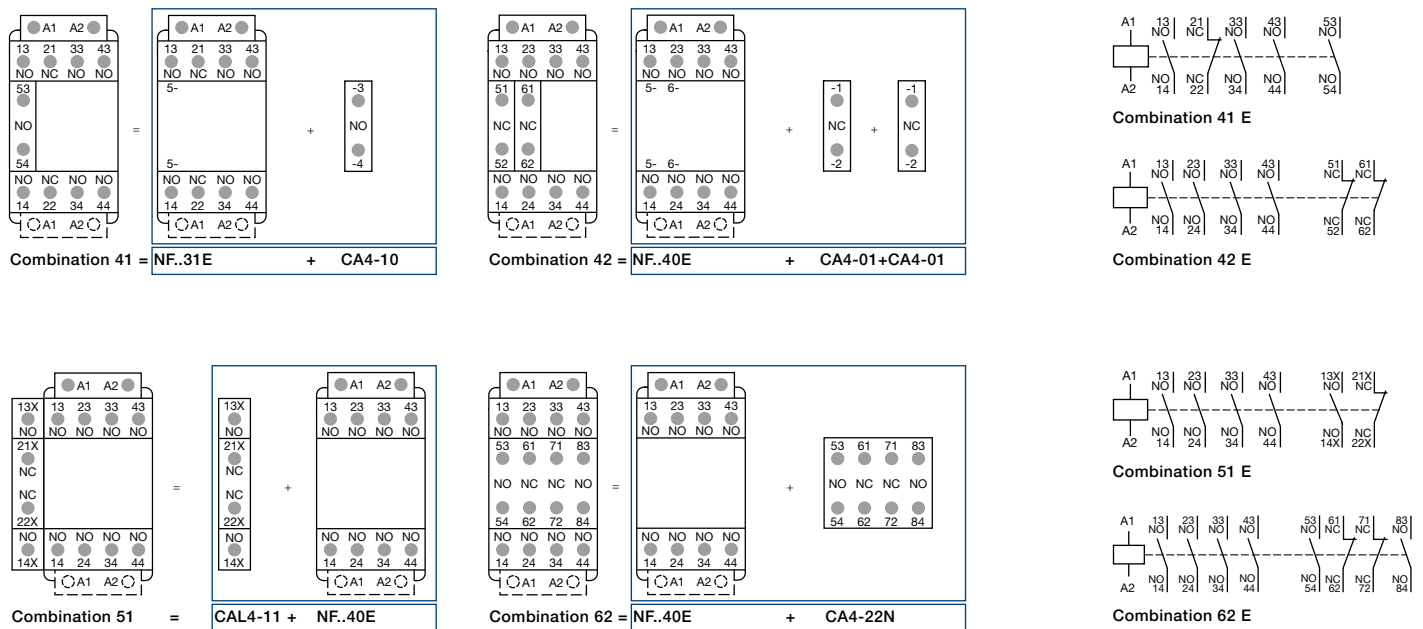

Note: Only NFZ contactor relays with DC control voltage 12...20 V DC need to respect the connection polarities indicated close to the coil terminals: A1+ for the positive pole and A2- for the negative pole

# NF add-on auxiliary contacts

## Terminal marking and positioning

### 1-pole auxiliary contacts

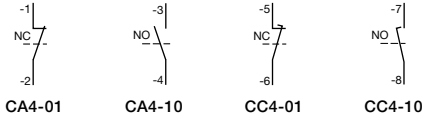

### 2-pole auxiliary contacts

5

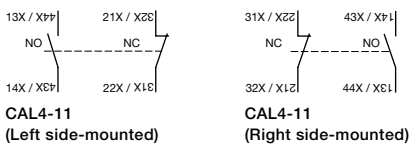

### 4-pole auxiliary contacts

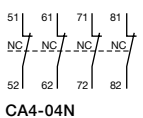
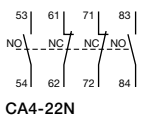
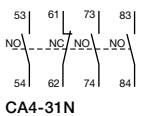
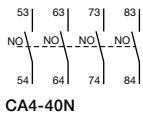
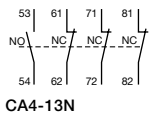



# NF contactor relays

## Main dimensions mm, inches

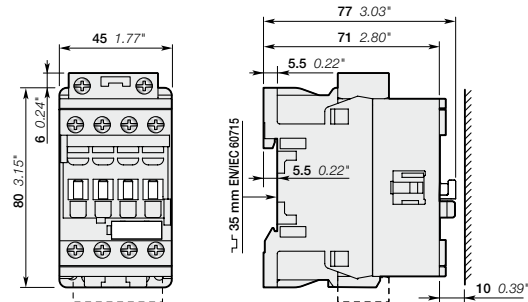

NF..22E, NF..31E, NF..40E

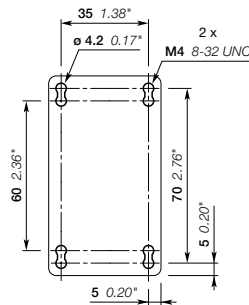

NF

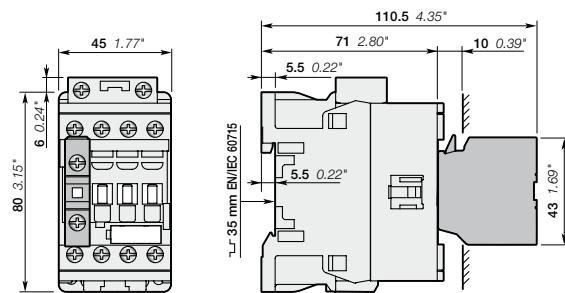

NF..22E, NF..31E, NF..40E  
+ CA4, CC4 1-pole auxiliary contact block

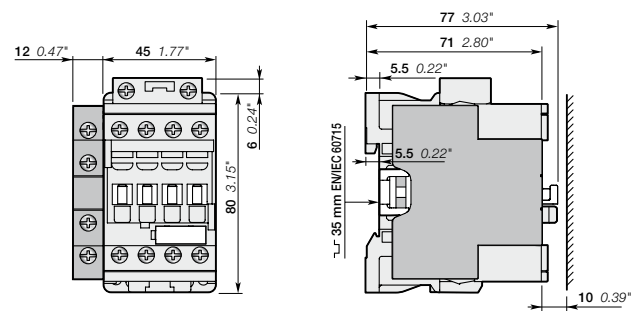

NF..22E, NF..31E, NF..40E  
+ CAL4-11 2-pole auxiliary contact block

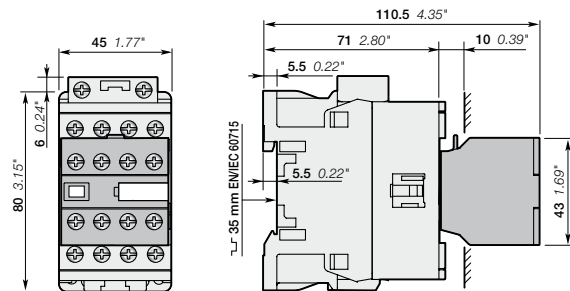

NF..22E, NF..31E, NF..40E  
+ CA4 4-pole auxiliary contact block

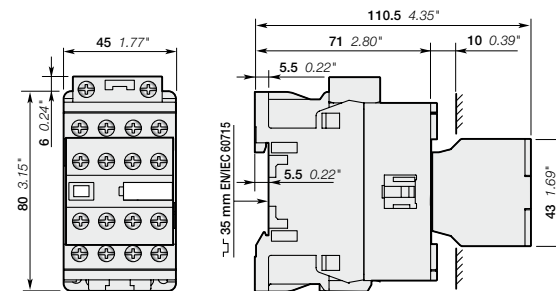

NF..44E, NF..53E, NF..62E, NF..71E, NF..80E

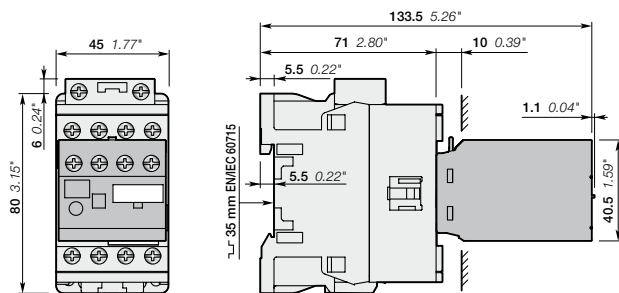

NF..22E, NF..31E, NF..40E  
+ TEF4 electronic timer

Note: Contactor relay lateral distance to grounded component 2 mm 0.08" min.



<b>Accessories for AF09 ... AF2650 3-pole contactors, AF09 ... AF38 4-pole contactors and NF contactor relays</b>	<b>5/197</b>
Auxiliary contact blocks	5/198
Electronic timers	5/207
Interlocks	5/210
Impulse contact blocks	5/212
Mechanical latching units	5/214
Other accessories	5/216
Terminal shrouds	5/218
Connections	5/219
Terminal connecting strips and shorting bars	5/220
Connection accessories for starting solutions	5/221
Connection sets for star-delta starter	5/222
Connection bars	5/223
Mounting plates	5/224
Adapter plates	5/225
Contactor coils, main contact sets and arc chutes	5/226

<b>Accessories for A45, A50, A75, (T)AE45, (T)AE50, (T)AE75, AF45, AF50, AF75 4-pole contactors and UA, UA..RA contactors</b>	<b>5/227</b>
Auxiliary contact blocks	5/228
Electronic timers	5/234
Impulse contact blocks	5/237
Mechanical and electrical interlock units	5/238
CA5, CE5, CAL5 and TEF5 fitting details	5/240
Function markers - Mounting piece	5/241
Surge suppressors for contactor coils	5/242
Interface relays	5/244
Mechanical latching units	5/246
Additional terminal blocks	5/248
Terminals for control lead connections	5/249
Other accessories	5/250
Contactor coils and main contact sets	5/251

<b>Accessories for EK100 ... EK1000 4-pole contactors</b>	<b>5/253</b>
Auxiliary contact blocks	5/254
Mechanical interlock units	5/258
Mechanical and electrical interlock units	5/258
Surge suppressors for contactor coils	5/260
Terminal shrouds and connection sets	5/262
Mounting plates	5/263
Main contact sets - Arc chutes	5/264
Contactor coils	5/265



# Accessories for AF09 ... AF2650 3-pole contactors, AF09 ... AF38 4-pole contactors and NF contactor relays

Auxiliary contact blocks	5/198
Electronic timers	5/207
Interlocks	5/210
Impulse contact blocks	5/212
Mechanical latching units	5/214
Other accessories	5/216
Terminal shrouds	5/218
Connections	5/219
Terminal connecting strips and shorting bars	5/220
Connection accessories for starting solutions	5/221
Connection sets for star-delta starter	5/222
Connection bars	5/223
Mounting plates	5/224
Adapter plates	5/225
Contactor coils, main contact sets and arc chutes	5/226

# Auxiliary contact blocks for AF09 ... AF96 contactors and NF contactor relays



CA4-10

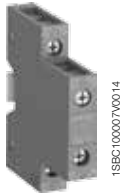

CAL4-11



CA4-22E



CAT4-11E

## Description

The auxiliary contact blocks are used for the operation of auxiliary circuits and control circuits for standard industrial environments.

Types of auxiliary contact blocks for front mounting:

- CA4 1 or 4-pole block, with instantaneous N.O., N.C. contacts
- CC4 1-pole block, with N.O. leading contact or N.C. lagging contact
- CAT4 2-pole block, with instantaneous N.O. + N.C. contacts and A1 / A2 coil terminal connection on front face.

Select the 4-pole auxiliary contact blocks CA4-..E, CA4-..M, CA4-..U or CA4-..N type, according to the contactor or contactor relay type for compliance with the standard requirements (see "Terminal marking and positioning").

Types of auxiliary contact blocks for side mounting:

- CAL4 2-pole block, with instantaneous N.O. + N.C. contacts.

For clipping onto the right- and/or left-hand side of the contactors.

The auxiliary contact blocks are equipped with screw type connecting terminals delivered open, protected against accidental direct contact and bear the corresponding function marking.

## Ordering details (1)

For contactors	Auxiliary contacts	Type	Order code	Pkg qty	Weight (1 pce)
					kg

### Front-mounted instantaneous auxiliary contact blocks

AF09 ... AF96	1 0 - -	CA4-10	1SBN010110R1010	1	0.014
4-pole NF	1 0 - -	CA4-10-T	1SBN010110T1010	10	0.014
	0 1 - -	CA4-01	1SBN010110R1001	1	0.014
	0 1 - -	CA4-01-T	1SBN010110T1001	10	0.014
AF09 ... AF16..-30-10	2 2 - -	CA4-22M	1SBN010140R1122	1	0.055
	3 1 - -	CA4-31M	1SBN010140R1131	1	0.055
	1 3 - -	CA4-13M	1SBN010140R1113	1	0.055
	0 4 - -	CA4-04M	1SBN010140R1104	1	0.055
AF26 ... AF96..-30-00	2 2 - -	CA4-22E	1SBN010140R1022	1	0.055
AF09 ... AF38..-40-00	3 1 - -	CA4-31E	1SBN010140R1031	1	0.055
AF09 ... AF38..-22-00	4 0 - -	CA4-40E	1SBN010140R1040	1	0.055
AF26 ... AF96..-30-00	0 4 - -	CA4-04E	1SBN010140R1004	1	0.055
AF09 ... AF16..-40-00					
AF09 ... AF16..-30-01	2 2 - -	CA4-22U	1SBN010140R1322	1	0.055
	3 1 - -	CA4-31U	1SBN010140R1331	1	0.055
	4 0 - -	CA4-40U	1SBN010140R1340	1	0.055
4-pole NF	2 2 - -	CA4-22N	1SBN010140R1222	1	0.055
	3 1 - -	CA4-31N	1SBN010140R1231	1	0.055
	4 0 - -	CA4-40N	1SBN010140R1240	1	0.055
	1 3 - -	CA4-13N	1SBN010140R1213	1	0.055
NF..40E	0 4 - -	CA4-04N	1SBN010140R1204	1	0.055

### Front-mounted auxiliary contact blocks with N.O. leading contact and N.C. lagging contact

AF09 ... AF96	- - 1 0	CC4-10	1SBN010111R1010	1	0.014
4-pole NF	- - 0 1	CC4-01	1SBN010111R1001	1	0.014

### Side-mounted instantaneous auxiliary contact blocks

AF09 ... AF96	1 1 - -	CAL4-11	1SBN010120R1011	1	0.040
NF	1 1 - -	CAL4-11-T	1SBN010120T1011	10	0.040

### Front-mounted instantaneous auxiliary contact and A1/A2 coil terminal blocks

AF09 ... AF16..-30-10	1 1 - -	CAT4-11M	1SBN010151R1111	1	0.040
AF26 ... AF65..-30-00	1 1 - -	CAT4-11E	1SBN010151R1011	1	0.040
AF09 ... AF38..-40-00					
AF09 ... AF38..-22-00					
AF09 ... AF16..-30-01	1 1 - -	CAT4-11U	1SBN010151R1311	1	0.040

(1) For each contactor or contactor relay type, refer to "Accessory fitting details" table.

**Note:** CAT4 not suitable for AF..Z contactors with DC control voltage 12...20 V DC.

# Auxiliary contact blocks for AF09 ... AF96 contactors and NF contactor relays

## Technical data





### Contact utilization characteristics according to IEC

<b>Types</b>	1-pole <b>CA4</b> , 1-pole <b>CC4</b> , 4-pole <b>CA4</b> , 2-pole <b>CAT4</b> , 2-pole <b>CAL4</b>	
<b>Standards</b>	IEC 60947-5-1 and EN 60947-5-1	
<b>Rated insulation voltage <math>U_i</math></b> acc. to IEC 60947-5-1	690 V	
<b>Rated impulse withstand voltage <math>U_{imp}</math></b>	6 kV	
<b>Rated operational voltage <math>U_e</math> max.</b>	24...690 V	
<b>Conventional thermal current <math>I_{th}</math> - <math>\theta \leq 40^\circ\text{C}</math></b>	16 A	
<b>Rated frequency (without derating)</b>	50/60 Hz	
<b><math>I_e</math> / Rated operational current AC-15</b> acc. to IEC 60947-5-1	24-127 V 50/60 Hz	6 A
	220-240 V 50/60 Hz	4 A
	400-440 V 50/60 Hz	3 A
	500 V 50/60 Hz	2 A
	690 V 50/60 Hz	2 A
<b>Making capacity</b> acc. to IEC 60947-5-1	10 x $I_e$ AC-15	
<b>Breaking capacity</b> acc. to IEC 60947-5-1	10 x $I_e$ AC-15	
<b><math>I_e</math> / Rated operational current DC-13</b> acc. to IEC 60947-5-1	24 V DC	6 A / 144 W
	48 V DC	2.8 A / 134 W
	72 V DC	1 A / 72 W
	110 V DC	0.55 A / 60 W
	125 V DC	0.55 A / 69 W
	220 V DC	0.27 A / 60 W
	250 V DC	0.27 A / 68 W
	400 V DC	0.15 A / 60 W
	500 V DC	0.13 A / 65 W
	600 V DC	0.1 A / 60 W
<b>Short-circuit protection device gG type fuse</b>	10 A	
<b>Rated short-time withstand current <math>I_{cw}</math></b> $\theta = 40^\circ\text{C}$	for 1.0 s	100 A
	for 0.1 s	140 A
<b>Minimum switching capacity</b> with failure rate acc. to IEC 60947-5-4	12 V / 3 mA	
<b>Power dissipation per pole at 6 A</b>	10-7	
<b>Mechanical durability</b>	Number of operating cycles	10 millions operating cycles
	Max. switching frequency	3600 cycles/h
<b>Max. electrical switching frequency</b>	AC-15	1200 cycles/h
	DC-13	900 cycles/h
<b>Mechanically linked contacts</b> acc. to annex L of IEC 60947-5-1	Additional N.O. or N.C. auxiliary contacts (CA4, CAL4, CAT4) are mechanically linked contacts	
<b>Mirror contacts</b> acc. to annex F of IEC 60947-4-1	Additional N.C. auxiliary contacts (CA4, CAL4, CAT4) are mirror contacts	

### Contact utilization characteristics according to UL / CSA

<b>Types</b>	1-pole <b>CA4</b> , 1-pole <b>CC4</b> , 4-pole <b>CA4</b> , 2-pole <b>CAT4</b> , 2-pole <b>CAL4</b>	
<b>Standards</b>	UL 508, CSA C22.2 N°14	
<b>Max. operational voltage</b>	600 V AC, 600 V DC	
<b>Pilot duty</b>	A600, Q600	
AC thermal rated current	10 A	
AC maximum volt-ampere making	7200 VA	
AC maximum volt-ampere breaking	720 VA	
DC thermal rated current	2.5 A	
DC maximum volt-ampere making-breaking	69 VA	

### Connecting characteristics

<b>Types</b>	1-pole <b>CA4</b> , 1-pole <b>CC4</b> , 4-pole <b>CA4</b> , 2-pole <b>CAT4</b> , 2-pole <b>CAL4</b>	
<b>Connection capacity (min. ... max.)</b>		
 Rigid solid	1 x	1...2.5 mm <sup>2</sup>
	2 x	1...2.5 mm <sup>2</sup>
 Flexible with non insulated ferrule	1 x	0.75...2.5 mm <sup>2</sup>
	2 x	0.75...2.5 mm <sup>2</sup>
 Flexible with insulated ferrule	1 x	0.75...2.5 mm <sup>2</sup>
	2 x	0.75...1.5 mm <sup>2</sup>
 Lugs	L <	8 mm
<b>Connection capacity acc. to UL/CSA</b>	1 or 2 x	AWG 18...14
<b>Stripping length</b>	10 mm	
<b>Tightening torque</b>	1.2 Nm / 11 lb.in	
<b>Degree of protection</b> acc. to IEC 60947-1 / EN 60947-1 and IEC 60529 / EN 60529	IP20	
<b>Screw terminals</b> All terminals	Delivered in open position, screws of unused terminals must be tightened M3.5	
<b>Screwdriver type</b>	Flat Ø 5.5 / Pozidriv 2	

# Auxiliary contact blocks for AF116 ... AF2650 contactors



CAL19-11

1SFN01071V0001

## Description

The auxiliary contact blocks are used for the operation of auxiliary circuits and control circuits for standard industrial environments.

Types of auxiliary contact blocks for side mounting:



- CAL 2-pole block, with instantaneous N.O. + N.C. contacts.

For clipping onto the right- and/or left-hand side of the contactors.

The CAL ...-11B is a second block for mounting in addition to a first CAL ...-11 block, right- and/or left-hand of the AF116 ... AF2650 contactors.

The auxiliary contact blocks are equipped with screw type connecting terminals delivered open, protected against accidental direct contact and bear the corresponding function marking.

## Ordering details

For contactors	Auxiliary contacts	Type	Order code	Pkg qty	Weight (1 pce)
	 				kg

### Side-mounted instantaneous auxiliary contact blocks

AF116 ... AF370	1	1	CAL19-11	1SFN010820R1011	2	0.040
	1	1	CAL19-11B	1SFN010820R3311	2	0.040
AF400 ... AF2650	1	1	CAL18-11	1SFN010720R1011	2	0.050
	1	1	CAL18-11B	1SFN010720R3311	2	0.050

(1) For each contactor type, refer to "Accessory fitting details" table.



CAL18-11

1SFN01082V0001



# Auxiliary contact blocks for AF116 ... AF2650 contactors







## Technical data

Types	CAL18	CAL19
<b>Contact utilization characteristics according to IEC</b>		
<b>Standards</b>	IEC 60947-5-1 and EN 60947-5-1	
<b>Rated insulation voltage <math>U_i</math></b> acc. to IEC 60947-5-1	690 V	
<b>Rated impulse withstand voltage <math>U_{imp}</math></b>	6 kV	
<b>Rated operational voltage <math>U_e</math> max.</b>	24...690 V AC	
<b>Conventional thermal current <math>I_{th}</math> - <math>\theta \leq 40</math> °C</b>	16 A	
<b>Rated frequency (without derating)</b>	50/60 Hz	
<b><math>I_e</math> / Rated operational current AC-15</b> acc. to IEC 60947-5-1	24-127 V 50/60 Hz	6 A
	220-240 V 50/60 Hz	4 A
	380-440 V 50/60 Hz	3 A
	500-690 V 50/60 Hz	2 A
<b>Making capacity</b> acc. to IEC 60947-5-1	10 x $I_e$ AC-15	
<b>Breaking capacity</b> acc. to IEC 60947-5-1	10 x $I_e$ AC-15	
<b><math>I_e</math> / Rated operational current DC-13</b> acc. to IEC 60947-5-1	24 V DC	6 A / 144 W
	48 V DC	2.8 A / 134 W
	72 V DC	1 A / 72 W
	110 V DC	0.55 A / 60 W
	125 V DC	0.55 A / 69 W
	220 V DC	0.3 A / 66 W
	250 V DC	0.3 A / 75 W
<b>Short-circuit protection device</b> gG type fuse	10 A	
<b>Rated short-time withstand current <math>I_{sc}</math></b> $\theta = 40$ °C	for 1.0 s	100 A
	for 0.1 s	140 A
<b>Minimum switching capacity</b> with failure rate acc. to IEC 60947-5-4	24 V / 50 mA (0.5 million of operating cycles)	24 V / 50 mA
<b>Power dissipation per pole at 6 A</b>	$\leq 10^{-6}$	
<b>Mechanical durability</b> Number of operating cycles	3 millions (A/AF400 ... AF750)	5 millions operating cycles
	0.5 million (AF1250 ... AF2050)	
	Max. switching frequency	3600 cycles/h
<b>Max. electrical switching frequency</b>	AC-15	1200 cycles/h
	DC-13	900 cycles/h
<b>Mechanically linked contacts</b> acc. to annex L of IEC 60947-5-1	N.O. or N.C. auxiliary contacts are mechanically linked contacts	
<b>Mirror contacts</b> acc. to annex F of IEC 60947-4-1	N.C. auxiliary contacts are mirror contacts	

## Contact utilization characteristics according to UL / CSA

<b>Standards</b>	UL 508, CSA C22.2 N°14
<b>Max. operational voltage</b>	600 V AC, 250 V DC
<b>Pilot duty</b>	A600, Q300
AC thermal rated current	10 A
AC maximum volt-ampere making	7200 V A
AC maximum volt-ampere breaking	720 V A
DC thermal rated current	2.5 A
DC maximum volt-ampere making-breaking	69 V A

## Connecting characteristics

<b>Connection capacity (min. ... max.)</b>	
 Solid / stranded	1 x 1...4 mm <sup>2</sup>
 Solid / stranded	2 x 1...4 mm <sup>2</sup>
 Flexible with non insulated ferrule	1 x 0.75...2.5 mm <sup>2</sup>
 Flexible with non insulated ferrule	2 x 0.75...2.5 mm <sup>2</sup>
 Flexible with insulated ferrule	1 x 0.75...2.5 mm <sup>2</sup>
 Flexible with insulated ferrule	2 x 0.75...2.5 mm <sup>2</sup>
 Lugs	L $\leq$ 8 mm
	I > 3.7 mm
<b>Connection capacity acc. to UL/CSA</b>	1 or 2 x AWG18...14
<b>Stripping length</b>	9 mm
<b>Tightening torque</b>	1 Nm
<b>Degree of protection</b> acc. to IEC 60947-1 / EN 60947-1 and IEC 60529 / EN 60529	IP20
<b>Screw terminals</b> All terminals	Delivered in open position, screws of unused terminals must be tightened M3.5
<b>Screwdriver type</b>	Flat $\varnothing$ 5.5 / Pozidriv 2

# Auxiliary contact blocks for AF400 ... AF2650 contactors for severe industrial environments



CEL18

1SFN101083V0001

## Description

The auxiliary contact blocks are used for the operation of auxiliary and control circuits for severe industrial environments.

Types of auxiliary contact blocks for side mounting:

- CEL18 1-pole block, with built-in microswitch IP67 degree of protection (IP20 on terminals). Instantaneous N.O. or N.C. contact.

For clipping onto the right- and/or left-hand side of the contactors.

The auxiliary contact blocks are equipped with screw type connecting terminals delivered open, protected against accidental direct contact and bear the corresponding function marking.

## Ordering details (1)

For contactors	Auxiliary contacts	Type	Order code	Pkg qty	Weight (1 pce)
	 				kg

### Side-mounting instantaneous auxiliary contact blocks

AF400 ... AF2650	1 0	CEL18-10	1SFN010716R1010	1	0.050
	0 1	CEL18-01	1SFN010716R1001	1	0.050

(1) For each contactor type, refer to "Accessory fitting details" table.

# Auxiliary contact blocks for AF400 ... AF2650 contactors for severe industrial environments

## Technical data

Types	CEL18
-------	-------





### Contact utilization characteristics according to IEC

<b>Standards</b>	IEC 60947-5-1 and EN 60947-5-1	
<b>Rated insulation voltage <math>U_i</math></b> acc. to IEC 60947-5-1	250 V	
<b>Rated operational voltage <math>U_e</math> max.</b>	125 V	
<b>Conventional thermal current <math>I_{th}</math> - <math>\theta \leq 40^\circ\text{C}</math></b>	0.1 A	
<b><math>I_e</math> / Rated operational current AC-14</b>		
acc. to IEC 60947-5-1	<b>24-127 V 50/60 Hz</b>	0.1 A
<b>Making capacity</b> acc. to IEC 60947-5-1	6 x $I_e$ AC-14	
<b>Breaking capacity</b> acc. to IEC 60947-5-1	6 x $I_e$ AC-14	
<b><math>I_e</math> / Rated operational current DC-12</b>		
acc. to IEC 60947-5-1	<b>24 V DC</b>	0.1 A
	<b>48 V DC</b>	0.1 A
	<b>72 V DC</b>	0.1 A
	<b>110 V DC</b>	0.1 A
	<b>220 V DC</b>	-
<b>Short-circuit protection device</b>	0.1 A (FF type fuses) (1)	
<b>Minimum switching capacity</b>		
with failure rate acc. to IEC 60947-5-4	3 V / 1 mA	
<b>Mechanical durability</b>		
Number of operating cycles	1 million	
Max. switching frequency	1200 cycles/h	
<b>Electrical durability</b>		
Number of operating cycles	0.7 millions	
Max. switching frequency	<b>AC-14, AC15</b>	1200 cycles/h
	<b>DC-12</b>	900 cycles/h

### Contact utilization characteristics according to UL / CSA

<b>Standards</b>	UL 508, CSA C22.2 N°14
<b>Max. operational voltage</b>	125 V
<b>Pilot duty</b>	
AC thermal rated current	0.1 A

### Connecting characteristics

<b>Connection capacity (min. ... max.)</b>		
	Rigid solid	1 x 1...4 mm <sup>2</sup>
	Flexible with ferrule	2 x 1...4 mm <sup>2</sup>
		1 x 0.75...2.5 mm <sup>2</sup>
	Lugs	2 x 0.75...2.5 mm <sup>2</sup>
		L ≤ 7.7 mm
		L > 3.7 mm
<b>Connection capacity acc. to UL/CSA</b>	1 or 2 x	AWG 18...14
<b>Tightening torque</b>		1 Nm
<b>Degree of protection</b>	<b>Terminals</b>	IP20
acc. to IEC 60947-1 / EN 60947-1 and IEC 60529 / EN 60529	<b>Microswitches</b>	IP67
<b>Screw terminals</b>	Delivered in open position, screws of unused terminals must be tightened	
All terminals	M3.5	
<b>Screwdriver type</b>	Flat Ø 5.5 / Pozidriv 2	

(1) or HRC fuses for very fast action (6.3 x 32 mm size).

# Auxiliary contact blocks for AF09 ... AF96 contactors and NF contactor relays

## Electrical durability

### Electrical durability for AC-15 utilization category

AC-15 utilization category according to IEC 60947-5-1 / EN 60947-5-1:

- making current:  $10 \times I_e$  with  $\cos \varphi = 0.7$  and  $U_e$
- breaking current:  $I_e$  with  $\cos \varphi = 0.4$  and  $U_e$ .

These curves represent the electrical durability of the built-in or add-on auxiliary contacts in relation to the breaking current. The curves have been drawn for resistive and inductive loads up to 690 V, 40...60 Hz.

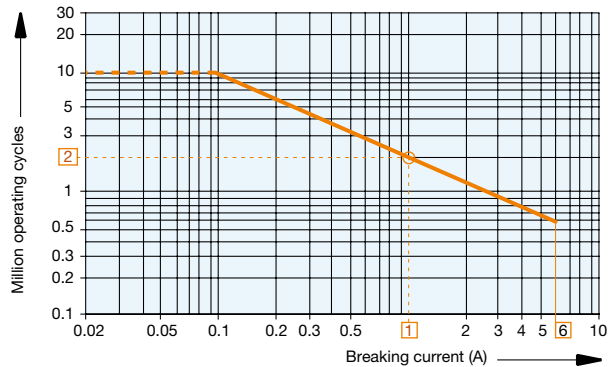

- AF09 ... AF96 contactor built-in auxiliary contacts
- 1-pole and 4-pole CA4, 2-pole CAT4, 1-pole CC4, 2-pole CAL4 add-on auxiliary contacts.

#### Example:

Breaking current = 1 A

On the opposite curve at intersection "O" 1 A the corresponding value for the electrical durability is approximately 2 millions operating cycles.

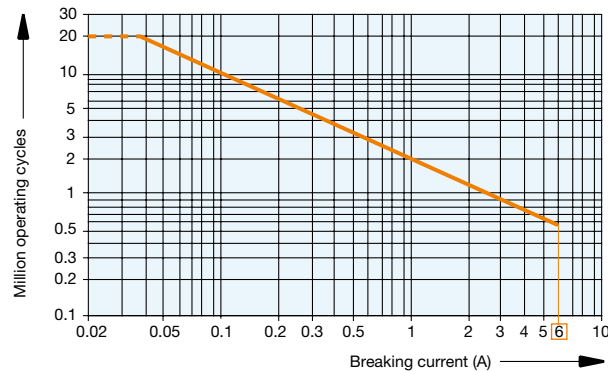

NF contactor relays.

(For add on auxiliary contacts see curve above).

### Electrical durability for DC-13 utilization category

DC-13 utilization category according to IEC 60947-5-1 / EN 60947-5-1: making and breaking current  $I_e$  and  $U_e$ .

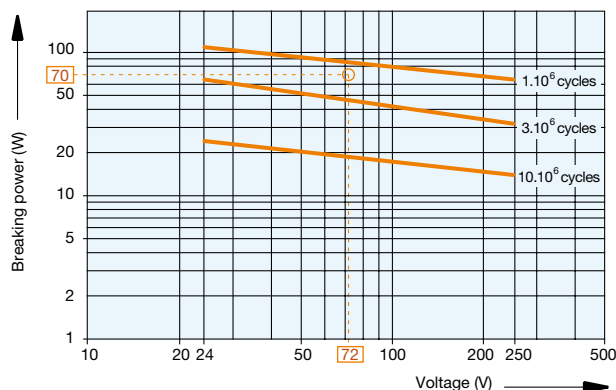

- AF09 ... AF96 contactor built-in auxiliary contacts 1-pole and 4-pole CA4, 2-pole CAT4, 1-pole CC4,
- 2-pole CAL4 add-on auxiliary contacts,
- NF contactor relays.

#### Example:

Control of DC electro-magnet:

$U_e$  voltage = 72 V DC and breaking power = 70 W.

On the opposite curve at intersection "O" 72 V / 70 W the corresponding value for the electrical durability is approximately 2 millions operating cycles.

# Auxiliary contacts for AF116 ... AF2650 contactors

## Electrical durability

### Electrical durability for AC-15 utilization category

AC-15 utilization category according to IEC 60947-5-1 / EN 60947-5-1:

- making current:  $10 \times I_e$  with  $\cos \varphi = 0.7$  and  $U_e$
- breaking current:  $I_e$  with  $\cos \varphi = 0.4$  and  $U_e$ .

These curves represent the electrical durability of the add-on auxiliary contacts, in relation to the breaking current.

The curves have been drawn for resistive and inductive loads up to 690 V, 40...60 Hz.

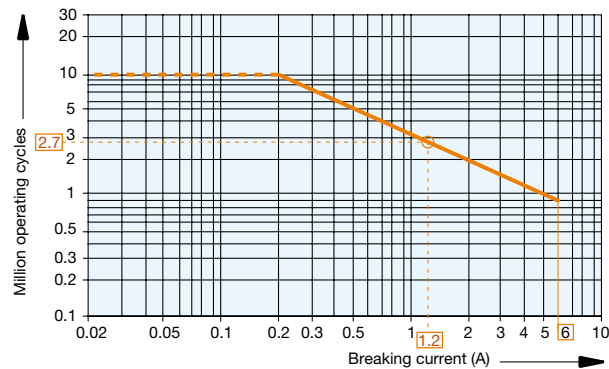

- AF116 ... AF2650 contactors auxiliary contacts
- 2-pole CAL18 and CAL19 add-on auxiliary contacts

#### Example:

Breaking current = 1.2 A

On the opposite curve at intersection "O" 1.2 A the corresponding value for the electrical durability is approximately 2.7 millions operating cycles.

# Add-on auxiliary contacts

## Terminal marking and positioning

### 1-pole auxiliary contacts

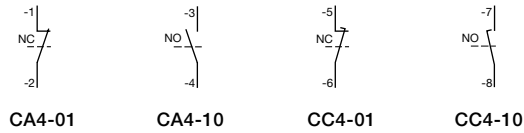

### 2-pole auxiliary contacts

5

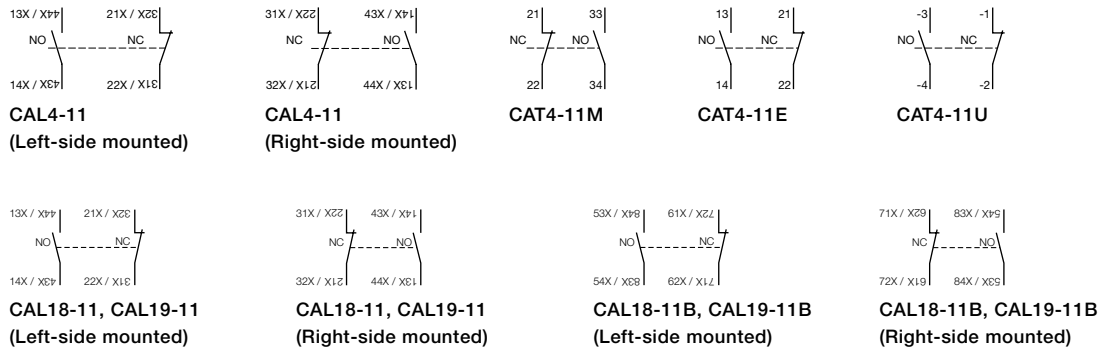

### 4-pole auxiliary contacts

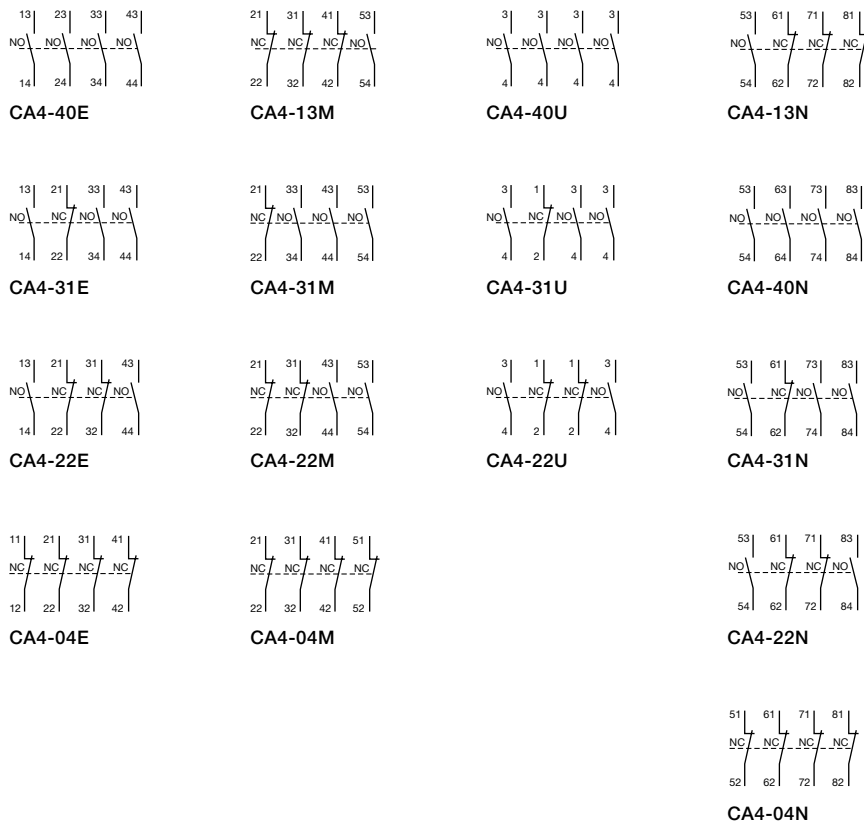

# Electronic timers



1SBC1000AV0014

TEF4-ON



1SBC100012V0014

TEF4-OFF

## Description

TEF4 frontal electronic timers are used for realizing timing function and are available in ON-delay and OFF-delay versions.

### Compact solution in cabinet compared to separate timers

TEF4 electronic timers are front-mounted and locked on AF contactors or NF contactor relays. A mechanical indicator allows to show the state of the contactor.

### Safe and cost-reduced wiring

TEF4 electronic timers are supplied by a direct plug-in parallel connection to the coil terminals A1 - A2 of the contactor or contactor relay. A varistor is integrated on the timer to offer a built-in protection against surges in the contactor coil.

### Available for a wide control voltage range 24...240 V AC/DC

TEF4-ON or TEF4-OFF allow time-delayed functions up to 100 s in 3 distinct time ranges, independently of the control system. The time delay ranges are selected by a switch and the time delay can be adjusted by means of a rotary switch. The timing function is activated by closing or opening the device on which the timer is mounted. The OFF-delay version operates without additional control supply.

## Ordering details

For contactors, contactor relays	Time delay range selected by switch	Delay type	Rated control circuit voltage U <sub>c</sub> V 50/60 Hz or DC	Auxiliary contacts 	Type	Order code	Weight Pkg (1 pce) kg
AF09 ... AF96	0.1...1 s	ON-delay	24...240	1 1	TEF4-ON	1SBN020112R1000	0.065
NF	1...10 s 10...100 s	OFF-delay	24...240	1 1	TEF4-OFF	1SBN020114R1000	0.065

# Electronic timers

## Technical data

### Contact utilization characteristics according to IEC

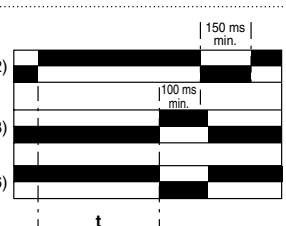
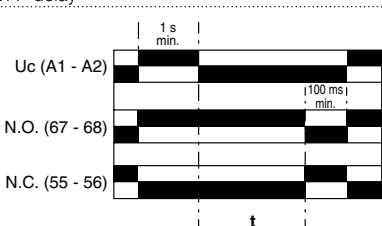
Types	TEF4-ON	TEF4-OFF
<b>Standards</b>	IEC 60947-5-1 and EN 60947-5-1	
<b>Rated insulation voltage <math>U_i</math></b> acc. to IEC 60947-5-1	400 V	
<b>Rated impulse withstand voltage <math>U_{imp}</math></b>	4 kV	
<b>Rated operational voltage <math>U_e</math> max.</b>	240 V	
<b>Rated frequency (without derating)</b>	50 / 60 Hz	
<b>Conventional thermal current <math>I_{th} - \theta \leq 40^\circ\text{C}</math></b>	5 A	
<b><math>I_e</math> / Rated operational current AC-15</b> acc. to IEC 60947-5-1	24-127 V 50/60 Hz 220-240 V 50/60 Hz	3 A 1.5 A
<b>Making capacity</b> acc. to IEC 60947-5-1	10 x $I_e$ AC-15	
<b>Breaking capacity</b> acc. to IEC 60947-5-1	10 x $I_e$ AC-15	
<b><math>I_e</math> / Rated operational current DC-13</b> acc. to IEC 60947-5-1	24 V DC	1 A / 24 W
<b>Short-circuit protection device</b> gG type fuse	6 A	
<b>Rated short-time withstand current <math>I_{cw}</math></b> $\theta = 40^\circ\text{C}$	for 1.0 s for 0.1 s	8 A 8 A
<b>Minimum switching capacity</b> with failure rate acc. to IEC 60947-5-4	24 V DC	12 V / 3 mA $10^{-7}$
<b>Power dissipation per pole at 3 A</b>	0.1 W	
<b>Function diagram</b>	ON-delay 	OFF-delay 
	Bistable relay inside. Before use, once apply $U_c$ then switch it off in order to initialize position of the contacts.	
<b>Control circuit voltage</b>		
<b>AC control voltage</b>	Rated control circuit voltage $U_c$ 50/60 Hz	24...240 V AC 1.5 mA RMS
<b>DC control voltage</b>	Rated control circuit voltage $U_c$ Average consumption	24...240 V DC 1.5 mA 1 mA
<b>Rated frequency limits</b>	50 / 60 Hz	
<b>Supply voltage range</b>	0.85...1.1 x $U_c$ (at $\theta \leq 70^\circ\text{C}$ )	
<b>Overvoltage protection</b>	Varistor included	
<b>Time delay range (t) selected by switch</b>	0.1...1 s 1...10 s 10...100 s	<input type="checkbox"/> <input type="checkbox"/> <input type="checkbox"/>
<b>On-load reiteration accuracy under constant conditions</b>	$\leq 1\%$	
<b>Minimum ON period</b>	0.1 s	
<b>Recovery time</b>	0.15 s	
<b>Ambient air temperature</b>	Operation Storage	-25 °C ... +70 °C -40 °C ... +80 °C
<b>Climatic withstand</b>	Category B according to IEC 60947-1 Annex Q	
<b>Maximum operating altitude</b>	2000 m	
<b>Mounting positions</b>	Mounting positions 1, 1 +/- 30°, 2, 3, 4, 5	
<b>Shock withstand</b> acc. to IEC 60068-2-27 and EN 60068-2-27 (Mounting position 1)	1/2 sinusoidal shock for 11 ms: no change in contact position Same as contactor or contactor relay	
<b>Vibration withstand</b> acc. to IEC 60068-2-6	5...300 Hz 3 g closed position / 2 g open position	
<b>Mechanical durability</b>	Number of operating cycles Max. switching frequency	5 millions operating cycles 3600 cycles/h 1800 cycles/h
<b>Max. electrical switching frequency</b>	AC-15 DC-13	1200 cycles/h 900 cycles/h







# Electronic timers

## Technical data

### Contact utilization characteristics according to UL / CSA

Types	TEF4-ON	TEF4-OFF
<b>Standards</b>	UL 508, CSA C22.2 N°14	
<b>Rated insulation voltage <math>U_i</math></b> acc. to UL / CSA	300 V	
<b>Max. operational voltage</b>	240 V	
<b>Pilot duty</b>	B300, R300	
AC thermal rated current	5 A	
AC maximum volt-ampere making	3600 VA	
AC maximum volt-ampere breaking	360 VA	
DC thermal rated current	1 A	
DC maximum volt-ampere making-breaking	28 VA	

### Connecting characteristics

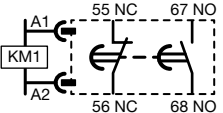
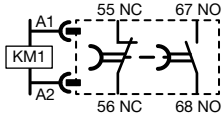
<b>Connection capacity (min. ... max.)</b>		
 Rigid solid	1 x	1...2.5 mm <sup>2</sup>
	2 x	1...2.5 mm <sup>2</sup>
 Flexible with non insulated ferrule	1 x	0.75...2.5 mm <sup>2</sup>
	2 x	0.75...2.5 mm <sup>2</sup>
 Flexible with insulated ferrule	1 x	0.75...2.5 mm <sup>2</sup>
	2 x	0.75...1.5 mm <sup>2</sup>
 Lugs	L ≤	8 mm
	I >	3.7 mm
<b>Connection capacity acc. to UL / CSA</b>	1 or 2 x	AWG 18...14
<b>Stripping length</b>		10 mm
<b>Tightening torque</b>		1.2 N.m / 11 lb.in
<b>Degree of protection</b> acc. to IEC 60947-1 / EN 60947-1 and IEC 60529 / EN 60529		IP20
<b>Screw terminals</b> All terminals		Delivered in open position, screws of unused terminals should be tightened M3.5
<b>Screwdriver type</b>		Flat Ø 5.5 / Pozidriv 2
<b>Terminal Marking</b>		 

# Interlocks



## Mechanical interlock units

### Description

The VM mechanical interlock units are designed for the interlocking of two AF contactors. When mounted between two contactors, the VM mechanical interlock unit prevents one of the contactors from closing as long as the other contactor is closed. The mechanical interlock units VM4 and VM96-4 include 2 fixing clips (BB4).

### Ordering details

For contactors	Mounting	Type	Order code	Pkg qty	Weight (1 pce) kg
<b>Mechanical interlock units for two contactors mounted side by side</b>					
AF09 ... AF38..-30-..		VM4	1SBN030105T1000	10	0.005
AF09 ... AF38..-40-00					
AF40 ... AF96		VM96-4	1SBN033405T1000	10	0.006
For same size contactors:		VM19	1SFN030300R1000	1	0.054
AF116 ... AF146					
AF190, AF205					
AF265 ... AF370					
AF116 ... AF146 and AF190, AF205		VM140/190	1SFN034403R1000	1	0.088
AF190, AF205 and AF265 ... AF370		VM205/265	1SFN035203R1000	1	0.090
AF400 ... AF1250	PN.. mounting plate to be ordered separately	VM750H	1SFN035700R1000	1	0.200
AF1350 ... AF2650	Plate included	VM1650H	1SFN036503R1000	1	6.000
<b>Mechanical interlock units for two contactors mounted one above the other</b>					
AF400 ... AF1250	Additional plate (not supplied)	VM750V	1SFN035701R1000	1	0.200

5



## Mechanical and electrical interlock sets

### Description

VEM4 mechanical and electrical interlock set for the interlocking of two AF contactors. VEM4 set includes a mechanical interlock unit VM4 with 2 fixing clips (BB4) and a VE4 electrical interlock block with A2-A2 connection. Fixing the electrical interlock block to the contactor front face connects the 2 built-in N.C. interlocking contacts with the two coils. VE4 block must be used with A2-A2 connection to respect the electrical connection diagram.

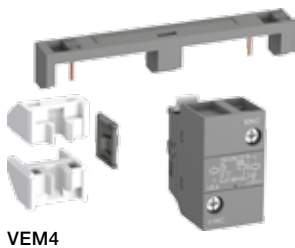

### Ordering details

For contactors	Auxiliary contacts	Type	Order code	Pkg qty	Weight (1 pce) kg
<b>Mechanical and electrical interlock set</b>					
For same size contactors:	0 2	VEM4	1SBN030111R1000	1	0.035
AF09 ... AF16..-30-..					
AF26 ... AF38..-30-00					
AF09, AF16..-40-00					
AF26, AF38..-40-00					

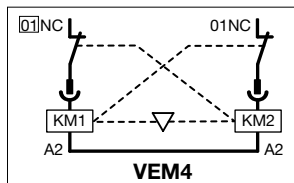

### Fixing clips

For contactors	Type	Order code	Pkg qty	Weight (1 pce) kg
AF09 ... AF38	BB4	1SBN110120W1000	50	0.002

Note: VEM4 not suitable for AF..Z contactors with DC control voltage 12...20 V DC.

# Interlocks

## Technical data

### Mechanical interlock unit

Types	VM4, VM96	VM19 ... VM750	VM1650H
Mechanical durability	Number of operating cycles	5 millions operating cycles	1 million operating cycles
	Max. mechanical switching frequency	1800 cycles/h	300 cycles/h

### Mechanical and electrical interlock set





#### Contact utilization characteristics according to IEC

Types	VEM4
Standards	IEC 60947-5-1 and EN 60947-5-1
Rated insulation voltage $U_i$ acc. to IEC 60947-5-1	690 V
Rated impulse withstand voltage $U_{imp}$ .	6 kV
Rated control circuit voltage $U_c$	AC 50/60 Hz control voltage
	DC control voltage
Conventional thermal current $I_{th} - \theta \leq 40 \text{ }^\circ\text{C}$	24...500 V AC 20...500 V DC 16 A
Mechanical durability	Number of operating cycles
	Max. mechanical switching frequency
Electrical durability	5 millions operating cycles 1800 cycles/h 1200 cycles/h

#### Contact utilization characteristics according to UL / CSA

Types	VEM4
Standards	UL 508, CSA C22.2 N°14
Max. operational voltage	500 V AC, 500 V DC

### Connecting characteristics

Types	VEM4
Connection capacity (min. ... max.)	
 Rigid solid	1 x 1...2.5 mm <sup>2</sup> 2 x 1...2.5 mm <sup>2</sup>
 Flexible with ferrule	1 x 0.75...2.5 mm <sup>2</sup> 2 x 0.75...2.5 mm <sup>2</sup>
 Flexible with insulated ferrule	1 x 0.75...2.5 mm <sup>2</sup> 2 x 0.75...1.5 mm <sup>2</sup>
 Lugs	L < 8 mm
Connection capacity acc. to UL / CSA	1 or 2 x AWG 18...14
Stripping length	10 mm
Tightening torque	1.2 Nm / 11 lb.in
Degree of protection	IP20
acc. to IEC 60947-1 / EN 60947-1 and IEC 60529 / EN 60529	
Screw terminals	Delivered in open position, screws of unused terminals must be tightened
All terminals	M3.5
Screwdriver type	Flat Ø 5.5 / Pozidriv 2

# Impulse contact blocks

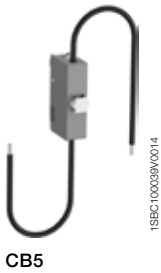

CB5

## Description



Impulse contact blocks are designed for use in enclosures, in association with an adjustable mechanical pushbutton. Two types are available:

- CB5-10: N.O. contact with a black actuator ("ON" function)
- CB5-01: N.C. contact with a light grey actuator ("OFF" function).

These blocks are equipped with 2 connecting leads 0.5 mm<sup>2</sup> with end, approximately 18 cm long.

Mounting: Clipped onto the front face of the contactors.

## Ordering details

For contactors	Contacts	Type	Order code	Pkg qty	Weight (1 pce) kg
	 				
AF09 ... AF38	1 -	CB5-10	1SBN010013R1010	1	0.012
	- 1	CB5-01	1SBN010013R1001	1	0.012

Note: For AF40 ... AF96 mounting: please consult us.

## Main dimensions mm, inches

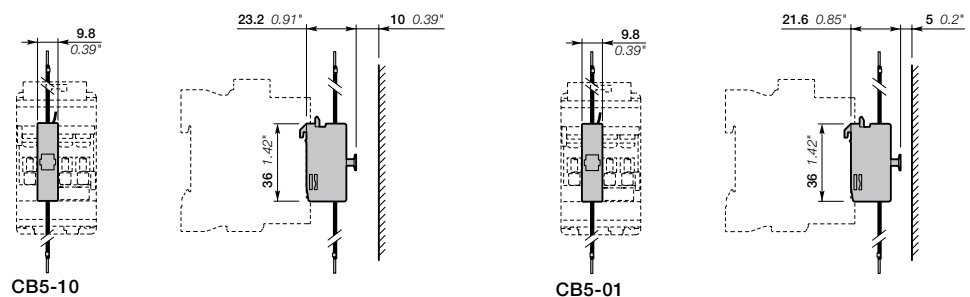

# Notes

A series of horizontal dotted lines for taking notes, spanning the width of the page.

# Mechanical latching units



1SBCT00040V0014

WB75-A

## Description

For converting standard contactors into latched contactors.

The WB75-A block contains a mechanical latching device with electromagnetic impulse unlatching (AC or DC) or manual unlatching.

Captive screw type connecting terminals, built-in cable clamps, M3.5 (+,-) pozidriv 2 screw with screw-driver guidance; delivered untightened and protected against accidental direct contact.

## Operation

After closing, the contactor continues to be held in the closed position by the latching mechanism should the supply voltage fail at the contactor coil terminals.

Contactor opening can be controlled:

- electrically by an impulse (AC or DC) on the WB75-A block coil.  
(the coil is not designed to be permanently energized)
- manually by pressing the pushbutton on the front face of the WB75-A block.

## Mounting

The WB75-A block is clipped onto the front face of the 1-stack contactor where it takes up two slots (see dimension drawing). The two other slots do not accept CA4 single pole auxiliary contacts. Up to 2 CAL4-11 auxiliary contact blocks can be side-mounted on contactors (except NF22E and AF.-22-00, refer to main accessory fitting details table in main accessories section).

## Ordering details

For contactors	Rated control circuit voltage		Type	Order code	Pkg qty	Weight (1 pce)
	Uc V 50 Hz or DC	V 60 Hz				
AF09 ... AF38 NF	24	24...28	WB75-A	FPTN372726R1001	1	0.120
	42	42...48	WB75-A	FPTN372726R1002	1	0.120
	48	48...55	WB75-A	FPTN372726R1003	1	0.120
	110	110...127	WB75-A	FPTN372726R1004	1	0.120
	220...230	220...255	WB75-A	FPTN372726R1006	1	0.120
	230...240	230...277	WB75-A	FPTN372726R1005	1	0.120
	380...415	380...440	WB75-A	FPTN372726R1007	1	0.120
	415...440	440...480	WB75-A	FPTN372726R1008	1	0.120

Note: For WB75-A produced since week 06-2012.

5

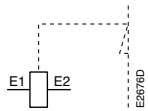

Terminal marking

# Mechanical latching units





## Technical data

Type	WB75-A
------	--------

## Utilization characteristics according to IEC

Rated insulation voltage Ui acc. to IEC 60947-1	690 V
<b>Max. electrical impulse time</b>	
On AC coil (with load factor 5 %)	20 s
On DC coil (with load factor 3 %)	8 s
<b>Min. electrical impulse time</b>	
For latching (energizing of the contactor coil)	<b>AC</b> 120 ms
	<b>DC</b> 120 ms
For pull-out (energizing of the WB block coil)	<b>AC</b> 30 ms
	<b>DC</b> 50 ms
<b>Coil operating limits</b>	<b>AC or DC supply</b> 0.85...1.1 x Uc
<b>AC control voltage</b> 50/60 Hz	
Rated control circuit voltage Uc	24...480 V AC
Coil consumption	<b>Average pull-in value</b> 90 VA
	<b>Average holding value</b> 60 VA
<b>DC control voltage</b>	
Rated control circuit voltage Uc	24...440 V DC
Coil consumption	<b>Average pull-in value</b> 110 W
	<b>Average holding value</b> 110 W
<b>Operating time</b>	
On contactor closing (latching)	
Between coil energization and:	
	<b>N.O. contact closing</b> No difference with the operation of a contactor without mechanical latching unit
	<b>N.C. contact opening</b> No difference with the operation of a contactor without mechanical latching unit
On contactor opening (unlatching)	
Between WB coil energization and:	
	<b>N.O. contact opening</b> 5...25 ms
	<b>N.C. contact closing</b> 7...28 ms
<b>Mechanical durability</b>	<b>Number of operating cycles</b> 1 million operating cycles
<b>Max. switching frequency</b>	3600 cycles/h with on-load factor of 8 %

## Connecting characteristics

<b>Connection capacity</b> (min. ... max.)	
 Rigid solid	<b>1 x</b> 1...4 mm <sup>2</sup>
 Flexible with ferrule	<b>2 x</b> 1...4 mm <sup>2</sup>
 Flexible with ferrule	<b>1 x</b> 0.75...2.5 mm <sup>2</sup>
 Flexible with ferrule	<b>2 x</b> 0.75...2.5 mm <sup>2</sup>
 Lugs	<b>L &lt;</b> 8 mm
	<b>I &gt;</b> 3.5 mm
<b>Tightening torque</b>	
Recommended	1 Nm
Max.	1.2 Nm
<b>Screw terminals</b>	Delivered in open position, screws of unused terminals must be tightened
All terminals	M3.5
<b>Screwdriver type</b>	Flat Ø 5.5 / Pozidriv 2

# Other accessories



LDC4

## Ordering details

For contactors	Type	Order code	Pkg qty	Weight (1 pce)
				kg



BX4

## Additional coil terminal blocks

Additional coil terminal blocks for a bottom access to the coil terminals of contactors or contactor relays.

AF09 ... AF96, NF	LDC4	1SBN070156T1000	10	0.010
-------------------	------	-----------------	----	-------

## Protective covers

Sealable and transparent protective covers BX4 and non-removable BX4-CA to protect the devices against accidental contact.

AF09 ... AF96 1-stack contactors and NF contactor relays	BX4	1SBN110108T1000	10	0.006
4-pole CA4, 2-pole CAT4 auxiliary contact blocks and TEF4 electronic timer	BX4-CA	1SBN110109W1000	50	0.001

Note: BX4 produced since 13045 (day 045 - year 2013) are suitable for AF40 ... AF96.



BX4-CA

## Function markers AF09 ... AF370

Box of 16 blank cards (16 markers by card) printable on HTP500 thermal transfer printer and AMS 500 marking table to identify your contactors, overload relays or manual motor starters. Marker dimensions: 7 x 20 mm (.276" x .787").

AF09 ... AF370 contactors, TF thermal overload relays, EF electronic overload relays and MS116, MS132 manual motor starters	BA4	1SNA235156R2700	16	0.011
AMS 500 support plate for 8 BA4	SPRC 1	1SNA360010R1500	1	0.220
HTP500 support plate	HTP500-BA4	1SNA235712R2400	1	0.290



BA4

## Function markers AF400 ... AF2650

Set of 50 function markers designed to be clipped onto the front face of devices. Details can be added to these markers using a ball point pen, indelible felt-tip pen or pentel white.

Self-adhesive labels (not supplied) can also be added to them. Marker dimensions: 7 x 19 mm (.276" x .748").

AF400 ... AF2650 and accessories	BA5-50	1SBN110000R1000	1	0.017
----------------------------------	--------	-----------------	---	-------



BA5-50

## Main dimensions mm, inches

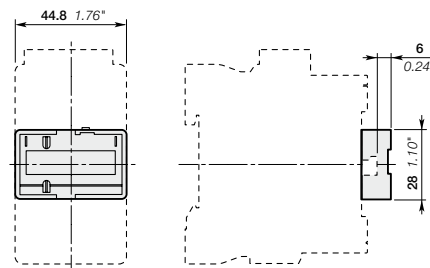

BX4



# Other accessories



BP38-4



BDT4  
For AF09 ... AF65, NF



BDT4  
For AF80 ... AF96

## Ordering details

For contactors	Type	Order code	Pkg qty	Weight (1 pce) kg
----------------	------	------------	---------	-------------------

## Mounting pieces

Mounting piece for replacing installed contactors fixed by screws by AF contactors.

From contactor	To contactor				
A26 ... A40, AL26 ... AL40	AF09 ... AF38	BP38-4	1SBN112303T1000	10	0.003
A40 ... A75, AE50 ... AE75, AF50 ... AF75	AF40 ... AF65	BP65-4	1SBN113403T1000	10	0.004
A95, A110, AE95, AE110, AF95, AF110	AF80 ... AF96	BP96-4	1SBN113903T1000	10	0.005

## Test block

BDT4 test block is suitable for switching on contactor off-load.

Marking on the block indicates the contactor type to fit with.

AF09 ... AF96, NF	BDT4	1SBN110122T1000	10	0.007
-------------------	------	-----------------	----	-------

## Main dimensions mm, inches

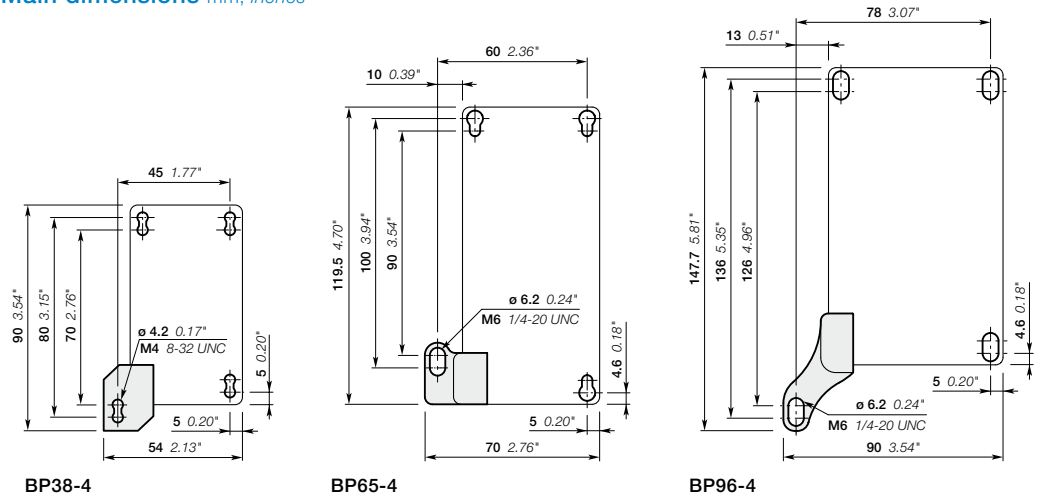

# Terminal shrouds



1SFC101038W0001

LT140-30L

## Description

Main terminal protection for AF116 ... AF1250 contactors.

The auxiliary contact blocks and coils are designed to provide an IP 20 degree of protection.

The main terminals, equipped with compression lugs or cable clamps, can be protected against accidental direct contact after wiring (EN 50274) by the addition of terminal shrouds (see table below).

## Ordering details

For contactors	Type	Order code	Pkg qty	Weight (1 pce) kg
AF116 ... AF146, with compression lugs	LT140-30L	1SFN124203R1000	2	0.070
AF190, AF205, with cable clamps	LT205-30C	1SFN124801R1000	2	0.050
AF190, AF205, with compression lugs	LT205-30L	1SFN124803R1000	2	0.220
AF190, AF205, with shorting bar or between contactor and TOL/EOL in DOL starters	LT205-30Y	1SFN124804R1000	1	0.050
AF265 ... AF370, with cable clamps	LT370-30C	1SFN125401R1000	2	0.035
AF265 ... AF370, with compression lugs	LT370-30L	1SFN125403R1000	2	0.280
AF265 ... AF370, with shorting bar or between contactor and TOL/EOL in DOL starters	LT370-30Y	1SFN125404R1000	1	0.075
AF265 ... AF370, for use with extending cable clamps, ATK300/2 and OZXB4	LT370-30D	1SFN125406R1000	1	0.15
AF400, AF460 with cable clamps	LT460-AC	1SFN125701R1000	2	0.100
AF400, AF460 with compression lugs	LT460-AL	1SFN125703R1000	2	0.800
AF580, AF750 with cable clamps	LT750-AC	1SFN126101R1000	2	0.120
AF580, AF1250 with compression lugs	LT750-AL	1SFN126103R1000	2	0.825



1SFC101041V0001

LT370-30C



1SFC101039W0001

LT460-AC



1SFC101038/0001

LW140

## Terminal enlargements

### Description

Enlargement pieces designed to increase the width of the contactor terminal pads in order to allow larger connections to be mounted.

### Ordering details

For contactors	Dimensions		Type	Order code	Pkg qty	Weight (1 pce)
	hole Ø mm	bar mm				
AF116 ... AF146	6.5	13 x 3	LW140	1SFN074207R1000	1	0.115
AF190, AF205	10.5	17.5 x 5	LW205	1SFN074807R1000	1	0.260
AF265 ... AF370	10.5	20 x 5	LW370	1SFN075407R1000	1	0.340
AF400, AF460	10.5	25 x 5	LW460	1SFN075707R1000	1	0.730
AF580, AF750	13	40 x 6	LW750	1SFN076107R1000	1	1.230
AF1250	13	50 x 10	LW1250	1SFN076407R1000	1	2.000



1SFC101049/0001

LX140

## Terminal extension

### Description

Extension pieces designed to extend the main terminals of contactors for combined mounting of contactors and connection sets.

### Ordering details

For contactors	Dimensions		Type	Order code	Pkg qty	Weight (1 pce)
	hole Ø mm	bar mm				
AF116 ... AF146	6.5	13 x 3	LX140	1SFN074210R1000	1	0.072
AF190, AF205	8.5	17.5 x 5	LX205	1SFN074810R1000	1	0.180
AF265 ... AF370	10.5	20 x 5	LX370	1SFN075410R1000	1	0.234
AF400, AF460	10.5	25 x 5	LX460	1SFN075710R1000	1	0.500
AF580, AF750	13	40 x 6	LX750	1SFN076110R1000	1	0.850



1SFC101073/0001

LL146-30

## Connection sockets

### Description

Connection socket can be used to replace built-in cable clamps in AF116 ... AF146.

### Ordering details

For contactor	Type	Order code	Pkg qty	Weight (1 pce)
AF116 ... AF146	LL146-30	1SFN074211R1000	6	0.102



1SFC101046/0001

LD146-30

## Connection module

### Description

Connection module can be fixed on AF116 ... AF146 delivered with bar terminals.

### Ordering details

For contactor	Type	Order code	Pkg qty	Weight (1 pce)
AF116 ... AF146	LD146-30	1SFN074208R1000	2	0.165

# Terminal connecting strips and shorting bars



LY16-4

1SBC100024V0014



LP185

1SFC101088V0001

## Description

Parallel and series connection of 3-pole contactors:

- To obtain a star point (3 parallel-connected poles)
- To connect poles in parallel and thus increase the AC load passing through the flow path made up of the parallel-connected poles: LP, LY.  
The relevant cable cross-sectional area may limit the maximum permissible current. Consult information in table below
- To connect poles in series and thus increase the DC load controlled by the poles: LP, LY (only LY16-4 and LY38-4 secable strips).

Types	for connection of "n" poles	with terminal	insulated
LP	n = 2	no	no (1)
LY	n = 2 (secable LY16-4, LY38-4 connecting strips) n = 3	no no	yes yes (1)

(1) LP460 ... LP750, LY185 ... LY750 not insulated. Use terminal shrouds.

## Ordering details

For contactors	max. nominal continuous current with "n" poles				Cable cross-sectional area mm <sup>2</sup>	Type	Order code	Pkg qty	Weight (1 pce) kg
	in parallel		in series						
	2 poles	3 poles	4 poles	2 poles					
AF09	30	33	-	25	6	LY16-4	1SBN071303T1000	10	0.006
AF12	32	36	-	27					
AF16	34	40	-	30					
AF26	50	60	-	45	10	LY38-4	1SBN072303T1000	10	0.012
AF116 ... AF146	-	240	-	-	-	LY140	1SFN074203R1000	1	0.055
AF190, AF205	-	400	-	-	-	LY185	1SFN074703R1000	1	0.200
AF265 ... AF370	-	670	-	-	-	LY300	1SFN075103R1000	1	0.300
AF400, AF460	-	1000	-	-	-	LY460	1SFN075703R1000	1	0.450
AF580, AF750	-	1650	-	-	-	LY750	1SFN076103R1000	1	0.800
AF190, AF205	300	-	-	-	-	LP185	1SFN074712R1000	2	0.300
AF265 ... AF370	475	-	-	-	-	LP300	1SFN075112R1000	2	0.400
AF400, AF460	725	-	-	-	-	LP460	1SFN075712R1000	2	0.550
AF580, AF750	1200	-	-	-	-	LP750	1SFN076112R1000	2	0.950

# Connection accessories for starting solutions

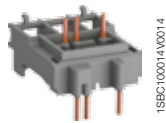

BEA16-4

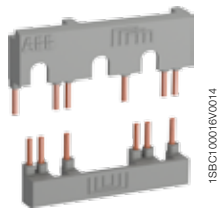

BER16-4

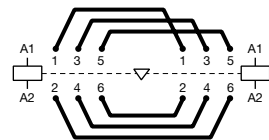

BEA, BER  
Reversing connections

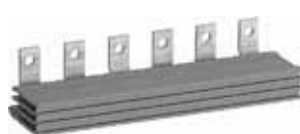

BEP140-30

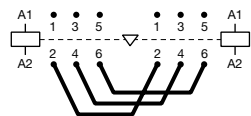

BEP, BES  
Phase to phase connections

## Connecting links with manual motor starters

### Description

The BEA insulated 3-pole connecting links are used to connect AF09 ... AF38 contactors with the MS116 or MS132 manual motor starters.

The BEA insulated 3-pole connecting links ensure the electrical and mechanical connection between the contactor and the associated manual motor starter.

### Ordering details

For 3-pole contactors	Manual motor starter	Type	Order code	Pkg qty	Weight (1 pce) kg
AF09 ... AF16	MS116-0.16 ... MS116-25, MS132-0.16 ... MS132-25	BEA16-4	1SBN081306T1000	10	0.025
AF26 ... AF38	MS116-0.16 ... MS116-16, MS132-0.16 ... MS132-10	BEA26-4	1SBN082306T1000	10	0.025
	MS116-20 ... MS116-32, MS132-12 ... MS132-32	BEA38-4	1SBN082306T2000	10	0.030

## Connection sets for reversing contactors

### Description

The BER and BEM connection sets are used to connect the main poles of two 3-pole contactors mounted side by side.

The BER connection sets are made up of 1 upstream and 1 downstream connections.

The BEM connection sets are made up of 3 upstream and 3 downstream connections.

BER and BEM connection sets are insulated and made of solid copper bars.

### Ordering details

For 3-pole contactors	Type	Order code	Pkg qty	Weight (1 pce) kg
AF09 ... AF16	BER16-4	1SBN081311R1000	1	0.045
AF26 ... AF38	BER38-4	1SBN082311R1000	1	0.100
AF40 ... AF65	BER65-4	1SBN083411R1000	1	0.175
AF80, AF96	BER96-4	1SBN083911R1000	1	0.250
AF116 ... AF146	BER140-4	1SBN084211R1000	1	0.615
AF190, AF205	BER205-4	1SBN084811R1000	1	1.237
AF265 ... AF370	BER370-4	1SBN085411R1000	1	2.140
AF400, AF460	BEM460-30	1SBN085701R1000	1	4.400
AF580, AF750	BEM750-30	1SBN086101R1000	1	7.300

## 3-pole phase to phase connections

### Description

The BEP and BES connection sets are used to connect phase to phase the main poles of two 3-pole contactors mounted side by side.

The BEP connection sets are made up of 1 upstream or downstream connections.

The BES connection sets are made up of 3 upstream or downstream connections.

BEP and BES connection sets are insulated and made of solid copper bars.

### Ordering details

For 3-pole contactors	Type	Order code	Pkg qty	Weight (1 pce) kg
AF116 ... AF146	BEP140-30	1SBN084214R1000	1	0.320
AF190, AF205	BEP205-30	1SBN084814R1000	1	0.534
AF265 ... AF370	BEP370-30	1SBN085414R1000	1	0.926
AF400, AF460	BES460	1SBN085704R1000	1	2.200
AF580, AF750	BES750	1SBN086104R1000	1	3.700

# Connection sets for star-delta starter

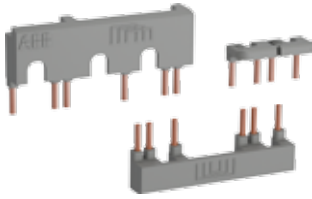

BEY16-4

1SBC100018V0014

## Description

The BEY and BED connection sets are used to connect the main poles of the Line, Delta and Star contactors of a star-delta starter.

The connection sets are made up of:

- Line contactor / delta contactor:
  - BEY: upstream phase-to-phase connection
  - BED: upstream connection in parallel
- Delta contactor / star contactor: downstream connection in parallel
- Star contactor: star point upstream
- Insulated, solid copper bar.

## Ordering details

For 3-pole line, delta & star contactors	Interlock unit between delta & star contactors	Type	Order code	Pkg qty	Weight (1 pce) kg
AF09 ... AF16	With or without VM4 or VEM4	BEY16-4	1SBN081313R2000	1	0.050
AF26 ... AF38	With or without VM4 or VEM4	BEY38-4	1SBN082713R2000	1	0.110
AF40 ... AF65	With or without VM96-4	BEY65-4	1SBN083413R2000	1	0.200
AF80, AF96	With or without VM96-4	BEY96-4	1SBN083913R2000	1	0.250
AF116 ... AF146	With or without VM19	BEY140-4	1SFN084413R1000	1	1.040
AF190 ... AF205 (line and delta) AF140 ... AF146 (star)	With or without VM140/190	BEY190-4	1SFN084813R1000	1	1.154
AF190, AF205	With or without VM19	BEY205-4	1SFN085213R1000	1	1.205
AF265 ... AF370 (line and delta) AF190 ... AF205 (star)	With or without VM205/265	BEY265-4	1SFN085413R1000	1	2.020
AF265 ... AF370	With or without VM19	BEY370-4	1SFN085813R1000	1	2.110
AF400 ... AF460	With or without VM750H	BED460	1SFN085703R1000	1	4.700
AF580 ... AF750 (line and delta) AF400 ... AF460 (star)	With or without VM750H	BED580	1SFN085903R1000	1	6.300
AF580 ... AF750	With or without VM750H	BED750	1SFN086103R1000	1	7.700

5

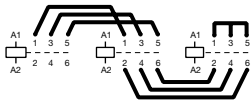

AF09 ... AF370  
Line-delta-star connection

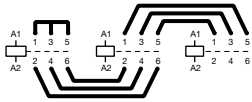

AF400 ... AF750  
Star-delta-line connection

# Connection bars



BEA140/XT2

1SFC101061V0001



BEA205/T4

1SFC101064V0001



BEA370/T5

1SFC101065V0001

## Connection bars between contactors and MCCB

### Description

Connection between contactors/starters and moulded case circuit breakers. These connection sets are solid copper bars.

### Ordering details

For contactors	MCCB	Type	Order code	Pkg qty	Weight (1 pce)
					kg

#### Vertical assembly

AF116 ... AF146	XT2	BEA140/XT2	1SFN084206R1000	1	0.058
AF116 ... AF146	XT4	BEA140/XT4	1SFN084206R1001	1	0.068
AF190, AF205	XT4	BEA205/XT4	1SFN084806R1000	1	0.200
AF190, AF205	T4	BEA205/T4	1SFN084806R1001	1	0.190
AF265 ... AF370	T5	BEA370/T5	1SFN085406R1000	1	0.350
AF400 ... AF750	T6	BEA750/T6	1SFN086106R1000	1	0.410
AF400 ... AF750	T5	BEA750/T5	1SFN086106R1001	1	0.410

#### Vertical assembly with control wire terminals (also suitable when using busbar kits for starter combinations)

AF400 ... AF750	T5	BEA750D/T5	1SFN086106R1003	1	0.720
AF400 ... AF750	T6	BEA750D/T6	1SFN086106R1002	1	0.720

#### Horizontal assembly (also suitable when using busbar kits for starter combinations)

AF400, AF460	T4	BEA460H/T4	1SFN085907R1000	1	2.450
--------------	----	------------	-----------------	---	-------

## Connection bars between contactors and switch fuse

### Description

Connection between contactors/starters and moulded case circuit breakers. These connection sets are solid copper bars.

### Ordering details

For contactors	Switch fuse	Type	Order code	Pkg qty	Weight (1 pce)
					kg

#### Vertical assembly

AF400, AF460	OESA400	BEF460/OESA400	1SFN085708R1000	1	0.340
AF460 ... AF750	OESA630 to OESA800	BEF750/OESA800	1SFN086108R1000	1	0.740

#### Horizontal assembly

AF400, AF460	OESA400...LR	OESA460H/OESA400	1SFN085709R1000	1	1.250
--------------	--------------	------------------	-----------------	---	-------

Note: The BEF connection bars provided for the A145 ... A300 contactors can be used for the AF145 ... AF300 contactors.

# Mounting plates



PN460

1SFC101063V0001

## Description

Mounting plates with fixing holes for the specified contactors and overload relays.

## Ordering details

For contactors	For overload relays	Type	Order code	Pkg qty	Weight (1 pce)
----------------	---------------------	------	------------	---------	----------------

### Mounting plates for Direct on line starters

AF400, AF460	E500DU	PN460-11	1SFN095705R1000	1	2.120
AF580, AF750	E800DU	PN750-11	1SFN096105R1000	1	2.500

For two contactors side by side with space for mechanical interlock	For one or two overload relays	Type	Order code	Pkg qty	Weight (1 pce)
---	--------------------------------	------	------------	---------	----------------

### Mounting plates for mechanical interlocked contactors, reversing starters and two speed starters for double windings

AF400, AF460	E500DU	PN460-21	1SFN095701R1000	1	3.490
AF580, AF750	E800DU	PN750-21	1SFN096101R1000	1	4.230

For main and delta contactors	For star contactor (1)	For overload relays	Type	Order code	Pkg qty	Weight (1 pce)
-------------------------------	------------------------	---------------------	------	------------	---------	----------------

### Mounting plates for star-delta starters and two speed starters for single windings

AF400, AF460	A300, AF400	E500DU	PN460-41	1SFN095703R1000	1	5.310
AF580, AF750	AF400 ... AF580	E800DU	PN750-41	1SFN096103R1000	1	6.320

(1) Space for mechanical interlock included.



# Adapter plates

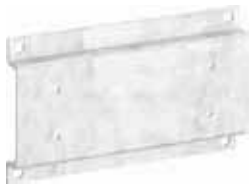

1SFC101048/0001

PR146-1

## Description

Adapter plates with fixing holes for replacing installed contactors.

## Ordering details

From contactors	To contactor	Type	Order code	Pkg qty	Weight (1 pce) kg
A95, AF95, A110, AF110	AF116, AF140, AF146	PR146-1	1SFN094200R1000	1	0.300
EH150, EH160, EH175, EH210, EG160	AF190, AF205	PR210-1	1SFN094900R1000	1	0.440
EH250, EH260, EH300	AF265, AF305, AF370	PR300-1	1SFN095300R1000	1	0.560
EH370, EH550, EG315	AF400, AF460, AF580	PR460-1	1SFN095700R1000	1	0.900
EH700, EH800	AF750	PR750-1	1SFN096100R1000	1	0.500
OKYM150, OKYM175	AF190	PR185-2	1SFN095100R1001	1	0.500
OKYM200, OKYM250	AF265, AF305, AF370	PR300-2	1SFN095300R1001	1	0.500
OKYM315	AF400, AF460	PR400-2	1SFN095700R1002	1	0.820
OKYM400	AF400, AF460	PR460-2	1SFN095700R1001	1	0.800
OKYM500	AF580	PR580-2	1SFN096100R1002	1	0.700
EH550, EG630, OKYM630	AF580, AF750	PR750-2	1SFN096100R1001	1	1.100

5

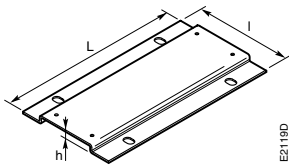

EZ119D

## Dimensions (mm)

Type of the plate	Dimensions			Fixing holes mm
	L	l	h	
PR146-1	150	90	15	4 x $\varnothing$ 6.5
PR210-1	200	132	11.5	4 x $\varnothing$ 7
PR300-1	200	172	11.5	4 x $\varnothing$ 7
PR460-1	278	198	11.5	4 x $\varnothing$ 7
PR750-1	283	244	11.5	4 x $\varnothing$ 7
PR185-2	202	152	11.2	4 x $\varnothing$ 11
PR300-2	202	152	11.2	4 x $\varnothing$ 11
PR400-2	278	151	11.5	4 x $\varnothing$ 11
PR460-2	278	176	11.5	4 x $\varnothing$ 11
PR580-2	283	176	11.5	4 x $\varnothing$ 11
PR750-2	283	255	11.5	4 x $\varnothing$ 14

Fixing holes according to the plate types

1SFC101107C0201

# Contactors coils, main contact sets and arc chutes



ZAF1650

1SFC101007F0201

## Contactors coils

### Ordering details

For contactors	Rated control circuit voltage Uc min. ... Uc max.		Type	Order code	Pkg qty	Weight (1 pce) kg
	V 50/60 Hz	V DC				
	AF400, AF460	-				
	48...130	48...130	ZAF460	1SFN155770R6906	1	0.525
	100...250	100...250	ZAF460	1SFN155770R7006	1	0.525
	250...500	250...500	ZAF460	1SFN155770R7106	1	0.525
AF580 ... AF1250	-	24...60	ZAF750	1SFN156170R6806	1	1.335
	48...130	48...130	ZAF750	1SFN156170R6906	1	1.335
	100...250	100...250	ZAF750	1SFN156170R7006	1	1.335
	250...500	250...500	ZAF750	1SFN156170R7106	1	1.335
AF1350 ... AF2050	100...250	100...250	ZAF1650 (1)	1SFN156570R7026	1 set	0.900
			ZP1650 (2)	1SFN166521R1070	1	0.300
AF2650	100...250	100...250	ZAF2650 (1)	1SFN156670R7026	1 set	0.900
			ZP2650 (2)	1SFN166621R1070	1	0.300

(1) One set of two coil.

(2) Printed circuit board.

5

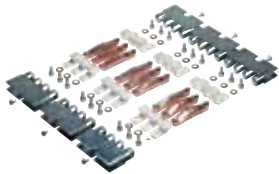

ZL1650

1SFC101069F0201

## Main contact sets

### Description

The contact sets for 3-pole contactors consists of six fixed contacts, three moving contacts, springs and the required screws.

### Ordering details

For contactors	Type	Order code	Pkg qty	Weight (1 pce) kg
AF400	ZL400	1SFN165703R1000	1	1.320
AF460	ZL460	1SFN165903R1000	1	1.320
AF580	ZL580	1SFN166103R1000	1	1.840
AF750	ZL750	1SFN166303R1000	1	1.840
AF1250	ZL1250	1SFN166403R1000	1	1.840
AF1350	ZL1350	1SFN166503R1000	1	2.500
AF1650	ZL1650	1SFN166703R1000	1	3.500
AF2050	ZL2050	1SFN167003R1000	1	3.500
AF2650	ZL2650	1SFN166603R1000	1	1.200

## Arc chutes

### Ordering details

For contactors	Type	Order code	Pkg qty	Weight (1 pce) kg
AF400, AF460	ZW460	1SFN165710R1000	1	1.380
AF580, AF750, AF1250	ZW750	1SFN166110R1000	1	1.500
AF1350, AF1650, AF2050	ZW1650	1SFN166510R1000	1	4.000
AF2650	ZW2650	1SFN166610R1000	1	4.000

1SFC101137C0201

# Accessories for A45, A50, A75, (T)AE45, (T)AE50, (T)AE75, AF45, AF50, AF75 4-pole contactors and UA, UA..RA contactors

Auxiliary contact blocks	5/228
Electronic timers	5/234
Impulse contact blocks	5/237
Mechanical and electrical interlock units	5/238
CA5, CE5, CAL5 and TEF5 fitting details	5/240
Function markers - Mounting piece	5/241
Surge suppressors for contactor coils	5/242
Interface relays	5/244
Mechanical latching units	5/246
Additional terminal blocks	5/248
Terminals for control lead connections	5/249
Other accessories	5/250
Contactor coils and main contact sets	5/251

# Auxiliary contact blocks



CA5-10



CA5-40E



CAL5-11



CAL18-11

## Description

The auxiliary contact blocks are used for the operation of auxiliary circuits and control circuits for standard industrial environments.

Types of auxiliary contact blocks for front mounting:

- CA5 1 or 4-pole block, instantaneous with N.O., N.C. contacts
- CC5 1-pole block, with N.O. leading contact or N.C. lagging contact.

Select the 4-pole auxiliary contact blocks CA5 type, according to the contactor type for compliance with the standard requirements (see "Terminal Marking and Positioning").

Types of auxiliary contact blocks for side mounting:

- CAL 2-pole block instantaneous N.O. + N.C. contacts.

For clipping onto the right- and/or left-hand side of the contactors.

The auxiliary contact blocks are equipped with screw type connecting terminals delivered open, protected against accidental direct contact and bear the corresponding function marking.

## Ordering details

For contactors	Number of blocks (1)	Auxiliary contacts	Type	Order code	Pkg qty	Weight (1 pce)
						kg

### Front-mounted instantaneous auxiliary contact blocks, 1-pole

A45, A50, A75 .....	1-6	1	0	-	-	CA5-10	1SBN010010R1010	10	0.014
AE45, AE50, AE75 .....	1-6	0	1	-	-	CA5-01	1SBN010010R1001	10	0.014
TAE45, TAE50, TAE75 .....	1-6	-	-	1	0	CC5-10	1SBN010011R1010	10	0.014
AF45, AF50, AF75 .....	1-6	-	-	0	1	CC5-01	1SBN010011R1001	10	0.014
UA16 ... UA110 .....	1-6	-	-	0	1	CC5-01	1SBN010011R1001	10	0.014

### Front-mounted instantaneous auxiliary contact blocks, 4-pole

A45, A50, A75 .....	1	2	2	-	-	CA5-22E	1SBN010040R1022	2	0.060
AE45, AE50, AE75 .....	1	3	1	-	-	CA5-31E	1SBN010040R1031	2	0.060
TAE45, TAE50, TAE75 .....	1	4	0	-	-	CA5-40E	1SBN010040R1040	2	0.060
AF45, AF50, AF75 .....	1	0	4	-	-	CA5-04E	1SBN010040R1004	2	0.060
UA50 ... UA110 .....	1	1	1	1	1	CA5-11/11E	1SBN010040R1018	2	0.060
UA16 ... UA30 .....	1	2	2	-	-	CA5-22M	1SBN010040R1122	2	0.060
		3	1	-	-	CA5-31M	1SBN010040R1131	2	0.060
		1	3	-	-	CA5-13M	1SBN010040R1113	2	0.060
		0	4	-	-	CA5-04M	1SBN010040R1104	2	0.060
		1	1	1	1	CA5-11/11M	1SBN010040R1118	2	0.060

### Side-mounted instantaneous auxiliary contact blocks, 2-pole

A45, A50, A75 .....	1-2	1	1	-	-	CAL5-11	1SBN010020R1011	2	0.050
AE45, AE50, AE75 .....	1								
TAE45, TAE50, TAE75 .....	1								
AF45, AF50, AF75 .....	1-2								
UA16 ... UA75 .....	1-2								
UA95, UA110 .....	1-2	1	1	-	-	CAL18-11	1SBN010720R1011	2	0.050

(1) For each contactor type, refer to "Accessory fitting details" table.

#### Note:

- The front-mounted auxiliary contact blocks provided for the A contactors can be used with the GA and GAE types
- The CAL auxiliary contact blocks can be used with GA contactors:
  - GA75-10-00: 2 x CAL5-11 blocks
  - GA75-10-11: 1 x CAL5-11 block
  - GAE75-10-00: 1 x CAL5-11 block
  - GAE75-10-11: no add-on block.
- The CAL auxiliary contact blocks can be used with UA..RA contactors. See "Accessory fitting details" for this contactor type.

# Auxiliary contact blocks

## Technical data

	<b>Front mounted</b>	<b>Side mounted</b>
<b>Types</b>	1-pole CA5, 1-pole CC5, 4-pole CA5	CAL5-11 CAL18-11, CAL18-11B



## Contact utilization characteristics according to IEC

<b>Standards</b>	IEC 60947-5-1 and EN 60947-5-1		
<b>Rated insulation voltage <math>U_i</math></b> acc. to IEC 60947-5-1	690 V		
<b>Rated operational voltage <math>U_e</math> max.</b>	24...690 V AC		
<b>Conventional thermal current <math>I_{th}</math> - <math>\theta \leq 40</math> °C</b>	16 A		
<b><math>I_e</math> / Rated operational current AC-15</b> acc. to IEC 60947-5-1	24-127 V 50/60 Hz	6 A	
	220-240 V 50/60 Hz	4 A	
	380-440 V 50/60 Hz	3 A	
	500-690 V 50/60 Hz	2 A	
<b>Making capacity</b> acc. to IEC 60947-5-1	10 x $I_e$ AC-15		
<b>Breaking capacity</b> acc. to IEC 60947-5-1	10 x $I_e$ AC-15		
<b><math>I_e</math> / Rated operational current DC-13</b> acc. to IEC 60947-5-1	24 V DC	6 A / 144 W	
	48 V DC	2.8 A / 134 W	
	72 V DC	1 A / 72 W	
	110 V DC	0.55 A / 60 W	
	125 V DC	0.55 A / 69 W	
	220 V DC	0.3 A / 66 W	
	250 V DC	0.3 A / 75 W	
<b>Short-circuit protection device</b> gG type fuse	10 A		
<b>Rated short-time withstand current <math>I_{cw}</math></b> $\theta = 40$ °C	for 1.0 s	100 A	
	for 0.1 s	140 A	
<b>Minimum switching capacity</b>			
A40 ... A75 contactors with failure rate acc. to IEC 60947-5-4	17 V / 1 mA	-	
	$\leq 10^{-7}$	-	
A95 ... A110 contactors with failure rate acc. to IEC 60947-5-4	24 V / 50 mA	-	24 V / 50 mA (0.5 million of operating cycles)
	-	-	$\leq 10^{-6}$
<b>Power dissipation per pole at 6 A</b>	0.1 W		
<b>Mechanical durability</b> Number of operating cycles	10 millions (A9 ... A75) 3 millions (A95 ... A110)	10 millions	5 millions (A/AF95 ... A/AF185) 3 millions (A/AF210 ... AF750) 0.5 million (AF1250 ... AF2050)
<b>Electrical durability</b>			
Max. switching frequency	3600 cycles/h		
Number of operating cycles	see "Electrical durability" curves		
Max. switching frequency	AC-15	1200 cycles/h	
	DC-13	900 cycles/h	

## Contact utilization characteristics according to UL / CSA

<b>Standards</b>	UL 508, CSA C22.2 N°14
<b>Max. operational voltage</b>	600 V AC, 250 V DC
<b>Pilot duty</b>	A600, Q300
AC thermal rated current	10 A

## Connecting characteristics

<b>Connection capacity (min. ... max.)</b>			
	Rigid solid	1 x	1...4 mm <sup>2</sup>
		2 x	1...4 mm <sup>2</sup>
	Flexible with ferrule	1 x	0.75...2.5 mm <sup>2</sup>
		2 x	0.75...2.5 mm <sup>2</sup>
	Lugs	L ≤	7.7 mm
		L >	3.7 mm
			8 mm
			3.7 mm
<b>Tightening torque</b>	1 Nm		
<b>Degree of protection</b>	<b>Terminals</b>	IP20	
acc. to IEC 60947-1 / EN 60947-1 and IEC 60529 / EN 60529			
<b>Screw terminals</b>	Delivered in open position, screws of unused terminals must be tightened		
All terminals	M3.5		
<b>Screwdriver type</b>	Flat Ø 5.5 / Pozidriv 2		

# Auxiliary contact blocks for severe industrial environments



CE5-01W

1SBG381011FD301

## Description

The auxiliary contact blocks are used for the operation of auxiliary and control circuits for severe industrial environments.

Types of auxiliary contact blocks for front mounting:

- CE5 1-pole block, instantaneous with N.O. contact or N.C. contact, designed in 2 protection versions:
  - CE5-... D with built-in microswitch IP40, degree of protection (IP20 on terminals)
  - CE5-... W with built-in microswitch IP67, degree of protection (IP20 on terminals).

Types of auxiliary contact blocks for side mounting:

- CEL18 1-pole block with built-in microswitch IP67 degree of protection (IP20 on terminals). Instantaneous N.O. or N.C. contact.

For clipping onto the right- and/or left-hand side of the contactors.

The auxiliary contact blocks are equipped with screw type connecting terminals delivered open, protected against accidental direct contact and bear the corresponding function marking.

5

## Ordering details (1)

For contactors	Number of blocks	Auxiliary contacts	Type	Order code	Pkg qty	Weight (1 pce)
						kg
<b>Front-mounting instantaneous auxiliary contact blocks, 1-pole</b>						
A45, A50, A75.....	1-6	1 - - -	CE5-10D0.1	1SBN010015R1010	1	0.020
AE45, AE50, AE75.....	1-6	- 1 - -	CE5-01D0.1	1SBN010015R1001	1	0.020
TAE45, TAE50, TAE75.....	1-6	1 - - -	CE5-10D2	1SBN010017R1010	1	0.020
AF45, AF50, AF75.....	1-6	- 1 - -	CE5-01D2	1SBN010017R1001	1	0.020
		1 - - -	CE5-10W0.1	1SBN010016R1010	1	0.020
		- 1 - -	CE5-01W0.1	1SBN010016R1001	1	0.020
		1 - - -	CE5-10W2	1SBN010018R1010	1	0.020
		- 1 - -	CE5-01W2	1SBN010018R1001	1	0.020
<b>Side-mounting instantaneous auxiliary contact blocks, 1-pole microswitch auxiliary contact N.O. or N.C.</b>						
UA95, UA110.....	1-2	1 0 - -	CEL18-10	1SFN010716R1010	1	0.050
UA95, UA110.....	1-2	0 1 - -	CEL18-01	1SFN010716R1001	1	0.050

(1) For each contactor type, refer to "Accessory fitting details" table.

**Note:** The front-mounted auxiliary contact blocks provided for the A contactors can be used with the UA, GA and GAE types.

# Auxiliary contact blocks

## Technical data

	Front-mounted		Side-mounted
Types	1-pole CE5-..0.1	1-pole CE5-..2	CEL18-10, CEL18-01



## Contact utilization characteristics according to IEC

Standards	IEC 60947-5-1 and EN 60947-5-1		
Rated insulation voltage $U_i$ acc. to IEC 60947-5-1	250 V		
Rated operational voltage $U_e$ max.	125 V	250 V	125 V
Conventional thermal current $I_{th} - \theta \leq 40^\circ\text{C}$	0.1 A	2 A	0.1 A
$I_e$ / Rated operational current	AC-14	AC-15	AC-14
acc. to IEC 60947-5-1			
	24-127 V 50/60 Hz	2 A	0.1 A
	220-240 V 50/60 Hz	2 A	–
Making capacity acc. to IEC 60947-5-1	6 x $I_e$ AC-14	10 x $I_e$ AC-15	6 x $I_e$ AC-14
Breaking capacity acc. to IEC 60947-5-1	6 x $I_e$ AC-14	10 x $I_e$ AC-15	6 x $I_e$ AC-14
$I_e$ / Rated operational current	DC-12		
acc. to IEC 60947-5-1			
	24 V DC	2 A	0.1 A
	48 V DC	1 A	0.1 A
	72 V DC	0.3 A	0.1 A
	110 V DC	0.2 A	0.1 A
	125 V DC	0.2 A	–
	220 V DC	0.1 A	–
Short-circuit protection device	0.1 A (FF type fuses) (1)	10 A (FF type fuses) (1)	0.1 A (FF type fuses) (1)
Minimum switching capacity			
A40 ... A75 contactors	3 V / 1 mA	17 V / 1 mA	3 V / 1 mA
With failure rate acc. to IEC 60947-5-4	–	$\leq 10^{-7}$	–
A95 ... A110 contactors	3 V / 1 mA	17 V / 1 mA	–
With failure rate acc. to IEC 60947-5-4	–	$\leq 10^{-7}$	–
Mechanical durability	Number of operating cycles	5 millions for CE5-..D0.1 2.5 millions for CE5-..W0.1	5 millions for CE5-..D2 2.5 millions for CE5-..W2 1 million
	Max. switching frequency	3600 cycles/h	1200 cycles/h
Electrical durability	Number of operating cycles	2.5 millions for CE5-..D0.1 0.7 millions for CE5-..W0.1	1 million for CE5-..D2 0.3 millions for CE5-..W2 0.7 millions
	Max. switching frequency	AC-14, AC-15 DC-12	1200 cycles/h 900 cycles/h

## Contact utilization characteristics according to UL / CSA

Standards	UL 508, CSA C22.2 N°14		
Max. operational voltage	125 V AC / 110 V DC	250 V AC / 220 V DC	125 V
Pilot duty			
AC thermal rated current	0.1 A	2 A	0.1 A

## Connecting characteristics

Connection capacity (min. ... max.)			
 Rigid solid	1 x	1...4 mm <sup>2</sup>	
	2 x	1...4 mm <sup>2</sup>	
 Flexible with ferrule	1 x	0.75...2.5 mm <sup>2</sup>	
	2 x	0.75...2.5 mm <sup>2</sup>	
 Bars or lugs	L ≤	7.7 mm	
	I >	3.7 mm	
Connection capacity acc. to UL/CSA	1 or 2 x	AWG 18...14	
Tightening torque		1 Nm	
Degree of protection	Terminals	IP20	
acc. to IEC 60947-1 / EN 60947-1 and IEC 60529 / EN 60529	Microswitches	IP40 for CE5-..D0.1 IP67 for CE5-..W0.1	IP40 for CE5-..D2 IP67 for CE5-..W2
			IP67
Screw terminals		Delivered in open position, screws of unused terminals must be tightened	
All terminals		M3.5	
Screwdriver type		Flat Ø 5.5 / Pozidriv 2	

(1) or HRC fuses for very fast action (6.3 x 32 mm size).

# Auxiliary contacts

## Electrical durability

### Electrical durability for AC-15 utilization category

AC-15 utilization category according to IEC 60947-5-1 / EN 60947-5-1:

- making current:  $10 \times I_e$  with  $\cos \varphi = 0.7$  and  $U_e$
- breaking current:  $I_e$  with  $\cos \varphi = 0.4$  and  $U_e$ .

These curves represent the electrical durability of the built-in or add-on auxiliary contacts, in relation to the breaking current. The curves have been drawn for resistive and inductive loads up to 690 V, 40...60 Hz.

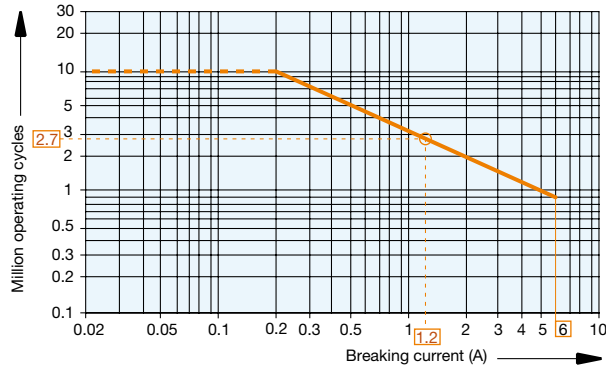

- 1-pole and 4-pole CA5,
- 1-pole CC5,
- 2-pole CAL5 and CAL18 add-on auxiliary contacts.

#### Example:

Breaking current = 1.2 A

On the opposite curve at intersection "O" 1.2 A the corresponding value for the electrical durability is approximately  $2.7 \cdot 10^6$  operating cycles.

### Electrical durability for DC-13 utilization category

DC-13 utilization category according to IEC 60947-5-1 / EN 60947-5-1: making and breaking current =  $I_e$  with  $U_e$  value.

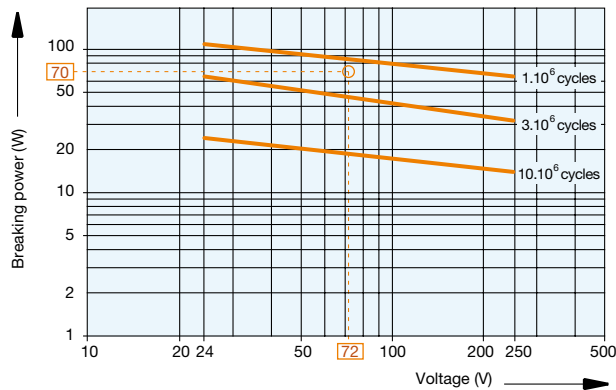

- 1-pole and 4-pole CA5,
- 1-pole CC5,
- 2-pole CAL5 and CAL18 add-on auxiliary contacts.

#### Example:

Control of DC electro-magnet:  $U_e$  voltage = 72 V DC and breaking power = 70 W.

On the opposite curve at intersection "O" 72 V / 70 W the corresponding value for the electrical durability is approximately  $2 \cdot 10^6$  operating cycles.



# Add-on auxiliary contacts

## Terminal marking and positioning

### 1-pole auxiliary contacts

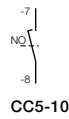
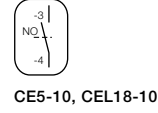
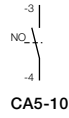
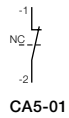

### 2-pole auxiliary contacts

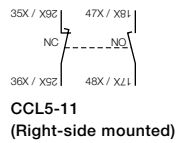
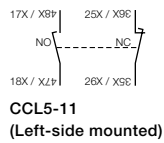
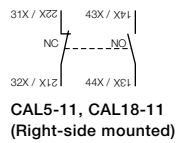
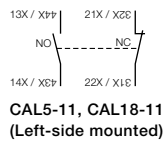

### 4-pole auxiliary contacts

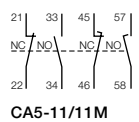
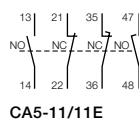
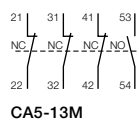
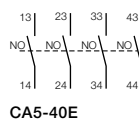
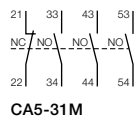
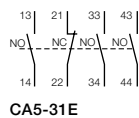
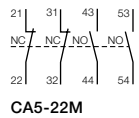
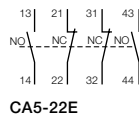
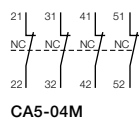
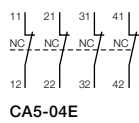

# Electronic timers



TEF5-OFF

1SBC101389FF0014

## Description

TEF5 frontal electronic timers are used for realizing timing function and are available in ON-delay and OFF-delay versions.

### Compact solution in cabinet compared to separate timers

TEF5 electronic timers are front-mounted and locked on contactors. A mechanical indicator allows to show the state of the contactor.

TEF5 electronic timers are supplied by direct wiring to the coil terminals A1 - A2 of the contactor or contactor relay. A varistor is integrated on the timer to offer a built-in protection against surges in the contactor coil.

### Available for a wide control voltage range 24...240 V AC/DC

TEF5-ON or TEF5-OFF allow time-delayed functions up to 100 s in 3 distinct time ranges, independently of the control system. The time delay ranges are selected by a switch and the time delay can be adjusted by means of a rotary switch. The timing function is activated by closing or opening the device on which the timer is mounted. The OFF-delay version operates without additional control supply.



## Ordering details

For contactors, contactor relays	Time delay range selected by switch	Delay type	Rated control circuit voltage $U_c$ V 50/60 Hz or DC	Auxiliary contacts 	Type	Order code	Weight Pkg (1 pce) kg
A45, A50, A75 (T)AE45, (T)AE50, (T)AE75	0.1...1 s 1...10 s 10...100 s	ON-delay	24...240	1 1	TEF5-ON	1SBN020312R1000	0.065
AF45, AF50, AF75		OFF-delay	24...240	1 1	TEF5-OFF	1SBN020314R1000	0.065

# Electronic timers

## Technical data

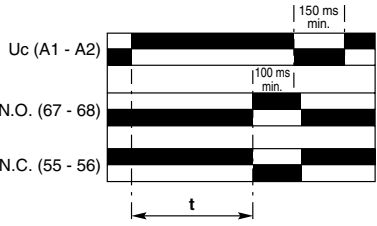
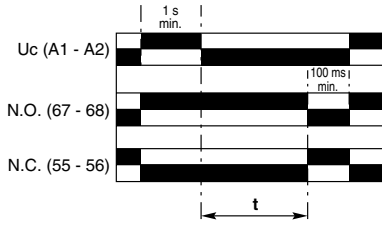
### Contact utilization characteristics according to IEC

Types	TEF5-ON	TEF5-OFF
<b>Standards</b>	IEC 60947-5-1 and EN 60947-5-1	
<b>Rated insulation voltage <math>U_i</math></b> acc. to IEC 60947-5-1	400 V	
<b>Rated impulse withstand voltage <math>U_{imp}</math></b>	4 kV	
<b>Rated operational voltage <math>U_e</math> max.</b>	240 V	
<b>Rated frequency (without derating)</b>	50 / 60 Hz	
<b>Conventional thermal current <math>I_{th} - \theta \leq 40^\circ\text{C}</math></b>	5 A	
<b><math>I_e</math> / Rated operational current AC-15</b> acc. to IEC 60947-5-1	24-127 V 50/60 Hz 220-240 V 50/60 Hz	3 A 1.5 A
<b>Making capacity</b> acc. to IEC 60947-5-1	10 x $I_e$ AC-15	
<b>Breaking capacity</b> acc. to IEC 60947-5-1	10 x $I_e$ AC-15	
<b><math>I_e</math> / Rated operational current DC-13</b> acc. to IEC 60947-5-1	24 V DC	1 A / 24 W
<b>Short-circuit protection device</b> gG type fuse	6 A	
<b>Rated short-time withstand current <math>I_{cw}</math></b> $\theta = 40^\circ\text{C}$	for 1.0 s for 0.1 s	8 A 8 A
<b>Minimum switching capacity</b> with failure rate acc. to IEC 60947-5-4	24 V DC	12 V / 3 mA $10^{-7}$
<b>Power dissipation per pole at 3 A</b>	0.1 W	
<b>Function diagram</b>	ON-delay 	OFF-delay 
	Bistable relay inside. Before use, once apply $U_c$ then switch it off in order to initialize position of the contacts.	
<b>Control circuit voltage</b>		
<b>AC control voltage</b>	Rated control circuit voltage $U_c$ 50/60 Hz	24...240 V AC 1.5 mA RMS
<b>DC control voltage</b>	Rated control circuit voltage $U_c$ Average consumption	24...240 V DC 1.5 mA 1 mA
<b>Rated frequency limits</b>	50 / 60 Hz	
<b>Supply voltage range</b>	0.85...1.1 x $U_c$ (at $\theta \leq 70^\circ\text{C}$ )	
<b>Overvoltage protection</b>	Varistor included	
<b>Time delay range (t) selected by switch</b>	0.1...1 s 1...10 s 10...100 s	
<b>On-load reiteration accuracy under constant conditions</b>	$\leq 1\%$	
<b>Minimum ON period</b>	0.1 s	
<b>Recovery time</b>	0.15 s	
<b>Ambient air temperature</b>	Operation Storage	-25 °C ... +70 °C -40 °C ... +80 °C
<b>Climatic withstand</b>	Category B according to IEC 60947-1 Annex Q	
<b>Maximum operating altitude</b>	2000 m	
<b>Mounting positions</b>	Acc. to mounting positions permitted on contactors or contactor relays With AL, TAL contactors or NL, TNL contactor relays: mounting position 5 not permitted.	
<b>Shock withstand</b> acc. to IEC 60068-2-27 and EN 60068-2-27 (Mounting position 1)	1/2 sinusoidal shock for 11 ms: no change in contact position Same as contactor or contactor relay	
<b>Mechanical durability</b>	Number of operating cycles Max. switching frequency	5 millions operating cycles 3600 cycles/h
<b>Max. electrical switching frequency</b>	AC-15 DC-13	1200 cycles/h 900 cycles/h







# Electronic timers

## Technical data

### Contact utilization characteristics according to UL / CSA

Types	TEF5-ON	TEF5-OFF
<b>Standards</b>	UL 508, CSA C22.2 N°14	
<b>Rated insulation voltage <math>U_i</math></b> acc. to UL / CSA	300 V	
<b>Max. operational voltage</b>	240 V	
<b>Pilot duty</b>	B300, R300	
AC thermal rated current	5 A	
AC maximum volt-ampere making	3600 VA	
AC maximum volt-ampere breaking	360 VA	
DC thermal rated current	1 A	
DC maximum volt-ampere making-breaking	28 VA	

### Connecting characteristics

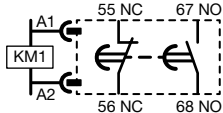
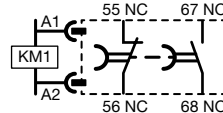
<b>Connection capacity</b> (min. ... max.)		
 Rigid solid	1 x	1...2.5 mm <sup>2</sup>
 Rigid solid	2 x	1...2.5 mm <sup>2</sup>
 Flexible with non insulated ferrule	1 x	0.75...2.5 mm <sup>2</sup>
 Flexible with non insulated ferrule	2 x	0.75...2.5 mm <sup>2</sup>
 Flexible with insulated ferrule	1 x	0.75...2.5 mm <sup>2</sup>
 Flexible with insulated ferrule	2 x	0.75...1.5 mm <sup>2</sup>
 Lugs	L ≤	8 mm
	L >	3.7 mm
<b>Connection capacity acc. to UL / CSA</b>	1 or 2 x	AWG 18...14
<b>Stripping length</b>		10 mm
<b>Tightening torque</b>		1 N.m / 9 lb.in
<b>Degree of protection</b>		IP20
acc. to IEC 60947-1 / EN 60947-1 and IEC 60529 / EN 60529		
<b>Screw terminals</b>		Delivered in open position, screws of unused terminals should be tightened
All terminals		M3.5
<b>Screwdriver type</b>		Flat Ø 5.5 / Pozidriv 2
<b>Terminal Marking</b>		 

# Impulse contact blocks

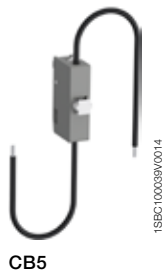

CB5

## Description

Impulse contact blocks are designed for use in enclosures, in association with an adjustable mechanical pushbutton.

- CB5-10: N.O. contact with a black actuator ("ON" function)
- CB5-01: N.C. contact with a light grey actuator ("OFF" function).

These blocks are equipped with 2 connecting leads 0.5 mm<sup>2</sup> with end, approximately 18 cm long.

Mounting: Clipped onto the front face of the contactors.

## Ordering details

For contactors	Contacts	Type	Order code	Pkg qty	Weight (1 pce) kg	
A45, A50, A75	1	-	CB5-10	1SBN010013R1010	1	0.012
(T)AE45, (T)AE50, (T)AE75 AF45, AF50, AF75	-	1	CB5-01	1SBN010013R1001	1	0.012

## Main dimensions mm, inches

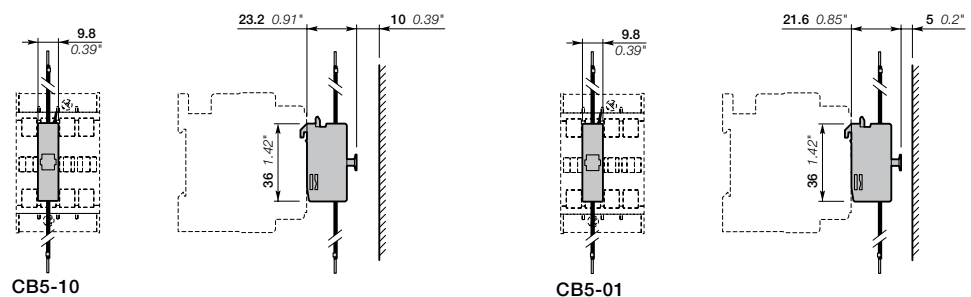

# Mechanical and electrical interlock units



VE5-2

1SBC101428F0014

## Description

When mounted between two contactors, the mechanical interlock unit prevents one of the contactors from closing as long as the other contactor is closed.

VE interlock units are used for mechanical and electrical interlocking of two AC or DC operated contactors mounted side by side.

## Ordering details

For contactors	Mounting	Type	Order code	Pkg qty	Weight (1 pce) kg
<b>Mechanical and electrical interlock units for two horizontal mounted contactors</b>					
A45, A50, A75 (T)AE45, (T)AE50, (T)AE75 AF45, AF50, AF75	Rail mounting	VE5-2	1SBN030210R1000	1	0.146

The interlock units can be used with GA and GAE types.

# Mechanical and electrical interlock units

## Technical data

Types	VE5-2
-------	-------



### Contact utilization characteristics according to IEC

Standards	IEC 60947-5-1 and EN 60947-5-1	
Rated insulation voltage $U_i$ acc. to IEC 60947-5-1	690 V	
Rated operational voltage $U_e$ max.	24...690 V	
Conventional thermal current $I_{th}$ - $\theta \leq 40^\circ\text{C}$	16 A	
$I_e$ / Rated operational current AC-15 acc. to IEC 60947-5-1	24-127 V 50/60 Hz	6 A
	220-240 V 50/60 Hz	4 A
	380-440 V 50/60 Hz	3 A
	500-690 V 50/60 Hz	2 A
	Making capacity acc. to IEC 60947-5-1	10 x $I_e$ AC-15
Breaking capacity acc. to IEC 60947-5-1	10 x $I_e$ AC-15	
$I_e$ / Rated operational current DC-13 acc. to IEC 60947-5-1	24 V DC	6 A
	48 V DC	2.8 A
	72 V DC	1 A
	125 V DC	0.55 A
	250 V DC	0.3 A
Short-circuit protection device - gG type fuse	10 A	
Rated short-time withstand current $I_{cw}$ $\theta = 40^\circ\text{C}$	for 1.0 s	100 A
	for 0.1 s	140 A
Power dissipation per pole at 6 A	0.15 W	
Mechanical durability	5 millions operating cycles	
Number of operating cycles	600 cycles/h	
Max. switching frequency	600 cycles/h	

### Utilization characteristics according to UL/CSA

Standards	UL 508, CSA C22.2 N°14
Max. operational voltage	600 V

### Connecting characteristics

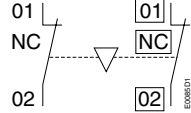
Connection capacity (min. ... max.)	
 Rigid solid	1 x 1...4 mm <sup>2</sup> 2 x 1...4 mm <sup>2</sup>
 Flexible with ferrule	1 x 0.75...2.5 mm <sup>2</sup> 2 x 0.75...2.5 mm <sup>2</sup>
 Lugs	L < 8 mm l > 3.5 mm
Tightening torque	
Recommended	1 Nm
Max.	1.2 Nm
Degree of protection acc. to IEC 60947-1 / EN 60947-1 and IEC 60529 / EN 60529	
IP20	
Screw terminals All terminals	
delivered in open position, screws of unused terminals must be tightened M3.5	
Screwdriver type	
Flat Ø 5.5 / Pozidriv 2	
Terminal marking	
	

Technical note: when, during switching, the arc time is estimated to more than 40 ms, the closing signal of one of the two contactors must be delayed with respect to the opening signal of the other contactor in order to prevent a short-circuit.

Use a TEF5 electronic timer according to application use with time lapse for A and (T)AE contactors.

# CA5, CE5, CAL5 and TEF5 fitting details

Many configurations are possible depending on whether these are front-mounted or side-mounted.

Contactor types	Main poles	Built-in auxiliary contacts	Front-mounted accessories			Side-mounted accessories	
			Auxiliary contact blocks	Electronic timer	Auxiliary contact blocks	Interlock unit	
			1-pole CA5 1-pole CE5	4-pole CA5	TEF5	2-pole CAL5	VE5-2
<b>4-pole contactors</b>							
A45, A50, A75 AF45, AF50, AF75	4 0 0 0	0 0	1 to 6 x CA5 1 to 5 x CE5 max. (2)	or 1 x 4-pole CA5 + 2 x 1-pole CA5 or CE5 (2)	or 1 x TEF5 + 2 x 1-pole CA5	+	1 to 2 x CAL5-11 or 1 x VE5-2 + 1 x CAL5-11
	2 2	0 0 (1)	1 to 6 x CA5 no CE5	or 1 x 4-pole CA5 + 2 x 1-pole CA5 no CE5	or 1 x TEF5 + 2 x 1-pole CA5	+	1 to 2 x CAL5-11 -
AE45, AE50, AE75	4 0 0 0	0 0	1 to 6 x CA5 1 to 5 x CE5 max. (2)	or 1 x 4-pole CA5 + 2 x 1-pole CA5 or CE5 (2)	or 1 x TEF5 + 2 x 1-pole CA5	+	1 x CAL5-11 or 1 x VE5-2
	2 2	0 0 (1)	1 to 6 x CA5 no CE5	or 1 x 4-pole CA5 + 2 x 1-pole CA5 no CE5	or 1 x TEF5 + 2 x 1-pole CA5	+	1 x CAL5-11 -
TAE45, TAE50, TAE75	4 0 0 0	0 0	1 to 6 x CA5 1 to 5 x CE5 max. (2)	or 1 x 4-pole CA5 + 2 x 1-pole CA5 or CE5 (2)	or 1 x TEF5 + 2 x 1-pole CA5	+	1 x CAL5-11 or 1 x VE5-2

(1) 2 x N.C. CA5 auxiliary contacts maximum.

Note: regarding combination of CE5 with other accessories:

(2) The total number of N.O. or N.C. CE5 and other additional N.C. CA5 auxiliary contacts is limited to 5.



# Function markers

## Mounting piece



BA5-50

1SBC575874FC001

### BA5-50 Function markers

#### Description

Set of 50 function markers designed to be clipped onto the front face of devices. Details can be added to these markers using a ball point pen, indelible felt-tip pen or pentel white.

Self-adhesive labels (not supplied) can also be added to them.

Marker dimensions: 7 x 19 mm (0.276" x 0.748").

#### Ordering details

For contactors	Type	Order code	Pkg qty	Weight (1 pce) kg
A45, A50, A75 (T)AE45, (T)AE50, (T)AE75 AF45, AF50, AF75 UA, UA..RA and accessories	BA5-50	1SBN110000R1000	1	0.017

5



BP16

1SBC586724FC002

### BP16 Mounting piece

#### Description

Mounting piece for screw fixing (M4, not supplied) of UA, UA..RA series contactors indicated in the table below.

Easy handling of screwdrivers and screw driving.

Add-on mounting piece on contactor's rear face, offering a wide fixing facility.

#### Ordering details

For contactors	Type	Order code	Pkg qty	Weight (1 pce) kg
UA16, UA16..RA	BP16	1SBN111403R1000	100	0.141

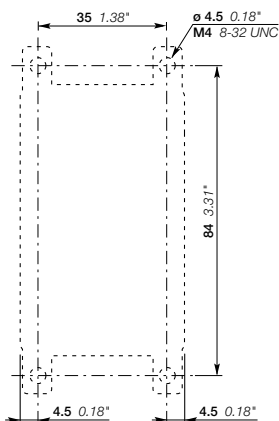

Drilling plan for UA16, UA16..RA contactors with BP16

1SBC101531S0201 - Rev. A

# Surge suppressors for contactor coils

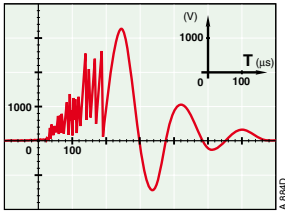

## Description

The operation of inductive circuits causes overvoltages, in particular on opening of the contactor coil. The electromagnetic energy stored in the coil during contactor closing is restored on opening in the form of surges, the slope and amplitude of which may rise to several kilovolts. A number of drawbacks are observed ranging from interference on the electronic devices to breakdown of insulators and even destruction of certain sensitive components.

The graph opposite reproduces the oscillogram showing voltage discharges at the terminals of a 42 V / 50 Hz coil without peak clipping. The coil was switched by 8 series-connected poles of a contactor relay.

Following a burst of discharges with a very steep slope a damped oscillation emerges with a peak value of 3500 V.

### Overvoltage Factor

The overvoltage factor  $k$  is defined as the ratio of the maximum overvoltage peak value  $\hat{U}_s$  to the peak value  $\hat{U}_c$  of the coil rated control voltage  $U_c$ :

$$k = \frac{\hat{U}_s \text{ max.}}{\hat{U}_c} \quad \text{in DC: } k = \frac{\hat{U}_s \text{ max.}}{U_c} \quad \text{or in AC: } k = \frac{\hat{U}_s \text{ max.}}{U_c \sqrt{2}}$$

For example the following is obtained for the above graph:  $k = \frac{3500}{42 \sqrt{2}} \approx 60$

To reduce the harmful effects of these overvoltages, ABB has developed a range of surge suppressors designed to reduce the  $k$  factor defined above and to limit or even completely eliminate the high pre-damping voltage frequencies.

Each case is different, but the technical data tolerances and the generous sizing of parts have enabled us to reduce the number of variants.

We have chosen the following solutions: transil diodes, varistors and RC blocks.

Note: A varistor is a resistor whose value decreases to a very large extent when a certain voltage is applied at its terminals.

## Ordering details

For contactors	Rated control circuit voltage $U_c$			Type	Order code	Pkg qty	Weight (1 pce) kg
	V	AC	DC				
A45, A50, A75 AE45, AE50, AE75 TAE45, TAE50, TAE75	24...50	●	●	RV5/50	1SBN050010R1000	2	0.015
	50...133	●	●	RV5/133	1SBN050010R1001	2	0.015
	110...250	●	●	RV5/250	1SBN050010R1002	2	0.015
	250...440	●	●	RV5/440	1SBN050010R1003	2	0.015
A45, A50, A75	24...50	●	-	RC5-2/50	1SBN050200R1000	2	0.015
	50...133	●	-	RC5-2/133	1SBN050200R1001	2	0.015
	110...250	●	-	RC5-2/250	1SBN050200R1002	2	0.015
	250...440	●	-	RC5-2/440	1SBN050200R1003	2	0.015
AE45, AE50, AE75 TAE45, TAE50, TAE75	12...32	-	●	RT5/32	1SBN050020R1000	2	0.015
	25...65	-	●	RT5/65	1SBN050020R1001	2	0.015
	50...90	-	●	RT5/90	1SBN050020R1002	2	0.015
	77...150	-	●	RT5/150	1SBN050020R1003	2	0.015
	150...264	-	●	RT5/264	1SBN050020R1004	2	0.015

Note: The surge suppressors provided for A contactors can be used with the UA, UA..RA and GA75 types.  
The surge suppressors provided for AE45 ... AE75 contactors can be used with the GAE75 types.

5



RV5/50

1SBC574001FC001



RC5-1/50

1SBC573891FC001

# Surge suppressors for contactor coils

## Technical data

Varistor	RV5/50	RV5/133	RV5/250	RV5/440
Rated control circuit voltage $U_c$	24...50 V AC 24...50 V DC	50...133 V AC 50...133 V DC	110...250 V AC 110...250 V DC	250...440 V AC 250...440 V DC
Residual overvoltage (clipping voltage)	132 V AC 132 V DC	270 V AC 270 V DC	480 V AC 480 V DC	825 V AC 825 V DC
Opening time growth factor	1.1...1.5			
Operating temperature	-20...+70 °C			
Connection to the coil terminals (parallel mounting)	Clip-on for both fixing and connection.			
Fixing	Clipped onto the top part of the contactor base without change in contactor overall dimensions.			
Advantages	High energy absorption: good damping - Unpolarized system.			
Drawback	Clipping as from Uvdr*, thus voltage front up to this point. *Uvdr = Varistor operating voltage (voltage dependent resistor), tolerance $\pm 10\%$ .			

RC type	RC5-2/50	RC5-2/133	RC5-2/250	RC5-2/440
Rated control circuit voltage $U_c$	24...50 V AC	50...133 V AC	110...250 V AC	250...440 V AC
Residual overvoltage (clipping voltage)	2 to 3 x $U_c$ max.			
Opening time growth factor	1.2...1.3			
Operating temperature	-20...+70 °C			
Connection to the coil terminals (parallel mounting)	Clip-on for both fixing and connection.			
Fixing	Clipped onto the top part of the contactor base without change in contactor overall dimensions.			
Advantages	Very fast clipping - Attenuation of steep fronts and thus of high frequencies. No operating delays.			

Transil diode	RT5/32	RT5/65	RT5/90	RT5/150	RT5/264
Rated control circuit voltage $U_c$	12...32 V DC	25...65 V DC	50...90 V DC	77...150 V DC	150...264 V DC
Residual overvoltage (clipping voltage)	50 V DC	100 V DC	150 V DC	210 V DC	390 V DC
Opening time growth factor	1.5...3				
Operating temperature	-20...+70 °C				
Connection to the coil terminals (parallel mounting)	Clip-on for both fixing and connection.				
Fixing	Clipped onto the top part of the contactor base without change in contactor overall dimensions.				
Advantages	Good energy absorption - Unpolarized system - Simple, reliable system.				
Drawback	A certain delay on drop out which does not however reduce contactor breaking capacity.				

## Wiring diagrams

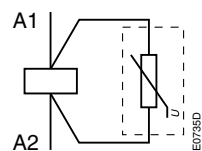

Varistor

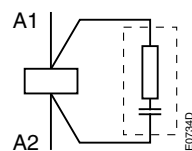

RC type

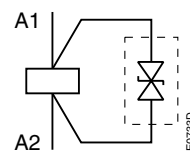

Transil diode

## Dimensions

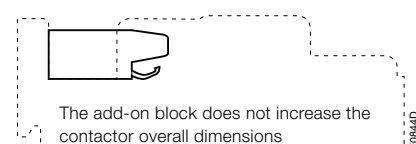

RV5, RC5, RT5

# Interface relays



RA5-1

## Description

RA5-1 interface relay is designed to receive 24 V DC signals delivered by PLC's or other sources with a low output power and to restore them with sufficient power to operate the coils of the relevant A45, A50 and A75 contactors.

RA5-1 interface relay is made up of a miniature electromechanical relay equipped with a N.O. contact and with a low consumption 24 V DC coil.

The interface relay coil is controlled by the PLC while the N.O. contact ensures switching of the power contactor.

Coil switching gives rise to overvoltages which have adverse effects on the electronic devices, insulators and, more generally, on component lifetime. The RA5-1 is equipped with surge suppressors:

- on the 24 V DC relay coil via a diode,
- on the power contactor coil via a varistor.

Furthermore, the RA5-1 is protected against relay pole reversal by a diode inserted between the E1 and E2 input terminals.

## Ordering details

For contactors	Coil voltages	Rated control circuit voltage U <sub>c</sub>	Type	Order code	Pkg qty	Weight (1 pce)
	V 50/60 Hz	V DC				kg
A45, A50, A75	24...250	24	RA5-1	1SBN060300R1000	1	0.050
			RA5-1	1SBN060300T1000	10	0.050

Note: The interface relays provided for the A... contactors can be used for the UA, UA..RA and GA types.

# Interface relays



## Technical data

Type	RA5-1
------	-------

## Utilization characteristics according to IEC

Standards	IEC 60255-5
Rated insulation voltage $U_i$ acc. to IEC 60947-4-1	250 V AC
Ambient air temperature	
In free air operation	at $U_c = 24$ V DC (between E1 and E2) $-25...+70$ °C
Storage	from $0.85$ to $1.1 \times U_c$ $-25...+55$ °C
Storage	$-40...+70$ °C
Climatic withstand	Complies with that of associated contactors
Maximum operating altitude	3000 m
Mounting positions	No limitation
Fixing	Using the contactor A1 and A2 terminal connecting parts

## Connecting characteristics

Connection capacity (min. ... max.)	
 Rigid solid	1 x 1...4 mm <sup>2</sup> 2 x 1...4 mm <sup>2</sup>
 Flexible with ferrule	1 x 0.75...2.5 mm <sup>2</sup> 2 x 0.75...2.5 mm <sup>2</sup>
 Lugs	L < 8 mm l > 3.5 mm
Tightening torque	
Recommended	1 Nm
Max.	1.2 Nm
Degree of protection	Protection against direct contact in acc. with EN 50274
acc. to IEC 60947-1 / EN 60947-1 and IEC 60529 / EN 60529	RA5-1 wired and mounted on the associated contactor
Screw terminals	Delivered in open position, screws of unused terminals must be tightened
All terminals	M3.5
Screwdriver type	Flat Ø 5.5 / Pozidriv 2

## Working data

Surge suppression	
For contactor coil	Varistor
For interface relay coil	Diode
Protection against polarity reversal between terminals E1 and E2	Diode
Interface relay operating time	Closing and drop-out $\leq 10$ ms
Total operating time, interface relay + contactor	
Between energization and:	
N.O. contact closing	20...37 ms
N.C. contact opening	17...32 ms
Between de-energization and:	
N.O. contact opening	17...25 ms
N.C. contact closing	20...28 ms

## Electrical input data

Control voltage (E1 and E2 terminals) $U_c$	
Rated value	24 V DC
Max. range at ambient temperature 20 °C	19...30 V DC
Max. consumption for $U_c = 24$ V DC, $\theta = 20$ °C	0.3 W
"0" status (relay open)	for $U_c \leq 2.4$ V DC for $I_c < 1$ mA
"1" status (relay closed)	for $U_c \geq 19$ V DC
Max. short supply interruption immunity time	2 ms

## Electrical output data

Switching voltage (A0 and A2 terminals)	$\leq 250$ V AC
Electrical durability	
Number of operating cycles	2 millions (600 cycles/h) on A40 ... A75 contactors 0.5 million (600 cycles/h) on A95 and A110 contactors

## Connection

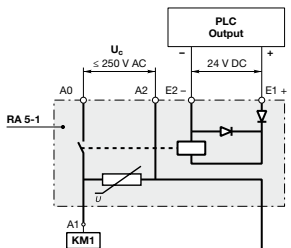
	<p>The "E1+" and "E2-" input terminals must be connected, according to their polarity, to the PLC output.</p> <p>The RA5-1 is equipped with two terminal pads for connection to the A1 and the A2 terminals of the contactor coil.</p> <p>This coil is supplied between the A0 and the A2 terminals of the RA 5-1.</p> <p>Mounting: terminals pads clamped inside the contactor coil terminals.</p>
---	---

# Mechanical latching units



1SBC101526S0201

WB75-A

## Description

For converting standard contactors into latched contactors.

The WB75-A block contains a mechanical latching device with electromagnetic impulse unlatching (AC or DC) or manual unlatching.

Captive screw type connecting terminals, built-in cable clamps, M3.5 (+,-) pozidriv 2 screw with screw-driver guidance; delivered untightened and protected against accidental direct contact.

## Operation

After closing, the contactor continues to be held in the closed position by the latching mechanism should the supply voltage fail at the contactor coil terminals.

Contactor opening can be controlled:

- electrically by an impulse (AC or DC) on the WB75-A block coil.  
(the coil is not designed to be permanently energized)
- manually by pressing the pushbutton on the front face of the WB75-A block.

## Mounting

The WB75-A block is clipped onto the front face of the 1-stack contactor where it takes up two slots. The two other slots may accept CA5... single pole auxiliary contacts (1 block on each side of the mechanical latch).

5

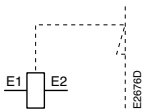

Terminal marking

## Ordering details

For contactors	Rated control circuit voltage Uc		Type	Order code	Pkg qty	Weight (1 pce)
	V 50 Hz or DC	V 60 Hz				
A45, A50, A75,	24	24...28	WB75-A	FPTN372726R1001	1	0.120
AE45, AE50, AE75,	42	42...48	WB75-A	FPTN372726R1002	1	0.120
TAE45, TAE50, TAE75,	48	48...55	WB75-A	FPTN372726R1003	1	0.120
AF45, AF50, AF75,	110	110...127	WB75-A	FPTN372726R1004	1	0.120
UA16 ... UA75,	220...230	220...255	WB75-A	FPTN372726R1006	1	0.120
GA75, GAE75	230...240	230...277	WB75-A	FPTN372726R1005	1	0.120
	380...415	380...440	WB75-A	FPTN372726R1007	1	0.120
	415...440	440...480	WB75-A	FPTN372726R1008	1	0.120

# Mechanical latching units





## Technical data

Type	WB75-A
------	--------

## Utilization characteristics according to IEC

Rated insulation voltage $U_i$ acc. to IEC 60947-1	690 V
<b>Max. electrical impulse time</b>	
On AC coil (with load factor 5 %)	20 s
On DC coil (with load factor 3 %)	8 s
<b>Min. electrical impulse time</b>	
For latching (energizing of the contactor coil)	<b>AC</b> 50 ms (A, UA, GA contactors) <b>DC</b> 50 ms (AE, TAE, GAE contactors)
For pull-out (energizing of the WB block coil)	<b>AC</b> 30 ms (A, UA, GA contactors) <b>DC</b> 50 ms (AE, TAE, GAE contactors)
<b>Coil operating limits</b>	<b>AC or DC supply</b> 0.85...1.1 x $U_c$
<b>AC control voltage</b> 50/60 Hz	
Rated control circuit voltage $U_c$	24...480 V AC
Coil consumption	<b>Average pull-in value</b> 90 VA <b>Average holding value</b> 60 VA
<b>DC control voltage</b>	
Rated control circuit voltage $U_c$	24...440 V DC
Coil consumption	<b>Average pull-in value</b> 110 W <b>Average holding value</b> 110 W
<b>Operating time</b>	
On contactor closing (latching)	
Between coil energization and:	<b>N.O. contact closing</b> No difference with the operation of a contactor without mechanical latching unit <b>N.C. contact opening</b> No difference with the operation of a contactor without mechanical latching unit
On contactor opening (unlatching)	
Between WB coil energization and:	<b>N.O. contact opening</b> 5...25 ms <b>N.C. contact closing</b> 7...28 ms
<b>Mechanical durability</b>	<b>Number of operating cycles</b> 1 million operating cycles
<b>Max. switching frequency</b>	3600 cycles/h with on-load factor of 8 %

## Connecting characteristics

<b>Connection capacity</b> (min. ... max.)		
 Rigid solid	<b>1 x</b>	1...4 mm <sup>2</sup>
 Flexible with ferrule	<b>2 x</b>	1...4 mm <sup>2</sup>
 Flexible with ferrule	<b>1 x</b>	0.75...2.5 mm <sup>2</sup>
 Flexible with ferrule	<b>2 x</b>	0.75...2.5 mm <sup>2</sup>
 Lugs	<b>L &lt;</b>	8 mm
	<b>I &gt;</b>	3.5 mm
<b>Tightening torque</b>		
Recommended		1 Nm
Max.		1.2 Nm
<b>Screw terminals</b>		Delivered in open position, screws of unused terminals must be tightened
All terminals		M3.5
<b>Screwdriver type</b>		Flat Ø 5.5 / Pozidriv 2

# Additional terminal blocks



LD75

1SBC0960742FC001

## Description

The LD terminal blocks are designed to increase the connecting capacity of the contactor on which they are fitted and for preparation of the wiring before final connection on the contactor.

The LD blocks are 3-pole terminal blocks with tunnel terminals. The available range can be used on A45, A50 and A75 contactors.





The LD75 terminal blocks are fixed in the 3 independent slots located above the built-in connectors.

## Ordering details

For contactors	Type	Order code	Pkg qty	Weight (1 pce) kg
A45, A50, A75 (T)AE45, (T)AE50, (T)AE75 AF45, AF50, AF75	LD75	1SBN073508R1000	1	0.115

Note: The LD terminal blocks provided for the A contactors can be used with the UA types.

## Technical data

Types	LD75
<b>Rated insulation voltage <math>U_i</math></b> acc. to IEC 60947-4-1 acc. to UL / CSA	690 V 600 V
<b>Main terminals</b>	 Screw terminals with single connector 10x11 mm
<b>Connection capacity (min. ... max.)</b>	
 Rigid Solid ( $\leq 4 \text{ mm}^2$ ) } <b>1 x</b> 6...50 mm <sup>2</sup>	
 Stranded ( $\geq 6 \text{ mm}^2$ ) } <b>2 x</b> 6...25 mm <sup>2</sup>	
 Flexible with ferrule <b>1 x</b> 6...35 mm <sup>2</sup>	
 Flexible with ferrule <b>2 x</b> 6...16 mm <sup>2</sup>	
Bars	10 mm
Tightening torque	4 Nm
<b>Degree of protection</b> acc. to IEC 60947-1 / EN 60947-1 and IEC 60529 / EN 60529	IP10
<b>Screw terminals</b>	Delivered in closed position M6
<b>Screwdriver type</b>	pozidriv 2

Note: The utilization of LD additional terminal blocks leaves the possibility to connect the following cables directly into the contactor main terminals.

	LD75
Possible cross section of rigid cable in the contactor terminals	50 mm <sup>2</sup>



# Terminals for control lead connections



LK75-L



LK75-F

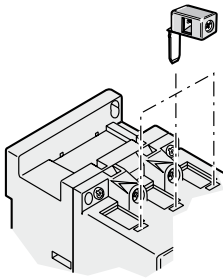

LK positioning

## Description

Terminals designed to connect the control conductors to the main poles of the A45, A50 and A75 contactors and derivative versions.

Accessories clipped into the slots placed above each power terminal connector.

The LK75 are fitted with a pin designed to hold them in place until the connector has been fully clamped with its power cable.

- Degree of protection IP20
- Connecting terminal delivered in open position: cable clamp and M3.5 (+, -) pozidriv 2 screw.
- Cable cross-sectional area:
  - 1 or 2 rigid conductors ..... 1...4 mm<sup>2</sup>
  - 1 or 2 flexible conductors with cable end ..... 0.75...2.5 mm<sup>2</sup>
- Tightening torque for the LK screw:
  - recommended ..... 1.00 Nm
  - maxi ..... 1.20 Nm

## Ordering details

For contactors	Type	Order code	Pkg qty	Weight (1 pce) kg
Right and left on: A45, A50, A75 (T)AE45, (T)AE50, (T)AE75 AF45, AF50, AF75	LK75-L	1SBN073552R1003	2	0.006
Opposite on: A45, A50, A75 (T)AE45, (T)AE50, (T)AE75 AF45, AF50, AF75	LK75-F	1SBN073552R1002	2	0.006

Note: The LK terminals provided for the A contactors can be used with the AM, UA, GA and GAE types.

## Main dimensions mm, inches

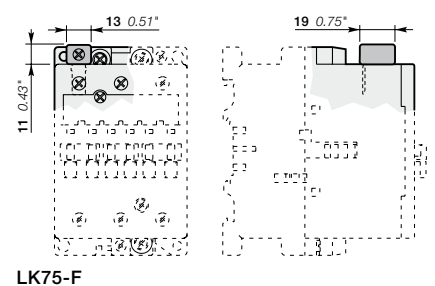
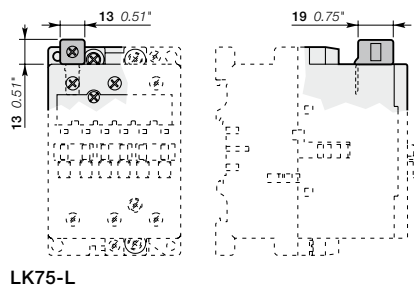

# Other accessories



1SFT19600-011C3

LW

## Terminal enlargements

### Description

Enlargement pieces designed to increase the width of the contactor terminal pads in order to allow larger connections to be mounted.

Sets containing 3 tin plated copper bars fixed by an isolating spacer.

### Ordering details

For contactors	Dimensions		Type	Order code	Pkg qty	Weight (1 pce)
	hole Ø mm	bar mm				
UA95, UA110	6.5	15 x 3	LW110	1SFN074307R1000	1	0.100

5



SB7170C3\_1

LH



SB7170C3\_2

LF

## Terminal connecting strips and shorting bars

### Description

Parallel and series connection of 4-pole contactor poles:

- To connect poles in parallel and thus increase the AC load passing through the flow path made up of the parallel-connected poles: LH (2 poles); LF (3 poles).

For the maximum permissible current values with parallel-connected poles see "Parallel connection of main poles".

The relevant cable cross-sectional area may limit the maximum permissible current. Consult the information in the table below

- To connect poles in series and thus increase the DC load controlled by the poles: LH.

Types	for connection of "n" poles	with terminal	insulated
LH	n = 2	yes	no
LF	n = 3	yes	no

### Ordering details

For contactors	max. nominal continuous current with "n" poles A	Cable cross-sectional area mm <sup>2</sup>	Type	Order code	Pkg qty	Weight (1 pce) kg
A45, A50, A75 (T)AE45, (T)AE50, (T)AE75 AF45, AF50, AF75	200	95	LH75	FPTN472734R0001	2	0.085
A45, A50, A75 (T)AE45, (T)AE50, (T)AE75 AF45, AF50, AF75	275	150	LF75	FPTN472735R0001	2	0.095

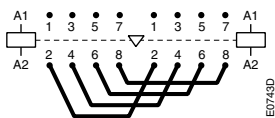

E0743D

BES  
Changeover connections

## Connection sets

### Description

Connection between the main poles of two 4-pole contactors mounted side by side so that they operate as source reversing contactors.

These sets are made up of four downstream connections, with insulated, stranded, rigid copper cables.

### Ordering details

For 4-pole contactors	Type	Order code	Pkg qty	Weight (1 pce) kg
A45, A50, A75 (T)AE45, (T)AE50, (T)AE75 AF45, AF50, AF75	BES75-40	1SBN083302R1000	1	0.400

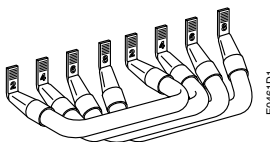

E0A61D1

BES75-40

# Contactors coils and main contact sets



ZA16

1SBC573862F0302

## Contactors coils

### Ordering details

For contactors	Rated control circuit voltage		Type	Order code	Pkg qty	Weight (1 pce) kg
	Uc min. ... Uc max.					
	V 50/60 Hz	V DC				
AF45, AF50, AF75	-	20...60	ZAF75	1SBN153570R7206	1	0.170
	48...130	48...130	ZAF75	1SBN153570R6906	1	0.170
	100...250	100...250	ZAF75	1SBN153570R7006	1	0.170

For contactors	Rated control circuit voltage		Type	Order code	Pkg qty	Weight (1 pce) kg
	Uc					
	V 50 Hz	V 60 Hz				
UA16, UA16..RA	24	24	ZA16	1SBN151410R8106	1	0.093
	48	48	ZA16	1SBN151410R8306	1	0.093
	110	110...120	ZA16	1SBN151410R8406	1	0.093
	220...230	230...240	ZA16	1SBN151410R8006	1	0.093
	230...240	240...260	ZA16	1SBN151410R8806	1	0.093
	380...400	400...415	ZA16	1SBN151410R8506	1	0.093
	400...415	415...440	ZA16	1SBN151410R8606	1	0.093
UA26, UA30, UA26..RA, UA30..RA	24	24	ZA40	1SBN152410R8106	1	0.148
	48	48	ZA40	1SBN152410R8306	1	0.148
	110	110...120	ZA40	1SBN152410R8406	1	0.148
	220...230	230...240	ZA40	1SBN152410R8006	1	0.148
	230...240	240...260	ZA40	1SBN152410R8806	1	0.148
	380...400	400...415	ZA40	1SBN152410R8506	1	0.148
	400...415	415...440	ZA40	1SBN152410R8606	1	0.148
UA50 ... UA75 UA50..RA ... UA75..RA GA75	24	24	ZA75	1SBN153510R8106	1	0.166
	48	48	ZA75	1SBN153510R8306	1	0.166
	110	110...120	ZA75	1SBN153510R8406	1	0.166
	220...230	230...240	ZA75	1SBN153510R8006	1	0.166
	230...240	240...260	ZA75	1SBN153510R8806	1	0.166
	380...400	400...415	ZA75	1SBN153510R8506	1	0.166
	400...415	415...440	ZA75	1SBN153510R8606	1	0.166
UA95, UA110 UA95..RA, UA110..RA	24	24	ZA110	1SFN154310R8106	1	0.170
	48	48	ZA110	1SFN154310R8306	1	0.170
	110	110...120	ZA110	1SFN154310R8406	1	0.170
	220...230	230...240	ZA110	1SFN154310R8006	1	0.170
	230...240	240...260	ZA110	1SFN154310R8806	1	0.170
	380...400	400...415	ZA110	1SFN154310R8506	1	0.170
	400...415	415...440	ZA110	1SFN154310R8606	1	0.170

5

## Main contact sets

### Description

The contact sets for 3-pole contactors consists of six fixed contacts, three moving contacts, springs and the required screws.

### Ordering details

For contactors	Type	Order code	Pkg qty	Weight (1 pce) kg
UA50	ZLU50	1SBN163502R1000	1	0.115
UA63	ZLU63	1SBN163702R1000	1	0.145
UA75	ZLU75	1SBN164102R1000	1	0.145
UA95	ZLU95	1SFN164302R1000	1	0.190
UA110	ZLU110	1SFN164502R1000	1	0.190

1SFC101143C0201



## Accessories for EK100 ... EK1000 contactors

Auxiliary contact blocks	5/254
Mechanical interlock units	5/258
Mechanical and electrical interlock units	5/258
Surge suppressors for contactor coils	5/260
Terminal shrouds and connection sets	5/262
Mounting plates	5/263
Main contact sets - Arc chutes	5/264
Contactor coils	5/265

# Auxiliary contact blocks

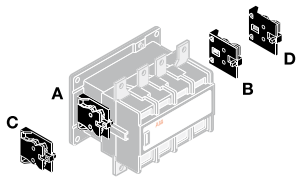

Mounting positions of the CAL16-11

E2074D

## Description

The auxiliary contact blocks are used for the operation of auxiliary circuits and control circuits.

Types of auxiliary contact blocks for standard industrial environments:

- CAL instantaneous with N.O. + N.C. contacts
- CCL N.O. leading contact + N.C. lagging contact.

The auxiliary contact blocks are equipped with screw type connecting terminals delivered open, protected against accidental direct contact, and bear the corresponding function marking.

Mounting: Screwed onto the right and / or lefthand side of the EK110 ... EK1000 contactors.

## Ordering details

For contactors	Number of blocks	Auxiliary contacts	Type	Order code	Pkg qty	Weight (1 pce)
						kg

### 2-pole auxiliary contacts N.O. + N.C.

EK	1	1 1 - -	CAL16-11A	SK829002-A	1	0.050
	1	1 1 - -	CAL16-11B	SK829002-B	1	0.050
	1	1 1 - -	CAL16-11C	SK829002-C	1	0.050
	1	1 1 - -	CAL16-11D	SK829002-D	1	0.050
	1	1 - - 1	CCL16-11E (1)	SK829002-E	1	0.050

(1) Mounting of CCL16-11E blocks does not allow an additional second block to be added on top of it.  
All DC operated EK... contactors are equipped with one CCL16-11E on the right side.

# Auxiliary contact blocks

## Technical data

Types	2-pole CAL 16-11, 2-pole CCL 16-11
-------	------------------------------------

### Contact utilization characteristics according to IEC







Standards	IEC 60947-5-1 and EN 60947-5-1	
Rated insulation voltage $U_i$ acc. to IEC 60947-5-1	690 V	
Rated operational voltage $U_e$ max.	24...690 V	
Conventional thermal current $I_{th}$ - $\theta \leq 40$ °C	10 A	
Rated frequency (without derating)	50/60 Hz	
le / Rated operational current AC-15		
acc. to IEC 60947-5-1	24-127 V	6 A
	220-240 V	6 A
	380-440 V	4 A
	500-690 V	1 A
Making capacity acc. to IEC 60947-5-1	10 x $I_e$ AC-15	
Breaking capacity acc. to IEC 60947-5-1	10 x $I_e$ AC-15	
le / Rated operational current DC-13		
acc. to IEC 60947-5-1	24 V DC	6 A
	48 V DC	6 A
	72 V DC	4 A
	125 V DC	1.8 A
	250 V DC	0.6 A
Short-circuit protection device gG type fuse	10 A	
Rated short-time withstand current $I_{cw}$	for 1.0 s	50 A
$\theta = 40$ °C	for 0.1 s	100 A
Minimum switching capacity	0.25 VA / 12 V or 0.25 VA / 5 mA	
with failure rate acc. to IEC 60947-5-4		
Power dissipation per pole at 6 A	0.2 W	
Mechanical durability	Number of operating cycles	10 millions operating cycles
	Max. switching frequency	3600 cycles/h
Electrical durability	Number of operating cycles	see "Electrical durability" curves
	Max. switching frequency	1200 cycles/h

5

### Contact utilization characteristics according to UL / CSA

Max. operational voltage	600 V
Pilot duty	A600

### Connecting characteristics

Connection capacity (min. ... max.)		
	Rigid solid	1 x 0.5...2.5 mm <sup>2</sup>
	Flexible with ferrule	2 x 0.5...2.5 mm <sup>2</sup>
		1 x 0.5...2.5 mm <sup>2</sup>
	Flexible with insulated ferrule	2 x 0.5...2.5 mm <sup>2</sup>
		1 x 0.5...1.5 mm <sup>2</sup>
	Lugs	L ≤ 8 mm
		L > 3.7 mm
Tightening torque	Recommended	1.00 Nm
	Max.	1.20 Nm
Degree of protection		IP20
acc. to IEC 60947-1 / EN 60947-1 and IEC 60529 / EN 60529		
Screw terminals	Delivered in open position, screws of unused terminals must be tightened	
All terminals	M3.5	
Screwdriver type	Pozidriv 2	

# Auxiliary contacts

## Electrical durability

### Electrical Durability for AC-15 Utilization Category

AC-15 utilization category according to IEC 60947-5-1 / EN 60947-5-1:

- making current:  $10 \times I_e$  with  $\cos \varphi = 0.7$  and  $U_e$
- breaking current:  $I_e$  with  $\cos \varphi = 0.4$  and  $U_e$ .

This curve represents the electrical durability of the auxiliary contacts in relation to the breaking current.

The curve has been drawn for resistive and inductive loads up to 690 V, 40...60 Hz.

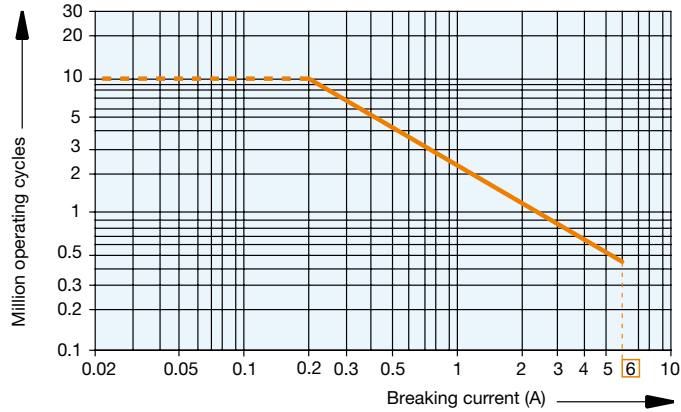

2-pole CAL16... and CCL16... auxiliary contact blocks

### Electrical Durability for DC-13 Utilization Category

DC-13 utilization category according to IEC 60947-5-1 / EN 60947-5-1:

- making and breaking current =  $I_e$  with  $U_e$  value.

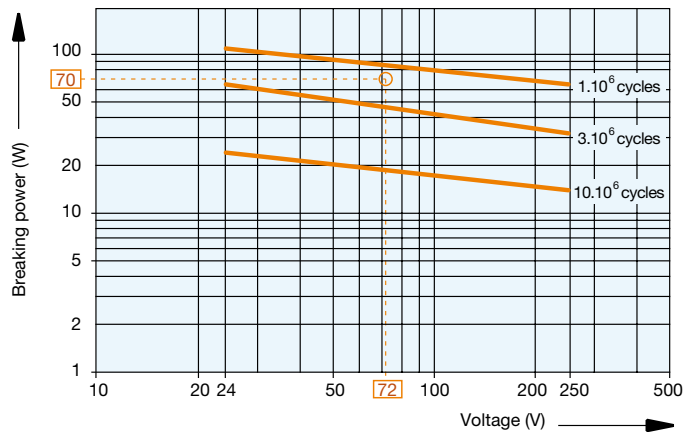

2-pole CAL16... and CCL16... auxiliary contact blocks

#### Example:

Control of d.c. electro-magnet:  $U_e$  voltage = 72 V d.c. and breaking power = 70 W.

On the opposite curve at intersection "O" 72 V / 70 W the corresponding value for the electrical durability is approximately  $2 \cdot 10^6$  cycles.



# Add-on auxiliary contacts

## Terminal marking and positioning

### 2-pole auxiliary contacts



CAL16-11A



CAL16-11B



CAL16-11C



CAL16-11 D



CAL16-11E

# Mechanical interlock units

## Mechanical and electrical interlock units



A08PC4

### Description

The mechanical interlock unit prevents one of the contactors from closing as long as the other contactor is closed.

- VH145, VH300 interlock units for mechanical and electrical interlocking of two horizontal mounted AC or DC operated EK110 ... EK1000 contactors.
- VH800 interlock unit for mechanical interlocking of two horizontal mounted AC or DC operated EK370 ... EK1000 contactors.

### Ordering details

For contactors	Type	Order code	Pkg qty	Weight (1 pce) kg
----------------	------	------------	---------	-------------------

#### Mechanical and electrical interlock units for two horizontal mounted contactors

EK110, EK150	VH145	SK829071-A	1	0.130
EK175, EK210	VH300	SK829071-B	1	0.130

#### Mechanical interlock unit for two horizontal mounted contactors

EK370 ... EK1000	VH800	SK829070-F	1	6.000
------------------	-------	------------	---	-------

### Selection table

For contactors

Left	Right	EK110, EK150	EK175, EK210	EK370 ... EK1000
EK110, EK150		VH145	-	-
EK175, EK210		-	VH300	-
EK370 ... EK1000		-	-	VH800
Fixing		PN210-22 mounting plate (to be supplied separately)	PN300-22 mounting plate (to be supplied separately)	Mounting plate included



1SFC573992FC001

VH145

5

# Mechanical interlocks units

## Mechanical and electrical interlock units





### Technical data

Types	VH145	VH300
-------	-------	-------

### Contact utilization characteristics according to IEC

Standards	IEC 60947-5-1 and EN 60947-5-1	
Rated insulation voltage $U_i$ acc. to IEC 60947-5-1	690 V	
Rated insulation voltage $U_i$ acc. to UL / CSA	600 V	
Rated operational voltage $U_e$ max.	24 ... 690 V	
Conventional thermal current $I_{th}$ - $\theta \leq 40$ °C	10 A	
$I_e$ / Rated operational current AC-15 acc. to IEC 60947-5-1	24-127 V 50/60 Hz	6 A
	220-240 V 50/60 Hz	6 A
	380-440 V 50/60 Hz	4 A
	500-690 V 50/60 Hz	1 A
	Making capacity acc. to IEC 60947-5-1	
Breaking capacity acc. to IEC 60947-5-1		10 x $I_e$ AC-15
$I_e$ / Rated operational current DC-13 acc. to IEC 60947-5-1	24 V DC	6 A
	48 V DC	6 A
	72 V DC	4 A
	125 V DC	1.8 A
	250 V DC	0.6 A
Short-circuit protection device - gG type fuse	10 A	
Rated short-time withstand current $I_{cw}$ $\theta = 40$ °C	for 1.0 s	100 A
	for 0.1 s	140 A
Power dissipation per pole at 6 A	0.15 W	
Mechanical durability	1 million operating cycles	
Max. switching frequency	600 cycles/h	

### Connecting characteristics

Connection capacity (min. ... max.)		
 Rigid solid	1 x	1 ... 2.5 mm <sup>2</sup>
 Flexible with ferrule	2 x	1 ... 2.5 mm <sup>2</sup>
 Flexible with ferrule	1 x	0.75 ... 2.5 mm <sup>2</sup>
 Flexible with ferrule	2 x	0.75 ... 2.5 mm <sup>2</sup>
 Bars or lugs	L <	8 mm
	L >	3.7 mm
Tightening torque		
Recommended	1 Nm	
Max.	1.2 Nm	
Degree of protection		
acc. to IEC 60947-1 / EN 60947-1 and IEC 60529 / EN 60529		IP20
Screw terminals		
All terminals	Delivered in open position, screws of unused terminals must be tightened	
Screwdriver type	M3.5	
Screwdriver type	Flat Ø 5.5 / Pozidriv 2	

Technical note: when, during switching, the arc time is estimated to more than 40 ms, the closing signal of one of the two contactors must be delayed with respect to the opening signal of the other contactor in order to prevent a short-circuit.

Use a TP40 pneumatic timer or TE5S electronic timer with time lapse, as applicable.

# Surge suppressors for contactor coils

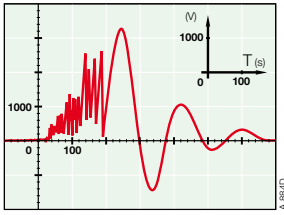

## Description

The operation of inductive circuits causes overvoltages, in particular on opening of the contactor coil. The electromagnetic energy stored in the coil during contactor closing is restored on opening in the form of surges, the slope and amplitude of which may rise to several kilovolts. A number of drawbacks are observed ranging from interference on the electronic devices to breakdown of insulators and even destruction of certain sensitive components.

The graph opposite reproduces the oscillogram showing voltage discharges at the terminals of a 42 V / 50 Hz coil without peak clipping. The coil was switched by 8 series-connected poles of a contactor relay.

Following a burst of discharges with a very steep slope a damped oscillation emerges with a peak value of 3500 V.

## Overvoltage Factor

The overvoltage factor  $k$  is defined as the ratio of the maximum overvoltage peak value  $\hat{U}_s$  to the peak value  $\hat{U}_c$  of the coil rated control voltage  $U_c$ :

$$k = \frac{\hat{U}_s \text{ max.}}{\hat{U}_c} \quad \text{in DC: } k = \frac{\hat{U}_s \text{ max.}}{U_c} \quad \text{or in AC: } k = \frac{\hat{U}_s \text{ max.}}{U_c \sqrt{2}}$$

For example the following is obtained for the above graph:  $k = \frac{3500}{42 \sqrt{2}} \approx 60$

To reduce the harmful effects of these overvoltages, ABB has developed a range of surge suppressors designed to reduce the  $k$  factor defined above and to limit or even completely eliminate the high pre-damping voltage frequencies.

Each case is different, but the technical data tolerances and the generous sizing of parts have enabled us to reduce the number of variants.

We have chosen the following solutions: transil diodes, varistors and RC blocks.

Note: A varistor is a resistor whose value decreases to a very large extent when a certain voltage is applied at its terminals.



RC-EH300/48

## Ordering details

For contactors	Rated control circuit voltage $U_c$			Type	Order code	Pkg qty	Weight (1 pce) kg
	V	AC	DC				
EK110 ... EK210	24...48	●	-	RC-EH300/48	SK829007-A	1	0.015
	110...415	●	-	RC-EH300/415	SK829007-B	1	0.015
EK370 ... EK1000	48...110	●	-	RC-EH800/110	SK829007-C	1	0.015
EK110 ... EK1000	24...125	-	●	RC-EH800/110	SK829007-C	1	0.015
EK370 ... EK1000	220...600	●	-	RC-EH800/600	SK829007-D	1	0.015

# Surge suppressors for contactor coils

## Technical data

Varistor + RC	RC-EH800/110	RC-EH800/600
Rated control circuit voltage $U_c$	48 ... 110 V AC 24 ... 125 V DC	220 ... 600 V AC -
Residual overvoltage (clipping voltage)	205 V AC 205 V DC	1100 V AC -
Opening time growth factor	1.1 ... 1.15	
Operating temperature	-20 ... +70 °C	
Connection to the coil terminals (parallel mounting)	Flexible, accessible leads, equipped with forked lugs	
Fixing	Glued to the top part of the contactor base	
Advantages	<ul style="list-style-type: none"> <li>- High energy absorption: good damping</li> <li>- Unpolarized system</li> <li>- The RC system damps the voltage front under the <math>U_{vdr}^*</math> threshold.</li> </ul>	

\* $U_{vdr}$  = Varistor operating (voltage dependant resistor), tolerance  $\pm 10\%$

RC type	RC-EH300/48	RC-EH300/415
Rated control circuit voltage $U_c$	24 ... 48 V AC	110 ... 415 V AC
Residual overvoltage (clipping voltage)	2 to 3 x $U_c$ max.	
Opening time growth factor	1.2 ... 3	
Operating temperature	-20 ... +70 °C	
Connection to the coil terminals (parallel mounting)	Flexible, accessible leads, equipped with forked lugs	
Fixing	Glued to the top part of the contactor base	
Advantages	<ul style="list-style-type: none"> <li>- Very fast clipping</li> <li>- Attenuation of steep fronts and thus of high frequencies</li> <li>- No operating delays.</li> </ul>	

## Wiring diagrams

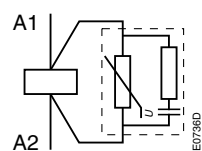

Varistor + RC

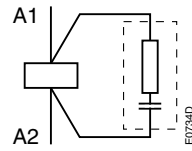

RC type

## Main dimensions mm

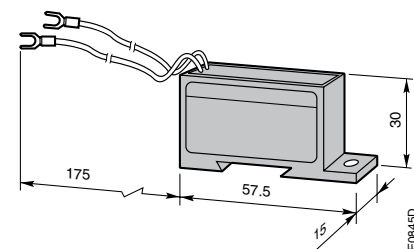

RC-EH

# Terminal shrouds and connection sets



LT210-EK

1SFC101068C01C3

## Terminal shrouds

### Description

The use of terminal shrouds on the main terminals of EK... contactors is required in electrical panels or cubicles to be built in compliance with the rules for protection against direct contact with live parts in acc. with EN 50274.

On EK110 ... EK1000 contactors:

- The auxiliary contact blocks and coils are designed to provide an IP20 degree of protection
- The main terminals, equipped with lugs or connectors, can be protected against accidental direct contact after wiring (EN 50274) by the addition of terminal shrouds (see table below).

Each terminal shroud protects all the terminals on one side of the contactor. Two terminal shrouds should be provided for each separate contactor.

### Ordering details

For contactors	Type	Order code	Pkg qty	Weight (1 pce) kg
EK110, EK150	LT150-EK	SK178001-HB	1	0.139
EK175, EK210	LT210-EK	SK178001-KB	1	0.152
EK370, EK550	LT550-EK	SK178001-LB	1	0.190
EK1000	LT1000-EK	SK178001-MB	1	0.200

5

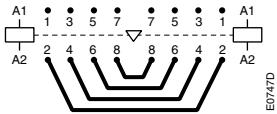

BSS100 ... BSS1000

EB/47D

## Connection sets

### Description

Connection between the main poles of two 4-pole contactors mounted side by side so that they operate as source reversing contactors.

These sets are made up of four downstream connections.

BSS100 ... BSS210 – Insulated, flexible copper bars.

BSS550, BSS1000 – Bare, solid copper bars.

### Ordering details

For contactors	Type	Order code	Pkg qty	Weight (1 pce) kg
<b>Mechanical and electrical interlock units for two horizontal mounted contactors</b>				
EK110	BSS100	SK829090-B	1	0.400
EK150	BSS145	SK829090-F	1	0.700
EK175, EK210	BSS210	SK829090-G	1	1.000
EK370, EK550	BSS550	SK829090-E	1	3.300
EK1000	BSS1000	SK829090-H	1	5.500

# Mounting plates



PN...

## Description

Mounting plates for two horizontal mounted contactors with or without a mechanical interlock unit.

## Ordering details

To use with:			Type	Order code	Pkg qty	Weight (1 pce) kg
Left hand contactor	Mechanical interlock	Right hand contactor				
EK110, EK150	VH145	EK110, EK150	PN210-22	SK829075-C	1	1.400
EK175, EK210	VH300	EK175, EK210	PN300-22	SK829075-E	1	2.070

(1) Space for mechanical interlock included.

## Main dimensions mm

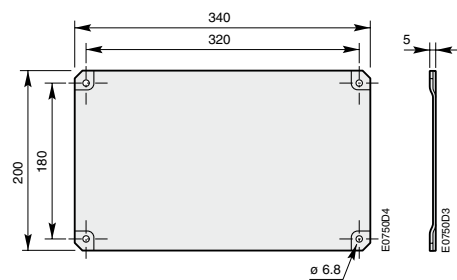

PN210-22

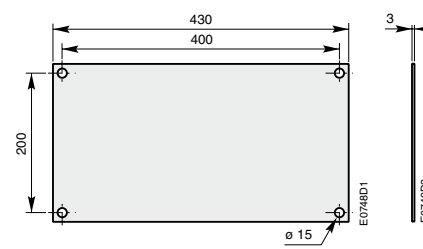

PN300-22

1SFC101069C0201

# Main contact sets

## Arc chutes



1SFC586473P0304

KZK370

### Main contact sets

#### Description

The contact sets for 4-pole contactors consist of eight fixed contacts, four moving contacts, springs and the necessary screws. In addition, the sets include four moving arcing contacts for EK370 ... EK1000 contactors.

#### Ordering details

For contactors	Type	Order code	Pkg qty	Weight (1 pce) kg
EK110	KZK110	SK824204-A	1	0.450
EK150	KZK150	SK824204-B	1	0.450
EK175	KZK175	SK825204-A	1	0.700
EK210	KZK210	SK825204-B	1	0.700
EK370	KZK370	SK827204-A	1	2.400
EK550	KZK550	SK827204-B	1	2.400
EK1000	KZK1000	SK827204-F	1	3.000

### Arc chutes

#### Description

The arc chutes sets for EK 4-pole contactors contain 8 pieces.

#### Ordering details

For contactors	Type	Order code	Pkg qty	Weight (1 pce) kg
EK110	KWK110	5223351-AH	1	0.660
EK150	KWK150	5223351-AK	1	0.660
EK175	KWK175	5223351-AL	1	1.260
EK210	KWK210	5223351-AM	1	1.260
EK370	KWK370	5223351-Y	1	3.170
EK550	KWK550	5223351-Z	1	3.170
EK1000	KWK1000	5223351-AN	1	3.170



# Contactor coils



KH300

1SFC273613F0302

## Description

Coils for EK110 ... EK1000 - AC operated.

## Ordering details

For contactors	Rated control circuit voltage U <sub>c</sub> (1)		Type	Order code	Pkg qty	Weight (1 pce)  kg
	V 50 Hz	V 60 Hz				
EK110 ... EK150	48	-	KH210	SK825400-AD	1	0.360
	-	110	KH210	SK825400-AE	1	0.360
	110	120	KH210	SK825400-AF	1	0.360
	220...230	-	KH210	SK825400-AL	1	0.360
	230...240	-	KH210	SK825400-AM	1	0.360
	-	380	KH210	SK825400-AN	1	0.360
	380...400	440	KH210	SK825400-AP	1	0.360
EK175 ... EK210	48	-	KH300	SK826400-AD	1	0.440
	-	110	KH300	SK826400-AE	1	0.440
	110	120	KH300	SK826400-AF	1	0.440
	220...230	-	KH300	SK826400-AL	1	0.440
	230...240	-	KH300	SK826400-AM	1	0.440
	-	380	KH300	SK826400-AN	1	0.440
	380...400	440	KH300	SK826400-AP	1	0.440
EK370 ... EK1000	48	-	KH800	SK828100-AD	1	0.950
	110	110...120	KH800	SK828100-EF	1	0.950
	110...115	115...127	KH800	SK828100-EG	1	0.950
	220	220...240	KH800	SK828100-EL	1	0.950
	220...230	230...255	KH800	SK828100-EM	1	0.950
	380	380...415	KH800	SK828100-EP	1	0.950
	380...400	400...440	KH800	SK828100-ER	1	0.950
400...415	-	KH800	SK828100-AR	1	0.950	

(1) Other control voltages, see voltage code table.

# Contactors coils

## Description

- Coils for EK110 ... EK1000 - DC operated with sets including a DC coil, an economy resistor and a insertion contact.
- Coils for EK110 ... EK210 - Multi-frequency coil and an insertion contact for contactor with built-in rectifier.

## Ordering details

For contactors	Rated control circuit voltage U <sub>c</sub> (1) V DC	Type	Order code	Pkg qty	Weight (1 pce) kg
EK110 ... EK150	12	KP210	SK825450-DA	1 set	0.450
	24	KP210	SK825450-DB	1 set	0.450
	36	KP210	SK825450-DC	1 set	0.450
	48	KP210	SK825450-DD	1 set	0.450
	60	KP210	SK825450-DT	1 set	0.450
	75	KP210	SK825450-DG	1 set	0.450
	110	KP210	SK825450-DE	1 set	0.450
	125	KP210	SK825450-DU	1 set	0.450
EK175 ... EK210	220	KP210	SK825450-DF	1 set	0.450
	12	KP300	SK826450-DA	1 set	0.550
	24	KP300	SK826450-DB	1 set	0.550
	36	KP300	SK826450-DC	1 set	0.550
	48	KP300	SK826450-DD	1 set	0.550
	60	KP300	SK826450-DT	1 set	0.550
	75	KP300	SK826450-DG	1 set	0.550
	110	KP300	SK826450-DE	1 set	0.550
EK3700 ... EK1000	125	KP300	SK826450-DU	1 set	0.550
	220	KP300	SK826450-DF	1 set	0.550
	24	KP800	SK828150-DB	1 set	1.060
	36	KP800	SK828150-DC	1 set	1.060
	48	KP800	SK828150-DD	1 set	1.060
	60	KP800	SK828150-DT	1 set	1.060
	75	KP800	SK828150-DG	1 set	1.060
	110	KP800	SK828150-DE	1 set	1.060
125	KP800	SK828150-DU	1 set	1.060	
220	KP800	SK828150-DF	1 set	1.060	

## Ordering details

For contactors	Rated control circuit voltage U <sub>c</sub> (1) V AC 40...400 Hz	Type	Order code	Pkg qty	Weight (1 pce) kg
EK110 ... EK150	110...120	KP210	SK825450-EF	1 set	0.450
	115...127	KP210	SK825450-EG	1 set	0.450
	220...230	KP210	SK825450-EL	1 set	0.450
	230...240	KP210	SK825450-EM	1 set	0.450
	380...400	KP210	SK825450-EP	1 set	0.450
	400...415	KP210	SK825450-ER	1 set	0.450
EK175 ... EK210	110...120	KP300	SK826450-EF	1 set	0.450
	115...127	KP300	SK826450-EG	1 set	0.450
	220...230	KP300	SK826450-EL	1 set	0.450
	230...240	KP300	SK826450-EM	1 set	0.450
	380...400	KP300	SK826450-EP	1 set	0.450
	400...415	KP300	SK826450-ER	1 set	0.450

(1) Other control voltages, see voltage code table.

# Voltage code table

The below tables indicate the available coil voltages and corresponding digits for order codes. When placing an order, please give the order code. Select a standard contactor from ordering detail pages. Change the **coil voltage code** in the order code according to the table below. Example: for contactor AF400-30-11 and coil 100...250 V 50/60 Hz, the order code is 1SFL577001R**70**11.

## AF09 ... AF370 3-pole contactors

### AF09 ... AF38 4-pole contactors

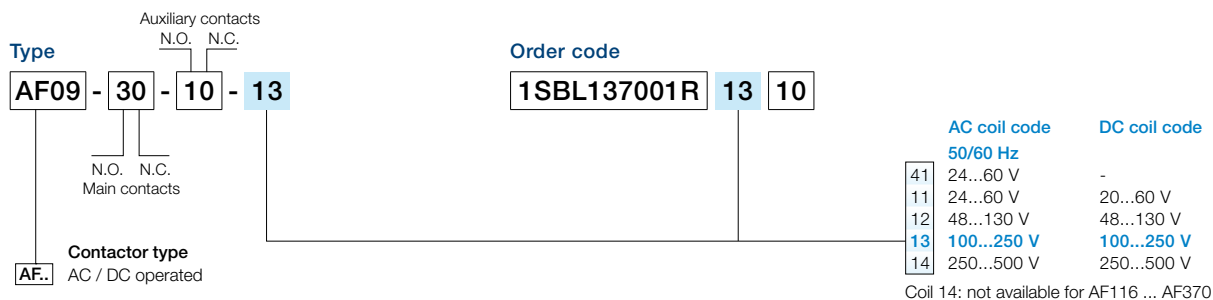

## AF400 ... AF2650 3-pole contactors

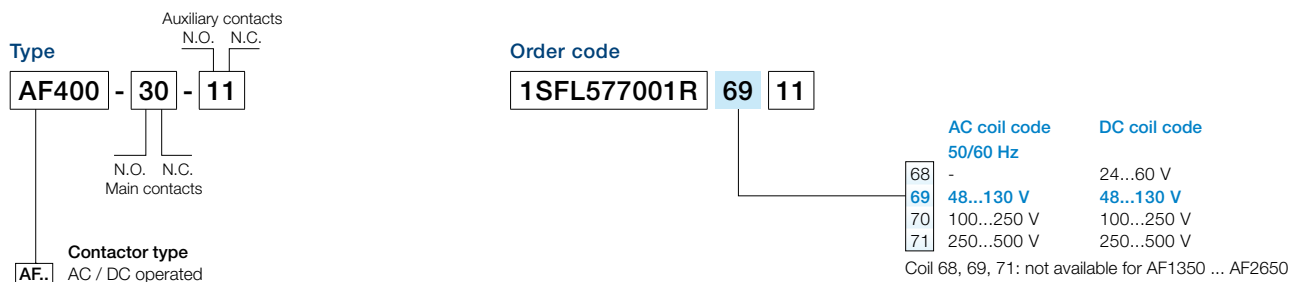

## AF09 ... AF38 3- and 4-pole contactors - low consumption

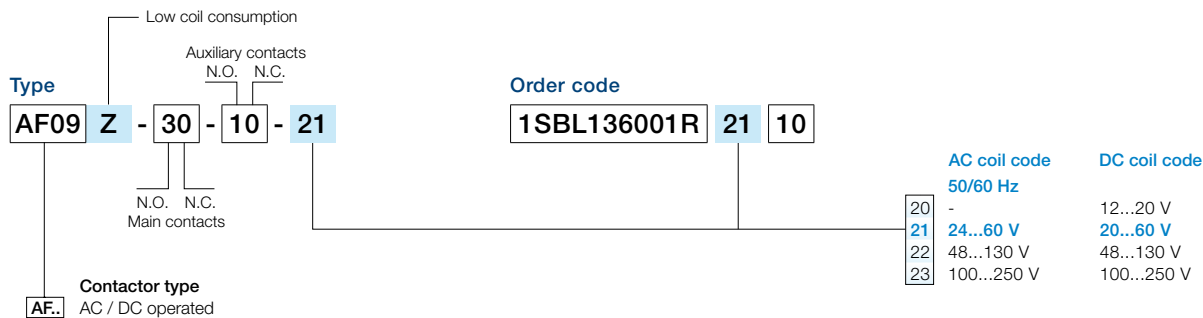

# Voltage code table

## NF contactor relays



## NF contactor relays - low consumption

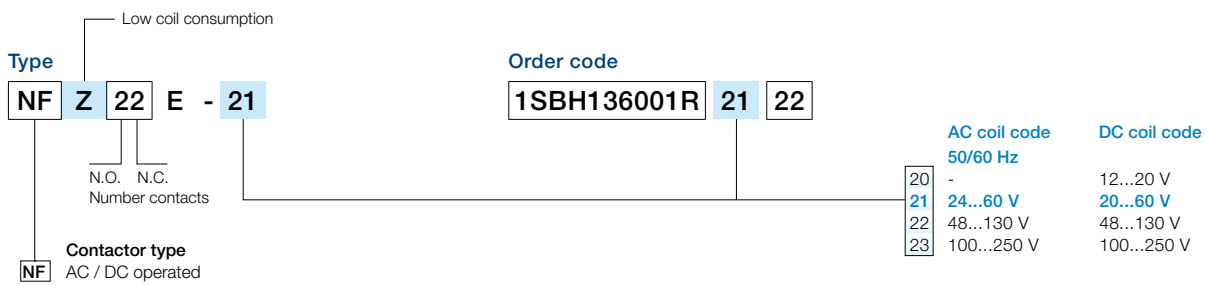

# Voltage code table

## A.. 4-pole contactors, UA, UA..RA contactors

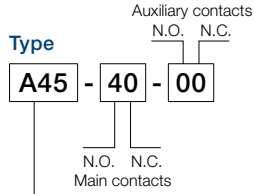

Order code

1SBL331201R **80** 00

**A45, A50, A75**  
**AE45, AE50, AE75**  
**TAE45, TAE50, TAE75**  
**AF45, AF50, AF75**

**GAF**

**UA, UA..RA**  
**GA**  
**GAE**  
**AM**

**Contactor type**

AC operated  
DC operated  
DC operated large coil voltage range  
AC / DC operated with electronic coil interface  
AC / DC operated with electronic coil interface  
Capacitor switching - AC operated  
DC switching - AC operated  
DC switching - DC operated  
Magnetically latched - DC operated

Contactors: A, UA, UA..RA, GA  
AC coil code

	50 Hz	60 Hz
81	24 V	24 V
16	26 V	28 V
17	28 V	32 V
82	42 V	42 V
20	42 V	48 V
83	48 V	48 V
73	60 V	60 V
74	100 V	100...110 V
26	105 V	110...127 V
84	110 V	110...120 V
89	110...115 V	115...127 V
29	120 V	140 V
30	125...127 V	150 V
34	175 V	208 V
36	190 V	220 V
40	210 V	240 V
80	220...230 V	230...240 V
88	230...240 V	240...260 V
42	230...240 V	277 V
85	380...400 V	400...415 V
86	400...415 V	415...440 V
50	400 V	440 V
51	400...415 V	480 V
87	415...440 V	440...460 V
53	440 V	500 V
55	500 V	600 V
56	550 V	-
58	660...690 V	-
59	-	690 V

Codes in bold for dual frequency coils.

Contactors: AE, TAE, GAE  
DC coil code

80	12 V
81	24 V
82	42 V
83	48 V
21	50 V
84	60 V
85	75 V
86	110 V
87	125 V
88	220 V
89	240 V
38	250 V

Contactors: AF45, AF50, AF75  
AC coil code DC coil code

	50/60 Hz	
72	-	20...60 V
69	48...130 V	48...130 V
70	100...250 V	100...250 V

5

## EK contactors

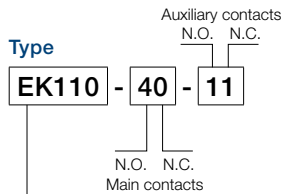

**Contactor type**

**EK** AC operated or DC operated

Order code

SK824440 - **AD**

Contactors: EK110 ... EK210  
AC coil code

	50 Hz	60 Hz
AA	-	24 V
AB	24 V	-
AC	-	48 V
AD	48 V	-
AE	-	110 V
AF	110 V	120 V
AG	127 V	-
AZ	-	208 V
AH	190 V	220 V
AK	-	240 V
AL	220...230 V	-
AM	230...240 V	-
AN	-	380 V
AP	380...400 V	440 V
AR	400...415 V	-
AS	-	480 V
AT	440 V	-
AU	500 V	-
AV	-	600 V

Contactors: EK370 ... EK1000  
AC coil code

	50 Hz	60 Hz
AD	48 V	-
AE	-	110 V
AF	110 V	120 V
AG	127 V	-
AZ	-	208 V
AH	190 V	220 V
AK	-	240 V
AL	220...230 V	240 V
AM	230...240 V	-
AN	-	380 V
AP	380...400 V	440 V
AR	400...415 V	-
AS	-	480 V
AT	440 V	-
AU	500 V	-
AV	-	600 V

Contactors: EK110 ... EK1000  
DC coil code

DA	12 V (2)
DB	24 V
DC	36 V
DD	48 V
DT	60 V
DG	75 V
DE	110 V
DU	125 V
DF	220 V

(2) Not for EK370 ... EK1000 contactors.

Contactors: EK110 ... EK210  
Multi-frequency coil code

40...400 Hz	
EF	110...120 V
EG	115...127 V
EL	220...230 V
EM	230...240 V
EP	380...400 V
ER	400...415 V

Contactors: EK370 ... EK1000  
Dual frequency coil code

	50 Hz	60 Hz
EF	110 V	110...120 V
EG	110...115 V	115...127 V
EL	220 V	220...240 V
EM	220...230 V	230...255 V
EP	380 V	380...415 V
ER	380...400 V	400...440 V

2 auxiliary contact blocks maximum per contactor, ambient temperature ≤ 55 °C and mounting positions 2 and 6 excluded.

# Questionnaire for product specifications: Block contactors

Tel.: ..... e-mail: .....  
Segments: .....

Tel.: ..... e-mail: .....  
Date: .....

## Application

Type: ..... No of phases: .....  
Utilisation category (AC/DC): ..... % AC4 if any: .....  
Rated operational voltage  $U_e$ : ..... V  $\cos \varphi$ : .....  
Frequency: ..... Hz L/R: ..... ms  
Nominal current  $I_n$ : ..... A  
Making current: ..... A Breaking current: ..... A  
Duty:  continuous  temporary  intermittent  
Load factor (% of ON time): ..... %  
Number of cycles per hour: ..... or per year: .....  
Expected durability: ..... operating cycles  
Number of main poles N.O.: ..... N.C.: .....  
Other information: .....

## Control circuit

Rated control  $U_c$  voltage: ..... V  DC  AC f: ..... Hz  
Minimum / maximum: ..... V to ..... V  
Surge suppressor: ..... type: .....  
Interface with PLC: ..... mA ..... V DC  
Accessories: .....  
Number of auxiliary contacts: N.O.: ..... N.C.: .....  
Low level contacts: ..... mA ..... V  DC  AC

## Protection

Short circuit protection: .....  
Type:  Fuse  Circuit breaker  Manual motor starter  
Max short circuit current: ..... A  
Motor protection:  Overload relay  Manual Motor Starter  Electronic overload relay

## Installation

Ambient temperature: .....  
Ambient environment: .....  
Humidity: ..... %  
Chemical pollution: .....  
Other: .....  
Mounting position, see drawing below (Position 6:  
please consult factory): .....

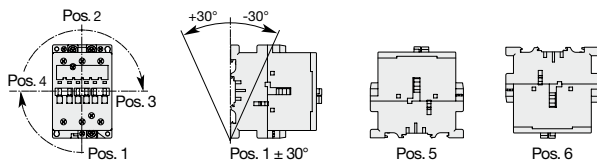

Wiring:  Clamping screws or cage connectors  
 Cable lugs (ring tongue)  
Other: ..... Cross section: .....  
Additional comments: .....

## Logistic and packaging

Quantity by batch: .....  
Delivery order: .....  
Expected quantity: ..... per year  
Expected first delivery date: ..... and Qty: .....  
Quantity on first 6 month: ..... on first year: .....

## Approvals and other requirements

Reference standards: .....  
Required approvals: .....  
Customer specifications: .....  
Shock and vibrations: .....  
Specific quality assurance clauses: .....  
Other comments: .....

# Questionnaire for product specifications: Block contactors

Other comments: .....

.....

.....

.....

.....

.....

.....

.....

.....

.....

## User Guide for the questionnaire

This document is used to define the contactor specifications according to the complete information on the application. Do not hesitate to join some complementary documents if necessary (schemes, tables, customer specification...).

Please see below some definitions to help you :

### Operating cycle

Includes one making operation and one breaking operation.

### Electrical Durability

Number of on-load operating cycles that the contactor is able to carry out. It depends on the utilization category.

### Mechanical Durability

Number of no-current operating cycles that the contactor is able to carry out

### Load Factor

Ratio of the on-load operating time to the total cycle time x 100 (%).

### Intermittent Duty

Duty during which the contactor is successively closed or open for periods which are too short to enable the contactor to achieve thermal balance.

### Temporary Duty

Duty in which the main contacts of the contactor remain closed for periods insufficient to allow the equipment to reach stabilized temperature, the unload periods being separated by off-load periods of sufficient duration to restore the ambient temperature

### Continuous Duty

Duty in which the main contacts of the contactor remain closed, with a continuous current during enough time to reach thermal stabilization, but no more than eight hours without interruption.

### Ambient Temperature

Air temperature close to the contactor.

### Mounting Position

Comply with the manufacturer's instructions. Restrictions could be taken into account for certain mounting positions.

A contactor's duty is characterized by the utilization category together with the rated operational voltage and current indicated:

### Utilization categories for contactors according to IEC 60947-4-1

### Utilization categories for contactor relays according to IEC 60947-5-1

See our catalog p7/8

### Making and breaking current

Current at contactor closing or at contactor opening

### Time constant L/R (for DC circuit)

Ratio of the inductance to the resistance ( $L/R = \text{mH}/\Omega = \text{ms}$ )





# AS..S, AF..S 3-pole contactors and NS..S, NF..S contactor relays with spring terminals

<b>AS..S 3-pole contactors - with spring terminals</b>	<b>6/3</b>
Ordering details	6/4
Technical data	6/10
Terminal marking and postioning	6/16
Main dimensions	6/18
Accessories	6/32
Voltage code table	6/37

<b>NS..S contactor relays - with spring terminals</b>	<b>6/3</b>
Ordering details	6/20
Technical data	6/24
Terminal marking and postioning	6/28
Main dimensions	6/30
Accessories	6/32
Voltage code table	6/37

<b>AF..S 3-pole contactors - with spring terminals</b>	<b>6/39</b>
Overview	6/40
Ordering details	6/42
Technical data	6/48
Terminal marking and postioning	6/53
Main dimensions	6/54
Accessories	6/72
Voltage code table	6/79

<b>NF..S contactor relays - with spring terminals</b>	<b>6/39</b>
Overview	6/58
Ordering details	6/60
Technical data	6/66
Terminal marking and postioning	6/69
Main dimensions	6/70
Accessories	6/72
Voltage code table	6/79



# AS..S 3-pole contactors and NS..S contactor relays with spring terminals

## AS..S 3-pole contactors - with spring terminals

AS09..S ... AS16..S	AC operated	6/4
ASL09..S ... ASL16..S	DC operated	6/5
AS09..S ... AS16..S	AC operated - 2-stack	6/6
ASL09..S ... ASL16..S	DC operated - 2-stack	6/7
Main accessories		6/8
Technical data		6/10
Terminal marking and postioning		6/16
Main dimensions		6/18

## NS..S contactors relays - with spring terminals

NS..S	AC operated	6/20
NSL..S	DC operated	6/21
Main accessories		6/22
Technical data		6/24
Terminal marking and postioning		6/28
Main dimensions		6/30

## Accessories

Auxiliary contact blocks - with spring terminals	6/32
Surge suppressors for contactor coils	6/34
Connecting links for starting solution and other accessories	6/36

Voltage code table	6/37
--------------------	------

# AS09..S ... AS16..S 3-pole contactors

## 4 to 7.5 kW

### AC operated - with spring terminals



AS09-30-10S

1SBC101009F0014

#### Description

AS09 ... AS16 contactors are mainly used for controlling 3-phase motors and power circuits up to 690 V AC and 220 V DC.

These contactors are of the block type design with:

- spring terminals
- 3 main poles and 1 built-in auxiliary contact
- control circuit: AC operated
- add-on auxiliary contact blocks for front mounting and a comprehensive range of accessories.

#### Ordering details

IEC		UL/CSA		Rated control circuit voltage U <sub>c</sub>		Auxiliary contacts fitted		Type	Order code	Weight				
Rated operational power	Rated operational current I <sub>n</sub> at θ ≤ 40 °C	3-phase motor rating	General use rating	U <sub>c</sub> (1)		I L				Pkg (1 pce)				
400 V AC-3	AC-1	480 V	600 V AC	V 50 Hz	V 60 Hz	I L				kg				
kW	A	hp	A			1	0							
4	20	5	12	24	24	1	0	AS09-30-10S-20	1SBL101004R2010	0.220				
						0	1	AS09-30-01S-20	1SBL101004R2001	0.220				
				-	120	1	0	AS09-30-10S-16	1SBL101004R1610	0.220				
						0	1	AS09-30-01S-16	1SBL101004R1601	0.220				
				230	230	1	0	AS09-30-10S-26	1SBL101004R2610	0.220				
						0	1	AS09-30-01S-26	1SBL101004R2601	0.220				
				400	400	1	0	AS09-30-10S-28	1SBL101004R2810	0.220				
						0	1	AS09-30-01S-28	1SBL101004R2801	0.220				
				5.5	22	7.5	12	24	24	1	0	AS12-30-10S-20	1SBL111004R2010	0.220
										0	1	AS12-30-01S-20	1SBL111004R2001	0.220
-	120	1	0					AS12-30-10S-16	1SBL111004R1610	0.220				
		0	1					AS12-30-01S-16	1SBL111004R1601	0.220				
230	230	1	0					AS12-30-10S-26	1SBL111004R2610	0.220				
		0	1					AS12-30-01S-26	1SBL111004R2601	0.220				
400	400	1	0					AS12-30-10S-28	1SBL111004R2810	0.220				
		0	1					AS12-30-01S-28	1SBL111004R2801	0.220				
7.5	22	10	15.2					24	24	1	0	AS16-30-10S-20	1SBL121004R2010	0.220
										0	1	AS16-30-01S-20	1SBL121004R2001	0.220
				-	120	1	0	AS16-30-10S-16	1SBL121004R1610	0.220				
						0	1	AS16-30-01S-16	1SBL121004R1601	0.220				
				230	230	1	0	AS16-30-10S-26	1SBL121004R2610	0.220				
						0	1	AS16-30-01S-26	1SBL121004R2601	0.220				
				400	400	1	0	AS16-30-10S-28	1SBL121004R2810	0.220				
						0	1	AS16-30-01S-28	1SBL121004R2801	0.220				

Note: for multiple packaging, please contact your ABB local sales organization.

(1) Other control voltages see voltage code table.

#### Main dimensions mm, inches

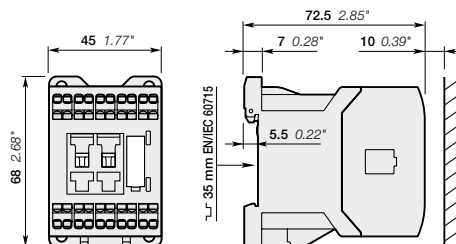

AS09..S, AS12..S, AS16..S

1SBC101454S0201

# ASL09..S ... ASL16..S 3-pole contactors

## 4 to 7.5 kW

### DC operated - with spring terminals



ASL09-30-10S



#### Description

ASL09..S ... ASL16..S contactors are mainly used for controlling 3-phase motors and power circuits up to 690 V AC and 220 V DC.

These contactors are of the block type design with:

- spring terminals
- 3 main poles and 1 built-in auxiliary contact
- control circuit: low consumption (3 W at pull-in and holding) DC operated with solid core magnet. Suitable for direct control by PLC outputs (the polarity on the coil terminals A1+ and A2- must be respected)
- add-on auxiliary contact blocks for front mounting and comprehensive range of accessories.

#### Ordering details

IEC		UL/CSA		Rated control circuit voltage Uc (1)	Auxiliary contacts fitted	Type	Order code	Weight				
Rated operational power	operational current $\theta \leq 40^\circ\text{C}$	3-phase motor rating 480 V	General use rating 600 V AC						Pkg (1 pce)			
400 V AC-3 kW	AC-1 A	hp	A	V DC	 			kg				
4	20	5	12	24	1 0	ASL09-30-10S-81	1SBL103004R8110	0.280				
					0 1	ASL09-30-01S-81	1SBL103004R8101	0.280				
				48	1 0	ASL09-30-10S-83	1SBL103004R8310	0.280				
					0 1	ASL09-30-01S-83	1SBL103004R8301	0.280				
				110	1 0	ASL09-30-10S-86	1SBL103004R8610	0.280				
					0 1	ASL09-30-01S-86	1SBL103004R8601	0.280				
				220	1 0	ASL09-30-10S-88	1SBL103004R8810	0.280				
					0 1	ASL09-30-01S-88	1SBL103004R8801	0.280				
				5.5	22	7.5	12	24	1 0	ASL12-30-10S-81	1SBL113004R8110	0.280
									0 1	ASL12-30-01S-81	1SBL113004R8101	0.280
48	1 0	ASL12-30-10S-83	1SBL113004R8310					0.280				
	0 1	ASL12-30-01S-83	1SBL113004R8301					0.280				
110	1 0	ASL12-30-10S-86	1SBL113004R8610					0.280				
	0 1	ASL12-30-01S-86	1SBL113004R8601					0.280				
220	1 0	ASL12-30-10S-88	1SBL113004R8810					0.280				
	0 1	ASL12-30-01S-88	1SBL113004R8801					0.280				
7.5	22	10	15.2					24	1 0	ASL16-30-10S-81	1SBL123004R8110	0.280
									0 1	ASL16-30-01S-81	1SBL123004R8101	0.280
				48	1 0	ASL16-30-10S-83	1SBL123004R8310	0.280				
					0 1	ASL16-30-01S-83	1SBL123004R8301	0.280				
				110	1 0	ASL16-30-10S-86	1SBL123004R8610	0.280				
					0 1	ASL16-30-01S-86	1SBL123004R8601	0.280				
				220	1 0	ASL16-30-10S-88	1SBL123004R8810	0.280				
					0 1	ASL16-30-01S-88	1SBL123004R8801	0.280				

Note: for multiple packaging, please contact your ABB local sales organization.

(1) Other control voltages see voltage code table.

#### Main dimensions mm, inches

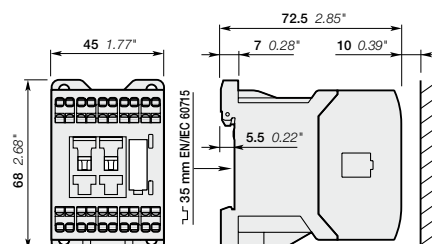

ASL09..S, ASL12..S, ASL16..S

# AS09..S ... AS16..S 2-stack 3-pole contactors

## 4 to 7.5 kW

### AC operated - with spring terminals



AS09-30-32S

#### Description

AS09..S ... AS16..S contactors are mainly used for controlling 3-phase motors and power circuits up to 690 V AC and 220 V DC.

These contactors are of the block type design with:

- spring terminals
- 1st stack with 3 main poles and 1 N.O. built-in auxiliary contact
- 2nd stack with permanently fixed 2 N.O. + 2 N.C. auxiliary contact block
- the auxiliary contact elements are mechanically linked (side-marked symbol) and the N.C. auxiliary contacts are mirror contacts
- control circuit: AC operated
- a comprehensive range of accessories.

#### Ordering details

IEC Rated operational power 400 V AC-3 kW	UL/CSA 3-phase motor rating 480 V AC-1 hp	General use rating 600 V AC A	Rated control circuit voltage Uc (1)		Auxiliary contacts fitted I L	Type	Order code	Weight Pkg (1 pce) kg	
			V 50 Hz	V 60 Hz					
4	20	5	12	24	24	3 2	AS09-30-32S-20	1SBL101004R2032	0.260
				-	120	3 2	AS09-30-32S-16	1SBL101004R1632	0.260
				230	230	3 2	AS09-30-32S-26	1SBL101004R2632	0.260
				400	400	3 2	AS09-30-32S-28	1SBL101004R2832	0.260
5.5	22	7.5	12	24	24	3 2	AS12-30-32S-20	1SBL111004R2032	0.260
				-	120	3 2	AS12-30-32S-16	1SBL111004R1632	0.260
				230	230	3 2	AS12-30-32S-26	1SBL111004R2632	0.260
				400	400	3 2	AS12-30-32S-28	1SBL111004R2832	0.260
7.5	22	10	15.2	24	24	3 2	AS16-30-32S-20	1SBL121004R2032	0.260
				-	120	3 2	AS16-30-32S-16	1SBL121004R1632	0.260
				230	230	3 2	AS16-30-32S-26	1SBL121004R2632	0.260
				400	400	3 2	AS16-30-32S-28	1SBL121004R2832	0.260

Note: for multiple packaging, please contact your ABB local sales organization.

(1) Other control voltages see voltage code table.

#### Main dimensions mm, inches

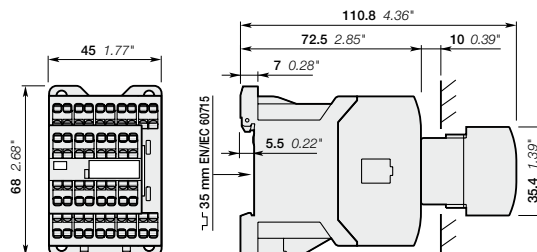

AS09..S, AS12..S, AS16..S

1SBC101456S0201

# ASL09..S ... ASL16..S 2-stack 3-pole contactors

## 4 to 7.5 kW

### DC operated - with spring terminals



ASL09-30-32S

#### Description

ASL09..S ... ASL16..S contactors are mainly used for controlling 3-phase motors and power circuits up to 690 V AC and 220 V DC.

These contactors are of the block type design with:

- spring terminals
- 1st stack with 3 main poles and 1 N.O. built-in auxiliary contact
- 2nd stack with permanently fixed 2 N.O. + 2 N.C. auxiliary contact block
- the auxiliary contact elements are mechanically linked (side-marked symbol) and the N.C. auxiliary contacts are mirror contacts
- control circuit: low consumption (3 W at pull-in and holding) DC operated with solid core magnet. Suitable for direct control by PLC outputs (the polarity on the coil terminals A1+ and A2- must be respected)
- a comprehensive range of accessories.

#### Ordering details

IEC		UL/CSA		Rated control circuit voltage Uc (1)	Auxiliary contacts fitted	Type	Order code	Weight
Rated power kW	operational current θ ≤ 40 °C A	3-phase motor rating 480 V hp	General use rating 600 V AC A					
4	20	5	12	24	3 2	ASL09-30-32S-81	1SBL103004R8132	0.320
				48	3 2	ASL09-30-32S-83	1SBL103004R8332	0.320
				110	3 2	ASL09-30-32S-86	1SBL103004R8632	0.320
				220	3 2	ASL09-30-32S-88	1SBL103004R8832	0.320
5.5	22	7.5	12	24	3 2	ASL12-30-32S-81	1SBL113004R8132	0.320
				48	3 2	ASL12-30-32S-83	1SBL113004R8332	0.320
				110	3 2	ASL12-30-32S-86	1SBL113004R8632	0.320
				220	3 2	ASL12-30-32S-88	1SBL113004R8832	0.320
7.5	22	10	15.2	24	3 2	ASL16-30-32S-81	1SBL123004R8132	0.320
				48	3 2	ASL16-30-32S-83	1SBL123004R8332	0.320
				110	3 2	ASL16-30-32S-86	1SBL123004R8632	0.320
				220	3 2	ASL16-30-32S-88	1SBL123004R8832	0.320

Note: for multiple packaging, please contact your ABB local sales organization.  
(1) Other control voltages see voltage code table.

#### Main dimensions mm, inches

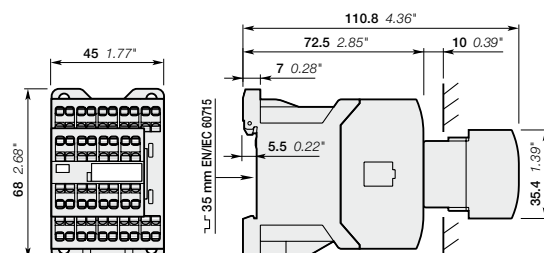

ASL09..S, ASL12..S, ASL16..S

# AS09..S ... AS16..S and ASL09..S ... ASL16..S 3-pole contactors - with spring terminals Main accessories

Contactor and main accessories (other accessories available)

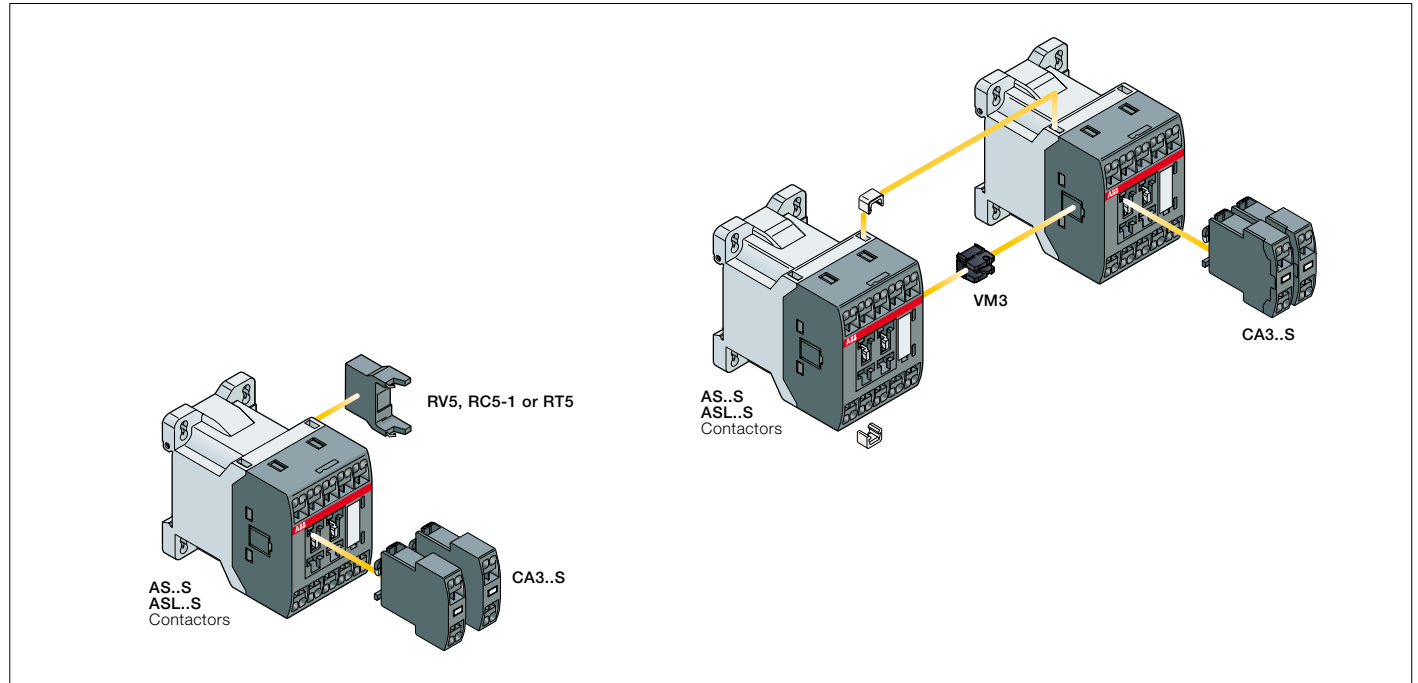

6

## Main accessory fitting details

Contactor types	Main poles	Built-in auxiliary contacts	Front-mounted accessories		Side-mounted accessories		
			Auxiliary contact blocks	Mechanical interlock unit (between 2 contactors)	Surge suppressors		
AS09..S ... AS16..S	3 0	1 0	1-pole CA3..S	VM3	+	RV5 or RC5-1	
AS09..S ... AS16..S	3 0	0 1	2 max.	+	1	+	RV5 or RC5-1
AS09..S ... AS16..S	3 0	3 2	-	1	+	RV5 or RT5	
ASL09..S ... ASL16..S	3 0	1 0	2 max.	+	1	+	RV5 or RT5
ASL09..S ... ASL16..S	3 0	0 1	-	1	+	RV5 or RT5	
ASL09..S ... ASL16..S	3 0	3 2	-	1	+	RV5 or RT5	



# AS09..S ... AS16..S and ASL09..S ... ASL16..S 3-pole contactors - with spring terminals

## Main accessories



CA3-10S

1SBC101037F0014

### Front-mounted instantaneous auxiliary contact blocks

For contactors	Auxiliary contacts	Type	Order code	Pkg qty	Weight (1 pce)
					kg
AS09..S ... AS16..S	1 0	CA3-10S	1SBN011019T1010	10	0.011
ASL09..S ... ASL16..S	0 1	CA3-01S	1SBN011019T1001	10	0.011



VM3

1SBC101069F0014

### Mechanical interlock unit

For contactors	Type	Order code	Pkg qty	Weight (1 pce)
AS09..S ... AS16..S, ASL09..S ... ASL16..S	VM3	1SBN031005T1000	10	0.002



RV5

1SBC574001F0301

### Surge suppressors

For contactors	Rated control circuit voltage - U <sub>c</sub>			Type	Order code	Pkg qty	Weight (1 pce)
	V	AC	DC				
AS09..S ... AS16..S, ASL09..S ... ASL16..S	24...50	●	●	RV5/50	1SBN050010R1000	2	0.015
	50...133	●	●	RV5/133	1SBN050010R1001	2	0.015
	110...250	●	●	RV5/250	1SBN050010R1002	2	0.015
	250...440	●	●	RV5/440	1SBN050010R1003	2	0.015
AS09..S ... AS16..S	24...50	●	-	RC5-1/50	1SBN050100R1000	2	0.012
	50...133	●	-	RC5-1/133	1SBN050100R1001	2	0.012
	110...250	●	-	RC5-1/250	1SBN050100R1002	2	0.012
	250...440	●	-	RC5-1/440	1SBN050100R1003	2	0.012
ASL09..S ... ASL16..S	12...32	-	●	RT5/32	1SBN050020R1000	2	0.015
	25...65	-	●	RT5/65	1SBN050020R1001	2	0.015
	50...90	-	●	RT5/90	1SBN050020R1002	2	0.015
	77...150	-	●	RT5/150	1SBN050020R1003	2	0.015
	150...264	-	●	RT5/264	1SBN050020R1004	2	0.015



BEA16-3U

1SBC101384F0010

### Connecting links with manual motor starters

For contactors	Manual motor starter	Type	Order code	Pkg qty	Weight (1 pce)
AS09..S ... AS16..S ASL09..S ... ASL16..S	MS116-0.16 ... MS116-16 MS132-0.16 ... MS132-16	BEA16-3U	1SBN081020R1000	1	0.045

# AS09..S ... AS16..S and ASL09..S ... ASL16..S 3-pole contactors - with spring terminals

## Technical data

### Main pole - Utilization characteristics according to IEC

Contractor types	AC operated	AS09..S	AS12..S	AS16..S
	DC operated	ASL09..S	ASL12..S	ASL16..S
<b>Standards</b>		IEC 60947-1 / 60947-4-1 and EN 60947-1 / 60947-4-1		
<b>Rated operational voltage U<sub>e</sub> max.</b>		690 V		
<b>Rated frequency (without derating)</b>		50 / 60 Hz		
<b>Conventional free-air thermal current I<sub>th</sub></b>				
acc. to IEC 60947-4-1, open contactors, $\theta \leq 40$ °C		20 A	22 A	22 A
With conductor cross-sectional area		2.5 mm <sup>2</sup>	2.5 mm <sup>2</sup>	2.5 mm <sup>2</sup>
<b>AC-1 Utilization category</b>				
For air temperature close to contactor				
<b>I<sub>e</sub> / Rated operational current AC-1</b>	$\theta \leq 40$ °C	20 A	22 A	22 A
U <sub>e</sub> max. $\leq$ 690 V, 50/60 Hz	$\theta \leq 60$ °C	15 A	17 A	17 A
	$\theta \leq 70$ °C	12 A	14 A	14 A
With conductor cross-sectional area		2.5 mm <sup>2</sup>		
<b>AC-3 Utilization category</b>				
For air temperature close to contactor $\theta \leq 60$ °C				
<b>I<sub>e</sub> / Max. rated operational current AC-3 (1)</b>				
	220-230-240 V	9 A	12 A	15.7 A
	400 V	9 A	12 A	15.5 A
	415 V	9 A	12 A	15.5 A
	440 V	8 A	11 A	13.6 A
	500 V	8 A	11 A	12.5 A
	690 V	5 A	7 A	9 A
<b>Rated operational power AC-3 (1)</b>				
	220-230-240 V	2.2 kW	3 kW	4 kW
	400 V	4 kW	5.5 kW	7.5 kW
	415 V	4 kW	5.5 kW	7.5 kW
	440 V	4 kW	5.5 kW	7.5 kW
	500 V	4 kW	5.5 kW	7.5 kW
	690 V	4 kW	5.5 kW	7.5 kW
<b>Rated making capacity AC-3</b>		10 x I <sub>e</sub> AC-3 acc. to IEC 60947-4-1		
<b>Rated breaking capacity AC-3</b>		8 x I <sub>e</sub> AC-3 acc. to IEC 60947-4-1		
<b>AC-8a Utilization category</b>				
(without thermal overload relay - U <sub>e</sub> 400 V 50/60 Hz - $\theta \leq 40$ °C)				
<b>I<sub>e</sub> / Rated operational current AC-8a</b>		12 A	16 A	22 A
<b>Rated operational power AC-8a</b>		5.5 kW	7.5 kW	11 kW
<b>Short-circuit protection device for contactors</b>				
without thermal overload relay - Motor protection excluded (2)				
U <sub>e</sub> $\leq$ 500 V AC - gG type fuse		25 A		
<b>Rated short-time withstand current I<sub>cw</sub></b>				
at 40 °C ambient temperature,	1 s	230 A	250 A	250 A
in free air from a cold state	10 s	100 A	124 A	124 A
	30 s	65 A	75 A	75 A
	1 min	50 A	55 A	55 A
	15 min	20 A	22 A	22 A
<b>Maximum breaking capacity</b>				
cos $\phi$ = 0.45	at 440 V	155 A		
	at 690 V	90 A		
<b>Power dissipation per pole</b>				
	I <sub>e</sub> / AC-1	0.9 W	1.1 W	1.1 W
	I <sub>e</sub> / AC-3	0.18 W	0.33 W	0.55 W
<b>Max. electrical switching frequency</b>				
	AC-1	600 cycles/h		
	AC-3	1200 cycles/h		
	AC-4	300 cycles/h		

(1) For the corresponding kW/A or hp/A values of 1500 r.p.m, 50 Hz or 1800 r.p.m, 60 Hz, 3-phase motors, see "Motor rated operational powers and currents".

(2) For the protection of motor starters against short circuits, see "Coordination with short-circuit protection devices".

# AS09..S ... AS16..S and ASL09..S ... ASL16..S 3-pole contactors - with spring terminals

## Technical data

### Main pole - Utilization characteristics according to UL / NEMA / CSA

Contactor types	AC operated	AS09..S	AS12..S	AS16..S
	DC operated	ASL09..S	ASL12..S	ASL16..S
Standards	UL 508, CSA C22.2 N°14			
Max. operational voltage	690 V			
NEMA size	00		00	00
NEMA continuous amp rating	Thermal current	9 A		
NEMA maximum horse power ratings 1-phase, 60 Hz	115 V AC	1/3 hp	1/3 hp	1/3 hp
	230 V AC	1 hp	1 hp	1 hp
NEMA maximum horse power ratings 3-phase, 60 Hz	200 V AC	1-1/2 hp	1-1/2 hp	1-1/2 hp
	230 V AC	1-1/2 hp	1-1/2 hp	1-1/2 hp
	460 V AC	2 hp	2 hp	2 hp
	575 V AC	2 hp	2 hp	2 hp
UL / CSA General use rating	600 V AC	12 A	12 A	15.2 A
	With conductor cross-sectional area	AWG 14	AWG 14	AWG 12
UL / CSA maximum 1-phase motor rating	Full load current	120 V AC	7.2 A	9.8 A
		240 V AC	8 A	10 A
	Horse power rating	120 V AC	1/3 hp	1/2 hp
		240 V AC	1 hp	1-1/2 hp
UL / CSA maximum 3-phase motor rating	Full load current (1)	200-208 V AC	7.8 A	7.8 A
		220-240 V AC	6.8 A	9.6 A
		440-480 V AC	7.6 A	11 A
		550-600 V AC	9 A	11 A
	Horse power rating (1)	200-208 V AC	2 hp	2 hp
		220-240 V AC	2 hp	3 hp
		440-480 V AC	5 hp	7-1/2 hp
		550-600 V AC	7-1/2 hp	10 hp
Short-circuit protection device for contactors without thermal overload relay - Motor protection excluded	Fuse rating	40 A	50 A	60 A
	Fuse type, 600 V	J		
	Max. electrical switching frequency	For general use	600 cycles/h	
For motor use		1200 cycles/h		

(1) For the corresponding kW/A or hp/A values of 1500 r.p.m, 50 Hz or 1800 r.p.m, 60 Hz, 3-phase motors, see "Motor rated operational powers and currents".

### General technical data

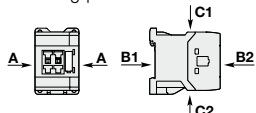
Contactor types	AC operated	AS09..S	AS12..S	AS16..S
	DC operated	ASL09..S	ASL12..S	ASL16..S
Rated insulation voltage Ui	acc. to IEC 60947-4-1	690 V		
	acc. to UL / CSA	600 V		
Rated impulse withstand voltage Uimp.	6 kV			
Ambient air temperature close to contactor	Operation	-40...+70 °C		
	Storage	-60...+80 °C		
Climatic withstand	Category B according to IEC 60947-1 Annex Q			
Maximum operating altitude (without derating)	3000 m			
Mechanical durability	Number of operating cycles	10 millions operating cycles		
	Max. switching frequency	3600 cycles/h		
Shock withstand acc. to IEC 60068-2-27 and EN 60068-2-27	1/2 sinusoidal shock for 11 ms: no change in contact position, closed or open position			
	Shock direction	AS contactors - AC operated		ASL contactors - DC operated
Mounting position 1 	A	20 g		20 g closed position / 10 g open position
	B1	10 g closed position / 5 g open position		15 g closed position / 5 g open position
	B2	15 g		10 g
	C1	20 g closed position / 9 g open position		15 g closed position / 8 g open position
	C2	20 g closed position / 14 g open position		14 g closed position / 8 g open position
	Vibration withstand acc. to IEC 60068-2-6	5...300 Hz / 3 g closed position / 2 g open position		

# AS09..S ... AS16..S and ASL09..S ... ASL16..S 3-pole contactors - with spring terminals

## Technical data

### Magnet system characteristics for AS09..S ... AS16..S contactors

Contactor types	AC operated	AS09..S	AS12..S	AS16..S
<b>Coil operating limits</b>	AC supply	0.85...1.1 x U <sub>c</sub> (at $\theta \leq 60$ °C); U <sub>c</sub> (at $\theta \leq 70$ °C)		
acc. to IEC 60947-4-1	Rated control circuit voltage U <sub>c</sub>	at 50 Hz	24...415 V	
		at 60 Hz	24...415 V	
Coil consumption	Average pull-in value	50 Hz	33 VA	
		60 Hz	33 VA	
		50/60 Hz	33 VA	
	Average holding value	50 Hz	6.5 VA / 1.5 W	
		60 Hz	5 VA / 1.2 W	
		50/60 Hz	6.5 VA / 1.5 W	
<b>Drop-out voltage</b>		Approx. 30...50 % of U <sub>c</sub>		
<b>Operating time</b>				
Between coil energization and:	N.O. contact closing	9...24 ms		
	N.C. contact opening	6...18 ms		
Between coil de-energization and:	N.O. contact opening (1)	5...19 ms		
	N.C. contact closing (1)	7...22 ms		
(1) The use of RC5-1 surge suppressor increases opening time by a factor of 2 to 3.				

6

### Magnet system characteristics for ASL09..S ... ASL16..S contactors

Contactor types	DC operated	ASL09..S	ASL12..S	ASL16..S
<b>Coil operating limits</b>	DC supply	0.85...1.1 x U <sub>c</sub> (at $\theta \leq 60$ °C); U <sub>c</sub> (at $\theta \leq 70$ °C)		
acc. to IEC 60947-4-1	Rated control circuit voltage U <sub>c</sub>	12...240 V DC		
Coil consumption	Average pull-in value	3 W		
	Average holding value	3 W		
<b>Drop-out voltage</b>		Approx. 10...40 % of U <sub>c</sub>		
Coil time constant	Open	L/R	12 ms	
	Closed	L/R	40 ms	
<b>Operating time</b>				
Between coil energization and:	N.O. contact closing	36...59 ms		
	N.C. contact opening	31...53 ms		
Between coil de-energization and:	N.O. contact opening (1)	13...17 ms		
	N.C. contact closing (1)	15...20 ms		
(1) The use of RT5 surge suppressor increases opening time by a factor of 1.1 to 1.2				







### Mounting characteristics and conditions for use

Contactor types	AC operated	AS09..S	AS12..S	AS16..S
	DC operated	ASL09..S	ASL12..S	ASL16..S
<b>Mounting positions</b>				
<b>Mounting distances</b>	The contactors can be assembled side by side.			
Fixing	On rail according to IEC 60715, EN 60715	35 x 7.5 mm or 35 x 15 mm		
	By screws (not supplied)	2 x M4 screws placed diagonally		

# AS09..S ... AS16..S and ASL09..S ... ASL16..S 3-pole contactors - with spring terminals

## Technical data

### Connecting characteristics

Contactor types	AC operated	AS09..S	AS12..S	AS16..S
	DC operated	ASL09..S	ASL12..S	ASL16..S
Main terminals	 Spring terminals			
<b>Connection capacity (min. ... max.)</b>				
<b>Main conductors (poles)</b>				
 Rigid	1 x	0.75...2.5 mm <sup>2</sup>		
	2 x	0.75...2.5 mm <sup>2</sup>		
 Flexible with non insulated ferrule	1 x	0.75...2.5 mm <sup>2</sup>		
	2 x	0.75...2.5 mm <sup>2</sup>		
 Flexible with insulated ferrule	1 x	0.75...1.5 mm <sup>2</sup>		
	2 x	0.75...1.5 mm <sup>2</sup>		
Connection capacity acc. to UL / CSA	1 or 2 x	AWG 18...12		
Stripping length	10 mm			
<b>Auxiliary conductors</b> (built-in auxiliary terminals + coil terminals)				
 Rigid solid	1 x	0.75...2.5 mm <sup>2</sup>		
	2 x	0.75...2.5 mm <sup>2</sup>		
 Flexible with non insulated ferrule	1 x	0.75...2.5 mm <sup>2</sup>		
	2 x	0.75...2.5 mm <sup>2</sup>		
 Flexible with insulated ferrule	1 x	0.75...1.5 mm <sup>2</sup>		
	2 x	0.75...1.5 mm <sup>2</sup>		
Connection capacity acc. to UL / CSA	1 or 2 x	AWG 18...14		
Stripping length	10 mm			
<b>Degree of protection</b>				
acc. to IEC 60947-1 / EN 60947-1 and IEC 60529 / EN 60529				
All terminals	IP20			
Screwdriver type	Flat Ø 3.5			

# AS09..S ... AS16..S and ASL09..S ... ASL16..S 3-pole contactors - with spring terminals

## Technical data

### Built-in auxiliary contacts according to IEC

Contactor types	AC operated	AS09..S	AS12..S	AS16..S
	DC operated	ASL09..S	ASL12..S	ASL16..S
Rated operational voltage U <sub>e</sub> max.	690 V			
Rated frequency (without derating)	50 / 60 Hz			
Conventional free air thermal current I <sub>th</sub> - 0 ≤ 40 °C	10 A			
I <sub>e</sub> / Rated operational current AC-15				
acc. to IEC 60947-5-1	24-127 V 50/60 Hz	6 A		
	220-240 V 50/60 Hz	4 A		
	400-440 V 50/60 Hz	3 A		
	500 V 50/60 Hz	2 A		
	690 V 50/60 Hz	2 A		
Making capacity AC-15	10 x I <sub>e</sub> AC-15 acc. to IEC 60947-5-1			
Breaking capacity AC-15	10 x I <sub>e</sub> AC-15 acc. to IEC 60947-5-1			
I <sub>e</sub> / Rated operational current DC-13				
acc. to IEC 60947-5-1	24 V DC	6 A / 144 W		
	48 V DC	2.8 A / 134 W		
	72 V DC	1 A / 72 W		
	110 V DC	0.55 A / 60 W		
	125 V DC	0.55 A / 69 W		
	220 V DC	0.27 A / 60 W		
	250 V DC	0.27 A / 68 W		
Short-circuit protection device gG type fuse	10 A			
Rated short-time withstand current I <sub>cw</sub>	for 1.0 s	100 A		
	for 0.1 s	140 A		
Minimum switching capacity	12 V / 3 m			
with failure rate acc. to IEC 60947-5-4	10 <sup>-7</sup>			
Non-overlapping time between N.O. and N.C. contacts	1.5 ms			
Power dissipation per pole at 6 A	0.1 W			
Max. electrical switching frequency	AC-15	1200 cycles/h		
	DC-13	900 cycles/h		
Mechanically linked contacts	Built-in N.O. or N.C. auxiliary contacts and additional N.O. or N.C. auxiliary contacts (CA3 aux. contact blocks) are mechanically linked contacts.			
acc. to annex L of IEC 60947-5-1				
Mirror contacts	Built-in N.C. auxiliary contacts or additional N.C. auxiliary contacts (CA3 aux. contact blocks) are mirror contacts.			
acc. to annex F of IEC 60947-4-1				

### Built-in auxiliary contacts according to UL / CSA

Contactor types	AC operated	AS09..S	AS12..S	AS16..S
	DC operated	ASL09..S	ASL12..S	ASL16..S
Max. operational voltage	600 V AC, 250 V DC			
Pilot duty	A600, Q300			
AC thermal rated current	10 A			
AC maximum volt-ampere making	7200 VA			
AC maximum volt-ampere breaking	720 VA			
DC thermal rated current	2.5 A			
DC maximum volt-ampere making-breaking	69 VA			

# Notes

A series of horizontal dotted lines for taking notes.

# AS09..S ... AS16..S 3-pole contactors - with spring terminals

## Terminal marking and positioning

### AS..S contactors - AC operated

Standard devices without addition of auxiliary contacts

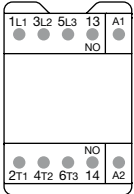

AS09 ... AS16-30-10S

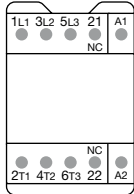

AS09 ... AS16-30-01S

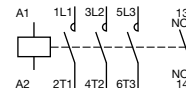

AS09 ... AS16-30-10S

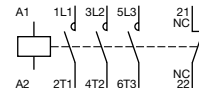

AS09 ... AS16-30-01S

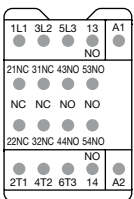

AS09 ... AS16-30-32S

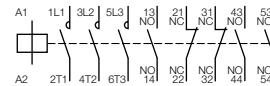

AS09 ... AS16-30-32S

6

Other possible contact combinations with auxiliary contact blocks added by the user

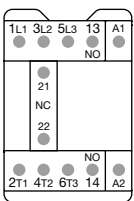

Combination 11

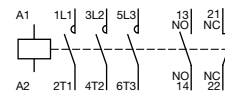
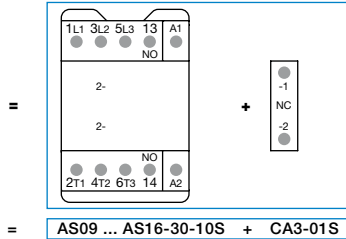

Combination 11

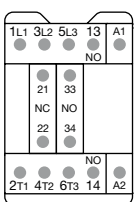

Combination 21

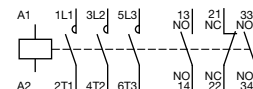
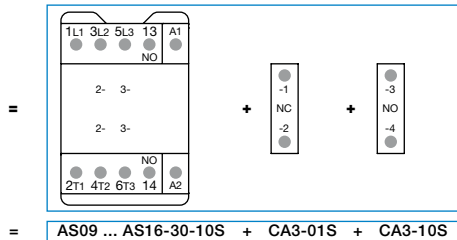

Combination 21

CA3..S 1-pole auxiliary contact blocks



CA3-10S

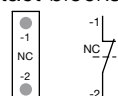

CA3-01S



# ASL09..S ... ASL16..S 3-pole contactors - with spring terminals

## Terminal marking and positioning

### ASL..S contactors - DC operated (the polarity A1+, A2- must be respected)

Standard devices without addition of auxiliary contacts

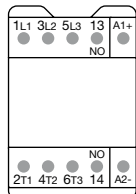

ASL09 ... ASL16-30-10S

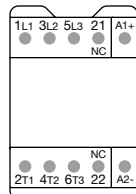

ASL09 ... ASL16-30-01S

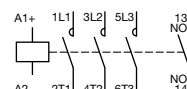

ASL09 ... ASL16-30-10S

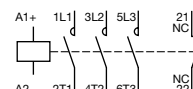

ASL09 ... ASL16-30-01S

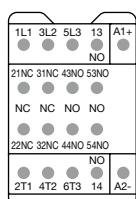

ASL09 ... ASL16-30-32

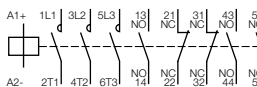

ASL09 ... ASL16-30-32S

Other possible contact combinations with auxiliary contact blocks added by the user

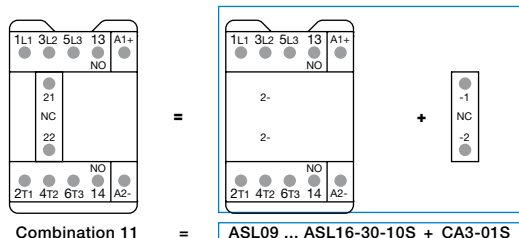

Combination 11

ASL09 ... ASL16-30-10S + CA3-01S

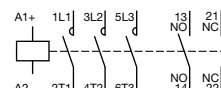

Combination 11

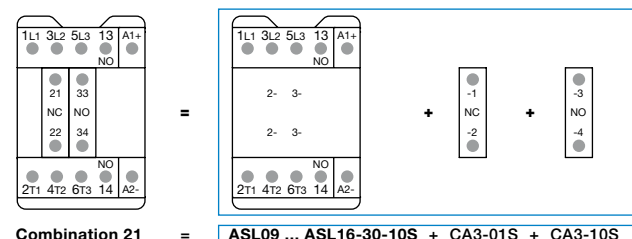

Combination 21

ASL09 ... ASL16-30-10S + CA3-01S + CA3-10S

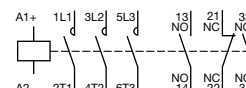

Combination 21

CA3..S 1-pole auxiliary contact blocks

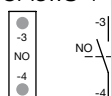

CA3-10S

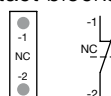

CA3-01S

# AS09..S ... AS16..S 3-pole contactors - with spring terminals

## Main dimensions mm, inches

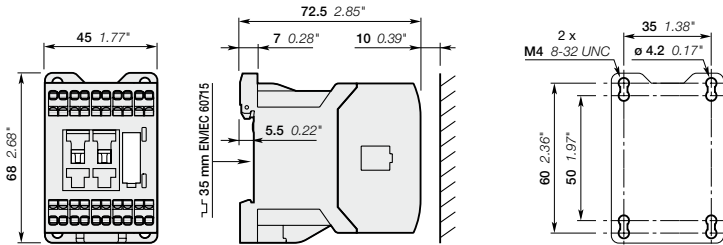

AS09..S, AS12..S, AS16..S

6

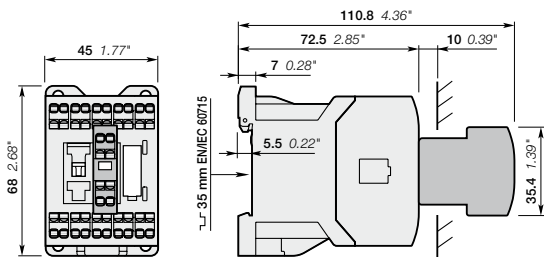

AS09..S, AS12..S, AS16..S  
+ CA3..S front-mounted 1-pole auxiliary contact block

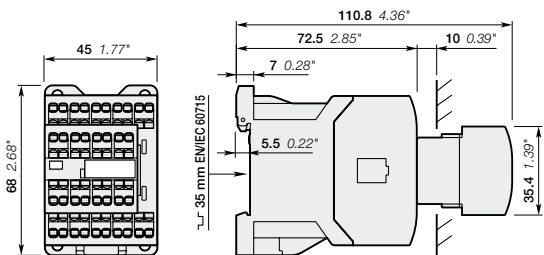

AS09...16-30-32S

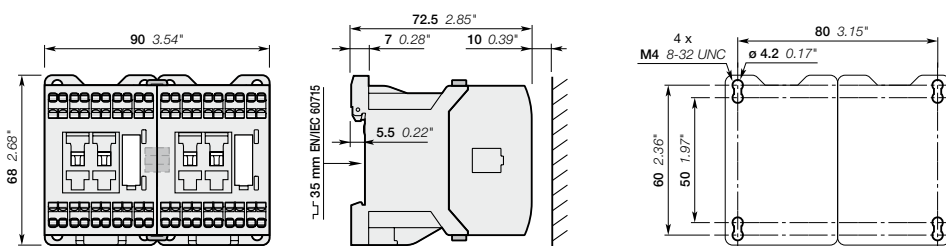

AS09..S, AS12..S, AS16..S  
+ VM3 mechanical interlock unit including two BB3 fixing clips

# ASL09..S ... ASL16..S 3-pole contactors - with spring terminals

## Main dimensions mm, inches

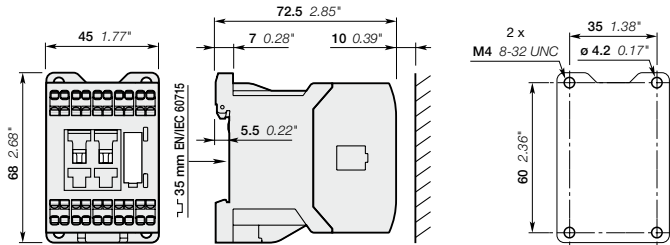

ASL09..S, ASL12..S, ASL16..S

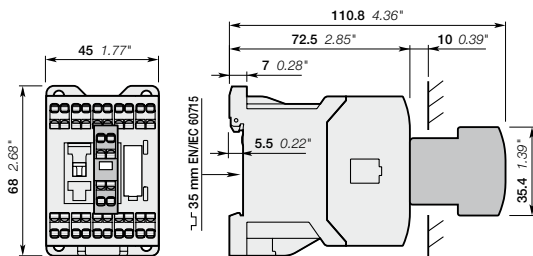

ASL09..S, ASL12..S, ASL16..S  
+ CA3..S front-mounted 1-pole auxiliary contact block

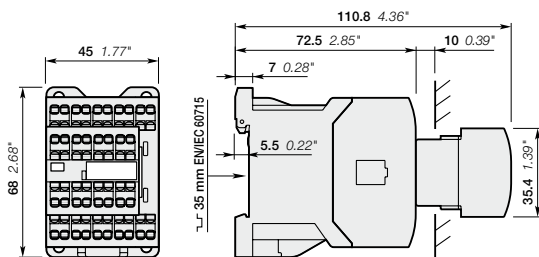

ASL09...16-30-32S

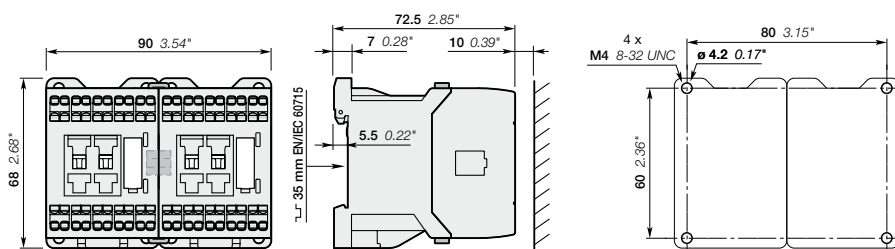

ASL09..S, ASL12..S, ASL16..S  
+ VM3 mechanical interlock unit including two BB3 fixing clips

# NS..S contactor relays - with spring terminals AC operated



NS22ES

1SBC101015F0014

## Description

NS..S contactor relays are used for switching auxiliary and control circuits.

These contactor relays are designed with:

- spring terminals
- 4 poles or 8 poles. Contactor relays have mechanically linked auxiliary contact elements (side-marked symbol)
- control circuit: AC operated
- add-on auxiliary contact blocks for front mounting and a comprehensive range of accessories.

## Ordering details

Number of contacts 1st stack	2nd stack	Rated control circuit voltage Uc (1)		Type	Order code	Weight  Pkg (1 pce) kg
		V 50 Hz	V 60 Hz			
		24	24	NS22ES-20	1SBH101004R2022	0.220
		-	120	NS22ES-16	1SBH101004R1622	0.220
		230	230	NS22ES-26	1SBH101004R2622	0.220
		400	400	NS22ES-28	1SBH101004R2822	0.220
		24	24	NS31ES-20	1SBH101004R2031	0.220
		-	120	NS31ES-16	1SBH101004R1631	0.220
		230	230	NS31ES-26	1SBH101004R2631	0.220
		400	400	NS31ES-28	1SBH101004R2831	0.220
		24	24	NS40ES-20	1SBH101004R2040	0.220
		-	120	NS40ES-16	1SBH101004R1640	0.220
		230	230	NS40ES-26	1SBH101004R2640	0.220
		400	400	NS40ES-28	1SBH101004R2840	0.220
		24	24	NS44ES-20	1SBH101004R2044	0.260
		-	120	NS44ES-16	1SBH101004R1644	0.260
		230	230	NS44ES-26	1SBH101004R2644	0.260
		400	400	NS44ES-28	1SBH101004R2844	0.260
		24	24	NS53ES-20	1SBH101004R2053	0.260
		-	120	NS53ES-16	1SBH101004R1653	0.260
		230	230	NS53ES-26	1SBH101004R2653	0.260
		400	400	NS53ES-28	1SBH101004R2853	0.260
		24	24	NS62ES-20	1SBH101004R2062	0.260
		-	120	NS62ES-16	1SBH101004R1662	0.260
		230	230	NS62ES-26	1SBH101004R2662	0.260
		400	400	NS62ES-28	1SBH101004R2862	0.260
		24	24	NS71ES-20	1SBH101004R2071	0.260
		-	120	NS71ES-16	1SBH101004R1671	0.260
		230	230	NS71ES-26	1SBH101004R2671	0.260
		400	400	NS71ES-28	1SBH101004R2871	0.260
		24	24	NS80ES-20	1SBH101004R2080	0.260
		-	120	NS80ES-16	1SBH101004R1680	0.260
		230	230	NS80ES-26	1SBH101004R2680	0.260
		400	400	NS80ES-28	1SBH101004R2880	0.260

Note: for multiple packaging, please contact your ABB local sales organization.

(1) Other control voltages see voltage code table.

## Main dimensions mm, inches

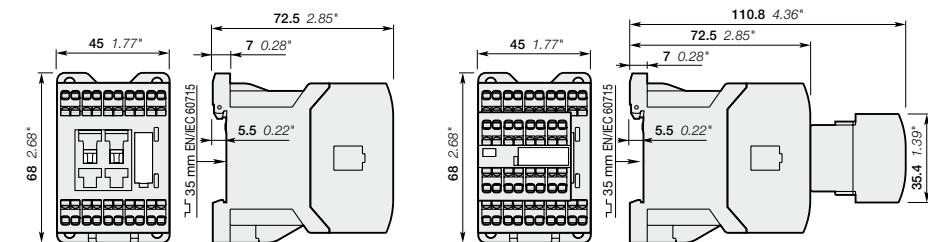

NS22ES, NS31ES, NS40ES

NS44ES, NS53ES, NS62ES, NS71ES, NS80ES

# NSL..S contactor relays - with spring terminals

## DC operated



NSL22ES

### Description

NSL..S contactor relays are used for switching auxiliary and control circuits.

These contactor relays are designed with:

- spring terminals
- 4 poles or 8 poles. Contactor relays have mechanically linked auxiliary contact elements (side-marked symbol)
- control circuit: low coil consumption (3 W at pull-in and holding) DC operated with solid core magnet. Suitable for direct control by PLC outputs (the polarity on the coil terminals A1+ and A2- must be respected)
- add-on auxiliary contact blocks for front mounting and a comprehensive range of accessories.

### Ordering details

Number of contacts		Rated control circuit voltage Uc (1) V DC	Type	Order code	Weight Pkg (1 pce) kg
1st stack	2nd stack				
		24	NSL22ES-81	1SBH103004R8122	0.280
		48	NSL22ES-83	1SBH103004R8322	0.280
		110	NSL22ES-86	1SBH103004R8622	0.280
		220	NSL22ES-88	1SBH103004R8822	0.280
		24	NSL31ES-81	1SBH103004R8131	0.280
		48	NSL31ES-83	1SBH103004R8331	0.280
		110	NSL31ES-86	1SBH103004R8631	0.280
		220	NSL31ES-88	1SBH103004R8831	0.280
		24	NSL40ES-81	1SBH103004R8140	0.280
		48	NSL40ES-83	1SBH103004R8340	0.280
		110	NSL40ES-86	1SBH103004R8640	0.280
		220	NSL40ES-88	1SBH103004R8840	0.280
		24	NSL44ES-81	1SBH103004R8144	0.320
		48	NSL44ES-83	1SBH103004R8344	0.320
		110	NSL44ES-86	1SBH103004R8644	0.320
		220	NSL44ES-88	1SBH103004R8844	0.320
		24	NSL53ES-81	1SBH103004R8153	0.320
		48	NSL53ES-83	1SBH103004R8353	0.320
		110	NSL53ES-86	1SBH103004R8653	0.320
		220	NSL53ES-88	1SBH103004R8853	0.320
		24	NSL62ES-81	1SBH103004R8162	0.320
		48	NSL62ES-83	1SBH103004R8362	0.320
		110	NSL62ES-86	1SBH103004R8662	0.320
		220	NSL62ES-88	1SBH103004R8862	0.320
		24	NSL71ES-81	1SBH103004R8171	0.320
		48	NSL71ES-83	1SBH103004R8371	0.320
		110	NSL71ES-86	1SBH103004R8671	0.320
		220	NSL71ES-88	1SBH103004R8871	0.320
		24	NSL80ES-81	1SBH103004R8180	0.320
		48	NSL80ES-83	1SBH103004R8380	0.320
		110	NSL80ES-86	1SBH103004R8680	0.320
		220	NSL80ES-88	1SBH103004R8880	0.320

Note: for multiple packaging, please contact your ABB local sales organization.

(1) Other control voltages see voltage code table.

### Main dimensions mm, inches

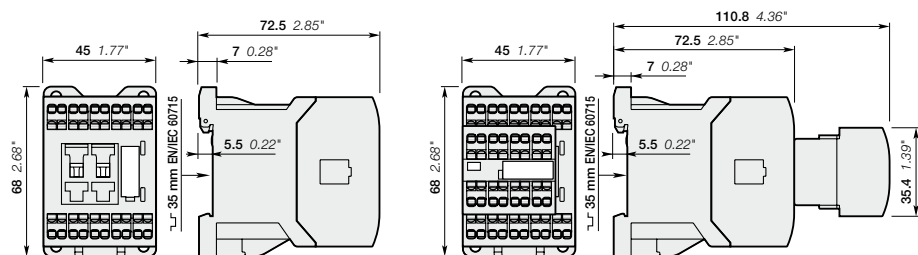

NSL22ES, NSL31ES, NSL40ES

NSL44ES, NSL53ES, NSL62ES, NSL71ES, NSL80ES

# NS..S and NSL..S contactor relays - with spring terminals

## Main accessories

### Contactor relays and main accessories

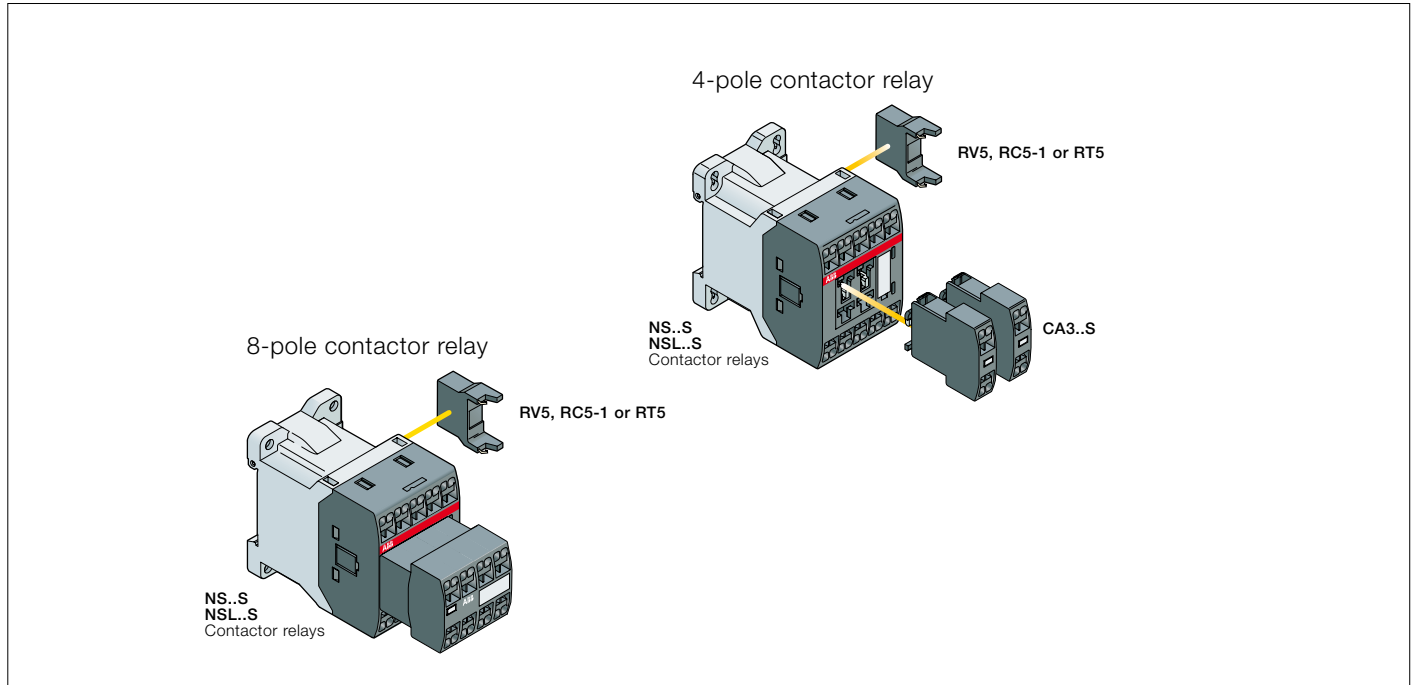

6

### Main accessory fitting details

Contactor types	Main poles	Front-mounted accessories		Side-mounted accessories	
		Auxiliary contact blocks		Surge suppressors	
		1-pole CA3..S			
NS..S	2 2 E	2 max.		+	RV5 or RC5-1
NS..S	3 1 E				
NS..S	4 0 E				
NS..S	4 4 E	-			RV5 or RC5-1
NS..S	5 3 E				
NS..S	6 2 E				
NS..S	7 1 E				
NS..S	8 0 E				
NSL..S	2 2 E	2 max.		+	RV5 or RT5
NSL..S	3 1 E				
NSL..S	4 0 E				
NSL..S	4 4 E	-			RV5 or RT5
NSL..S	5 3 E				
NSL..S	6 2 E				
NSL..S	7 1 E				
NSL..S	8 0 E				

# NS..S and NSL..S contactor relays - with spring terminals

## Main accessories



CA3-10S

1SBC1011037F0014

### Front mounted instantaneous auxiliary contact blocks

For contactor relays	Auxiliary contacts		Type	Order code	Pkg qty	Weight (1 pce) kg
	1	0				
NS..S, NSL..S	1	0	CA3-10S	1SBN011019T1010	10	0.011
	0	1	CA3-01S	1SBN011019T1001	10	0.011



RV5

1SBC574001F0301

### Surge suppressors

For contactor relays	Rated control circuit voltage - Uc			Type	Order code	Pkg qty	Weight (1 pce) kg
	V	AC	DC				
	NS..S, NSL..S	24...50	●				
	50...133	●	●	RV5/133	1SBN050010R1001	2	0.015
	110...250	●	●	RV5/250	1SBN050010R1002	2	0.015
	250...440	●	●	RV5/440	1SBN050010R1003	2	0.015
NS..S	24...50	●	-	RC5-1/50	1SBN050100R1000	2	0.012
	50...133	●	-	RC5-1/133	1SBN050100R1001	2	0.012
	110...250	●	-	RC5-1/250	1SBN050100R1002	2	0.012
	250...440	●	-	RC5-1/440	1SBN050100R1003	2	0.012
NSL..S	12...32	-	●	RT5/32	1SBN050020R1000	2	0.015
	25...65	-	●	RT5/65	1SBN050020R1001	2	0.015
	50...90	-	●	RT5/90	1SBN050020R1002	2	0.015
	77...150	-	●	RT5/150	1SBN050020R1003	2	0.015
	150...264	-	●	RT5/264	1SBN050020R1004	2	0.015

# NS..S and NSL..S contactor relays - with spring terminals

## Technical data

### Contact utilization characteristics according to IEC

Contactor relay types	AC operated	<b>NS..S</b>
	DC operated	<b>NSL..S</b>
Standards	IEC 60947-5-1 and EN 60947-5-1	
Rated operational voltage U <sub>e</sub> max.	690 V	
Rated frequency (without derating)	50 / 60 Hz	
Conventional free-air thermal current I <sub>th</sub> θ ≤ 40 °C	10 A	
I <sub>e</sub> / Rated operational current AC-15		
acc. to IEC 60947-5-1	24-127 V 50/60 Hz	6 A
	220-240 V 50/60 Hz	4 A
	400-440 V 50/60 Hz	3 A
	500 V 50/60 Hz	2 A
	690 V 50/60 Hz	2 A
Making capacity AC-15	10 x I <sub>e</sub> AC-15 acc. to IEC 60947-5-1	
Breaking capacity AC-15	10 x I <sub>e</sub> AC-15 acc. to IEC 60947-5-1	
I <sub>e</sub> / Rated operational current DC-13		
acc. to IEC 60947-5-1	24 V DC	6 A / 144 W
	48 V DC	2.8 A / 134 W
	72 V DC	1 A / 72 W
	110 V DC	0.55 A / 60 W
	125 V DC	0.55 A / 69 W
	220 V DC	0.27 A / 60 W
	250 V DC	0.27 A / 68 W
Short-circuit protection device for contactors		
U <sub>e</sub> ≤ 500 V AC - gG type fuse	10 A	
Rated short-time withstand current I <sub>cw</sub>	for 1.0 s	100 A
at 40 °C ambient temperature, in free air from a cold state	for 0.1 s	140 A
Minimum switching capacity	12 V / 3 mA	
with failure rate acc. to IEC 60947-5-4	10 <sup>-7</sup>	
Non-overlapping time between N.O. and N.C. contacts	1.5 ms	
Power dissipation per pole at 6 A	0.1 W	
Max. electrical switching frequency	AC-15	1200 cycles/h
	DC-13	900 cycles/h
Mechanically linked contacts	Built-in N.O. or N.C. auxiliary contacts and additional N.O. or N.C. auxiliary contacts (CA3..S aux. contact blocks) are mechanically linked contacts.	
acc. to annex L of IEC 60947-5-1		

### Contact utilization characteristics according to UL / CSA

Contactor relay types	AC operated	<b>NS..S</b>
	DC operated	<b>NSL..S</b>
Standards	UL 508, CSA C22.2 N°14	
Max. operational voltage	600 V AC, 250 V DC	
Pilot duty	A600, Q300	
AC thermal rated current	10 A	
AC maximum volt-ampere making	7200 VA	
AC maximum volt-ampere breaking	720 VA	
DC thermal rated current	2.5 A	
DC maximum volt-ampere making-breaking	69 VA	



# NS..S and NSL..S contactor relays - with spring terminals

## Technical data

### Magnet system characteristics for NS..S contactor relays

Contactor relay types	AC operated	NS..S	
Coil operating limits	AC supply		
acc. to IEC 60947-5-1		0.85...1.1 x U <sub>c</sub> (at $\theta \leq 60\text{ °C}$ ); U <sub>c</sub> (at $\theta \leq 70\text{ °C}$ )	
AC control voltage	Rated control circuit voltage U <sub>c</sub>	at 50 Hz	24...415 V
		at 60 Hz	24...415 V
Coil consumption	Average pull-in value	50 Hz	33 VA
		60 Hz	33 VA
		50/60 Hz	33 VA
	Average holding value	50 Hz	6.5 VA / 1.5 W
		60 Hz	5 VA / 1.2 W
		50/60 Hz	6.5 VA / 1.5 W
Drop-out voltage		Approx. 30...50 % of U <sub>c</sub>	
Operating time			
Between coil energization and:	N.O. contact closing	9...24 ms	
	N.C. contact opening	6...18 ms	
Between coil de-energization and:	N.O. contact opening (1)	5...19 ms	
	N.C. contact closing (1)	7...22 ms	
(1) The use of RC5-1 surge suppressor increases opening time by a factor of 2 to 3.			

### Magnet system characteristics for NSL..S contactor relays

Contactor relay types	DC operated	NSL..S	
Coil operating limits	DC supply		
acc. to IEC 60947-5-1		0.85...1.1 x U <sub>c</sub> (at $\theta \leq 60\text{ °C}$ ); U <sub>c</sub> (at $\theta \leq 70\text{ °C}$ )	
DC control voltage			
Rated control circuit voltage U <sub>c</sub>		12...240 V DC	
Coil consumption	Average pull-in value	3 W	
	Average holding value	3 W	
Drop-out voltage		Approx. 10...40 % of U <sub>c</sub>	
Coil time constant	Open	L/R	12 ms
	Closed	L/R	40 ms
Operating time			
Between coil energization and:	N.O. contact closing	36...59 ms	
	N.C. contact opening	31...53 ms	
Between coil de-energization and:	N.O. contact opening (1)	13...17 ms	
	N.C. contact closing (1)	15...20 ms	
(1) The use of RT5 surge suppressor increases opening time by a factor of 1.1 to 1.2.			

### Mounting characteristics and conditions for use

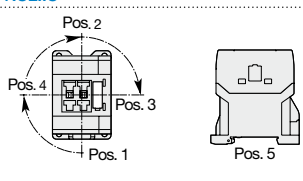
Contactor relay types	AC operated	NS..S
	DC operated	NSL..S
Mounting positions		
Mounting distances	The contactor relays can be assembled side by side.	
Fixing	On rail according to IEC 60715, EN 60715	35 x 7.5 mm or 35 x 15 mm
	By screws (not supplied)	2 x M4 screws placed diagonally

# NS..S and NSL..S contactor relays - with spring terminals

## Technical data

### General technical data

Contactor relay types	AC operated	<b>NS..S</b>
	DC operated	<b>NSL..S</b>
Rated insulation voltage $U_i$		
acc. to IEC 60947-5-1		690 V
acc. to UL / CSA		600 V
Rated impulse withstand voltage $U_{imp}$		6 kV
Ambient air temperature close to contactor relay		
Operation in free air		-40...+70 °C
Storage		-60...+80 °C
Climatic withstand		Category B according to IEC 60947-1 Annex Q
Maximum operating altitude (without derating)		3000 m
Mechanical durability		
Number of operating cycles		20 millions operating cycles
Max. switching frequency		3600 cycles/h
Shock withstand		1/2 sinusoidal shock for 11 ms: no change in contact position, closed or open position
acc. to IEC 60068-2-27 and EN 60068-2-27		
Mounting position 1	Shock direction	
		<b>NS contactor relays - AC operated</b>
	A	20 g
	B1	5 g
	B2	15 g
	C1	19 g closed position / 8 g open position
	C2	16 g closed position / 13 g open position
		<b>NSL contactor relays - DC operated</b>
		20 g closed position / 10 g open position
		15 g closed position / 5 g open position
		10 g
		19 g closed position / 8 g open position
		14 g closed position / 8 g open position
Vibration withstand		5...300 Hz
acc. to IEC 60068-2-6		3 g closed position / 2 g open position

### Connecting characteristics

Contactor relay types	AC operated	<b>NS..S</b>
	DC operated	<b>NSL..S</b>
Main terminals		 Spring terminals
Connection capacity (min. ... max.)		
Pole and coil terminals		
Rigid solid	1 x	0.75...2.5 mm <sup>2</sup>
Flexible with non insulated ferrule	2 x	0.75...2.5 mm <sup>2</sup>
Flexible with non insulated ferrule	1 x	0.75...2.5 mm <sup>2</sup>
Flexible with insulated ferrule	2 x	0.75...2.5 mm <sup>2</sup>
Flexible with insulated ferrule	1 x	0.75...1.5 mm <sup>2</sup>
Flexible with insulated ferrule	2 x	0.75...1.5 mm <sup>2</sup>
Connection capacity acc. to UL / CSA	1 or 2 x	AWG 18...14
Stripping length		10 mm
Degree of protection		
acc. to IEC 60947-1 / EN 60947-1 and IEC 60529 / EN 60529		
All terminals		IP20
Screwdriver type		Flat Ø 3.5

# Notes

A series of horizontal dotted lines for taking notes.

# NS..S contactor relays - with spring terminals

## Terminal marking and positioning

### NS..S contactor relays - AC operated

Standard devices without addition of auxiliary contact blocks

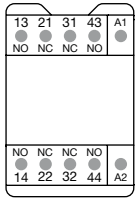

NS22ES

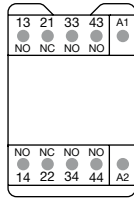

NS31ES

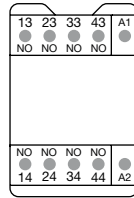

NS40ES

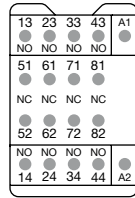

NS44ES

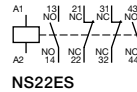

NS22ES

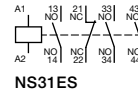

NS31ES

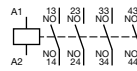

NS40ES



NS44ES

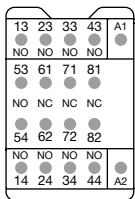

NS53ES

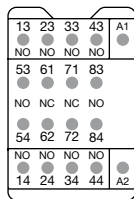

NS62ES

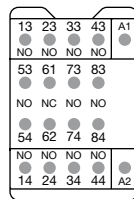

NS71ES

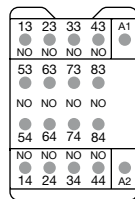

NS80ES

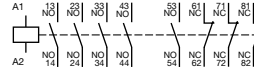

NS53ES

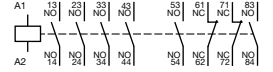

NS62ES



NS71ES

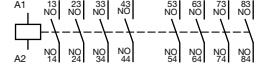

NS80ES

6

Other possible contact combinations with auxiliary contact blocks added by the user

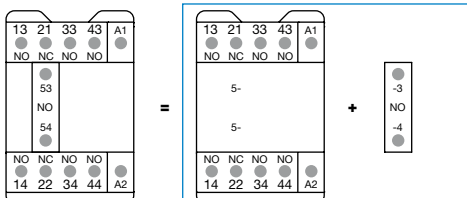

Combination 41E = NS31ES + CA3-10S

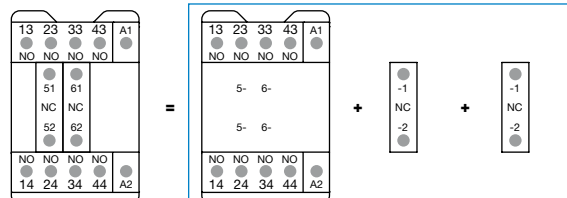

Combination 42E = NS40ES + CA3-01S + CA3-01S

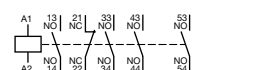

Combination 41E



Combination 42E

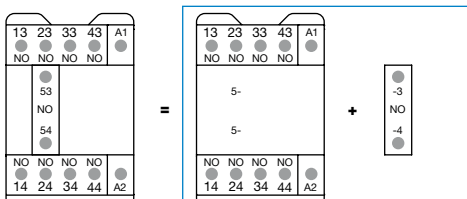

Combination 50E = NS40ES + CA3-10S

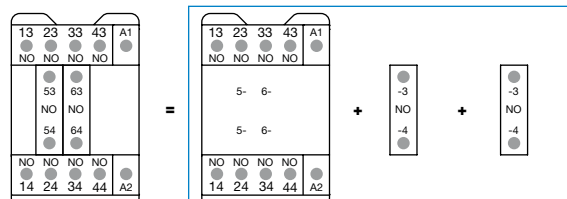

Combination 60E = NS40ES + CA3-10S + CA3-10S

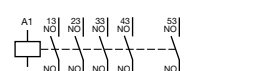

Combination 50E

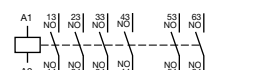

Combination 60E

CA3..S 1-pole auxiliary contact blocks

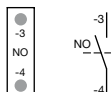

CA3-10S

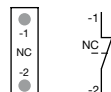

CA3-01S

# NSL..S contactor relays - with spring terminals

## Terminal marking and positioning

**NSL..S contactor relays - DC operated** (the polarity A1+, A2- must be respected)

Standard devices without addition of auxiliary contact blocks

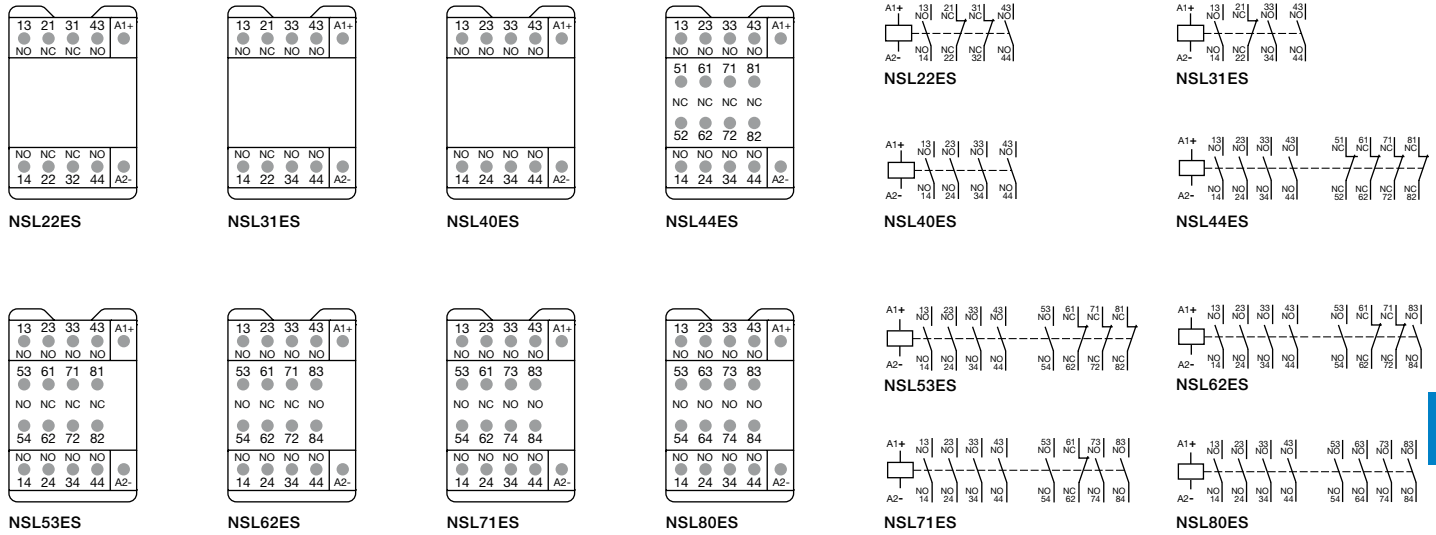

6

Other possible contact combinations with auxiliary contact blocks added by the user

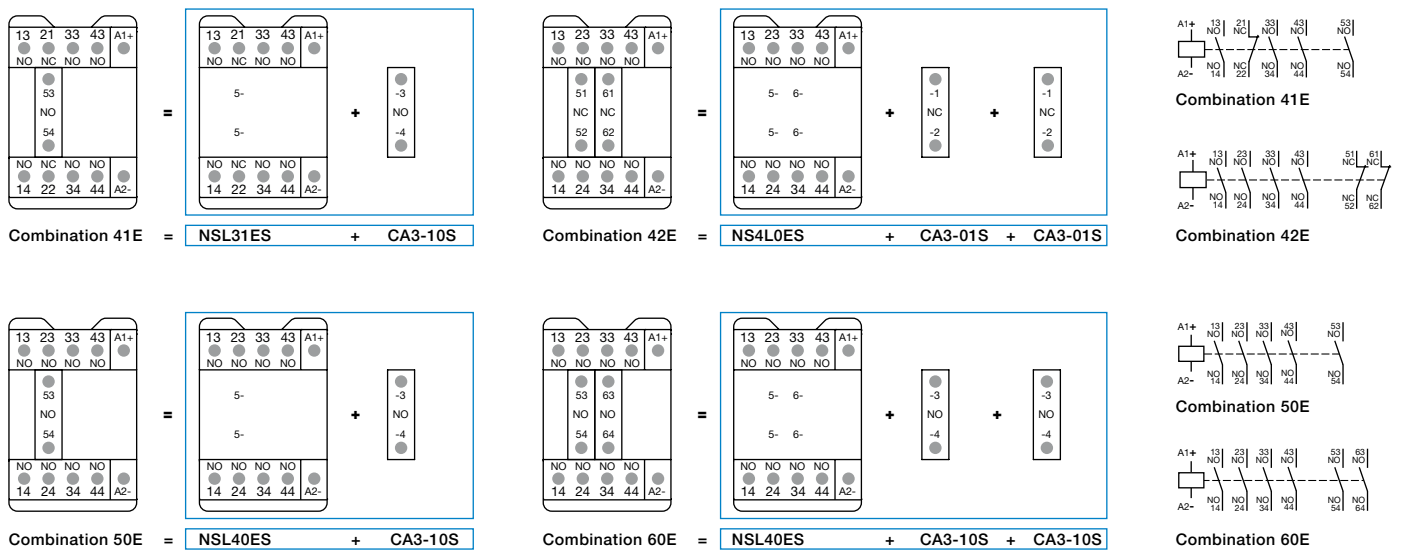

CA3..S 1-pole auxiliary contact blocks



# NS..S contactor relays - with spring terminals

## Main dimensions mm, inches

4-pole contactor relays

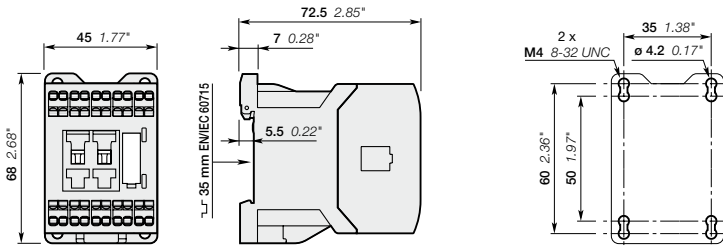

NS22ES, NS31ES, NS40ES

6

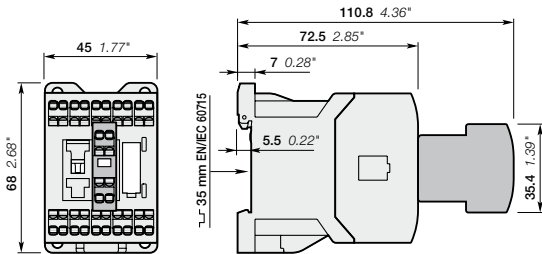

NS22ES, NS31ES, NS40ES  
+ CA3..S front-mounted 1-pole auxiliary contact block

8-pole contactor relays

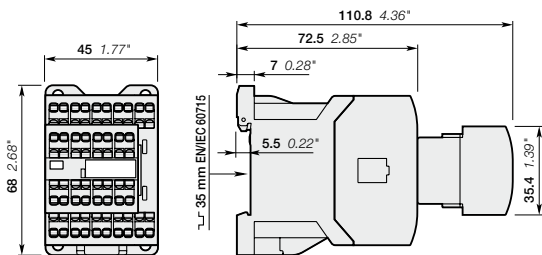

NS44ES, NS53ES, NS62ES, NS71ES, NS80ES

# NSL..S contactor relays - with spring terminals

## Main dimensions mm, inches

### 4-pole contactor relays

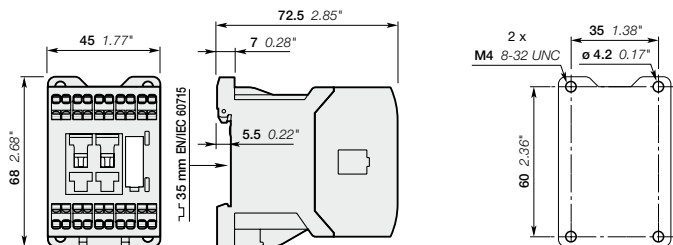

NSL22ES, NSL31ES, NSL40ES

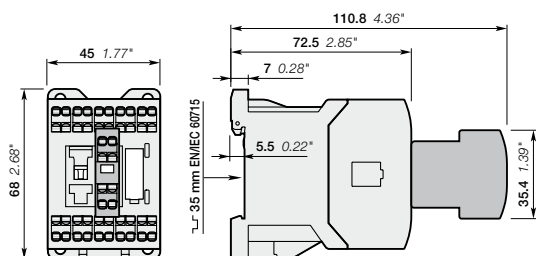

NSL22ES, NSL31ES, NSL40ES

+ CA3..S front-mounted 1-pole auxiliary contact block

### 8-pole contactor relays

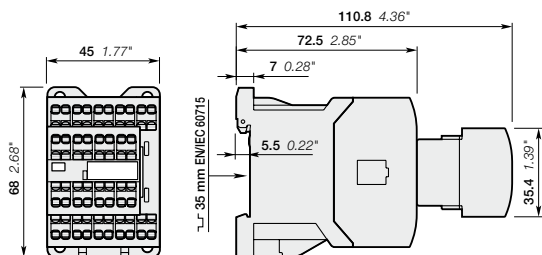

NSL44ES, NSL53ES, NSL62ES, NSL71ES, NSL80ES

# Auxiliary contact blocks - with spring terminals

## Accessories



CA3-10S

### Description

The auxiliary contact blocks are used for the operation of auxiliary circuits and control circuits. CA3 1-pole auxiliary contact blocks, designed for standard industrial environments, are equipped with:

- N.O. or N.C. contacts.
- spring-type connecting terminals.

All 1-pole auxiliary contact blocks are protected against accidental direct contact and bear the corresponding function marking.

A maximum of two 1-pole auxiliary contact blocks can be front-mounted on 1-stack contactors or 1-stack contactor relays.

### Ordering details

For contactors	For contactor relays	Contact blocks	Type	Order code	Pkg qty	Weight (1 pce)
						kg

#### 1-pole auxiliary contact blocks with spring terminals

AS09..S ... AS16..S	NS..S, NSL..S	1 -	CA3-10S	1SBN011019T1010	10	0.011
ASL09..S ... ASL16..S		- 1	CA3-01S	1SBN011019T1001	10	0.011

### Main dimensions mm, inches

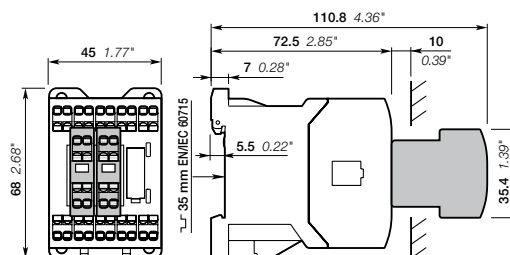



# Auxiliary contact blocks - with spring terminals

## Front mounting

### Technical data

Types	1-pole CA3..S
-------	---------------







### Contact utilization characteristics according to IEC

Standards	IEC 60947-5-1 and EN 60947-5-1	
Rated insulation voltage $U_i$ acc. to IEC 60947-5-1	690 V	
Rated impulse withstand voltage $U_{imp}$	6 kV	
Rated operational voltage $U_e$ max.	690 V	
Conventional thermal current $I_{th}$ - $\theta \leq 40^\circ\text{C}$	10 A	
le / Rated operational current AC-15 acc. to IEC 60947-5-1	24-127 V 50/60 Hz	6 A
	220-240 V 50/60 Hz	4 A
	400-440 V 50/60 Hz	3 A
	500 V 50/60 Hz	2 A
	690 V 50/60 Hz	2 A
Making capacity	10 x le AC-15 acc. to IEC 60947-5-1	
Breaking capacity	10 x le AC-15 acc. to IEC 60947-5-1	
le / Rated operational current DC-13 acc. to IEC 60947-5-1	24 V DC	6 A / 144 W
	48 V DC	2.8 A / 134 W
	72 V DC	1 A / 72 W
	110 V DC	0.55 A / 60 W
	125 V DC	0.55 A / 69 W
	220 V DC	0.27 A / 60 W
	250 V DC	0.27 A / 68 W
	Short-circuit protection device gG type fuse	10 A
Rated short-time withstand current $I_{sc}$ $\theta = 40^\circ\text{C}$	for 1.0 s	100 A
	for 0.1 s	140 A
Minimum switching capacity with failure rate acc. to IEC 60947-5-4	12 V / 3 mA	
Power dissipation per pole at 6 A	0.1 W	
Mechanical durability	Number of operating cycles	10 millions operating cycles
	Max. switching frequency	3600 cycles/h
	Max. electrical switching frequency	AC-15
AC-13		900 cycles/h
Mechanically linked contact acc. to annex L of IEC 60947-5-1	Additional N.O. or N.C. auxiliary contacts (CA3..S aux. contact blocks) are mechanically linked contacts	
Mirror contacts acc. to annex F of IEC 60947-4-1	Additional N.C. auxiliary contacts (CA3..S aux. contact blocks) are mirror contacts	

### Contact utilization characteristics according to UL / CSA

Standards	UL 508, CSA C22.2 N°14
Max. operational voltage	690 V AC, 250 V DC
Pilot duty	A600, Q300
AC thermal rated current	10 A
AC maximum volt-ampere making	7200 VA
AC maximum volt-ampere breaking	720 VA
DC thermal rated current	2.5 A
DC maximum volt-ampere making-breaking	69 VA

### Connecting characteristics

Connection capacity (min. ... max.)		
	Rigid solid	1 x 0.75...2.5 mm <sup>2</sup>
	Flexible with non insulated ferrule	2 x 0.75...2.5 mm <sup>2</sup>
		1 x 0.75...2.5 mm <sup>2</sup>
	Flexible with insulated ferrule	2 x 0.75...2.5 mm <sup>2</sup>
		1 x 0.75...1.5 mm <sup>2</sup>
		2 x 0.75...1.5 mm <sup>2</sup>
Connection capacity acc. to UL / CSA		1 or 2 x AWG 18...14
Stripping length		10 mm
Degree of protection acc. to IEC 60947-1 / EN 60947-1 and IEC 60529 / EN 60529	IP20	
Screw terminals	Spring terminals	
All terminals	Spring terminals	
Screwdriver type	Flat Ø 3.5	

# Surge suppressors for contactor coils

## Accessories

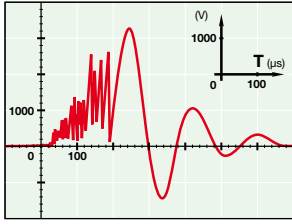

### Description

The operation of inductive circuits causes overvoltages, in particular on opening the contactor coil. The electromagnetic energy stored in the coil during contactor closing is restored on opening in the form of surges, the slope and amplitude of which may rise to several kilovolts. A number of drawbacks are observed ranging from interference on the electronic devices to the breakdown of insulators and even the destruction of certain sensitive components.

The graph opposite reproduces the oscillogram showing voltage discharges at the terminals of a 42 V / 50 Hz coil without peak clipping. The coil was switched by 8 series-connected poles of a contactor relay. Following a burst of discharges with a very steep slope, a damped oscillation emerges with a peak value of 3500 V.

### Overvoltage Factor

The overvoltage factor  $k$  is defined as the ratio of the maximum overvoltage peak value  $\hat{U}_s$  to the peak value  $\hat{U}_c$  of the coil rated control voltage  $U_c$ :

$$k = \frac{\hat{U}_s \text{ max.}}{\hat{U}_c} \quad \text{in DC} \quad k = \frac{\hat{U}_s \text{ max.}}{U_c} \quad \text{in AC} \quad k = \frac{\hat{U}_s \text{ max.}}{U_c \sqrt{2}}$$

For example the following is obtained for the above graph:  $k = \frac{3500}{42 \sqrt{2}} \approx 60$

To reduce the harmful effects of these overvoltages, ABB has developed a range of surge suppressors designed to reduce the  $k$  factor defined above and to limit or even completely eliminate the high pre-damping voltage frequencies.

Each case is different, but the technical data tolerances and generous sizing of parts have enabled us to reduce the number of variants.

We have chosen the following solutions: transil diodes, varistors and RC blocks.

Note: A varistor is a resistor whose value decreases to a very large extent when a certain voltage is applied at its terminals.

### Ordering details

For contactors	For contactor relays	Rated control circuit voltage - $U_c$			Type	Order code	Pkg qty	Weight (1 pce) kg
		V	DC	AC				
AS..S, ASL..S	NS..S, NSL..S	24...50	●	●	RV5/50	1SBN050010R1000	2	0.015
		50...133	●	●	RV5/133	1SBN050010R1001	2	0.015
		110...250	●	●	RV5/250	1SBN050010R1002	2	0.015
		250...440	●	●	RV5/440	1SBN050010R1003	2	0.015
AS..S	NS..S	24...50	-	●	RC5-1/50	1SBN050100R1000	2	0.012
		50...133	-	●	RC5-1/133	1SBN050100R1001	2	0.012
		110...250	-	●	RC5-1/250	1SBN050100R1002	2	0.012
		250...440	-	●	RC5-1/440	1SBN050100R1003	2	0.012
ASL..S	NSL..S	12...32	●	-	RT5/32	1SBN050020R1000	2	0.015
		25...65	●	-	RT5/65	1SBN050020R1001	2	0.015
		50...90	●	-	RT5/90	1SBN050020R1002	2	0.015
		77...150	●	-	RT5/150	1SBN050020R1003	2	0.015
		150...264	●	-	RT5/264	1SBN050020R1004	2	0.015

6



RV5



RC5-1



RT5

### Main dimensions mm, inches

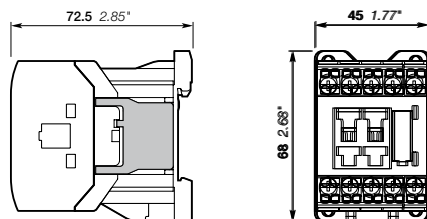

**Easy connection to the coil terminals**  
(parallel mounting)  
Clip-on for both fixing and connection.

**No additional space**  
Clipped onto the right side part of the contactor base without changing contactor overall dimensions and keeping a free access to coil terminals.

1SBC101499S0201

# Surge suppressors for contactor coils

## Technical data

<b>Varistor</b>	<b>RV5/50</b>	<b>RV5/133</b>	<b>RV5/250</b>	<b>RV5/440</b>
Rated control circuit voltage $U_c$	24...50 V AC	50...133 V AC	110...250 V AC	250...440 V AC
Residual overvoltage (clipping voltage)	24...50 V DC	50...133 V DC	110...250 V DC	250...440 V DC
	132 V AC	270 V AC	480 V AC	825 V AC
Opening time growth factor	132 V DC	270 V DC	480 V DC	825 V DC
	none			
Operating temperature	-20...+70 °C			
Advantages	High energy absorption: good damping - Unpolarized system.			
Drawback	Clipping as from $U_{vdr}^*$ , thus voltage front up to this point.			
	* $U_{vdr}$ = Varistor operating voltage (voltage dependent resistor), tolerance $\pm 10\%$ .			

<b>RC type</b>	<b>RC5-1/50</b>	<b>RC5-1/133</b>	<b>RC5-1/250</b>	<b>RC5-1/440</b>
Rated control circuit voltage $U_c$	24...50 V AC	50...133 V AC	110...250 V AC	250...440 V AC
Residual overvoltage (clipping voltage)	2 to 3 x $U_c$ max.			
Opening time growth factor	2...3			
Operating temperature	-20...+70 °C			
Advantages	Very fast clipping - Attenuation of steep fronts and thus of high frequencies.			

<b>Transil diode</b>	<b>RT5/32</b>	<b>RT5/65</b>	<b>RT5/90</b>	<b>RT5/150</b>	<b>RT5/264</b>
Rated control circuit voltage $U_c$	12...32 V DC	25...65 V DC	50...90 V DC	77...150 V DC	150...264 V DC
Residual overvoltage (clipping voltage)	50 V DC	100 V DC	150 V DC	210 V DC	390 V DC
Opening time growth factor	1.1...1.2				
Operating temperature	-20...+70 °C				
Advantages	Good energy absorption - Unpolarized system - Simple, reliable system.				
Drawback	Delay on drop out which does not however reduce contactor breaking capacity.				

### Wiring diagrams

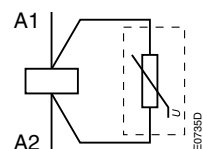

**Varistor**

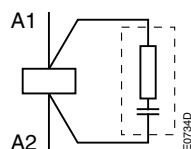

**RC type**

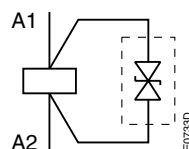

**Transil diode**

# Connecting links for starting solutions and other accessories



BEA16-3U

## Connecting links

The BEA16-3U insulated connecting links are used to connect an AS..S AC operated contactor or an ASL..S DC operated contactor with a manual motor starter.

The connecting link ensure the electrical and mechanical connection between the contactor and the manual motor starter.

## Ordering details

For contactors	Manual motor starter	Type	Order code	Pkg qty	Weight (1 pce) kg
AS09..S ... AS16..S ASL09..S ... ASL16..S	MS116-0.16 ... MS116-16 MS132-0.16 ... MS132-16	BEA16-3U	1SBN081020R1000	1	0.045



BDT4

## Test block

BDT4 test block is suitable for switching on contactor off-load.

Marking on the block indicates the contactor type to fit with.

## Ordering details

For contactors	Type	Order code	Pkg qty	Weight (1 pce) kg
AS..S, ASL..S, NS..S, NSL..S	BDT4	1SBN110122T1000	10	0.007



BA4

## Function markers

Box of 16 blank cards (16 markers by card) printable on HTP500 thermal transfer printer and AMS 500 marking table to identify your contactors, overload relays or manual motor starters.

Marker dimensions: 7 x 20 mm (.276" x .787").

## Ordering details

For contactors	Type	Order code	Pkg qty	Weight (1 pce) kg
AS..S, ASL..S, NS..S, NSL..S	BA4	1SNA235156R2700	16	0.011
AMS 500 support plate for 8 BA4	SPRC 1	1SNA360010R1500	1	0.220
HTP500 support plate	HTP500-BA4	1SNA235712R2400	1	0.290

# Voltage code table

The below tables indicate the available coil voltages and corresponding digits for order codes. When placing an order, please give either type or order code. Select a standard contactor from ordering detail pages. Change the **coil voltage code** in the type or in the order code according to the table below. Example: for contactor AS09-30-10S and coil 42 V 50/60 Hz, type is AS09-30-10S-**21** and order code is 1SBL101004R**21**10.

## 3-pole contactors - with spring terminals

**Type** AS16 - 30 - 10 S - 26

Auxiliary contacts  
N.O. N.C.

Main contacts  
N.O. N.C.

Order code 1SBL121004R 26 10

Contactor type  
AS AC operated  
ASL DC operated

Contactor with spring terminal

	AC coil code		DC coil code
	50 Hz	60 Hz	
20	24 V	24 V	80 12 V
21	42 V	42 V	81 24 V
22	48 V	48 V	83 48 V
23	110 V	110 V	84 60 V
24	115 V	115 V	86 110 V
16	-	120 V	87 125 V
25	220 V	220 V	88 220 V
26	230 V	230 V	89 240 V
27	240 V	240 V	
17	-	277 V	
13	380 V	-	
28	400 V	400 V	
29	415 V	415 V	

## Contactor relays - with spring terminals

**Type** NS 40 E S - 26

Contactor with spring terminal

N.O. N.C.  
Number contacts

Order code 1SBH101004R 26 40

Contactor type  
NS AC operated  
NSL DC operated

	AC coil code		DC coil code
	50 Hz	60 Hz	
20	24 V	24 V	80 12 V
21	42 V	42 V	81 24 V
22	48 V	48 V	83 48 V
23	110 V	110 V	84 60 V
24	115 V	115 V	86 110 V
16	-	120 V	87 125 V
25	220 V	220 V	88 220 V
26	230 V	230 V	89 240 V
27	240 V	240 V	
17	-	277 V	
13	380 V	-	
28	400 V	400 V	
29	415 V	415 V	



# AF..S 3-pole contactors and NF..S contactor relays with spring terminals

## AF..S 3-pole contactors - with spring terminals

Overview ..... 6/40

### 1-stack contactors

AF09..S ... AF26..S AC / DC operated ..... 6/42

AF09Z..S ... AF26Z..S AC / DC operated - low consumption ..... 6/43

### 2-stack contactors

AF09..S ... AF26..S AC / DC operated ..... 6/44

AF09Z..S ... AF26Z..S AC / DC operated - low consumption ..... 6/45

Main accessories ..... 6/46

Technical data ..... 6/48

Terminal marking and positioning ..... 6/53

Main dimensions ..... 6/54

## NF..S contactor relays - with spring terminals

Overview ..... 6/58

### 4-pole contactor relays

NF..S AC / DC operated ..... 6/60

NFZ..S AC / DC operated - low consumption ..... 6/61

### 8-pole contactor relays

NF..S AC / DC operated ..... 6/62

NFZ..S AC / DC operated - low consumption ..... 6/63

Main accessories ..... 6/64

Technical data ..... 6/66

Terminal marking and positioning ..... 6/69

Main dimensions ..... 6/70

### Accessories

Auxiliary contact blocks - with spring terminals ..... 6/72

Electronic timers - with spring terminals ..... 6/75

Other accessories ..... 6/78

Voltage code table ..... 6/79

# 3-pole contactors - with spring terminals

## Main accessories

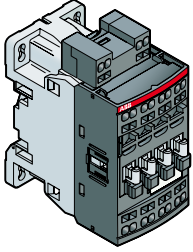

**AF09..S ... AF16..S**  
3-pole contactors

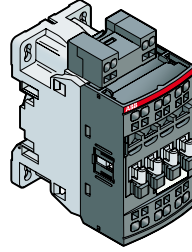

**AF26..S**  
3-pole contactors

## Main accessories for contactors

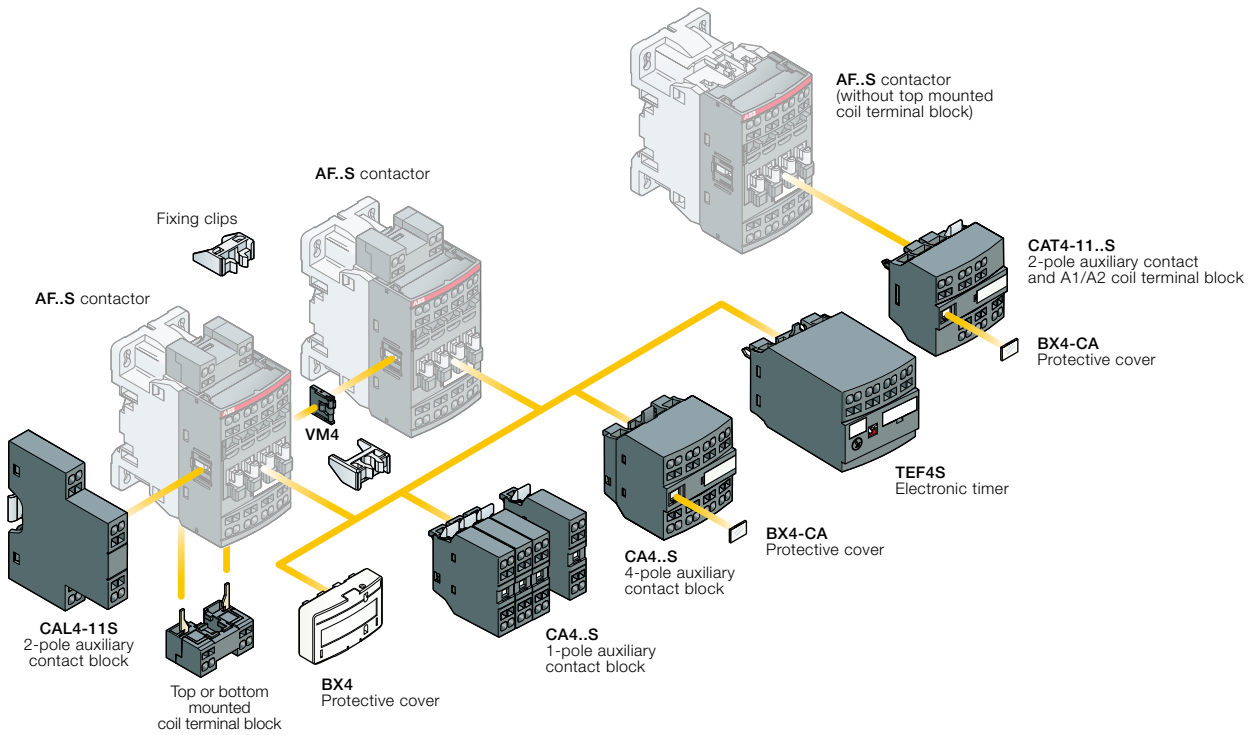



# 3-pole contactors - with spring terminals



Spring terminals



	AC / DC Control voltage	AF09..S	AF12..S	AF16..S	AF26..S
--	-------------------------	---------	---------	---------	---------

## Switching of 3-phase cage motors

	IEC	AC-3	Rated operational power	400 V	4 kW	5.5 kW	7.5 kW	11 kW	
			Rated operational current	$\theta \leq 60\text{ }^\circ\text{C}$	400 V	9 A	12 A	18 A	26 A
				$\theta \leq 60\text{ }^\circ\text{C}$	415 V	9 A	12 A	18 A	26 A
	UL/CSA	3-phase motor rating		440-480 V	5 hp	7.5 hp	10 hp	-	
			NEMA size		00	0	-	-	

## Switching of resistive circuits

	IEC	AC-1	Rated operational current	$\theta \leq 40\text{ }^\circ\text{C}$	690 V	22 A	24 A	24 A	35 A
			With conductor cross-sectional area	$\theta \leq 60\text{ }^\circ\text{C}$	690 V	18 A	20 A	20 A	30 A
				$\theta \leq 70\text{ }^\circ\text{C}$	690 V	15 A	16 A	16 A	25 A
	UL/CSA	General use rating		600 V AC	20 A	20 A	20 A	-	
			With conductor cross-sectional area		AWG 12	AWG 12	AWG 12	-	

## Main accessories

Auxiliary contact blocks	Front mounting		1-pole CA4-10S or CA4-01S 4-pole CA4..S
	Side mounting		2-pole CAT4-11..S (with coil front connection)
Interlock	Mechanical		VM4 Including 2 fixing clips
Additional coil terminal block			LDC4S
Protective covers			BX4 For all 1-stack contactors BX4-CA For 4-pole CA4..S and 2-pole CAT4..S auxiliary contact blocks

# AF09..S ... AF26..S 3-pole contactors - with spring terminals

## 4 to 11 kW

### AC / DC operated



AF09-30-10S

1SBC101099F0014



AF26-30-00S

1SBC101100F0014

### Description

AF09..S ... AF26..S contactors are mainly used for controlling 3-phase motors and power circuits up to 690 V AC and 220 V DC. These contactors are of the block type design with 3 main poles:

- control circuit: AC or DC operated with electronic coil interface accepting a wide control voltage range (e.g. 100...250 V AC and DC), only 4 control voltage ranges covering 24...500 V 50/60 Hz and 20...500 V DC
- can manage large control voltage variations
- reduced panel energy consumption
- very distinct closing and opening.
- built-in surge suppression
- add-on auxiliary contact blocks for front or side mounting and a wide range of accessories.

### Ordering details

IEC		UL/CSA		Rated control circuit voltage		Auxiliary contacts fitted	Type	Order code	Weight	
Rated operational power	current $\theta \leq 40^\circ\text{C}$	3-phase motor rating	General use rating	Uc min. ... Uc max.						
400 V AC-3	AC-1	480 V	600 V AC	V 50/60 Hz	V DC				Pkg (1 pce)	
kW	A	hp	A						kg	
4	22	5	20	24...60	-	(1)	1 0	AF09-30-10S-41	1SBL137004R4110	0.270
							0 1	AF09-30-01S-41	1SBL137004R4101	0.270
				48...130	48...130		1 0	AF09-30-10S-12	1SBL137004R1210	0.270
							0 1	AF09-30-01S-12	1SBL137004R1201	0.270
				100...250	100...250		1 0	AF09-30-10S-13	1SBL137004R1310	0.270
							0 1	AF09-30-01S-13	1SBL137004R1301	0.270
5.5	24	7.5	20	24...60	-	(1)	1 0	AF12-30-10S-41	1SBL157004R4110	0.270
							0 1	AF12-30-01S-41	1SBL157004R4101	0.270
				48...130	48...130		1 0	AF12-30-10S-12	1SBL157004R1210	0.270
							0 1	AF12-30-01S-12	1SBL157004R1201	0.270
				100...250	100...250		1 0	AF12-30-10S-13	1SBL157004R1310	0.270
							0 1	AF12-30-01S-13	1SBL157004R1301	0.270
7.5	24	10	20	24...60	-	(1)	1 0	AF16-30-10S-41	1SBL177004R4110	0.270
							0 1	AF16-30-01S-41	1SBL177004R4101	0.270
				48...130	48...130		1 0	AF16-30-10S-12	1SBL177004R1210	0.270
							0 1	AF16-30-01S-12	1SBL177004R1201	0.270
				100...250	100...250		1 0	AF16-30-10S-13	1SBL177004R1310	0.270
							0 1	AF16-30-01S-13	1SBL177004R1301	0.270
11	35	-	-	24...60	-	(1)	0 0	AF26-30-00S-41	1SBL237004R4100	0.320
							0 0	AF26-30-00S-12	1SBL237004R1200	0.320
				48...130	48...130		0 0	AF26-30-00S-13	1SBL237004R1300	0.320
							0 0	AF26-30-00S-14	1SBL237004R1400	0.320
				100...250	100...250		0 0	AF26-30-00S-13	1SBL237004R1300	0.320
							0 0	AF26-30-00S-14	1SBL237004R1400	0.360

(1) For 24...60 V 50/60 Hz - 20...60 V DC, use AF..-30-..S-11 (see voltage code table).  
AF..-30-..S-11 not suitable for direct control by PLC-output.

### Main dimensions mm, inches

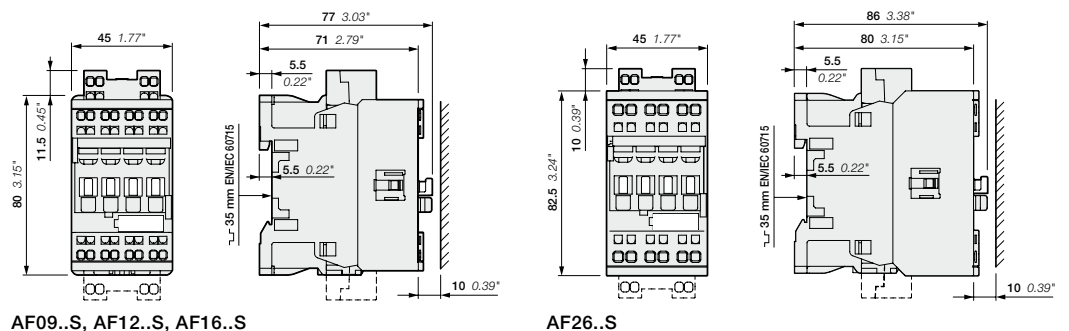

AF09..S, AF12..S, AF16..S

AF26..S

1SBC101688S0201 - Rev. A

# AF09Z..S ... AF26Z..S 3-pole contactors - with spring terminals

## 4 to 11 kW

### AC / DC operated - low consumption



AF09Z-30-10S



AF26Z-30-00S

#### Description

AF09Z..S ... AF26Z..S contactors are mainly used for controlling 3-phase motors and power circuits up to 690 V AC and 220 V DC. These contactors are of the block type design with 3 main poles:

- control circuit: AC or DC operated with electronic coil interface accepting a wide control voltage range (e.g. 100...250 V AC and DC), only 4 control voltage ranges covering 24...250 V 50/60 Hz and 12...250 V DC
- can manage large control voltage variations
- allow direct control by PLC-output  $\geq 24$  V DC 500 mA
- reduced panel energy consumption
- very distinct closing and opening
- can withstand short voltage dips and voltage sags (SEMI F47-0706 conditions of use on request).
- built-in surge suppression
- add-on auxiliary contact blocks for front or side mounting and a wide range of accessories.

#### Ordering details

IEC Rated operational power 400 V AC-3 kW	operational current $\theta \leq 40$ °C A	UL/CSA 3-phase motor rating 480 V hp	General use rating 600 V AC A	Rated control circuit voltage Uc min. ... Uc max.		Auxiliary contacts fitted	Type	Order code	Weight Pkg (1 pce) kg
				V 50/60 Hz	V DC				
4	22	5	20	-	12...20	1 0 0 1	AF09Z-30-10S-20	1SBL136004R2010	0.310
							AF09Z-30-01S-20	1SBL136004R2001	0.310
							AF09Z-30-10S-21	1SBL136004R2110	0.310
							AF09Z-30-01S-21	1SBL136004R2101	0.310
							AF09Z-30-10S-22	1SBL136004R2210	0.310
							AF09Z-30-01S-22	1SBL136004R2201	0.310
							AF09Z-30-10S-23	1SBL136004R2310	0.310
							AF09Z-30-01S-23	1SBL136004R2301	0.310
5.5	24	7.5	20	-	12...20	1 0 0 1	AF12Z-30-10S-20	1SBL156004R2010	0.310
							AF12Z-30-01S-20	1SBL156004R2001	0.310
							AF12Z-30-10S-21	1SBL156004R2110	0.310
							AF12Z-30-01S-21	1SBL156004R2101	0.310
							AF12Z-30-10S-22	1SBL156004R2210	0.310
							AF12Z-30-01S-22	1SBL156004R2201	0.310
							AF12Z-30-10S-23	1SBL156004R2310	0.310
							AF12Z-30-01S-23	1SBL156004R2301	0.310
7.5	24	10	20	-	12...20	1 0 0 1	AF16Z-30-10S-20	1SBL176004R2010	0.310
							AF16Z-30-01S-20	1SBL176004R2001	0.310
							AF16Z-30-10S-21	1SBL176004R2110	0.310
							AF16Z-30-01S-21	1SBL176004R2101	0.310
							AF16Z-30-10S-22	1SBL176004R2210	0.310
							AF16Z-30-01S-22	1SBL176004R2201	0.310
							AF16Z-30-10S-23	1SBL176004R2310	0.310
							AF16Z-30-01S-23	1SBL176004R2301	0.310
11	35	-	-	-	12...20	0 0 0 0	AF26Z-30-00S-20	1SBL236004R2000	0.360
							AF26Z-30-00S-21	1SBL236004R2100	0.360
							AF26Z-30-00S-22	1SBL236004R2200	0.360
							AF26Z-30-00S-23	1SBL236004R2300	0.360

Note: Only AF.Z..S contactors with DC control voltage 12...20 V DC need to respect the connection polarities indicated close to the coil terminals: A1+ for the positive pole and A2- for the negative pole.

#### Main dimensions mm, inches

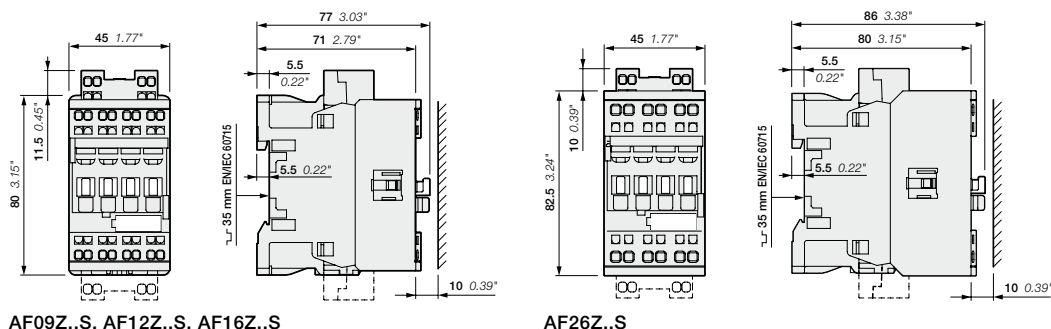

AF09Z..S, AF12Z..S, AF16Z..S

AF26Z..S

# AF09..S ... AF26..S 2-stack 3-pole contactors - with spring terminals

## 4 to 11 kW

### AC / DC operated



AF09-30-22S

1SBC10110F0014

#### Description

- AF09..S ... AF26..S contactors are mainly used for controlling 3-phase motors and power circuits up to 690 V AC and 220 V DC. These contactors are of the block type design with 3 main poles (1st stack):
- 2nd stack with permanently fixed auxiliary contact block. The built-in auxiliary contact elements are mechanically linked (side-marked symbol) and the N.C. auxiliary contacts are mirror contacts
  - control circuit: AC or DC operated with electronic coil interface accepting a wide control voltage range (e.g. 100...250 V AC and DC) only 4 control voltage ranges covering 24...500 V 50/60 Hz and 20...500 V DC
  - can manage large control voltage variations
  - reduced panel energy consumption
  - very distinct closing and opening.
  - built-in surge suppression
  - add-on auxiliary contact blocks for side mounting and a wide range of accessories.

#### Ordering details

IEC Rated operational power	UL/CSA 3-phase General use rating	3-phase motor rating	General use rating	Rated control circuit voltage		Auxiliary contacts fitted	Type	Order code	Weight Pkg (1 pce)
				Uc min. ... Uc max.					
400 V AC-3	AC-1	hp	A	V 50/60 Hz	V DC				kg
kW	A								
4	22	5	20	24...60	-	(1) 2 2	AF09-30-22S-41	1SBL137004R4122	0.320
				48...130	48...130	2 2	AF09-30-22S-12	1SBL137004R1222	0.320
				100...250	100...250	2 2	AF09-30-22S-13	1SBL137004R1322	0.320
				250...500	250...500	2 2	AF09-30-22S-14	1SBL137004R1422	0.360
5.5	24	7.5	20	24...60	-	(1) 2 2	AF12-30-22S-41	1SBL157004R4122	0.320
				48...130	48...130	2 2	AF12-30-22S-12	1SBL157004R1222	0.320
				100...250	100...250	2 2	AF12-30-22S-13	1SBL157004R1322	0.320
				250...500	250...500	2 2	AF12-30-22S-14	1SBL157004R1422	0.360
7.5	24	10	20	24...60	-	(1) 2 2	AF16-30-22S-41	1SBL177004R4122	0.320
				48...130	48...130	2 2	AF16-30-22S-12	1SBL177004R1222	0.320
				100...250	100...250	2 2	AF16-30-22S-13	1SBL177004R1322	0.320
				250...500	250...500	2 2	AF16-30-22S-14	1SBL177004R1422	0.360
11	35	-	-	24...60	-	(1) 1 1	AF26-30-11S-41	1SBL237004R4111	0.360
						2 2	AF26-30-22S-41	1SBL237004R4122	0.380
				48...130	48...130	1 1	AF26-30-11S-12	1SBL237004R1211	0.360
						2 2	AF26-30-22S-12	1SBL237004R1222	0.380
				100...250	100...250	1 1	AF26-30-11S-13	1SBL237004R1311	0.360
						2 2	AF26-30-22S-13	1SBL237004R1322	0.380
				250...500	250...500	1 1	AF26-30-11S-14	1SBL237004R1411	0.400
						2 2	AF26-30-22S-14	1SBL237004R1422	0.420

(1) For 24...60 V 50/60 Hz - 20...60 V DC, use AF..-30-..S-11 (see voltage code table).  
AF..-30-..S-11 not suitable for direct control by PLC-output.



AF26-30-11S

1SBC101102F0014



AF26-30-22S

1SBC101103F0014

#### Main dimensions mm, inches

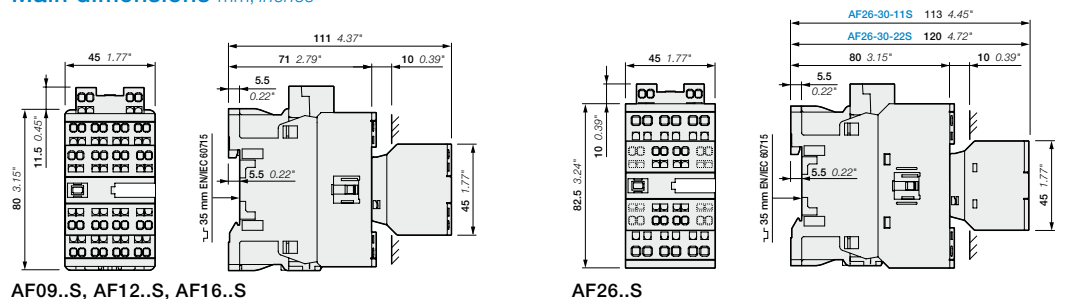

AF09..S, AF12..S, AF16..S

AF26..S

1SBC101710S0201 - Rev. A

# AF09Z..S ... AF26Z..S 2-stack 3-pole contactors - with spring terminals 4 to 11 kW AC / DC operated - low consumption



AF09Z-30-22S

1SBC101101F0014



AF26Z-30-11S

1SBC101102F0014



AF26Z-30-22S

1SBC101103F0014

## Description

AF09Z..S ... AF26Z..S contactors are mainly used for controlling 3-phase motors and power circuits up to 690 V AC and 220 V DC. These contactors are of the block type design with 3 main poles (1st stack):

- 2nd stack with permanently fixed auxiliary contact block. The built-in auxiliary contact elements are mechanically linked (side-marked symbol) and the N.C. auxiliary contacts are mirror contacts
- control circuit: AC or DC operated with electronic coil interface accepting a wide control voltage range (e.g. 100...250 V AC and DC), only 4 control voltage ranges covering 24...250 V 50/60 Hz and 12...250 V DC
- can manage large control voltage variations
- allow direct control by PLC-output  $\geq 24$  V DC 500 mA
- reduced panel energy consumption
- very distinct closing and opening
- can withstand short voltage dips and voltage sags (SEMI F47-0706 conditions of use on request).
- built-in surge suppression
- add-on auxiliary contact blocks for side mounting and a wide range of accessories.

## Ordering details

IEC Rated operational power 400 V AC-3 kW	Rated current $\theta \leq 40$ °C AC-1 A	UL/CSA 3-phase motor rating 480 V hp	General use rating 600 V AC A	Rated control circuit voltage Uc min. ... Uc max.		Auxiliary contacts fitted	Type	Order code	Weight Pkg (1 pce) kg
				V 50/60 Hz	V DC				
4	22	5	20	-	12...20	2 2	AF09Z-30-22S-20	1SBL136004R2022	0.360
				24...60	20...60	2 2	AF09Z-30-22S-21	1SBL136004R2122	0.360
				48...130	48...130	2 2	AF09Z-30-22S-22	1SBL136004R2222	0.360
				100...250	100...250	2 2	AF09Z-30-22S-23	1SBL136004R2322	0.360
5.5	24	7.5	20	-	12...20	2 2	AF12Z-30-22S-20	1SBL156004R2022	0.360
				24...60	20...60	2 2	AF12Z-30-22S-21	1SBL156004R2122	0.360
				48...130	48...130	2 2	AF12Z-30-22S-22	1SBL156004R2222	0.360
				100...250	100...250	2 2	AF12Z-30-22S-23	1SBL156004R2322	0.360
7.5	24	10	20	-	12...20	2 2	AF16Z-30-22S-20	1SBL176004R2022	0.360
				24...60	20...60	2 2	AF16Z-30-22S-21	1SBL176004R2122	0.360
				48...130	48...130	2 2	AF16Z-30-22S-22	1SBL176004R2222	0.360
				100...250	100...250	2 2	AF16Z-30-22S-23	1SBL176004R2322	0.360
11	35	-	-	-	12...20	1 1	AF26Z-30-11S-20	1SBL236004R2011	0.400
				24...60	20...60	2 2	AF26Z-30-22S-20	1SBL236004R2022	0.420
				24...60	20...60	1 1	AF26Z-30-11S-21	1SBL236004R2111	0.400
				24...60	20...60	2 2	AF26Z-30-22S-21	1SBL236004R2122	0.420
				48...130	48...130	1 1	AF26Z-30-11S-22	1SBL236004R2211	0.400
				48...130	48...130	2 2	AF26Z-30-22S-22	1SBL236004R2222	0.420
100...250	100...250	1 1	AF26Z-30-11S-23	1SBL236004R2311	0.400				
100...250	100...250	2 2	AF26Z-30-22S-23	1SBL236004R2322	0.420				

Note: Only AF.Z..S contactors with DC control voltage 12...20 V DC need to respect the connection polarities indicated close to the coil terminals: A1+ for the positive pole and A2- for the negative pole.

## Main dimensions mm, inches

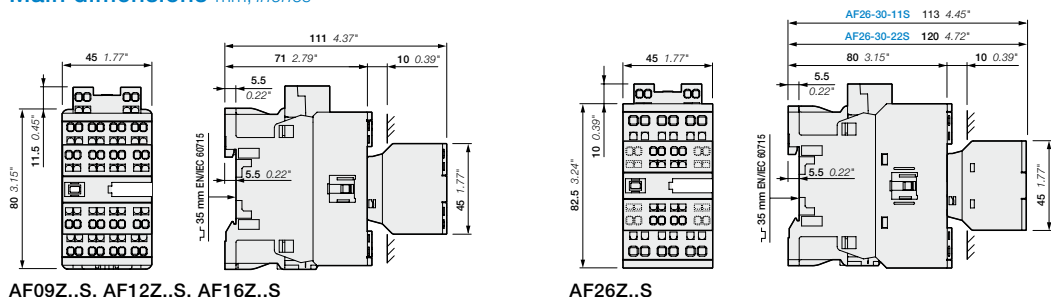

AF09Z..S, AF12Z..S, AF16Z..S

AF26Z..S

1SBC101711S0201 - Rev. A

# AF09..S ... AF26..S 3-pole contactors - with spring terminals

## Main accessories

### Contactor and main accessories (other accessories available)

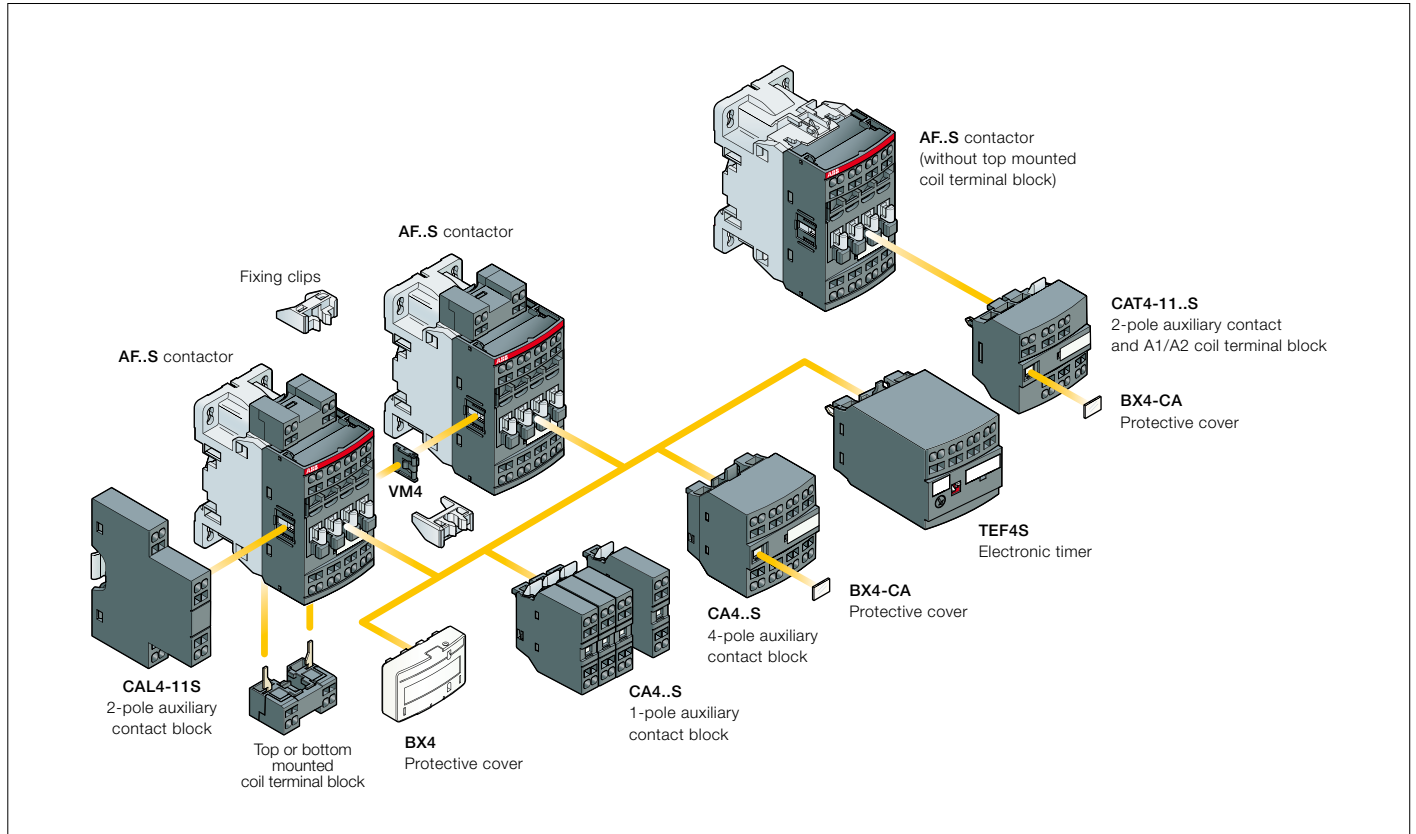

### Main accessory fitting details

Many configurations of accessories are possible depending on whether these are front-mounted or side-mounted.

Contactor types	Main poles	Built-in auxiliary contacts	Front-mounted accessories				Side-mounted accessories	
			Auxiliary contact blocks			Electronic timer	Mechanical interlock unit (between 2 contactors)	Left side
			1-pole CA4..S	2-pole CAT4-11..S	4-pole CA4..S	TEF4S	VM4	2-pole CAL4-11S
Max. N.C. built-in and add-on N.C. auxiliary contacts: 4 N.C. max. on positions 1, 2, 3, 4 and 3 N.C. max. on positions 1 ±30°, 5								
AF09..S ... AF16..S	3	0	0	1	4 max. <b>or</b> 1	<b>or</b> 1	–	+ 1
					2 max. –	–	–	+ 1
					3 max. –	–	+ 1	<b>or</b> 1
AF09..S ... AF16..S	3	0	1	0	4 max. <b>or</b> 1	<b>or</b> 1	–	+ 1
AF26..S	3	0	0	0	2 max. <b>or</b> 1	–	–	+ 1
					3 max. –	–	+ 1	<b>or</b> 1
AF26..S	3	0	1	1	–	–	–	1
AF09..S ... AF26..S	3	0	2	2	–	–	–	1



# AF09..S ... AF26..S 3-pole contactors - with spring terminals

## Main accessories



CA4-10S



CA4-22MS



CAL4-11S



CAT4-11ES



TEF4S-OFF

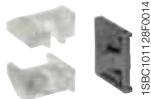

VM4



LDC4S





BX4



BX4-CA

### Ordering details (1)

For contactors	Auxiliary contacts	Type	Order code	Pkg qty	Weight (1 pce)
	 				kg

### Front-mounted instantaneous auxiliary contact blocks

AF09..S ... AF26..S	1 0	CA4-10S	1SBN010119R1010	1	0.016
	1 0	CA4-10S-T	1SBN010119T1010	10	0.016
	0 1	CA4-01S	1SBN010119R1001	1	0.016
	0 1	CA4-01S-T	1SBN010119T1001	10	0.016
AF09 ... AF16...-30-10S	2 2	CA4-22MS	1SBN010145R1122	1	0.060
	3 1	CA4-31MS	1SBN010145R1131	1	0.060
AF26..S	2 2	CA4-22ES	1SBN010145R1022	1	0.060
	3 1	CA4-31ES	1SBN010145R1031	1	0.060
	4 0	CA4-40ES	1SBN010145R1040	1	0.060

### Side-mounted instantaneous auxiliary contact blocks



AF09..S ... AF26..S	1 1	CAL4-11S	1SBN010130R1011	1	0.045
---------------------	-----	----------	-----------------	---	-------

### Front-mounted instantaneous auxiliary contact and A1/A2 coil terminal blocks

AF09 ... AF16...-30-10S	1 1	CAT4-11MS	1SBN010153R1111	1	0.045
AF26..S	1 1	CAT4-11ES	1SBN010153R1011	1	0.045
AF09 ... AF16...-30-01S	1 1	CAT4-11US	1SBN010153R1311	1	0.045

Note: CAT4 not fittable on AF..Z contactors with DC control voltage 12...20 V DC.

### Ordering details (1)

For contactors	Time delay range selected by switch	Delay type	Rated control circuit voltage U <sub>c</sub>	Auxiliary contacts	Type	Order code	Pkg qty	Weight (1 pce)
			V 50/60 Hz or DC	 				kg

### Front-mounted electronic timer

AF09..S ... AF26..S	0.1...1 s 1...10 s 10...100 s	ON-delay	24...240	1 1	TEF4S-ON	1SBN020113R1000	1	0.065
		OFF-delay	24...240	1 1	TEF4S-OFF	1SBN020115R1000	1	0.065

### Ordering details (1)

For contactors	Type	Order code	Pkg qty	Weight (1 pce)
				kg

### Mechanical interlock unit

AF09..S ... AF26..S	VM4	1SBN030105T1000	10	0.005
---------------------	-----	-----------------	----	-------

Note: VM4 includes 2 fixing clips (BB4) to maintain together both contactors.

### Additional coil terminal block

AF09..S ... AF26..S	LDC4S	1SBN070157T1000	10	0.010
---------------------	-------	-----------------	----	-------

### Protective covers

All 1-stack contactors	BX4	1SBN110108T1000	10	0.006
For 4-pole CA4..S and 2-pole CAT4..S auxiliary contact blocks	BX4-CA	1SBN110109W1000	50	0.001

(1) See "Main accessory fitting details" table.

# AF09..S ... AF26..S 3-pole contactors - with spring terminals

## Technical data

### Main pole - Utilization characteristics according to IEC

Contactor types	AC / DC operated	AF09..S	AF12..S	AF16..S	AF26..S
<b>Standards</b>		IEC 60947-1 / 60947-4-1 and EN 60947-1 / 60947-4-1			
<b>Rated operational voltage U<sub>e</sub> max.</b>		690 V			
<b>Rated frequency (without derating)</b>		50/60 Hz			
<b>Conventional free-air thermal current I<sub>th</sub></b>					
acc. to IEC 60947-4-1, open contactors, $\theta \leq 40\text{ °C}$		24 A	24 A	24 A	35 A
With conductor cross-sectional area		2.5 mm <sup>2</sup>	2.5 mm <sup>2</sup>	2.5 mm <sup>2</sup>	4 mm <sup>2</sup>
<b>AC-1 Utilization category</b>					
For air temperature close to contactor					
<b>I<sub>e</sub> / Rated operational current AC-1</b>	$\theta \leq 40\text{ °C}$	22 A	24 A	24 A	35 A
U <sub>e</sub> max. $\leq$ 690 V, 50/60 Hz	$\theta \leq 60\text{ °C}$	18 A	20 A	20 A	30 A
	$\theta \leq 70\text{ °C}$	15 A	16 A	16 A	25 A
With conductor cross-sectional area		2.5 mm <sup>2</sup>	2.5 mm <sup>2</sup>	2.5 mm <sup>2</sup>	4 mm <sup>2</sup>
<b>AC-3 Utilization category</b>					
For air temperature close to contactor $\theta \leq 60\text{ °C}$					
<b>I<sub>e</sub> / Max. rated operational current AC-3 (1)</b>					
	220-230-240 V	9 A	12 A	18 A	26 A
	380-400 V	9 A	12 A	18 A	26 A
	415 V	9 A	12 A	18 A	26 A
	440 V	9 A	12 A	18 A	26 A
	500 V	9.5 A	12.5 A	15 A	23 A
	690 V	7 A	9 A	10.5 A	17 A
<b>Rated operational power AC-3 (1)</b>					
	220-230-240 V	2.2 kW	3 kW	4 kW	6.5 kW
	380-400 V	4 kW	5.5 kW	7.5 kW	11 kW
	415 V	4 kW	5.5 kW	9 kW	11 kW
	440 V	4 kW	5.5 kW	9 kW	15 kW
	500 V	5.5 kW	7.5 kW	9 kW	15 kW
	690 V	5.5 kW	7.5 kW	9 kW	15 kW
<b>Rated making capacity AC-3</b>		10 x I <sub>e</sub> AC-3 acc. to IEC 60947-4-1			
<b>Rated breaking capacity AC-3</b>		8 x I <sub>e</sub> AC-3 acc. to IEC 60947-4-1			
<b>AC-8a Utilization category</b>					
(without thermal overload relay - U <sub>e</sub> 400 V 50/60 Hz - $\theta \leq 40\text{ °C}$ )					
<b>I<sub>e</sub> / Rated operational current AC-8a</b>		12 A	16 A	22 A	30 A
<b>Rated operational power AC-8a</b>		5.5 kW	7.5 kW	11 kW	15 kW
<b>Short-circuit protection device for contactors</b>					
without thermal overload relay - Motor protection excluded (2)					
U <sub>e</sub> $\leq$ 500 V AC - gG type fuse		25 A	25 A	25 A	40 A
<b>Rated short-time withstand current I<sub>cw</sub></b>					
at 40 °C ambient temperature,	<b>1 s</b>	300 A	300 A	300 A	700 A
in free air from a cold state	<b>10 s</b>	150 A	150 A	150 A	350 A
	<b>30 s</b>	80 A	80 A	80 A	225 A
	<b>1 min</b>	60 A	60 A	60 A	150 A
	<b>15 min</b>	24 A	24 A	24 A	35 A
<b>Maximum breaking capacity</b>					
cos $\phi$ = 0.45	<b>at 440 V</b>	250 A	250 A	250 A	500 A
	<b>at 690 V</b>	106 A	106 A	106 A	200 A
<b>Power dissipation per pole</b>					
	<b>I<sub>e</sub> / AC-1</b>	0.9 W	1.1 W	1.1 W	1.8 W
	<b>I<sub>e</sub> / AC-3</b>	0.15 W	0.3 W	0.6 W	1 W
<b>Max. electrical switching frequency</b>					
	<b>AC-1</b>	600 cycles/h			
	<b>AC-3</b>	1200 cycles/h			
	<b>AC-2, AC-4</b>	300 cycles/h			
					150 cycles/h

(1) For the corresponding kW/A or hp/A values of 1500 r.p.m, 50 Hz or 1800 r.p.m, 60 Hz, 3-phase motors, see "Motor rated operational powers and currents".

(2) For the protection of motor starters against short circuits, see "Coordination with short-circuit protection devices".



3-phase motors



1500 r.p.m. 50 Hz  
1800 r.p.m. 60 Hz  
3-phase motors



# AF09..S ... AF26..S 3-pole contactors - with spring terminals

## Technical data

### Main pole - Utilization characteristics according to UL / NEMA / CSA

Contactor types	AC / DC operated	AF09..S	AF12..S	AF16..S	AF26..S		
<b>Standards</b>		UL 508, CSA C22.2 N°14			-		
<b>Max. operational voltage</b>		690 V					
<b>NEMA size</b>		00	0	-	-		
<b>NEMA continuous amp rating</b>	<b>Thermal current</b>	9 A	18 A	-	-		
<b>NEMA maximum horse power ratings 1-phase, 60 Hz</b>	<b>115 V AC</b>	1/3 hp	1 hp	-	-		
	<b>230 V AC</b>	1 hp	2 hp	-	-		
<b>NEMA maximum horse power ratings 3-phase, 60 Hz</b>	<b>200 V AC</b>	1-1/2 hp	3 hp	-	-		
	<b>230 V AC</b>	1-1/2 hp	3 hp	-	-		
	<b>460 V AC</b>	2 hp	5 hp	-	-		
	<b>575 V AC</b>	2 hp	5 hp	-	-		
<b>UL / CSA General use rating</b>	600 V AC	20 A	20 A	20 A	-		
	With conductor cross-sectional area	AWG 12	AWG 12	AWG 12	-		
<b>UL / CSA maximum 1-phase motor rating</b>	Full load current	<b>120 V AC</b>	13.8 A	16 A	16 A		
		<b>240 V AC</b>	10 A	12 A	12 A		
	Horse power rating	<b>120 V AC</b>	3/4 hp	1 hp	1 hp		
		<b>240 V AC</b>	1 1/2 hp	2 hp	2 hp		
<b>UL / CSA maximum 3-phase motor rating</b>	Full load current (1)	<b>200-208 V AC</b>	7.8 A	11 A	11 A		
		<b>220-240 V AC</b>	6.8 A	9.6 A	15.2 A		
		<b>440-480 V AC</b>	7.6 A	11 A	14 A		
		<b>550-600 V AC</b>	9 A	11 A	11 A		
	Horse power rating (1)	<b>200-208 V AC</b>	2 hp	3 hp	3 hp		
		<b>220-240 V AC</b>	2 hp	3 hp	5 hp		
		<b>440-480 V AC</b>	5 hp	7.5 hp	10 hp		
		<b>550-600 V AC</b>	7.5 hp	10 hp	10 hp		
		<b>Short-circuit protection device for contactors</b>					
		without thermal overload relay - Motor protection excluded					
Fuse rating		30	30	60	-		
Fuse type, 600 V		J	J	J	-		
<b>Max. electrical switching frequency</b>	For general use	600 cycles/h	600 cycles/h	600 cycles/h	-		
	For motor use	1200 cycles/h	1200 cycles/h	1200 cycles/h	-		

(1) For the corresponding kW/A or hp/A values of 1500 r.p.m, 50 Hz or 1800 r.p.m, 60 Hz, 3-phase motors, see "Motor rated operational powers and currents".

### General technical data

Contactor types	AC / DC operated	AF09..S	AF12..S	AF16..S	AF26..S
<b>Rated insulation voltage Ui</b>		690 V			
acc. to IEC 60947-4-1		690 V			
acc. to UL / CSA		600 V			
<b>Rated impulse withstand voltage Uimp.</b>		6 kV			
<b>Electromagnetic compatibility</b>		Devices complying with IEC 60947-1 / EN 60947-1 - Environment A			
<b>Ambient air temperature</b> close to contactor					
Operation without thermal overload relay		-40...+70 °C			
Storage		-60...+80 °C			
<b>Climatic withstand</b>		Category B according to IEC 60947-1 Annex Q			
<b>Maximum operating altitude (without derating)</b>		3000 m			
<b>Mechanical durability</b>					
Number of operating cycles		10 millions operating cycles			
Max. switching frequency		3600 cycles/h			
<b>Shock withstand</b>					
acc. to IEC 60068-2-27 and EN 60068-2-27	<b>Shock direction</b>	1/2 sinusoidal shock for 11 ms: no change in contact position, closed or open position			
Mounting position 1	<b>A</b>	30 g			
	<b>B1</b>	25 g closed position / 5 g open position			
	<b>B2</b>	15 g			
	<b>C1</b>	25 g			
	<b>C2</b>	25 g			
	<b>Vibration withstand</b>		5...300 Hz		
acc. to IEC 60068-2-6		4 g closed position / 2 g open position			

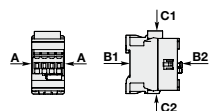

# AF09..S ... AF26..S 3-pole contactors - with spring terminals

## Technical data

### Magnet system characteristics

Contactor types	AC / DC operated	AF09..S	AF12..S	AF16..S	AF26..S
Coil operating limits acc. to IEC 60947-4-1	AC supply	At $\theta \leq 60^\circ\text{C}$ $0.85 \times U_c \text{ min...} 1.1 \times U_c \text{ max.}$ At $\theta \leq 70^\circ\text{C}$ $0.85 \times U_c \text{ min...} U_c \text{ max.}$			
	DC supply	At $\theta \leq 60^\circ\text{C}$ $0.85 \times U_c \text{ min...} 1.1 \times U_c \text{ max.}$ At $\theta \leq 70^\circ\text{C}$ (AF) $0.85 \times U_c \text{ min...} U_c \text{ max.}$ - (AF..Z) $0.85 \times U_c \text{ min...} 1.1 \times U_c \text{ max.}$			
AC control voltage	Rated control circuit voltage $U_c$	24...500 V AC			
50/60 Hz	Coil consumption	Average pull-in value	(AF) 50 VA - (AF..Z) 16 VA		
		Average holding value	(AF) 2.2 VA / 2 W - (AF..Z) 1.7 VA / 1.5 W		
DC control voltage	Rated control circuit voltage $U_c$	12...500 V DC			
	Coil consumption	Average pull-in value	(AF) 50 W - (AF..Z) 12...16 W		
		Average holding value	(AF) 2 W - (AF..Z) 1.7 W		
PLC-output control		(AF..Z) $\geq 500 \text{ mA}$ 24 V DC			
Drop-out voltage		$\leq 60\%$ of $U_c \text{ min.}$			
Voltage sag immunity acc. to SEMI F47-0706		(AF..Z) conditions of use on request			
Dips withstand $-20^\circ\text{C} \leq \theta \leq +60^\circ\text{C}$		(AF..Z) 22 ms average for $U_c \geq 24 \text{ V}$ 50/60 Hz or $U_c \geq 20 \text{ V}$ DC			
Operating time	Between coil energization and:	N.O. contact closing	40...95 ms		
		N.C. contact opening	38...90 ms		
	Between coil de-energization and:	N.O. contact opening	11...95 ms		
		N.C. contact closing	13...98 ms		













### Mounting characteristics and conditions for use

Contactor types	AC / DC operated	AF09..S	AF12..S	AF16..S	AF26..S
Mounting positions					
Mounting distances		Max. N.C. built-in and add-on N.C. auxiliary contacts: see accessory fitting details for a 3-pole contactor AF09..S ... AF26..S			
Fixing	On rail according to IEC 60715, EN 60715 By screws (not supplied)	The contactors can be assembled side by side 35 x 7.5 mm or 35 x 15 mm 2 x M4 screws placed diagonally			

# AF09..S ... AF26..S 3-pole contactors - with spring terminals

## Technical data

### Connecting characteristics

Contactor types	AC / DC operated	AF09..S	AF12..S	AF16..S	AF26..S
Main terminals					
Connection capacity (min. ... max.)		Spring terminals			
<b>Main conductors (poles)</b>					
 Rigid	Solid ( $\leq 4 \text{ mm}^2$ )	1 x	1...2.5 mm <sup>2</sup>		1.5...4 mm <sup>2</sup>
 Flexible with non insulated ferrule		2 x	1...2.5 mm <sup>2</sup>		1.5...4 mm <sup>2</sup>
 Flexible with insulated ferrule		1 x	0.75...2.5 mm <sup>2</sup>		1.5...4 mm <sup>2</sup>
 Flexible with insulated ferrule		2 x	0.75...2.5 mm <sup>2</sup>		1.5...4 mm <sup>2</sup>
 Flexible with insulated ferrule		1 x	0.75...1.5 mm <sup>2</sup>		1.5...4 mm <sup>2</sup>
 Flexible with insulated ferrule		2 x	0.75...1.5 mm <sup>2</sup>		1.5...4 mm <sup>2</sup>
Connection capacity acc. to UL/CSA		1 or 2 x	AWG 18...12		-
Stripping length			10 mm		14 mm
<b>Auxiliary conductors</b> (built-in auxiliary terminals + coil terminals)					
 Rigid solid		1 x	1...2.5 mm <sup>2</sup>		
 Flexible with non insulated ferrule		2 x	1...2.5 mm <sup>2</sup>		
 Flexible with insulated ferrule		1 x	0.75...2.5 mm <sup>2</sup>		
 Flexible with insulated ferrule		2 x	0.75...2.5 mm <sup>2</sup>		
 Flexible with insulated ferrule		1 x	0.75...1.5 mm <sup>2</sup>		
 Flexible with insulated ferrule		2 x	0.75...1.5 mm <sup>2</sup>		
Connection capacity acc. to UL/CSA		1 or 2 x	AWG 18...14		-
Stripping length			10 mm		
<b>Degree of protection</b>					
acc. to IEC 60947-1 / EN 60947-1 and IEC 60529 / EN 60529					
Main terminals			IP20		
Coil terminals			IP20		
Built-in auxiliary terminals			IP20		
Screwdriver type			Flat Ø 3.5		

# AF09..S ... AF26..S 3-pole contactors - with spring terminals

## Technical data

### Built-in auxiliary contacts according to IEC

Contactor types	AC / DC operated	AF09..S	AF12..S	AF16..S	AF26..S
Rated operational voltage $U_e$ max.		690 V			
Rated frequency (without derating)		50/60 Hz			
Conventional free air thermal current $I_{th} - \theta \leq 40^\circ\text{C}$		16 A			
<b>le / Rated operational current AC-15</b> acc. to IEC 60947-5-1	24-127 V 50/60 Hz	6 A			
	220-240 V 50/60 Hz	4 A			
	400-440 V 50/60 Hz	3 A			
	500 V 50/60 Hz	2 A			
	690 V 50/60 Hz	2 A			
<b>Making capacity AC-15</b>		10 x $le$ AC-15 acc. to IEC 60947-5-1			
<b>Breaking capacity AC-15</b>		10 x $le$ AC-15 acc. to IEC 60947-5-1			
<b>le / Rated operational current DC-13</b> acc. to IEC 60947-5-1	24 V DC	6 A / 144 W			
	48 V DC	2.8 A / 134 W			
	72 V DC	1 A / 72 W			
	110 V DC	0.55 A / 60 W			
	125 V DC	0.55 A / 69 W			
	220 V DC	0.27 A / 60 W			
	250 V DC	0.27 A / 68 W			
	400 V DC	0.15 A / 60 W			
	500 V DC	0.13 A / 65 W			
	600 V DC	0.1 A / 60 W			
<b>Short-circuit protection device gG type fuse</b>		10 A			
<b>Rated short-time withstand current <math>I_{cw}</math></b>	for 1.0 s	100 A			
	for 0.1 s	140 A			
<b>Minimum switching capacity</b> with failure rate acc. to IEC 60947-5-4		12 V / 3 mA			
<b>Non-overlapping time between N.O. and N.C. contacts</b>		$\geq 2$ ms			
<b>Power dissipation per pole at 6 A</b>		0.1 W			
<b>Max. electrical switching frequency</b>	AC-15	1200 cycles/h			
	DC-13	900 cycles/h			
<b>Mechanically linked contacts</b> (according to annex L of IEC 60947-5-1)		Built-in N.O. or N.C. auxiliary contacts and additional N.O. or N.C. auxiliary contacts (CA4..S, CAL4..S, CAT4..S aux. contact blocks) are mechanically linked contacts.			
<b>Mirror contacts</b> (according to annex F of IEC 60947-4-1)		Built-in N.C. auxiliary contacts or additional N.C. auxiliary contacts (CA4..S, CAL4..S, CAT4..S aux. contact blocks) are mirror contacts.			

### Built-in auxiliary contacts according to UL / CSA

Contactor types	AC / DC operated	AF09..S	AF12..S	AF16..S	AF26..S
<b>Max. operational voltage</b>		600 V AC, 600 V DC			-
<b>Pilot duty</b>		A600, Q600			-
AC thermal rated current		10 A			-
AC maximum volt-ampere making		7200 VA			-
AC maximum volt-ampere breaking		720 VA			-
DC thermal rated current		2.5 A			-
DC maximum volt-ampere making-breaking		69 VA			-

# AF09..S ... AF26..S 3-pole contactors - with spring terminals

## Terminal marking and positioning

### AF09..S ... AF26..S contactors - AC / DC operated

Standard devices without addition of auxiliary contacts

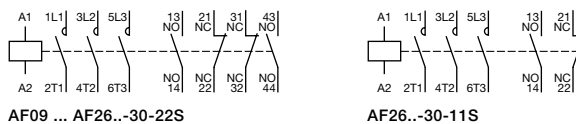
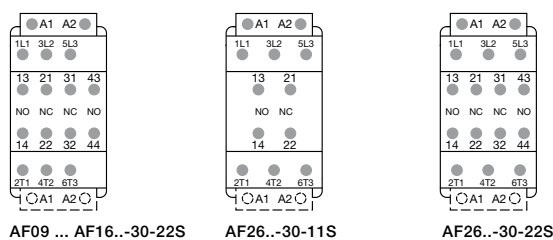
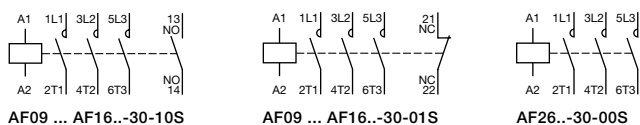
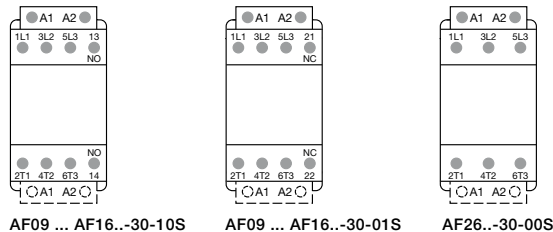

Other possible contact combinations with auxiliary contacts added by the user

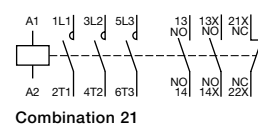
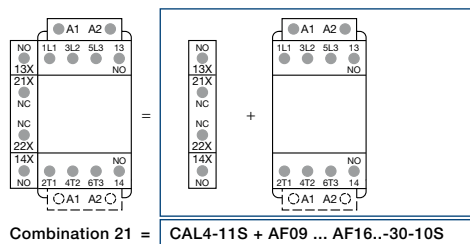
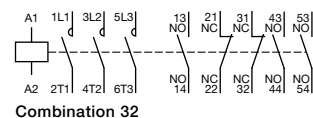
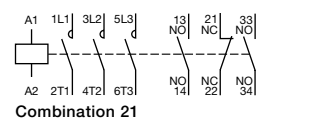
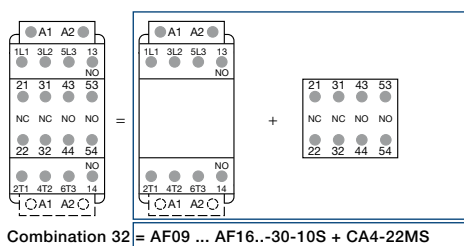
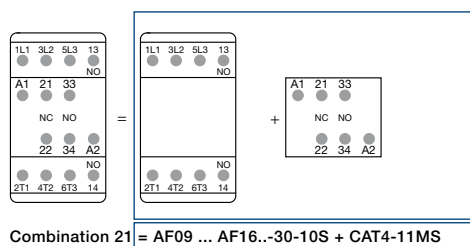
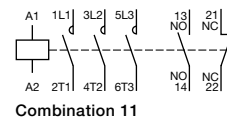
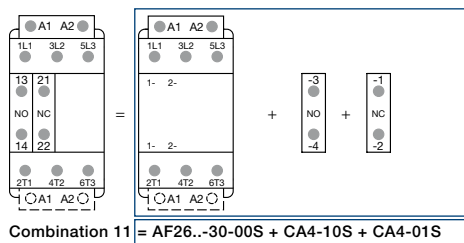
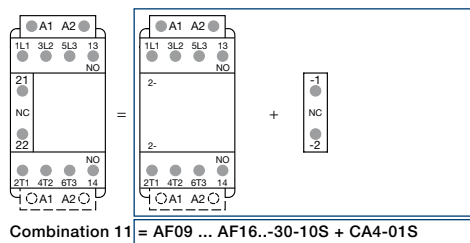

Note: Only AF.Z contactor with DC control voltage 12...20 V DC need to respect the connection polarities indicated close to the coil terminals: A1+ for the positive pole and A2- for the negative pole.

# AF09..S ... AF16..S 3-pole contactors - with spring terminals

## Main dimensions mm, inches

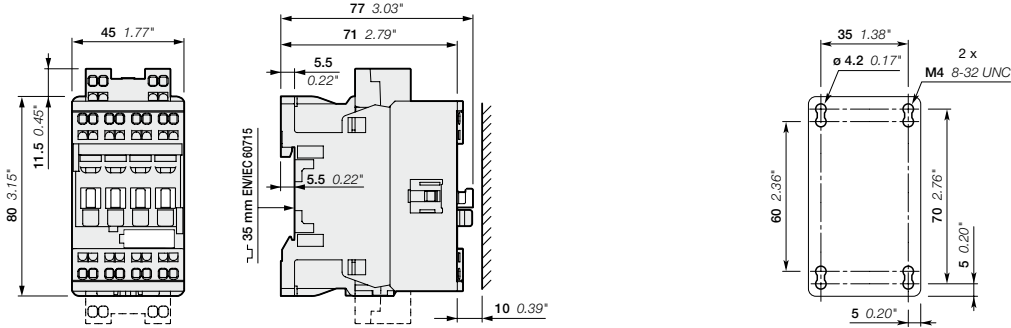

AF09..S, AF12..S, AF16..S

6

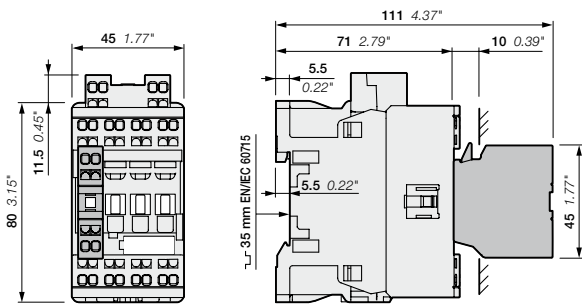

AF09..S, AF12..S, AF16..S  
+ CA4..S 1-pole auxiliary contact block

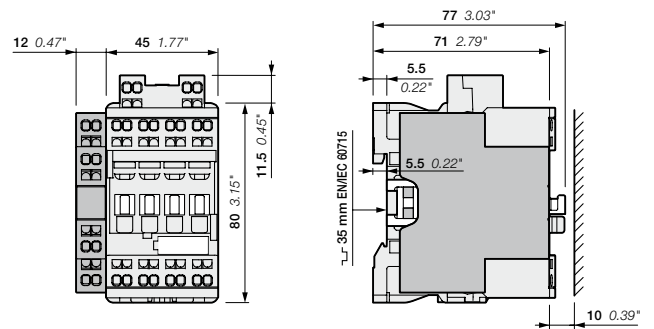

AF09..S, AF12..S, AF16..S  
+ CAL4-11S 2-pole auxiliary contact block

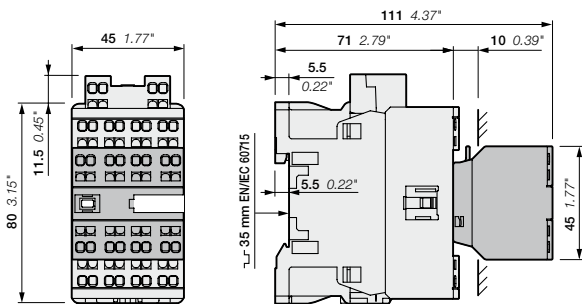

AF09..S, AF12..S, AF16..S  
+ CA4..S 4-pole auxiliary contact block

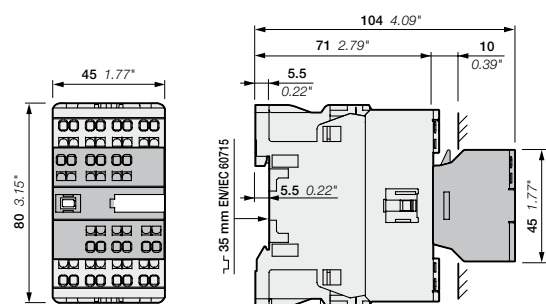

AF09..S, AF12..S, AF16..S  
+ CAT4..S 2-pole auxiliary contact and coil terminal block

Note: contactor lateral distance to grounded component 2 mm 0.08" min.

# AF26..S 3-pole contactors - with spring terminals

## Main dimensions mm, inches

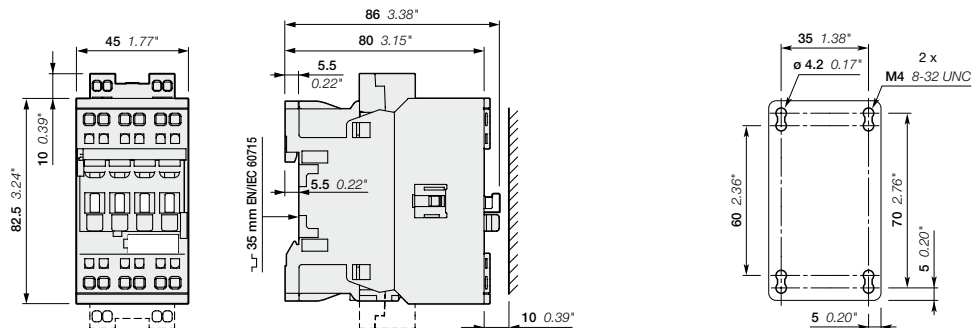

AF26..S

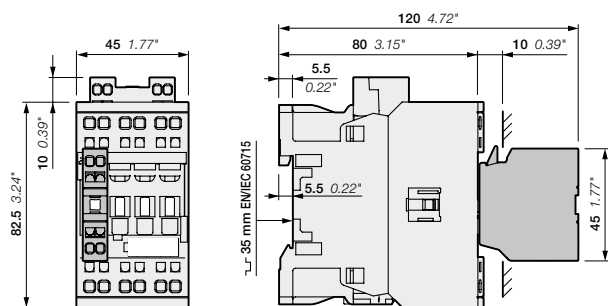

AF26..S  
+ CA4..S 1-pole auxiliary contact block

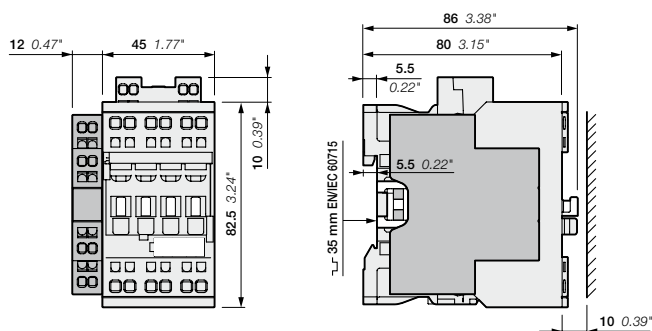

AF26..S  
+ CAL4-11S 2-pole auxiliary contact block

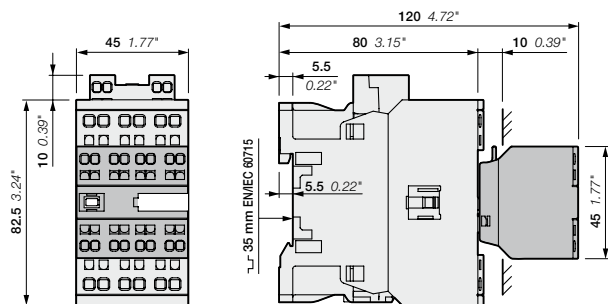

AF26..S  
+ CA4..S 4-pole auxiliary contact block

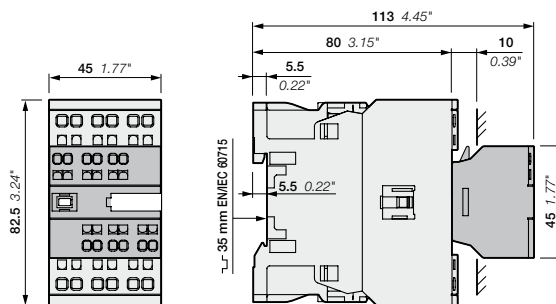

AF26..S  
+ CAT4..S 2-pole auxiliary contact and coil terminal block

Note: contactor lateral distance to grounded component 2 mm 0.08" min.

# AF09..S ... AF26..S 3-pole contactors - with spring terminals

## Main dimensions mm, inches

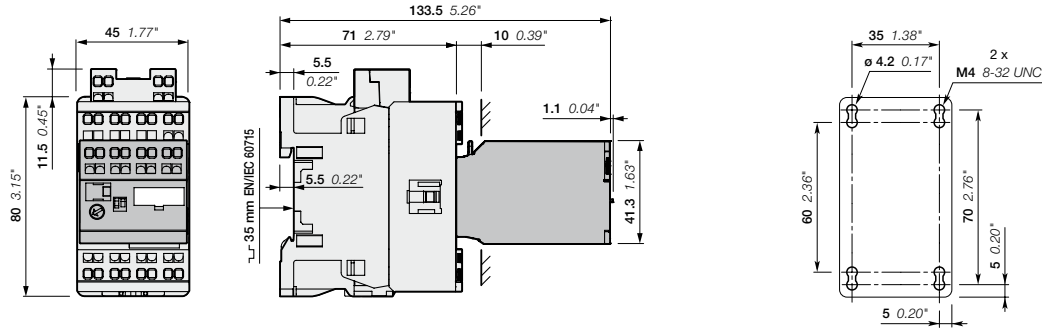

AF09..S, AF12..S, AF16..S  
+ TEF4S

6

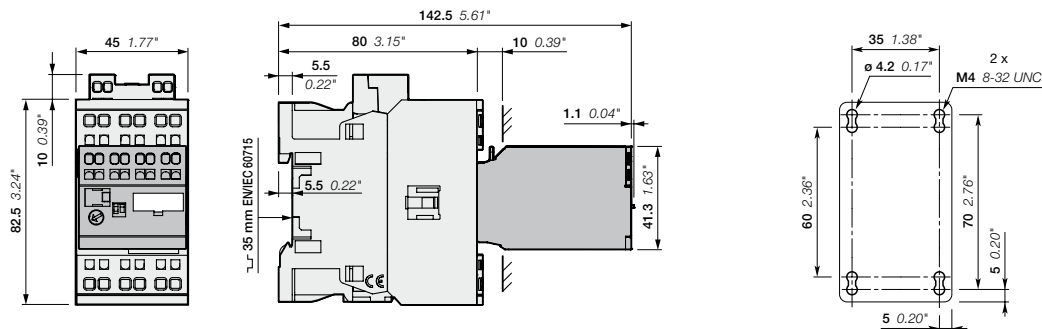

AF26..S  
+ TEF4S

Note: contactor lateral distance to grounded component 2 mm 0.08" min.



# AF09..S ... AF26..S 2-stack 3-pole contactors - with spring terminal

## Main dimensions mm, inches

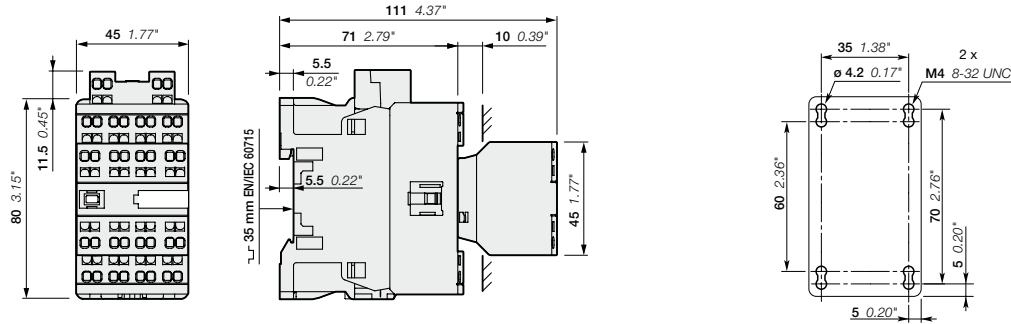

AF09, AF12, AF16..-30-22S

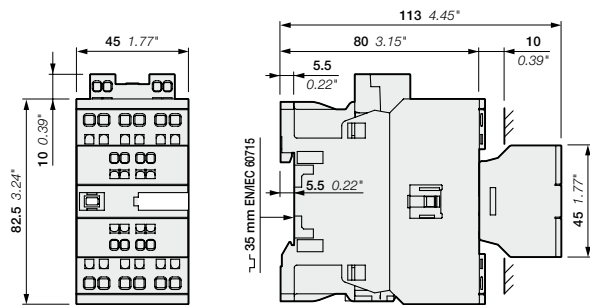

AF26..-30-11S

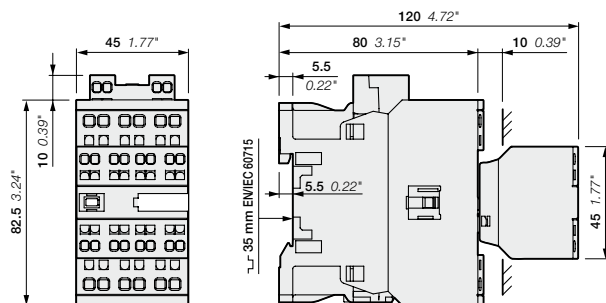

AF26..-30-22S

Note: contactor lateral distance to grounded component 2 mm 0.08" min.

# Contactor relays - with spring terminals

## Main accessories

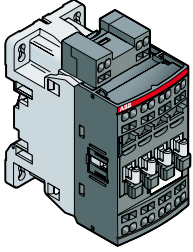

**NF22ES, NF31ES and NF40ES**  
4-pole contactor relays

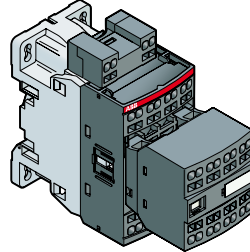

**NF44ES, NF53ES, NF62ES, NF71ES and NF80ES**  
8-pole contactor relays

6

## Main accessories for contactor relays

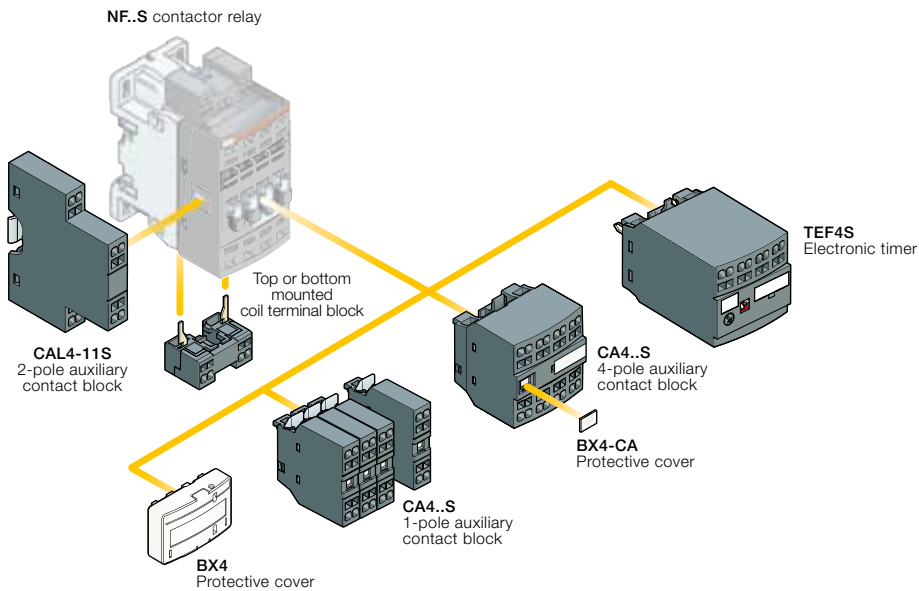

# Contactors relays - with spring terminals



## Spring terminals



	AC / DC Control voltage	NF22ES	NF31ES	NF40ES
		2N.O. + 2N.C.	3N.O. + 1N.C.	4N.O.



	AC / DC Control supply	NF44ES	NF53ES	NF62ES	NF71ES	NF80ES
		4N.O. + 4N.C.	5N.O. + 3N.C.	6N.O. + 2N.C.	7N.O. + 1N.C.	8N.O.

## Control circuit switching

IEC	AC-15	Rated operational current	240 V	4 A
			400 V	3 A
			690 V	2 A
UL/CSA	Pilot Duty	24 V	6 A / 144 W	
		250 V	0.27 A / 68 W	

## Main accessories

Auxiliary contact blocks	Front mounting		1-pole <b>CA4-10S</b> or <b>CA4-01S</b> 4-pole <b>CA4..S</b>
	Side mounting		2-pole <b>CAL4-11S</b>
Additional coil terminal block			<b>LDC4S</b>
Protective covers			<b>BX4</b> For all 1-stack contactor relays <b>BX4-CA</b> For 4-pole CA4..S auxiliary contact blocks

# NF..S 4-pole contactor relays - with spring terminals AC / DC operated



NF22ES

1SBG10109F0014

## Description

NF..S contactor relays are used for switching auxiliary and control circuits.

These contactors relays are of the block type design with:

- 4 poles. Contactor relays have mechanically linked auxiliary contact elements (side-marked symbol)
- control circuit: AC or DC operated with electronic coil interface accepting a wide control voltage range (e.g. 100...250 V AC and DC)
- can manage large control voltage variations
- only 4 control voltage ranges covering 24...500 V 50/60 Hz and 20...500 V DC
- reduced panel energy consumption
- very distinct closing and opening.
- built-in surge suppression
- add-on auxiliary contact blocks for front or side mounting and a wide range of accessories.

## Ordering details

Number of contacts	Rated control circuit voltage Uc min. ... Uc max.		Type	Order code	Weight  Pkg (1 pce) kg	
	V 50/60 Hz	V DC				
	24...60	-	(1)	NF22ES-41	1SBH137004R4122	0.270
	48...130	48...130		NF22ES-12	1SBH137004R1222	0.270
	100...250	100...250		NF22ES-13	1SBH137004R1322	0.270
	250...500	250...500		NF22ES-14	1SBH137004R1422	0.310
	24...60	-	(1)	NF31ES-41	1SBH137004R4131	0.270
	48...130	48...130		NF31ES-12	1SBH137004R1231	0.270
	100...250	100...250		NF31ES-13	1SBH137004R1331	0.270
	250...500	250...500		NF31ES-14	1SBH137004R1431	0.310
	24...60	-	(1)	NF40ES-41	1SBH137004R4140	0.270
	48...130	48...130		NF40ES-12	1SBH137004R1240	0.270
	100...250	100...250		NF40ES-13	1SBH137004R1340	0.270
	250...500	250...500		NF40ES-14	1SBH137004R1440	0.310

(1) For 24...60 V 50/60 Hz - 20...60 V DC, use NF..ES-11 (see voltage code table).  
NF..ES-11 not suitable for direct control by PLC-output.

## Main dimensions mm, inches

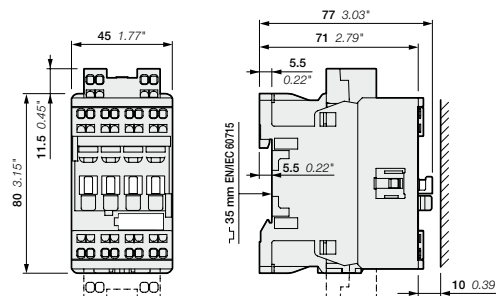

NF22ES, NF31ES, NF40ES

1SBG101691S0201 - Rev. A

# NFZ..S 4-pole contactor relays - with spring terminals AC / DC operated - low consumption



NFZ22ES

## Description

NFZ..S contactor relays are used for switching auxiliary and control circuits.

These contactors relays are of the block type design with:

- 4 poles. Contactor relays have mechanically linked auxiliary contact elements (side-marked symbol)
- control circuit: AC or DC operated with electronic coil interface accepting a wide control voltage range (e.g. 100...250 V AC and DC)
  - can manage large control voltage variations
  - only 4 control voltage ranges covering 24...250 V 50/60 Hz and 12...250 V DC
  - allow direct control by PLC-output  $\geq 24$  V DC 500 mA
  - reduced panel energy consumption
  - very distinct closing and opening
  - can withstand short voltage dips and voltage sags (SEMI F47-0706 conditions of use on request).
- built-in surge suppression
- add-on auxiliary contact blocks for front or side mounting and a wide range of accessories.

## Ordering details

Number of contacts	Rated control circuit voltage <i>U<sub>c</sub> min. ... U<sub>c</sub> max.</i>		Type	Order code	Weight  Pkg (1 pce) kg
	V 50/60 Hz	V DC			
	-	12...20	NFZ22ES-20	1SBH136004R2022	0.310
	24...60	20...60	NFZ22ES-21	1SBH136004R2122	0.310
	48...130	48...130	NFZ22ES-22	1SBH136004R2222	0.310
	100...250	100...250	NFZ22ES-23	1SBH136004R2322	0.310
	-	12...20	NFZ31ES-20	1SBH136004R2031	0.310
	24...60	20...60	NFZ31ES-21	1SBH136004R2131	0.310
	48...130	48...130	NFZ31ES-22	1SBH136004R2231	0.310
	100...250	100...250	NFZ31ES-23	1SBH136004R2331	0.310
	-	12...20	NFZ40ES-20	1SBH136004R2040	0.310
	24...60	20...60	NFZ40ES-21	1SBH136004R2140	0.310
	48...130	48...130	NFZ40ES-22	1SBH136004R2240	0.310
	100...250	100...250	NFZ40ES-23	1SBH136004R2340	0.310

Note: Only NFZ..S contactor relays with DC control voltage 12...20 V DC need to respect the connection polarities indicated close to the coil terminals: A1+ for the positive pole and A2- for the negative pole.

## Main dimensions mm, inches

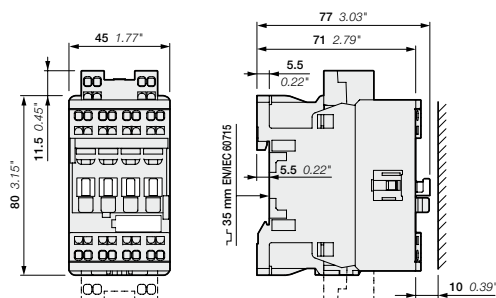

NFZ22ES, NFZ31ES, NFZ40ES

# NF..S 8-pole contactor relays - with spring terminals

## AC / DC operated



NF44ES

### Description

NF..S contactor relays are used for switching auxiliary and control circuits.

These contactors relays are of the block type design with:

- 8 poles with a permanently fixed 4-pole auxiliary contact block. Contactor relays have mechanically linked auxiliary contact elements (side-marked symbol)
- control circuit: AC or DC operated with electronic coil interface accepting a wide control voltage range (e.g. 100...250 V AC and DC)
  - can manage large control voltage variations
  - only 4 control voltage ranges covering 24...500 V 50/60 Hz and 20...500 V DC
  - reduced panel energy consumption
  - very distinct closing and opening.
- built-in surge suppression
- add-on auxiliary contact blocks for side mounting and a wide range of accessories.

### Ordering details

Number of contacts		Rated control circuit voltage Uc min. ... Uc max.	Type	Order code	Weight Pkg (1 pce) kg		
1st stack	2nd stack						
		V 50/60 Hz	V DC				
		24...60	-	(1)	NF44ES-41	1SBH137004R4144	0.320
		48...130	48...130		NF44ES-12	1SBH137004R1244	0.320
		100...250	100...250		NF44ES-13	1SBH137004R1344	0.320
		250...500	250...500		NF44ES-14	1SBH137004R1444	0.360
		24...60	-	(1)	NF53ES-41	1SBH137004R4153	0.320
		48...130	48...130		NF53ES-12	1SBH137004R1253	0.320
		100...250	100...250		NF53ES-13	1SBH137004R1353	0.320
		250...500	250...500		NF53ES-14	1SBH137004R1453	0.360
		24...60	-	(1)	NF62ES-41	1SBH137004R4162	0.320
		48...130	48...130		NF62ES-12	1SBH137004R1262	0.320
		100...250	100...250		NF62ES-13	1SBH137004R1362	0.320
		250...500	250...500		NF62ES-14	1SBH137004R1462	0.360
		24...60	-	(1)	NF71ES-41	1SBH137004R4171	0.320
		48...130	48...130		NF71ES-12	1SBH137004R1271	0.320
		100...250	100...250		NF71ES-13	1SBH137004R1371	0.320
		250...500	250...500		NF71ES-14	1SBH137004R1471	0.360
		24...60	-	(1)	NF80ES-41	1SBH137004R4180	0.320
		48...130	48...130		NF80ES-12	1SBH137004R1280	0.320
		100...250	100...250		NF80ES-13	1SBH137004R1380	0.320
		250...500	250...500		NF80ES-14	1SBH137004R1480	0.360

(1) For 24...60 V 50/60 Hz - 20...60 V DC, use NF..ES-11 (see voltage code table).  
NF..ES-11 not suitable for direct control by PLC-output.

### Main dimensions mm, inches

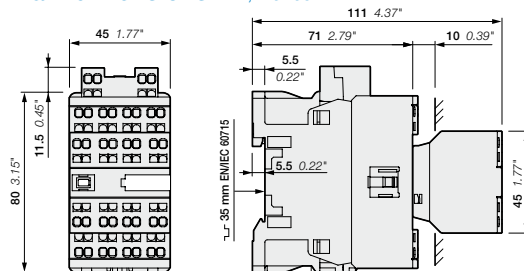

NF44ES, NF53ES, NF62ES, NF71ES, NF80ES

# NFZ..S 8-pole contactor relays - with spring terminals AC / DC operated - low consumption



NFZ44ES

## Description

NFZ..S contactor relays are used for switching auxiliary and control circuits.

These contactors relays are of the block type design with:

- 8 poles with a permanently fixed 4-pole auxiliary contact block. Contactor relays have mechanically linked auxiliary contact elements (side-marked symbol)
- control circuit: AC or DC operated with electronic coil interface accepting a wide control voltage range (e.g. 100...250 V AC and DC)
  - can manage large control voltage variations
  - only 4 control voltage ranges covering 24...250 V 50/60 Hz and 12...250 V DC
  - allow direct control by PLC-output  $\geq 24$  V DC 500 mA
  - reduced panel energy consumption
  - very distinct closing and opening
  - can withstand short voltage dips and voltage sags (SEMI F47-0706 conditions of use on request).
- built-in surge suppression
- add-on auxiliary contact blocks for side mounting and a wide range of accessories.

## Ordering details

Number of contacts		Rated control circuit voltage Uc min. ... Uc max.	Type	Order code	Weight Pkg (1 pce) kg	
1st stack	2nd stack					
		V 50/60 Hz	V DC			
		-	12...20	NFZ44ES-20	1SBH136004R2044	0.360
		24...60	20...60	NFZ44ES-21	1SBH136004R2144	0.360
		48...130	48...130	NFZ44ES-22	1SBH136004R2244	0.360
		100...250	100...250	NFZ44ES-23	1SBH136004R2344	0.360
		-	12...20	NFZ53ES-20	1SBH136004R2053	0.360
		24...60	20...60	NFZ53ES-21	1SBH136004R2153	0.360
		48...130	48...130	NFZ53ES-22	1SBH136004R2253	0.360
		100...250	100...250	NFZ53ES-23	1SBH136004R2353	0.360
		-	12...20	NFZ62ES-20	1SBH136004R2062	0.360
		24...60	20...60	NFZ62ES-21	1SBH136004R2162	0.360
		48...130	48...130	NFZ62ES-22	1SBH136004R2262	0.360
		100...250	100...250	NFZ62ES-23	1SBH136004R2362	0.360
		-	12...20	NFZ71ES-20	1SBH136004R2071	0.360
		24...60	20...60	NFZ71ES-21	1SBH136004R2171	0.360
		48...130	48...130	NFZ71ES-22	1SBH136004R2271	0.360
		100...250	100...250	NFZ71ES-23	1SBH136004R2371	0.360
		-	12...20	NFZ80ES-20	1SBH136004R2080	0.360
		24...60	20...60	NFZ80ES-21	1SBH136004R2180	0.360
		48...130	48...130	NFZ80ES-22	1SBH136004R2280	0.360
		100...250	100...250	NFZ80ES-23	1SBH136004R2380	0.360

Note: Only NFZ..S contactor relays with DC control voltage 12...20 V DC need to respect the connection polarities indicated close to the coil terminals: A1+ for the positive pole and A2- for the negative pole.

## Main dimensions mm, inches

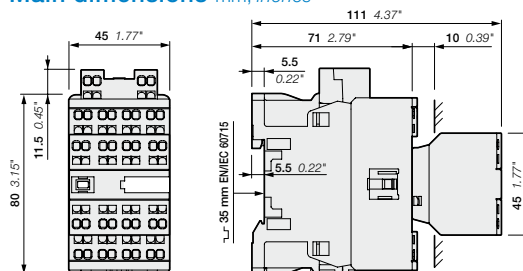

NFZ44ES, NFZ53ES, NFZ62ES, NFZ71ES, NFZ80ES

# NF..S contactor relays - with spring terminals

## Main accessories

### Contactor relays and main accessories (other accessories available)

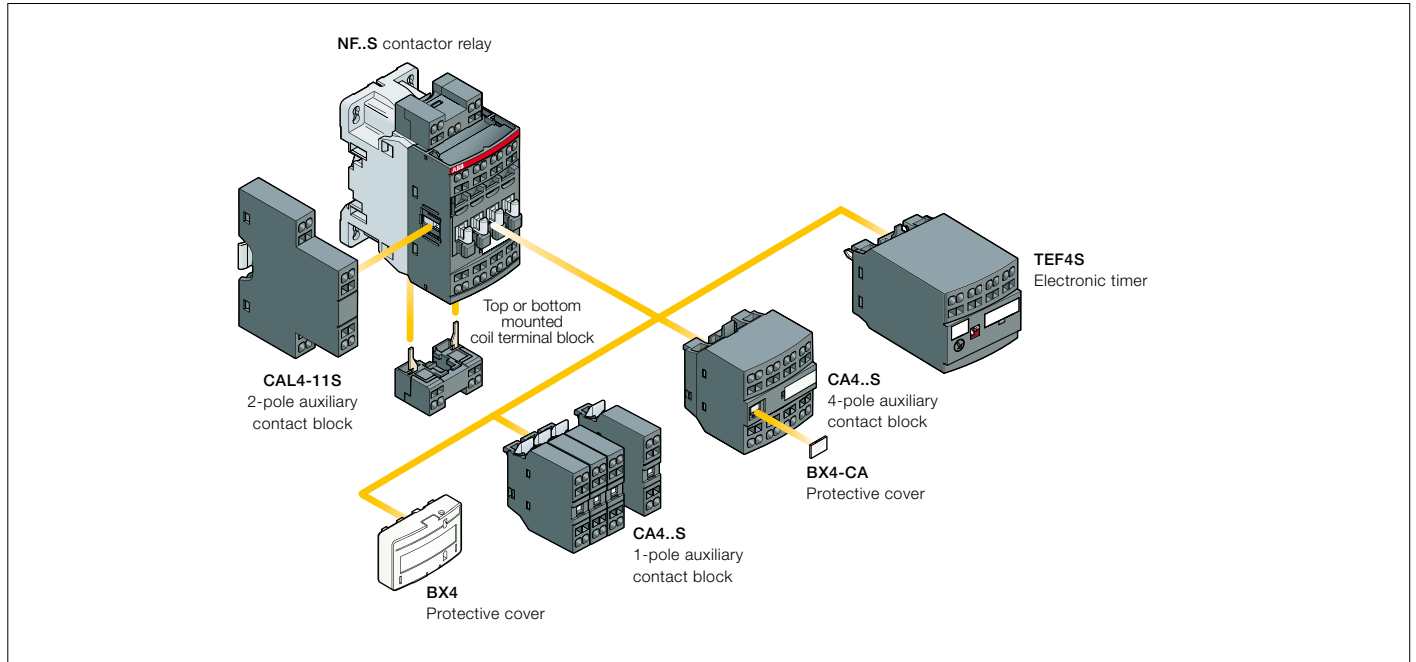

### Main accessory fitting details

Many configurations of accessories are possible depending on whether these are front-mounted or side-mounted.

Contactor relay types	Main poles	Front-mounted accessories			Side-mounted accessories	
		Auxiliary contact blocks		Electronic timer	Auxiliary contact blocks	
		1-pole CA4..S	4-pole CA4..S	TEF4S	Left side 2-pole CAL4-11S	Right side
Max. add-on N.C. auxiliary contacts: 3 N.C. max. on positions 1, 2, 3, 4 and 2 N.C. max. on positions 1 ±30°, 5						
NF..	2 2 ES 3 1 ES	4 max. 2 max.	or 1 -	or 1 or 1	+ 1 + 1	- + 1
Max. add-on N.C. auxiliary contacts: 4 N.C. max. on positions 1, 2, 3, 4 and 3 N.C. max. on positions 1 ±30°, 5						
NF..	4 0 ES	4 max. 2 max.	or 1 -	or 1 or 1	+ 1 + 1	- + 1
NF..	4 4 ES 5 3 ES 6 2 ES 7 1 ES 8 0 ES	-	-	-	1	-



# NF..S contactor relays - with spring terminals

## Main accessories



CA4-10S

1SBC101110F0014



CA4-22MS

1SBC101125F0014



CAL4-11S

1SBC101113F0014



TEF4S-OFF

1SBC101393F0014



LDC4S

1SBC101135F0014



BX4



1SBC101136F0014



BX4-CA

1SBC101139F0014

### Ordering details (1)

For contactor relays	Auxiliary contacts	Type	Order code	Pkg qty	Weight (1 pce)
	 				kg



### Front-mounted instantaneous auxiliary contact blocks

NF..S	1	0	CA4-10S	1SBN010119R1010	1	0.016
	1	0	CA4-10S-T	1SBN010119T1010	10	0.016
	0	1	CA4-01S	1SBN010119R1001	1	0.016
	0	1	CA4-01S-T	1SBN010119T1001	10	0.016
NF..S	2	2	CA4-22NS	1SBN010145R1222	1	0.060
	3	1	CA4-31NS	1SBN010145R1231	1	0.060
	4	0	CA4-40NS	1SBN010145R1240	1	0.060

### Side-mounted instantaneous auxiliary contact blocks

NF..S	1	1	CAL4-11S	1SBN010130R1011	1	0.045
-------	---	---	----------	-----------------	---	-------

### Ordering details (1)

For contactor relays	Time delay range selected by switch	Delay type	Rated control circuit voltage U <sub>c</sub>	Auxiliary contacts	Type	Order code	Pkg qty	Weight (1 pce)
			V 50/60 Hz or DC	 				kg

### Front-mounted electronic timer

NF..S	0.1...1 s	ON-delay	24...240	1	1	TEF4S-ON	1SBN020113R1000	1	0.065
	1...10 s	OFF-delay	24...240	1	1	TEF4S-OFF	1SBN020115R1000	1	0.065
	10...100 s								

### Ordering details (1)

For contactors	Type	Order code	Pkg qty	Weight (1 pce)
				kg

### Additional coil terminal block

NF..S	LDC4S	1SBN070157T1000	10	0.010
-------	-------	-----------------	----	-------

### Protective covers

All 1-stack contactor relays	BX4	1SBN110108T1000	10	0.006
For 4-pole CA4..S auxiliary contact blocks	BX4-CA	1SBN110109W1000	50	0.001

(1) See "Main accessory fitting details" table.

# NF..S contactor relays - with spring terminals

## Technical data

### Contact utilization characteristics according to IEC

Contactor relay types	AC / DC operated	NF..S
Standards		IEC 60947-1 / 60947-5-1 and EN 60947-1 / 60947-5-1
Rated operational voltage U <sub>e</sub> max.		690 V
Rated frequency (without derating)		50/60 Hz
Conventional free-air thermal current I <sub>th</sub> θ ≤ 40 °C		16 A
le / Rated operational current AC-15		
acc. to IEC 60947-5-1	24-127 V 50/60 Hz	6 A
	220-240 V 50/60 Hz	4 A
	400-440 V 50/60 Hz	3 A
	500 V 50/60 Hz	2 A
	690 V 50/60 Hz	2 A
Rated making capacity AC-15		10 x I <sub>e</sub> AC-15 acc. to IEC 60947-5-1
Rated breaking capacity AC-15		10 x I <sub>e</sub> AC-15 acc. to IEC 60947-5-1
le / Rated operational current DC-13		
acc. to IEC 60947-5-1	24 V DC	6 A / 144 W
	48 V DC	2.8 A / 134 W
	72 V DC	1 A / 72 W
	110 V DC	0.55 A / 60 W
	125 V DC	0.55 A / 69 W
	220 V DC	0.27 A / 60 W
	250 V DC	0.27 A / 68 W
	400 V DC	0.15 A / 60 W
	500 V DC	0.13 A / 65 W
	600 V DC	0.1 A / 60 W
Short-circuit protection device gG type fuse		10 A
Rated short-time withstand current I <sub>cw</sub>	for 1.0 s	100 A
	for 0.1 s	140 A
Minimum switching capacity		12 V / 3 mA
with failure rate acc. to IEC 60947-5-4		10 <sup>-7</sup>
Non-overlapping time between N.O. and N.C. contacts		≥ 2 ms
Power dissipation per pole at 6 A		0.1 W
Max. electrical switching frequency	AC-15	1200 cycles/h
	DC-13	900 cycles/h
Mechanically linked contacts		Built-in N.O. or N.C. auxiliary contacts and additional N.O. or N.C. auxiliary contacts (CA4..S, CAL4..S aux. contact blocks) are mechanically linked contacts
(acc. to annex L of IEC 60947-5-1)		

### Contact utilization characteristics according to UL / CSA

Contactor relay types	AC / DC operated	NF..S
Standards		UL 508, CSA C22.2 N°14
Max. operational voltage		600 V AC, 600 V DC
Pilot duty		A600, Q600
AC thermal rated current		10 A
AC maximum volt-ampere making		7200 VA
AC maximum volt-ampere breaking		720 VA
DC thermal rated current		2.5 A
DC maximum volt-ampere making-breaking		69 VA

# NF..S contactor relays - with spring terminals

## Technical data

### General technical data

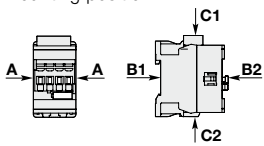
Contactor relay types	AC / DC operated	NF..S
<b>Rated insulation voltage <math>U_i</math></b> acc. to IEC 60947-5-1 acc. to UL/CSA		690 V 600 V
<b>Rated impulse withstand voltage <math>U_{imp}</math></b>		6 kV
<b>Electromagnetic compatibility</b>		Devices complying with IEC 60947-1 / EN 60947-1 - Environment A
<b>Ambient air temperature</b> close to contactor relay Operation in free air Storage		-40...+70 °C -60...+80 °C
<b>Climatic withstand</b>		Category B according to IEC 60947-1 Annex Q
<b>Maximum operating altitude (without derating)</b>		3000 m
<b>Mechanical durability</b> Number of operating cycles Max. switching frequency		20 millions operating cycles 6000 cycles/h
<b>Shock withstand</b> acc. to IEC 60068-2-27 and EN 60068-2-27 Mounting position 1	<b>Shock direction</b>	1/2 sinusoidal shock for 11 ms: no change in contact position, closed or open position
	<b>A</b>	30 g
	<b>B1</b>	25 g closed position / 5 g open position
	<b>B2</b>	15 g
	<b>C1</b>	25 g
	<b>C2</b>	25 g
<b>Vibration withstand</b> acc. to IEC 60068-2-6		5...300 Hz 4 g closed position / 2 g open position

6

### Magnet system characteristics

Contactor relay types	AC / DC operated	NF..S
<b>Coil operating limits</b> acc. to IEC 60947-5-1	<b>AC supply</b>	at $\theta \leq 60$ °C 0.85 x $U_c$ min...1.1 x $U_c$ max. at $\theta \leq 70$ °C 0.85 x $U_c$ min... $U_c$ max.
	<b>DC supply</b>	at $\theta \leq 60$ °C 0.85 x $U_c$ min...1.1 x $U_c$ max. at $\theta \leq 70$ °C (NF) 0.85 x $U_c$ min... $U_c$ max - (NFZ) 0.85 x $U_c$ min...1.1 x $U_c$ max.
<b>AC control voltage</b> Rated control circuit voltage $U_c$ 50/60 Hz Coil consumption	<b>Average pull-in value</b> <b>Average holding value</b>	24...500 V AC (NF) 50 VA - (NFZ) 16 VA (NF) 2.2 VA / 2 W - (NFZ) 1.7 VA / 1.5 W
<b>DC control voltage</b> Rated control circuit voltage $U_c$ Coil consumption	<b>Average pull-in value</b> <b>Average holding value</b>	12...500 V DC (NF) 50 W - (NFZ) 12...16 W (NF) 2 W - (NFZ) 1.7 W
<b>PLC-output control</b>		(NFZ) $\geq 500$ mA 24 V DC
<b>Drop-out voltage</b>		$\leq 60$ % of $U_c$ min.
<b>Voltage sag immunity</b> acc. to SEMI F47-0706		(NFZ) conditions of use on request
<b>Dips withstand</b> -20 °C $\leq \theta \leq$ +60 °C		(NFZ) 22 ms average for $U_c \geq 24$ V 50/60 Hz or $U_c \geq 20$ V DC
<b>Operating time</b> Between coil energization and:	<b>N.O. contact closing</b> <b>N.C. contact opening</b>	40...95 ms 38...90 ms
Between coil de-energization and:	<b>N.O. contact opening</b> <b>N.C. contact closing</b>	11...95 ms 13...98 ms

### Mounting characteristics

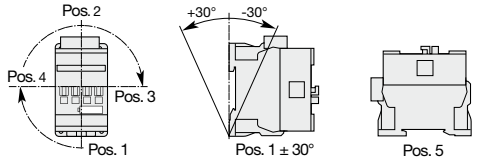





Contactor relay types	AC / DC operated	NF..S
<b>Mounting positions</b>		
<b>Mounting distances</b>		Max. add-on N.C. auxiliary contacts: see accessory fitting details for a NF..S contactor relay
<b>Fixing</b> On rail according to IEC 60715, EN 60715 By screws (not supplied)		The contactor relays can be assembled side by side. 35 x 7.5 mm or 35 x 15 mm 2 x M4 screws placed diagonally

1SBC101695S0201 - Rev. A

# NF..S contactor relays - with spring terminals

## Technical data

### Connecting characteristics

Contactor relay types	AC / DC operated	NF..S
Main terminals		 <p>Spring terminals</p>
Connection capacity (min. ... max.)		
<b>Pole and coil terminals</b>		
 Rigid	1 x	1...2.5 mm <sup>2</sup>
 Rigid	2 x	1...2.5 mm <sup>2</sup>
 Flexible with non insulated ferrule	1 x	0.75...2.5 mm <sup>2</sup>
 Flexible with non insulated ferrule	2 x	0.75...2.5 mm <sup>2</sup>
 Flexible with insulated ferrule	1 x	0.75...1.5 mm <sup>2</sup>
 Flexible with insulated ferrule	2 x	0.75...1.5 mm <sup>2</sup>
Connection capacity acc. to UL/CSA	1 or 2 x	AWG 18...12
Stripping length		10 mm
<b>Degree of protection</b>		
acc. to IEC 60947-1 / EN 60947-1 and IEC 60529 / EN 60529		
All terminals		IP20
Screwdriver type		Flat Ø 3.5

# NF..S contactor relays - with spring terminals

## Terminal marking and positioning

Standard devices without addition of auxiliary contacts

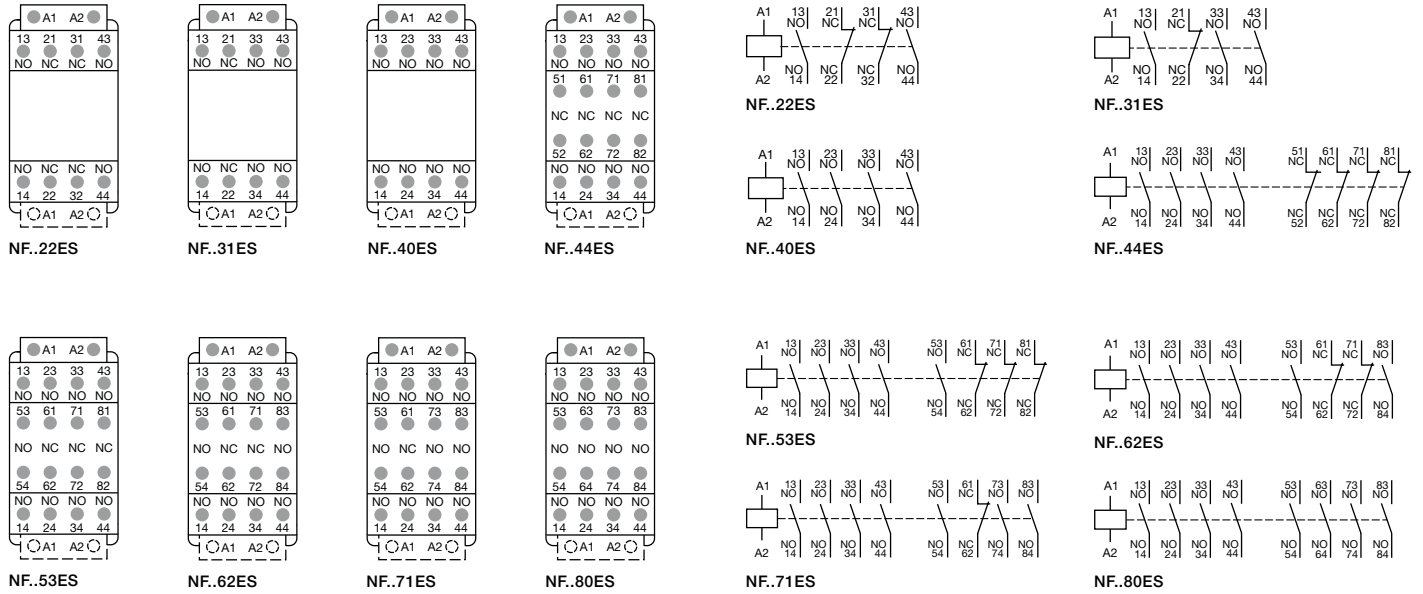

Other possible contact combinations with auxiliary contacts added by the user

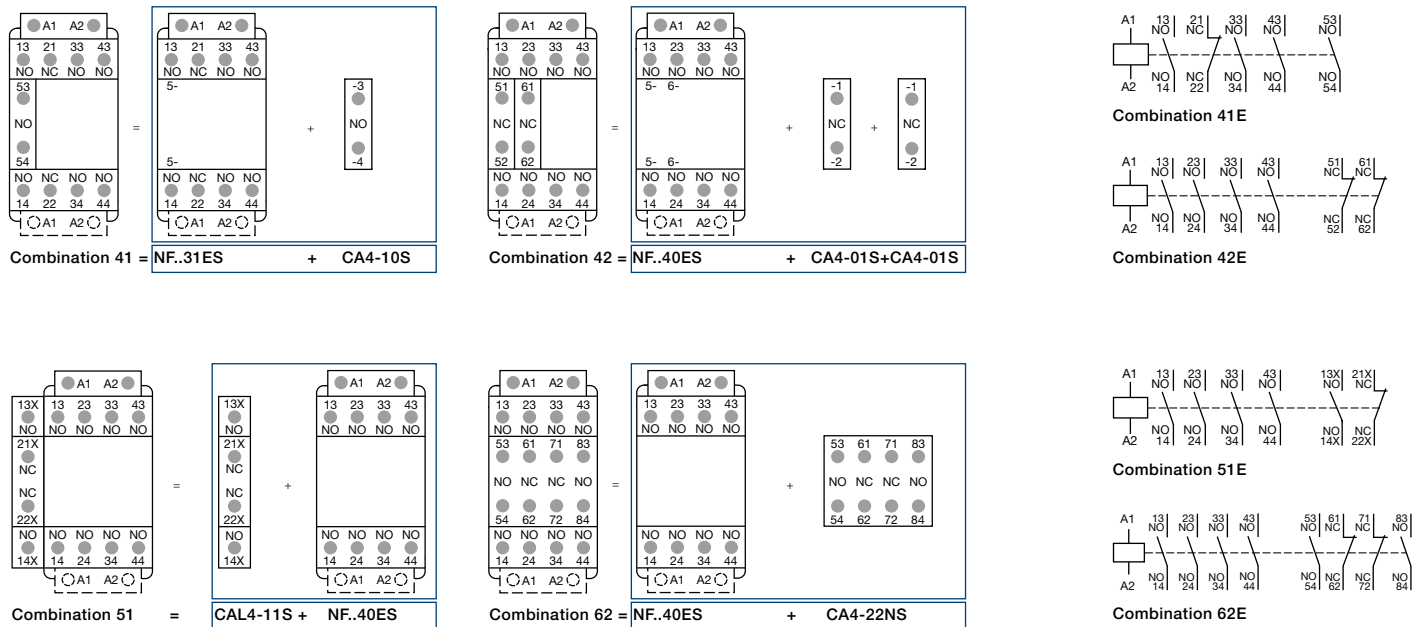

Note: Only NFZ contactor relays with DC control voltage 12...20 V DC need to respect the connection polarities indicated close to the coil terminals: A1+ for the positive pole and A2- for the negative pole.

# NF..S contactor relays - with spring terminals

## Main dimensions mm, inches

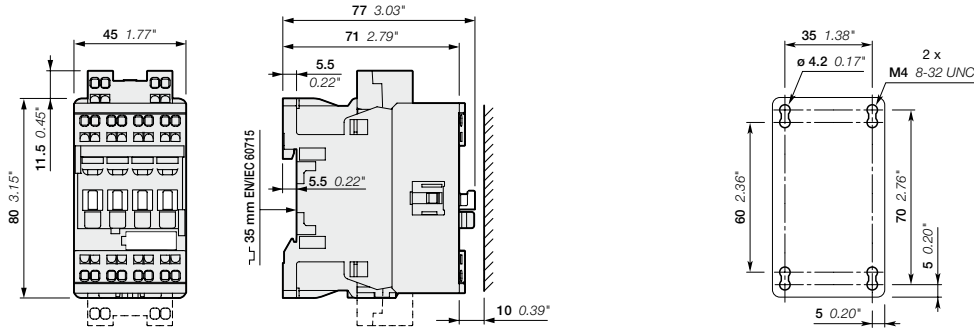

NF..22ES, NF..31ES, NF..40ES

6

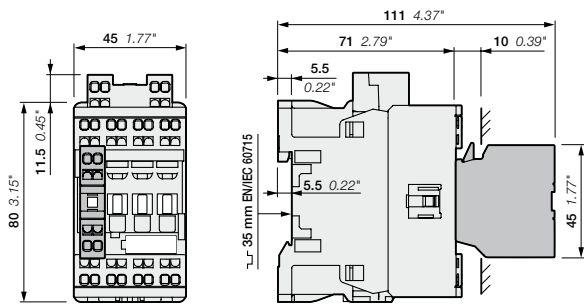

NF..22ES, NF..31ES, NF..40ES  
+ CA4..S 1-pole auxiliary contact block

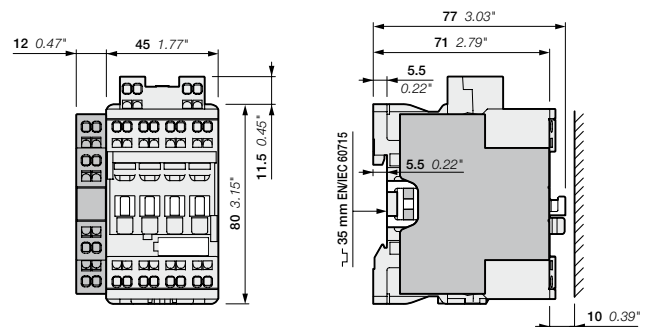

NF..22ES, NF..31ES, NF..40ES  
+ CAL4-11S 2-pole auxiliary contact block

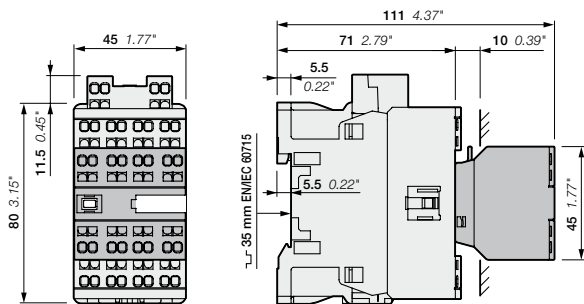

NF..22ES, NF..31ES, NF..40ES  
+ CA4..S 4-pole auxiliary contact block

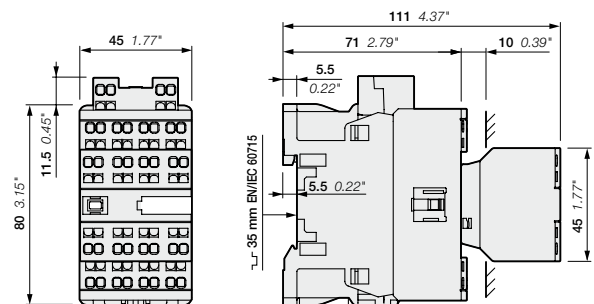

NF..44ES, NF..53ES, NF..62ES, NF..71ES, NF..80ES

Note: Contactor relay lateral distance to grounded component 2 mm 0.08" min.

# NF..S contactor relays - with spring terminals

## Main dimensions mm, inches

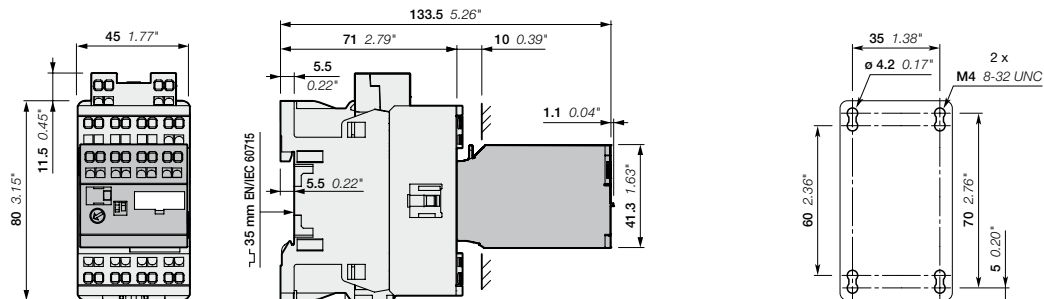

NF..22ES, NF..31ES, NF..40ES  
+ TEF4S

Note: Contactor relay lateral distance to grounded component 2 mm 0.08" min.

# Auxiliary contact blocks - with spring terminals



CA4-10S

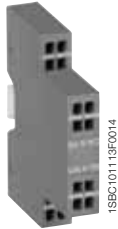

CAL4-11S



CA4-22MS



CAT4-11ES

## Description

The auxiliary contact blocks are used for the operation of auxiliary and control circuits for standard industrial environments.



Types of auxiliary contact blocks for front mounting:

- CA4..S 1 or 4-pole block, with instantaneous N.O., N.C. contacts
- CAT4..S 2-pole block, front-mounted, instantaneous N.O. + N.C. contacts with A1 / A2 coil terminal connection on front face
- CAL4..S 2-pole block, with instantaneous N.O. + N.C. contacts clipped onto the right and/or left side of the contactors.

Select the type of 2 or 4-pole auxiliary contact blocks CAT4 or CA4 (-..ES, -..MS, -..US or -..NS) according to the device type for compliance with the standard requirements (see terminal and marking positioning).

The auxiliary contact blocks are equipped with spring terminals protected against accidental direct contact and bear the corresponding function marking.

## Ordering details (1)

For contactors	Auxiliary contacts	Type	Order code	Pkg qty	Weight (1 pce)
	 				kg

## Front-mounted instantaneous auxiliary contact blocks

AF09..S ... AF38..S 4-pole NF..S	1 0 - -	CA4-10S	1SBN010119R1010	1	0.016
	1 0 - -	CA4-10S-T	1SBN010119T1010	10	0.016
	0 1 - -	CA4-01S	1SBN010119R1001	1	0.016
	0 1 - -	CA4-01S-T	1SBN010119T1001	10	0.016
AF09 ... AF16..-30-10S	2 2 - -	CA4-22MS	1SBN010145R1122	1	0.060
	3 1 - -	CA4-31MS	1SBN010145R1131	1	0.060
AF26..S	2 2 - -	CA4-22ES	1SBN010145R1022	1	0.060
	3 1 - -	CA4-31ES	1SBN010145R1031	1	0.060
	4 0 - -	CA4-40ES	1SBN010145R1040	1	0.060
4-pole NF..S	2 2 - -	CA4-22NS	1SBN010145R1222	1	0.060
	3 1 - -	CA4-31NS	1SBN010145R1231	1	0.060
	4 0 - -	CA4-40NS	1SBN010145R1240	1	0.060

## Side-mounted instantaneous auxiliary contact blocks

AF09..S ... AF26..S NF..S	1 1 - -	CAL4-11S	1SBN010130R1011	1	0.045
------------------------------	---------	----------	-----------------	---	-------

## Front-mounted instantaneous auxiliary contact and A1/A2 coil terminal blocks

AF09 ... AF16..-30-10S	1 1 - -	CAT4-11MS	1SBN010153R1111	1	0.045
AF26..S	1 1 - -	CAT4-11ES	1SBN010153R1011	1	0.045
AF09 ... AF16..-30-01S	1 1 - -	CAT4-11US	1SBN010153R1311	1	0.045

(1) For each contactor or contactor relay type, refer to "Accessory fitting details" table.

Note: CAT4..S not fittable on AF..Z contactors with DC control voltage 12...20 V DC.



# Auxiliary contact blocks - with spring terminals

## Technical data

Types	1-pole CA4..S, 4-pole CA4..S, 2-pole CAT4..S, 2-pole CAL4..S
-------	--



## Contact utilization characteristics according to IEC

Standards	IEC 60947-5-1 and EN 60947-5-1	
Rated insulation voltage $U_i$ acc. to IEC 60947-5-1	690 V	
Rated impulse withstand voltage $U_{imp}$	6 kV	
Rated operational voltage $U_e$ max.	24...690 V	
Conventional thermal current $I_{th}$ - $\theta \leq 40^\circ\text{C}$	16 A	
Rated frequency (without derating)	50/60 Hz	
$I_e$ / Rated operational current AC-15 acc. to IEC 60947-5-1	24-127 V 50/60 Hz	6 A
	220-240 V 50/60 Hz	4 A
	400-440 V 50/60 Hz	3 A
	500 V 50/60 Hz	2 A
	690 V 50/60 Hz	2 A
Making capacity	10 x $I_e$ AC-15 acc. to IEC 60947-5-1	
Breaking capacity	10 x $I_e$ AC-15 acc. to IEC 60947-5-1	
$I_e$ / Rated operational current DC-13 acc. to IEC 60947-5-1	24 V DC	6 A / 144 W
	48 V DC	2.8 A / 134 W
	72 V DC	1 A / 72 W
	110 V DC	0.55 A / 60 W
	125 V DC	0.55 A / 69 W
	220 V DC	0.27 A / 60 W
	250 V DC	0.27 A / 68 W
	400 V DC	0.15 A / 60 W
	500 V DC	0.13 A / 65 W
	600 V DC	0.1 A / 60 W
Short-circuit protection device gG type fuse	10 A	
Rated short-time withstand current $I_{cw}$ $\theta = 40^\circ\text{C}$	for 1.0 s	100 A
	for 0.1 s	140 A
Minimum switching capacity with failure rate acc. to IEC 60947-5-4	12 V / 3 mA	
Power dissipation per pole at 6 A	$10^{-7}$	
Mechanical durability	Number of operating cycles	10 millions operating cycles
	Max. switching frequency	3600 cycles/h
Max. electrical switching frequency	AC-15	1200 cycles/h
	DC-13	900 cycles/h
Mechanically linked contacts acc. to annex L of IEC 60947-5-1	Additional N.O. or N.C. auxiliary contacts (CA4..S, CAL4..S, CAT4..S) are mechanically linked contacts	
Mirror contacts acc. to annex F of IEC 60947-4-1	Additional N.C. auxiliary contacts (CA4..S, CAL4..S, CAT4..S) are mirror contacts	

## Contact utilization characteristics according to UL / CSA

Standards	UL 508, CSA C22.2 N°14
Max. operational voltage	600 V AC, 600 V DC
Pilot duty	A600, Q600
AC thermal rated current	10 A
AC maximum volt-ampere making	7200 VA
AC maximum volt-ampere breaking	720 VA
DC thermal rated current	2.5 A
DC maximum volt-ampere making-breaking	69 VA

## Connecting characteristics

Connection capacity (min. ... max.)		
	Rigid solid	1 x 1...2.5 mm <sup>2</sup>
		2 x 1...2.5 mm <sup>2</sup>
	Flexible with ferrule	1 x 0.75...2.5 mm <sup>2</sup>
		2 x 0.75...2.5 mm <sup>2</sup>
	Flexible with insulated ferrule	1 x 0.75...2.5 mm <sup>2</sup>
		2 x 0.75...1.5 mm <sup>2</sup>
Connection capacity acc. to UL/CSA	1 or 2 x	AWG 18...14
Stripping length	10 mm	
Degree of protection	IP20	
acc. to IEC 60947-1 / EN 60947-1 and IEC 60529 / EN 60529		
Screwdriver type	Flat Ø 3.5	

# Add-on auxiliary contacts - with spring terminals

## Terminal marking and positioning

### 1-pole auxiliary contacts



CA4-01S



CA4-10S

### 2-pole auxiliary contacts

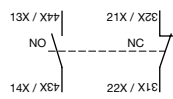

CAL4-11S  
(Left side-mounted)

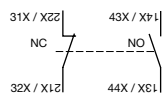

CAL4-11S  
(Right side-mounted)

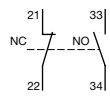

CAT4-11MS

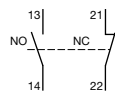

CAT4-11ES

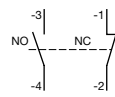

CAT4-11US

### 4-pole auxiliary contacts

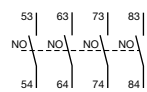

CA4-40NS

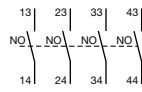

CA4-40ES

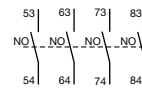

CA4-40NS

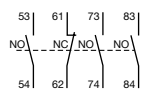

CA4-31NS

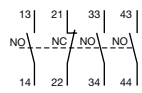

CA4-31ES

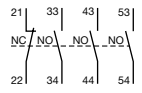

CA4-31MS

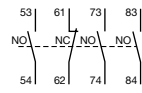

CA4-31NS

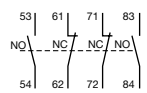

CA4-22NS

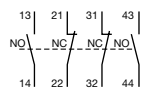

CA4-22ES

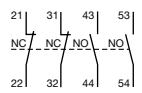

CA4-22MS

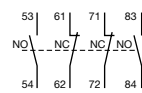

CA4-22NS

# Electronic timers - with spring terminals



TEF4S-ON

1SBC10139AF0014



TEF4S-OFF

1SBC10139F0014

## Description

TEF4S frontal electronic timers are used for realizing timing function and are available in ON-delay and OFF-delay versions.

### Compact solution in cabinet compared to separate timers

TEF4S electronic timers are front-mounted and locked on AF..S contactors or NF..S contactor relays. A mechanical indicator allows to show the state of the contactor.

### Safe and cost-reduced wiring

TEF4S electronic timers are supplied by a direct plug-in parallel connection to the coil terminals A1 - A2 of the contactor or contactor relay. A varistor is integrated on the timer to offer a built-in protection against surges in the contactor coil.

### Available for a wide control voltage range 24...240 V AC/DC

TEF4S-ON or TEF4S-OFF allow time-delayed functions up to 100 s in 3 distinct time ranges, independently of the control system. The time delay ranges are selected by a switch and the time delay can be adjusted by means of a rotary switch. The timing function is activated by closing or opening the device on which the timer is mounted. The OFF-delay version operates without additional control supply.

## Ordering details

For contactors, contactor relays	Time delay range selected by switch	Delay type	Rated control circuit voltage Uc  V 50/60 Hz or DC	Auxiliary contacts      	Type	Order code	Weight  Pkg (1 pce) kg
AF09..S ... AF26..S	0.1...1 s	ON-delay	24...240	1 1	TEF4S-ON	1SBN020113R1000	0.065
NF..S	1...10 s 10...100 s	OFF-delay	24...240	1 1	TEF4S-OFF	1SBN020115R1000	0.065

# Electronic timers - with spring terminals

## Technical data

### Contact utilization characteristics according to IEC

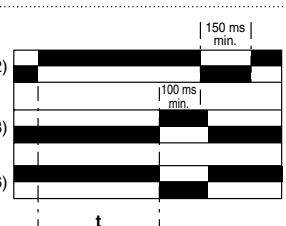
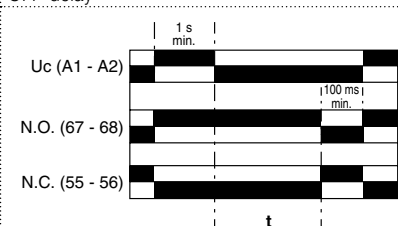
Types	TEF4S-ON	TEF4S-OFF
<b>Standards</b>	IEC 60947-5-1 and EN 60947-5-1	
<b>Rated insulation voltage <math>U_i</math></b> acc. to IEC 60947-5-1	400 V	
<b>Rated impulse withstand voltage <math>U_{imp}</math></b>	4 kV	
<b>Rated operational voltage <math>U_e</math> max.</b>	240 V	
<b>Rated frequency (without derating)</b>	50 / 60 Hz	
<b>Conventional thermal current <math>I_{th} - \theta \leq 40^\circ\text{C}</math></b>	5 A	
<b><math>I_e</math> / Rated operational current AC-15</b> acc. to IEC 60947-5-1	24-127 V 50/60 Hz 220-240 V 50/60 Hz	3 A 1.5 A
<b>Making capacity</b> acc. to IEC 60947-5-1	10 x $I_e$ AC-15	
<b>Breaking capacity</b> acc. to IEC 60947-5-1	10 x $I_e$ AC-15	
<b><math>I_e</math> / Rated operational current DC-13</b> acc. to IEC 60947-5-1	24 V DC	1 A / 24 W
<b>Short-circuit protection device gG type fuse</b>	6 A	
<b>Rated short-time withstand current <math>I_{cw}</math></b> $\theta = 40^\circ\text{C}$	for 1.0 s for 0.1 s	8 A 8 A
<b>Minimum switching capacity</b> with failure rate acc. to IEC 60947-5-4	24 V DC	12 V / 3 mA $10^{-7}$
<b>Power dissipation per pole at 3 A</b>	0.1 W	
<b>Function diagram</b>	ON-delay 	OFF-delay 
Bistable relay inside. Before use, once apply $U_c$ then switch it off in order to initialize position of the contacts.		
<b>Control circuit voltage</b>		
<b>AC control voltage</b>	Rated control circuit voltage $U_c$ 50/60 Hz	24...240 V AC 1.5 mA RMS
<b>DC control voltage</b>	Rated control circuit voltage $U_c$ Average consumption	24...240 V DC 1.5 mA 1 mA
<b>Rated frequency limits</b>	50 / 60 Hz	
<b>Supply voltage range</b>	0.85...1.1 x $U_c$ (at $\theta \leq 70^\circ\text{C}$ )	
<b>Overvoltage protection</b>	Varistor included	
<b>Time delay range (t) selected by switch</b>	0.1...1 s 1...10 s 10...100 s	<input type="checkbox"/> <input type="checkbox"/> <input type="checkbox"/>
<b>On-load reiteration accuracy under constant conditions</b>	$\leq 1\%$	
<b>Minimum ON period</b>	0.1 s	
<b>Recovery time</b>	0.15 s	
<b>Ambient air temperature</b>	Operation Storage	-25 °C ... +70 °C -40 °C ... +80 °C
<b>Climatic withstand</b>	Category B according to IEC 60947-1 Annex Q	
<b>Maximum operating altitude</b>	2000 m	
<b>Mounting positions</b>	Mounting positions 1, 1 +/- 30°, 2, 3, 4, 5	
<b>Shock withstand</b> acc. to IEC 60068-2-27 and EN 60068-2-27	1/2 sinusoidal shock for 11 ms: no change in contact position Same as contactor or contactor relay	
<b>(Mounting position 1)</b>		
<b>Vibration withstand</b> acc. to IEC 60068-2-6	5...300 Hz 3 g closed position / 2 g open position	
<b>Mechanical durability</b>	Number of operating cycles Max. switching frequency	5 millions operating cycles 3600 cycles/h
<b>Max. electrical switching frequency</b>	AC-15 DC-13	1200 cycles/h 900 cycles/h





# Electronic timers - with spring terminals

## Technical data

### Contact utilization characteristics according to UL / CSA

Types	TEF4S-ON	TEF4S-OFF
Standards	UL 508, CSA C22.2 N°14	
Rated insulation voltage $U_i$ acc. to UL / CSA	300 V	
Max. operational voltage	240 V	
Pilot duty	B300, R300	
AC thermal rated current	5 A	
AC maximum volt-ampere making	3600 VA	
AC maximum volt-ampere breaking	360 VA	
DC thermal rated current	1 A	
DC maximum volt-ampere making-breaking	28 VA	

### Connecting characteristics

Connection capacity (min. ... max.)		
 Rigid solid	1 x	1...2.5 mm <sup>2</sup>
	2 x	1...2.5 mm <sup>2</sup>
 Flexible with non insulated ferrule	1 x	0.75...2.5 mm <sup>2</sup>
	2 x	0.75...2.5 mm <sup>2</sup>
 Flexible with insulated ferrule	1 x	0.75...1.5 mm <sup>2</sup>
	2 x	0.75...1.5 mm <sup>2</sup>
Connection capacity acc. to UL / CSA	1 or 2 x	AWG 18...14
Stripping length		10 mm
Degree of protection		IP20
acc. to IEC 60947-1 / EN 60947-1 and IEC 60529 / EN 60529		
Screwdriver type		Flat Ø 3.5
Terminal Marking		

# Other accessories

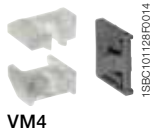

## Ordering details

For contactors	Type	Order code	Pkg qty	Weight (1 pce) kg
----------------	------	------------	---------	-------------------

## Mechanical interlock unit

VM4 mechanical interlock unit for the interlocking of two AF contactors. When mounted between two contactors without additional width, the VM4 mechanical interlock unit prevents one of the contactors from closing as long as the other contactor is closed. The mechanical interlock unit includes 2 fixing clips (BB4).

AF09..S ... AF26..S	VM4	1SBN030105T1000	10	0.005
---------------------	-----	-----------------	----	-------

## Fixing clips

AF09..S ... AF26..S	BB4	1SBN110120W1000	50	0.002
---------------------	-----	-----------------	----	-------

## Additional coil terminal block - with spring terminals

Additional coil terminal block for a bottom access to the coil terminals of contactors or contactor relays.

AF09..S ... AF26..S and NF..S	LDC4S	1SBN070157T1000	10	0.010
-------------------------------	-------	-----------------	----	-------

## Protective covers

Sealable and transparent protective covers BX4 and non-removable BX4-CA to protect the devices against accidental contact.

All 1-stack contactors and contactor relays	BX4	1SBN110108T1000	10	0.006
For 4-pole CA4 and 2-pole CAT4 auxiliary contact blocks	BX4-CA	1SBN110109W1000	50	0.001

## Mounting piece

Mounting piece for replacement of A / AL26 ... A / AL40 contactors fixed by screws by AF contactors in 45 mm width.

AF09..S ... AF26..S	BP38-4	1SBN112303T1000	10	0.003
---------------------	--------	-----------------	----	-------

## Function markers

Box of 16 blank cards (16 markers by card) printable on HTP500 thermal transfer printer and AMS 500 marking table to identify your contactors, overload relays or manual motor starters.

Marker dimensions: 7 x 20 mm (.276" x .787").

Box of 16 blank cards	BA4	1SNA235156R2700	16	0.011
AMS 500 support plate for 8 BA4	SPRC 1	1SNA360010R1500	1	0.220
HTP500 support plate	HTP500-BA4	1SNA235712R2400	1	0.290

## Test block

BDT4 test block is suitable for switching on contactor off-load.

Marking on the block indicates the contactor type to fit with.

AF..S, NF..S	BDT4	1SBN110122T1000	10	0.007
--------------	------	-----------------	----	-------

## Main dimensions mm, inches

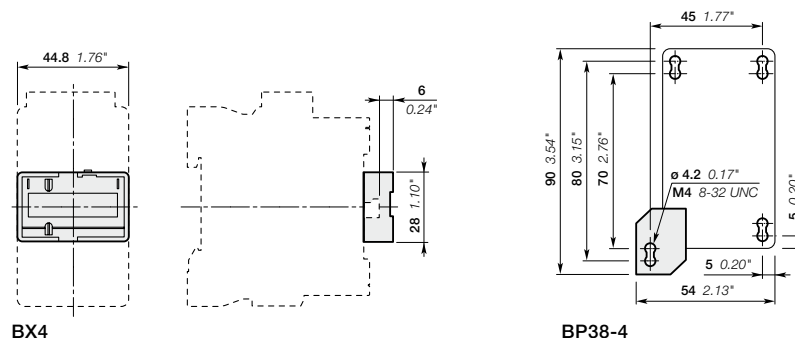

# Voltage code table

The below tables indicate the available coil voltages and corresponding digits for order codes.

## 3-pole contactors - with spring terminals

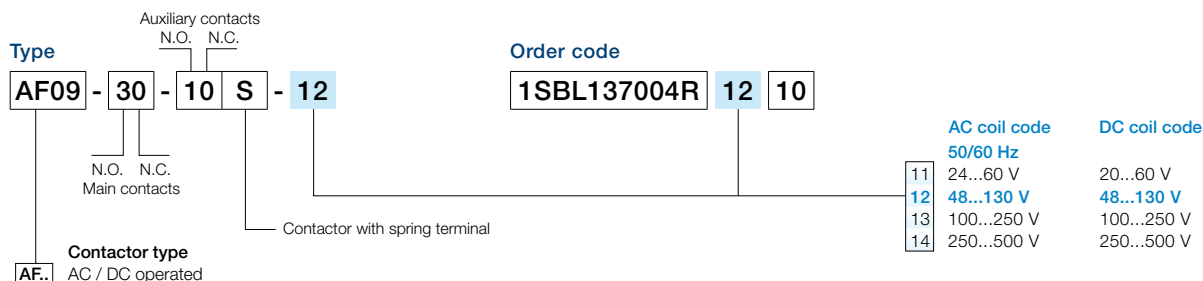

## 3-pole contactors - low consumption - with spring terminals

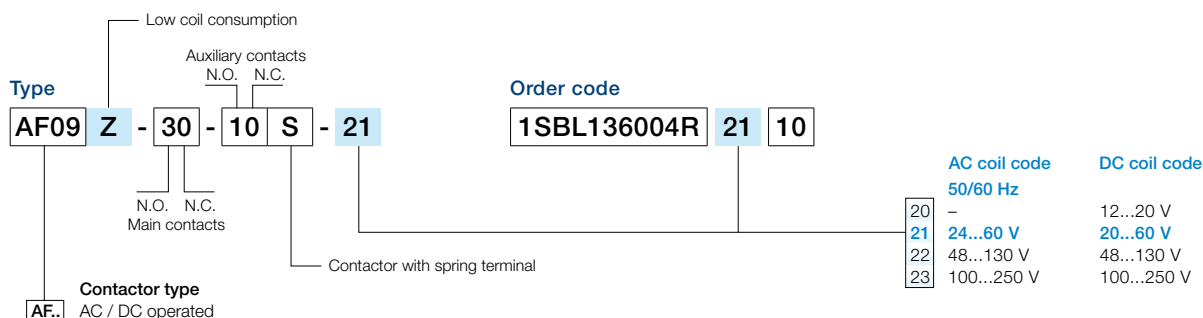

## Contactor relays - with spring terminals

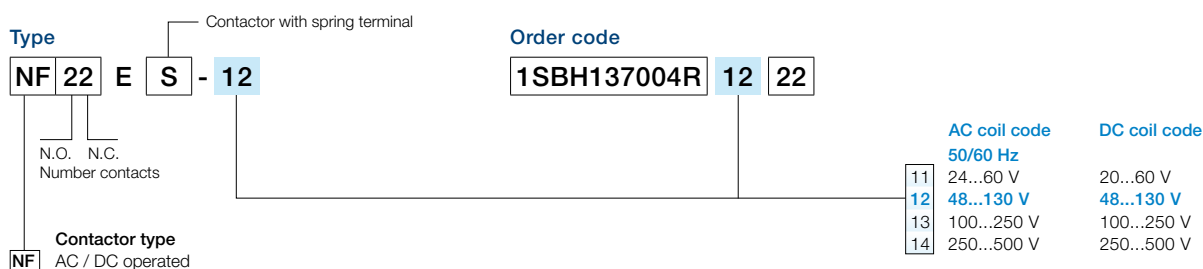

## Contactor relays - low consumption - with spring terminals

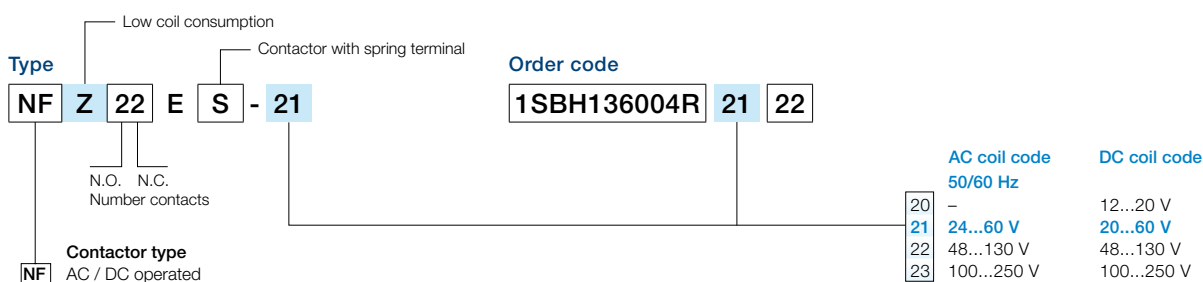





# Overload relays

## Overview

Thermal and electronic overload relays	7/2
--	-----

## Thermal overload relays

### T16 (0.10 ... 16 A)

Ordering details	7/4
Technical data	7/5

### TF42 (0.10 ... 38 A)

Ordering details	7/8
Technical data	7/9

### TF65

in progress

Ordering details	7/12
------------------	------

### TF96

in progress

Ordering details	7/16
------------------	------

### TF140DU (66 ... 142 A)

Ordering details	7/20
Technical data	7/21

### TA200DU (66 ... 200 A)

Ordering details	7/24
Technical data	7/25

## Electronic overload relays

### E16DU (0.10 ... 18.9 A)

Ordering details	7/28
Technical data	7/29
Accessories	7/32

### EF19, EF45 (0.10 ... 45 A)

Ordering details	7/33
Technical data	7/34

### EF65, EF96, EF146 (25 ... 150 A)

Ordering details	7/37
Technical data	7/38

### EF205, EF370 (63 ... 380 A)

Ordering details	7/41
Technical data	7/42

### E500DU, E800DU, E1250DU (150 ... 1250 A)

Ordering details	7/45
Technical data	7/46

# Thermal and electronic overload relays

## Thermal overload relays



IEC: rated operational power AC-3	400 V	0.03 ... 4.0 kW	0.03 ... 4.0 kW	4.0 ... 18.5 kW	18.5 ... 30 kW
UL/CSA: 3-phase hp-ratings	480 V	1/2 ... 5 hp	1/2 ... 10 hp	5 ... 20 hp	30 ... 60 hp
Fitting to contactors		B6, B7, AS	AS09 ... AS16	AF09 ... AF38	AF40, AF52, AF65
Type		<b>T16</b>	<b>T16</b>	<b>TF42</b>	<b>TF65</b>
Current range		0.10 ... 16 A	0.10 ... 16 A	0.10 ... 38 A	22 ... 67 A
Trip class		10	10	10	10
Separate mounting kit		DB16	DB16	DB42	-

## 7 Electronic overload relays with integrated CT

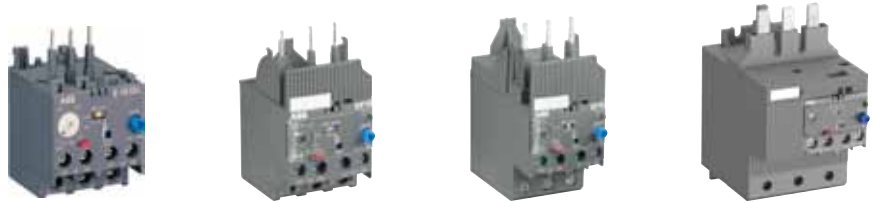

IEC: rated operational power AC-3	400 V	0.03 ... 4.0 kW	4 ... 7.5 kW	4.0 ... 18.5 kW	18.5 ... 30 kW
UL/CSA: 3-phase hp-ratings	480 V	1 ... 5 hp	5 ... 10 hp	5 ... 20 hp	30 ... 60 hp
Fitting to contactors		B6, B7	AF09 ... AF016	AF26 ... AF38	AF40, AF52, AF65
Type		<b>E16DU</b>	<b>EF19</b>	<b>EF45</b>	<b>EF65</b>
Current range		0.10 ... 18.9 A	0.10 ... 19 A	9 ... 45 A	25 ... 70 A
Trip class		10E, 20E, 30E selectable			
Separate mounting kit		DB16E	-	-	-

## Electronic overload relays with external separate CT



IEC: rated operational power AC-3	400 V	200 ... 250 kW	315 ... 400 kW
UL/CSA: 3-phase hp-ratings	480 V	350 ... 400 hp	500 ... 600 hp
Fitting to contactors		AF400, AF460	AF580, AF750, AF1250
Type		<b>E500DU</b>	<b>E800DU</b>
Current range		150 ... 500 A	250 ... 800 A
Trip class		10E, 20E, 30E selectable	



37 ... 45 kW	55 ... 75 kW	90 ... 110 kW
60 hp	75 ... 100 hp	125 ... 150 hp
AF80, AF96	AF116, AF140, AF146	AF190, AF205
<b>TF96</b>	<b>TF140DU</b>	<b>TA200DU</b>
40 ... 96 A	66 ... 142 A	66 ... 200 A
10	10A	10A
-	-	-



37 ... 45 kW	55 ... 75 kW	90 ... 110 kW	132 ... 200 kW
60 hp	75 ... 100 hp	125 ... 150 hp	200 ... 350 hp
AF80, AF96	AF116, AF140	AF190, AF205	AF265, AF305, AF370
<b>EF96</b>	<b>EF146</b>	<b>EF205</b>	<b>EF370</b>
36 ... 100 A	54 ... 150 A	63 ... 210 A	115 ... 380 A
	10E, 20E, 30E selectable		
-	-	-	-

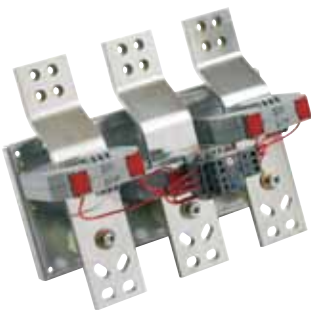

475 ... 560 kW
800 ... 900 hp
AF1350, AF1650, AF2050
<b>E1250DU</b>
375 ... 1250 A
10E, 20E, 30E selectable

# T16 thermal overload relays

## 0.10 ... 16.0 A



2CDC23102F0011

T16-16



2CDC23902F0011

T16 + DB16

7



1SFC151402F0011

KPR-101L



2CDC231002F0011

DB16

### Description

The T16 thermal overload relays are economic electromechanical protection devices for the main circuit. They offer reliable protection for motors in the event of overload or phase failure. The devices have trip class 10.

The thermal overload relays are three pole relays with bimetal tripping elements. The motor current flows through the bimetal tripping elements and heats them directly and indirectly. In case of an overload (over current), the bimetal elements bent as a result of the heating. This leads to a release of the relay and a change of the contacts switching position (95-96 / 97-98).

- Manual or automatic reset selectable
- Phase loss sensitive acc. to IEC/EN 60947-4-1
- TEST and STOP function - Trip indication on the front
- Temperature compensation
- Suitable for three- and single-phase applications

### Ordering details

Setting range	Short-circuit protective device	Trip class	Type	Order code	Weight (1 pce) kg
<b>A</b>					
0.10 ... 0.13	0.5 A, Fuse type T	10	T16-0.13	1SAZ711201R1005	0.100
0.13 ... 0.17	1.0 A, Fuse type T	10	T16-0.17	1SAZ711201R1008	0.100
0.17 ... 0.23	1.0 A, Fuse type T	10	T16-0.23	1SAZ711201R1009	0.100
0.23 ... 0.31	1.0 A, Fuse type T	10	T16-0.31	1SAZ711201R1013	0.100
0.31 ... 0.41	2.0 A, Fuse type gG	10	T16-0.41	1SAZ711201R1014	0.100
0.41 ... 0.55	2.0 A, Fuse type gG	10	T16-0.55	1SAZ711201R1017	0.100
0.55 ... 0.74	4.0 A, Fuse type gG	10	T16-0.74	1SAZ711201R1021	0.100
0.74 ... 1.00	6.0 A, Fuse type gG	10	T16-1.0	1SAZ711201R1023	0.100
1.00 ... 1.30	6.0 A, Fuse type gG	10	T16-1.3	1SAZ711201R1025	0.100
1.30 ... 1.70	10.0 A, Fuse type gG	10	T16-1.7	1SAZ711201R1028	0.100
1.70 ... 2.30	10.0 A, Fuse type gG	10	T16-2.3	1SAZ711201R1031	0.100
2.30 ... 3.10	10.0 A, Fuse type gG	10	T16-3.1	1SAZ711201R1033	0.100
3.10 ... 4.20	20.0 A, Fuse type gG	10	T16-4.2	1SAZ711201R1035	0.100
4.20 ... 5.70	20.0 A, Fuse type gG	10	T16-5.7	1SAZ711201R1038	0.100
5.70 ... 7.60	35.0 A, Fuse type gG	10	T16-7.6	1SAZ711201R1040	0.100
7.60 ... 10.0	35.0 A, Fuse type gG	10	T16-10	1SAZ711201R1043	0.104
10.0 ... 13.0	40.0 A, Fuse type gG	10	T16-13	1SAZ711201R1045	0.104
13.0 ... 16.0	40.0 A, Fuse type gG	10	T16-16	1SAZ711201R1047	0.104

### Ordering details accessories

For thermal overload relays	Description	Type	Order code	Weight (1 pce) kg
<b>A</b>				
T16	Single mounting kit	DB16	1SAZ701901R0001	0.032
T16	Reset push button*	KPR-101L	1SFA616162R1014	0.027

\*Note: for more information see catalogue 1SFC151004C0201

### Main dimensions mm, inches

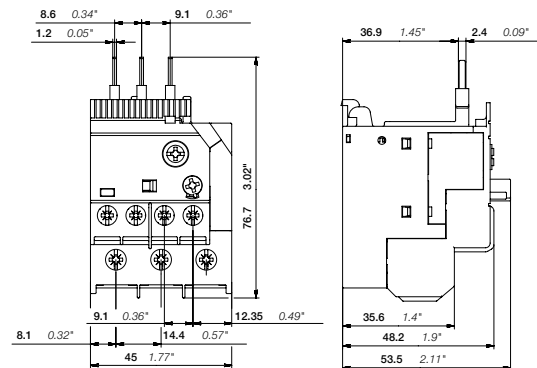

T16

2CDC23902F0008

2CDC106036C0201

# T16 thermal overload relays

## Technical data

### Main circuit – Utilization characteristics according to IEC/EN

Type	<b>T16</b>
Standards	IEC/EN 60947-4-1, IEC/EN 60947-5-1, IEC/EN 60947-1
Rated operational voltage $U_e$	690 V AC - V DC
Rated frequency	50/60 Hz
Trip class	10
Number of poles	3
Duty time	100 %
Operating frequency without early tripping	Up to 15 operations/h, see "Technical diagram – Intermittent periodic duty"
Rated impulse withstand voltage $U_{imp}$	6 kV
Rated insulation voltage $U_i$	690 V AC

### Auxiliary circuit according to IEC/EN

Type	<b>T16</b>
Rated operational voltage $U_e$	600 V
Conventional free air thermal current $I_{th}$	<b>N.C., 95-96</b> 6 A <b>N.O., 97-98</b> 4 A
Rated frequency	DC, 50/60 Hz
Number of poles	1 N.O. + 1 N.C.
$I_e$ / Rated operational current AC-15 acc. to IEC/EN 60947-5-1 for utilization category	
110-120 V	<b>N.C., 95-96</b> 3.00 A <b>N.O., 97-98</b> 0.75 A
220-230-240 V	<b>N.C., 95-96</b> 3.00 A <b>N.O., 97-98</b> 0.75 A
440 V	<b>N.C., 95-96</b> 0.75 A <b>N.O., 97-98</b> 0.75 A
480-500 V	<b>N.C., 95-96</b> 0.75 A <b>N.O., 97-98</b> 0.75 A
$I_e$ / Rated operational current DC-13 acc. to IEC/EN 60947-5-1 for utilization category	
24 V	<b>N.C., 95-96</b> 1.25 A <b>N.O., 97-98</b> 1.25 A
60 V	<b>N.C., 95-96</b> 0.55 A <b>N.O., 97-98</b> 0.55 A
110-120-125 V	<b>N.C., 95-96</b> 0.55 A <b>N.O., 97-98</b> 0.55 A
250 V	<b>N.C., 95-96</b> 0.27 A <b>N.O., 97-98</b> 0.27 A
Minimum switching capacity	17 V / 3 mA
Short-circuit protective device	<b>N.C., 95-96</b> 6 A, Fuse type gG <b>N.O., 97-98</b> 4 A, Fuse type gG
Rated impulse withstand voltage $U_{imp}$	6 kV
Rated insulation voltage $U_i$	690 V

### Technical diagram – Intermittent periodic duty

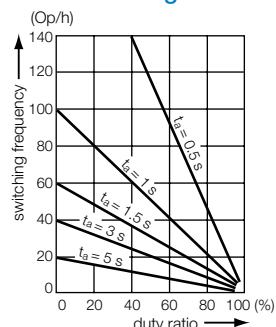

$t_s$ : Motor starting time

2CDC32005R0211

2CDC106036C0201

# T16 thermal overload relays

## Technical data

### Main circuit – Utilization characteristics according to UL/CSA

Type	T16
Standards	UL 508, CSA 22.2 No. 14
Maximum operational voltage	600 V AC
Trip rating	125 % of FLA
Full load amps (FLA)	See table "Full load amps and short-circuit protective device"
Short-circuit rating RMS symmetrical	See table "Full load amps and short-circuit protective device"
Short-circuit protective device	See table "Full load amps and short-circuit protective device"

### Auxiliary circuit according to UL/CSA

Type	T16	
Contact rating	N.C., 95-96	B600, Q300
	N.O., 97-98	D300, Q300
Conventional thermal current	N.C., 95-96	5 A
	N.O., 97-98	2.5 A

### Full load amps and short-circuit protective device

Type	Full load amps (FLA)	Short-circuit protective device			
		480 / 600 V AC		480 / 600 V AC	
		Short circuit rating RMS symmetrical	Fuse type	Short circuit rating RMS symmetrical	Fuse type
T16-0.13	0.13 A	18 kA	1 A, K5	100 kA	30 A, Class J
T16-0.17	0.17 A	18 kA	1 A, K5	100 kA	30 A, Class J
T16-0.23	0.23 A	18 kA	1 A, K5	100 kA	30 A, Class J
T16-0.31	0.31 A	18 kA	3 A, K5	100 kA	30 A, Class J
T16-0.41	0.41 A	18 kA	3 A, K5	100 kA	30 A, Class J
T16-0.55	0.55 A	18 kA	3 A, K5	100 kA	30 A, Class J
T16-0.74	0.74 A	18 kA	3 A, K5	100 kA	30 A, Class J
T16-1.0	1.00 A	18 kA	6 A, K5	100 kA	30 A, Class J
T16-1.3	1.30 A	18 kA	6 A, K5	100 kA	30 A, Class J
T16-1.7	1.70 A	18 kA	6 A, K5	100 kA	30 A, Class J
T16-2.3	2.30 A	18 kA	10 A, K5	100 kA	30 A, Class J
T16-3.1	3.10 A	18 kA	10 A, K5	100 kA	30 A, Class J
T16-4.2	4.20 A	18 kA	15 A, K5	100 kA	30 A, Class J
T16-5.7	5.70 A	18 kA	20 A, K5	100 kA	30 A, Class J
T16-7.6	7.60 A	18 kA	25 A, K5	100 kA	30 A, Class J
T16-10	10.0 A	18 kA	35 A, K5	100 kA	45 A, Class J
T16-13	13.0 A	18 kA	40 A, K5	100 kA	45 A, Class J
T16-16	16.0 A	18 kA	60 A, K5	100 kA	45 A, Class J

# T16 thermal overload relays



## Technical data

### General technical data

Type	<b>T16</b>	
Pollution degree	3	
Phase loss sensitive	Yes	
Ambient air temperature		
Operation	Open - compensated	-25 ... +60 °C
	Open	-25 ... +60 °C
Storage	-50 ... +80 °C	
Ambient air temperature compensation	Acc. to IEC/EN60947-4-1	
Maximum operating altitude permissible	2000 m	
Resistance to shock acc. to IEC 60068-2-27	25g / 11 ms	
Resistance to vibrations acc. to IEC 60068-2-6	3g / 3 ... 150 Hz	
Mounting position	Position 1-5	
Mounting	Mount on the contactor and tighten the screws of the main circuit terminals or with single mounting kit on DIN rail (35 mm)	
Degree of protection	Housing	IP20
	Main circuit terminals	IP10





### Electrical connection

#### Main circuit

Type	<b>T16</b>	
Connecting capacity		
	 Rigid	1 x 0.75 ... 4 mm <sup>2</sup> 2 x 0.75 ... 1.5 mm <sup>2</sup> or 1.5 ... 4 mm <sup>2</sup> <sup>1)</sup>
	 Flexible	1 x or 2 x 0.75 ... 4 mm <sup>2</sup>
	Stranded acc. to UL/CSA	1 x or 2 x AWG 18-10
	Flexible acc. to UL/CSA	1 x or 2 x AWG 18-10
Stripping length	12 mm	
Tightening torques	1.1 ... 1.5 Nm / 9 ... 13 lb.in	
Connection screw	M4 (Pozidriv 2)	

<sup>1)</sup> Only connect two different "conductor/wire" cross-sections, if they are within the indicated ranges

#### Auxiliary circuit

Type	<b>T16</b>	
Connecting capacity		
	 Rigid	1 x or 2 x 0.75 ... 4 mm <sup>2</sup>
	 Flexible with ferrule	1 x or 2 x 0.75 ... 2.5 mm <sup>2</sup>
	 Flexible with insulated ferrule	1 x 0.75 ... 2.5 mm <sup>2</sup> 2 x 0.75 ... 1.5 mm <sup>2</sup>
	 Flexible	1 x or 2 x 0.75 ... 1 mm <sup>2</sup> or 1 ... 2.5 mm <sup>2</sup>
	Stranded acc. to UL/CSA	1 x or 2 x AWG 18-12
	Flexible acc. to UL/CSA	1 x or 2 x AWG 18-12
Stripping length	9 mm	
Tightening torques	1.1 ... 1.5 Nm / 9 ... 13 lb.in	
Connection screw	M3 (Pozidriv 2)	

# TF42 thermal overload relays

## 0.10 ... 38.0 A



1SBC101328F0010

TF42-38



2CDC231001F0011

DB42

7



1SFC151402F0001

KPR-101L

### Description

The TF42 thermal overload relays are economic electromechanical protection devices for the main circuit. They offer reliable protection for motors in the event of overload or phase failure. The devices have trip class 10.

The thermal overload relays are three pole relays with bimetal tripping elements. The motor current flows through the bimetal tripping elements and heats them directly and indirectly. In case of an overload (over current), the bimetal elements bent as a result of the heating. This leads to a release of the relay and a change of the contacts switching position (95-96 / 97-98).

- Manual or automatic reset selectable
- Phase loss sensitive acc. to IEC/EN 60947-4-1
- TEST and STOP function – Trip indication on the front
- Temperature compensation
- Suitable for three- and single-phase applications

### Ordering details

Setting range	Short-circuit protective device	Trip class	Type	Order code	Weight (1 pce) kg
<b>A</b>					
0.10 ... 0.13	0.5 A, Fuse type T	10	TF42-0.13	1SAZ721201R1005	0.130
0.13 ... 0.17	1.0 A, Fuse type T	10	TF42-0.17	1SAZ721201R1008	0.130
0.17 ... 0.23	1.0 A, Fuse type T	10	TF42-0.23	1SAZ721201R1009	0.130
0.23 ... 0.31	1.0 A, Fuse type T	10	TF42-0.31	1SAZ721201R1013	0.130
0.31 ... 0.41	2.0 A, Fuse type gG	10	TF42-0.41	1SAZ721201R1014	0.130
0.41 ... 0.55	2.0 A, Fuse type gG	10	TF42-0.55	1SAZ721201R1017	0.130
0.55 ... 0.74	4.0 A, Fuse type gG	10	TF42-0.74	1SAZ721201R1021	0.130
0.74 ... 1.00	6.0 A, Fuse type gG	10	TF42-1.0	1SAZ721201R1023	0.130
1.00 ... 1.30	6.0 A, Fuse type gG	10	TF42-1.3	1SAZ721201R1025	0.130
1.30 ... 1.70	10.0 A, Fuse type gG	10	TF42-1.7	1SAZ721201R1028	0.130
1.70 ... 2.30	10.0 A, Fuse type gG	10	TF42-2.3	1SAZ721201R1031	0.130
2.30 ... 3.10	10.0 A, Fuse type gG	10	TF42-3.1	1SAZ721201R1033	0.130
3.10 ... 4.20	20.0 A, Fuse type gG	10	TF42-4.2	1SAZ721201R1035	0.130
4.20 ... 5.70	20.0 A, Fuse type gG	10	TF42-5.7	1SAZ721201R1038	0.130
5.70 ... 7.60	35.0 A, Fuse type gG	10	TF42-7.6	1SAZ721201R1040	0.130
7.60 ... 10.0	35.0 A, Fuse type gG	10	TF42-10	1SAZ721201R1043	0.130
10.0 ... 13.0	40.0 A, Fuse type gG	10	TF42-13	1SAZ721201R1045	0.130
13.0 ... 16.0	40.0 A, Fuse type gG	10	TF42-16	1SAZ721201R1047	0.130
16.0 ... 20.0	63.0 A, Fuse type gG	10	TF42-20	1SAZ721201R1049	0.145
20.0 ... 24.0	63.0 A, Fuse type gG	10	TF42-24	1SAZ721201R1051	0.145
24.0 ... 29.0	63.0 A, Fuse type gG	10	TF42-29	1SAZ721201R1052	0.145
29.0 ... 35.0	80.0 A, Fuse type gG	10	TF42-35	1SAZ721201R1053	0.145
35.0 ... 38.0/40.0	80.0 A, Fuse type gG	10	TF42-38	1SAZ721201R1055	0.145

### Ordering details accessories

For thermal overload relays	Description	Type	Order code	Weight (1 pce) kg
<b>A</b>				
TF42	Single mounting kit	DB42	1SAZ701902R0001	0.087
TF42	Reset push button*	KPR-101L	1SFA616162R1014	0.027

\*Note: for more information see catalogue 1SFC151004C0201

### Main dimensions mm, inches

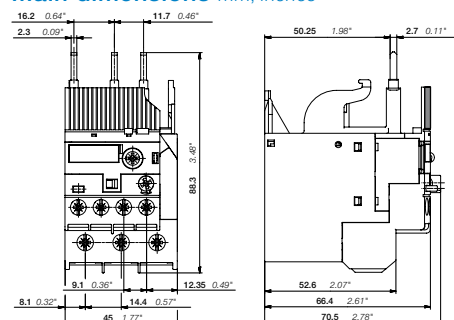

TF42

2CDC233005F0009

2CDC106046C0201



# TF42 thermal overload relays

## Technical data

### Main circuit – Utilization characteristics according to IEC/EN

Type	TF42
Standards	IEC/EN 60947-4-1, IEC/EN 60947-5-1, IEC/EN 60947-1
Rated operational voltage $U_n$	690 V AC
Rated frequency	50/60 Hz
Trip class	10
Number of poles	3
Duty time	100 %
Operating frequency without early tripping	Up to 15 operations/h, see "Technical diagram – Intermittent periodic duty"
Rated impulse withstand voltage $U_{imp}$	6 kV
Rated insulation voltage $U_i$	690 V AC

### Auxiliary circuit according to IEC/EN

Type	TF42
Rated operational voltage $U_n$	600 V
Conventional free air thermal current $I_{th}$	N.C., 95-96 6 A N.O., 97-98 4 A
Rated frequency	DC, 50/60 Hz
Number of poles	1 N.O. + 1 N.C.
$I_e$ / Rated operational current AC-15 acc. to IEC/EN 60947-5-1 for utilization category	
110-120 V	N.C., 95-96 3.00 A N.O., 97-98 0.75 A
220-230-240 V	N.C., 95-96 3.00 A N.O., 97-98 0.75 A
440 V	N.C., 95-96 0.75 A N.O., 97-98 0.75 A
480-500 V	N.C., 95-96 0.75 A N.O., 97-98 0.75 A
$I_e$ / Rated operational current DC-13 acc. to IEC/EN 60947-5-1 for utilization category	
24 V	N.C., 95-96 1.25 A N.O., 97-98 1.25 A
110-120-125 V	N.C., 95-96 0.55 A N.O., 97-98 0.55 A
250 V	N.C., 95-96 0.27 A N.O., 97-98 0.27 A
Minimum switching capacity	17 V / 3 mA
Short-circuit protective device	N.C., 95-96 6 A, Fuse type gG N.O., 97-98 4 A, Fuse type gG
Rated impulse withstand voltage $U_{imp}$	6 kV
Rated insulation voltage $U_i$	690 V

### Technical diagram – Intermittent periodic duty

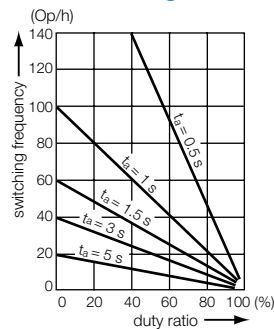

$t_s$ : Motor starting time

# TF42 thermal overload relays

## Technical data

### Main circuit – Utilization characteristics according to UL/CSA

Type	TF42
Standards	UL 508, CSA 22.2 No. 14
Maximum operational voltage	600 V AC
Trip rating	125 % of FLA
Full load amps (FLA)	See table "Full load amps and short-circuit protective device"
Short-circuit rating RMS symmetrical	See table "Full load amps and short-circuit protective device"
Short-circuit protective device	See table "Full load amps and short-circuit protective device"

### Auxiliary circuit according to UL/CSA

Type	TF42	
Contact rating	N.C., 95-96	B600, Q300
	N.O., 97-98	D300, Q300
Conventional thermal current	N.C., 95-96	5 A
	N.O., 97-98	2.5 A

### Full load amps and short-circuit protective device

Type	Full load amps (FLA)	Short-circuit protective device			
		480 / 600 V AC		480 / 600 V AC	
		Short circuit rating RMS symmetrical	Fuse type	Short circuit rating RMS symmetrical	Fuse type
TF42-0.13	0.13 A	18 kA	1 A, K5	100 kA	30 A, Class J
TF42-0.17	0.17 A	18 kA	1 A, K5	100 kA	30 A, Class J
TF42-0.23	0.23 A	18 kA	1 A, K5	100 kA	30 A, Class J
TF42-0.31	0.31 A	18 kA	3 A, K5	100 kA	30 A, Class J
TF42-0.41	0.41 A	18 kA	3 A, K5	100 kA	30 A, Class J
TF42-0.55	0.55 A	18 kA	3 A, K5	100 kA	30 A, Class J
TF42-0.74	0.74 A	18 kA	3 A, K5	100 kA	30 A, Class J
TF42-1.0	1.00 A	18 kA	6 A, K5	100 kA	30 A, Class J
TF42-1.3	1.30 A	18 kA	6 A, K5	100 kA	30 A, Class J
TF42-1.7	1.70 A	18 kA	6 A, K5	100 kA	30 A, Class J
TF42-2.3	2.30 A	18 kA	10 A, K5	100 kA	30 A, Class J
TF42-3.1	3.10 A	18 kA	10 A, K5	100 kA	30 A, Class J
TF42-4.2	4.20 A	18 kA	15 A, K5	100 kA	30 A, Class J
TF42-5.7	5.70 A	18 kA	20 A, K5	100 kA	30 A, Class J
TF42-7.6	7.60 A	18 kA	25 A, K5	100 kA	30 A, Class J
TF42-10	10.0 A	18 kA	35 A, K5	100 kA	45 A, Class J
TF42-13	13.0 A	18 kA	40 A, K5	100 kA	45 A, Class J
TF42-16	16.0 A	18 kA	60 A, K5	100 kA	45 A, Class J
TF42-20	20.0 A	18 kA	80 A, K5	100 kA	60 A, Class J
TF42-24	24.0 A	18 kA	80 A, K5	100 kA	60 A, Class J
TF42-29	29.0 A	18 kA	100 A, K5	100 kA	100 A, Class J
TF42-35	35.0 A	18 kA	150 A, K5	100 kA	175 A, Class J
TF42-38	38.0 A	18 kA	150 A, K5	100 kA	175 A, Class J

# TF42 thermal overload relays



## Technical data

### General technical data

Type	TF42	
Pollution degree	3	
Phase loss sensitive	Yes	
Ambient air temperature		
Operation	Open - compensated	-25 ... +60 °C
	Open	-25 ... +60 °C
Storage	-50 ... +80 °C	
Ambient air temperature compensation	Acc. to IEC/EN60947-4-1	
Maximum operating altitude permissible	2000 m	
Resistance to shock acc. to IEC 60068-2-27	25g / 11 ms	
Resistance to vibrations acc. to IEC 60068-2-6	3g / 3 ... 150 Hz	
Mounting position	Position 1-5	
Mounting	Mount on the contactor and tighten the screws of the main circuit terminals or with single mounting kit on DIN rail (35 mm)	
Degree of protection	Housing	IP20
	Main circuit terminals	IP10





### Electrical connection

#### Main circuit

Type	TF42 (TF42-0.13 ... TF42-16)		TF42 (TF42-20 ... TF42-38)
Connecting capacity			
 Rigid	1 x or 2 x	0.75 ... 4 mm <sup>2</sup>	1.5 ... 2.5 mm <sup>2</sup> or 2.5 ... 10 mm <sup>2</sup> <sup>1)</sup>
 Flexible with insulated ferrule	1 x or 2 x	0.75 ... 4 mm <sup>2</sup>	2.5 ... 4 mm <sup>2</sup> or 4 ... 6 mm <sup>2</sup>
Stranded acc. to UL/CSA	1 x or 2 x	AWG 18-10	AWG 14-6
Flexible acc. to UL/CSA	1 x or 2 x	AWG 18-10	AWG 14-6
Stripping length	12 mm		
Tightening torques	1.5 - 2.5 Nm / 13 ... 22 lb.in		2.5 - 2.7 Nm / 22 lb.in
Connection screw	M4 (Pozidriv 2)		

<sup>1)</sup> Only connect two different "conductor/wire" cross-sections, if they are within the indicated ranges

#### Auxiliary circuit

Type	TF42		
Connecting capacity			
 Rigid	1 x or 2 x	0.75 ... 4 mm <sup>2</sup>	
 Flexible with ferrule	1 x or 2 x	0.75 ... 2.5 mm <sup>2</sup>	
 Flexible with insulated ferrule	1 x	0.75 ... 2.5 mm <sup>2</sup>	
	2 x	0.75 ... 1.5 mm <sup>2</sup>	
 Flexible	1 x or 2 x	0.75 ... 1 mm <sup>2</sup> or 1 ... 2.5 mm <sup>2</sup>	
Stranded acc. to UL/CSA	1 x or 2 x	AWG 18-12	
Flexible acc. to UL/CSA	1 x or 2 x	AWG 18-12	
Stripping length	9 mm		
Tightening torques	1.1 ... 1.5 Nm / 9 ... 13 lb.in		
Connection screw	M3 (Pozidriv 2)		



2CDC231004FF0013

TF65

## Description

The TF65 thermal overload relays are economic electromechanical protection devices for the main circuit. They offer reliable protection for motors in the event of overload or phase failure. The devices have trip class 10.

The thermal overload relays are three pole relays with bimetal tripping elements. The motor current flows through the bimetal tripping elements and heats them directly and indirectly. In case of an overload (over current), the bimetal elements bent as a result of the heating. This leads to a release of the relay and a change of the contacts switching position (95-96 / 97-98).

- Manual or automatic reset selectable
- Phase loss sensitive acc. to IEC/EN 60947-4-1
- TEST and STOP function – Trip indication on the front
- Temperature compensation
- Suitable for three- and single-phase applications

## Ordering details

Setting range	Short-circuit protective device	Trip class	Type	Order code	Weight (1 pce) kg
A		10	TF65	1SAZ811201R1001	
		10	TF65	1SAZ811201R1002	
		10	TF65	1SAZ811201R1003	
		10	TF65	1SAZ811201R1004	
		10	TF65	1SAZ811201R1005	
		10	TF65	1SAZ811201R1006	
		10	TF65	1SAZ811201R1007	

## Ordering details accessories

For thermal overload relays	Description	Type	Order code	Weight (1 pce) kg
A				
TF65	Reset push button*	KPR-101L	1SFA616162R1014	0.027

\*Note: for more information see catalogue 1SFC151004C0201

7



1SFC151402FF001

KPR-101L

## Main dimensions mm, inches

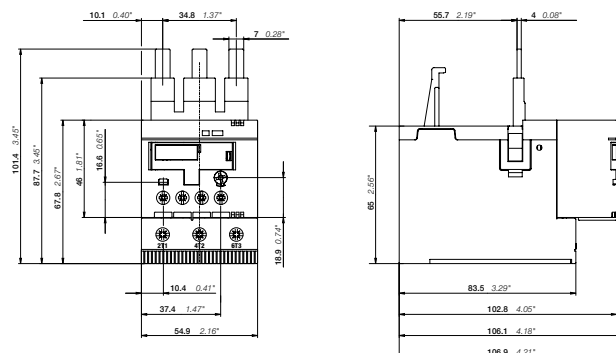

TF65

2CDC231004FF0009

2CDC106063C0201









2CDC231005F0013

TF96

## Description

The TF96 thermal overload relays are economic electromechanical protection devices for the main circuit. They offer reliable protection for motors in the event of overload or phase failure. The devices have trip class 10.

The thermal overload relays are three pole relays with bimetal tripping elements. The motor current flows through the bimetal tripping elements and heats them directly and indirectly. In case of an overload (over current), the bimetal elements bent as a result of the heating. This leads to a release of the relay and a change of the contacts switching position (95-96 / 97-98).

- Manual or automatic reset selectable
- Phase loss sensitive acc. to IEC/EN 60947-4-1
- TEST and STOP function - Trip indication on the front
- Temperature compensation
- Suitable for three- and single-phase applications

## Ordering details

Setting range	Short-circuit protective device	Trip class	Type	Order code	Weight (1 pce) kg
A		10	TF96	1SAZ911201R1001	
		10	TF96	1SAZ911201R1002	
		10	TF96	1SAZ911201R1003	
		10	TF96	1SAZ911201R1004	
		10	TF96	1SAZ911201R1005	
		10	TF96	1SAZ911201R1006	

## Ordering details accessories

For thermal overload relays	Description	Type	Order code	Weight (1 pce) kg
A				
TF96	Reset push button*	KPR-101L	1SFA616162R1014	0.027

\*Note: for more information see catalogue 1SFC151004C0201

7



1SFC151402F0001

KPR-101L

## Main dimensions mm, inches

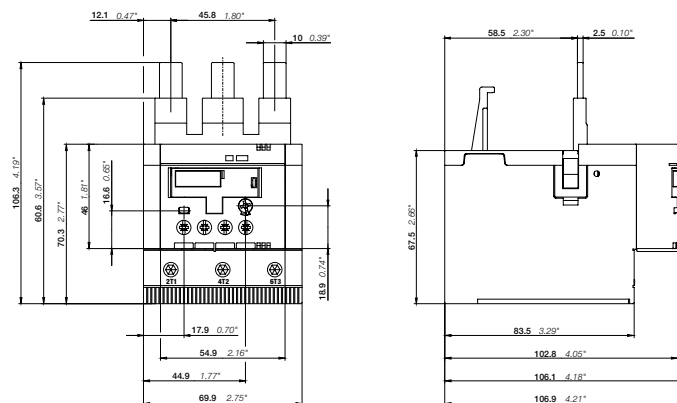

TF69

2CDC231005F0009

2CDC106064C0201









# TF140DU thermal overload relays

## 66 ... 142 A



2CDC231012V0012

TF140DU-110



1SFC151402F0001

KPR-101L

### Description

The TF140DU thermal overload relays are economic electromechanical protection devices for the main circuit. They offer reliable protection for motors in the event of overload or phase failure. The devices have trip class 10A.

The thermal overload relays are three pole relays with bimetal tripping elements. The motor current flows through the bimetal tripping elements and heats them directly and indirectly. In case of an overload (over current), the bimetal elements bent as a result of the heating. This leads to a release of the relay and a change of the contacts switching position (95-96 / 97-98).

- Manual or automatic reset selectable
- Phase loss sensitive acc. to IEC/EN 60947-4-1
- TEST and STOP function – Trip indication on the front
- Temperature compensation
- Suitable for three- and single-phase applications

### Ordering details

Setting range	Short-circuit protective device	Trip class	Type	Order code	Weight (1 pce) kg
A					
66 ... 90	200 A, Fuse type gG	10A	TF140DU-90	1SAZ431201R1001	0.820
80 ... 110	224 A, Fuse type gG	10A	TF140DU-110	1SAZ431201R1002	0.820
100 ... 135	224 A, Fuse type gG	10A	TF140DU-135	1SAZ431201R1003	0.820
110 ... 142	250 A, Fuse type gG	10A	TF140DU-142	1SAZ431201R1004	0.820

### Ordering details accessories

For thermal overload relays	Description	Type	Order code	Weight (1 pce) kg
A				
TF140DU	Reset push button*	KPR-101L	1SFA616162R1014	0.027

\*Note: for more information see catalogue 1SFC151004C0201

### Main dimensions mm, inches

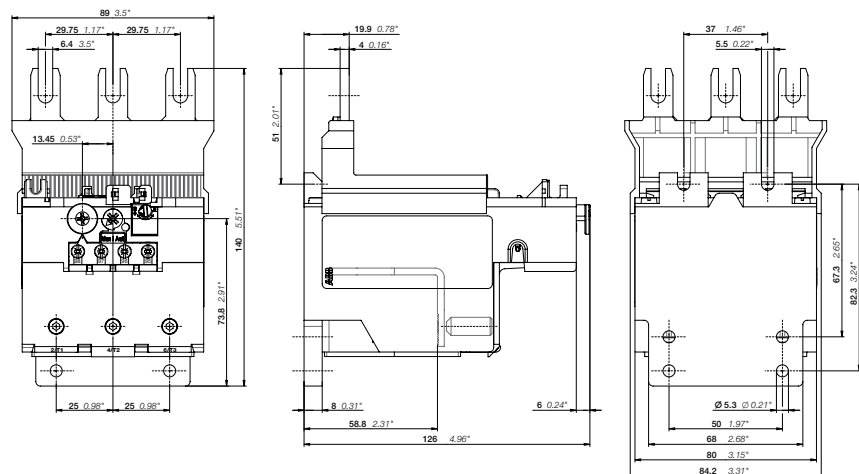

TF140DU

2CDC230008F0012

2CDC106054C0201

# TF140DU thermal overload relays

## Technical data

### Main circuit – Utilization characteristics according to IEC/EN

Type	TF140DU
Standards	IEC/EN 60947-1, IEC/EN 60947-4-1, IEC/EN 60947-5-1
Rated operational voltage $U_n$	690 V AC
Rated frequency	DC, 50/60 Hz
Frequency range	0 ... 400 Hz
Trip class	10A
Number of poles	3
Duty time	100 %
Operating frequency without early tripping	Up to 15 operations/h, see "Technical diagram – Intermittent periodic duty"
Rated impulse withstand voltage $U_{imp}$	8 kV
Rated insulation voltage $U_i$	690 V

### Auxiliary circuit according to IEC/EN

Type	TF140DU
Rated operational voltage $U_n$	500 V AC, 440 V DC
Conventional free air thermal current $I_{th}$	N.C., 95-96 10 A N.O., 97-98 6 A
Rated frequency	DC, 50/60 Hz
Number of poles	1 N.O. + 1 N.C.
$I_e$ / Rated operational current AC-15 acc. to IEC/EN 60947-5-1 for utilization category	
110-120 V	N.C., 95-96 3.00 A N.O., 97-98 1.50 A
220-230-240 V	N.C., 95-96 1.50 A N.O., 97-98 1.50 A
440 V	N.C., 95-96 1.00 A N.O., 97-98 1.00 A
480-500 V	N.C., 95-96 1.00 A N.O., 97-98 1.00 A
$I_e$ / Rated operational current DC-13 acc. to IEC/EN 60947-5-1 for utilization category	
24 V	N.C., 95-96 1.25 A N.O., 97-98 1.25 A
60 V	N.C., 95-96 0.25 A N.O., 97-98 0.25 A
110-120-125 V	N.C., 95-96 0.25 A N.O., 97-98 0.25 A
250 V	N.C., 95-96 0.12 A N.O., 97-98 0.04 A
Minimum switching capacity	17 V / 3 mA
Short-circuit protective device	N.C., 95-96 10 A, Fuse type gG N.O., 97-98 6 A, Fuse type gG
Rated impulse withstand voltage $U_{imp}$	6 kV
Rated insulation voltage $U_i$	690 V

### Technical diagram – Intermittent periodic duty

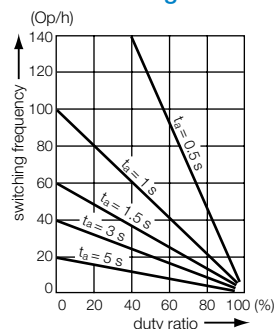

$t_s$ : Motor starting time

2CDC32005F0211

2CDC106054C0201

# TF140DU thermal overload relays

## Technical data

### Main circuit – Utilization characteristics according to UL/CSA

Type	TF140DU
Standards	UL 508, CSA 22.2 No. 14, UL 60947-4-1A
Maximum operational voltage	600 V AC
Trip rating	125 % of FLA
Full load amps (FLA)	See table "Full load amps and short-circuit protective device"
Short-circuit rating RMS symmetrical	See table "Full load amps and short-circuit protective device"
Short-circuit protective device	See table "Full load amps and short-circuit protective device"

### Auxiliary circuit according to UL/CSA

Type	TF140DU	
Contact rating	N.C., 95-96	B600
	N.O., 97-98	C300
Conventional thermal current	N.C./N.O.	10 A / 6 A

### Full load amps and short-circuit protective device

Type	Full load amps (FLA)	Short-circuit protective device					
		480 / 600 V AC		480 / 600 V AC		480 / 600 V AC	
		Short circuit rating RMS symmetrical	Fuse type	Short circuit rating RMS symmetrical	Fuse type	Short circuit rating RMS symmetrical	Listed circuit breaker
TF140DU-90	90 A	10 kA	250 A, K5 / RK5	100 kA	250 A, Class J	100 kA	250 A
TF140DU-110	110 A	10 kA	250 A, K5 / RK5	100 kA	250 A, Class J	100 kA	250 A
TF140DU-135	135 A	10 kA	250 A, K5 / RK5	100 kA	250 A, Class J	100 kA	250 A
TF140DU-142	142 A	10 kA	250 A, K5 / RK5	100 kA	250 A, Class J	100 kA	250 A

7

# TF140DU thermal overload relays



## Technical data

### General technical data





Type	TF140DU	
Pollution degree	3	
Phase loss sensitive	Yes	
Ambient air temperature		
Operation	Open - compensated	-25 ... +55 °C
	Open	-25 ... +55 °C
Storage	-40 ... +70 °C	
Ambient air temperature compensation	Acc. to IEC/EN 60947-4-1	
Maximum operating altitude permissible	2000 m	
Resistance to shock acc. to IEC 60068-2-27	12g / 11 ms	
Mounting position	Position 1-5	
Mounting	Mount on the contactor and tighten the screws of the main circuit terminals	
Degree of protection	Housing	IP20
	Main circuit terminals	IP00

### Electrical connection

#### Main circuit

Type	TF140DU	
Connecting capacity		
 Rigid	1 x	16 ... 70 mm <sup>2</sup>
	2 x	-
 Flexible	1 x	16 ... 70 mm <sup>2</sup>
	2 x	-
	Stranded acc. to UL/CSA	1 x or 2 x AWG 6-2/0
	Flexible acc. to UL/CSA	1 x or 2 x AWG 6-2/0
Stripping length	25 mm	
Tightening torques	8 ... 10 Nm / 77 ... 88 lb.in	
Connection screw	M8 (Hexagon)	

#### Auxiliary circuit

Type	TF140DU	
Connecting capacity		
 Rigid	1 x or 2 x	0.75 ... 4 mm <sup>2</sup>
 Flexible with ferrule	1 x or 2 x	0.75 ... 2.5 mm <sup>2</sup>
 Flexible with insulated ferrule	1 x or 2 x	0.75 ... 2.5 mm <sup>2</sup>
 Flexible	1 x or 2 x	0.75 ... 2.5 mm <sup>2</sup>
	Stranded acc. to UL/CSA	1 x or 2 x AWG 18-14
	Flexible acc. to UL/CSA	1 x or 2 x AWG 18-14
Stripping length	9 mm	
Tightening torques	0.8 ... 1.3 Nm / 12 lb.in	
Connection screw	M3.5 (Pozidriv 2)	

# TA200DU thermal overload relays

## 66 ... 200 A



2CDC231010R0011

TA200DU-200



1SFC151402F0001

KPR-101L

### Description

The TA200DU thermal overload relays are economic electromechanical protection devices for the main circuit. They offer reliable protection for motors in the event of overload or phase failure. The devices have trip class 10A.

The thermal overload relays are three pole relays with bimetal tripping elements. The motor current flows through the bimetal tripping elements and heats them directly and indirectly. In case of an overload (over current), the bimetal elements bent as a result of the heating. This leads to a release of the relay and a change of the contacts switching position (95-96 / 97-98).

- Manual or automatic reset selectable
- Phase loss sensitive acc. to IEC/EN 60947-4-1
- TEST and STOP function – Trip indication on the front
- Temperature compensation
- Suitable for three- and single-phase applications

### Ordering details

Setting range	Short-circuit protective device	Trip class	Type	Order code	Weight (1 pce) kg
A					
66 ... 90	200 A, Fuse type gG / 125 A aM	10A	TA200DU-90	1SAZ421201R1001	0.755
80 ... 110	224 A, Fuse type gG / 160 A aM	10A	TA200DU-110	1SAZ421201R1002	0.760
100 ... 135	224 A, Fuse type gG / 200 A aM	10A	TA200DU-135	1SAZ421201R1003	0.760
110 ... 150	250 A, Fuse type gG / 200 A aM	10A	TA200DU-150	1SAZ421201R1004	0.760
130 ... 175	315 A, Fuse type gG / 250 A aM	10A	TA200DU-175	1SAZ421201R1005	0.770
150 ... 200	315 A, Fuse type gG / 250 A aM	10A	TA200DU-200	1SAZ421201R1006	0.785

### Ordering details accessories

For thermal overload relays	Description	Type	Order code	Weight (1 pce) kg
A				
TA200DU	Terminal shroud	LT200/A	1SAZ401901R1001	0.090
TA200DU	Single mounting kit	DB200	1SAZ401110R0001	0.225
TA200DU	Reset push button*	KPR-101L	1SFA616162R1014	0.027

\*Note: for more information see catalogue 1SFC151004C0201

### Main dimensions mm, inches

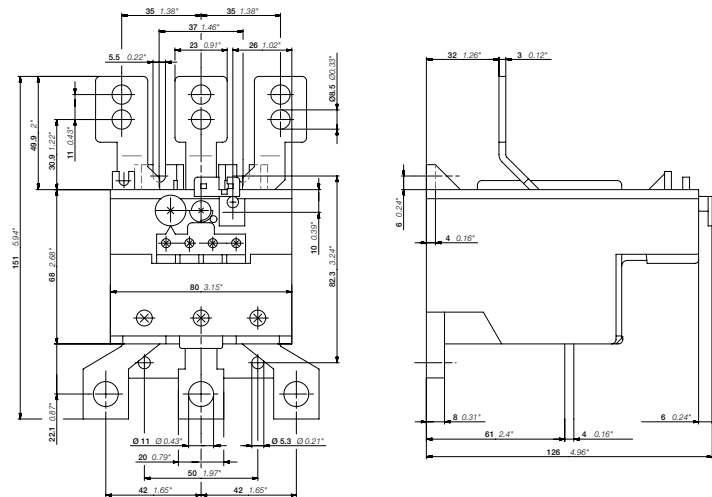

TA200DU

2CDC232021F0011

2CDC106038C0201



# TA200DU thermal overload relays

## Technical data

### Main circuit – Utilization characteristics according to IEC/EN

Type	TA200DU
Standards	IEC/EN 60947-1, IEC/EN 60947-4-1
Rated operational voltage $U_n$	690 V AC
Rated frequency	DC, 50/60 Hz
Frequency range	0 ... 400 Hz
Trip class	10A
Number of poles	3
Duty time	100 %
Operating frequency without early tripping	Up to 15 operations/h, see "Technical diagram – Intermittent periodic duty"
Rated impulse withstand voltage $U_{imp}$	6 kV
Rated insulation voltage $U_i$	690 V AC

### Auxiliary circuit according to IEC/EN

Type	TA200DU
Rated operational voltage $U_n$	500 V AC, 440 V DC
Conventional free air thermal current $I_{th}$	N.C., 95-96 10 A N.O., 97-98 6 A
Rated frequency	DC, 50/60 Hz
Number of poles	1 N.O. + 1 N.C.
$I_e$ / Rated operational current AC-15 acc. to IEC/EN 60947-5-1 for utilization category	
110-120 V	N.C., 95-96 3.00 A N.O., 97-98 1.50 A
220-230-240 V	N.C., 95-96 3.00 A N.O., 97-98 1.50 A
440 V	N.C., 95-96 1.00 A N.O., 97-98 1.00 A
480-500 V	N.C., 95-96 1.00 A N.O., 97-98 1.00 A
$I_e$ / Rated operational current DC-13 acc. to IEC/EN 60947-5-1 for utilization category	
24 V	N.C., 95-96 1.25 A N.O., 97-98 1.25 A
60 V	N.C., 95-96 0.25 A N.O., 97-98 0.25 A
110-120-125 V	N.C., 95-96 0.25 A N.O., 97-98 0.25 A
250 V	N.C., 95-96 0.12 A N.O., 97-98 0.04 A
Minimum switching capacity	17 V / 3 mA
Short-circuit protective device	N.C., 95-96 10 A, Fuse type gG N.O., 97-98 6 A, Fuse type gG
Rated impulse withstand voltage $U_{imp}$	6 kV
Rated insulation voltage $U_i$	690 V

### Technical diagram – Intermittent periodic duty

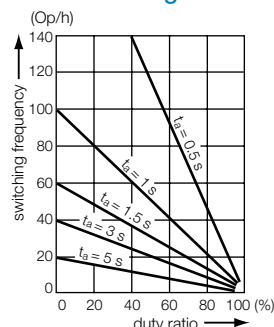

$t_s$ : Motor starting time

2CDC32005F0211

# TA200DU thermal overload relays

## Technical data

### Main circuit – Utilization characteristics according to UL/CSA

Type	TA200DU
Standards	UL 508, CSA 22.2 No. 14
Maximum operational voltage	600 V AC
Trip rating	125 % of FLA
Full load amps (FLA)	See table "Full load amps and short-circuit protective device"
Short-circuit rating RMS symmetrical	See table "Full load amps and short-circuit protective device"
Short-circuit protective device	See table "Full load amps and short-circuit protective device"

### Auxiliary circuit according to UL/CSA

Type	TA200DU
Contact rating	N.C., 95-96 C600 N.O., 97-98 B600
Conventional thermal current	5 A

### Full load amps and short-circuit protective device

Type	Full load amps (FLA)	Short-circuit protective device							
		480 / 600 V AC		225 A		100 kA		400 A	
		Short circuit rating RMS symmetrical	Fuse type	Listed circuit breaker	Short circuit rating RMS symmetrical	Fuse type	Short circuit rating RMS symmetrical	Listed circuit breaker	
TA200DU-90	90 A	10 kA	250 A, K5 / RK5	225 A	100 kA	250 A, Class J	100 kA	250 A	
TA200DU-110	110 A	10 kA	250 A, K5 / RK5	225 A	100 kA	250 A, Class J	100 kA	250 A	
TA200DU-135	135 A	10 kA	300 A, K5 / RK5	225 A	100 kA	250 A, Class J	100 kA	250 A	
TA200DU-150	150 A	10 kA	300 A, K5 / RK5	225 A	100 kA	250 A, Class J	100 kA	250 A	
TA200DU-175	175 A	10 kA	300 A, K5 / RK5	225 A	100 kA	300 A, Class J	100 kA	300 A	
TA200DU-200	200 A	10 kA	400 A, K5 / RK5	400 A	100 kA	400 A, Class J	100 kA	400 A	

# TA200DU thermal overload relays



## Technical data

### General technical data





Type	TA200DU	
Pollution degree	3	
Phase loss sensitive	Yes	
Ambient air temperature		
Operation	Open - compensated	-25 ... +55 °C
	Open	-25 ... +55 °C
Storage	-40 ... +70 °C	
Ambient air temperature compensation	Acc. to IEC/EN60947-4-1	
Maximum operating altitude permissible	2000 m	
Resistance to shock acc. to IEC 60068-2-27	12g / 15 ms	
Mounting position	Position 1-6	
Mounting	Mount on the contactor and tighten the screws of the main circuit terminals or with single mounting kit	
Degree of protection	Housing	IP20
	Main circuit terminals	IP00

### Electrical connection

#### Main circuit

Type	TA200DU	
Connecting capacity		
	 Rigid	1 x 25 ... 120 mm <sup>2</sup>
	 Flexible	1 x 25 ... 120 mm <sup>2</sup>
	Stranded acc. to UL/CSA	1 x AWG 4 ... 0000
	Flexible acc. to UL/CSA	1 x AWG 4 ... 0000
	Lugs	L > 10 mm
Tightening torques	25 Nm / 220 lb.in	
Connection screw	Open bars	

#### Auxiliary circuit

Type	TA200DU	
Connecting capacity		
	 Rigid	1 x or 2 x 0.75 ... 4 mm <sup>2</sup>
	 Flexible with ferrule	1 x or 2 x 0.75 ... 2.5 mm <sup>2</sup>
	 Flexible with insulated ferrule	1 x or 2 x 0.75 ... 2.5 mm <sup>2</sup>
	 Flexible	1 x or 2 x 0.75 ... 2.5 mm <sup>2</sup>
	Stranded acc. to UL/CSA	1 x or 2 x AWG 18 ... 14
	Flexible acc. to UL/CSA	1 x or 2 x AWG 18 ... 14
Stripping length	9 mm	
Tightening torques	0.8 ... 1.3 Nm / 12 lb.in	
Connection screw	M3.5 (Pozidriv 2)	

# E16DU electronic overload relays

## 0.10 to 18.9 A



2CDC231001F0007

E16DU-1.0



1SFC151402F0001

KPR-101L

### Description

The E16DU is self-supplied electronic overload relays, which means no extra external supply is needed. It offers reliable protection for motors in the event of overload or phase failure. Easy to use like a thermal overload relay and compatible with standard motor applications, the electronic overload relay is convincing, above all, due to its wide setting range, high accuracy, high operational temperature range and the possibility to select a trip class (10E, 20E, 30E). Further features are the temperature compensation, trip contact (N.C.), signal contact (N.O.), automatic or manual reset selectable, trip-free mechanism, STOP and TEST function and a trip indication. The overload relays are connected directly to the contactors.

### Ordering details

Setting range	Short-circuit protective device	Trip class	Type	Order code	Weight (1 pce) kg
<b>A</b>					
<b>E16DU electronic overload relays</b>					
0.10 ... 0.32	1 A, Fuse type gG	10E, 20E, 30E	E16DU-0.32	1SAX111001R1101	0.150
0.30 ... 1.00	4 A, Fuse type gG	10E, 20E, 30E	E16DU-1.0	1SAX111001R1102	0.150
0.80 ... 2.70	10 A, Fuse type gG	10E, 20E, 30E	E16DU-2.7	1SAX111001R1103	0.150
1.90 ... 6.30	20 A, Fuse type gG	10E, 20E, 30E	E16DU-6.3	1SAX111001R1104	0.150
5.70 ... 18.9	50 A, Fuse type gG	10E, 20E, 30E	E16DU-18.9	1SAX111001R1105	0.150

### Ordering details accessories

For thermal overload relays	Description	Type	Order code	Weight (1 pce) kg
<b>A</b>				
E16DU	Single mounting kit	DB200	1SAZ401110R0001	0.225
E16DU	Reset push button*	KPR-101L	1SFA616162R1014	0.027

\*Note: for more information see catalogue 1SFC151004C0201

### Main dimensions mm, inches

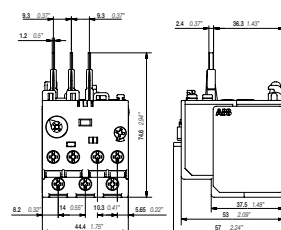

E16DU

2CDC232007F0011

2CDC107030C0201

# E16DU electronic overload relays

## Technical data

### Main circuit – Utilization characteristics according to IEC/EN

Type	E16DU
Standards	IEC/EN 60947-1, IEC/EN 60947-4-1, IEC/EN 60947-5-1
Rated operational voltage $U_n$	690 V AC
Rated frequency	50/60 Hz – not suitable for DC applications
Trip class	10E, 20E, 30E, selectable
Number of poles	3
Duty time	100 %
Operating frequency without early tripping	Up to 15 operations/h, see "Technical diagram – Intermittent periodic duty"
Rated impulse withstand voltage $U_{imp}$	6 kV
Rated insulation voltage $U_i$	690 V AC

### Auxiliary circuit according to IEC/EN

Type	E16DU
Rated operational voltage $U_n$	600 V AC / DC
Conventional free air thermal current $I_{th}$	6 A
Rated frequency	DC, 50/60 Hz
Number of poles	1 N.C. + 1 N.O.
$I_e$ / Rated operational current AC-15 acc. to IEC/EN 60947-5-1 for utilization category	
110-120 V	50/60 Hz 3.00 A
220-230-240 V	50/60 Hz 3.00 A
440 V	50/60 Hz 1.10 A
480-500 V	50/60 Hz 0.72 A
$I_e$ / Rated operational current DC-13 acc. to IEC/EN 60947-5-1 for utilization category	
24 V	1.50 A
60 V	0.55 A
110-120-125 V	0.55 A
250 V	0.27 A
Minimum switching capacity	12 V / 3 mA
Short-circuit protective device	6 A, Fuse type gG
Rated impulse withstand voltage $U_{imp}$	6 kV
Rated insulation voltage $U_i$	690 V

### Technical diagram – Intermittent periodic duty

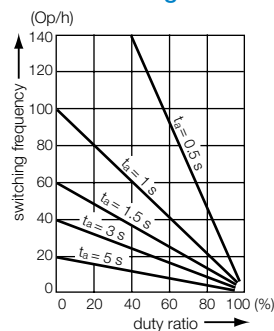

$t_a$ : Motor starting time

2CDC232005F0211

# E16DU electronic overload relays

## Technical data

### Main circuit – Utilization characteristics according to UL/CSA

Type	E16DU
Standards	UL 508, CSA 22.2, No. 14
Maximum operational voltage	600 V AC
Trip rating	125 % of FLA
Full load amps (FLA)	See table "Full load amps and short-circuit protective device"
Short-circuit rating RMS symmetrical	See table "Full load amps and short-circuit protective device"
Short-circuit protective device	See table "Full load amps and short-circuit protective device"

### Auxiliary circuit according to UL/CSA

Type	E16DU
Contact rating	B600, Q300
Conventional thermal current	5 A

### Full load amps and short-circuit protective device

Type	Full load amps (FLA)	Short-circuit protective device					
		480 V AC		600 V AC			
		SCCR	Fuse type	SCCR	Fuse type	SCCR	Fuse type
E16DU-0.32	0.32 A	50 kA	2 A, Class J	5 kA	2 A, K5 / RK5	100 kA	2 A, Class J
E16DU-1.0	1.00 A	50 kA	2 A, K5 / RK5	5 kA	2 A, K5 / RK5	100 kA	2 A, Class J
E16DU-2.7	2.70 A	50 kA	4 A, K5 / RK5	5 kA	4 A, K5 / RK5	100 kA	4 A, Class J
E16DU-6.3	6.30 A	50 kA	15 A, K5 / RK5	5 kA	15 A, K5 / RK5	100 kA	15 A, Class J
E16DU-18.9	18.90 A	50 kA	30 A, K5 / RK5	5 kA	30 A, K5 / RK5	100 kA	30 A, Class J

# E16DU electronic overload relays



## Technical data

### General data





Type	E16DU	
Pollution degree	3	
Phase loss sensitive	Yes	
Ambient air temperature		
Operation	Open - compensated	-25 ... +70 °C
Storage		-50 ... +85 °C
Ambient air temperature compensation	Acc. to IEC/EN60947-4-1	
Maximum operating altitude permissible	2000 m	
Resistance to shock acc. to IEC 60068-2-27	15g / 11 ms	
Resistance to vibrations acc. to IEC 60068-2-6	5g / 3 ... 150 Hz	
Mounting position	Position 1-6	
Mounting	Mount on the contactor and tighten the screws of the main circuit terminals or with single mounting kit	
Degree of protection	Housing	IP20
	Main circuit terminals	IP20

### Electrical connection

#### Main circuit

Type	E16DU	
Connecting capacity		
 Rigid	1 x	1 ... 4 mm <sup>2</sup>
	2 x	1 ... 4 mm <sup>2</sup>
 Flexible with insulated ferrule	1 x	0.75 ... 2.5 mm <sup>2</sup>
	2 x	0.75 ... 2.5 mm <sup>2</sup>
Stranded acc. to UL/CSA	1 x	AWG 16-10
	2 x	AWG 16-10
Flexible acc. to UL/CSA	1 x	AWG 16-10
	2 x	AWG 16-10
Stripping length	9 mm	
Tightening torques	0.8 - 1.5 Nm / 7 lb.in	
Connection screw	M3.5 (Pozi driv 2)	

#### Auxiliary circuit

Type	E16DU	
Connecting capacity		
 Rigid	1 or 2 x	1 ... 4 mm <sup>2</sup>
 Flexible with ferrule	1 or 2 x	0.75 ... 2.5 mm <sup>2</sup>
 Flexible with insulated ferrule	1 or 2 x	0.75 ... 2.5 mm <sup>2</sup>
 Flexible	1 or 2 x	0.75 ... 2.5 mm <sup>2</sup>
Stranded acc. to UL/CSA	1 or 2 x	AWG 16-10
Flexible acc. to UL/CSA	1 or 2 x	AWG 16-10
Stripping length	9 mm	
Tightening torques	0.8 ... 1.2 Nm / 7 lb.in	
Connection screw	M3.5 (Pozi driv 2)	

# E16DU electronic overload relays

## Accessories



2CDC231003R0010

DB16E

### Description

Single mounting kit is available as accessory for E16DU. The single mounting kits offer the possibility to mount the overload relay separately from the contactor.

### Ordering details

For electronic overload relays	Description	Type	Order code	Weight (1 pce) kg
<b>Single mounting kits</b>				
E16DU	Single mounting kit	DB16E	1SAX101110R0001	0.035

### Main dimensions mm, inches

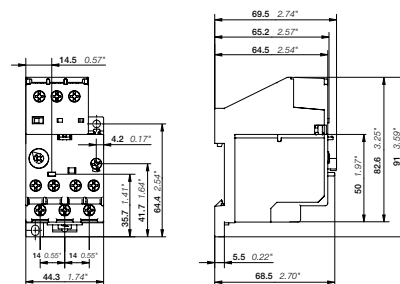

DB16E

2CDC232027F0011

2CDC107030C0201



# EF19, EF45 electronic overload relays

## 0.10 to 45.0 A



1SBC10114RF0010

EF19-18.9



1SBC10114RF0010

EF45-30



1SFC151402F001

KPR-101L

### Description

The EF19 and EF45 are self-supplied electronic overload relays, which means no extra external supply is needed. It offers reliable protection for motors in the event of overload or phase failure. Easy to use like a thermal overload relay and compatible with standard motor applications, the electronic overload relay is convincing, above all, due to its wide setting range, high accuracy, high operational temperature range and the possibility to select a trip class (10E, 20E, 30E). Further features are the temperature compensation, trip contact (N.C.), signal contact (N.O.), automatic or manual reset selectable, trip-free mechanism, STOP and TEST function and a trip indication. The overload relays are connected directly to the contactors.

### Ordering details

Setting range	Short-circuit protective device	Trip class	Type	Order code	Weight (1 pce) kg
<b>A</b>					
<b>EF19 electronic overload relays</b>					
0.10 ... 0.32	1 A, Fuse type gG	10E, 20E, 30E	EF19-0.32	1SAX121001R1101	0.158
0.30 ... 1.00	4 A, Fuse type gG	10E, 20E, 30E	EF19-1.0	1SAX121001R1102	0.158
0.80 ... 2.70	10 A, Fuse type gG	10E, 20E, 30E	EF19-2.7	1SAX121001R1103	0.158
1.90 ... 6.30	20 A, Fuse type gG	10E, 20E, 30E	EF19-6.3	1SAX121001R1104	0.158
5.70 ... 18.9	50 A, Fuse type gG	10E, 20E, 30E	EF19-18.9	1SAX121001R1105	0.158
<b>EF45 electronic overload relays</b>					
9.00 ... 30.0	160 A, Fuse type gG	10E, 20E, 30E	EF45-30	1SAX221001R1101	0.362
15.0 ... 45.0	160 A, Fuse type gG	10E, 20E, 30E	EF45-45	1SAX221001R1102	0.362

### Ordering details accessories

For thermal overload relays	Description	Type	Order code	Weight (1 pce) kg
<b>A</b>				
EF19, EF45	Reset push button*	KPR-101L	1SFA616162R1014	0.027

\*Note: for more information see catalogue 1SFC151004C0201

### Main dimensions mm, inches

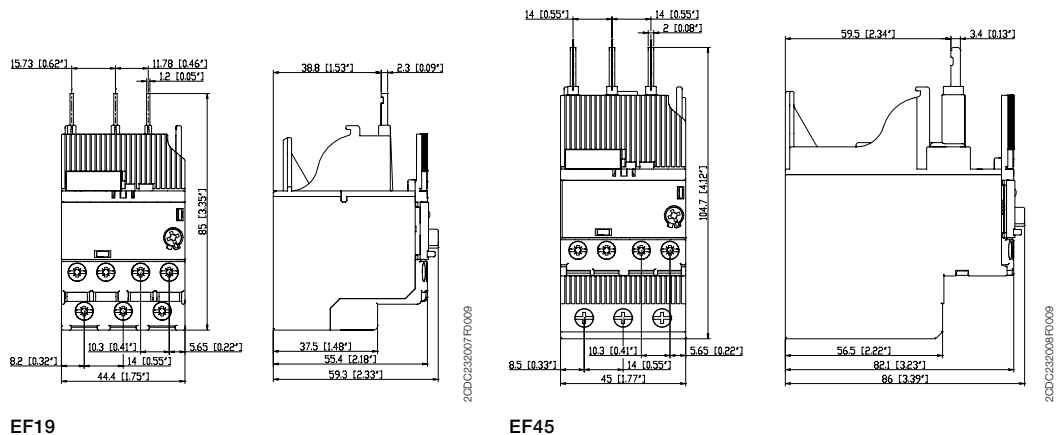

# EF19, EF45 electronic overload relays

## Technical data

### Main circuit – Utilization characteristics according to IEC/EN

Type	EF19	EF45
Standards	IEC/EN 60947-1, IEC/EN 60947-4-1, IEC/EN 60947-5-1	
Rated operational voltage $U_n$	690 V AC	
Rated frequency	50/60 Hz – not suitable for DC applications	
Trip class	10E, 20E, 30E, selectable	
Number of poles	3	
Duty time	100 %	
Operating frequency without early tripping	Up to 15 operations/h, see "Technical diagram – Intermittent periodic duty"	
Rated impulse withstand voltage $U_{imp}$	6 kV	
Rated insulation voltage $U_i$	690 V AC	

### Auxiliary circuit according to IEC/EN

Type	EF19	EF45
Rated operational voltage $U_n$	600 V AC / DC	
Conventional free air thermal current $I_{th}$	6 A	
Rated frequency	DC, 50/60 Hz	
Number of poles	1 N.C. + 1 N.O.	
$I_n$ / Rated operational current AC-15 acc. to IEC/EN 60947-5-1 for utilization category		
110-120 V	50/60 Hz	3.00 A
220-230-240 V	50/60 Hz	3.00 A
440 V	50/60 Hz	1.10 A
480-500 V	50/60 Hz	0.75 A
$I_n$ / Rated operational current DC-13 acc. to IEC/EN 60947-5-1 for utilization category		
24 V		1.50 A
60 V		0.55 A
110-120-125 V		0.55 A
250 V		0.27 A
Minimum switching capacity	12 V / 3 mA	
Short-circuit protective device	6 A, Fuse type gG	
Rated impulse withstand voltage $U_{imp}$	6 kV	
Rated insulation voltage $U_i$	690 V	

### Technical diagram – Intermittent periodic duty

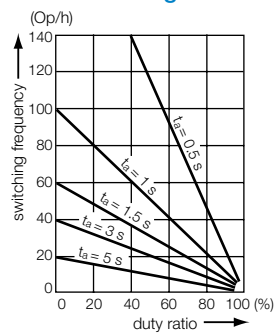

$t_a$ : Motor starting time

# EF19, EF45 electronic overload relays

## Technical data

### Main circuit – Utilization characteristics according to UL/CSA

Type	EF19	EF45
Standards	UL 508, CSA 22.2 No. 14	
Maximum operational voltage	600 V AC	
Trip rating	125 % of FLA	
Full load amps (FLA)	See table "Full load amps and short-circuit protective device"	
Short-circuit rating RMS symmetrical	See table "Full load amps and short-circuit protective device"	
Short-circuit protective device	See table "Full load amps and short-circuit protective device"	

### Auxiliary circuit according to UL/CSA

Type	EF19	EF45
Contact rating	N.C., 95-96 N.O., 97-98	B600, Q600 B600, Q600
Conventional thermal current	5 A	

### Full load amps and short-circuit protective device

Type	Full load amps (FLA)	Short-circuit protective device					
		480 V AC		600 V AC			
		SCCR	Fuse type	SCCR	Fuse type	SCCR	Fuse type
EF19-0.32	0.32 A	50 kA	2 A, Class J	5 kA	2 A, K5 / RK5	100 kA	2 A, Class J
EF19-1.0	1.00 A	50 kA	2 A, K5 / RK5	5 kA	2 A, K5 / RK5	100 kA	2 A, Class J
EF19-2.7	2.70 A	50 kA	4 A, K5 / RK5	5 kA	4 A, K5 / RK5	100 kA	4 A, Class J
EF19-6.3	6.30 A	50 kA	15 A, K5 / RK5	5 kA	15 A, K5 / RK5	100 kA	15 A, Class J
EF19-18.9	18.90 A	50 kA	30 A, K5 / RK5	5 kA	30 A, K5 / RK5	100 kA	30 A, Class J

Type	Full load amps (FLA)	Short-circuit protective device					
		480 V AC		600 V AC			
		SCCR	Fuse type	SCCR	Fuse type	SCCR	Fuse type
EF45-30	30 kA	18 kA	150 A, K5 / RK5	18 kA	150 A, K5 / RK5	100 kA	150 A, Class J
EF45-45	45 kA	18 kA	200 A, K5 / RK5	18 kA	200 A, K5 / RK5	100 kA	200 A, Class J

# EF19, EF45 electronic overload relays



## Technical data

### General data





Type	EF19	EF45
Pollution degree	3	
Phase loss sensitive	Yes	
Ambient air temperature		
Operation	Open - compensated	
Storage		
Ambient air temperature compensation	-25 ... +70 °C	
Maximum operating altitude permissible	-50 ... +85 °C	
Resistance to shock acc. to IEC 60068-2-27	Acc. to IEC/EN60947-4-1	
Resistance to vibrations acc. to IEC 60068-2-6	2000 m	
Mounting position	15g / 11 ms	
Mounting	1g / 3 ... 150 Hz	
Degree of protection	Position 1-6	
Housing	Mount on the contactor and tighten the screws of the main circuit terminals	
Main circuit terminals	IP20	
	IP20	

### Electrical connection

#### Main circuit

Type	EF19	EF45
Connecting capacity		
 Rigid	1 or 2 x 1 ... 4 mm <sup>2</sup>	2.5 ... 16 mm <sup>2</sup>
 Flexible with ferrule	1 or 2 x 0.75 ... 2.5 mm <sup>2</sup>	2.5 ... 10 mm <sup>2</sup>
Stranded acc. to UL/CSA	1 or 2 x AWG 16-10	AWG 14-6
Flexible acc. to UL/CSA	1 or 2 x AWG 16-10	AWG 14-6
Stripping length	9 mm	13 mm
Tightening torques	0.8 ... 1.5 Nm / 7 ... 13 lb.in	2.3 ... 2.6 Nm / 20 ... 22 lb.in
Connection screw	M3.5 (Pozi driv 2)	

#### Auxiliary circuit

Type	EF19	EF45
Connecting capacity		
 Rigid	1 or 2 x 1 ... 4 mm <sup>2</sup>	
 Flexible with ferrule	1 or 2 x 0.75 ... 2.5 mm <sup>2</sup>	
 Flexible with insulated ferrule	1 or 2 x 0.75 ... 2.5 mm <sup>2</sup>	
 Flexible	1 or 2 x 0.75 ... 2.5 mm <sup>2</sup>	
Stranded acc. to UL/CSA	1 or 2 x AWG 18-10	
Flexible acc. to UL/CSA	1 or 2 x AWG 18-10	
Stripping length	9 mm	
Tightening torques	0.8 ... 1.2 Nm / 7 ... 11 lb.in	
Connection screw	M3 (Pozi driv 2)	

# EF65, EF96, EF146 electronic overload relays 25 to 150 A



2CDC231001F0013

EF65-70



2CDC231016F0012

EF96-100



2CDC231017F0012

EF146-150



1SFC151402F0001

KPR-101L

## Description

The EF65, EF96 and EF146 are self-supplied electronic overload relays, which means no extra external supply is needed. It offers reliable protection for motors in the event of overload or phase failure. Easy to use like a thermal overload relay and compatible with standard motor applications, the electronic overload relay is convincing, above all, due to its wide setting range, high accuracy, high operational temperature range and the possibility to select a trip class (10E, 20E, 30E). Further features are the temperature compensation, trip contact (N.C.), signal contact (N.O.), automatic or manual reset selectable, trip-free mechanism, STOP and TEST function and a trip indication. The overload relays are connected directly to the contactors.

## Ordering details

Setting range	Short-circuit protective device	Trip class	Type	Order code	Weight (1 pce) kg
A					
25 ... 70	160 A, Fuse typ gG	10E, 20E, 30E	EF65-70	1SAX331001R1101	0.790
36 ... 100	200 A, Fuse typ gG	10E, 20E, 30E	EF96-100	1SAX341001R1101	0.780
54 ... 150	315 A, Fuse typ gG	10E, 20E, 30E	EF146-150	1SAX351001R1101	0.890

## Ordering details accessories

For thermal overload relays	Description	Type	Order code	Weight (1 pce) kg
A				
EF65, EF96, EF146	Reset push button*	KPR-101L	1SFA616162R1014	0.027

\*Note: for more information see catalogue 1SFC151004C0201

## Main dimensions mm, inches

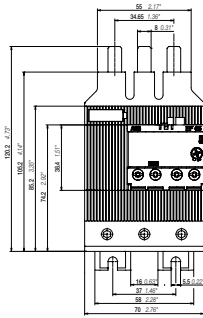

EF65-70

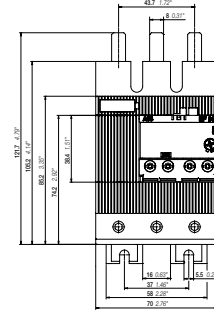
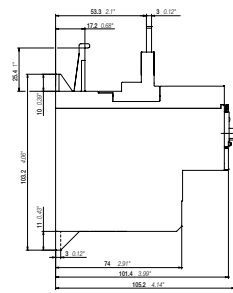

EF96-100

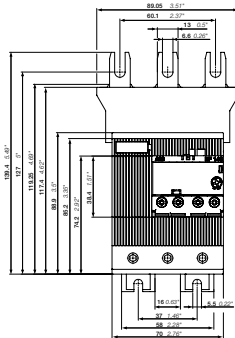

EF146-150

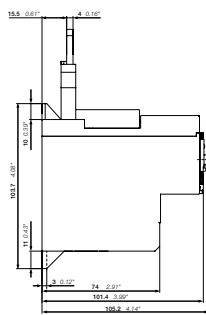

# EF65, EF96, EF146 electronic overload relays

## Technical data

### Main circuit – Utilization characteristics according to IEC/EN

Type	EF65, EF96, EF146
Standards	IEC/EN 60947-1, IEC/EN 60947-4-1, IEC/EN 60947-5-1
Rated operational voltage $U_n$	1000 V AC
Rated frequency	50/60 Hz – not suitable for DC applications
Trip class	10E, 20E, 30E, selectable
Number of poles	3
Duty time	100 %
Operating frequency without early tripping	Up to 15 operations/h, see "Technical diagram – Intermittent periodic duty"
Rated impulse withstand voltage $U_{imp}$	8 kV
Rated insulation voltage $U_i$	1000 V

### Auxiliary circuit according to IEC/EN

Type	EF65, EF96, EF146
Rated operational voltage $U_n$	600 V AC / DC
Conventional free air thermal current $I_{th}$	6 A
Rated frequency	DC, 50/60 Hz
Number of poles	1 N.C. + 1 N.O.
$I_n$ / Rated operational current AC-15 acc. to IEC/EN 60947-5-1 for utilization category	
110-120 V	50/60 Hz 3.00 A
220-230-240 V	50/60 Hz 3.00 A
400 V	50/60 Hz 1.10 A
480-500 V	50/60 Hz 0.75 A
$I_n$ / Rated operational current DC-13 acc. to IEC/EN 60947-5-1 for utilization category	
24 V	1.50 A
60 V	0.55 A
110-120-125 V	0.55 A
250 V	0.27 A
Minimum switching capacity	12 V / 3 mA
Short-circuit protective device	6 A, Fuse type gG
Rated impulse withstand voltage $U_{imp}$	6 kV
Rated insulation voltage $U_i$	690 V

### Technical diagram – Intermittent periodic duty

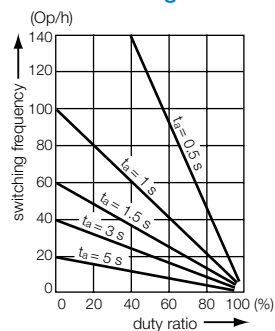

$t_a$ : Motor starting time

# EF65, EF96, EF146 electronic overload relays

## Technical data

### Main circuit – Utilization characteristics according to UL/CSA

Type	EF65, EF96, EF146
Standards	UL 508, CSA 22.2 No. 14, UL 60947-4-1A
Maximum operational voltage	600 V AC
Trip rating	125 % of FLA
Full load amps (FLA)	See table "Full load amps and short-circuit protective device"
Short-circuit rating RMS symmetrical	See table "Full load amps and short-circuit protective device"
Short-circuit protective device	See table "Full load amps and short-circuit protective device"

### Auxiliary circuit according to UL/CSA

Type	EF65, EF96, EF146
Contact rating	N.C., 95-96 B600, Q600 N.O., 97-98 B600, Q600
Conventional thermal current	6 A

### Full load amps and short-circuit protective device

Type	Full load amps (FLA)	Short-circuit protective device					
		480 V AC			600 V AC		
		SCCR	Fuse type	SCCR	Fuse type	SCCR	Fuse type
EF65-70	70 A	10 kA	150 A, R5/RK5	10kA	150 A, R5/RK5	100 kA	175 A, J
EF96-100	100 A	10 kA	200 A, R5/RK5	10kA	200 A, R5/RK5	100 kA	225 A, J
EF146-150	150 A	10 kA	250 A, R5/RK5	10kA	250 A, R5/RK5	100 kA	350 A, J

# EF65, EF96, EF146 electronic overload relays



## Technical data

### General data





Type	EF65, EF96, EF146	
Pollution degree	3	
Phase loss sensitive	Yes	
Ambient air temperature		
Operation	Open - compensated	-25 ... +70 °C
Storage		-50 ... +85 °C
Ambient air temperature compensation	Acc. to IEC/EN 60947-4-1	
Maximum operating altitude permissible	2000 m	
Resistance to shock acc. to IEC 60068-2-27	15g / 11 ms	
Resistance to vibrations acc. to IEC 60068-2-6	5g / 3 ... 150 Hz	
Mounting position	Position 1-6	
Mounting	Mount on the contactor and tighten the screws of the main circuit terminals	
Degree of protection	Housing	IP20
	Main circuit terminals	IP10

### Electrical connection

#### Main circuit

Type	EF65	EF96	EF146
Connecting capacity			
 Rigid	1 x 4 ... 35 mm <sup>2</sup> 2 x 4 ... 35 mm <sup>2</sup>	6 ... 70 mm <sup>2</sup> 6 ... 35 mm <sup>2</sup>	10 ... 95 mm <sup>2</sup> 10 ... 35 mm <sup>2</sup>
 Flexible	1 x 4 ... 35 mm <sup>2</sup> 2 x 4 ... 35 mm <sup>2</sup>	6 ... 50 mm <sup>2</sup> 6 ... 35 mm <sup>2</sup>	10 ... 70 mm <sup>2</sup> 10 ... 35 mm <sup>2</sup>
Stranded acc. to UL/CSA	1 x AWG 10-2 2 x	AWG 8-2	AWG 6-00 AWG 6-2
Flexible acc. to UL/CSA	1 x AWG 10-2 2 x	AWG 8-2	AWG 6-00 AWG 6-2
Stripping length	20 mm	20 mm	20 mm
Tightening torques	4 Nm / 35 lb.in	6 Nm / 55 lb.in	8 Nm / 70 lb.in
Connection screw	M8 (Pozidriv 2)	M8 (Hexagon 4)	M8 (Hexagon 4)

#### Auxiliary circuit

Type	EF65, EF96, EF146	
Connecting capacity		
 Rigid	1 or 2 x	1 ... 4 mm <sup>2</sup>
 Flexible with ferrule	1 or 2 x	0.75 ... 2.5 mm <sup>2</sup>
 Flexible with insulated ferrule	1 or 2 x	0.75 ... 2.5 mm <sup>2</sup>
 Flexible	1 or 2 x	0.75 ... 2.5 mm <sup>2</sup>
Stranded acc. to UL/CSA	1 or 2 x	AWG 18-10
Flexible acc. to UL/CSA	1 or 2 x	AWG 18-10
Stripping length	9 mm	
Tightening torques	0.8 ... 1.2 Nm / 7 ... 11 lb.in	
Connection screw	M3.5 (Pozidriv 2)	



# EF205, EF370 electronic overload relays 63 to 380 A



2CDC231010V0012

EF205-210



2CDC231010V0012

EF370-380



1SFC151402F0001

KPR-101L

## Description

The EF205 and EF370 are self-supplied electronic overload relays, which means no extra external supply is needed. It offers reliable protection for motors in the event of overload or phase failure. Easy to use like a thermal overload relay and compatible with standard motor applications, the electronic overload relay is convincing, above all, due to its wide setting range, high accuracy, high operational temperature range and the possibility to select a trip class (10E, 20E, 30E). Further features are the temperature compensation, trip contact (N.C.), signal contact (N.O.), automatic or manual reset selectable, trip-free mechanism, STOP and TEST function and a trip indication. The overload relays are connected directly to the contactors.

## Ordering details

Setting range	Short-circuit protective device	Trip class	Type	Order code	Weight (1 pce) kg
A					
63 ... 210	1250 A, Fuse type gG	10E, 20E, 30E	EF205-210	1SAX531001R1101	1.210
115 ... 380	1600 A, Fuse type gG	10E, 20E, 30E	EF370-380	1SAX611001R1101	1.430

## Ordering details accessories

For thermal overload relays	Description	Type	Order code	Weight (1 pce) kg
A				
EF205, EF370	Reset push button*	KPR-101L	1SFA616162R1014	0.027

\*Note: for more information see catalogue 1SFC151004C0201

## Main dimensions mm, inches

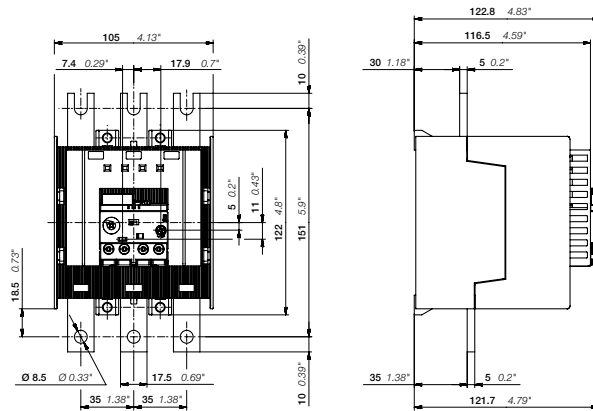

2CDC232004F0012

EF205-210

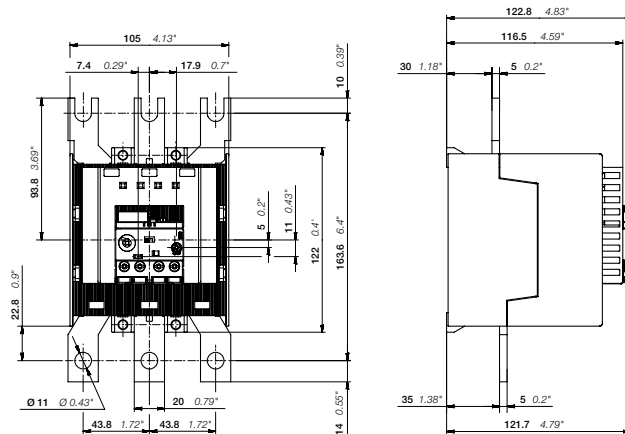

2CDC232004F0012

EF370-380

# EF205, EF370 electronic overload relays

## Technical data

### Main circuit – Utilization characteristics according to IEC/EN

Type	EF205, EF370
Standards	IEC/EN 60947-1, IEC/EN 60947-4-1, IEC/EN 60947-5-1
Rated operational voltage $U_n$	1000 V AC
Rated frequency	50/60 Hz – not suitable for DC applications
Trip class	10E, 20E, 30E, selectable
Number of poles	3
Duty time	100 %
Operating frequency without early tripping	Up to 15 operations/h, see "Technical diagram – Intermittent periodic duty"
Rated impulse withstand voltage $U_{imp}$	8 kV
Rated insulation voltage $U_i$	1000 V

### Auxiliary circuit according to IEC/EN

Type	EF205, EF370
Rated operational voltage $U_n$	600 V AC / DC
Conventional free air thermal current $I_{th}$	6 A
Rated frequency	DC, 50/60 Hz
Number of poles	1 N.C. + 1 N.O.
$I_n$ / Rated operational current AC-15 acc. to IEC/EN 60947-5-1 for utilization category	
110-120 V	50/60 Hz 3.00 A
220-230-240 V	50/60 Hz 3.00 A
400 V	50/60 Hz 1.10 A
480-500 V	50/60 Hz 0.75 A
$I_n$ / Rated operational current DC-13 acc. to IEC/EN 60947-5-1 for utilization category	
24 V	1.50 A
60 V	0.55 A
110-120-125 V	0.55 A
250 V	0.27 A
Minimum switching capacity	12 V / 3 mA
Short-circuit protective device	6 A, Fuse type gG
Rated impulse withstand voltage $U_{imp}$	6 kV
Rated insulation voltage $U_i$	690 V

### Technical diagram – Intermittent periodic duty

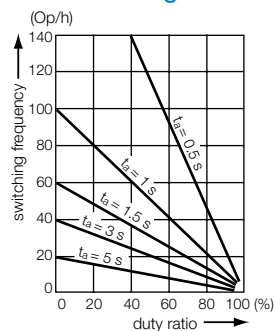

$t_a$ : Motor starting time

# EF205, EF370 electronic overload relays

## Technical data

### Main circuit – Utilization characteristics according to UL/CSA

Type	EF205, EF370
Standards	UL 508, CSA 22.2 No. 14, UL 60947-4-1A
Maximum operational voltage	600 V AC
Trip rating	125 % of FLA
Full load amps (FLA)	See table "Full load amps and short-circuit protective device"
Short-circuit rating RMS symmetrical	See table "Full load amps and short-circuit protective device"
Short-circuit protective device	See table "Full load amps and short-circuit protective device"

### Auxiliary circuit according to UL/CSA

Type	EF205, EF370
Contact rating	N.C., 95-96 B600, Q600 N.O., 97-98 B600, Q600
Conventional thermal current	6 A

### Full load amps and short-circuit protective device

Type	Full load amps (FLA)	Short-circuit protective device		600 V AC		SCCR	Fuse type
		480 V AC	Fuse type	SCCR	Fuse type		
EF205-210	210 A	10 kA	400 A, R5/RK5	10kA	400 A, R5/RK5	100 kA	400 A, J
EF370-380	380 A	18 kA	800 A, L/T	18kA	800 A, L/T	-	-

# EF205, EF370 electronic overload relays





## Technical data

### General data





Type	EF205, EF370	
Pollution degree	3	
Phase loss sensitive	Yes	
Ambient air temperature		
Operation	Open - compensated	-25 ... +70 °C
Storage		-50 ... +85 °C
Ambient air temperature compensation	Acc. to IEC/EN 60947-4-1	
Maximum operating altitude permissible	2000 m	
Resistance to shock acc. to IEC 60068-2-27	25g / 11 ms	
Resistance to vibrations acc. to IEC 60068-2-6	5g / 3 ... 150 Hz	
Mounting position	Position 1-6	
Mounting	Mount on the contactor and tighten the screws of the main circuit terminals	
Degree of protection	Housing	IP20
	Main circuit terminals	IP20

### Electrical connection

#### Main circuit

Type	EF205	EF370
Connecting capacity		
 Rigid	1 x 16 ... 185 mm <sup>2</sup> 2 x 16 ... 120 mm <sup>2</sup>	50 ... 240 mm <sup>2</sup> 50 ... 150 mm <sup>2</sup>
 Flexible	1 x 16 ... 185 mm <sup>2</sup> 2 x 16 ... 120 mm <sup>2</sup>	50 ... 240 mm <sup>2</sup> 50 ... 150 mm <sup>2</sup>
 Lugs	L ≤ 24 mm	32 mm
 Bars	Ø > 8 mm	10 mm
Stranded acc. to UL/CSA	1 x AWG 6-0000 2 x AWG 6-0000	AWG 1-500 kcmil AWG 1-500 kcmil
Flexible acc. to UL/CSA	1 x AWG 6-0000 2 x AWG 6-0000	AWG 1-500 kcmil AWG 1-500 kcmil
Stripping length	-	-
Tightening torques	18 Nm / 160 lb.in	28 Nm / 247 lb.in
Connection screw	M8	M10

#### Auxiliary circuit

Type	EF205, EF370
Connecting capacity	
 Rigid	1 or 2 x 1 ... 4 mm <sup>2</sup>
 Flexible with ferrule	1 or 2 x 0.75 ... 2.5 mm <sup>2</sup>
 Flexible with insulated ferrule	1 or 2 x 0.75 ... 2.5 mm <sup>2</sup>
 Flexible	1 or 2 x 0.75 ... 2.5 mm <sup>2</sup>
Stranded acc. to UL/CSA	1 or 2 x AWG 18-10
Flexible acc. to UL/CSA	1 or 2 x AWG 18-10
Stripping length	9 mm
Tightening torques	0.8 ... 1.2 Nm / 7 ... 11 lb.in
Connection screw	M3.5 (Pozidriv 2)

# E500DU, E800DU, E1250DU electronic overload relays 150 to 1250 A



E500DU-500

2CDC231003F0008



E800DU-800

2CDC231004F0008



E1250DU-1250

1SFC101025F0201



KPR-101L

1SFC151402F0001

## Description

The E500DU up to E1250DU are self-supplied electronic overload relays, which means no extra external supply is needed. It offers reliable protection for motors in the event of overload or phase failure. Easy to use like a thermal overload relay and compatible with standard motor applications, the electronic overload relay is convincing, above all, due to its wide setting range, high accuracy, high operational temperature range and the possibility to select a trip class (10E, 20E, 30E). Further features are the temperature compensation, trip contact (N.C.), signal contact (N.O.), automatic or manual reset selectable, trip-free mechanism, STOP and TEST function and a trip indication. Busbar kits are available as accessory for contactor mounting.

## Ordering details

Setting range	Short-circuit protective device	Trip class	Type	Order code	Weight (1 pce) kg
A					

### E500DU electronic overload relay

150 ... 500	1000 A	10E, 20E, 30E	E500DU-500	1SAX711001R1101	1.170
-------------	--------	---------------	------------	-----------------	-------

### E800DU electronic overload relay

250 ... 800	1250 A	10E, 20E, 30E	E800DU-800	1SAX811001R1101	3.905
-------------	--------	---------------	------------	-----------------	-------

### E1250DU electronic overload relay

375 ... 1250	-	10E, 20E, 30E	E1250DU-1250	1SFA739001R1000	12.181
--------------	---	---------------	--------------	-----------------	--------

## Ordering details accessories

For electronic overload relays	Description	Type	Order code	Weight (1 pce) kg
E500DU	LT500E Terminal shroud for E500DU	LT500E	1SAX701904R0001	0.360
E800DU	LT320E Terminal shroud for E320DU	LT800E	1SAX601904R0001	0.105
E500DU, E800DU	Reset push button*	KPR-101L	1SFA616162R1014	0.027

\*Note: for more information see catalogue 1SFC151004C0201

## Main dimensions mm, inches

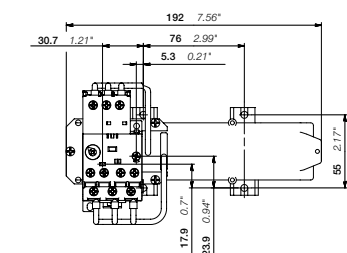
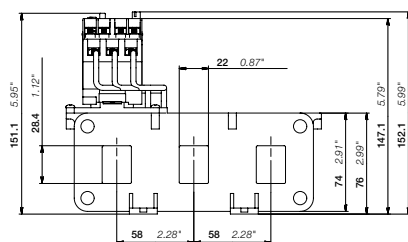

E500DU

2CDC232013F0011

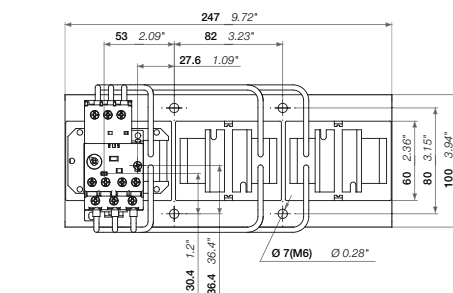
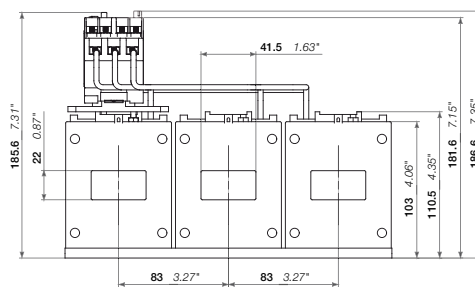

E800DU

2CDC232014F0011

2CDC107031C0201

# E500DU, E800DU, E1250DU electronic overload relays

## Technical data

### Main circuit – Utilization characteristics according to IEC/EN

Type	E500DU	E800DU	E1250DU
Standards	IEC/EN 60947-1, IEC/EN 60947-4-1, IEC/EN 60947-5-1		
Rated operational voltage $U_e$	1000 V AC		
Rated frequency	50/60 Hz – not suitable for DC applications		
Trip class	10E, 20E, 30E, selectable		
Number of poles	3		
Duty time	100 %		
Operating frequency without early tripping	Up to 15 operations/h, see "Technical diagram – Intermittent periodic duty"		
Rated impulse withstand voltage $U_{imp}$	8 kV		
Rated insulation voltage $U_i$	1000 V AC		

### Auxiliary circuit according to IEC/EN

Type	E500DU	E800DU	E1250DU
Rated operational voltage $U_e$	600 V AC / DC		
Conventional free air thermal current $I_{th}$	6 A		
Rated frequency	DC, 50/60 Hz		
Number of poles	1 N.C. + 1 N.O.		
$I_e$ / Rated operational current AC-15 acc. to IEC/EN 60947-5-1 for utilization category			
110-120 V	50/60 Hz	3.00 A	
220-230-240 V	50/60 Hz	3.00 A	
440 V	50/60 Hz	1.10 A	
480-500 V	50/60 Hz	0.72 A	
$I_e$ / Rated operational current DC-13 acc. to IEC/EN 60947-5-1 for utilization category			
24 V		1.50 A	
60 V		0.55 A	
110-120-125 V		0.55 A	
250 V		0.27 A	
Minimum switching capacity	12 V / 3 mA		
Short-circuit protective device	6 A, Fuse type gG		
Rated impulse withstand voltage $U_{imp}$	8 kV		
Rated insulation voltage $U_i$	690 V		

### Technical diagram – Intermittent periodic duty

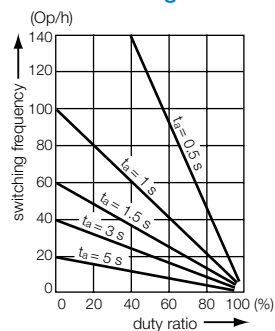

$t_a$ : Motor starting time

# E500DU, E800DU, E1250DU electronic overload relays

## Technical data

### Main circuit – Utilization characteristics according to UL/CSA

Type	E500DU	E800DU	E1250DU
Standards	UL 508, CSA 22.2 No. 14		
Maximum operational voltage	600 V AC		
Trip rating	125 % of FLA		

### Auxiliary circuit according to UL/CSA





Type	E500DU	E800DU	E1250DU
Contact rating	N.C., 95-96 N.O., 97-98	B600, Q300	
Conventional thermal current	5 A		

### General data

Type	E500DU	E800DU	E1250DU
Pollution degree	3		
Phase loss sensitive	Yes		
Ambient air temperature			
Operation	Open - compensated		
Storage	-25 ... +70 °C		
Storage	-50 ... +85 °C		
Ambient air temperature compensation	Acc. to IEC/EN60947-4-1		
Maximum operating altitude permissible	2000 m		
Resistance to shock acc. to IEC 60068-2-27	15g / 11 ms		
Resistance to vibrations acc. to IEC 60068-2-6	5g / 3 ... 150 Hz		
Degree of protection			
Housing	IP20		
Main circuit terminals	IP20		

### Electrical connection

#### Auxiliary circuit

Type	E500DU	E800DU	E1250DU
Connecting capacity			
 Rigid	1 or 2 x	1 ... 4 mm <sup>2</sup>	
 Flexible with ferrule	1 or 2 x	0.75 ... 2.5 mm <sup>2</sup>	
 Flexible with insulated ferrule	1 or 2 x	0.75 ... 2.5 mm <sup>2</sup>	
 Flexible	1 or 2 x	0.75 ... 2.5 mm <sup>2</sup>	
Stranded acc. to UL/CSA	1 or 2 x	AWG 16-10	
Flexible acc. to UL/CSA	1 or 2 x	AWG 16-10	
Stripping length	9 mm		
Tightening torques	0.8 ... 1.2 Nm / 7 lb.in		
Connection screw	M3.5 (Pozidriv 2)		





# R contactors

[Presentation](#) 8/2

---

## Overview

R contactors for the AC circuits switching 8/4

R contactors for the DC circuits switching 8/6

---

[Questionnaire](#) 8/8

---

# R contactors

## 85 to 5000 A

R contactors with variable number of poles and their variants (contactors with N.C. + N.O. poles, couplers...) are used for controlling power circuits up to 1000 V AC or 1500 V DC. They are designed with common standard components. With the combination of these elements and the adaptation possibilities, special versions can be provided. Designed for long-lasting operation and demanding applications, the ABB R contactors are used for many applications all over the world.

### Flexibility of design

- Variable number of poles
- Adjustable number of auxiliary contacts
- Optional combination of N.O. and N.C. poles
- Mechanical or magnetic latching available.

### Easy maintenance

- Direct access to all the components of the contactor
- Complete and didactic instruction manual
- Spare parts available
- Dedicated service for bar contactors.

### Exceptional durability

- Mechanical durability up to 10 millions operating cycles
- Mechanical switching frequency up to 1200 cycles per hour
- Electrical durability up to 350 000 operating cycles.

### Ideal for heavy duty applications

- High making and breaking capacity
- Fully compatible with the requirements of utilization categories AC-3, DC-3 and DC-5 (control of AC / DC motors for mining, iron and steel industries...).

### Custom-made solutions

- More than 60 years' experience in dealing with customers projects
- Development of solutions from specifications
- Pre-sales support to identify and define customer requirements
- Specialists available to help you, select your product or optimize your configuration.



# R contactors

## For heavy duty applications

R contactors meet the particular requirements of each AC / DC control application up to 5000 A, where the demands are increasing:

- Power distribution
- Photovoltaic, hydroelectric power stations
- Batteries
- Mining
- Railway networks and rolling stock
- Induction furnaces
- Pump stations
- Travelling cranes.



### Control your AC applications up to 5000 A

AC-1 Rated operational current up to 5000 A

AC-3 Rated power up to 1500 kW (1520 A - 440 V)

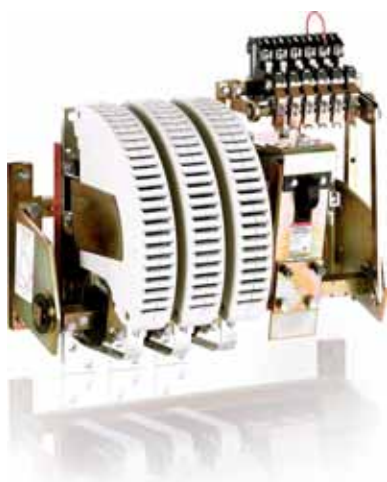

### Control your DC applications up to 5000 A

DC-1 Rated operational current up to 5000 A

DC-3 / DC-5 Rated operational current up to 2000 A  
1500 V with poles in series



### Special applications

AC / DC coupling: LOR.. contactors

Slip ring motor control: FOR.. contactors

AC / DC switching (N.C. / N.O. main poles): NOR & JOR.. contactors

Latching contactors for energy saving and safety requirements: AMA or AME contactors

Field discharge: AM(F)-CC-JORE.. contactors

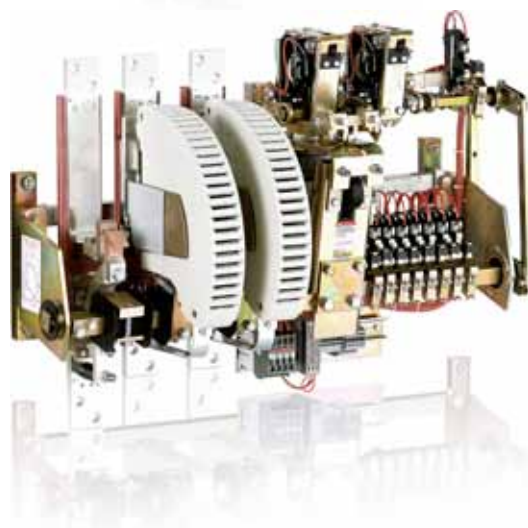

# R contactors for the AC circuits switching

Voltage  $U_e$  up to **1000 V AC**  
 Current  $I_e$  up to **4500 A**



Contactor type	AC control circuit	~	IORR63..-MT	IORR125..-MT	IORR200..-MT	IORR400..-MT	IORR500..-MT	IORR800..-MT
	DC control circuit	≡	IORE63..-MT	IORE125..-MT	IORE200..-MT	IORE400..-MT	IORE500..-MT	IORE800..-MT
<b>Categories</b>	<b>U<sub>e</sub></b>							
<b>AC-1</b>	at 40 °C	<b>I<sub>e</sub></b>	85 A	170 A	260 A	400 A	550 A	800 A
<b>AC-3</b>	690 V AC	<b>I<sub>e</sub></b>	85 A	160 A	260 A	400 A	550 A	800 A
	1000 V AC max.	<b>I<sub>e</sub></b>	56 A	105 A	180 A	280 A	380 A	580 A
<b>AC-3</b>	690 V AC	<b>Power</b>	<b>80 kW</b>	<b>150 kW</b>	<b>240 kW</b>	<b>400 kW</b>	<b>540 kW</b>	<b>780 kW</b>

8

Voltage  $U_e$  up to **500 V AC**  
 Current  $I_e$  up to **5000 A**

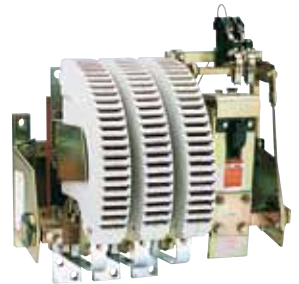

Contactor type	AC control circuit	~			IORR800	
	DC control circuit	≡			IORE800	
<b>Categories</b>	<b>U<sub>e</sub></b>					
<b>AC-1</b>	at 40 °C	<b>I<sub>e</sub></b>	From 85 A to 550 A, select above IOR...-MT			900 A
<b>AC-3</b>	380-415-440 V AC	<b>I<sub>e</sub></b>	-			800 A
	500 V AC max.	<b>I<sub>e</sub></b>	-			800 A
<b>AC-3</b>	400 V AC	<b>Power</b>	-			<b>450 kW</b>

**Recap:**

All contactors fulfill the IEC 60947-4-1 / EN 60947-4-1 standards.

- Utilization category AC-1: max. breaking current = 1.5 x  $I_e$ , max. making current = 1.5 x  $I_e$ .
- Utilization category AC-3: max. breaking current = 8 x  $I_e$ , max. making current = 10 x  $I_e$ .

Contactors with NC poles, magnetic or mechanical latching devices on request.

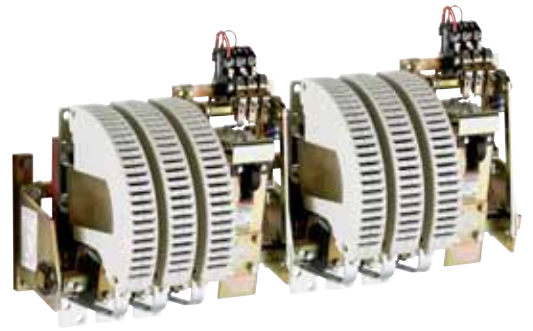

IORR1400..-MT	IORR1700..-MT	IORR2100..-MT	IORR2500..-MT	IORR3200..-MT	IORR3800..-MT	IORR4500..-MT	IORR5100..-MT
IORE1400..-MT	IORE1700..-MT	IORE2100..-MT	IORE2500..-MT	IORE3200..-MT	IORE3800..-MT	IORE4500..-MT	IORE5100..-MT
1250 A	1650 A	1850 A	2200 A	3000 A	3500 A	4000 A	4500 A
970 A	1170 A	1270 A	-	-	-	-	-
610 A	680 A	810 A	-	-	-	-	-
<b>1000 kW</b>	<b>1200 kW</b>	<b>1300 kW</b>	-	-	-	-	-

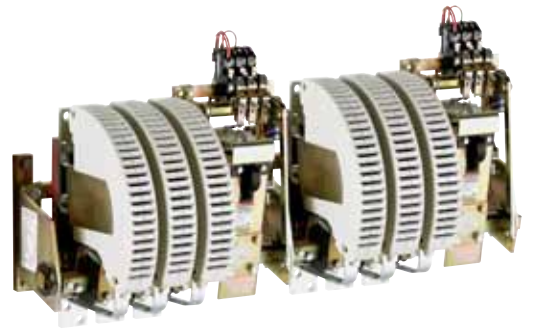

IORR1000	IORR1400	IORR1700	IORR2100	IORR2500	IORR3200	IORR3800	IORR4500	IORR5100
IORE1000	IORE1400	IORE1700	IORE2100	IORE2500	IORE3200	IORE3800	IORE4500	IORE5100
1000 A	1350 A	1650 A	2000 A	2400 A	3200 A	3800 A	4500 A	5000 A
800 A	1060 A	1260 A	1520 A	-	-	-	-	-
800 A	1080 A	1220 A	1340 A	-	-	-	-	-
<b>450 kW</b>	<b>630 kW</b>	<b>750 kW</b>	<b>900 kW</b>	-	-	-	-	-



# R contactors for the DC circuits switching

Voltage  $U_e$  up to **1500 V DC**

Current  $I_e$  up to **5000 A**



Contactor type	AC control circuit	~	IORR63..-CC	IORR125..-CC	IORR200..-CC	IORR400..-CC	IORR500..-CC
	DC control circuit	≡	IORE63..-CC	IORE125..-CC	IORE200..-CC	IORE400..-CC	IORE500..-CC
Number of poles in series*	Categories	$U_e$ max.					
1 pole	DC-1	500 V DC	$I_e$ 85 A	170 A	275 A	400 A	550 A
	DC-3 / DC-5	500 V DC	$I_e$ 68 A	140 A	205 A	350 A	500 A
2 poles	DC-1	1000 V DC	$I_e$ 85 A	170 A	275 A	400 A	550 A
	DC-3 / DC-5	1000 V DC	$I_e$ 68 A	140 A	205 A	350 A	500 A
3 poles	DC-1	1500 V DC	$I_e$ 85 A**	170 A**	275 A**	400 A**	550 A**
	DC-3 / DC-5	1500 V DC	$I_e$ 68 A**	140 A**	205 A**	350 A**	500 A**

\*Number of poles to be fitted in series according to the operational voltage and the utilization categories.

\*\*Version with increased insulation for 1000 V DC <  $U_e$  ≤ 1500 V DC, please consult us.

8

## Contactors

UL / CSA approved 

Voltage  $U_e$  up to **600 V DC**

Current  $I_e$  up to **2000 A**



Contactor type	AC control circuit	~	IORR800-10-CC	IORR1000-10-CC	IORR1400-10-CC	IORR1700-10-CC	IORR2100-10-CC
	DC control circuit	≡	IORE800-10-CC	IORE1000-10-CC	IORE1400-10-CC	IORE1700-10-CC	IORE2100-10-CC
		$U$ max.					
1 pole	General use	600 V DC	$I_e$ 800 A	1000 A	1300 A	1700 A	2000 A

### Recap:

All contactors fulfill the IEC 60947-4-1 / EN 60947-4-1 standards.

Utilization category DC-1: max. breaking current = 1.5 x  $I_e$ ,  
max. making current = 1.5 x  $I_e$ .

Utilization categories DC-3 / DC-5: max. breaking current = 4 x  $I_e$ ,  
max. making current = 4 x  $I_e$ .

Contactors with NC poles, magnetic or mechanical latching devices on request.

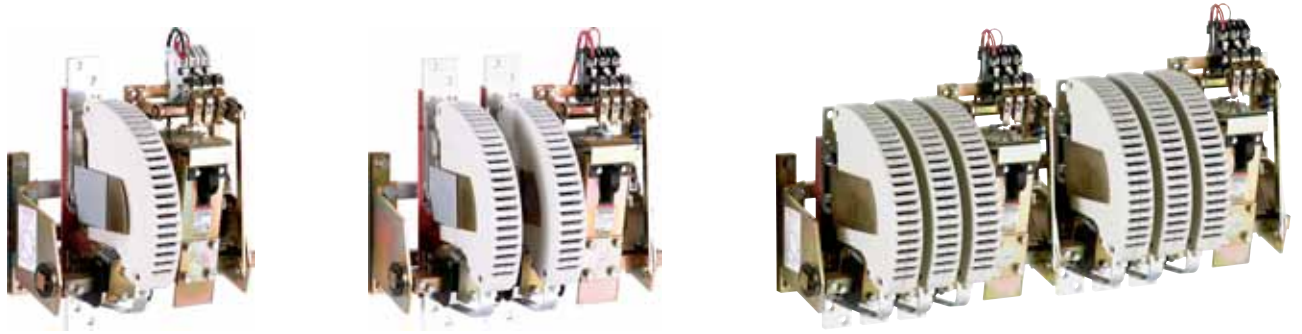

[IORR800.-CC](#) [IORR1000.-CC](#) [IORR1400.-CC](#) [IORR1700.-CC](#) [IORR2100.-CC](#) [IORR2500.-CC](#) [IORR3200.-CC](#) [IORR3800.-CC](#) [IORR4500.-CC](#) [IORR5100.-CC](#)  
[IORE800.-CC](#) [IORE1000.-CC](#) [IORE1400.-CC](#) [IORE1700.-CC](#) [IORE2100.-CC](#) [IORE2500.-CC](#) [IORE3200.-CC](#) [IORE3800.-CC](#) [IORE4500.-CC](#) [IORE5100.-CC](#)

**Ue max.**

750 V DC	800 A	1000 A	1250 A	1600 A	2000 A	2300 A	3200 A	3800 A	4500 A	5000 A
600 V DC	720 A	1000 A	1250 A	1600 A	2000 A	On request	On request	On request	On request	On request
1500 V DC	800 A	1000 A	1250 A	1600 A	2000 A	2300 A	3200 A	3800 A	4500 A	5000 A
1000 V DC	720 A	1000 A	1250 A	1600 A	2000 A	On request	On request	On request	On request	On request
1500 V DC	800 A	1000 A	1250 A	1600 A	2000 A	2300 A	3200 A	3800 A	4500 A	5000 A
1500 V DC	720 A	1000 A	1250 A	1600 A	2000 A	On request	On request	On request	On request	On request

## Product overview

Upper terminal plate  
for power circuit (network)

2 N.O. main poles with arc chutes

Main frame  
for contactor fixing

Lower terminal plate  
for power circuit (utilization)

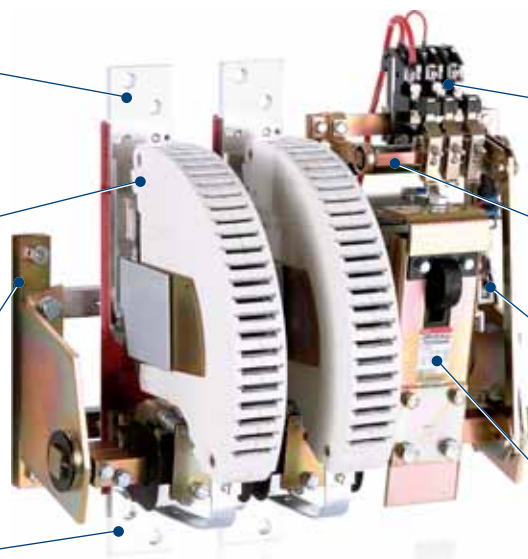

CA15.. auxiliary contacts  
1 N.O. + 1 N.C. fitted as  
standard (extra auxiliary  
contacts on request)

Auxiliary frame  
for auxiliary contacts

Connecting terminals  
for coil supply

Electro-magnet (RR type),  
laminated magnetic circuit,  
AC coil, direct supply

# Questionnaire

## Specification for R contactors

Customer .....  
 Contact person ..... Date .....  
 Tel. .... e-mail .....

ABB .....  
 Contact person .....  
 Tel. ....

Quantity ..... Requested delivery date .....  
 Project / Application .....

### Power circuit

#### AC switching

Application type

- AC-1 (resistive load)
- AC-3 (direct starting, switching off running motors)
- No load breaking
- Other .....

Number of poles: N.O. .... N.C. ....

Rated operational current  $I_e$  ..... A

Max. making current ..... A

Max. breaking current ..... A

Rated operational voltage  $U_e$  ..... V ..... Hz

or

#### DC switching

Application type

- DC-1 (resistive load)
- DC-3 (shunt motors)
- DC-5 (series motors)
- No load breaking
- Other ..... L/R ..... ms

Number of poles: N.O. .... N.C. ....

Rated operational current  $I_e$  ..... A

Making current ..... A

Breaking current min. .... A max. .... A

Rated operational voltage  $U_e$  ..... V DC

### Operating conditions

Switching frequency ..... cycles/h

Mech. durability required (millions of operating cycles) .....

Remarks .....

### Auxiliary contacts

Number of N.O. auxiliary contacts .....

Number of N.C. auxiliary contacts .....

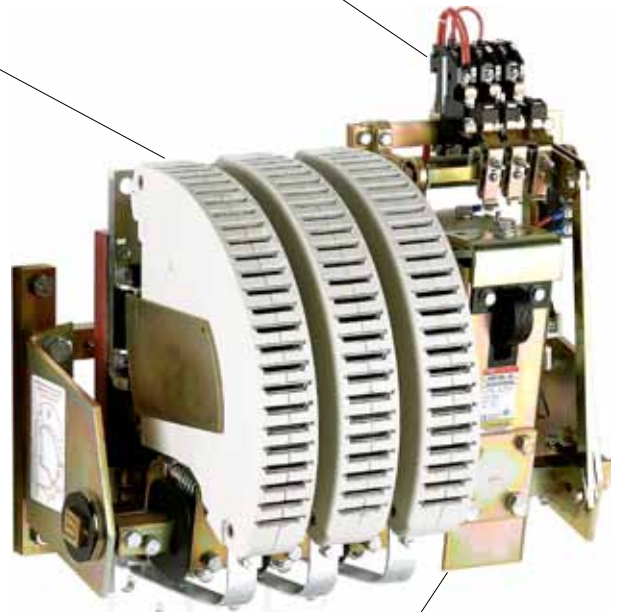

### Control circuit (coil)

AC  Voltage ..... V ..... Hz

DC  Voltage ..... V DC

#### Options

- Magnetical latching
- Mechanical latching

### Accessories

Please add any other useful documents for further information e.g. technical specification, drawing, wiring diagram, etc.

### Replacement of an existing contactor

Brand .....

Type .....

Fixing dimension F = ..... mm

Overall dimensions W = ..... mm

H = ..... mm

D = ..... mm

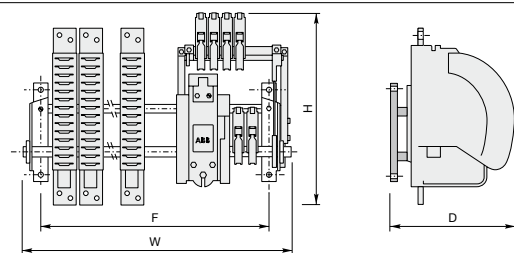

Please photocopy and forward. Questionnaire also available on the ABB Website:

[www.abb.com/lowvoltage](http://www.abb.com/lowvoltage) Section: Our offering Select: Control Products > Contactors > Bar mounted contactors







# Motor control and protection

## Motor control and protection

Benefits and advantages .....	9/2
Technical data .....	9/3

# Motor control and protection

## Benefits and advantages

UMC100-FBP is a flexible, modular and expandable motor management system for constant-speed low-voltage range motors. It's most important tasks include motor protection, prevention of plant standstills and the reduction of down time. This is made possible by early information relating to possible motor problems which avoids unplanned plant standstills. Even if a motor trips, quick diagnosis of the cause of the fault serves to reduce downtime.

UMC100-FBP combines in a very compact unit:

### Motor protection

- Overload, underload
- Overvoltage, undervoltage
- Blocked rotor, low / high current
- Phase failure, imbalance, phase sequence
- Earth leakage
- Thermistor protection
- Limitation of starts per time
- One single version with integrated measuring system covers the rated motor current from 0,24 to 63 A

### Motor control

- Integrated and easy to parametrize motor starter functions like direct, reverse, star-delta,...
- Additionally free programmable logic for application specific control functions
- Expansion modules DX111, DX122 for more I/Os
- Expansion modules VI150, VI155 for 3-phase voltage measuring

### Motor diagnostics

- Quick and comprehensive access to all relevant data via fieldbus and/or operator panel
- Current, thermal load
- Phase voltages
- Power factor
- Energy

### Communication

- Communication-independent basic device
- Freely selectable fieldbus protocol with FieldBusPlug
- Profibus DP
- DeviceNet
- Modbus
- CANopen
- Ethernet Modbus TCP

### Typical application segments

- Oil & gas
- Cement
- Paper
- Mining
- Steel
- Chemical industry

#### Further information

UMC & FBP Catalogue 2CDC 190 022 D0204  
UMC & FBP Brochure 2CDC 135 011 B0202

# Motor control and protection

## Technical data



### Basic device UMC100-FBP

UMC100-FBP allows the connection of one I/O-expansion module DX111 or DX122, and one voltage module VI150 or VI155. Expansion modules are connected via 2-wire bus, the max. distance to UMC100-FBP is 3 m.

Main power	
Voltage	max 1000 V AC
Frequency	45 to 65 Hz
Rated motor current	0.24 to 63 A, without accessories
	Greater currents with transformer
Transformer diameter	11 mm (max 25 mm <sup>2</sup> )
Tripping classes	5, 10, 20, 30, 40 in accordance with EN/IEC 60947-4-1
Short-circuit protection	Separate fuse on network side

Control unit	
Supply voltage	24 V DC
Reverse polarity protection	yes
Inputs	6 digital inputs 24 V DC
	1 PTC input
Outputs	3 relay outputs relay
	1 digital output transistor
Interfaces	1 for ABB FieldBusPlug
	1 for UMC100-PAN control station
	1 for expansion module
Parametric assignment	via fieldbus, control station and / or software
Addressing	Control station or addressing set
LEDs	3 LEDs: green, yellow, red

Environment and mechanical data	
Fastening	on DIN busbar (EN50022-35) or with 4 screws x M4
Dimensions (W x H x D)	70 x 105 x 110 mm (incl. FieldBusPlug and control panel)
Weight	0.39 kg
Terminal cross-section	max. 2.5 mm <sup>2</sup> or 2 x 1.5 mm <sup>2</sup>



### I/O-expansion modules DX111 / DX122

Expansion modules to increase the number of I/Os of a UMC100-FBP. Easy use of inputs by parametrizing for fault or warning; individual message on operator panel configurable.

Supply voltage		24 V DC
Inputs	DX111	8 digital inputs 24 V DC
	DX122	8 digital inputs 110/230 V AC
Outputs	4 relay outputs relay	
	1 analogue output, 0/4 to 20 mA / 0 to 10 V configurable	
Fastening		on DIN busbar (EN50022-35)
Dimensions (W x H x D)		45 x 77 x 100 mm (without terminal block)

# Motor control and protection

## Technical data

NEW



### Voltage expansion modules

Measures the 3 phase voltages of a motor. Different versions for use in grounded and ungrounded networks.

Supply voltage		24 V DC
Inputs	VI150	3 analogue inputs 150 - 690 V AC
		For use in grounded networks
	VI155	3 analogue inputs 150 - 690 V AC
		For use in all networks
Outputs		1 relay output
Fastening		on DIN busbar (EN50022-35)
Dimensions (W x H x D)		22.5 x 77 x 100 mm (without terminal block)



### Control panel UMC100-PAN

Installation on the device or on the switching cabinet door

Graphics-enabled and backlit display, 3 LEDs for status indication

Freely configurable error messages

Multilingual: German, English, French, Italian, Portuguese, Spanish, Russian

9



### MTQ22 - UMC100 and Ethernet

- Ethernet connectivity for up to four UMC100
- Modbus TCP protocol
- Supports all network topologies
  - Star
  - Bus
  - Ring with redundancy (MRP protocol)
- No special Ethernet connectors required in MCCs
- Easy to use in withdrawable applications

# Notes

A series of horizontal dotted lines for taking notes, spanning the width of the page.





# Self resetting current limiting module

## S800-SCL-SR

Ordering details	10/2
Technical data	10/3

# S800-SCL-SR

## Self-resetting current limiting module



2CC0413389F0001

S800S-SCL-SR



2CC04133181R0001

S803W-SCL-SR

### Description

S800-SCL-SR is ABB's innovative self-resetting current limiting module which considerably increases the short-circuit breaking capacity of downstream manual motor starters and high performance MCBs. S800-SCL-SR is a self resetting current limiting module based on the S800 technology.

It limits the short-circuit current until the downstream means of protection trips. Its current continuity makes it as the ideal solution for group protection: All parallel branches remain operative. This leads to an Expanded application range of the low voltage switchgear whose short-circuit capabilities are usually limited. S800-SCL-SR can be combined with S800S high performance MCB or with manual motor starters. S800-SCL-SR can also back up a single circuit breaker or a group of circuit breakers or motor starters (group protection). Terminals and outside dimensions are identical to the S800 range.

### Ordering details

Self-resetting short-circuit limiter IEC version [A]	Type designation	Product number	EAN number	Weight [kg]	Pack. unit
			<b>7612271</b>		
<b>1-pole</b>					
32	S801S-SCL32-SR	2CCS801901R0539	412012	0.25	1
63	S801S-SCL63-SR	2CCS801901R0599	412036	0.25	1
100	S801S-SCL100-SR	2CCS801901R0639	411992	0.25	1
<b>2-pole</b>					
32	S802S-SCL32-SR	2CCS802901R0539	412074	0.5	1
63	S802S-SCL63-SR	2CCS802901R0599	412098	0.5	1
100	S802S-SCL100-SR	2CCS802901R0639	412050	0.5	1
<b>3-pole</b>					
32	S803S-SCL32-SR	2CCS803901R0539	411930	0.75	1
63	S803S-SCL63-SR	2CCS803901R0599	411947	0.75	1
100	S803S-SCL100-SR	2CCS803901R0639	411954	0.75	1

Self-resetting short-circuit limiter IEC/UL version [A]	Type designation	Product number	EAN number	Weight [kg]	Pack. unit
			<b>7612271</b>		
<b>3-pole</b>					
32	S803W-SCL32-SR	2CCS803917R0539	412319	0.75	1
63	S803W-SCL63-SR	2CCS803917R0599	412326	0.75	1
100	S803W-SCL100-SR	2CCS803917R0639	412302	0.75	1

### Main dimensions mm, inches

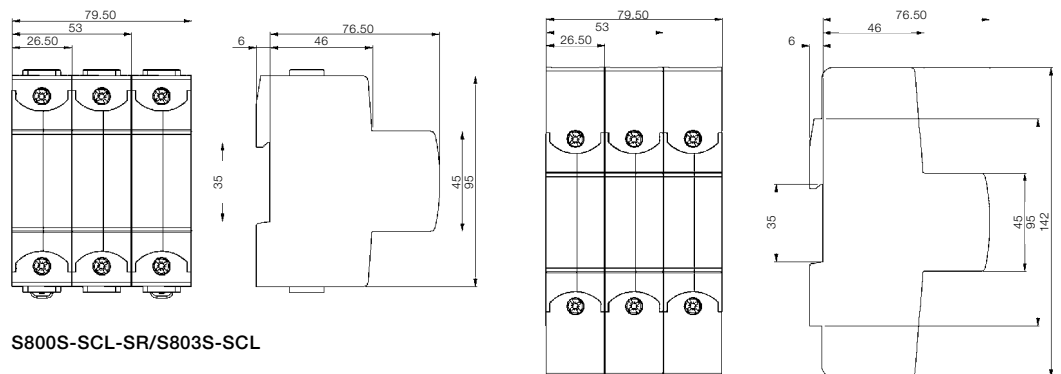

S800S-SCL-SR/S803S-SCL

S803W-SCL-SR

2CC0413012B0201

# S800S-SCL-SR/S803W-SCL-SR

## Technical data

		S800S-SCL-SR	S803W-SCL-SR
Rated operational current $I_e$	[A]	32, 63, 100	32, 63, 100
Pole		1, 2, 3	3
Rated operational voltage $U_e$			
(AC) according to IEC 60947-2	50/60 Hz [V]	400/690	690
(AC) according to UL 508	50/60 Hz [V]		600
Rated insulation voltage $U_i$	[V]	690	690
Rated impulse withstand voltage $U_{imp}$	[kV]	8	8
Rated ultimate short-circuit breaking capacity			
<b><math>I_{cu} = I_{cs}</math> according to IEC 60947-2*</b>			
(AC) 50/60 Hz 240/415 V	[kA]	100	100
(AC) 50/60 Hz 254/440 V	[kA]	100	100
(AC) 50/60 Hz 277/480 V	[kA]	65	65
(AC) 50/60 Hz 289/500 V	[kA]	65	65
(AC) 50/60 Hz 346/600 V	[kA]	65	65
(AC) 50/60 Hz 400/690 V	[kA]	50	50
<b>Short-circuit rating according to UL 508, CSA 22.2*</b>			
(AC) 50/60 Hz 480 V	[kA]	65	65
(AC) 50/60 Hz 600 V	[kA]	65	65
*) Valid only for approved combinations			
Rated frequency	[Hz]	50/60	50/60
Mounting position		any	any
Connections $C_u$			
	[mm <sup>2</sup> ]	1 ... 50 rigid (solid/stranded)	1 ... 50 rigid (solid/stranded)
	[mm <sup>2</sup> ]	1 ... 70 flexible	1 ... 70 flexible
Tightening torque			14–1 AWG
	[Nm]	min. 3 / max. 4	min. 3 / max. 4
	[in. lbs.]		min. 26.5 / max. 25
Feeding		optional	optional
Mouting on DIN top hat rail		EN 60715	EN 60715
Ambient air temperature	[°C]	-40 ... +70	-40 ... +70
Storage temperature	[°C]	-40 ... +85	-40 ... +85
Degree of protection		IP20	IP20
Classification acc. to NF F 16-101, NF F 16-102		I3, F2	I3, F2
Damp Heat		IEC 60068-2-30, 55 °C / 95 % r.h.	IEC 60068-2-30, 55 °C / 95 % r.h.
Vibration		IEC 60068-2-6, 5–10 Hz / 3 mm and 10–500 Hz / 2 g at 0.5 x $I_e$	IEC 60068-2-6, 5–10 Hz / 3 mm and 10–500 Hz / 2 g at 0.5 x $I_e$
Random Vibration		IEC 60068-2-64, 5–500 Hz / 2 g at 0.5 x $I_e$	IEC 60068-2-64, 5–500 Hz / 2 g at 0.5 x $I_e$
Resistance to climatic conditions		IEC 60068-2-1 /-2-2 /-2-30	IEC 60068-2-1 /-2-2 /-2-30
Standard		IEC 60947-2 IEC 60947-4-1	IEC 60947-2 IEC 60947-4-1 UL 508, CSA 22.2 No. 14

### Internal resistance at 25°C ambient temperature and nominal power losses

Rated current $I_n$ [A]	Internal resistance $R_i$ [mΩ/pole]	Power losses $P_{vn}$ [W/pole]
32	2.8	3.6
63	1.3	5.7
100	0.7	7.8

### Influence of ambient temperature – single mounted devices

Rated current $I_n$ [A]	10°C	15°C	20°C	25°C	30°C	35°C	40°C	45°C	50°C	55°C	60°C	65°C	70°C
32	38.2	37.2	35.8	35.2	34.2	33.3	32	30.7	29.8	28.8	27.8	26.5	25.1
63	75.3	73.2	70.6	69.3	67.4	65.5	63	60.5	58.6	56.7	54.8	52.3	49.8
100	119.5	116.2	112	110	107	104	100	96	93	90	87	84	80

# S800-SCL-SR

## Technical data

### Short circuit breaking capacity

	S800S-SCL-SR	S803W-SCL-SR
Rated ultimate short-circuit breaking capacity		
<b>I<sub>cu</sub> = I<sub>cs</sub> according to IEC 60947-2</b>		
(AC) 50/60 Hz 240/415V	[kA] 100	100
(AC) 50/60 Hz 254/440V	[kA] 100	100
(AC) 50/60 Hz 277/480V	[kA] 65	65
(AC) 50/60 Hz 289/500V	[kA] 65	65
(AC) 50/60 Hz 346/600V	[kA] 65	65
(AC) 50/60 Hz 400/690V	[kA] 50	50
<b>Short-circuit rating according to UL 508, CSA 22.2</b>		
(AC) 50/60 Hz 480V	[kA]	65
(AC) 50/60 Hz 600V	[kA]	65

### Coordination

Type	230V AC						400V AC						440V AC					
	Ics		Fuse		Current Limiter		Ics		Fuse		Current Limiter		Ics		Fuse		Current Limiter	
	kA	kA	kA	A	kA	A	kA	kA	kA	A	kA	A	kA	kA	kA	A	kA	A
MS132-0.16																		
MS132-0.25																		
MS132-0.4																		
MS132-0.63																		
MS132-1.0	No back-up required						No back-up required						No back-up required					
MS132-1.6																		
MS132-2.5													20	20	100	35	100	32, 63,100
MS132-4.0													20	20	100	63	100	32, 63,100
MS132-6.3													20	20	100	100	100	32, 63,100
MS132-10													20	20	100	100	100	32, 63,100
MS132-12													20	20	100	125	100	32, 63,100
MS132-16													20	20	100	125	100	32, 63,100
MS132-20													20	20	100	125	100	32, 63,100
MS132-25	50	50	100	125	100	63,100	50	50	100	125	100	63,100	20	20	100	125	100	63,100
MS132-32	25	50	100	125	100	63,100	25	50	100	125	100	63,100	20	20	100	125	100	63,100

Type	500V AC						690V AC					
	Ics		Fuse		Current Limiter		Ics		Fuse		Current Limiter	
	kA	kA	kA	A	kA	A	kA	kA	kA	A	kA	A
MS132-0.16												
MS132-0.25												
MS132-0.4												
MS132-0.63												
MS132-1.0	No back-up required						No back-up required					
MS132-1.6												
MS132-2.5	20	20	100	35	65*	32, 63,100	3	3	80	35	50**	32, 63,100
MS132-4.0	20	20	100	63	65*	32, 63,100	3	3	80	63	50**	32, 63,100
MS132-6.3	20	20	100	100	65*	32, 63,100	3	3	80	100	50**	32, 63,100
MS132-10	20	20	100	100	65*	32, 63,100	3	3	80	100	50**	32, 63,100
MS132-12	20	20	100	125	65*	32, 63,100	3	3	80	125	50**	32, 63,100
MS132-16	20	20	100	125	65*	32, 63,100	3	3	80	125	50**	32, 63,100
MS132-20	20	20	100	125	65*	32, 63,100	3	3	80	125	50**	32, 63,100
MS132-25	10	10	100	125	65*	63,100	3	3	80	125	50**	63,100
MS132-32	10	10	100	125	65*	63,100	3	3	80	125	50**	63,100

\* 100 kA on request  
 \*\* 80 kA on request

# S800-SCL-SR and S803S-SCL

## Technical data

### Installation requirements

The total sum of the rated currents of all downstream motor starters or circuit breakers shall not exceed the rated current of the S800-SCL-SR. Furthermore the sum of all load currents including inrush currents shall not exceed the maximum permissible load of the S800-SCL-SR.

### Maximum load

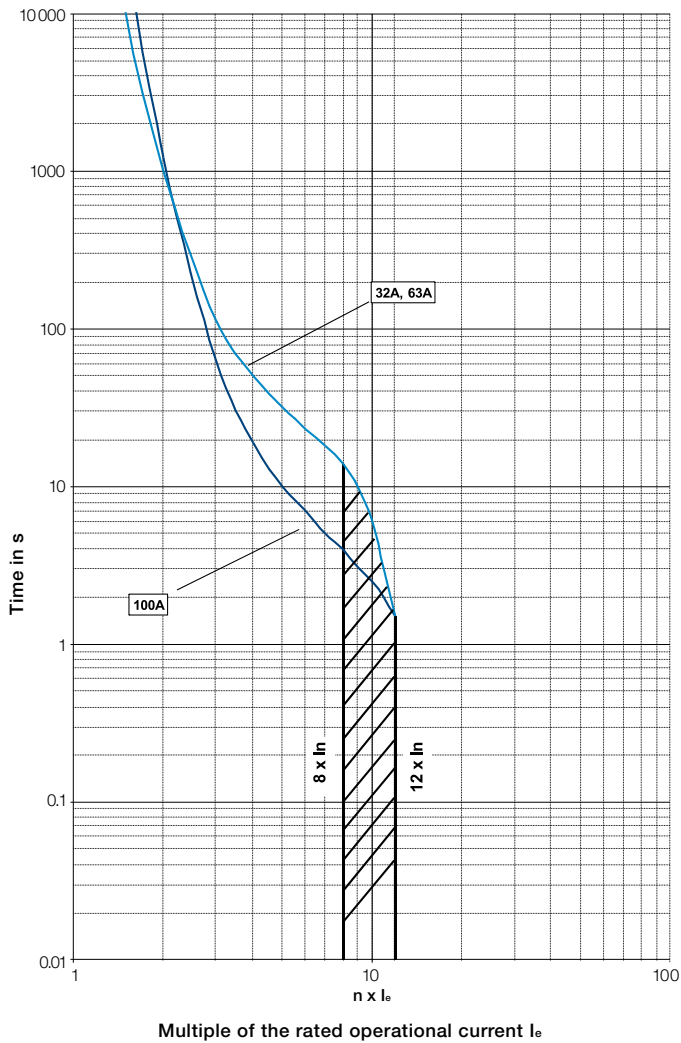



# General technical data

## General technical data

Coordination with short-circuit protection devices	11/2
Standards, specifications and certifying organizations	11/4
Terms and technical definitions	11/6
Standards and utilization categories	11/8
Degrees of protection	11/10
Climatic withstand of devices	11/11

# Coordination with short-circuit protection devices

In compliance with standards IEC 60947-4-1 and EN 60947-4-1, we define for the contactors and starters the type, rating and characteristics of the short-circuit protection devices SCPD which allow selective protection against overloads and ensure protection against short circuits.

## Basic functions

Any starter is designed to:

- start motors,
- ensure continuous functioning of motors,
- disconnect motors from the supply line,
- guarantee protection of motors against overloads.

The starter is typically made up of a switching device (contactor) and an overload protection device (thermal overload relay or electronic overload relay).

These two devices MUST be coordinated with equipment capable of providing protection against short circuit (SCPD: short circuit protective device): typically a circuit breaker with magnetic release only or a switch fuse. These are not necessarily part of the starter.

## Applicable standards

IEC 60947-4-1 (EN 60947-4-1) precisely defines the different points to be considered in order to carry out correct coordination.

Complete coordination for a combination includes the following points:

- Selectivity test between the overload relay and the short-circuit protection device SCPD.
- Short-circuit condition tests:
  - at prospective "r" currents - These currents depend on the rated operational current of the starter (**I<sub>e</sub>** AC-3) and are given by the standard (Table 13). For example:
    - r = 1kA for **I<sub>e</sub>** AC-3 < 16 A
    - r = 3 kA for 16 A < **I<sub>e</sub>** AC-3 < 63 A
    - r = 5 kA for 63 A < **I<sub>e</sub>** AC-3 < 125 A etc.
  - at the rated conditional short-circuit current "**I<sub>q</sub>**" - This is the maximum prospective current that the combination can withstand, for example 50 kA.

## Types of coordination

IEC 60947-4-1 (EN 60947-4-1) defines two types of coordination according to the expected level of service continuity. Acceptable extreme damage for the switchgear is divided into two types.

**Type 1:** In short-circuit conditions, the contactor or starter does not endanger persons or installations and will not be able to then operate without being repaired or having parts replaced.

**Type 2:** In short-circuit conditions, the contactor or starter does not endanger persons or installations and will be able to operate afterwards. The risk of contacts light welding is acceptable. In this case, the manufacturer must stipulate the measures to be taken with respect to maintenance of the equipment.

11

## The complete ABB offer

ABB has acquired years of experience with respect to problems of coordination and is able to make a complete offer based on tests performed in its qualified laboratories. This offer includes 400 V, 500 V, 690 V networks.

**A complete data base of coordination tables**, according to IEC 60947-4-1 (EN 60947-4-1), is available on the ABB Website.

In the coordination tables the following short-circuit protection devices are recommended:

- Moulded case circuit-breakers (MCCBs)
- Miniature circuit-breakers (MCBs)
- Switch-disconnector-fuses (aM, gG and BS)
- Manual Motor Starters (MMS).

## General remarks applicable to all tables

- Each table is defined for a maximum ambient temperature of 40 °C. For higher temperatures, apply a derating factor according to the following rules:
  - Fuses: factor of 0.8 applied to **I<sub>n</sub>** for an ambient temperature of 70 °C
  - MCCBs and MCBs: factor of 0.8 applied to **I<sub>n</sub>** for an ambient temperature of 60 °C
  - The starter derating factor depends on the operating conditions of thermal overload relays:
    - Factor of 0.9 applied to **I<sub>n</sub>** for an ambient temperature of 70 °C.
- Each table is defined for motor currents: 3-phase motors, 4-pole
- **Normal starting** means a starting time < 2 s. - **Difficult starting** means an accelerating time 10 s < **t<sub>s</sub>** < 30 s
- **Tripping classes** of thermal overload relays according to IEC 60947-4-1 (EN 60947-4-1): 10A and 10
- **Tripping classes** of electronic overload relays according to IEC 60947-4-1 (EN 60947-4-1): 10E, 20E, 30E selectable
- In the tables with MCCBs, these are fitted with the magnetic relay alone. Setting is always carried out at > 12.3 **I<sub>e</sub>** AC-3 so that the transient current peak occurring during starting does not lead to tripping.



# Coordination with short-circuit protection devices

A complete data base of coordination tables, according to [IEC 60947-4-1](#) (EN 60947-4-1) or [UL 508 / UL 60947-4-1](#), is available on the ABB Website: see below.

## Selection

Simple or multiple selections all from the same screen.

The screenshot shows the ABB 'Coordination tables for motor protection' selection tool. The interface includes a search bar, a 'Selected Optimized Coordination' section, and a table of results. The table has columns for Protection Device, Rated Voltage [V], Short-Circuit Current [kA], Starter Type, Coordination type, and Motor Rated Power [kW] [HP].

### Short-circuit protection devices

- Air circuit breakers
- Fuses "gG" or "aM"
- Miniature circuit breaker
- Moulded case circuit breaker
- Manual motor starter

### Starter type

- Direct-on-line normal start
- Direct-on-line heavy duty
- Star-delta normal start
- Soft starter normal start

### Coordination

- IEC type 1 or type 2
- UL type A to Type F

## Results

- Search results displayed at the bottom of the selection page.
- Only the most appropriate solutions to your application, will be displayed at the bottom of the page.
- "Enable Smart Current Search" function featured for the short-circuit current where "near to" selected values also are included in the result.
- Possible to print the page to a pdf file or from your printer.
- "Clear selection" function to deselect all selected.

Fuses, 400 V, 80 kA, DOL-N5, Coordination type IEC Type 2							
Motor	Fuses IEC	Contactor	Overload Relay				
Rated Power [kW]	Rated Current [A]	Switch-Fuse Type	Rating [A]	Type and Size	Type	Current setting range [A]	Max allowed load current [A]
0.37	1.1	OS32D	2	OFAM 80kM AS	E18DU2 7 10	1.30 - 2.70	1.4
0.37	1.1	OS32D	2	OFAM 80kM AS	TA2SDU 1.4	1.00 - 1.40	1.4
0.37	1.1	OS32D	3	OFAM 80kM AS	UMC22/100 10	0.24 - 03.00	1.4
0.37	1.1	OS32D	4	OPAA 60H AS	UMC22/100 10	0.24 - 03.00	1.3
0.37	1.1	OS32D	4	OPAA 60H AS	E18DU2 7 10	1.30 - 2.70	1.3
0.37	1.1	OS32D	4	OPAA 60H AS	TA2SDU 1.4	1.00 - 1.40	1.4

Fuses, 400 V, 80 kA, DOL-N5, Coordination type IEC Type 2, Overload Relay TOL							
Motor	Fuses IEC	Contactor	Overload Relay				
Rated Power [kW]	Rated Current [A]	Switch-Fuse Type	Rating [A]	Type and Size	Type	Current setting range [A]	Max allowed load current [A]
0.25	0.85	OS32GD	2	OFAF 50kM AF29	TF42-1.6	0.74 - 1.00	1
0.12	0.44	OS32GD	2	OFAF 50kM AF29	TF42-0.6E	0.42 - 0.55	0.55

## Access

To find the coordination tables for motor protection, please see:

[www.abb.com/lowvoltage](http://www.abb.com/lowvoltage) then go to the right menu: "Support", select: "Online Product Selection Tools" then select "Coordination Tables for motor protection"

# Standards, specifications and certifying organizations

## Definitions

ABB low voltage devices are developed and manufactured in accordance with the applicable regulations as stated in the international IEC standards, the European EN standards and the national ones such as NF, DIN, GB and BS. For devices installed in ships, an approval issued by independent classification societies is demanded by the maritime insurance companies.

## CB scheme

Certification Body certificates (CB certificates) are available to prove the complete conformity to standards

The IEC CB (Certification Body) scheme is multilateral agreement between the National Certification Bodies to allow international certification of electrical and electronic products so that a single certification allows worldwide market access.

The CB Scheme was established by the International Electrotechnical Committee for conformity testing to standards for electrical equipment (IECEE).

## Certified products

In some cases, products are validated and tested according to a standard by a certification body and the manufacturer is regularly visited by this body in order to check the respect of the design and the materials used. This process creates a certified product. This is the case of UL (Underwriters Laboratories) and CSA (Canadian Standard Association) for instance (see below).

## Specifications

### International Specifications

The International Electrotechnical Commission, IEC, which is part of the International Standards Organization, ISO, publishes IEC publications which act as a basis for the world market.

### European Specifications and National Specifications

The European committee for electrotechnical standardization (CENELEC), which groups together European countries, publishes EN standards.

These European standards may differ very little from IEC international standards and have similar numbering.

The same applies for national standards which use, without exception, the same numbering and reproduce the texts of these unified standards in their entirety. Contradicting national standards are withdrawn.

### European Directives

The guarantee of the free movement of goods within the European Community means that any regulatory differences between member states have been eliminated. The European directives set up common rules that are included in the legislation of each state while contradictory regulations are cancelled.

Three directives are essential:

- **Low Voltage Directive** 2006/95/EC concerns electrical equipment from 0 to 1000 V AC and from 0 to 1500 V DC.

This specifies that compliance with the requirements that it sets out is acquired if the equipment conforms to the standards harmonized on an European level. EN 60947-1 and EN 60947-4-1 for contactors.

- **Machinery Directive** 2006/42/EC for safety specifications of machines and equipment on complete machines.
- **Electromagnetic Compatibility Directive** 2004/108/EC which concerns all devices able to create electromagnetic disturbance.

## CE Marking:

CE marking indicates that the marked equipment conforms to the relevant EU directive.

CE marking is part of an administrative procedure and guarantees free movement of the product within the European Community.

## Standards in Canada and the USA

Canadian and American specifications are more or less equivalent but differ greatly from IEC standards.

**UL** Underwriters Laboratories USA

**CSA** Canadian Standard Association Canada

**UL** (USA) specifications make the following distinction between devices:



### Listed Product

A product that has been produced under UL's listing and follow-up service program in accordance with the terms of UL's service agreement and that bears the UL listing mark as the manufacturer's declaration that the product complies with UL's requirements.



### Recognized Component

A part or subassembly covered under UL's recognition service and intended for factory installation in listed (or other) products. Recognized components are incomplete in certain construction features or restricted in performance capabilities and not intended for separate installation in the field, rather they are intended for use as components of incomplete equipment submitted for investigation by UL. Final acceptance of the component in the complete equipment is dependent upon its installation and use in accordance with all applicable use conditions and ratings noted in the component report issued by UL, in the guide information and in the individual client's Recognized Component information page.

The combined UL signs for the USA and Canada are recognized by the authorities of both countries.

**Compulsory China Certification (CCC):** The CCC mark is a compulsory certification mark in the field of safety for products sold on the Chinese market.

**GOST:** Russia (please consult your local ABB sales office)

**C-Tick:** The C-Tick mark certifies compliance with the Australian EMC requirements. The mark is also recognized in New Zealand

**ANCE:** Mexico

## Marine Approvals

The following specifications must be respected when these devices are used on ships:

<b>BV</b>	Bureau Veritas France
<b>DNV</b>	Det Norske Veritas Norway
<b>GL</b>	Germanischer Lloyd Germany
<b>LRS</b>	Lloyd's Register of Shipping Great Britain
<b>ABS</b>	American Bureau of Shipping
<b>RMRS</b>	Russian Maritime Register of Shipping RMRS
<b>RRR</b>	Russian River Register
<b>MRS</b>	Maritime Register of Shipping Russia
<b>PRS</b>	Polski Rejestr Statkow Poland
<b>RINA</b>	Registro Italiano Navale Italy

# Standards, specifications and certifying organizations

## Specifications (cont.)

### International Standards

IEC 60947-1 Low-voltage switchgear and controlgear – Part 1: General rules

IEC 60947-4-1 Low-voltage switchgear and controlgear – Part 4: Contactors and motor starters – Section 1: Electromechanical contactors and motor starters

IEC 60947- 5-1 Low-voltage switchgear and controlgear – Part 5: Control circuit devices and switching elements – Section 1: Electromechanical control circuit devices

IEC 60947-5-4 Low-voltage switchgear and controlgear – Part 5-4: Control circuit devices and switching elements. Method of assessing the performance of low-energy contacts. Special tests

IEC 60947- 6-1 Low-voltage switchgear and controlgear – Part 6: Multiple function equipment – Section 1: Automatic transfer switching equipment

IEC 60204-1 Electrical equipment of industrial machines – Part 1: General requirements

IEC 60715 Dimensions of low-voltage switchgear and controlgear. Standardized mounting on rails for mechanical support of electrical devices in switchgear and controlgear installations

### European Standards

EN 50 005 Low-voltage switchgear and controlgear for industrial use – Terminal marking and distinctive number: General rules (Annex L of IEC 60947-1).

EN 50 011 Low-voltage switchgear and controlgear for industrial use – Terminal marking, distinctive number and distinctive letter for particular contactor relays (Annex M of IEC 60947-5-1)

EN 60947-1 Low-voltage switchgear and controlgear – Part 1: General rules.

EN 60947-4-1 Low-voltage switchgear and controlgear – Part 4: Contactors and motor starters – Section 1: Electromechanical contactors and motor starters.

EN 60947-5-1 Low-voltage switchgear and controlgear – Part 5: Control circuit devices and switching elements – Section 1: Electromechanical control circuit devices.

EN 60947-5-4 Low-voltage switchgear and controlgear – Part 5-4: Control circuit devices and switching elements. Method of assessing the performance of low-energy contacts. Special tests.

EN 60947- 6-1 Low-voltage switchgear and controlgear – Part 6: Multiple function equipment – Section 1: Automatic transfer switching equipment.

EN 60204-1 Electrical equipment of industrial machines – Part 1: General requirements.

EN 60 715 Dimensions of low-voltage switchgear and controlgear. Standardized mounting on rails for mechanical support of electrical devices in switchgear and controlgear installations.

### National Standards

European countries national standards reproduce the corresponding EN... standards. Codification is built by addition of a prefix to EN numbering.

For instance:

- France **NF** EN...
- Germany **DIN** EN...
- Great Britain **BS** EN...
- Italy **CEI** EN...
- Sweden **SS** EN...

# Terms and technical definitions

## Circuits

- auxiliary circuit: All the conductive parts of a contactor designed to be inserted in a different circuit from the main circuit and the contactor control circuits.
- control circuit: All the conductive parts of a contactor (other than the main circuit and the auxiliary circuit) used to control the contactor's closing operation or opening operation or both.
- main circuit: All the conductive parts of a contactor designed to be inserted in the circuit that it controls.

## Thermal overload relay tripping classes

IEC 60947-4-1 defines tripping classes 10 A, 10, 20 and 30. Types 10 A, 10, etc. correspond to the maximum tripping time for a making current at 7.2 times the setting current.

Furthermore, for each class the standard specifies the tripping time for 1.5 times the setting current and sets the non tripping condition at 1.05 times the setting current.

All these data are summarized in the table below.

### Extract from IEC 60947-4-1:

Tripping class	10 A	10	20	30
Max. tripping time for 1.5 times the setting current (warm state)	s 120	240	480	720
Tripping time for 7.2 times the setting current (cold state)	s 2 - 10	4 - 10	6 - 20	9 - 30
For 1.05 times the setting current	No tripping			

## Electromagnetic compatibility

AF... contactors comply with IEC 60947-1, 60947-4-1 and EN 60947-1, 60947-4-1 standards.

Definitions:

Environment A: "Mainly relates to low-voltage non public or industrial networks/locations/installations (EN 50082-2 article 4) including highly disturbing sources".

Environment B: "Mainly relates to low-voltage public networks (EN 50082-1 article 5) such as residential, commercial and light industrial locations/installations. Highly disturbing sources such as arc welders are not covered by this environment".

Notice for AF09 ... AF38, AF116 ... AF2650 contactors and NF contactor relays: these products have been designed for environment A. Use of this product in environment B may cause unwanted electromagnetic disturbances in which case the user may be required to take adequate mitigation measures.

AF40 ... AF96 have been designed for environment B.

## Definitions according to SEMI F47-0706

SEMI F47-0706 defines the voltage sag immunity required for semiconductor processing, metrology and automated test equipment, and on subsystems and components which are used in the construction of semiconductor processing equipment including but not limited to:

- Power supplies
- Generators
- Robots and factory interface
- Chillers, pumps, blowers
- AC operated contactors and contactor relays
- ...

**voltage sag:** an rms reduction in the AC voltage, at the power frequency, for durations from a half cycle to a few seconds.

The IEC terminology for this phenomenon is voltage dip.

**voltage sag immunity:** the ability of equipment to withstand momentary electrical power interruptions or sags

## Coordination of protections against short circuit

The goal here is to protect electromechanical starters and softstarters.

Any starter is designed to:

- start motors,
- ensure continuous functioning of motors,
- disconnect motors from the supply line,
- guarantee protection of motors against overloads.

The starter is typically made up of a switching device (contactor) and an overload protection device (thermal overload relay or electronic overload relay). These two devices MUST be coordinated with equipment capable of providing protection against short circuit (SCPD: short circuit protective device): typically a circuit breaker with magnetic release only or a switch fuse. These are not necessarily part of the starter.

The characteristics of the starter must comply with the international standard IEC 60947-4-1 which defines the above items as follows:

**contactor:** a mechanical switching device having only one position of rest, operated otherwise than by hand, capable of making, carrying and breaking currents under normal circuit conditions including overload conditions.

**overload release:** overload relay or release which operates in the case of overload and also in case of loss of phase.

**circuit-breaker:** defined by IEC 60947-2 as a mechanical switching device, capable of making, carrying and breaking currents under normal circuit conditions and also making, carrying for a specified time and breaking currents under specified abnormal circuit conditions.

IEC publication 60947-4-1 defines coordination types "1" and "2":

- Type "1" coordination requires that, in the event of a short-circuit, the contactor or starter does not endanger persons or installations and will not then be able to operate without being repaired or parts being replaced.
- Type "2" coordination requires that, in short-circuit conditions, the contactor or starter does not endanger persons or installations and will be able to operate afterwards. The risk of contacts being light welded is acceptable. In this case, the manufacturer must stipulate the measures to be taken with respect to maintenance of the equipment.

## Rated operational current $I_e$

Current rated by the manufacturer. It is mainly based on the rated operational voltage  $U_e$ , the rated frequency, the utilization category, the rated duty and the type of protective enclosure, if necessary.

## Conventional free air thermal current $I_{th}$

Current that the contactor can withstand in free air for a duty time of 8 hours without the temperature rise of its various parts exceeding the maximum values given by the standard.

## Operating cycle or cycle

Includes one making operation and one breaking operation.

## Cycle time

This is the sum of the current flow time and the no-current time for given cycle.

## Electrical durability

Number of on-load operating cycles that the contactor is able to carry out. It depends on the operational current, the operational voltage and the utilization category.

# Terms and technical definitions

## Mechanical durability

Number of no-current operating cycles that a contactor is able to carry out.

## Assessed failure rate

Defined according to IEC 60947-5-4. This rate is given in standard industrial environments for the contactor relays and for the built-in auxiliary contact of contactors.

## Load factor

Ratio of the on-load operating time to the total cycle time x 100.

## Switching frequency

Number of switching cycles per hour.

## Plugging

Stopping or fast reversal in rotation direction of a motor by two supply leads being interchanged while the motor is running.

## Inching

Energization of a motor's circuit repeatedly or for short periods with the aim of obtaining small movements of the driven mechanism.

## Coil operating limits

Expressed in multiples of the nominal control circuit voltage  $U_c$  for the upper and lower limits.

## Mounting position

Comply with the manufacturer's instructions. Restrictions are to be taken into account for certain mounting positions.

## Rated breaking or making capacity

Root mean square (r.m.s.) value of the current that the contactor is able to break or make at a given voltage according to the conditions specified by standards and for a given utilization category.

## Intermittent duty

Duty during which the contactor is successively closed or open for periods which are too short to enable the contactor to achieve thermal balance.

## Ambient temperature

Air temperature close to the contactor.

## Time

- Time constant: Ratio of the inductance to the resistance ( $L/R = \text{mH}/\Omega = \text{ms}$ ).
- Short-time withstand current: Current that the contactor is able to withstand in closed position for a short time interval and in specified conditions.
- Closing time: Time interval between the coil energization and the instant the contacts touch on all the poles.
- Opening time: Time interval between the coil de-energization and the instant the contacts separate on all the poles.

## Rated control voltage $U_c$

Control voltage value for which the control circuit is sized.

## Rated operational voltage $U_e$

Voltage to which the contactor's utilization characteristics refer. In three-phase it is the phase-to-phase voltage.

## Rated insulation voltage $U_i$

Reference voltage for dielectric tests and creepage distances.

## Rated impulse withstand voltage $U_{imp}$

Peak value of an impulse voltage, having a specified form and polarity, which does not cause breakdown in specific test conditions.

## Shock withstand

Requirement for vehicles, crane drives, installations on board ships and plug-in equipment. For the acceptable "g" values, the contacts must not change position and the thermal overload relays must not trip.

## Resistance to vibrations

Requirements for vehicles, boats and other means of transport. For the specified vibration amplitude and frequency values the device must remain able to operate.

# Standards and utilization categories

## Utilization categories:

A contactor's duty is characterised by the utilization category together with the rated operational voltage and current indicated.

### Utilization categories for contactors according to IEC 60947-4-1:

<b>Alternating current:</b>	AC-1	Non-inductive or slightly inductive loads, resistance furnaces.
	AC-2	Slip-ring motors: starting, switching off.
	AC-3	Cage motors: starting, switching off running motors.
	AC-4	Cage motors: starting, plugging, inching.
	AC-5a	Discharge lamp switching.
	AC-5b	Incandescent lamp switching.
	AC-6a	Transformer switching.
	AC-6b	Capacitor bank switching.
	AC-8a	Hermetic refrigeration compressor motor control with manual resetting of overload releases.
	AC-8b	Hermetic refrigeration compressor motor control with automatic resetting of overload releases.
<b>Direct current:</b>	DC-1	Non inductive or slightly inductive loads, resistance furnaces.
	DC-3	Shunt motors: starting, plugging, inching, dynamic breaking of DC motors.
	DC-5	Series motors: starting, plugging, inching, dynamic breaking of DC motors.
	DC-6	Incandescent lamp switching.

### Utilization categories for contactor relays according to IEC 60947-5-1:

<b>Alternating current:</b>	AC-12	Control of resistive loads and static loads with opto-coupler isolation.
	AC-13	Control of static loads with transformer isolation.
	AC-14	Control of weak electromagnetic loads ( $\leq 72$ VA).
	AC-15	Control of electromagnetic loads ( $> 72$ VA).
	<b>Direct current:</b>	DC-12
DC-13		Control of DC electromagnets.
DC-14		Control of DC electromagnets having economy resistors.

In fact some applications, and the specific criteria characterizing the various loads controlled by contactors, may modify the utilization characteristics of the contactors. The main applications concerned are:

### Capacitor bank switching

Account must be taken of high peaks when the current is made and of harmonic currents during continuous duty. For this application, IEC publication 60947-4-1 stipulates utilization category AC-6b. The operational currents or powers acceptable for the contactors are determined by our electrical tests; IEC publication 60947-4-1 gives the calculating formula for determining the operational current (Table 9).

11

### Transformer switching

Account must be taken of the peaks due to magnetization phenomena when the current is made.

For this application, IEC publication 60947-4-1 stipulates utilization category AC-6a. The operational currents or powers acceptable for the contactors are determined using the values obtained for AC-3 or AC-4 category tests and the calculating formula given in IEC 60947-4-1 (Table 9).

### Lighting circuit switching

The current peaks occurring on energization of the circuit and the power factor depend on the type of lamps, the connection mode and whether or not there is compensation.

For this application, IEC publication 60947-4-1 stipulates two standard utilization categories:

- AC-5a for discharge lamp switching.
- AC-5b for incandescent lamp switching.

### Slip-ring motor switching

The contactors used for short-circuiting rotor resistors can be used for rotor voltages up to 2 times the rated operational voltage.

The conditions of use of rotor contactors depend on the connection mode of the main poles. IEC 60947-4-1 stipulates AC-2 utilization category for starter contactor.



# Standards and utilization categories

## Utilization categories (cont.)

### DC power circuit switching

Arc suppression is more difficult in direct current than in alternating current. Higher the time constant and voltage, heavier the breaking conditions: consequently several poles have to be connected in series.

### AC high current circuit switching

Possibility of increasing performances by connecting poles in parallel.

### Circuit switching during temporary and intermittent duty

In these cases higher operational currents are acceptable.

### Influence of the length of the conductors used in the contactor control circuit

According to the operational voltages, the cross-sectional areas, the coil consumption and the control layout, difficulties due to line resistances and capacitances may appear during contactor closing and opening orders.

## Making and breaking conditions for utilization categories

Utilization category	Durability test conditions						Occasional operation					
	Making conditions			Breaking conditions			Making and breaking capacities - 50 operating cycles			Making and breaking capacities - 50 operating cycles		
	I/le	U/Ue	Cos. φ or L/R (ms)	I/le	U/Ue	Cos. φ or L/R (ms)	Ic/le	Ur/Ue	Cos. φ or L/R (ms)	Ic/le	Ur/Ue	Cos. φ or L/R (ms)

### Contactors for AC circuit switching

AC-1		1	1	0.95	1	1	0.95	1.5	1.05	0.8	1.5	1.05	0.8
AC-2		2.5	1	0.65	2.5	1	0.65	4	1.05	0.65	4	1.05	0.65
AC-3	le < 17 A	6	1	0.65	1	0.17	0.65	10	1.05	0.45	8	1.05	0.45
	17 < le < 100 A	6	1	0.35	1	0.17	0.35	10	1.05	0.45	8	1.05	0.45
	le > 100 A	6	1	0.35	1	0.17	0.35	10	1.05	0.35	8	1.05	0.35
AC-4	le < 17 A	6	1	0.65	6	1	0.65	12	1.05	0.45	10	1.05	0.45
	17 < le < 100 A	6	1	0.35	6	1	0.35	12	1.05	0.45	10	1.05	0.45
	le > 100 A	6	1	0.35	6	1	0.35	12	1.05	0.35	10	1.05	0.35

### Contactors for DC circuit switching

DC-1		1	1	1	1	1	1	1.5	1.05	1	1.5	1.05	1
DC-3		2.5	1	2	2.5	1	2	4	1.05	2.5	4	1.05	2.5
DC-5		2.5	1	7.5	2.5	1	7.5	4	1.05	15	4	1.05	15

### Contactors for AC circuit switching

AC-14	(≤ 72 VA)	–	–	–	–	–	–	6	1.1	0.7	6	1.1	0.7
AC-15	(> 72 VA)	10	1	0.7	1	1	0.4	10	1.1	0.3	10	1.1	0.3

### Contactors for AC circuit switching

Utilization category	Standard operation						Occasional operation						
	Making conditions			Breaking conditions			Making and breaking capacities - 50 operating cycles			Making and breaking capacities - 50 operating cycles			
	I/le	U/Ue	T <sub>0.95</sub>	I/le	U/Ue	T <sub>0.95</sub>	Ic/le	Ur/Ue	T <sub>0.95</sub>	Ic/le	Ur/Ue	T <sub>0.95</sub>	
DC-13		1	1	6 P(1)	1	1	6 P(1)	1.1	1.1	6 P(1)	1.1	1.1	6 P(1)
DC-14		–	–	–	–	–	–	10	1.1	15 ms	10	1.1	15 ms

(1) The value "6 x P" is the result of an empirical relation which is estimated to represent most DC magnetic loads up to the highest limit of P = 50 W (6 x P = 300 ms). It is accepted that loads having drawn energy above 50 W are made up of weaker loads in parallel. As a consequence, the 300 ms value must form the highest limit whatever the value of the power drawn.

### Key:

**U (I)** = applied voltage (current)

**Ur** = recovery voltage

**L/R** = test circuit time constant

**Ue (Ie)** = rated operational voltage (current)

**Ic** = making and breaking current expressed in DC or in AC like the r.m.s. value of the symmetrical components

**T<sub>0.95</sub>** = time required to reach 95% of the current in steady-state conditions, expressed in milliseconds

# Degrees of protection

## General

In an installation, the degree of protection required for electrical equipment depends on the environmental characteristics. The degree of protection, ensured by the enclosure of equipment or by the cubicle containing the equipment is expressed by the IP code which gives the level of protection against access to hazardous parts, the ingress of foreign bodies and/or the ingress of water, in compliance with IEC 60529, IEC 60947-1.

Besides the IP symbol, the complete code has two figures followed (optionally) by two additional letters. A short description of the elements used in IP coding is given below.

IP... code	Figures or letters	Specifications for installation protection	Protection of persons
<b>First figure</b>		<b>Against ingress of foreign bodies</b>	<b>Against access to hazardous parts with:</b>
	0	No protection	No protection
	1	Diameter > 50 mm	Back of hand
	2	Diameter > 12.5 mm	Finger
	3	Diameter > 2.5 mm	Tool
	4	Diameter > 1 mm	Wire
	5	Limited protection against dust	Wire
	6	Total protection against dust	Wire
<b>Second figure</b>		<b>Against entrance of water having a harmful effect</b>	
	0	No protection	
	1	Vertical dripping	
	2	Dripping at a vertical angle of < 15°	
	3	Rain at a vertical angle of < 60°	
	4	Splashing	
	5	Low pressure water jet	
	6	Powerful water jets	
	7	Temporary immersion	
	8	Permanent immersion	
<b>Additional letter (optional) for use with:</b>		<b>Against ingress of foreign bodies</b>	<b>Against access to hazardous parts with:</b>
First figure 0	A	Stopped by a barrier with a 50 mm Ø sphere	Back of hand
First figure 0 or 1	B	Entrance of test finger limited to 80 mm	Finger
First figure 1 or 2	C	Wire with 2.5 mm Ø and length of 100 mm	Tool
First figure 2 or 3	D	Wire with 1 mm Ø and length of 100 mm	Wire
<b>Additional letter (optional)</b>		<b>Specific additional information</b>	
	H	High voltage apparatus	-
	M	Moving parts which are moving during water test	
	S	Moving parts which are stationary during water test	
	W	Specified atmospheric conditions	

Note: The type of enclosure or cubicle in which the equipment must be installed prevails with respect to the degree of protection.



# Climatic withstand of devices

The life time of devices are mainly influenced by series of climatic factors which cause their corrosion.

In practice, besides climatic conditions, there are other factors which may damage equipment such as fungi, insects (termites), dust, work site dirt and aggressive environment (salty or sulphurous atmosphere, etc.) which can often only be identified at the place of installation.

Climatic stress, definitions and test conditions are dealt with in national publications such as the DIN 50 series and UTE 63-100 publication which are attached to international publications such as IEC 60068.

## The test conditions are:

Description	Symbolization	Time of one cycle	Cycle phase time	Temperature in test chamber	Relative humidity
Humidity and variable temperature	IEC 60068-2-30 Test Db	24 hours	12 hours including rise in temperature	40 °C	95 %
			12 hours including cooling (open device)	25 °C	95 %

ABB contactors have been used for many years in the most countries, with hot and humid climates for example: Brazil, Indonesia, India or on ships. Experience has shown that ABB devices can be used in most countries throughout the world.

The climate of the country in which the apparatus is installed is not the determining choice factor.

## Account must be taken of:

- the immediate environment of the devices (sheltered, ventilated, temperature),
- the aggressivity of the immediate atmosphere at the place of installation,
- the length and frequency of non operating periods.

In the case of frequent condensation (i.e. the formation of condensation caused by rapid changes in temperature), heating resistors must be installed in cubicles (100 to 250 W per m<sup>3</sup> of enclosure).

## The table below gives the cases where heating is necessary.

Environment		Operating conditions	Climate	Internal heating of enclosure
Inside premises	No running water no condensation	Continuous or not	All climates	Without
	With running water	Continuous	All climates	Without
		Frequent or long stops	Temperate Tropical	Without With
Outside, sheltered	No running water no condensation	Continuous or not	Temperate	Without
			Tropical	With
Outside or by the seaside	With running water	Continuous Frequent or long stops	All climates	Without
			Temperate Tropical	Without With

The entrance of dust, insects, dirt, etc. in devices may be prevented if the appropriate degree of protection according to IEC 60529 is chosen (See "Degree of protection" table).

# Index

## Order code classification

Order code	Type	Page
1SAM101923R0002	MSMN	2/14
1SAM101923R0012	MSMNO	2/14
1SAM101924R0003	MSOX-32	2/14
1SAM101924R0013	MSOX-30	2/14
1SAM201901R1001	HKF1-11	2/9
1SAM201901R1002	HKF1-20	2/9
1SAM201902R1001	HK1-11	2/9
1SAM201902R1002	HK1-20	2/9
1SAM201902R1003	HK1-02	2/9
1SAM201902R1004	HK1-20L	2/9
1SAM201903R1001	SK1-11	2/9
1SAM201903R1002	SK1-20	2/9
1SAM201903R1003	SK1-02	2/9
1SAM201904R1001	UA1-24	2/9
1SAM201904R1002	UA1-48	2/9
1SAM201904R1003	UA1-60	2/9
1SAM201904R1004	UA1-110	2/9
1SAM201904R1005	UA1-230	2/9
1SAM201904R1006	UA1-400	2/9
1SAM201904R1007	UA1-415	2/9
1SAM201904R1008	UA1-208	2/9
1SAM201906R1102	PS1-2.0-65	2/8
1SAM201906R1103	PS1-3.0-65	2/8
1SAM201906R1104	PS1-4.0-65	2/8
1SAM201906R1105	PS1-5.0-65	2/8
1SAM201906R1112	PS1-2.1-65	2/8
1SAM201906R1113	PS1-3.1-65	2/8
1SAM201906R1114	PS1-4.1-65	2/8
1SAM201906R1115	PS1-5.1-65	2/8
1SAM201906R1122	PS1-2.2-65	2/8
1SAM201906R1123	PS1-3.2-65	2/8
1SAM201906R1124	PS1-4.2-65	2/8
1SAM201906R1125	PS1-5.2-65	2/8
1SAM201907R1101	S1-M1-25	2/8
1SAM201907R1102	S1-M2-25	2/8
1SAM201907R1103	S1-M3-25	2/8
1SAM201908R1001	BS1-3	2/8
1SAM201909R1001	FS116	2/8
1SAM201910R1001	AA1-24	2/9
1SAM201910R1002	AA1-110	2/9
1SAM201910R1003	AA1-230	2/9
1SAM201910R1004	AA1-400	2/9
1SAM201911R1010	IB132-G	2/13
1SAM201911R1011	IB132-Y	2/13
1SAM201912R1010	DMS132-G	2/13
1SAM201912R1011	DMS132-Y	2/13
1SAM201913R1103	S1-M3-35	2/8
1SAM201916R1103	PS1-3.0-100	2/8
1SAM201916R1104	PS1-4.0-100	2/8
1SAM201916R1105	PS1-5.0-100	2/8
1SAM201916R1113	PS1-3.1-100	2/8
1SAM201916R1114	PS1-4.1-100	2/8
1SAM201916R1115	PS1-5.1-100	2/8
1SAM201916R1123	PS1-3.2-100	2/8
1SAM201920R1000	MSH-AR	2/14
1SAM201920R1001	MSHD-LB	2/14
1SAM201920R1002	MSHD-LY	2/14
1SAM201920R1011	MSHD-LTB	2/25
1SAM201920R1012	MSHD-LTY	2/25
1SAM250000R1001	MS116-0.16	2/4
1SAM250000R1002	MS116-0.25	2/4
1SAM250000R1003	MS116-0.4	2/4
1SAM250000R1004	MS116-0.63	2/4
1SAM250000R1005	MS116-1.0	2/4
1SAM250000R1006	MS116-1.6	2/4
1SAM250000R1007	MS116-2.5	2/4
1SAM250000R1008	MS116-4.0	2/4
1SAM250000R1009	MS116-6.3	2/4
1SAM250000R1010	MS116-10	2/4
1SAM250000R1011	MS116-16	2/4
1SAM250000R1012	MS116-12	2/4
1SAM250000R1013	MS116-20	2/4
1SAM250000R1014	MS116-25	2/4
1SAM250000R1015	MS116-32	2/4
1SAM250005R1001	MS116-0.16-HKF1-11	2/4
1SAM250005R1002	MS116-0.25-HKF1-11	2/4
1SAM250005R1003	MS116-0.4-HKF1-11	2/4
1SAM250005R1004	MS116-0.63-HKF1-11	2/4
1SAM250005R1005	MS116-1.0-HKF1-11	2/4
1SAM250005R1006	MS116-1.6-HKF1-11	2/4
1SAM250005R1007	MS116-2.5-HKF1-11	2/4
1SAM250005R1008	MS116-4.0-HKF1-11	2/4
1SAM250005R1009	MS116-6.3-HKF1-11	2/4
1SAM250005R1010	MS116-10.0-HKF1-11	2/4
1SAM250005R1011	MS116-16.0-HKF1-11	2/4
1SAM250005R1012	MS116-12.0-HKF1-11	2/4
1SAM250005R1013	MS116-20-HKF1-11	2/4
1SAM250005R1014	MS116-25-HKF1-11	2/4
1SAM250005R1015	MS116-32-HKF1-11	2/4
1SAM301901R1001	CK1-11	2/20
1SAM301901R1002	CK1-20	2/20
1SAM301901R1003	CK1-02	2/20
1SAM350000R1001	MS132-0.16	2/15
1SAM350000R1002	MS132-0.25	2/15
1SAM350000R1003	MS132-0.4	2/15
1SAM350000R1004	MS132-0.63	2/15
1SAM350000R1005	MS132-1.0	2/15
1SAM350000R1006	MS132-1.6	2/15
1SAM350000R1007	MS132-2.5	2/15
1SAM350000R1008	MS132-4.0	2/15

Order code	Type	Page
1SAM350000R1009	MS132-6.3	2/15
1SAM350000R1010	MS132-10	2/15
1SAM350000R1011	MS132-16	2/15
1SAM350000R1012	MS132-12	2/15
1SAM350000R1013	MS132-20	2/15
1SAM350000R1014	MS132-25	2/15
1SAM350000R1015	MS132-32	2/15
1SAM350005R1001	MS132-0.16-HKF1-11	2/15
1SAM350005R1002	MS132-0.25-HKF1-11	2/15
1SAM350005R1003	MS132-0.4-HKF1-11	2/15
1SAM350005R1004	MS132-0.63-HKF1-11	2/15
1SAM350005R1005	MS132-1.0-HKF1-11	2/15
1SAM350005R1006	MS132-1.6-HKF1-11	2/15
1SAM350005R1007	MS132-2.5-HKF1-11	2/15
1SAM350005R1008	MS132-4.0-HKF1-11	2/15
1SAM350005R1009	MS132-6.3-HKF1-11	2/15
1SAM350005R1010	MS132-10.0-HKF1-11	2/15
1SAM350005R1011	MS132-16.0-HKF1-11	2/15
1SAM350005R1012	MS132-12.0-HKF1-11	2/15
1SAM350005R1013	MS132-20-HKF1-11	2/15
1SAM350005R1014	MS132-25-HKF1-11	2/15
1SAM350005R1015	MS132-32-HKF1-11	2/15
1SAM360000R1001	MO132-0.16	2/26
1SAM360000R1002	MO132-0.25	2/26
1SAM360000R1003	MO132-0.4	2/26
1SAM360000R1004	MO132-0.63	2/26
1SAM360000R1005	MO132-1.0	2/26
1SAM360000R1006	MO132-1.6	2/26
1SAM360000R1007	MO132-2.5	2/26
1SAM360000R1008	MO132-4.0	2/26
1SAM360000R1009	MO132-6.3	2/26
1SAM360000R1010	MO132-10	2/26
1SAM360000R1011	MO132-16	2/26
1SAM360000R1012	MO132-12	2/26
1SAM360000R1013	MO132-20	2/26
1SAM360000R1014	MO132-25	2/26
1SAM360000R1015	MO132-32	2/26
1SAM401901R1001	HK4-11	2/43
1SAM401901R1002	HK4-W	2/43
1SAM401902R1001	HKS4-11	2/43
1SAM401902R1002	HKS4-20	2/43
1SAM401902R1003	HKS4-02	2/43
1SAM401904R1001	SK4-11	2/43
1SAM401905R1001	UA4-110	2/43
1SAM401905R1002	UA4-230	2/43
1SAM401905R1003	UA4-400	2/43
1SAM401905R1004	UA4-24	2/43
1SAM401906R1001	UA4-HK-230	2/43
1SAM401906R1002	UA4-HK-400	2/43
1SAM401907R1001	AA4-24	2/43
1SAM401907R1002	AA4-110	2/43
1SAM401907R1003	AA4-230	2/43
1SAM401907R1004	AA4-400	2/43
1SAM401908R1001	KA450	2/42
1SAM401910R1001	TB450	2/42
1SAM401911R1001	PS4-2.0	2/42
1SAM401911R1002	PS4-3.0	2/42
1SAM401911R1003	PS4-4.0	2/42
1SAM401911R1004	PS4-2.2	2/42
1SAM401911R1005	PS4-3.2	2/42
1SAM401911R1006	PS4-4.2	2/42
1SAM401911R1007	S4-M1	2/42
1SAM401911R1008	BS4-3	2/42
1SAM401912R1001	DX495	2/42
1SAM450000R1005	MS450-40	2/38
1SAM450000R1006	MS450-45	2/38
1SAM450000R1007	MS450-50	2/38
1SAM460000R1005	MO450-40	2/47
1SAM460000R1006	MO450-45	2/47
1SAM460000R1007	MO450-50	2/47
1SAM501901R1001	KA495	2/42
1SAM501902R1001	KA495C	2/42
1SAM550000R1007	MS495-63	2/38
1SAM550000R1008	MS495-75	2/38
1SAM550000R1009	MS495-90	2/38
1SAM550000R1010	MS495-100	2/38
1SAM560000R1007	MO495-63	2/47
1SAM560000R1008	MO495-75	2/47
1SAM560000R1009	MO495-90	2/47
1SAM560000R1010	MO495-100	2/47
1SAM580000R1004	MS497-32	2/38
1SAM580000R1005	MS497-40	2/38
1SAM580000R1006	MS497-50	2/38
1SAM580000R1007	MS497-63	2/38
1SAM580000R1008	MS497-75	2/38
1SAM580000R1009	MS497-90	2/38
1SAM580000R1010	MS497-100	2/38
1SAM590000R1004	MO496-32	2/47
1SAM590000R1005	MO496-40	2/47
1SAM590000R1006	MO496-50	2/47
1SAM590000R1007	MO496-63	2/47
1SAM590000R1008	MO496-75	2/47
1SAM590000R1009	MO496-90	2/47
1SAM590000R1010	MO496-100	2/47
1SAX1110110R0001	DB16E	7/32
1SAX111001R1101	E16DU-0.32	7/28
1SAX111001R1102	E16DU-1.0	7/28
1SAX111001R1103	E16DU-2.7	7/28
1SAX111001R1104	E16DU-6.3	7/28
1SAX111001R1105	E16DU-18.9	7/28

Order code	Type	Page
1SAX121001R1101	EF19-0.32	7/33
1SAX121001R1102	EF19-1.0	7/33
1SAX121001R1103	EF19-2.7	7/33
1SAX121001R1104	EF19-6.3	7/33
1SAX121001R1105	EF19-18.9	7/33
1SAX221001R1101	EF45-30	7/33
1SAX221001R1102	EF45-45	7/33
1SAX331001R1101	EF65-70	7/37
1SAX341001R1101	EF96-100	7/37
1SAX351001R1101	EF146-150	7/37
1SAX531001R1101	EF205-210	7/41
1SAX601904R0001	LT800E	7/45
1SAX611001R1101	EF370-380	7/41
1SAX701904R0001	LT500E	7/45
1SAX711001R1101	E500DU-500	7/45
1SAX811001R1101	E800DU-800	7/45
1SAZ401110R0001	DB20U	7/24
1SAZ401901R001	LT200A	7/24
1SAZ421201R1001	TA200DU-90	7/24
1SAZ421201R1002	TA200DU-110	7/24
1SAZ421201R1003	TA200DU-135	7/24
1SAZ421201R1004	TA200DU-150	7/24
1SAZ421201R1005	TA200DU-175	7/24
1SAZ421201R1006	TA200DU-200	7/24
1SAZ431201R1001	TF140DU-90	7/20
1SAZ431201R1002	TF140DU-110	7/20
1SAZ431201R1003	TF140DU-135	7/20
1SAZ431201R1004	TF140DU-142	7/20
1SAZ701901R0001	DB16	7/4
1SAZ701902R0001	DB42	7/8
1SAZ711201R1005	T16-0.13	7/4
1SAZ711201R1008	T16-0.17	7/4
1SAZ711201R1009	T16-0.23	7/4
1SAZ711201R1013	T16-0.31	7/4
1SAZ711201R1014	T16-0.41	7/4
1SAZ711201R1017	T16-0.55	7/4
1SAZ711201R1021	T16-0.74	7/4
1SAZ711201R1023	T16-1.0	7/4
1SAZ711201R1025	T16-1.3	7/4
1SAZ711201R1028	T16-1.7	7/4
1SAZ711201R1031	T16-2.3	7/4
1SAZ711201R1033	T16-3.1	7/4
1SAZ711201R1035	T16-4.2	7/4
1SAZ711201R1038	T16-5.7	7/4
1SAZ711201R1040	T16-7.6	7/4
1SAZ711201R1043	T16-10	7/4
1SAZ711201R1045	T16-13	7/4
1SAZ711201R1047	T16-16	7/4
1SAZ721201R1005	TF42-0.13	7/8
1SAZ721201R1008	TF42-0.17	7/8
1SAZ721201R1009	TF42-0.23	7/8
1SAZ721201R1013	TF42-0.31	7/8
1SAZ721201R1014	TF42-0.41	7/8
1SAZ721201R1017	TF42-0.55	7/8
1SAZ721201R1021	TF42-0.74	7/8
1SAZ721201R1023	TF42-1.0	7/8
1SAZ721201R1025	TF42-1.3	7/8
1SAZ721201R1028	TF42-1.7	7/8
1SAZ721201R1031	TF42-2.3	7/8
1SAZ721201R1033	TF42-3.1	7/8
1SAZ721201R1035	TF42-4.2	7/8
1SAZ721201R1038	TF42-5.7	7/8
1SAZ721201R1040	TF42-7.6	7/8
1SAZ721201R1043	TF42-10	7/8
1SAZ721201R1045	TF42-13	7/8
1SAZ721201R1047	TF42-16	7/8
1SAZ721201R1049	TF42-20	7/8
1SAZ721201R1051	TF42-24	7/8
1SAZ721201R1052	TF42-29	7/8
1SAZ721201R1053	TF42-35	7/8
1SAZ721201R1055	TF42-38	7/8
1SAZ811201R1001	TF	

# Index

## Order code classification

Order code	Type	Page	Order code	Type	Page	Order code	Type	Page
1SBH101001R2622	NS22E-26	4/60	1SBH103004R8653	NLS53ES-86	6/21	1SBH137001R4122	NF22E-41	5/180
1SBH101001R2631	NS31E-26	4/60	1SBH103004R8662	NLS62ES-86	6/21	1SBH137001R4131	NF31E-41	5/180
1SBH101001R2640	NS40E-26	4/60	1SBH103004R8671	NLS71ES-86	6/21	1SBH137001R4140	NF40E-41	5/180
1SBH101001R2644	NS44E-26	4/60	1SBH103004R8680	NLS80ES-86	6/21	1SBH137001R4144	NF44E-41	5/184
1SBH101001R2653	NS53E-26	4/60	1SBH103004R8822	NLS22ES-88	6/21	1SBH137001R4153	NF53E-41	5/184
1SBH101001R2662	NS62E-26	4/60	1SBH103004R8831	NLS31ES-88	6/21	1SBH137001R4162	NF62E-41	5/184
1SBH101001R2671	NS71E-26	4/60	1SBH103004R8840	NLS40ES-88	6/21	1SBH137001R4171	NF71E-41	5/184
1SBH101001R2680	NS80E-26	4/60	1SBH103004R8844	NLS44ES-88	6/21	1SBH137001R4180	NF80E-41	5/184
1SBH101001R2822	NS22E-28	4/60	1SBH103004R8853	NLS53ES-88	6/21	1SBH137004R1222	NF22ES-12	6/60
1SBH101001R2831	NS31E-28	4/60	1SBH103004R8862	NLS62ES-88	6/21	1SBH137004R1231	NF31ES-12	6/60
1SBH101001R2840	NS40E-28	4/60	1SBH103004R8871	NLS71ES-88	6/21	1SBH137004R1240	NF40ES-12	6/60
1SBH101001R2844	NS44E-28	4/60	1SBH103004R8880	NLS80ES-88	6/21	1SBH137004R1244	NF44ES-12	6/62
1SBH101001R2853	NS53E-28	4/60	1SBH136001R2022	NFZ22E-20	5/181	1SBH137004R1253	NF53ES-12	6/62
1SBH101001R2862	NS62E-28	4/60	1SBH136001R2031	NFZ31E-20	5/181	1SBH137004R1262	NF62ES-12	6/62
1SBH101001R2871	NS71E-28	4/60	1SBH136001R2040	NFZ40E-20	5/181	1SBH137004R1271	NF71ES-12	6/62
1SBH101001R2880	NS80E-28	4/60	1SBH136001R2044	NFZ44E-20	5/185	1SBH137004R1280	NF80ES-12	6/62
1SBH101004R1622	NS22ES-16	6/20	1SBH136001R2053	NFZ53E-20	5/185	1SBH137004R1322	NF22ES-13	6/60
1SBH101004R1631	NS31ES-16	6/20	1SBH136001R2062	NFZ62E-20	5/185	1SBH137004R1331	NF31ES-13	6/60
1SBH101004R1640	NS40ES-16	6/20	1SBH136001R2071	NFZ71E-20	5/185	1SBH137004R1340	NF40ES-13	6/60
1SBH101004R1644	NS44ES-16	6/20	1SBH136001R2080	NFZ80E-20	5/185	1SBH137004R1344	NF44ES-13	6/62
1SBH101004R1653	NS53ES-16	6/20	1SBH136001R2122	NFZ22E-21	5/181	1SBH137004R1353	NF53ES-13	6/62
1SBH101004R1662	NS62ES-16	6/20	1SBH136001R2131	NFZ31E-21	5/181	1SBH137004R1362	NF62ES-13	6/62
1SBH101004R1671	NS71ES-16	6/20	1SBH136001R2140	NFZ40E-21	5/181	1SBH137004R1371	NF71ES-13	6/62
1SBH101004R1680	NS80ES-16	6/20	1SBH136001R2144	NFZ44E-21	5/185	1SBH137004R1380	NF80ES-13	6/62
1SBH101004R2022	NS22ES-20	6/20	1SBH136001R2153	NFZ53E-21	5/185	1SBH137004R1422	NF22ES-14	6/60
1SBH101004R2031	NS31ES-20	6/20	1SBH136001R2162	NFZ62E-21	5/185	1SBH137004R1431	NF31ES-14	6/60
1SBH101004R2040	NS40ES-20	6/20	1SBH136001R2171	NFZ71E-21	5/185	1SBH137004R1440	NF40ES-14	6/60
1SBH101004R2044	NS44ES-20	6/20	1SBH136001R2180	NFZ80E-21	5/185	1SBH137004R1444	NF44ES-14	6/62
1SBH101004R2053	NS53ES-20	6/20	1SBH136001R2222	NFZ22E-22	5/181	1SBH137004R1453	NF53ES-14	6/62
1SBH101004R2062	NS62ES-20	6/20	1SBH136001R2231	NFZ31E-22	5/181	1SBH137004R1462	NF62ES-14	6/62
1SBH101004R2071	NS71ES-20	6/20	1SBH136001R2240	NFZ40E-22	5/181	1SBH137004R1471	NF71ES-14	6/62
1SBH101004R2080	NS80ES-20	6/20	1SBH136001R2244	NFZ44E-22	5/185	1SBH137004R1480	NF80ES-14	6/62
1SBH101004R2622	NS22ES-26	6/20	1SBH136001R2253	NFZ53E-22	5/185	1SBH137004R1422	NF22ES-14	6/60
1SBH101004R2631	NS31ES-26	6/20	1SBH136001R2262	NFZ62E-22	5/185	1SBH137004R1431	NF31ES-14	6/60
1SBH101004R2640	NS40ES-26	6/20	1SBH136001R2271	NFZ71E-22	5/185	1SBH137004R1440	NF40ES-14	6/60
1SBH101004R2644	NS44ES-26	6/20	1SBH136001R2280	NFZ80E-22	5/185	1SBH137004R1444	NF44ES-14	6/62
1SBH101004R2653	NS53ES-26	6/20	1SBH136001R2322	NFZ22E-23	5/181	1SBH137004R1453	NF53ES-14	6/62
1SBH101004R2662	NS62ES-26	6/20	1SBH136001R2331	NFZ31E-23	5/181	1SBH137004R1462	NF62ES-14	6/62
1SBH101004R2671	NS71ES-26	6/20	1SBH136001R2340	NFZ40E-23	5/181	1SBH137004R1471	NF71ES-14	6/62
1SBH101004R2680	NS80ES-26	6/20	1SBH136001R2344	NFZ44E-23	5/185	1SBH137004R1480	NF80ES-14	6/62
1SBH101004R2822	NS22ES-28	6/20	1SBH136001R2353	NFZ53E-23	5/185	1SBK103600M1600	VAS09EM-16M	4/44
1SBH101004R2831	NS31ES-28	6/20	1SBH136001R2362	NFZ62E-23	5/185	1SBK103600M2000	VAS09EM-20M	4/44
1SBH101004R2840	NS40ES-28	6/20	1SBH136001R2371	NFZ71E-23	5/185	1SBK103600M2600	VAS09EM-26M	4/44
1SBH101004R2844	NS44ES-28	6/20	1SBH136001R2380	NFZ80E-23	5/185	1SBK103600M2800	VAS09EM-28M	4/44
1SBH101004R2853	NS53ES-28	6/20	1SBH136004R2022	NFZ22ES-20	6/61	1SBK103700M8100	VASL09EM-81M	4/45
1SBH101004R2862	NS62ES-28	6/20	1SBH136004R2031	NFZ31ES-20	6/61	1SBK103700M8300	VASL09EM-83M	4/45
1SBH101004R2871	NS71ES-28	6/20	1SBH136004R2040	NFZ40ES-20	6/61	1SBK103700M8600	VASL09EM-86M	4/45
1SBH101004R2880	NS80ES-28	6/20	1SBH136004R2044	NFZ44ES-20	6/63	1SBK103700M8800	VASL09EM-88M	4/45
1SBH103001R8122	NLS22E-81	4/61	1SBH136004R2053	NFZ53ES-20	6/63	1SBK103800M1600	VAS09SEM-16M	4/44
1SBH103001R8131	NLS31E-81	4/61	1SBH136004R2062	NFZ62ES-20	6/63	1SBK103800M2000	VAS09SEM-20M	4/44
1SBH103001R8140	NLS40E-81	4/61	1SBH136004R2071	NFZ71ES-20	6/63	1SBK103800M2600	VAS09SEM-26M	4/44
1SBH103001R8144	NLS44E-81	4/61	1SBH136004R2080	NFZ80ES-20	6/63	1SBK103800M2800	VAS09SEM-28M	4/44
1SBH103001R8153	NLS53E-81	4/61	1SBH136004R2122	NFZ22ES-21	6/61	1SBK103900M8100	VASL09SEM-81M	4/45
1SBH103001R8162	NLS62E-81	4/61	1SBH136004R2131	NFZ31ES-21	6/61	1SBK103900M8300	VASL09SEM-83M	4/45
1SBH103001R8171	NLS71E-81	4/61	1SBH136004R2140	NFZ40ES-21	6/61	1SBK103900M8600	VASL09SEM-86M	4/45
1SBH103001R8180	NLS80E-81	4/61	1SBH136004R2144	NFZ44ES-21	6/63	1SBK103900M8800	VASL09SEM-88M	4/45
1SBH103001R8322	NLS22E-83	4/61	1SBH136004R2153	NFZ53ES-21	6/63	1SBK113600M1600	VAS12EM-16M	4/44
1SBH103001R8331	NLS31E-83	4/61	1SBH136004R2162	NFZ62ES-21	6/63	1SBK113600M2000	VAS12EM-20M	4/44
1SBH103001R8340	NLS40E-83	4/61	1SBH136004R2171	NFZ71ES-21	6/63	1SBK113600M2600	VAS12EM-26M	4/44
1SBH103001R8344	NLS44E-83	4/61	1SBH136004R2180	NFZ80ES-21	6/63	1SBK113600M2800	VAS12EM-28M	4/44
1SBH103001R8353	NLS53E-83	4/61	1SBH136004R2222	NFZ22ES-22	6/61	1SBK113700M8100	VASL12EM-81M	4/45
1SBH103001R8362	NLS62E-83	4/61	1SBH136004R2231	NFZ31ES-22	6/61	1SBK113700M8300	VASL12EM-83M	4/45
1SBH103001R8371	NLS71E-83	4/61	1SBH136004R2240	NFZ40ES-22	6/61	1SBK113700M8600	VASL12EM-86M	4/45
1SBH103001R8380	NLS80E-83	4/61	1SBH136004R2244	NFZ44ES-22	6/63	1SBK113700M8800	VASL12EM-88M	4/45
1SBH103001R8622	NLS22E-86	4/61	1SBH136004R2253	NFZ53ES-22	6/63	1SBK113800M1600	VAS12SEM-16M	4/44
1SBH103001R8631	NLS31E-86	4/61	1SBH136004R2262	NFZ62ES-22	6/63	1SBK113800M2000	VAS12SEM-20M	4/44
1SBH103001R8640	NLS40E-86	4/61	1SBH136004R2271	NFZ71ES-22	6/63	1SBK113800M2600	VAS12SEM-26M	4/44
1SBH103001R8644	NLS44E-86	4/61	1SBH136004R2280	NFZ80ES-22	6/63	1SBK113800M2800	VAS12SEM-28M	4/44
1SBH103001R8653	NLS53E-86	4/61	1SBH136004R2322	NFZ22ES-23	6/61	1SBK113900M8100	VASL12SEM-81M	4/45
1SBH103001R8662	NLS62E-86	4/61	1SBH136004R2331	NFZ31ES-23	6/61	1SBK113900M8300	VASL12SEM-83M	4/45
1SBH103001R8671	NLS71E-86	4/61	1SBH136004R2340	NFZ40ES-23	6/61	1SBK113900M8600	VASL12SEM-86M	4/45
1SBH103001R8680	NLS80E-86	4/61	1SBH136004R2344	NFZ44ES-23	6/63	1SBK113900M8800	VASL12SEM-88M	4/45
1SBH103001R8822	NLS22E-88	4/61	1SBH136004R2353	NFZ53ES-23	6/63	1SBK123600M1600	VAS16EM-16M	4/44
1SBH103001R8831	NLS31E-88	4/61	1SBH136004R2362	NFZ62ES-23	6/63	1SBK123600M2000	VAS16EM-20M	4/44
1SBH103001R8840	NLS40E-88	4/61	1SBH136004R2371	NFZ71ES-23	6/63	1SBK123600M2600	VAS16EM-26M	4/44
1SBH103001R8844	NLS44E-88	4/61	1SBH136004R2380	NFZ80ES-23	6/63	1SBK123600M2800	VAS16EM-28M	4/44
1SBH103001R8853	NLS53E-88	4/61	1SBH137001R1222	NF22E-12	5/180	1SBK123700M8100	VASL16EM-81M	4/45
1SBH103001R8862	NLS62E-88	4/61	1SBH137001R1231	NF31E-12	5/180	1SBK123700M8300	VASL16EM-83M	4/45
1SBH103001R8871	NLS71E-88	4/61	1SBH137001R1240	NF40E-12	5/180	1SBK123700M8600	VASL16EM-86M	4/45
1SBH103001R8880	NLS80E-88	4/61	1SBH137001R1244	NF44E-12	5/184	1SBK123700M8800	VASL16EM-88M	4/45
1SBH103004R8122	NLS22ES-81	6/21	1SBH137001R1253	NF53E-12	5/184	1SBK123800M1600	VAS16SEM-16M	4/44
1SBH103004R8131	NLS31ES-81	6/21	1SBH137001R1262	NF62E-12	5/184	1SBK123800M2000	VAS16SEM-20M	4/44
1SBH103004R8140	NLS40ES-81	6/21	1SBH137001R1271	NF71E-12	5/184	1SBK123800M2600	VAS16SEM-26M	4/44
1SBH103004R8144	NLS44ES-81	6/21	1SBH137001R1280	NF80E-12	5/184	1SBK123800M2800	VAS16SEM-28M	4/44
1SBH103004R8153	NLS53ES-81	6/21	1SBH137001R1322	NF22E-13	5/180	1SBK123900M8100	VASL16SEM-81M	4/45
1SBH103004R8162	NLS62ES-81	6/21	1SBH137001R1331	NF31E-13	5/180	1SBK123900M8300	VASL16SEM-83M	4/45
1SBH103004R8171	NLS71ES-81	6/21	1SBH137001R1340	NF40E-13	5/180	1SBK123900M8600	VASL16SEM-86M	4/45
1SBH103004R8180	NLS80ES-81	6/21	1SBH137001R1344	NF44E-13	5/184	1SBK123900M8800	VASL16SEM-88M	4/45
1SBH103004R8322	NLS22ES-83	6/21	1SBH137001R1353	NF53E-13	5/184	1SBL101001R1601	AS09-30-01-16	4/32
1SBH103004R8331	NLS31ES-83	6/21	1SBH137001R1362	NF62E-13	5/184	1SBL101001R1610	AS09-30-01-16	4/32
1SBH103004R8340	NLS40ES-83	6/21	1SBH137001R1371	NF71E-13	5/184	1SBL101001R1632	AS09-30-32-16	4/34
1SBH103004R8344	NLS44ES-83	6/21	1SBH137001R1380	NF80E-13	5/184	1SBL101001R2001	AS09-30-01-20	4/32
1SBH103004R8353	NLS53ES-83	6/21	1SBH137001R1422	NF22E-14	5/180	1SBL101001R2010	AS09-30-10-20	4/32
1SBH103004R8362	NLS62ES-83	6/21	1SBH137001R1431	NF31E-14	5/180	1SBL101001R2032	AS09-30-32-20	4/34
1SBH103004R8371	NLS71ES-83	6/21	1SBH137001R1440	NF40E-14	5/180	1SBL101001R2601	AS09-30-01-26	4/32
1SBH103004R8380	NLS80ES-83	6/21	1SBH137001R1444	NF44E-14	5/184	1SBL101001R2610	AS09-30-10	



# Index

## Order code classification

Order code	Type	Page	Order code	Type	Page	Order code	Type	Page
1SBL101004R1601	AS09-30-01S-16	6/4	1SBL121004R2010	AS16-30-10S-20	6/4	1SBL156001R2110	AF12Z-30-10-21	5/7
1SBL101004R1610	AS09-30-10S-16	6/4	1SBL121004R2032	AS16-30-32S-20	6/6	1SBL156001R2122	AF12Z-30-22-21	5/25
1SBL101004R1632	AS09-30-32S-16	6/6	1SBL121004R2601	AS16-30-01S-26	6/4	1SBL156001R2201	AF12Z-30-01-22	5/7
1SBL101004R2001	AS09-30-01S-20	6/4	1SBL121004R2610	AS16-30-10S-26	6/4	1SBL156001R2210	AF12Z-30-10-22	5/7
1SBL101004R2010	AS09-30-10S-20	6/4	1SBL121004R2632	AS16-30-32S-26	6/6	1SBL156001R2222	AF12Z-30-22-22	5/25
1SBL101004R2032	AS09-30-32S-20	6/6	1SBL121004R2801	AS16-30-01S-28	6/4	1SBL156001R2301	AF12Z-30-01-23	5/7
1SBL101004R2601	AS09-30-01S-26	6/4	1SBL121004R2810	AS16-30-10S-28	6/4	1SBL156001R2310	AF12Z-30-10-23	5/7
1SBL101004R2610	AS09-30-10S-26	6/4	1SBL121004R2832	AS16-30-32S-28	6/6	1SBL156001R2322	AF12Z-30-22-23	5/25
1SBL101004R2632	AS09-30-32S-26	6/6	1SBL123001R8101	ASL16-30-01-81	4/33	1SBL156004R2001	AF12Z-30-01S-20	6/43
1SBL101004R2801	AS09-30-01S-28	6/4	1SBL123001R8110	ASL16-30-10-81	4/33	1SBL156004R2010	AF12Z-30-10S-20	6/43
1SBL101004R2810	AS09-30-10S-28	6/4	1SBL123001R8132	ASL16-30-32-81	4/35	1SBL156004R2022	AF12Z-30-22S-20	6/45
1SBL101004R2832	AS09-30-32S-28	6/6	1SBL123001R8301	ASL16-30-01-83	4/33	1SBL156004R2101	AF12Z-30-01S-21	6/43
1SBL103001R8101	ASL09-30-01-81	4/33	1SBL123001R8310	ASL16-30-10-83	4/33	1SBL156004R2110	AF12Z-30-10S-21	6/43
1SBL103001R8110	ASL09-30-10-81	4/33	1SBL123001R8332	ASL16-30-32-83	4/35	1SBL156004R2122	AF12Z-30-22S-21	6/45
1SBL103001R8132	ASL09-30-32-81	4/35	1SBL123001R8601	ASL16-30-01-86	4/33	1SBL156004R2201	AF12Z-30-01S-22	6/43
1SBL103001R8301	ASL09-30-01-83	4/33	1SBL123001R8610	ASL16-30-10-86	4/33	1SBL156004R2210	AF12Z-30-10S-22	6/43
1SBL103001R8310	ASL09-30-10-83	4/33	1SBL123001R8632	ASL16-30-32-86	4/35	1SBL156004R2222	AF12Z-30-22S-22	6/45
1SBL103001R8332	ASL09-30-32-83	4/35	1SBL123001R8801	ASL16-30-01-88	4/33	1SBL156004R2301	AF12Z-30-01S-23	6/43
1SBL103001R8601	ASL09-30-01-86	4/33	1SBL123001R8810	ASL16-30-10-88	4/33	1SBL156004R2310	AF12Z-30-10S-23	6/43
1SBL103001R8610	ASL09-30-10-86	4/33	1SBL123001R8832	ASL16-30-32-88	4/35	1SBL156004R2322	AF12Z-30-22S-23	6/45
1SBL103001R8632	ASL09-30-32-86	4/35	1SBL123004R8101	ASL16-30-01S-81	6/5	1SBL157001R1201	AF12-30-01-12	5/6
1SBL103001R8801	ASL09-30-01-88	4/33	1SBL123004R8110	ASL16-30-10S-81	6/5	1SBL157001R1210	AF12-30-10-12	5/6
1SBL103001R8810	ASL09-30-10-88	4/33	1SBL123004R8132	ASL16-30-32S-81	6/7	1SBL157001R1222	AF12-30-22-12	5/24
1SBL103001R8832	ASL09-30-32-88	4/35	1SBL123004R8301	ASL16-30-01S-83	6/5	1SBL157001R1301	AF12-30-01-13	5/6
1SBL103004R8101	ASL09-30-01S-81	6/5	1SBL123004R8310	ASL16-30-10S-83	6/5	1SBL157001R1310	AF12-30-10-13	5/6
1SBL103004R8110	ASL09-30-10S-81	6/5	1SBL123004R8332	ASL16-30-32S-83	6/7	1SBL157001R1322	AF12-30-22-13	5/24
1SBL103004R8132	ASL09-30-32S-81	6/7	1SBL123004R8601	ASL16-30-01S-86	6/5	1SBL157001R1401	AF12-30-01-14	5/6
1SBL103004R8301	ASL09-30-01S-83	6/5	1SBL123004R8610	ASL16-30-10S-86	6/5	1SBL157001R1410	AF12-30-10-14	5/6
1SBL103004R8310	ASL09-30-10S-83	6/5	1SBL123004R8632	ASL16-30-32S-86	6/7	1SBL157001R1422	AF12-30-22-14	5/24
1SBL103004R8332	ASL09-30-32S-83	6/7	1SBL123004R8801	ASL16-30-01S-88	6/5	1SBL157001R4101	AF12-30-01-41	5/6
1SBL103004R8601	ASL09-30-01S-86	6/5	1SBL123004R8810	ASL16-30-10S-88	6/5	1SBL157001R4110	AF12-30-10-41	5/6
1SBL103004R8610	ASL09-30-10S-86	6/5	1SBL123004R8832	ASL16-30-32S-88	6/7	1SBL157001R4122	AF12-30-22-41	5/24
1SBL103004R8632	ASL09-30-32S-86	6/7	1SBL136001R2001	AF09Z-30-01-20	5/7	1SBL157004R1201	AF12-30-01S-12	6/42
1SBL103004R8801	ASL09-30-01S-88	6/5	1SBL136001R2010	AF09Z-30-10-20	5/7	1SBL157004R1210	AF12-30-10S-12	6/42
1SBL103004R8810	ASL09-30-10S-88	6/5	1SBL136001R2022	AF09Z-30-22-20	5/25	1SBL157004R1222	AF12-30-22S-12	6/44
1SBL103004R8832	ASL09-30-32S-88	6/7	1SBL136001R2101	AF09Z-30-01-21	5/7	1SBL157004R1301	AF12-30-01S-13	6/42
1SBL111001R1601	AS12-30-01-16	4/32	1SBL136001R2110	AF09Z-30-10-21	5/7	1SBL157004R1310	AF12-30-10S-13	6/42
1SBL111001R1610	AS12-30-10-16	4/32	1SBL136001R2122	AF09Z-30-22-21	5/25	1SBL157004R1322	AF12-30-22S-13	6/44
1SBL111001R1632	AS12-30-32-16	4/34	1SBL136001R2201	AF09Z-30-01-22	5/7	1SBL157004R1401	AF12-30-01S-14	6/42
1SBL111001R2001	AS12-30-01-20	4/32	1SBL136001R2210	AF09Z-30-10-22	5/7	1SBL157004R1410	AF12-30-10S-14	6/42
1SBL111001R2010	AS12-30-10-20	4/32	1SBL136001R2222	AF09Z-30-22-22	5/25	1SBL157004R1422	AF12-30-22S-14	6/44
1SBL111001R2032	AS12-30-32-20	4/34	1SBL136001R2301	AF09Z-30-01-23	5/7	1SBL157004R4101	AF12-30-01S-41	6/42
1SBL111001R2601	AS12-30-01-26	4/32	1SBL136001R2310	AF09Z-30-10-23	5/7	1SBL157004R4110	AF12-30-10S-41	6/42
1SBL111001R2610	AS12-30-10-26	4/32	1SBL136001R2322	AF09Z-30-22-23	5/25	1SBL157004R4122	AF12-30-22S-41	6/44
1SBL111001R2632	AS12-30-32-26	4/34	1SBL136004R2001	AF09Z-30-01S-20	6/43	1SBL176001R2001	AF16Z-30-01-20	5/7
1SBL111001R2632	AS12-30-32-26	4/34	1SBL136004R2010	AF09Z-30-10S-20	6/43	1SBL176001R2010	AF16Z-30-10S-20	6/43
1SBL111001R2801	AS12-30-01-28	4/32	1SBL136004R2022	AF09Z-30-22S-20	6/45	1SBL176001R2022	AF16Z-30-22S-20	6/45
1SBL111001R2810	AS12-30-10-28	4/32	1SBL136004R2101	AF09Z-30-01S-21	6/43	1SBL176001R2101	AF16Z-30-01-21	5/7
1SBL111001R2822	AS12-30-32-28	4/34	1SBL136004R2110	AF09Z-30-10S-21	6/43	1SBL176001R2122	AF16Z-30-22-21	5/25
1SBL111001R2832	AS12-30-32S-28	6/6	1SBL136004R2122	AF09Z-30-22S-21	6/45	1SBL176001R2201	AF16Z-30-01-22	5/7
1SBL111004R1601	AS12-30-01S-16	6/4	1SBL136004R2201	AF09Z-30-10S-22	6/43	1SBL176001R2210	AF16Z-30-10-22	5/7
1SBL111004R1610	AS12-30-10S-16	6/4	1SBL136004R2210	AF09Z-30-22S-22	6/45	1SBL176001R2222	AF16Z-30-22-22	5/25
1SBL111004R1632	AS12-30-32S-16	6/6	1SBL136004R2301	AF09Z-30-01S-23	6/43	1SBL176001R2301	AF16Z-30-01-23	5/7
1SBL111004R2001	AS12-30-01S-20	6/4	1SBL136004R2310	AF09Z-30-10S-23	6/43	1SBL176001R2310	AF16Z-30-10-23	5/7
1SBL111004R2010	AS12-30-10S-20	6/4	1SBL136004R2322	AF09Z-30-22S-23	6/45	1SBL176001R2322	AF16Z-30-22-23	5/25
1SBL111004R2032	AS12-30-32S-20	6/6	1SBL136201R2000	AF09Z-40-00-20	5/95	1SBL176004R2001	AF16Z-30-01S-20	6/43
1SBL111004R2601	AS12-30-01S-26	6/4	1SBL136201R2100	AF09Z-40-00-21	5/95	1SBL176004R2010	AF16Z-30-10S-20	6/43
1SBL111004R2610	AS12-30-10S-26	6/4	1SBL136201R2200	AF09Z-40-00-22	5/95	1SBL176004R2022	AF16Z-30-22S-20	6/45
1SBL111004R2632	AS12-30-32S-26	6/6	1SBL136201R2300	AF09Z-40-00-23	5/95	1SBL176004R2101	AF16Z-30-01S-21	6/43
1SBL111004R2801	AS12-30-01S-28	6/4	1SBL136501R2000	AF09Z-22-00-20	5/95	1SBL176004R2110	AF16Z-30-10S-21	6/43
1SBL111004R2810	AS12-30-10S-28	6/4	1SBL136501R2100	AF09Z-22-00-21	5/95	1SBL176004R2122	AF16Z-30-22S-21	6/45
1SBL111004R2832	AS12-30-32S-28	6/6	1SBL136501R2200	AF09Z-22-00-22	5/95	1SBL176004R2201	AF16Z-30-01-22	5/7
1SBL113001R8101	ASL12-30-01-81	4/33	1SBL136501R2300	AF09Z-22-00-23	5/95	1SBL176004R2210	AF16Z-30-10S-22	6/43
1SBL113001R8110	ASL12-30-10-81	4/33	1SBL137001R1201	AF09-30-01-12	5/6	1SBL176004R2222	AF16Z-30-22S-22	6/45
1SBL113001R8132	ASL12-30-32-81	4/35	1SBL137001R1210	AF09-30-10-12	5/6	1SBL176004R2301	AF16Z-30-01S-23	6/43
1SBL113001R8301	ASL12-30-01-83	4/33	1SBL137001R1222	AF09-30-22-12	5/24	1SBL176004R2310	AF16Z-30-10S-23	6/43
1SBL113001R8310	ASL12-30-10-83	4/33	1SBL137001R1301	AF09-30-01-13	5/6	1SBL176004R2322	AF16Z-30-22S-23	6/45
1SBL113001R8332	ASL12-30-32-83	4/35	1SBL137001R1310	AF09-30-10-13	5/6	1SBL176201R2000	AF16Z-40-00-20	5/95
1SBL113001R8601	ASL12-30-01-86	4/33	1SBL137001R1322	AF09-30-22-13	5/24	1SBL176201R2100	AF16Z-40-00-21	5/95
1SBL113001R8610	ASL12-30-10-86	4/33	1SBL137001R1401	AF09-30-01-14	5/6	1SBL176201R2200	AF16Z-40-00-22	5/95
1SBL113001R8632	ASL12-30-32-86	4/35	1SBL137001R1410	AF09-30-10-14	5/6	1SBL176201R2300	AF16Z-40-00-23	5/95
1SBL113004R8101	ASL12-30-01S-81	6/5	1SBL137001R1422	AF09-30-22-14	5/24	1SBL176501R2000	AF16Z-22-00-20	5/95
1SBL113004R8110	ASL12-30-10S-81	6/5	1SBL137001R4101	AF09-30-01-41	5/6	1SBL176501R2100	AF16Z-22-00-21	5/95
1SBL113004R8132	ASL12-30-32S-81	6/7	1SBL137001R4110	AF09-30-10-41	5/6	1SBL176501R2200	AF16Z-22-00-22	5/95
1SBL113004R8301	ASL12-30-01S-83	6/5	1SBL137001R4122	AF09-30-22-41	6/44	1SBL176501R2300	AF16Z-22-00-23	5/95
1SBL113004R8310	ASL12-30-10S-83	6/5	1SBL137004R1201	AF09-30-01S-12	6/42	1SBL177001R1201	AF16-30-01-12	5/6
1SBL113004R8332	ASL12-30-32S-83	6/7	1SBL137004R1210	AF09-30-10S-12	6/42	1SBL177001R1210	AF16-30-10-12	5/6
1SBL113004R8601	ASL12-30-01S-86	6/5	1SBL137004R1222	AF09-30-22S-12	6/44	1SBL177001R1222	AF16-30-22-12	5/24
1SBL113004R8610	ASL12-30-10S-86	6/5	1SBL137004R1301	AF09-30-01S-13	6/42	1SBL177001R1301	AF16-30-01-13	5/6
1SBL113004R8632	ASL12-30-32S-86	6/7	1SBL137004R1310	AF09-30-10S-13	6/42	1SBL177001R1310	AF16-30-10-13	5/6
1SBL113004R8801	ASL12-30-01S-88	6/5	1SBL137004R1322	AF09-30-22S-13	6/44	1SBL177001R1322	AF16-30-22-13	5/24
1SBL113004R8810	ASL12-30-10S-88	6/5	1SBL137004R1401	AF09-30-01S-14	6/42	1SBL177001R1401	AF16-30-01-14	5/6
1SBL113004R8832	ASL12-30-32S-88	6/7	1SBL137004R1410	AF09-30-10S-14	6/42	1SBL177001R1410	AF16-30-10-14	5/6
1SBL121001R1601	AS16-30-01-16	4/32	1SBL137004R1422	AF09-30-22S-14	6/44	1SBL177001R1422	AF16-30-22-14	5/24
1SBL121001R1610	AS16-30-10-16	4/32	1SBL137004R4101	AF09-30-01S-41	6/42	1SBL177001R4101	AF16-30-01-41	5/6
1SBL121001R1632	AS16-30-32-16	4/34	1SBL137004R4110	AF09-30-10S-41	6/42	1SBL177001R4110	AF16-30-1	

# Index

## Order code classification

Order code	Type	Page
1SBL177201R1200	AF16-40-00-12	5/94
1SBL177201R1300	AF16-40-00-13	5/94
1SBL177201R1400	AF16-40-00-14	5/94
1SBL177201R4100	AF16-40-00-41	5/94
1SBL177501R1200	AF16-22-00-12	5/94
1SBL177501R1300	AF16-22-00-13	5/94
1SBL177501R1400	AF16-22-00-14	5/94
1SBL177501R4100	AF16-22-00-41	5/94
1SBL181022R8010	UA16-30-10	5/167
1SBL181022R8110	UA16-30-10	5/167
1SBL181022R8310	UA16-30-10	5/167
1SBL181022R8410	UA16-30-10	5/167
1SBL181022R8510	UA16-30-10	5/167
1SBL181022R8610	UA16-30-10	5/167
1SBL181022R8810	UA16-30-10	5/167
1SBL181024R8010	UA16-30-10RA	5/158
1SBL181024R8110	UA16-30-10RA	5/158
1SBL181024R8310	UA16-30-10RA	5/158
1SBL181024R8410	UA16-30-10RA	5/158
1SBL181024R8510	UA16-30-10RA	5/158
1SBL181024R8610	UA16-30-10RA	5/158
1SBL181024R8810	UA16-30-10RA	5/158
1SBL236001R2000	AF26Z-30-00-20	5/7
1SBL236001R2011	AF26Z-30-11-20	5/25
1SBL236001R2022	AF26Z-30-22-20	5/25
1SBL236001R2100	AF26Z-30-00-21	5/7
1SBL236001R2111	AF26Z-30-11-21	5/25
1SBL236001R2122	AF26Z-30-22-21	5/25
1SBL236001R2200	AF26Z-30-00-22	5/7
1SBL236001R2211	AF26Z-30-11-22	5/25
1SBL236001R2222	AF26Z-30-22-22	5/25
1SBL236001R2300	AF26Z-30-00-23	5/7
1SBL236001R2311	AF26Z-30-11-23	5/25
1SBL236001R2322	AF26Z-30-22-23	5/25
1SBL236004R2000	AF26Z-30-00S-20	6/43
1SBL236004R2011	AF26Z-30-11S-20	6/45
1SBL236004R2022	AF26Z-30-22S-20	6/45
1SBL236004R2100	AF26Z-30-00S-21	6/43
1SBL236004R2111	AF26Z-30-11S-21	6/45
1SBL236004R2122	AF26Z-30-22S-21	6/45
1SBL236004R2200	AF26Z-30-00S-22	6/43
1SBL236004R2211	AF26Z-30-11S-22	6/45
1SBL236004R2222	AF26Z-30-22S-22	6/45
1SBL236004R2300	AF26Z-30-00S-23	6/43
1SBL236004R2311	AF26Z-30-11S-23	6/45
1SBL236004R2322	AF26Z-30-22S-23	6/45
1SBL236201R2000	AF26Z-40-00-20	5/95
1SBL236201R2100	AF26Z-40-00-21	5/95
1SBL236201R2200	AF26Z-40-00-22	5/95
1SBL236201R2300	AF26Z-40-00-23	5/95
1SBL236501R2000	AF26Z-22-00-20	5/95
1SBL236501R2100	AF26Z-22-00-21	5/95
1SBL236501R2200	AF26Z-22-00-22	5/95
1SBL236501R2300	AF26Z-22-00-23	5/95
1SBL237001R1200	AF26-30-00-12	5/6
1SBL237001R1211	AF26-30-11-12	5/24
1SBL237001R1222	AF26-30-22-12	5/24
1SBL237001R1300	AF26-30-00-13	5/6
1SBL237001R1311	AF26-30-11-13	5/24
1SBL237001R1322	AF26-30-22-13	5/24
1SBL237001R1400	AF26-30-00-14	5/6
1SBL237001R1411	AF26-30-11-14	5/24
1SBL237001R1422	AF26-30-22-14	5/24
1SBL237001R4100	AF26-30-00-41	5/6
1SBL237001R4111	AF26-30-11-41	5/24
1SBL237001R4122	AF26-30-22-41	5/24
1SBL237004R1200	AF26-30-00S-12	6/42
1SBL237004R1211	AF26-30-11S-12	6/44
1SBL237004R1222	AF26-30-22S-12	6/44
1SBL237004R1300	AF26-30-00S-13	6/42
1SBL237004R1311	AF26-30-11S-13	6/44
1SBL237004R1322	AF26-30-22S-13	6/44
1SBL237004R1400	AF26-30-00S-14	6/42
1SBL237004R1411	AF26-30-11S-14	6/44
1SBL237004R1422	AF26-30-22S-14	6/44
1SBL237004R4100	AF26-30-00S-41	6/42
1SBL237004R4111	AF26-30-11S-41	6/44
1SBL237004R4122	AF26-30-22S-41	6/44
1SBL237201R1200	AF26-40-00-12	5/94
1SBL237201R1300	AF26-40-00-13	5/94
1SBL237201R1400	AF26-40-00-14	5/94
1SBL237201R4100	AF26-40-00-41	5/94
1SBL237501R1200	AF26-22-00-12	5/94
1SBL237501R1300	AF26-22-00-13	5/94
1SBL237501R1400	AF26-22-00-14	5/94
1SBL237501R4100	AF26-22-00-41	5/94
1SBL241022R8010	UA26-30-10	5/167
1SBL241022R8310	UA26-30-10	5/167
1SBL241022R8410	UA26-30-10	5/167
1SBL241022R8510	UA26-30-10	5/167
1SBL241022R8610	UA26-30-10	5/167
1SBL241022R8810	UA26-30-10	5/167
1SBL241024R8010	UA26-30-10RA	5/158
1SBL241024R8110	UA26-30-10RA	5/158
1SBL241024R8310	UA26-30-10RA	5/158
1SBL241024R8410	UA26-30-10RA	5/158
1SBL241024R8510	UA26-30-10RA	5/158
1SBL241024R8610	UA26-30-10RA	5/158
1SBL241024R8810	UA26-30-10RA	5/158

Order code	Type	Page
1SBL276001R2000	AF30Z-30-00-20	5/7
1SBL276001R2011	AF30Z-30-11-20	5/25
1SBL276001R2022	AF30Z-30-22-20	5/25
1SBL276001R2100	AF30Z-30-00-21	5/7
1SBL276001R2111	AF30Z-30-11-21	5/25
1SBL276001R2122	AF30Z-30-22-21	5/25
1SBL276001R2200	AF30Z-30-00-22	5/7
1SBL276001R2211	AF30Z-30-11-22	5/25
1SBL276001R2222	AF30Z-30-22-22	5/25
1SBL276001R2300	AF30Z-30-00-23	5/7
1SBL276001R2311	AF30Z-30-11-23	5/25
1SBL276001R2322	AF30Z-30-22-23	5/25
1SBL277001R1200	AF30-30-00-12	5/6
1SBL277001R1211	AF30-30-11-12	5/24
1SBL277001R1222	AF30-30-22-12	5/24
1SBL277001R1300	AF30-30-00-13	5/6
1SBL277001R1311	AF30-30-11-13	5/24
1SBL277001R1322	AF30-30-22-13	5/24
1SBL277001R1400	AF30-30-00-14	5/6
1SBL277001R1411	AF30-30-11-14	5/24
1SBL277001R1422	AF30-30-22-14	5/24
1SBL277001R4100	AF30-30-00-41	5/6
1SBL277001R4111	AF30-30-11-41	5/24
1SBL277001R4122	AF30-30-22-41	5/24
1SBL281022R8010	UA30-30-10	5/167
1SBL281022R8110	UA30-30-10	5/167
1SBL281022R8310	UA30-30-10	5/167
1SBL281022R8410	UA30-30-10	5/167
1SBL281022R8510	UA30-30-10	5/167
1SBL281022R8610	UA30-30-10	5/167
1SBL281022R8810	UA30-30-10	5/167
1SBL281024R8010	UA30-30-10RA	5/158
1SBL281024R8110	UA30-30-10RA	5/158
1SBL281024R8310	UA30-30-10RA	5/158
1SBL281024R8410	UA30-30-10RA	5/158
1SBL281024R8510	UA30-30-10RA	5/158
1SBL281024R8610	UA30-30-10RA	5/158
1SBL281024R8810	UA30-30-10RA	5/158
1SBL296001R2000	AF38Z-30-00-20	5/7
1SBL296001R2011	AF38Z-30-11-20	5/25
1SBL296001R2022	AF38Z-30-22-20	5/25
1SBL296001R2100	AF38Z-30-00-21	5/7
1SBL296001R2111	AF38Z-30-11-21	5/25
1SBL296001R2122	AF38Z-30-22-21	5/25
1SBL296001R2200	AF38Z-30-00-22	5/7
1SBL296001R2211	AF38Z-30-11-22	5/25
1SBL296001R2222	AF38Z-30-22-22	5/25
1SBL296001R2300	AF38Z-30-00-23	5/7
1SBL296001R2311	AF38Z-30-11-23	5/25
1SBL296001R2322	AF38Z-30-22-23	5/25
1SBL296201R2000	AF38Z-40-00-20	5/95
1SBL296201R2100	AF38Z-40-00-21	5/95
1SBL296201R2200	AF38Z-40-00-22	5/95
1SBL296201R2300	AF38Z-40-00-23	5/95
1SBL296501R2000	AF38Z-22-00-20	5/95
1SBL296501R2100	AF38Z-22-00-21	5/95
1SBL296501R2200	AF38Z-22-00-22	5/95
1SBL296501R2300	AF38Z-22-00-23	5/95
1SBL297001R1200	AF38-30-00-12	5/6
1SBL297001R1211	AF38-30-11-12	5/24
1SBL297001R1222	AF38-30-22-12	5/24
1SBL297001R1300	AF38-30-00-13	5/6
1SBL297001R1311	AF38-30-11-13	5/24
1SBL297001R1322	AF38-30-22-13	5/24
1SBL297001R1400	AF38-30-00-14	5/6
1SBL297001R1411	AF38-30-11-14	5/24
1SBL297001R1422	AF38-30-22-14	5/24
1SBL297001R4100	AF38-30-00-41	5/6
1SBL297001R4111	AF38-30-11-41	5/24
1SBL297001R4122	AF38-30-22-41	5/24
1SBL297201R1200	AF38-40-00-12	5/94
1SBL297201R1300	AF38-40-00-13	5/94
1SBL297201R1400	AF38-40-00-14	5/94
1SBL297201R4100	AF38-40-00-41	5/94
1SBL297501R1200	AF38-22-00-12	5/94
1SBL297501R1300	AF38-22-00-13	5/94
1SBL297501R1400	AF38-22-00-14	5/94
1SBL331201R8000	A45-40-00	5/99
1SBL331201R8100	A45-40-00	5/99
1SBL331201R8300	A45-40-00	5/99
1SBL331201R8400	A45-40-00	5/99
1SBL331201R8500	A45-40-00	5/99
1SBL331201R8600	A45-40-00	5/99
1SBL331201R8800	A45-40-00	5/99
1SBL331501R8000	A45-22-00	5/99
1SBL331501R8100	A45-22-00	5/99
1SBL331501R8300	A45-22-00	5/99
1SBL331501R8400	A45-22-00	5/99
1SBL331501R8500	A45-22-00	5/99
1SBL331501R8600	A45-22-00	5/99
1SBL331501R8800	A45-22-00	5/99
1SBL337201R6900	AF45-40-00	5/101
1SBL337201R7000	AF45-40-00	5/101
1SBL337201R7200	AF45-40-00	5/101
1SBL337501R6900	AF45-22-00	5/101
1SBL337501R7000	AF45-22-00	5/101
1SBL337501R7200	AF45-22-00	5/101
1SBL339201R8000	AE45-40-00	5/100
1SBL339201R8100	AE45-40-00	5/100

Order code	Type	Page
1SBL339201R8300	AE45-40-00	5/100
1SBL339201R8400	AE45-40-00	5/100
1SBL339201R8600	AE45-40-00	5/100
1SBL339201R8700	AE45-40-00	5/100
1SBL339201R8800	AE45-40-00	5/100
1SBL339201R8900	AE45-40-00	5/100
1SBL339261R5100	TAE45-40-00	5/104
1SBL339261R5200	TAE45-40-00	5/104
1SBL339261R5400	TAE45-40-00	5/104
1SBL339261R5600	TAE45-40-00	5/104
1SBL339261R5800	TAE45-40-00	5/104
1SBL339261R6200	TAE45-40-00	5/104
1SBL339261R6600	TAE45-40-00	5/104
1SBL339261R6800	TAE45-40-00	5/104
1SBL339501R8000	AE45-22-00	5/100
1SBL339501R8100	AE45-22-00	5/100
1SBL339501R8300	AE45-22-00	5/100
1SBL339501R8400	AE45-22-00	5/100
1SBL339501R8600	AE45-22-00	5/100
1SBL339501R8700	AE45-22-00	5/100
1SBL339501R8800	AE45-22-00	5/100
1SBL339501R8900	AE45-22-00	5/100
1SBL347001R1100	AF40-30-00-11	5/8
1SBL347001R1111	AF40-30-11-11	5/26
1SBL347001R1122	AF40-30-22-11	5/26
1SBL347001R1200	AF40-30-00-12	5/8
1SBL347001R1211	AF40-30-11-12	5/26
1SBL347001R1222	AF40-30-22-12	5/26
1SBL347001R1300	AF40-30-00-13	5/8
1SBL347001R1311	AF40-30-11-13	5/26
1SBL347001R1322	AF40-30-22-13	5/26
1SBL347001R1400	AF40-30-00-14	5/8
1SBL347001R1411	AF40-30-11-14	5/26
1SBL347001R1422	AF40-30-22-14	5/26
1SBL347001R4100	AF40-30-00-41	5/8
1SBL347001R4111	AF40-30-11-41	5/26
1SBL347001R4122	AF40-30-22-41	5/26
1SBL351022R8000	UA50-30-00	5/168
1SBL351022R8011	UA50-30-11	5/169
1SBL351022R8100	UA50-30-00	5/168
1SBL351022R8111	UA50-30-11	5/169
1SBL351022R8300	UA50-30-00	5/168
1SBL351022R8311	UA50-30-11	5/169
1SBL351022R8500	UA50-30-00	5/168
1SBL351022R8511	UA50-30-11	5/169
1SBL351022R8600	UA50-30-00	5/168
1SBL351022R8611	UA50-30-11	5/169
1SBL351022R8800	UA50-30-00	5/168
1SBL351022R8811	UA50-30-11	5/169
1SBL351024R8000	UA50-30-00RA	5/159
1SBL351024R8100	UA50-30-00RA	5/159
1SBL351024R8300	UA50-30-00RA	5/159
1SBL351024R8400	UA	



# Index

## Order code classification

Order code	Type	Page	Order code	Type	Page	Order code	Type	Page
1SBL371022R8011	UA63-30-11	5/169	1SBL417201R6900	AF75-40-00	5/101	1SBN011019T1001	CA3-01S	6/9
1SBL371022R8100	UA63-30-00	5/168	1SBL417201R7000	AF75-40-00	5/101	1SBN011019T1010	CA3-10S	6/9
1SBL371022R8111	UA63-30-11	5/169	1SBL417201R7200	AF75-40-00	5/101	1SBN020112R1000	TEF4-ON	5/11
1SBL371022R8300	UA63-30-00	5/168	1SBL417501R6900	AF75-22-00	5/101	1SBN020113R1000	TEF4S-ON	6/47
1SBL371022R8311	UA63-30-11	5/169	1SBL417501R7000	AF75-22-00	5/101	1SBN020114R1000	TEF4-OFF	5/11
1SBL371022R8400	UA63-30-00	5/168	1SBL417501R7200	AF75-22-00	5/101	1SBN020115R1000	TEF4S-OFF	6/47
1SBL371022R8411	UA63-30-11	5/169	1SBL419201R8000	AE75-40-00	5/100	1SBN020312R1000	TEF5-ON	5/103
1SBL371022R8500	UA63-30-00	5/168	1SBL419201R8100	AE75-40-00	5/100	1SBN020314R1000	TEF5-OFF	5/103
1SBL371022R8511	UA63-30-11	5/169	1SBL419201R8300	AE75-40-00	5/100	1SBN021012R1000	TEF3-ON	4/37
1SBL371022R8600	UA63-30-00	5/168	1SBL419201R8400	AE75-40-00	5/100	1SBN021014R1000	TEF3-OFF	4/37
1SBL371022R8611	UA63-30-11	5/169	1SBL419201R8600	AE75-40-00	5/100	1SBN030105T1000	VM4	5/11
1SBL371022R8800	UA63-30-00	5/168	1SBL419201R8700	AE75-40-00	5/100	1SBN030111R1000	VM4	5/11
1SBL371022R8811	UA63-30-11	5/169	1SBL419201R8800	AE75-40-00	5/100	1SBN030210R1000	VE5-2	5/103
1SBL371024R8000	UA63-30-00RA	5/159	1SBL419201R8900	AE75-40-00	5/100	1SBN031005T1000	VM3	4/37
1SBL371024R8100	UA63-30-00RA	5/159	1SBL419261R5100	TAE75-40-00	5/104	1SBN033405T1000	VM96-4	5/11
1SBL371024R8300	UA63-30-00RA	5/159	1SBL419261R5200	TAE75-40-00	5/104	1SBN050010R1000	RV5/50	4/37
1SBL371024R8400	UA63-30-00RA	5/159	1SBL419261R5400	TAE75-40-00	5/104	1SBN050010R1001	RV5/133	4/37
1SBL371024R8500	UA63-30-00RA	5/159	1SBL419261R5500	TAE75-40-00	5/104	1SBN050010R1002	RV5/250	4/37
1SBL371024R8600	UA63-30-00RA	5/159	1SBL419261R5800	TAE75-40-00	5/104	1SBN050010R1003	RV5/440	4/37
1SBL371024R8800	UA63-30-00RA	5/159	1SBL419261R6200	TAE75-40-00	5/104	1SBN050020R1000	RT5/32	4/37
1SBL387001R1100	AF65-30-00-11	5/8	1SBL419261R6600	TAE75-40-00	5/104	1SBN050020R1001	RT5/65	4/37
1SBL387001R1111	AF65-30-11-11	5/26	1SBL419261R6800	TAE75-40-00	5/104	1SBN050020R1002	RT5/90	4/37
1SBL387001R1122	AF65-30-22-11	5/26	1SBL419501R8000	AE75-22-00	5/100	1SBN050020R1003	RT5/150	4/37
1SBL387001R1200	AF65-30-00-12	5/8	1SBL419501R8100	AE75-22-00	5/100	1SBN050020R1004	RT5/264	4/37
1SBL387001R1211	AF65-30-11-12	5/26	1SBL419501R8300	AE75-22-00	5/100	1SBN050100R1000	RC5-1/50	4/37
1SBL387001R1222	AF65-30-22-12	5/26	1SBL419501R8400	AE75-22-00	5/100	1SBN050100R1001	RC5-1/133	4/37
1SBL387001R1300	AF65-30-00-13	5/8	1SBL419501R8600	AE75-22-00	5/100	1SBN050100R1002	RC5-1/250	4/37
1SBL387001R1311	AF65-30-11-13	5/26	1SBL419501R8700	AE75-22-00	5/100	1SBN050100R1003	RC5-1/440	4/37
1SBL387001R1322	AF65-30-22-13	5/26	1SBL419501R8800	AE75-22-00	5/100	1SBN050200R1000	RC5-2/50	5/103
1SBL387001R1400	AF65-30-00-14	5/8	1SBL419501R8900	AE75-22-00	5/100	1SBN050200R1001	RC5-2/133	5/103
1SBL387001R1411	AF65-30-11-14	5/26	1SBN010010R1001	CA5-01	5/103	1SBN050200R1002	RC5-2/250	5/103
1SBL387001R1422	AF65-30-22-14	5/26	1SBN010010R1010	CA5-10	5/103	1SBN050200R1003	RC5-2/440	5/103
1SBL387001R4100	AF65-30-00-41	5/8	1SBN010010R1001	CC5-01	5/228	1SBN060300R1000	RA5-1	5/244
1SBL387001R4111	AF65-30-11-41	5/26	1SBN010010R1010	CC5-10	5/228	1SBN060300T1000	RA5-1	5/244
1SBL387001R4122	AF65-30-22-41	5/26	1SBN010013R1001	CB5-01	5/212	1SBN070156T1000	LDC4	5/183
1SBL397001R1100	AF80-30-00-11	5/8	1SBN010013R1010	CB5-10	5/212	1SBN070157T1000	LDC4S	6/47
1SBL397001R1111	AF80-30-11-11	5/27	1SBN010015R1001	CE5-01D0.1	5/230	1SBN071303T1000	LY16-4	5/220
1SBL397001R1122	AF80-30-22-11	5/27	1SBN010015R1010	CE5-10D0.1	5/230	1SBN072303T1000	LY38-4	5/220
1SBL397001R1200	AF80-30-00-12	5/8	1SBN010016R1001	CE5-01W0.1	5/230	1SBN073508R1000	LD75	5/248
1SBL397001R1211	AF80-30-11-12	5/27	1SBN010016R1010	CE5-10W0.1	5/230	1SBN073552R1002	LK75-F	5/249
1SBL397001R1222	AF80-30-22-12	5/27	1SBN010017R1001	CE5-01D2	5/230	1SBN073552R1003	LK75-L	5/249
1SBL397001R1300	AF80-30-00-13	5/8	1SBN010017R1010	CE5-10D2	5/230	1SBN080906R1001	BEA7/325	3/37
1SBL397001R1311	AF80-30-11-13	5/27	1SBN010018R1001	CE5-01W2	5/230	1SBN080906R1002	BEA7/132	3/37
1SBL397001R1322	AF80-30-22-13	5/27	1SBN010018R1010	CE5-10W2	5/230	1SBN081006T1000	BEA16-3	4/37
1SBL397001R1400	AF80-30-00-14	5/8	1SBN010020R1011	CAL5-11	5/103	1SBN081012R1000	BER16C-3	4/37
1SBL397001R1411	AF80-30-11-14	5/27	1SBN010040R1004	CA5-04E	5/228	1SBN081018R2000	BEY16C-3	4/37
1SBL397001R1422	AF80-30-22-14	5/27	1SBN010040R1018	CA5-11/11E	5/228	1SBN081020R1000	BEA16-3U	6/9
1SBL397001R4100	AF80-30-00-41	5/8	1SBN010040R1022	CA5-22E	5/103	1SBN081306T1000	BEA16-4	5/11
1SBL397001R4111	AF80-30-11-41	5/27	1SBN010040R1031	CA5-31E	5/228	1SBN081311R1000	BER16-4	5/11
1SBL397001R4122	AF80-30-22-41	5/27	1SBN010040R1040	CA5-40E	5/228	1SBN081313R2000	BEY16-4	5/11
1SBL407001R1100	AF96-30-00-11	5/8	1SBN010040R1104	CA5-04M	5/228	1SBN082306T1000	BEA26-4	5/11
1SBL407001R1111	AF96-30-11-11	5/27	1SBN010040R1113	CA5-13M	5/228	1SBN082306T2000	BEA38-4	5/11
1SBL407001R1122	AF96-30-22-11	5/27	1SBN010040R1118	CA5-11/11M	5/228	1SBN082311R1000	BER38-4	5/11
1SBL407001R1200	AF96-30-00-12	5/8	1SBN010040R1122	CA5-22M	5/228	1SBN082713R2000	BEY38-4	5/11
1SBL407001R1211	AF96-30-11-12	5/27	1SBN010040R1131	CA5-31M	5/228	1SBN083302R1000	BE575-40	5/103
1SBL407001R1222	AF96-30-22-12	5/27	1SBN010110R1001	CA4-01	5/11	1SBN083411R1000	BER65-4	5/11
1SBL407001R1300	AF96-30-00-13	5/8	1SBN010110R1010	CA4-10	5/11	1SBN083413R2000	BEY65-4	5/11
1SBL407001R1311	AF96-30-11-13	5/27	1SBN010110T1001	CA4-01-T	5/11	1SBN083911R1000	BER96-4	5/11
1SBL407001R1322	AF96-30-22-13	5/27	1SBN010110T1010	CA4-10-T	5/11	1SBN083913R2000	BEY96-4	5/11
1SBL407001R1400	AF96-30-00-14	5/8	1SBN010111R1001	CC4-01	5/11	1SBN110000R1000	BA5-50	3/37
1SBL407001R1411	AF96-30-11-14	5/27	1SBN010111R1010	CC4-10	5/11	1SBN110108T1000	BX4	5/183
1SBL407001R1422	AF96-30-22-14	5/27	1SBN010119R1001	CA4-01S	6/47	1SBN110109W1000	BX4-CA	5/183
1SBL407001R4100	AF96-30-00-41	5/8	1SBN010119R1010	CA4-10S	6/47	1SBN110120W1000	BB4	5/210
1SBL407001R4111	AF96-30-11-41	5/27	1SBN010119T1001	CA4-01S-T	6/47	1SBN110122T1000	BDT4	4/80
1SBL407001R4122	AF96-30-22-41	5/27	1SBN010120T1010	CA4-10S-T	6/47	1SBN111020R1000	BB3	4/80
1SBL411022R8000	UA75-30-00	5/168	1SBN010120R1011	CAL4-11	5/11	1SBN111403R1000	BP16	5/241
1SBL411022R8011	UA75-30-11	5/169	1SBN010120T1011	CAL4-11-T	5/11	1SBN112303T1000	BP38-4	5/217
1SBL411022R8100	UA75-30-00	5/168	1SBN010130R1011	CAL4-11S	6/47	1SBN113403T1000	BP65-4	5/217
1SBL411022R8111	UA75-30-11	5/169	1SBN010140R1004	CA4-04E	5/97	1SBN113903T1000	BP96-4	5/217
1SBL411022R8300	UA75-30-00	5/168	1SBN010140R1022	CA4-22E	5/11	1SBN151410R8006	ZA16	5/251
1SBL411022R8311	UA75-30-11	5/169	1SBN010140R1031	CA4-31E	5/97	1SBN151410R8106	ZA16	5/251
1SBL411022R8400	UA75-30-00	5/168	1SBN010140R1040	CA4-40E	5/97	1SBN151410R8306	ZA16	5/251
1SBL411022R8411	UA75-30-11	5/169	1SBN010140R1104	CA4-04M	5/198	1SBN151410R8406	ZA16	5/251
1SBL411022R8500	UA75-30-00	5/168	1SBN010140R1113	CA4-13M	5/198	1SBN151410R8506	ZA16	5/251
1SBL411022R8511	UA75-30-11	5/169	1SBN010140R1122	CA4-22M	5/11	1SBN151410R8606	ZA16	5/251
1SBL411022R8600	UA75-30-00	5/168	1SBN010140R1131	CA4-31M	5/198	1SBN151410R8806	ZA16	5/251
1SBL411022R8611	UA75-30-11	5/169	1SBN010140R1204	CA4-04N	5/183	1SBN152410R8006	ZA40	5/251
1SBL411022R8800	UA75-30-00	5/168	1SBN010140R1213	CA4-13N	5/183	1SBN152410R8106	ZA40	5/251
1SBL411022R8811	UA75-30-11	5/169	1SBN010140R1222	CA4-22N	5/183	1SBN152410R8306	ZA40	5/251
1SBL411024R8000	UA75-30-00RA	5/159	1SBN010140R1231	CA4-31N	5/183	1SBN152410R8406	ZA40	5/251
1SBL411024R8100	UA75-30-00RA	5/159	1SBN010140R1240	CA4-40N	5/183	1SBN152410R8506	ZA40	5/251
1SBL411024R8300	UA75-30-00RA	5/159	1SBN010140R1322	CA4-22U	5/11	1SBN152410R8606	ZA40	5/251
1SBL411024R8400	UA75-30-00RA	5/159	1SBN010140R1331	CA4-31U	5/198	1SBN152410R8806	ZA40	5/251
1SBL411024R8500	UA75-30-00RA	5/159	1SBN010140R1340	CA4-40U	5/198	1SBN153510R8006	ZA75	5/251
1SBL411024R8600	UA75-30-00RA	5/159	1SBN010145R1022	CA4-22ES	6/47	1SBN153510R8106	ZA75	5/251
1SBL411024R8800	UA75-30-00RA	5/159	1SBN010145R1031	CA4-31ES	6/47	1SBN153510R8306	ZA75	5/251
1SBL411201R8000	A75-40-00	5/99	1SBN010145R1040	CA4-40ES	6/47	1SBN153510R8406	ZA75	5/251
1SBL411201R8100	A75-40-00	5/99	1SBN010145R1122	CA4-22MS	6/47	1SBN153510R8506	ZA75	5/251
1SBL411201R8300	A75-40-00	5/99	1SBN010145R1131	CA4-31MS	6/47	1SBN153510R8606	ZA75	5/251
1SBL411201R8400	A75-40-00	5/99	1SBN010145R1222	CA4-22NS	6/65	1SBN153510R8806	ZA75	5/251
1SBL411201R8500	A75-40-00	5/99	1SBN010145R1231	CA4-31NS	6/65	1SBN153570R6906	ZAF75	5/251
1SBL411201R8600	A75-40-00	5/99	1SBN010145R1240	CA4-40NS	6/65	1SBN153570R7006	ZAF75	5/251
1SBL411201R8800	A75-40-00	5/99	1SBN010151R1011	CAT4-11E	5/11	1SBN153570R7206	ZAF75	5/251
1SBL411501R8000	A75-22-00	5/99	1SBN010151R1111	CAT4-11M	5/11	1SBN163502R1000	ZLU50	5/251
1SBL411501R8100	A75-22-00	5/99	1SBN010151R1311	CAT4-11U	5/11	1SBN163702R1000	ZLU63	5/251
1SBL411501R8300	A75-22-00	5/99	1SBN010153R1011	CAT4-11ES	6/47	1SBN164102R1000	ZLU75	5/251
1SBL411501R8400	A75-22-00	5/99	1SBN010153R1111	CAT4				

# Index

## Order code classification

Order code	Type	Page	Order code	Type	Page	Order code	Type	Page
1SFA6162R1014	KPR-101L	7/4	1SFL487002R1111	AF190-30-11-11	5/17	1SFNO35203R1000	VM205/265	5/15
1SFA739001R1000	E1250DU-1250	7/45	1SFL487002R1122	AF190-30-22-11	5/31	1SFNO35700R1000	VM750H	5/23
1SFL427001R1100	AF116-30-00-11	5/12	1SFL487002R1200	AF190-30-00-12	5/13	1SFNO35701R1000	VM750V	5/210
1SFL427001R1111	AF116-30-11-11	5/16	1SFL487002R1211	AF190-30-11-12	5/17	1SFNO36503R1000	VM1650H	5/23
1SFL427001R1122	AF116-30-22-11	5/30	1SFL487002R1222	AF190-30-22-12	5/31	1SFNO74203R1000	LY140	5/220
1SFL427001R1200	AF116-30-00-12	5/12	1SFL487002R1300	AF190-30-00-13	5/13	1SFNO74207R1000	LW140	5/15
1SFL427001R1211	AF116-30-11-12	5/16	1SFL487002R1311	AF190-30-11-13	5/17	1SFNO74208R1000	LD146-30	5/219
1SFL427001R1222	AF116-30-22-12	5/30	1SFL487002R1322	AF190-30-22-13	5/31	1SFNO74210R1000	LX140	5/15
1SFL427001R1300	AF116-30-00-13	5/12	1SFL527002R1100	AF205-30-00-11	5/13	1SFNO74211R1000	LL146-30	5/219
1SFL427001R1311	AF116-30-11-13	5/16	1SFL527002R1111	AF205-30-11-11	5/17	1SFNO74307R1000	LW110	5/250
1SFL427001R1322	AF116-30-22-13	5/30	1SFL527002R1122	AF205-30-22-11	5/31	1SFNO74703R1000	LY185	5/220
1SFL427002R1100	AF116-30-00B-11	5/12	1SFL527002R1200	AF205-30-00-12	5/13	1SFNO74712R1000	LP185	5/220
1SFL427002R1111	AF116-30-11B-11	5/16	1SFL527002R1211	AF205-30-11-12	5/17	1SFNO74807R1000	LW205	5/15
1SFL427002R1122	AF116-30-22B-11	5/30	1SFL527002R1222	AF205-30-22-12	5/31	1SFNO74810R1000	LX205	5/15
1SFL427002R1200	AF116-30-00B-12	5/12	1SFL527002R1300	AF205-30-00-13	5/13	1SFNO75103R1000	LY300	5/220
1SFL427002R1211	AF116-30-11B-12	5/16	1SFL527002R1311	AF205-30-11-13	5/17	1SFNO75112R1000	LP300	5/220
1SFL427002R1222	AF116-30-22B-12	5/30	1SFL527002R1322	AF205-30-22-13	5/31	1SFNO75407R1000	LW370	5/15
1SFL427002R1300	AF116-30-00B-13	5/12	1SFL547002R1100	AF265-30-00-11	5/13	1SFNO75410R1000	LX370	5/15
1SFL427002R1311	AF116-30-11B-13	5/16	1SFL547002R1111	AF265-30-11-11	5/17	1SFNO75703R1000	LY460	5/220
1SFL427002R1322	AF116-30-22B-13	5/30	1SFL547002R1122	AF265-30-22-11	5/31	1SFNO75707R1000	LW460	5/23
1SFL431022R8000	UA95-30-00	5/170	1SFL547002R1200	AF265-30-00-12	5/13	1SFNO75710R1000	LX460	5/23
1SFL431022R8011	UA95-30-11	5/171	1SFL547002R1211	AF265-30-11-12	5/17	1SFNO75712R1000	LP460	5/220
1SFL431022R8100	UA95-30-00	5/170	1SFL547002R1222	AF265-30-22-12	5/31	1SFNO76103R1000	LY750	5/220
1SFL431022R8111	UA95-30-11	5/171	1SFL547002R1300	AF265-30-00-13	5/13	1SFNO76107R1000	LW750	5/23
1SFL431022R8300	UA95-30-00	5/170	1SFL547002R1311	AF265-30-11-13	5/17	1SFNO76110R1000	LX750	5/23
1SFL431022R8311	UA95-30-11	5/171	1SFL547002R1322	AF265-30-22-13	5/31	1SFNO76112R1000	LP750	5/220
1SFL431022R8400	UA95-30-00	5/170	1SFL577001R6811	AF400-30-11	5/20	1SFNO76407R1000	LW1250	5/23
1SFL431022R8411	UA95-30-11	5/171	1SFL577001R6822	AF400-30-22	5/34	1SFNO84211R1000	BEA140/XT2	5/223
1SFL431022R8500	UA95-30-00	5/170	1SFL577001R6911	AF400-30-11	5/20	1SFNO84216R1000	BEA140/XT4	5/223
1SFL431022R8511	UA95-30-11	5/171	1SFL577001R6922	AF400-30-22	5/34	1SFNO84218R1000	BER140-4	5/221
1SFL431022R8600	UA95-30-00	5/170	1SFL577001R7011	AF400-30-11	5/20	1SFNO84218R1000	BEP140-30	5/221
1SFL431022R8611	UA95-30-11	5/171	1SFL577001R7022	AF400-30-22	5/34	1SFNO84413R1000	BEY140-4	5/222
1SFL431022R8800	UA95-30-00	5/170	1SFL577001R7111	AF400-30-11	5/20	1SFNO84406R1000	BEA205/XT4	5/223
1SFL431022R8811	UA95-30-11	5/171	1SFL577001R7122	AF400-30-22	5/34	1SFNO84806R1000	BEA205/T4	5/223
1SFL431024R8000	UA95-30-00RA	5/160	1SFL587002R1100	AF305-30-00-11	5/13	1SFNO84811R1000	BER205-4	5/221
1SFL431024R8100	UA95-30-00RA	5/160	1SFL587002R1111	AF305-30-11-11	5/17	1SFNO84813R1000	BEY190-4	5/222
1SFL431024R8300	UA95-30-00RA	5/160	1SFL587002R1122	AF305-30-22-11	5/31	1SFNO84814R1000	BEP205-30	5/221
1SFL431024R8400	UA95-30-00RA	5/160	1SFL587002R1200	AF305-30-00-12	5/13	1SFNO85213R1000	BEY205-4	5/222
1SFL431024R8500	UA95-30-00RA	5/160	1SFL587002R1211	AF305-30-11-12	5/17	1SFNO85406R1000	BEA370/T5	5/223
1SFL431024R8600	UA95-30-00RA	5/160	1SFL587002R1222	AF305-30-22-12	5/31	1SFNO85411R1000	BER370-4	5/221
1SFL431024R8800	UA95-30-00RA	5/160	1SFL587002R1300	AF305-30-00-13	5/13	1SFNO85413R1000	BEY265-4	5/222
1SFL447001R1100	AF140-30-00-11	5/12	1SFL587002R1311	AF305-30-11-13	5/17	1SFNO85414R1000	BEP370-30	5/221
1SFL447001R1111	AF140-30-11-11	5/16	1SFL587002R1322	AF305-30-22-13	5/31	1SFNO85701R1000	BEM460-30	5/221
1SFL447001R1122	AF140-30-22-11	5/30	1SFL597001R6811	AF460-30-11	5/20	1SFNO85703R1000	BED460	5/222
1SFL447001R1200	AF140-30-00-12	5/12	1SFL597001R6822	AF460-30-22	5/34	1SFNO85704R1000	BES460	5/221
1SFL447001R1211	AF140-30-11-12	5/16	1SFL597001R6911	AF460-30-11	5/20	1SFNO85708R1000	BEP460/OESA400	5/223
1SFL447001R1222	AF140-30-22-12	5/30	1SFL597001R6922	AF460-30-22	5/34	1SFNO85709R1000	OESA460H/OESA400	5/223
1SFL447001R1300	AF140-30-00-13	5/12	1SFL597001R7011	AF460-30-11	5/20	1SFNO85813R1000	BEY370-4	5/222
1SFL447001R1311	AF140-30-11-13	5/16	1SFL597001R7022	AF460-30-22	5/34	1SFNO85818R1000	BED580	5/222
1SFL447001R1322	AF140-30-22-13	5/30	1SFL597001R7111	AF460-30-11	5/20	1SFNO85907R1000	BEA460H/T4	5/223
1SFL447002R1100	AF140-30-00B-11	5/12	1SFL597001R7122	AF460-30-22	5/34	1SFNO86101R1000	BEM750-30	5/221
1SFL447002R1111	AF140-30-11B-11	5/16	1SFL607002R1100	AF370-30-00-11	5/13	1SFNO86103R1000	BED750	5/222
1SFL447002R1122	AF140-30-22B-11	5/30	1SFL607002R1111	AF370-30-11-11	5/17	1SFNO86104R1000	BES750	5/221
1SFL447002R1200	AF140-30-00B-12	5/12	1SFL607002R1122	AF370-30-22-11	5/31	1SFNO86106R1000	BEA750/T6	5/223
1SFL447002R1211	AF140-30-11B-12	5/16	1SFL607002R1200	AF370-30-00-12	5/13	1SFNO86106R1001	BEA750/T5	5/223
1SFL447002R1222	AF140-30-22B-12	5/30	1SFL607002R1211	AF370-30-11-12	5/17	1SFNO86106R1002	BEA750D/T6	5/223
1SFL447002R1300	AF140-30-00B-13	5/12	1SFL607002R1222	AF370-30-22-12	5/31	1SFNO86106R1003	BEA750D/T5	5/223
1SFL447002R1311	AF140-30-11B-13	5/16	1SFL607002R1300	AF370-30-00-13	5/13	1SFNO86108R1000	BEP750/OESA800	5/223
1SFL447002R1322	AF140-30-22B-13	5/30	1SFL607002R1311	AF370-30-11-13	5/17	1SFNO94200R1000	PR146-1	5/225
1SFL451022R8000	UA110-30-00	5/170	1SFL607002R1322	AF370-30-22-13	5/31	1SFNO94900R1000	PR210-1	5/225
1SFL451022R8011	UA110-30-11	5/171	1SFL617001R6811	AF580-30-11	5/20	1SFNO95100R1001	PR185-2	5/225
1SFL451022R8100	UA110-30-00	5/170	1SFL617001R6822	AF580-30-22	5/34	1SFNO95300R1000	PR300-1	5/225
1SFL451022R8111	UA110-30-11	5/171	1SFL617001R6911	AF580-30-11	5/20	1SFNO95300R1001	PR300-2	5/225
1SFL451022R8300	UA110-30-00	5/170	1SFL617001R6922	AF580-30-22	5/34	1SFNO95700R1000	PR460-1	5/225
1SFL451022R8311	UA110-30-11	5/171	1SFL617001R7011	AF580-30-11	5/20	1SFNO95700R1001	PR460-2	5/225
1SFL451022R8400	UA110-30-00	5/170	1SFL617001R7022	AF580-30-22	5/34	1SFNO95700R1002	PR400-2	5/225
1SFL451022R8411	UA110-30-11	5/171	1SFL617001R7111	AF580-30-11	5/20	1SFNO95701R1000	PN460-21	5/224
1SFL451022R8500	UA110-30-00	5/170	1SFL617001R7122	AF580-30-22	5/34	1SFNO95703R1000	PN460-41	5/224
1SFL451022R8511	UA110-30-11	5/171	1SFL637001R6811	AF750-30-11	5/20	1SFNO95705R1000	PN460-11	5/224
1SFL451022R8600	UA110-30-00	5/170	1SFL637001R6822	AF750-30-22	5/34	1SFNO96100R1000	PR750-1	5/225
1SFL451022R8611	UA110-30-11	5/171	1SFL637001R6911	AF750-30-11	5/20	1SFNO96100R1001	PR750-2	5/225
1SFL451022R8800	UA110-30-00	5/170	1SFL637001R6922	AF750-30-22	5/34	1SFNO96101R1002	PR580-2	5/225
1SFL451022R8811	UA110-30-11	5/171	1SFL637001R7011	AF750-30-11	5/20	1SFNO96101R1000	PN750-21	5/224
1SFL451024R8000	UA110-30-00RA	5/160	1SFL637001R7022	AF750-30-22	5/34	1SFNO96103R1000	PN750-41	5/224
1SFL451024R8100	UA110-30-00RA	5/160	1SFL637001R7111	AF750-30-11	5/20	1SFNO96105R1000	PN750-11	5/224
1SFL451024R8300	UA110-30-00RA	5/160	1SFL637001R7122	AF750-30-22	5/34	1SFN124203R1000	LT140-30L	5/15
1SFL451024R8400	UA110-30-00RA	5/160	1SFL647001R6811	AF1250-30-11	5/21	1SFN124801R1000	LT205-30C	5/15
1SFL451024R8500	UA110-30-00RA	5/160	1SFL647001R6822	AF1250-30-22	5/35	1SFN124803R1000	LT205-30L	5/15
1SFL451024R8600	UA110-30-00RA	5/160	1SFL647001R6911	AF1250-30-11	5/21	1SFN124804R1000	LT205-30Y	5/15
1SFL451024R8800	UA110-30-00RA	5/160	1SFL647001R6922	AF1250-30-22	5/35	1SFN125401R1000	LT370-30C	5/15
1SFL467001R1100	AF146-30-00-11	5/12	1SFL647001R7011	AF1250-30-11	5/21	1SFN125403R1000	LT370-30L	5/15
1SFL467001R1111	AF146-30-11-11	5/16	1SFL647001R7022	AF1250-30-22	5/35	1SFN125404R1000	LT370-30Y	5/15
1SFL467001R1122	AF146-30-22-11	5/30	1SFL647001R7111	AF1250-30-11	5/21	1SFN125406R1000	LT370-30D	5/15
1SFL467001R1200	AF146-30-00-12	5/12	1SFL647001R7122	AF1250-30-22	5/35	1SFN125701R1000	LT460-AC	5/23
1SFL467001R1211	AF146-30-11-12							



# Index

## Order code classification

Order code	Type	Page
1SFN156170R7006	ZAF750	5/226
1SFN156170R7106	ZAF750	5/226
1SFN156570R7026	ZAF1650	5/226
1SFN156670R7026	ZAF2650	5/226
1SFN164302R1000	ZLU95	5/251
1SFN164502R1000	ZLU110	5/251
1SFN165703R1000	ZL400	5/226
1SFN165710R1000	ZW460	5/226
1SFN165903R1000	ZL460	5/226
1SFN166103R1000	ZL580	5/226
1SFN166110R1000	ZW750	5/226
1SFN166303R1000	ZL750	5/226
1SFN166403R1000	ZL1250	5/226
1SFN166503R1000	ZL1350	5/226
1SFN166510R1000	ZW1650	5/226
1SFN166521R1070	ZP1650	5/226
1SFN166603R1000	ZL2650	5/226
1SFN166610R1000	ZW2650	5/226
1SFN166621R1070	ZP2650	5/226
1SFN166703R1000	ZL1650	5/226
1SFN167003R1000	ZL2050	5/226
1SNA235156R2700	BA4	4/80
1SNA235712R2400	HTP500-BA4	4/80
1SNA360010R1500	SPRC 1	4/80
2CCS801901R0539	S801S-SCL32-SR	10/2
2CCS801901R0599	S801S-SCL63-SR	10/2
2CCS801901R0639	S801S-SCL100-SR	10/2
2CCS802901R0539	S802S-SCL32-SR	10/2
2CCS802901R0599	S802S-SCL63-SR	10/2
2CCS802901R0639	S802S-SCL100-SR	10/2
2CCS803901R0539	S803S-SCL32-SR	10/2
2CCS803901R0599	S803S-SCL63-SR	10/2
2CCS803901R0639	S803S-SCL100-SR	10/2
2CCS803917R0539	S803W-SCL32-SR	10/2
2CCS803917R0599	S803W-SCL63-SR	10/2
2CCS803917R0639	S803W-SCL100-SR	10/2
FPTN372726R1001	WB75-A	5/214
FPTN372726R1002	WB75-A	5/214
FPTN372726R1003	WB75-A	5/214
FPTN372726R1004	WB75-A	5/214
FPTN372726R1005	WB75-A	5/214
FPTN372726R1006	WB75-A	5/214
FPTN372726R1007	WB75-A	5/214
FPTN372726R1008	WB75-A	5/214
FPTN472734R0001	LH75	5/250
FPTN472735R0001	LF75	5/250
GHV2501902R0002	RV-BC6/60	3/37
GHV2501902R0003	RV-BC6/F60	3/37
GHV2501903R0002	RV-BC6/250	3/37
GHV2501903R0003	RV-BC6/F250	3/37
GHV2501904R0002	RV-BC6/380	3/37
GHV2501904R0003	RV-BC6-F/380	3/37
GJF1101903R0001	SA1	2/8
GJF1101903R0002	SA2	2/8
GJF1101903R0003	SA3	2/8
GJH1211001R0221	K6-22Z-01	3/13
GJH1211001R0222	K6-22Z-02	3/13
GJH1211001R0223	K6-22Z-03	3/13
GJH1211001R0311	K6-31Z-01	3/13
GJH1211001R0312	K6-31Z-02	3/13
GJH1211001R0313	K6-31Z-03	3/13
GJH1211001R0401	K6-40E-01	3/13
GJH1211001R0402	K6-40E-02	3/13
GJH1211001R0403	K6-40E-03	3/13
GJH1211001R8220	K6-22Z-80	3/13
GJH1211001R8224	K6-22Z-84	3/13
GJH1211001R8225	K6-22Z-85	3/13
GJH1211001R8310	K6-31Z-80	3/13
GJH1211001R8314	K6-31Z-84	3/13
GJH1211001R8315	K6-31Z-85	3/13
GJH1211001R8400	K6-40E-80	3/13
GJH1211001R8404	K6-40E-84	3/13
GJH1211001R8405	K6-40E-85	3/13
GJH1211003R0221	K6-22Z-F-01	3/34
GJH1211003R0222	K6-22Z-F-02	3/34
GJH1211003R0223	K6-22Z-F-03	3/34
GJH1211003R0311	K6-31Z-F-01	3/34
GJH1211003R0312	K6-31Z-F-02	3/34
GJH1211003R0313	K6-31Z-F-03	3/34
GJH1211003R0401	K6-40E-F-01	3/34
GJH1211003R0402	K6-40E-F-02	3/34
GJH1211003R0403	K6-40E-F-03	3/34
GJH1211003R8220	K6-22Z-F-80	3/34
GJH1211003R8224	K6-22Z-F-84	3/34
GJH1211003R8225	K6-22Z-F-85	3/34
GJH1211003R8310	K6-31Z-F-80	3/34
GJH1211003R8314	K6-31Z-F-84	3/34
GJH1211003R8315	K6-31Z-F-85	3/34
GJH1211003R8400	K6-40E-F-80	3/34
GJH1211003R8404	K6-40E-F-84	3/34
GJH1211003R8405	K6-40E-F-85	3/34
GJH1211009R0221	K6-22Z-P-01	3/23
GJH1211009R0222	K6-22Z-P-02	3/23
GJH1211009R0223	K6-22Z-P-03	3/23
GJH1211009R0311	K6-31Z-P-01	3/23
GJH1211009R0312	K6-31Z-P-02	3/23
GJH1211009R0313	K6-31Z-P-03	3/23
GJH1211009R0401	K6-40E-P-01	3/23
GJH1211009R0402	K6-40E-P-02	3/23
GJH1211009R0403	K6-40E-P-03	3/23

Order code	Type	Page
GJH1211009R8220	K6-22Z-P-80	3/23
GJH1211009R8224	K6-22Z-P-84	3/23
GJH1211009R8225	K6-22Z-P-85	3/23
GJH1211009R8310	K6-31Z-P-80	3/23
GJH1211009R8314	K6-31Z-P-84	3/23
GJH1211009R8315	K6-31Z-P-85	3/23
GJH1211009R8400	K6-40E-P-80	3/23
GJH1211009R8404	K6-40E-P-84	3/23
GJH1211009R8405	K6-40E-P-85	3/23
GJH1213001R0221	K6-22Z-01	3/14
GJH1213001R0224	K6-22Z-04	3/14
GJH1213001R0225	K6-22Z-05	3/14
GJH1213001R0227	K6-22Z-07	3/14
GJH1213001R0311	K6-31Z-01	3/14
GJH1213001R0314	K6-31Z-04	3/14
GJH1213001R0315	K6-31Z-05	3/14
GJH1213001R0317	K6-31Z-07	3/14
GJH1213001R0401	K6-40E-01	3/14
GJH1213001R0404	K6-40E-04	3/14
GJH1213001R0405	K6-40E-05	3/14
GJH1213001R0407	K6-40E-07	3/14
GJH1213001R1223	K6-22Z-13	3/14
GJH1213001R1226	K6-22Z-16	3/14
GJH1213001R1313	K6-31Z-13	3/14
GJH1213001R1316	K6-31Z-16	3/14
GJH1213001R1403	K6-40E-13	3/14
GJH1213001R1406	K6-40E-16	3/14
GJH1213001R5311	K6-31Z-2-4-51	3/15
GJH1213001R5401	K6-40E-2-4-51	3/15
GJH1213001R7221	K6S-22Z-1-7-71	3/15
GJH1213001R7222	K6S-22Z-2-8-72	3/15
GJH1213001R7311	K6S-31Z-1-7-71	3/15
GJH1213001R7312	K6S-31Z-2-8-72	3/15
GJH1213001R7401	K6S-40E-1-7-71	3/15
GJH1213001R7402	K6S-40E-2-8-72	3/15
GJH1213001R8311	K6-31Z-1-4-81	3/15
GJH1213001R8401	K6-40E-1-4-81	3/15
GJH1213003R0221	K6-22Z-F-01	3/35
GJH1213003R0224	K6-22Z-F-04	3/35
GJH1213003R0225	K6-22Z-F-05	3/35
GJH1213003R0227	K6-22Z-F-07	3/35
GJH1213003R0311	K6-31Z-F-01	3/35
GJH1213003R0314	K6-31Z-F-04	3/35
GJH1213003R0315	K6-31Z-F-05	3/35
GJH1213003R0317	K6-31Z-F-07	3/35
GJH1213003R0401	K6-40E-F-01	3/35
GJH1213003R0404	K6-40E-F-04	3/35
GJH1213003R0405	K6-40E-F-05	3/35
GJH1213003R1226	K6-22Z-F-16	3/35
GJH1213003R1316	K6-31Z-F-16	3/35
GJH1213003R1406	K6-40E-F-16	3/35
GJH1213003R5311	K6-31Z-F-51	3/36
GJH1213003R5401	K6-40E-F-51	3/36
GJH1213003R8311	K6-31Z-F-1-4-81	3/36
GJH1213003R8401	K6-40E-F-1-4-81	3/36
GJH1213009R0221	K6-22Z-P-01	3/24
GJH1213009R0224	K6-22Z-P-04	3/24
GJH1213009R0225	K6-22Z-P-05	3/24
GJH1213009R0227	K6-22Z-P-07	3/24
GJH1213009R0311	K6-31Z-P-01	3/24
GJH1213009R0314	K6-31Z-P-04	3/24
GJH1213009R0315	K6-31Z-P-05	3/24
GJH1213009R0401	K6-40E-P-01	3/24
GJH1213009R0404	K6-40E-P-04	3/24
GJH1213009R0405	K6-40E-P-05	3/24
GJH1213009R0407	K6-40E-P-07	3/24
GJH1213009R1226	K6-22Z-P-16	3/24
GJH1213009R1316	K6-31Z-P-16	3/24
GJH1213009R1406	K6-40E-P-16	3/24
GJH1213009R5311	K6-31Z-P-2-4-51	3/26
GJH1213009R5401	K6-40E-P-2-4-51	3/26
GJH1213009R8311	K6-31Z-P-1-4-81	3/26
GJH1213009R8401	K6-40E-P-1-4-81	3/26
GJH1213061R5221	TKC6-22Z-51	3/16
GJH1213061R5225	TKC6-22Z-55	3/16
GJH1213061R5311	TKC6-31Z-51	3/16
GJH1213061R5315	TKC6-31Z-55	3/16
GJH1213061R5401	TKC6-40E-51	3/16
GJH1213061R5405	TKC6-40E-55	3/16
GJH1213061R6222	TKC6-22Z-62	3/16
GJH1213061R6228	TKC6-22Z-68	3/16
GJH1213061R6312	TKC6-31Z-62	3/16
GJH1213061R6318	TKC6-31Z-68	3/16
GJH1213061R6402	TKC6-40E-62	3/16
GJH1213061R6408	TKC6-40E-68	3/16
GJL1201317R0001	CA6-11K	3/38
GJL1201317R0002	CA6-11E	3/37
GJL1201317R0003	CA6-11M	3/37
GJL1201317R0004	CA6-11N	3/37
GJL1201318R0001	CA6-11K-F	3/38
GJL1201318R0002	CA6-11E-F	3/37
GJL1201318R0003	CA6-11M-F	3/37
GJL1201318R0004	CA6-11N-F	3/37
GJL1201319R0001	CA6-11K-P	3/38
GJL1201319R0002	CA6-11E-P	3/37
GJL1201319R0003	CA6-11M-P	3/37
GJL1201319R0004	CA6-11N-P	3/37
GJL1201330R0001	CAF6-11K	3/38
GJL1201330R0002	CAF6-11E	3/37
GJL1201330R0003	CAF6-11M	3/37

Order code	Type	Page
GJL1201330R0004	CAF6-11N	3/37
GJL1201330R0005	CAF6-20K	3/38
GJL1201330R0006	CAF6-20E	3/37
GJL1201330R0007	CAF6-20M	3/37
GJL1201330R0008	CAF6-20N	3/37
GJL1201330R0009	CAF6-02K	3/38
GJL1201330R0010	CAF6-02E	3/37
GJL1201330R0011	CAF6-02M	3/37
GJL1201330R0012	CAF6-02N	3/37
GJL1201902R0001	LB6	3/37
GJL1201903R0001	LB6-CA	3/37
GJL1201906R0001	LT6-B	3/37
GJL1201907R0001	LP6	3/37
GJL1201908R0001	BSM6-30	3/37
GJL1211001R0011	B6-30-01-01	3/2
GJL1211001R0012	B6-30-01-02	3/2
GJL1211001R0013	B6-30-01-03	3/2
GJL1211001R0101	B6-30-10-01	3/2
GJL1211001R0102	B6-30-10-02	3/2
GJL1211001R0103	B6-30-10-03	3/2
GJL1211001R8010	B6-30-01-80	3/2
GJL1211001R8014	B6-30-01-84	3/2
GJL1211001R8015	B6-30-01-85	3/2
GJL1211001R8100	B6-30-10-80	3/2
GJL1211001R8104	B6-30-10-84	3/2
GJL1211001R8105	B6-30-10-85	3/2
GJL1211003R0011	B6-30-01-F-01	3/27
GJL1211003R0012	B6-30-01-F-02	3/27
GJL1211003R0013	B6-30-01-F-03	3/27
GJL1211003R0101	B6-30-10-F-01	3/27
GJL1211003R0102	B6-30-10-F-02	3/27
GJL1211003R0103	B6-30-10-F-03	3/27
GJL1211003R8010	B6-30-01-F-80	3/27
GJL1211003R8014	B6-30-01-F-84	3/27
GJL1211003R8015	B6-30-01-F-85	3/27
GJL1211003R8100	B6-30-10-F-80	3/27
GJL1211003R8104	B6-30-10-F-84	3/27
GJL1211003R8105	B6-30-10-F-85	3/27
GJL1211009R0011	B6-30-01-P-01	3/17
GJL1211009R0012	B6-30-01-P-02	3/17
GJL1211009R0013	B6-30-01-P-03	3/17
GJL1211009R0101	B6-30-10-P-01	3/17
GJL1211009R0102	B6-30-10-P-02	3/17
GJL1211009R0103	B6-30-10-P-03	3/17
GJL1211009R8010	B6-30-01-P-80	3/17
GJL1211009R8014	B6-30-01-P-84	3/17
GJL1211009R8015	B6-30-01-P-85	3/17
GJL1211009R8100	B6-30-10-P-80	3/17
GJL1211009R8104	B6-30-10-P-84	3/17
GJL1211009R8105	B6-30-10-P-85	3/17
GJL1211201R0001	B6-40-00-01	3/10
GJL1211201R0002	B6-40-00-02	3/10
GJL1211201R0003	B6-40-00-03	3/10
GJL1211201R0004	B6-40-00-04	3/10
GJL1211201R8001	B6-22-00-81	3/10
GJL1211501R0002	B6-22-00-02	3/10
GJL1211501R0003	B6-22-00-03	3/10
GJL1211501R8000	B6-22-00-80	3/10
GJL1211501R8004	B6-22-00-84	3/10
GJL1211901R0011	VB6-30-01-01	3/4



# Index

## Order code classification

Order code	Type	Page	Order code	Type	Page	Order code	Type	Page
GJL1211919R0102	VB6A-30-10-P-02	3/21	GJL1213911R0017	VBC6A-30-01-07	3/7	GJL1311911R8104	VB7A-30-10-84	3/6
GJL1211919R0103	VB6A-30-10-P-03	3/21	GJL1213911R0101	VBC6A-30-10-01	3/7	GJL1311911R8105	VB7A-30-10-85	3/6
GJL1211919R8010	VB6A-30-01-P-80	3/21	GJL1213911R0103	VBC6A-30-10-03	3/7	GJL1311913R0011	VB7A-30-01-F-01	3/31
GJL1211919R8014	VB6A-30-01-P-84	3/21	GJL1213911R0104	VBC6A-30-10-04	3/7	GJL1311913R0012	VB7A-30-01-F-02	3/31
GJL1211919R8015	VB6A-30-01-P-85	3/21	GJL1213911R0105	VBC6A-30-10-05	3/7	GJL1311913R0013	VB7A-30-01-F-03	3/31
GJL1211919R8100	VB6A-30-10-P-80	3/21	GJL1213911R0107	VBC6A-30-10-07	3/7	GJL1311913R0101	VB7A-30-10-F-01	3/31
GJL1211919R8104	VB6A-30-10-P-84	3/21	GJL1213911R0106	VBC6A-30-01-16	3/7	GJL1311913R0102	VB7A-30-10-F-02	3/31
GJL1211919R8105	VB6A-30-10-P-85	3/21	GJL1213911R1106	VBC6A-30-10-16	3/7	GJL1311913R0103	VB7A-30-10-F-03	3/31
GJL1213001R0011	BC6-30-01-01	3/3	GJL1311001R0011	B7-30-01-01	3/2	GJL1311913R0104	VB7A-30-01-F-80	3/31
GJL1213001R0013	BC6-30-01-03	3/3	GJL1311001R0012	B7-30-01-02	3/2	GJL1311913R0105	VB7A-30-01-F-84	3/31
GJL1213001R0014	BC6-30-01-04	3/3	GJL1311001R0013	B7-30-01-03	3/2	GJL1311913R0106	VB7A-30-01-F-85	3/31
GJL1213001R0015	BC6-30-01-05	3/3	GJL1311001R0101	B7-30-10-01	3/2	GJL1311913R0107	VB7A-30-01-F-85	3/31
GJL1213001R0017	BC6-30-01-07	3/3	GJL1311001R0102	B7-30-10-02	3/2	GJL1311913R0108	VB7A-30-01-F-84	3/31
GJL1213001R0101	BC6-30-10-01	3/3	GJL1311001R0103	B7-30-10-03	3/2	GJL1311913R8105	VB7A-30-10-F-85	3/31
GJL1213001R0103	BC6-30-10-03	3/3	GJL1311001R8010	B7-30-01-80	3/2	GJL1311919R0011	VB7A-30-01-P-01	3/21
GJL1213001R0104	BC6-30-10-04	3/3	GJL1311001R8014	B7-30-01-84	3/2	GJL1311919R0012	VB7A-30-01-P-02	3/21
GJL1213001R0105	BC6-30-10-05	3/3	GJL1311001R8015	B7-30-01-85	3/2	GJL1311919R0013	VB7A-30-01-P-03	3/21
GJL1213001R0107	BC6-30-10-07	3/3	GJL1311001R8100	B7-30-10-80	3/2	GJL1311919R0101	VB7A-30-10-P-01	3/21
GJL1213001R1016	BC6-30-01-16	3/3	GJL1311001R8104	B7-30-10-84	3/2	GJL1311919R0102	VB7A-30-10-P-02	3/21
GJL1213001R1106	BC6-30-10-16	3/3	GJL1311001R8105	B7-30-10-85	3/2	GJL1311919R0103	VB7A-30-10-P-03	3/21
GJL1213001R5011	BC6-30-01-2.4-51	3/8	GJL1311003R0011	B7-30-01-F-01	3/27	GJL1311919R0104	VB7A-30-10-P-03	3/21
GJL1213001R5010	BC6-30-01-2.4-51	3/8	GJL1311003R0012	B7-30-01-F-02	3/27	GJL1311919R0105	VB7A-30-10-P-80	3/21
GJL1213001R7011	B6S-30-01-1.7-71	3/8	GJL1311003R0013	B7-30-01-F-03	3/27	GJL1311919R0106	VB7A-30-10-P-80	3/21
GJL1213001R7012	B6S-30-01-2.8-72	3/8	GJL1311003R0101	B7-30-10-F-01	3/27	GJL1311919R0107	VB7A-30-10-P-84	3/21
GJL1213001R7101	B6S-30-10-1.7-71	3/8	GJL1311003R0102	B7-30-10-F-02	3/27	GJL1311919R0108	VB7A-30-10-P-84	3/21
GJL1213001R7102	B6S-30-10-2.8-72	3/8	GJL1311003R0103	B7-30-10-F-03	3/27	GJL1311919R8105	VB7A-30-10-P-85	3/21
GJL1213001R8011	BC6-30-01-1.4-81	3/8	GJL1311003R8010	B7-30-01-F-80	3/27	GJL1313001R0011	BC7-30-01-01	3/3
GJL1213001R8101	BC6-30-10-1.4-81	3/8	GJL1311003R8014	B7-30-01-F-84	3/27	GJL1313001R0013	BC7-30-01-03	3/3
GJL1213003R0011	BC6-30-01-F-01	3/28	GJL1311003R8015	B7-30-01-F-85	3/27	GJL1313001R0014	BC7-30-01-04	3/3
GJL1213003R0013	BC6-30-01-F-03	3/28	GJL1311003R8100	B7-30-10-F-80	3/27	GJL1313001R0015	BC7-30-01-05	3/3
GJL1213003R0014	BC6-30-01-F-04	3/28	GJL1311003R8104	B7-30-10-F-84	3/27	GJL1313001R0017	BC7-30-01-07	3/3
GJL1213003R0015	BC6-30-01-F-05	3/28	GJL1311003R8105	B7-30-10-F-85	3/27	GJL1313001R0101	BC7-30-10-01	3/3
GJL1213003R0017	BC6-30-01-F-07	3/28	GJL13111009R0011	B7-30-01-P-01	3/17	GJL1313001R0104	BC7-30-10-04	3/3
GJL1213003R0101	BC6-30-10-F-01	3/28	GJL13111009R0012	B7-30-01-P-02	3/17	GJL1313001R0105	BC7-30-10-05	3/3
GJL1213003R0103	BC6-30-10-F-03	3/28	GJL13111009R0013	B7-30-01-P-03	3/17	GJL1313001R0107	BC7-30-10-07	3/3
GJL1213003R0104	BC6-30-10-F-04	3/28	GJL13111009R0101	B7-30-10-P-01	3/17	GJL1313001R1016	BC7-30-01-16	3/3
GJL1213003R0105	BC6-30-10-F-05	3/28	GJL13111009R0102	B7-30-10-P-02	3/17	GJL1313001R1103	BC7-30-10-03	3/3
GJL1213003R0107	BC6-30-10-F-07	3/28	GJL13111009R0103	B7-30-10-P-03	3/17	GJL1313001R1106	BC7-30-10-16	3/3
GJL1213003R1016	BC6-30-01-F-16	3/28	GJL13111009R8010	B7-30-01-P-80	3/17	GJL1313001R5011	BC7-30-01-2.4-51	3/8
GJL1213003R1106	BC6-30-10-F-16	3/28	GJL13111009R8104	B7-30-10-P-84	3/17	GJL1313001R5101	BC7-30-01-2.4-51	3/8
GJL1213003R5011	BC6-30-01-F-2.4-51	3/33	GJL13111009R8015	B7-30-01-P-85	3/17	GJL1313001R7011	B7S-30-01-1.7-71	3/8
GJL1213003R5101	BC6-30-10-F-2.4-51	3/33	GJL13111009R8100	B7-30-10-P-80	3/17	GJL1313001R7012	B7S-30-01-2.8-72	3/8
GJL1213003R8011	BC6-30-01-F-1.4-81	3/33	GJL13111009R8104	B7-30-10-P-84	3/17	GJL1313001R7101	B7S-30-01-1.7-71	3/8
GJL1213003R8101	BC6-30-10-F-1.4-81	3/33	GJL13111009R8105	B7-30-10-P-85	3/17	GJL1313001R7102	B7S-30-01-2.8-72	3/8
GJL1213009R0011	BC6-30-01-P-01	3/18	GJL13111201R0001	B7-40-00-01	3/10	GJL1313001R8011	BC7-30-01-1.4-81	3/8
GJL1213009R0013	BC6-30-01-P-03	3/18	GJL13111201R0002	B7-40-00-02	3/10	GJL1313001R8101	BC7-30-10-1.4-81	3/8
GJL1213009R0014	BC6-30-01-P-04	3/18	GJL13111201R0003	B7-40-00-03	3/10	GJL1313003R0011	BC7-30-01-F-01	3/28
GJL1213009R0015	BC6-30-01-P-05	3/18	GJL13111201R8000	B7-40-00-80	3/10	GJL1313003R0013	BC7-30-01-F-03	3/28
GJL1213009R0017	BC6-30-01-P-07	3/18	GJL13111201R8004	B7-40-00-84	3/10	GJL1313003R0014	BC7-30-01-F-04	3/28
GJL1213009R0101	BC6-30-10-P-01	3/18	GJL1311501R0001	B7-22-00-01	3/10	GJL1313003R0015	BC7-30-01-F-05	3/28
GJL1213009R0103	BC6-30-10-P-03	3/18	GJL1311501R0002	B7-22-00-02	3/10	GJL1313003R0017	BC7-30-01-F-07	3/28
GJL1213009R0104	BC6-30-10-P-04	3/18	GJL1311501R0003	B7-22-00-03	3/10	GJL1313003R0101	BC7-30-10-F-01	3/28
GJL1213009R0105	BC6-30-10-P-05	3/18	GJL1311501R8000	B7-22-00-80	3/10	GJL1313003R0103	BC7-30-10-F-03	3/28
GJL1213009R0107	BC6-30-10-P-07	3/18	GJL1311501R8004	B7-22-00-84	3/10	GJL1313003R0104	BC7-30-10-F-04	3/28
GJL1213009R1016	BC6-30-01-P-16	3/18	GJL1311901R0011	VB7-30-01-01	3/4	GJL1313003R0105	BC7-30-10-F-05	3/28
GJL1213009R1106	BC6-30-10-P-16	3/18	GJL1311901R0012	VB7-30-01-02	3/4	GJL1313003R0107	BC7-30-10-F-07	3/28
GJL1213009R5011	BC6-30-01-P-2.4-51	3/25	GJL1311901R0013	VB7-30-01-03	3/4	GJL1313003R1016	BC7-30-01-F-16	3/28
GJL1213009R5101	BC6-30-10-P-2.4-51	3/25	GJL1311901R0101	VB7-30-10-01	3/4	GJL1313003R1106	BC7-30-10-F-16	3/28
GJL1213009R8011	BC6-30-01-P-1.4-81	3/25	GJL1311901R0102	VB7-30-10-02	3/4	GJL1313003R5011	BC7-30-01-F-2.4-51	3/33
GJL1213009R8101	BC6-30-10-P-1.4-81	3/25	GJL1311901R0103	VB7-30-10-03	3/4	GJL1313003R5101	BC7-30-10-F-2.4-51	3/33
GJL1213109R0101	BC6-21-10-P-01	3/18	GJL1311901R8010	VB7-30-01-80	3/4	GJL1313003R8011	BC7-30-01-F-1.4-81	3/33
GJL1213109R0103	BC6-21-10-P-03	3/18	GJL1311901R8014	VB7-30-01-84	3/4	GJL1313003R8101	BC7-30-10-F-1.4-81	3/33
GJL1213109R0104	BC6-21-10-P-04	3/18	GJL1311901R8015	VB7-30-01-85	3/4	GJL1313009R0011	BC7-30-01-P-01	3/18
GJL1213109R0105	BC6-21-10-P-05	3/18	GJL1311901R8100	VB7-30-10-80	3/4	GJL1313009R0013	BC7-30-01-P-03	3/18
GJL1213109R1106	BC6-21-10-P-16	3/18	GJL1311901R8104	VB7-30-10-84	3/4	GJL1313009R0014	BC7-30-01-P-04	3/18
GJL1213501R0001	BC6-22-00-01	3/11	GJL1311901R8105	VB7-30-10-85	3/4	GJL1313009R0015	BC7-30-01-P-05	3/18
GJL1213501R0002	BC6-22-00-02	3/11	GJL1311903R0011	VB7-30-01-F-01	3/29	GJL1313009R0017	BC7-30-01-P-07	3/18
GJL1213501R0003	BC6-22-00-03	3/11	GJL1311903R0012	VB7-30-01-F-02	3/29	GJL1313009R0101	BC7-30-10-P-01	3/18
GJL1213501R0004	BC6-22-00-04	3/11	GJL1311903R0013	VB7-30-01-F-03	3/29	GJL1313009R0103	BC7-30-10-P-03	3/18
GJL1213501R0005	BC6-22-00-05	3/11	GJL1311903R0101	VB7-30-10-F-01	3/29	GJL1313009R0104	BC7-30-10-P-04	3/18
GJL1213501R0007	BC6-22-00-07	3/11	GJL1311903R0102	VB7-30-10-F-02	3/29	GJL1313009R0105	BC7-30-10-P-05	3/18
GJL1213501R1006	BC6-22-00-16	3/11	GJL1311903R0103	VB7-30-10-F-03	3/29	GJL1313009R0107	BC7-30-10-P-07	3/18
GJL1213901R0011	VBC6-30-01-01	3/5	GJL1311903R8010	VB7-30-01-F-80	3/29	GJL1313009R1016	BC7-30-01-P-16	3/18
GJL1213901R0013	VBC6-30-01-03	3/5	GJL1311903R8014	VB7-30-01-F-84	3/29	GJL1313009R1106	BC7-30-01-P-16	3/18
GJL1213901R0014	VBC6-30-01-04	3/5	GJL1311903R8015	VB7-30-01-F-85	3/29	GJL1313009R5011	BC7-30-01-P-2.4-51	3/25
GJL1213901R0015	VBC6-30-01-05	3/5	GJL1311903R8100	VB7-30-10-F-80	3/29	GJL1313009R5101	BC7-30-10-P-2.4-51	3/25
GJL1213901R0017	VBC6-30-01-07	3/5	GJL1311903R8104	VB7-30-10-F-84	3/29	GJL1313009R8011	BC7-30-01-P-1.4-81	3/25
GJL1213901R0101	VBC6-30-10-01	3/5	GJL1311903R8105	VB7-30-10-F-85	3/29	GJL1313061R5015	TBC7-30-01-55	3/9
GJL1213901R0103	VBC6-30-10-03	3/5	GJL1311909R0011	VB7-30-01-P-01	3/19	GJL1313061R5101	TBC7-30-01-51	3/9
GJL1213901R0104	VBC6-30-10-04	3/5	GJL1311909R0012	VB7-30-01-P-02	3/19	GJL1313061R5105	TBC7-30-10-55	3/9
GJL1213901R0105	VBC6-30-10-05	3/5	GJL1311909R0013	VB7-30-01-P-03	3/19	GJL1313061R6012	TBC7-30-01-62	3/9
GJL12139								

# Index

## Order code classification

Order code	Type	Page	Order code	Type	Page	Order code	Type	Page
GJL1313901R0105	VBC7-30-10-05	3/5	SK824441-AR	EK150-40-11	5/108	SK825451-AR	EK210-40-22	5/115
GJL1313901R0107	VBC7-30-10-07	3/5	SK824441-DA	EK150-40-21	5/109	SK826400-AD	KH300	5/265
GJL1313901R1016	VBC7-30-01-16	3/5	SK824441-DB	EK150-40-21	5/109	SK826400-AE	KH300	5/265
GJL1313901R1106	VBC7-30-10-16	3/5	SK824441-DC	EK150-40-21	5/109	SK826400-AF	KH300	5/265
GJL1313903R0011	VBC7-30-01-F-01	3/30	SK824441-DD	EK150-40-21	5/109	SK826400-AL	KH300	5/265
GJL1313903R0013	VBC7-30-01-F-03	3/30	SK824441-DE	EK150-40-21	5/109	SK826400-AM	KH300	5/265
GJL1313903R0014	VBC7-30-01-F-04	3/30	SK824441-DF	EK150-40-21	5/109	SK826400-AN	KH300	5/265
GJL1313903R0015	VBC7-30-01-F-05	3/30	SK824441-DG	EK150-40-21	5/109	SK826400-AP	KH300	5/265
GJL1313903R0017	VBC7-30-01-F-07	3/30	SK824441-DT	EK150-40-21	5/109	SK826400-AR	KH300	5/265
GJL1313903R0101	VBC7-30-10-F-01	3/30	SK824441-DU	EK150-40-21	5/109	SK826450-DA	KP300	5/266
GJL1313903R0103	VBC7-30-10-F-03	3/30	SK824450-AD	EK110-40-22	5/114	SK826450-DB	KP300	5/266
GJL1313903R0104	VBC7-30-10-F-04	3/30	SK824450-AE	EK110-40-22	5/114	SK826450-DC	KP300	5/266
GJL1313903R0105	VBC7-30-10-F-05	3/30	SK824450-AF	EK110-40-22	5/114	SK826450-DD	KP300	5/266
GJL1313903R0107	VBC7-30-10-F-07	3/30	SK824450-AL	EK110-40-22	5/114	SK826450-DE	KP300	5/266
GJL1313903R1016	VBC7-30-01-F-16	3/30	SK824450-AM	EK110-40-22	5/114	SK826450-DF	KP300	5/266
GJL1313903R1106	VBC7-30-10-F-16	3/30	SK824450-AN	EK110-40-22	5/114	SK826450-DG	KP300	5/266
GJL1313909R0011	VBC7-30-01-P-01	3/20	SK824450-AP	EK110-40-22	5/114	SK826450-DT	KP300	5/266
GJL1313909R0013	VBC7-30-01-P-03	3/20	SK824450-AR	EK110-40-22	5/114	SK826450-DU	KP300	5/266
GJL1313909R0014	VBC7-30-01-P-04	3/20	SK824451-AD	EK150-40-22	5/114	SK826450-EF	KP300	5/266
GJL1313909R0015	VBC7-30-01-P-05	3/20	SK824451-AE	EK150-40-22	5/114	SK826450-EG	KP300	5/266
GJL1313909R0017	VBC7-30-01-P-07	3/20	SK824451-AF	EK150-40-22	5/114	SK826450-EL	KP300	5/266
GJL1313909R0101	VBC7-30-10-P-01	3/20	SK824451-AL	EK150-40-22	5/114	SK826450-EM	KP300	5/266
GJL1313909R0103	VBC7-30-10-P-03	3/20	SK824451-AM	EK150-40-22	5/114	SK826450-EP	KP300	5/266
GJL1313909R0104	VBC7-30-10-P-04	3/20	SK824451-AN	EK150-40-22	5/114	SK826450-ER	KP300	5/266
GJL1313909R0105	VBC7-30-10-P-05	3/20	SK824451-AP	EK150-40-22	5/114	SK827040-AD	EK370-40-11	5/110
GJL1313909R0107	VBC7-30-10-P-07	3/20	SK824451-AR	EK150-40-22	5/114	SK827040-AR	EK370-40-11	5/110
GJL1313909R1016	VBC7-30-01-P-16	3/20	SK825204-A	KZK175	5/264	SK827040-DB	EK370-40-21	5/111
GJL1313909R1106	VBC7-30-10-P-16	3/20	SK825204-B	KZK210	5/264	SK827040-DC	EK370-40-21	5/111
GJL1313911R0011	VBC7A-30-01-01	3/7	SK825400-AD	KH210	5/265	SK827040-DD	EK370-40-21	5/111
GJL1313911R0013	VBC7A-30-01-03	3/7	SK825400-AE	KH210	5/265	SK827040-DE	EK370-40-21	5/111
GJL1313911R0014	VBC7A-30-01-04	3/7	SK825400-AF	KH210	5/265	SK827040-DF	EK370-40-21	5/111
GJL1313911R0015	VBC7A-30-01-05	3/7	SK825400-AL	KH210	5/265	SK827040-DG	EK370-40-21	5/111
GJL1313911R0016	VBC7A-30-01-16	3/7	SK825400-AM	KH210	5/265	SK827040-DT	EK370-40-21	5/111
GJL1313911R0017	VBC7A-30-01-07	3/7	SK825400-AN	KH210	5/265	SK827040-DU	EK370-40-21	5/111
GJL1313911R0101	VBC7A-30-10-01	3/7	SK825400-AP	KH210	5/265	SK827040-EF	EK370-40-11	5/110
GJL1313911R0103	VBC7A-30-10-03	3/7	SK825400-AR	KH210	5/265	SK827040-EG	EK370-40-11	5/110
GJL1313911R0104	VBC7A-30-10-04	3/7	SK825440-AD	EK175-40-11	5/110	SK827040-EL	EK370-40-11	5/110
GJL1313911R0105	VBC7A-30-10-05	3/7	SK825440-AE	EK175-40-11	5/110	SK827040-EM	EK370-40-11	5/110
GJL1313911R0107	VBC7A-30-10-07	3/7	SK825440-AF	EK175-40-11	5/110	SK827040-EP	EK370-40-11	5/110
GJL1313911R1106	VBC7A-30-10-16	3/7	SK825440-AL	EK175-40-11	5/110	SK827040-ER	EK370-40-11	5/110
GJL1313913R0011	VBC7A-30-01-F-01	3/32	SK825440-AM	EK175-40-11	5/110	SK827041-AD	EK550-40-11	5/110
GJL1313913R0013	VBC7A-30-01-F-03	3/32	SK825440-AN	EK175-40-11	5/110	SK827041-AR	EK550-40-11	5/110
GJL1313913R0014	VBC7A-30-01-F-04	3/32	SK825440-AP	EK175-40-11	5/110	SK827041-DB	EK550-40-21	5/111
GJL1313913R0015	VBC7A-30-01-F-05	3/32	SK825440-AR	EK175-40-11	5/110	SK827041-DC	EK550-40-21	5/111
GJL1313913R0017	VBC7A-30-01-F-07	3/32	SK825440-DA	EK175-40-21	5/111	SK827041-DD	EK550-40-21	5/111
GJL1313913R0101	VBC7A-30-10-F-01	3/32	SK825440-DB	EK175-40-21	5/111	SK827041-DE	EK550-40-21	5/111
GJL1313913R0103	VBC7A-30-10-F-03	3/32	SK825440-DC	EK175-40-21	5/111	SK827041-DF	EK550-40-21	5/111
GJL1313913R0104	VBC7A-30-10-F-04	3/32	SK825440-DD	EK175-40-21	5/111	SK827041-DG	EK550-40-21	5/111
GJL1313913R0105	VBC7A-30-10-F-05	3/32	SK825440-DE	EK175-40-21	5/111	SK827041-DT	EK550-40-21	5/111
GJL1313913R0107	VBC7A-30-10-F-07	3/32	SK825440-DF	EK175-40-21	5/111	SK827041-DU	EK550-40-21	5/111
GJL1313913R1016	VBC7A-30-01-F-16	3/32	SK825440-DG	EK175-40-21	5/111	SK827041-EF	EK550-40-11	5/110
GJL1313913R1106	VBC7A-30-10-F-16	3/32	SK825440-DH	EK175-40-21	5/111	SK827041-EG	EK550-40-11	5/110
GJL1313919R0011	VBC7A-30-01-P-01	3/22	SK825440-DI	EK175-40-21	5/111	SK827041-EL	EK550-40-11	5/110
GJL1313919R0013	VBC7A-30-01-P-03	3/22	SK825441-AD	EK210-40-11	5/110	SK827041-EM	EK550-40-11	5/110
GJL1313919R0014	VBC7A-30-01-P-04	3/22	SK825441-AE	EK210-40-11	5/110	SK827041-EP	EK550-40-11	5/110
GJL1313919R0015	VBC7A-30-01-P-05	3/22	SK825441-AF	EK210-40-11	5/110	SK827041-ER	EK550-40-11	5/110
GJL1313919R0017	VBC7A-30-01-P-07	3/22	SK825441-AL	EK210-40-11	5/110	SK827042-AD	EK370-40-22	5/115
GJL1313919R0101	VBC7A-30-10-P-01	3/22	SK825441-AM	EK210-40-11	5/110	SK827042-AR	EK370-40-22	5/115
GJL1313919R0103	VBC7A-30-10-P-03	3/22	SK825441-AN	EK210-40-11	5/110	SK827042-EF	EK370-40-22	5/115
GJL1313919R0104	VBC7A-30-10-P-04	3/22	SK825441-AP	EK210-40-11	5/110	SK827042-EG	EK370-40-22	5/115
GJL1313919R0105	VBC7A-30-10-P-05	3/22	SK825441-AR	EK210-40-11	5/110	SK827042-EL	EK370-40-22	5/115
GJL1313919R0107	VBC7A-30-10-P-07	3/22	SK825441-DA	EK210-40-21	5/111	SK827042-EM	EK370-40-22	5/115
GJL1313919R0106	VBC7A-30-01-P-16	3/22	SK825441-DB	EK210-40-21	5/111	SK827042-EP	EK370-40-22	5/115
GJL1313919R1106	VBC7A-30-10-P-16	3/22	SK825441-DC	EK210-40-21	5/111	SK827042-ER	EK370-40-22	5/115
GJL1317001R0011	B7D-30-01-01	3/3	SK825441-DD	EK210-40-21	5/111	SK827042-AR	EK370-40-22	5/115
GJL1317001R0015	B7D-30-01-05	3/3	SK825441-DE	EK210-40-21	5/111	SK827043-AD	EK550-40-22	5/115
GJL1317001R0101	B7D-30-10-01	3/3	SK825441-DF	EK210-40-21	5/111	SK827043-AR	EK550-40-22	5/115
GJL1317001R0105	B7D-30-10-05	3/3	SK825441-DG	EK210-40-21	5/111	SK827043-EF	EK550-40-22	5/115
GJL1317201R0001	B7D-40-00-01	3/11	SK825441-DH	EK210-40-21	5/111	SK827043-EG	EK550-40-22	5/115
GJL1317201R0005	B7D-40-00-05	3/11	SK825441-DI	EK210-40-21	5/111	SK827043-EL	EK550-40-22	5/115
SK178001-HB	LT150-EK	5/262	SK825441-DJ	EK210-40-21	5/111	SK827043-EM	EK550-40-22	5/115
SK178001-KB	LT210-EK	5/262	SK825448-AD	EK175-40-22	5/115	SK827043-EP	EK550-40-22	5/115
SK178001-LB	LT550-EK	5/262	SK825448-AE	EK175-40-22	5/115	SK827043-ER	EK550-40-22	5/115
SK178001-MB	LT1000-EK	5/262	SK825448-AF	EK175-40-22	5/115	SK827044-AD	EK1000-40-11	5/112
SK824204-A	KZK110	5/264	SK825448-AL	EK175-40-22	5/115	SK827044-AR	EK1000-40-11	5/112
SK824204-B	KZK150	5/264	SK825448-AM	EK175-40-22	5/115	SK827044-DB	EK1000-40-21	5/113
SK824440-AD	EK110-40-11	5/108	SK825448-AN	EK175-40-22	5/115	SK827044-DC	EK1000-40-21	5/113
SK824440-AE	EK110-40-11	5/108	SK825448-AR	EK175-40-22	5/115	SK827044-DD	EK1000-40-21	5/113
SK824440-AF	EK110-40-11	5/108	SK825450-DA	KP210	5/266	SK827044-DE	EK1000-40-21	5/113
SK824440-AL	EK110-40-11	5/108	SK825450-DB	KP210	5/266	SK827044-DF	EK1000-40-21	5/113
SK824440-AM	EK110-40-11	5/108	SK825450-DC	KP210	5/266	SK827044-DG	EK1000-40-21	5/113
SK824440-AN	EK110-40-11	5/108	SK825450-DD	KP210	5/266	SK827044-DT	EK1000-40-21	5/113
SK824440-AP	EK110-40-11	5/108	SK825450-DE	KP210	5/266	SK827044-DU	EK1000-40-21	5/113
SK824440-AR	EK110-40-11	5/108	SK825450-DF	KP210	5/266	SK827044-EF	EK1000-40-11	5/112
SK824440-DA	EK110-40-21	5/109	SK825450-DG	KP210	5/266	SK827044-EG	EK1000-40-11	5/112
SK824440-DB	EK110-40-21	5/109	SK825450-DH	KP210	5/266	SK827044-EL	EK1000-40-11	5/112
SK824440-DC	EK110-40-21	5/109	SK825450-DI	KP210	5/266	SK827044-EM	EK1000-40-11	5/112
SK824440-DD	EK110-40-21	5/109	SK825450-EF	KP210	5/266	SK827044-EP	EK1000-40-11	5/112
SK824440-DE	EK110-40-21	5/109	SK825450-EG	KP210	5/266	SK827044-ER	EK1000-40-11	5/112
SK824440-DF	EK110-40-21	5/109	SK825450-EH	KP210	5/266	SK827045-AD	EK1000-40-22	5/116
SK824440-DG	EK110-40-21	5/109	SK825450-EI	KP210	5/266	SK827045-AR	EK1000-40-22	5/116
SK824440-DT	EK110-40-21	5/109	SK825450-EJ	KP210	5/266	SK827045-EF	EK1000-40-22	5/116
SK824440-DU	EK110-40-21	5/109	SK825450-EK	KP210	5/266	SK827045-EG	EK1000-40-22	5/116
SK824441-AD	EK150-40-11	5/108	SK825450-EL	KP210	5/266	SK827045-EL	EK1000-40-22	5/116
SK824441-AE	EK150-40-11	5/108	SK825451-AD	EK210-40-22	5/115	SK827045-EM	EK1000-40-22	5/116
SK824441-AF	EK150-40-11	5/108	SK825451-AE	EK210-40-22	5/115	SK827045-EP	EK1000-40-22	5/116
SK824441-AL	EK150-40-11	5/108	SK825451-AF	EK210-40-22	5/115	SK827045-ER	EK1000-40-22	5/116
SK824441-AM	EK150-40-11	5/108	SK825451-AL	EK210-40-22	5/115	SK827204-A	KZK370	5/264
SK824441-AN	EK150-40-11	5/108	SK825451-AM	EK210-40-22	5/115	SK827204-B	KZK550	5/264
SK824441-AP	EK150-40-11	5/108	SK8					

# Index

## Order code classification

Order code	Type	Page	Order code	Type	Page	Order code	Type	Page
SK828100-AR	KH800	5/265						
SK828100-EF	KH800	5/265						
SK828100-EG	KH800	5/265						
SK828100-EL	KH800	5/265						
SK828100-EM	KH800	5/265						
SK828100-EP	KH800	5/265						
SK828100-ER	KH800	5/265						
SK828150-DB	KP800	5/266						
SK828150-DC	KP800	5/266						
SK828150-DD	KP800	5/266						
SK828150-DE	KP800	5/266						
SK828150-DF	KP800	5/266						
SK828150-DG	KP800	5/266						
SK828150-DT	KP800	5/266						
SK828150-DU	KP800	5/266						
SK829002-A	CAL16-11A	5/254						
SK829002-B	CAL16-11B	5/119						
SK829002-C	CAL16-11C	5/119						
SK829002-D	CAL16-11D	5/119						
SK829002-E	CCL16-11E	5/119						
SK829007-A	RC-EH300/48	5/119						
SK829007-B	RC-EH300/415	5/119						
SK829007-C	RC-EH800/110	5/119						
SK829007-D	RC-EH800/600	5/119						
SK829070-F	VH800	5/119						
SK829071-A	VH145	5/119						
SK829071-B	VH300	5/119						
SK829075-C	PN210-22	5/263						
SK829075-E	PN300-22	5/263						
SK829090-B	BSS100	5/119						
SK829090-E	BSS550	5/119						
SK829090-F	BSS145	5/119						
SK829090-G	BSS210	5/119						
SK829090-H	BSS1000	5/119						



# Index

## Type classification

Type	Order code	Page	Type	Order code	Page	Type	Order code	Page
A45-22-00	1SBL331501R8000	5/99	AF09-30-10S-13	1SBL137004R1310	6/42	AF12Z-30-01-23	1SBL156001R2301	5/7
	1SBL331501R8100	5/99	AF09-30-10S-14	1SBL137004R1410	6/42	AF12Z-30-01S-20	1SBL156004R2001	6/43
	1SBL331501R8300	5/99	AF09-30-10S-41	1SBL137004R4110	6/42	AF12Z-30-01S-21	1SBL156004R2101	6/43
	1SBL331501R8400	5/99	AF09-30-22-12	1SBL137001R1222	5/24	AF12Z-30-01S-22	1SBL156004R2201	6/43
	1SBL331501R8500	5/99	AF09-30-22-13	1SBL137001R1322	5/24	AF12Z-30-01S-23	1SBL156004R2301	6/43
	1SBL331501R8600	5/99	AF09-30-22-14	1SBL137001R1422	5/24	AF12Z-30-10-20	1SBL156001R2010	5/7
	1SBL331501R8800	5/99	AF09-30-22-41	1SBL137001R4122	5/24	AF12Z-30-10-21	1SBL156001R2110	5/7
A45-40-00	1SBL331201R8000	5/99	AF09-30-22S-12	1SBL137004R1222	6/44	AF12Z-30-10-22	1SBL156001R2210	5/7
	1SBL331201R8100	5/99	AF09-30-22S-13	1SBL137004R1322	6/44	AF12Z-30-10-23	1SBL156001R2310	5/7
	1SBL331201R8300	5/99	AF09-30-22S-14	1SBL137004R1422	6/44	AF12Z-30-10S-20	1SBL156004R2010	6/43
	1SBL331201R8400	5/99	AF09-30-22S-41	1SBL137004R4122	6/44	AF12Z-30-10S-21	1SBL156004R2110	6/43
	1SBL331201R8500	5/99	AF09-40-00-12	1SBL137201R1200	5/94	AF12Z-30-10S-22	1SBL156004R2210	6/43
	1SBL331201R8600	5/99	AF09-40-00-13	1SBL137201R1300	5/94	AF12Z-30-10S-23	1SBL156004R2310	6/43
	1SBL331201R8800	5/99	AF09-40-00-14	1SBL137201R1400	5/94	AF12Z-30-22-20	1SBL156001R2022	5/25
A50-40-00	1SBL351201R8000	5/99	AF09-40-00-41	1SBL137201R4100	5/94	AF12Z-30-22-21	1SBL156001R2122	5/25
	1SBL351201R8100	5/99	AF09Z-22-00-20	1SBL136501R2000	5/95	AF12Z-30-22-22	1SBL156001R2222	5/25
	1SBL351201R8300	5/99	AF09Z-22-00-21	1SBL136501R2100	5/95	AF12Z-30-22-23	1SBL156001R2322	5/25
	1SBL351201R8400	5/99	AF09Z-22-00-22	1SBL136501R2200	5/95	AF12Z-30-22S-20	1SBL156004R2022	6/45
	1SBL351201R8500	5/99	AF09Z-22-00-23	1SBL136501R2300	5/95	AF12Z-30-22S-21	1SBL156004R2122	6/45
	1SBL351201R8600	5/99	AF09Z-30-01-20	1SBL136001R2001	5/7	AF12Z-30-22S-22	1SBL156004R2222	6/45
	1SBL351201R8800	5/99	AF09Z-30-01-21	1SBL136001R2101	5/7	AF12Z-30-22S-23	1SBL156004R2322	6/45
A75-22-00	1SBL411501R8000	5/99	AF09Z-30-01-22	1SBL136001R2201	5/7	AF1350-30-11	1SFL657001R7011	5/21
	1SBL411501R8100	5/99	AF09Z-30-01-23	1SBL136001R2301	5/7	AF1350-30-22	1SFL657001R7022	5/35
	1SBL411501R8300	5/99	AF09Z-30-01S-20	1SBL136004R2001	6/43	AF140-30-00-11	1SFL447001R1100	5/12
	1SBL411501R8400	5/99	AF09Z-30-01S-21	1SBL136004R2101	6/43	AF140-30-00-12	1SFL447001R1200	5/12
	1SBL411501R8500	5/99	AF09Z-30-01S-22	1SBL136004R2201	6/43	AF140-30-00-13	1SFL447001R1300	5/12
	1SBL411501R8600	5/99	AF09Z-30-01S-23	1SBL136004R2301	6/43	AF140-30-00B-11	1SFL447002R1100	5/12
	1SBL411501R8800	5/99	AF09Z-30-10-20	1SBL136001R2010	5/7	AF140-30-00B-12	1SFL447002R1200	5/12
A75-40-00	1SBL411201R8000	5/99	AF09Z-30-10-21	1SBL136001R2110	5/7	AF140-30-00B-13	1SFL447002R1300	5/12
	1SBL411201R8100	5/99	AF09Z-30-10-22	1SBL136001R2210	5/7	AF140-30-11-11	1SFL447001R1111	5/16
	1SBL411201R8300	5/99	AF09Z-30-10-23	1SBL136001R2310	5/7	AF140-30-11-12	1SFL447001R1211	5/16
	1SBL411201R8400	5/99	AF09Z-30-10S-20	1SBL136004R2010	6/43	AF140-30-11-13	1SFL447001R1311	5/16
	1SBL411201R8500	5/99	AF09Z-30-10S-21	1SBL136004R2110	6/43	AF140-30-11B-11	1SFL447002R1111	5/16
	1SBL411201R8600	5/99	AF09Z-30-10S-22	1SBL136004R2210	6/43	AF140-30-11B-12	1SFL447002R1211	5/16
	1SBL411201R8800	5/99	AF09Z-30-10S-23	1SBL136004R2310	6/43	AF140-30-11B-13	1SFL447002R1311	5/16
AA1-110	1SAM201910R1002	2/9	AF09Z-30-22-20	1SBL136001R2022	5/25	AF140-30-22-11	1SFL447001R1122	5/30
AA1-230	1SAM201910R1003	2/9	AF09Z-30-22-21	1SBL136001R2122	5/25	AF140-30-22-12	1SFL447001R1222	5/30
AA1-24	1SAM201910R1001	2/9	AF09Z-30-22-22	1SBL136001R2222	5/25	AF140-30-22-13	1SFL447001R1322	5/30
AA1-400	1SAM201910R1004	2/9	AF09Z-30-22-23	1SBL136001R2322	5/25	AF140-30-22B-11	1SFL447002R1122	5/30
AA4-110	1SAM401907R1002	2/43	AF09Z-30-22S-20	1SBL136004R2022	6/45	AF140-30-22B-12	1SFL447002R1222	5/30
AA4-230	1SAM401907R1003	2/43	AF09Z-30-22S-21	1SBL136004R2122	6/45	AF140-30-22B-13	1SFL447002R1322	5/30
AA4-24	1SAM401907R1001	2/43	AF09Z-30-22S-22	1SBL136004R2222	6/45	AF146-30-00-11	1SFL467001R1100	5/12
AA4-400	1SAM401907R1004	2/43	AF09Z-30-22S-23	1SBL136004R2322	6/45	AF146-30-00-12	1SFL467001R1200	5/12
AE45-22-00	1SBL339501R8000	5/100	AF09Z-40-00-20	1SBL136201R2000	5/95	AF146-30-00-13	1SFL467001R1300	5/12
	1SBL339501R8100	5/100	AF09Z-40-00-21	1SBL136201R2100	5/95	AF146-30-00B-11	1SFL467002R1100	5/12
	1SBL339501R8300	5/100	AF09Z-40-00-22	1SBL136201R2200	5/95	AF146-30-00B-12	1SFL467002R1200	5/12
	1SBL339501R8400	5/100	AF09Z-40-00-23	1SBL136201R2300	5/95	AF146-30-00B-13	1SFL467002R1300	5/12
	1SBL339501R8600	5/100	AF116-30-00-11	1SFL427001R1100	5/12	AF146-30-11-11	1SFL467001R1111	5/16
	1SBL339501R8700	5/100	AF116-30-00-12	1SFL427001R1200	5/12	AF146-30-11-12	1SFL467001R1211	5/16
	1SBL339501R8800	5/100	AF116-30-00-13	1SFL427001R1300	5/12	AF146-30-11-13	1SFL467001R1311	5/16
	1SBL339501R8900	5/100	AF116-30-00B-11	1SFL427002R1100	5/12	AF146-30-11B-11	1SFL467002R1111	5/16
AE45-40-00	1SBL339201R8000	5/100	AF116-30-00B-12	1SFL427002R1200	5/12	AF146-30-11B-12	1SFL467002R1211	5/16
	1SBL339201R8100	5/100	AF116-30-00B-13	1SFL427002R1300	5/12	AF146-30-11B-13	1SFL467002R1311	5/16
	1SBL339201R8300	5/100	AF116-30-11-11	1SFL427001R1111	5/16	AF146-30-22-11	1SFL467001R1122	5/30
	1SBL339201R8400	5/100	AF116-30-11-12	1SFL427001R1211	5/16	AF146-30-22-12	1SFL467001R1222	5/30
	1SBL339201R8600	5/100	AF116-30-11-13	1SFL427001R1311	5/16	AF146-30-22-13	1SFL467001R1322	5/30
	1SBL339201R8700	5/100	AF116-30-11B-11	1SFL427002R1111	5/16	AF146-30-22-14	1SFL467001R1422	5/30
	1SBL339201R8800	5/100	AF116-30-11B-12	1SFL427002R1211	5/16	AF146-30-22B-11	1SFL467002R1122	5/30
	1SBL339201R8900	5/100	AF116-30-11B-13	1SFL427002R1311	5/16	AF146-30-22B-12	1SFL467002R1222	5/30
AE50-40-00	1SBL359201R8000	5/100	AF116-30-22-11	1SFL427001R1122	5/30	AF146-30-22B-13	1SFL467002R1322	5/30
	1SBL359201R8100	5/100	AF116-30-22-12	1SFL427001R1222	5/30	AF16-22-00-12	1SFL177501R1200	5/94
	1SBL359201R8300	5/100	AF116-30-22-13	1SFL427001R1322	5/30	AF16-22-00-13	1SFL177501R1300	5/94
	1SBL359201R8400	5/100	AF116-30-22B-11	1SFL427002R1122	5/30	AF16-22-00-14	1SFL177501R1400	5/94
	1SBL359201R8600	5/100	AF116-30-22B-12	1SFL427002R1222	5/30	AF16-22-00-41	1SFL177501R4100	5/94
	1SBL359201R8700	5/100	AF116-30-22B-13	1SFL427002R1322	5/30	AF16-30-01-12	1SFL177001R1201	5/6
	1SBL359201R8800	5/100	AF12-30-01-12	1SBL157001R1201	5/6	AF16-30-01-13	1SFL177001R1301	5/6
	1SBL359201R8900	5/100	AF12-30-01-13	1SBL157001R1301	5/6	AF16-30-01-14	1SFL177001R1401	5/6
AE75-22-00	1SBL419501R8000	5/100	AF12-30-01-14	1SBL157001R1401	5/6	AF16-30-01-41	1SFL177001R4101	5/6
	1SBL419501R8100	5/100	AF12-30-01-41	1SBL157001R4101	5/6	AF16-30-01S-12	1SFL177004R1201	6/42
	1SBL419501R8300	5/100	AF12-30-01S-12	1SBL157004R1201	6/42	AF16-30-01S-13	1SFL177004R1301	6/42
	1SBL419501R8400	5/100	AF12-30-01S-13	1SBL157004R1301	6/42	AF16-30-01S-14	1SFL177004R1401	6/42
	1SBL419501R8600	5/100	AF12-30-01S-41	1SBL157004R4101	6/42	AF16-30-01S-41	1SFL177004R4101	6/42
	1SBL419501R8700	5/100	AF12-30-01S-41	1SBL157004R4101	6/42	AF16-30-10-12	1SFL177001R1210	5/6
	1SBL419501R8800	5/100	AF12-30-10-12	1SBL157001R1210	5/6	AF16-30-10-13	1SFL177001R1310	5/6
	1SBL419501R8900	5/100	AF12-30-10-13	1SBL157001R1310	5/6	AF16-30-10-14	1SFL177001R1410	5/6
AE75-40-00	1SBL419201R8000	5/100	AF12-30-10-14	1SBL157001R1410	5/6	AF16-30-10-41	1SFL177001R4110	5/6
	1SBL419201R8100	5/100	AF12-30-10-41	1SBL157001R4110	5/6	AF16-30-10S-12	1SFL177004R1210	6/42
	1SBL419201R8300	5/100	AF12-30-10S-12	1SBL157004R1210	6/42	AF16-30-10S-13	1SFL177004R1310	6/42
	1SBL419201R8400	5/100	AF12-30-10S-13	1SBL157004R1310	6/42	AF16-30-10S-14	1SFL177004R1410	6/42
	1SBL419201R8600	5/100	AF12-30-10S-14	1SBL157004R1410	6/42	AF16-30-10S-41	1SFL177004R4110	6/42
	1SBL419201R8700	5/100	AF12-30-10S-41	1SBL157004R4101	6/42	AF16-30-22-12	1SFL177001R1222	5/24
	1SBL419201R8800	5/100	AF12-30-22-12	1SBL157001R1222	5/24	AF16-30-22-13	1SFL177001R1322	5/24
	1SBL419201R8900	5/100	AF12-30-22-13	1SBL157001R1322	5/24	AF16-30-22-14	1SFL177001R1422	5/24
AF09-22-00-12	1SBL137501R1200	5/94	AF12-30-22-14	1SBL157001R1422	5/24	AF16-30-22S-12	1SFL177004R1222	6/44
AF09-22-00-13	1SBL137501R1300	5/94	AF12-30-22-41	1SBL157001R4122	5/24	AF16-30-22S-13	1SFL177004R1322	6/44
AF09-22-00-14	1SBL137501R1400	5/94	AF12-30-22S-12	1SBL157004R1222	6/44	AF16		

# Index

## Type classification

Type	Order code	Page	Type	Order code	Page	Type	Order code	Page
AF16Z-30-01-22	1SBL176001R2201	5/7	AF26Z-30-00S-23	1SBL236004R2300	6/43	AF38Z-40-00-21	1SBL296201R2100	5/95
AF16Z-30-01-23	1SBL176001R2301	5/7	AF26Z-30-11-20	1SBL236001R2011	5/25	AF38Z-40-00-22	1SBL296201R2200	5/95
AF16Z-30-01S-20	1SBL176004R2001	6/43	AF26Z-30-11-21	1SBL236001R2111	5/25	AF38Z-40-00-23	1SBL296201R2300	5/95
AF16Z-30-01S-21	1SBL176004R2101	6/43	AF26Z-30-11-22	1SBL236001R2211	5/25	AF400-30-11	1SFL577001R6811	5/20
AF16Z-30-01S-22	1SBL176004R2201	6/43	AF26Z-30-11-23	1SBL236001R2311	5/25		1SFL577001R6911	5/20
AF16Z-30-01S-23	1SBL176004R2301	6/43	AF26Z-30-11S-20	1SBL236004R2011	6/45		1SFL577001R7011	5/20
AF16Z-30-10-20	1SBL176001R2010	5/7	AF26Z-30-11S-21	1SBL236004R2111	6/45		1SFL577001R7111	5/20
AF16Z-30-10-21	1SBL176001R2110	5/7	AF26Z-30-11S-22	1SBL236004R2211	6/45	AF400-30-22	1SFL577001R6822	5/34
AF16Z-30-10-22	1SBL176001R2210	5/7	AF26Z-30-11S-23	1SBL236004R2311	6/45		1SFL577001R6922	5/34
AF16Z-30-10-23	1SBL176001R2310	5/7	AF26Z-30-22-20	1SBL236001R2022	5/25		1SFL577001R7022	5/34
AF16Z-30-10S-20	1SBL176004R2010	6/43	AF26Z-30-22-21	1SBL236001R2122	5/25		1SFL577001R7122	5/34
AF16Z-30-10S-21	1SBL176004R2110	6/43	AF26Z-30-22-22	1SBL236001R2222	5/25	AF40-30-00-11	1SBL347001R1100	5/8
AF16Z-30-10S-22	1SBL176004R2210	6/43	AF26Z-30-22-23	1SBL236001R2322	5/25	AF40-30-00-12	1SBL347001R1200	5/8
AF16Z-30-10S-23	1SBL176004R2310	6/43	AF26Z-30-22S-20	1SBL236004R2022	6/45	AF40-30-00-13	1SBL347001R1300	5/8
AF16Z-30-22-20	1SBL176001R2022	5/25	AF26Z-30-22S-21	1SBL236004R2122	6/45	AF40-30-00-14	1SBL347001R1400	5/8
AF16Z-30-22-21	1SBL176001R2122	5/25	AF26Z-30-22S-22	1SBL236004R2222	6/45	AF40-30-00-41	1SBL347001R4100	5/8
AF16Z-30-22-22	1SBL176001R2222	5/25	AF26Z-30-22S-23	1SBL236004R2322	6/45	AF40-30-11-11	1SBL347001R1111	5/26
AF16Z-30-22-23	1SBL176001R2322	5/25	AF26Z-40-00-20	1SBL236201R2000	5/95	AF40-30-11-12	1SBL347001R1211	5/26
AF16Z-30-22S-20	1SBL176004R2022	6/45	AF26Z-40-00-21	1SBL236201R2100	5/95	AF40-30-11-13	1SBL347001R1311	5/26
AF16Z-30-22S-21	1SBL176004R2122	6/45	AF26Z-40-00-22	1SBL236201R2200	5/95	AF40-30-11-14	1SBL347001R1411	5/26
AF16Z-30-22S-22	1SBL176004R2222	6/45	AF26Z-40-00-23	1SBL236201R2300	5/95	AF40-30-11-41	1SBL347001R4111	5/26
AF16Z-30-22S-23	1SBL176004R2322	6/45	AF30-30-00-12	1SBL277001R1200	5/6	AF40-30-22-11	1SBL347001R1122	5/26
AF16Z-40-00-20	1SBL176201R2000	5/95	AF30-30-00-13	1SBL277001R1300	5/6	AF40-30-22-12	1SBL347001R1222	5/26
AF16Z-40-00-21	1SBL176201R2100	5/95	AF30-30-00-14	1SBL277001R1400	5/6	AF40-30-22-13	1SBL347001R1322	5/26
AF16Z-40-00-22	1SBL176201R2200	5/95	AF30-30-00-41	1SBL277001R4100	5/6	AF40-30-22-14	1SBL347001R1422	5/26
AF16Z-40-00-23	1SBL176201R2300	5/95	AF30-30-11-12	1SBL277001R1211	5/24	AF40-30-22-41	1SBL347001R4122	5/26
AF190-30-00-11	1SFL487002R1100	5/13	AF30-30-11-13	1SBL277001R1311	5/24	AF45-22-00	1SBL337501R6900	5/101
AF190-30-00-12	1SFL487002R1200	5/13	AF30-30-11-14	1SBL277001R1411	5/24		1SBL337501R7000	5/101
AF190-30-00-13	1SFL487002R1300	5/13	AF30-30-11-41	1SBL277001R4111	5/24		1SBL337501R7200	5/101
AF190-30-11-11	1SFL487002R1111	5/17	AF30-30-22-12	1SBL277001R1222	5/24	AF45-40-00	1SBL337201R6900	5/101
AF190-30-11-12	1SFL487002R1211	5/17	AF30-30-22-13	1SBL277001R1322	5/24		1SBL337201R7000	5/101
AF190-30-11-13	1SFL487002R1311	5/17	AF30-30-22-14	1SBL277001R1422	5/24		1SBL337201R7200	5/101
AF190-30-22-11	1SFL487002R1122	5/31	AF30-30-22-41	1SBL277001R4122	5/24	AF460-30-11	1SFL597001R6811	5/20
AF190-30-22-12	1SFL487002R1222	5/31	AF305-30-00-11	1SFL587002R1100	5/13		1SFL597001R6911	5/20
AF190-30-22-13	1SFL487002R1322	5/31	AF305-30-00-12	1SFL587002R1200	5/13		1SFL597001R7011	5/20
AF2050-30-11	1SFL707001R7011	5/21	AF305-30-00-13	1SFL587002R1300	5/13		1SFL597001R7111	5/20
AF2050-30-22	1SFL707001R7022	5/35	AF305-30-11-11	1SFL587002R1111	5/17	AF460-30-22	1SFL597001R6822	5/34
AF205-30-00-11	1SFL527002R1100	5/13	AF305-30-11-12	1SFL587002R1211	5/17		1SFL597001R6922	5/34
AF205-30-00-12	1SFL527002R1200	5/13	AF305-30-11-13	1SFL587002R1311	5/17		1SFL597001R7022	5/34
AF205-30-00-13	1SFL527002R1300	5/13	AF305-30-22-11	1SFL587002R1122	5/31		1SFL597001R7122	5/34
AF205-30-11-11	1SFL527002R1111	5/17	AF305-30-22-12	1SFL587002R1222	5/31	AF50-40-00	1SBL357201R6900	5/101
AF205-30-11-12	1SFL527002R1211	5/17	AF305-30-22-13	1SFL587002R1322	5/31		1SBL357201R7000	5/101
AF205-30-11-13	1SFL527002R1311	5/17	AF30Z-30-00-20	1SBL276001R2000	5/7		1SBL357201R7200	5/101
AF205-30-22-11	1SFL527002R1122	5/31	AF30Z-30-00-21	1SBL276001R2100	5/7	AF52-30-00-11	1SBL367001R1100	5/8
AF205-30-22-12	1SFL527002R1222	5/31	AF30Z-30-00-22	1SBL276001R2200	5/7	AF52-30-00-12	1SBL367001R1200	5/8
AF205-30-22-13	1SFL527002R1322	5/31	AF30Z-30-00-23	1SBL276001R2300	5/7	AF52-30-00-13	1SBL367001R1300	5/8
AF26-22-00-12	1SBL237501R1200	5/94	AF30Z-30-11-20	1SBL276001R2011	5/25	AF52-30-00-14	1SBL367001R1400	5/8
AF26-22-00-13	1SBL237501R1300	5/94	AF30Z-30-11-21	1SBL276001R2111	5/25	AF52-30-00-41	1SBL367001R4100	5/8
AF26-22-00-14	1SBL237501R1400	5/94	AF30Z-30-11-22	1SBL276001R2211	5/25	AF52-30-11-11	1SBL367001R1111	5/26
AF26-22-00-41	1SBL237501R4100	5/94	AF30Z-30-11-23	1SBL276001R2311	5/25	AF52-30-11-12	1SBL367001R1211	5/26
AF26-30-00-12	1SBL237001R1200	5/6	AF30Z-30-22-20	1SBL276001R2022	5/25	AF52-30-11-13	1SBL367001R1311	5/26
AF26-30-00-13	1SBL237001R1300	5/6	AF30Z-30-22-21	1SBL276001R2122	5/25	AF52-30-11-14	1SBL367001R1411	5/26
AF26-30-00-14	1SBL237001R1400	5/6	AF30Z-30-22-22	1SBL276001R2222	5/25	AF52-30-11-41	1SBL367001R4111	5/26
AF26-30-00-41	1SBL237001R4100	5/6	AF30Z-30-22-23	1SBL276001R2322	5/25	AF52-30-22-11	1SBL367001R1122	5/26
AF26-30-00S-12	1SBL237004R1200	6/42	AF370-30-00-11	1SFL607002R1100	5/13	AF52-30-22-12	1SBL367001R1222	5/26
AF26-30-00S-13	1SBL237004R1300	6/42	AF370-30-00-12	1SFL607002R1200	5/13	AF52-30-22-13	1SBL367001R1322	5/26
AF26-30-00S-14	1SBL237004R1400	6/42	AF370-30-00-13	1SFL607002R1300	5/13	AF52-30-22-14	1SBL367001R1422	5/26
AF26-30-00S-41	1SBL237004R4100	6/42	AF370-30-11-11	1SFL607002R1111	5/17	AF52-30-22-41	1SBL367001R4122	5/26
AF26-30-11-12	1SBL237001R1211	5/24	AF370-30-11-12	1SFL607002R1211	5/17	AF580-30-11	1SFL617001R6811	5/20
AF26-30-11-13	1SBL237001R1311	5/24	AF370-30-11-13	1SFL607002R1311	5/17		1SFL617001R6911	5/20
AF26-30-11-14	1SBL237001R1411	5/24	AF370-30-22-11	1SFL607002R1122	5/31		1SFL617001R7011	5/20
AF26-30-11-41	1SBL237001R4111	5/24	AF370-30-22-12	1SFL607002R1222	5/31		1SFL617001R7111	5/20
AF26-30-11S-12	1SBL237004R1211	6/44	AF370-30-22-13	1SFL607002R1322	5/31	AF580-30-22	1SFL617001R6822	5/34
AF26-30-11S-13	1SBL237004R1311	6/44	AF38-22-00-12	1SBL297501R1200	5/94		1SFL617001R6922	5/34
AF26-30-11S-14	1SBL237004R1411	6/44	AF38-22-00-13	1SBL297501R1300	5/94		1SFL617001R7022	5/34
AF26-30-11S-41	1SBL237004R4111	6/44	AF38-22-00-14	1SBL297501R1400	5/94		1SFL617001R7122	5/34
AF26-30-22-12	1SBL237001R1222	5/24	AF38-22-00-41	1SBL297501R4100	5/94	AF65-30-00-11	1SBL387001R1100	5/8
AF26-30-22-13	1SBL237001R1322	5/24	AF38-30-00-12	1SBL297001R1200	5/6	AF65-30-00-12	1SBL387001R1200	5/8
AF26-30-22-14	1SBL237001R1422	5/24	AF38-30-00-13	1SBL297001R1300	5/6	AF65-30-00-13	1SBL387001R1300	5/8
AF26-30-22S-12	1SBL237004R1222	6/44	AF38-30-00-14	1SBL297001R1400	5/6	AF65-30-00-14	1SBL387001R1400	5/8
AF26-30-22S-13	1SBL237004R1322	6/44	AF38-30-00-41	1SBL297001R4100	5/6	AF65-30-00-41	1SBL387001R4100	5/8
AF26-30-22S-14	1SBL237004R1422	6/44	AF38-30-11-12	1SBL297001R1211	5/24	AF65-30-11-11	1SBL387001R1111	5/26
AF26-30-22S-41	1SBL237004R4122	6/44	AF38-30-11-13	1SBL297001R1311	5/24	AF65-30-11-12	1SBL387001R1211	5/26
AF26-40-00-12	1SBL237201R1200	5/94	AF38-30-11-14	1SBL297001R1411	5/24	AF65-30-11-13	1SBL387001R1311	5/26
AF26-40-00-13	1SBL237201R1300	5/94	AF38-30-11-41	1SBL297001R4111	5/24	AF65-30-11-14	1SBL387001R1411	5/26
AF26-40-00-14	1SBL237201R1400	5/94	AF38-30-22-12	1SBL297001R1222	5/24	AF65-30-11-41	1SBL387001R4111	5/26
AF26-40-00-41	1SBL237201R4100	5/94	AF38-30-22-13	1SBL297001R1322	5/24	AF65-30-22-11	1SBL387001R1122	5/26
AF2650-30-11	1SFL667001R7011	5/21	AF38-30-22-14	1SBL297001R1422	5/24	AF65-30-22-12	1SBL387001R1222	5/26
AF2650-30-22	1SFL667001R7022	5/35	AF38-30-22-41	1SBL297001R4122	5/24	AF65-30-22-13	1SBL387001R1322	5/26
AF265-30-00-11	1SFL547002R1100	5/13	AF38-40-00-12	1SBL297201R1200	5/94	AF65-30-22-14	1SBL387001R1422	5/26
AF265-30-00-12	1SFL547002R1200	5/13	AF38-40-00-13	1SBL297201R1300	5/94	AF65-30-22-41	1SBL387001R4122	5/26
AF265-30-00-13	1SFL547002R1300	5/13	AF38-40-00-14	1SBL297201R1400	5/94	AF750-30-11	1SFL637001R6811	5/20
AF265-30-11-11	1SFL547002R1111	5/17	AF38-40-00-41	1SBL297201R4100	5/94		1SFL637001R6911	5/20
AF265-30-11-12	1SFL547002R1211	5/17	AF38Z-22-00-20	1SBL296501R2000	5/95		1SFL637001R7011	5/20
AF265-30-11-13	1SFL547002R1311	5/17	AF38Z-22-00-21	1SBL296501R2100	5/95		1SFL637001R7111	5/20
AF265-30-22-11	1SFL547002R1122	5/31	AF38Z-22-00-22	1SBL296501R2200	5/95	AF750-30-22	1SFL637001R6822	5/34
AF265-30-22-12	1SFL547002R1222	5/31	AF38Z-22-00-23	1SBL296501R2300	5/95		1SFL637001R6922	5/34
AF265-30-22-13	1SFL547002R1322	5/31	AF38Z-30-00-20	1SBL296001R2000	5/7		1SFL637001R7022	5/34
AF26Z-22-00-20	1SBL236501R2000	5/95	AF38Z-30-00-21	1SBL296001R2100	5/7		1SFL637001R7122	5/34
AF26Z-22-00-21	1SBL236501R2100	5/95	AF38Z-30-00-22	1SBL296001R2200	5/7	AF75-22-00	1SBL417501R6900	5/101
AF26Z-								

# Index

## Type classification

Type	Order code	Page	Type	Order code	Page	Type	Order code	Page
AF80-30-11-11	1SBL397001R1111	5/27	ASL09-30-01-88	1SBL103001R8801	4/33	B6-30-10-F-03	GJL1211003R0103	3/27
AF80-30-11-12	1SBL397001R1211	5/27	ASL09-30-01-S-81	1SBL103004R8101	6/5	B6-30-10-F-80	GJL1211003R8100	3/27
AF80-30-11-13	1SBL397001R1311	5/27	ASL09-30-01-S-83	1SBL103004R8301	6/5	B6-30-10-F-84	GJL1211003R8104	3/27
AF80-30-11-14	1SBL397001R1411	5/27	ASL09-30-01-S-86	1SBL103004R8601	6/5	B6-30-10-F-85	GJL1211003R8105	3/27
AF80-30-11-41	1SBL397001R4111	5/27	ASL09-30-01-S-88	1SBL103004R8801	6/5	B6-30-10-P-01	GJL1211009R0101	3/17
AF80-30-22-11	1SBL397001R1122	5/27	ASL09-30-10-81	1SBL103001R8110	4/33	B6-30-10-P-02	GJL1211009R0102	3/17
AF80-30-22-12	1SBL397001R1222	5/27	ASL09-30-10-83	1SBL103001R8310	4/33	B6-30-10-P-03	GJL1211009R0103	3/17
AF80-30-22-13	1SBL397001R1322	5/27	ASL09-30-10-86	1SBL103001R8610	4/33	B6-30-10-P-80	GJL1211009R8100	3/17
AF80-30-22-14	1SBL397001R1422	5/27	ASL09-30-10-88	1SBL103001R8810	4/33	B6-30-10-P-84	GJL1211009R8104	3/17
AF80-30-22-41	1SBL397001R4122	5/27	ASL09-30-10S-81	1SBL103004R8110	6/5	B6-30-10-P-85	GJL1211009R8105	3/17
AF96-30-00-11	1SBL407001R1100	5/8	ASL09-30-10S-83	1SBL103004R8310	6/5	B6-40-00-01	GJL1211201R0001	3/10
AF96-30-00-12	1SBL407001R1200	5/8	ASL09-30-10S-86	1SBL103004R8610	6/5	B6-40-00-02	GJL1211201R0002	3/10
AF96-30-00-13	1SBL407001R1300	5/8	ASL09-30-10S-88	1SBL103004R8810	6/5	B6-40-00-03	GJL1211201R0003	3/10
AF96-30-00-14	1SBL407001R1400	5/8	ASL09-30-32-S-81	1SBL103001R8132	4/35	B6-40-00-80	GJL1211201R8000	3/10
AF96-30-00-41	1SBL407001R4100	5/8	ASL09-30-32-S-83	1SBL103001R8332	4/35	B6-40-00-84	GJL1211201R8004	3/10
AF96-30-11-11	1SBL407001R1111	5/27	ASL09-30-32-S-86	1SBL103001R8632	4/35	B6S-30-01-1-7-71	GJL1213001R7011	3/8
AF96-30-11-12	1SBL407001R1211	5/27	ASL09-30-32-S-88	1SBL103001R8832	4/35	B6S-30-01-2-8-72	GJL1213001R7012	3/8
AF96-30-11-13	1SBL407001R1311	5/27	ASL09-30-32S-81	1SBL103004R8132	6/7	B6S-30-10-1-7-71	GJL1213001R7101	3/8
AF96-30-11-14	1SBL407001R1411	5/27	ASL09-30-32S-83	1SBL103004R8332	6/7	B6S-30-10-2-8-72	GJL1213001R7102	3/8
AF96-30-11-41	1SBL407001R4111	5/27	ASL09-30-32S-86	1SBL103004R8632	6/7	B7-22-00-01	GJL1311501R0001	3/10
AF96-30-22-11	1SBL407001R1122	5/27	ASL09-30-32S-88	1SBL103004R8832	6/7	B7-22-00-02	GJL1311501R0002	3/10
AF96-30-22-12	1SBL407001R1222	5/27	ASL12-30-01-81	1SBL113001R8101	4/33	B7-22-00-03	GJL1311501R0003	3/10
AF96-30-22-13	1SBL407001R1322	5/27	ASL12-30-01-83	1SBL113001R8301	4/33	B7-22-00-80	GJL1311501R8000	3/10
AF96-30-22-14	1SBL407001R1422	5/27	ASL12-30-01-86	1SBL113001R8601	4/33	B7-22-00-84	GJL1311501R8004	3/10
AF96-30-22-41	1SBL407001R4122	5/27	ASL12-30-01-88	1SBL113001R8801	4/33	B7-30-01-01	GJL1311001R0011	3/2
AS09-30-01-16	1SBL101001R1601	4/32	ASL12-30-01-S-81	1SBL113004R8101	6/5	B7-30-01-02	GJL1311001R0012	3/2
AS09-30-01-20	1SBL101001R2001	4/32	ASL12-30-01-S-83	1SBL113004R8301	6/5	B7-30-01-03	GJL1311001R0013	3/2
AS09-30-01-28	1SBL101001R2801	4/32	ASL12-30-01S-86	1SBL113004R8601	6/5	B7-30-01-80	GJL1311501R8010	3/2
AS09-30-01S-16	1SBL101004R1601	6/4	ASL12-30-01S-88	1SBL113004R8801	6/5	B7-30-01-84	GJL1311001R8014	3/2
AS09-30-01S-20	1SBL101004R2001	6/4	ASL12-30-10-81	1SBL113001R8110	4/33	B7-30-01-85	GJL1311001R8015	3/2
AS09-30-01S-26	1SBL101004R2601	6/4	ASL12-30-10-83	1SBL113001R8310	4/33	B7-30-01-F-01	GJL1311003R0011	3/27
AS09-30-01S-28	1SBL101004R2801	6/4	ASL12-30-10-86	1SBL113001R8610	4/33	B7-30-01-F-02	GJL1311003R0012	3/27
AS09-30-10-16	1SBL101001R1610	4/32	ASL12-30-10-88	1SBL113001R8810	4/33	B7-30-01-F-03	GJL1311003R0013	3/27
AS09-30-10-20	1SBL101001R2010	4/32	ASL12-30-10S-81	1SBL113004R8110	6/5	B7-30-01-F-80	GJL1311003R8010	3/27
AS09-30-10-26	1SBL101001R2610	4/32	ASL12-30-10S-83	1SBL113004R8310	6/5	B7-30-01-F-84	GJL1311003R8014	3/27
AS09-30-10-28	1SBL101001R2810	4/32	ASL12-30-10S-86	1SBL113004R8610	6/5	B7-30-01-F-85	GJL1311003R8015	3/27
AS09-30-10S-16	1SBL101004R1610	6/4	ASL12-30-10S-88	1SBL113004R8810	6/5	B7-30-01-P-01	GJL1311009R0011	3/17
AS09-30-10S-20	1SBL101004R2010	6/4	ASL12-30-32-S-81	1SBL113001R8132	4/35	B7-30-01-P-02	GJL1311009R0012	3/17
AS09-30-10S-26	1SBL101004R2610	6/4	ASL12-30-32-S-83	1SBL113001R8332	4/35	B7-30-01-P-03	GJL1311009R0013	3/17
AS09-30-10S-28	1SBL101004R2810	6/4	ASL12-30-32-S-86	1SBL113001R8632	4/35	B7-30-01-P-80	GJL1311009R8010	3/17
AS09-30-32-16	1SBL101001R1632	4/34	ASL12-30-32-S-88	1SBL113001R8832	4/35	B7-30-01-P-84	GJL1311009R8014	3/17
AS09-30-32-20	1SBL101001R2032	4/34	ASL12-30-32S-81	1SBL113004R8132	6/7	B7-30-01-P-85	GJL1311009R8015	3/17
AS09-30-32-26	1SBL101001R2632	4/34	ASL12-30-32S-83	1SBL113004R8332	6/7	B7-30-10-01	GJL1311001R0101	3/2
AS09-30-32-28	1SBL101001R2832	4/34	ASL12-30-32S-86	1SBL113004R8632	6/7	B7-30-10-02	GJL1311001R0102	3/2
AS09-30-32S-16	1SBL101004R1632	6/6	ASL12-30-32S-88	1SBL113004R8832	6/7	B7-30-10-03	GJL1311001R0103	3/2
AS09-30-32S-20	1SBL101004R2032	6/6	ASL16-30-01-81	1SBL123001R8101	4/33	B7-30-10-08	GJL1311001R8100	3/2
AS09-30-32S-26	1SBL101004R2632	6/6	ASL16-30-01-83	1SBL123001R8301	4/33	B7-30-10-84	GJL1311001R8104	3/2
AS09-30-32S-28	1SBL101004R2832	6/6	ASL16-30-01-86	1SBL123001R8601	4/33	B7-30-10-85	GJL1311001R8105	3/2
AS12-30-01-16	1SBL111001R1601	4/32	ASL16-30-01-88	1SBL123001R8801	4/33	B7-30-10-F-01	GJL1311003R0101	3/27
AS12-30-01-20	1SBL111001R2001	4/32	ASL16-30-01S-81	1SBL123004R8101	6/5	B7-30-10-F-02	GJL1311003R0102	3/27
AS12-30-01-26	1SBL111001R2601	4/32	ASL16-30-01S-83	1SBL123004R8301	6/5	B7-30-10-F-03	GJL1311003R0103	3/27
AS12-30-01-28	1SBL111001R2801	4/32	ASL16-30-01S-86	1SBL123004R8601	6/5	B7-30-10-F-80	GJL1311003R8100	3/27
AS12-30-01S-16	1SBL111004R1601	6/4	ASL16-30-01S-88	1SBL123004R8801	6/5	B7-30-10-F-84	GJL1311003R8104	3/27
AS12-30-01S-20	1SBL111004R2001	6/4	ASL16-30-10-81	1SBL123001R8110	4/33	B7-30-10-F-85	GJL1311003R8105	3/27
AS12-30-01S-26	1SBL111004R2601	6/4	ASL16-30-10-83	1SBL123001R8310	4/33	B7-30-10-P-01	GJL1311009R0101	3/17
AS12-30-01S-28	1SBL111004R2801	6/4	ASL16-30-10-86	1SBL123001R8610	4/33	B7-30-10-P-02	GJL1311009R0102	3/17
AS12-30-10-16	1SBL111001R1610	4/32	ASL16-30-10-88	1SBL123001R8810	4/33	B7-30-10-P-03	GJL1311009R0103	3/17
AS12-30-10-20	1SBL111001R2010	4/32	ASL16-30-10S-81	1SBL123004R8110	6/5	B7-30-10-P-80	GJL1311009R8100	3/17
AS12-30-10-26	1SBL111001R2610	4/32	ASL16-30-10S-83	1SBL123004R8310	6/5	B7-30-10-P-84	GJL1311009R8104	3/17
AS12-30-10-28	1SBL111001R2810	4/32	ASL16-30-10S-86	1SBL123004R8610	6/5	B7-30-10-P-85	GJL1311009R8105	3/17
AS12-30-10S-16	1SBL111004R1610	6/4	ASL16-30-10S-88	1SBL123004R8810	6/5	B7-40-00-01	GJL1311201R0001	3/10
AS12-30-10S-20	1SBL111004R2010	6/4	ASL16-30-32-S-81	1SBL123001R8132	4/35	B7-40-00-02	GJL1311201R0002	3/10
AS12-30-10S-26	1SBL111004R2610	6/4	ASL16-30-32-S-83	1SBL123001R8332	4/35	B7-40-00-80	GJL1311201R8000	3/10
AS12-30-10S-28	1SBL111004R2810	6/4	ASL16-30-32-S-86	1SBL123001R8632	4/35	B7-40-00-84	GJL1311201R8004	3/10
AS12-30-32-16	1SBL111001R1632	4/34	ASL16-30-32-S-88	1SBL123001R8832	4/35	B7D-30-01-01	GJL1317001R0011	3/3
AS12-30-32-20	1SBL111001R2032	4/34	ASL16-30-32S-81	1SBL123004R8132	6/7	B7D-30-01-05	GJL1317001R0015	3/3
AS12-30-32-26	1SBL111001R2632	4/34	ASL16-30-32S-83	1SBL123004R8332	6/7	B7D-30-10-01	GJL1317001R0101	3/3
AS12-30-32-28	1SBL111001R2832	4/34	ASL16-30-32S-86	1SBL123004R8632	6/7	B7D-30-10-05	GJL1317001R0105	3/3
AS12-30-32S-16	1SBL111004R1632	6/6	ASL16-30-32S-88	1SBL123004R8832	6/7	B7D-40-00-01	GJL1317201R0001	3/11
AS12-30-32S-20	1SBL111004R2032	6/6	B6-22-00-02	GJL1211501R0002	3/10	B7D-40-00-05	GJL1317201R0005	3/11
AS12-30-32S-26	1SBL111004R2632	6/6	B6-22-00-03	GJL1211501R0003	3/10	B7S-30-01-1-7-71	GJL1313001R7011	3/8
AS12-30-32S-28	1SBL111004R2832	6/6	B6-22-00-80	GJL1211501R8000	3/10	B7S-30-01-2-8-72	GJL1313001R7012	3/8
AS16-30-01-16	1SBL121001R1601	4/32	B6-22-00-84	GJL1211501R8004	3/10	B7S-30-10-1-7-71	GJL1313001R7101	3/8
AS16-30-01-20	1SBL121001R2001	4/32	B6-30-01-01	GJL1211001R0011	3/2	B7S-30-10-2-8-72	GJL1313001R7102	3/8
AS16-30-01-26	1SBL121001R2601	4/32	B6-30-01-02	GJL1211001R0012	3/2	BA4	1SNA235156R2700	4/80
AS16-30-01-28	1SBL121001R2801	4/32	B6-30-01-03	GJL1211001R0013	3/2	BA5-50	1SBN110000R1000	3/37
AS16-30-01S-16	1SBL121004R1601	6/4	B6-30-01-80	GJL1211001R8010	3/2	BB3	1SBN111020R1000	4/80
AS16-30-01S-20	1SBL121004R2001	6/4	B6-30-01-84	GJL1211001R8014	3/2	BB4	1SBN110120W1000	5/210
AS16-30-01S-26	1SBL121004R2601	6/4	B6-30-01-85	GJL1211001R8015	3/2	BC6-21-10-P-01	GJL1213109R0101	3/18
AS16-30-01S-28	1SBL121004R2801	6/4	B6-30-01-F-01	GJL1211003R0011	3/27	BC6-21-10-P-03	GJL1213109R0103	3/18
AS16-30-10-16	1SBL121001R1610	4/32	B6-30-01-F-02	GJL1211003R0012	3/27	BC6-21-10-P-04	GJL1213109R0104	3/18
AS16-30-10-20	1SBL121001R2010	4/32	B6-30-01-F-03	GJL1211003R0013	3/27	BC6-21-10-P-05	GJL1213109R0105	3/18
AS16-30-10-26	1SBL121001R2610	4/32	B6-30-01-F-80	GJL1211003R8010	3/27	BC6-21-10-P-16	GJL1213109R1106	3/18
AS16-30-10-28	1SBL121001R2810	4/32	B6-30-01-F-84	GJL1211003R8014	3/27	BC6-22-00-01	GJL1213501R0001	3/11
AS16-30-10S-16	1SBL121004R1610	6/4	B6-30-01-F-85	GJL1211003R8015	3/27	BC6-22-00-02	GJL1213501R0002	3/11
AS16-30-10S-20	1SBL121004R2010	6/4	B6-30-01-P-01	GJL1211009R0011	3/17	BC6-22-00-03	GJL1213501R0003	3/11
AS16-30-10S-26	1SBL121004R2610	6/4	B6-30-01-P-02	GJL1211009R0012	3/17	BC6-22-00-04	GJL1213501R0004	3/11
AS16-30-10S-28	1SBL121004R2810	6/4	B6-30-01-P-03	GJL1211009R0013	3/17	BC6-22-00-05	GJL	



# Index

## Type classification

Type	Order code	Page
BC6-30-01-F-03	GJL1213003R0013	3/28
BC6-30-01-F-04	GJL1213003R0014	3/28
BC6-30-01-F-05	GJL1213003R0015	3/28
BC6-30-01-F-07	GJL1213003R0017	3/28
BC6-30-01-F-1.4-81	GJL1213003R8011	3/33
BC6-30-01-F-16	GJL1213003R1016	3/28
BC6-30-01-F-2.4-51	GJL1213003R5011	3/33
BC6-30-01-P-01	GJL1213009R0011	3/18
BC6-30-01-P-03	GJL1213009R0013	3/18
BC6-30-01-P-04	GJL1213009R0014	3/18
BC6-30-01-P-05	GJL1213009R0015	3/18
BC6-30-01-P-07	GJL1213009R0017	3/18
BC6-30-01-P-1.4-81	GJL1213009R8011	3/25
BC6-30-01-P-16	GJL1213009R1016	3/18
BC6-30-01-P-2.4-51	GJL1213009R5011	3/25
BC6-30-10-01	GJL1213001R0101	3/3
BC6-30-10-03	GJL1213001R0103	3/3
BC6-30-10-04	GJL1213001R0104	3/3
BC6-30-10-05	GJL1213001R0105	3/3
BC6-30-10-07	GJL1213001R0107	3/3
BC6-30-10-1.4-81	GJL1213001R8101	3/8
BC6-30-10-16	GJL1213001R1106	3/3
BC6-30-10-2.4-51	GJL1213001R5101	3/8
BC6-30-10-F-01	GJL1213003R0101	3/28
BC6-30-10-F-03	GJL1213003R0103	3/28
BC6-30-10-F-04	GJL1213003R0104	3/28
BC6-30-10-F-05	GJL1213003R0105	3/28
BC6-30-10-F-07	GJL1213003R0107	3/28
BC6-30-10-F-1.4-81	GJL1213003R8101	3/33
BC6-30-10-F-16	GJL1213003R1106	3/28
BC6-30-10-F-2.4-51	GJL1213003R5101	3/33
BC6-30-10-P-01	GJL1213009R0101	3/18
BC6-30-10-P-03	GJL1213009R0103	3/18
BC6-30-10-P-04	GJL1213009R0104	3/18
BC6-30-10-P-05	GJL1213009R0105	3/18
BC6-30-10-P-07	GJL1213009R0107	3/18
BC6-30-10-P-1.4-81	GJL1213009R8101	3/25
BC6-30-10-P-16	GJL1213009R1106	3/18
BC6-30-10-P-2.4-51	GJL1213009R5101	3/25
BC7-30-01-01	GJL1313001R0011	3/3
BC7-30-01-03	GJL1313001R0013	3/3
BC7-30-01-04	GJL1313001R0014	3/3
BC7-30-01-05	GJL1313001R0015	3/3
BC7-30-01-07	GJL1313001R0017	3/3
BC7-30-01-1.4-81	GJL1313001R8011	3/8
BC7-30-01-16	GJL1313001R1016	3/3
BC7-30-01-2.4-51	GJL1313001R5011	3/8
BC7-30-01-F-01	GJL1313003R0011	3/28
BC7-30-01-F-03	GJL1313003R0013	3/28
BC7-30-01-F-04	GJL1313003R0014	3/28
BC7-30-01-F-05	GJL1313003R0015	3/28
BC7-30-01-F-07	GJL1313003R0017	3/28
BC7-30-01-F-1.4-81	GJL1313003R8011	3/33
BC7-30-01-F-16	GJL1313003R1016	3/28
BC7-30-01-F-2.4-51	GJL1313003R5011	3/33
BC7-30-01-P-01	GJL1313009R0011	3/18
BC7-30-01-P-03	GJL1313009R0013	3/18
BC7-30-01-P-04	GJL1313009R0014	3/18
BC7-30-01-P-05	GJL1313009R0015	3/18
BC7-30-01-P-07	GJL1313009R0017	3/18
BC7-30-01-P-1.4-81	GJL1313009R8011	3/25
BC7-30-01-P-16	GJL1313009R1016	3/18
BC7-30-01-P-2.4-51	GJL1313009R5011	3/25
BC7-30-10-01	GJL1313001R0101	3/3
BC7-30-10-03	GJL1313001R0103	3/3
BC7-30-10-04	GJL1313001R0104	3/3
BC7-30-10-05	GJL1313001R0105	3/3
BC7-30-10-07	GJL1313001R0107	3/3
BC7-30-10-1.4-81	GJL1313001R8101	3/8
BC7-30-10-16	GJL1313001R1106	3/3
BC7-30-10-2.4-51	GJL1313001R5101	3/8
BC7-30-10-F-01	GJL1313003R0101	3/28
BC7-30-10-F-03	GJL1313003R0103	3/28
BC7-30-10-F-04	GJL1313003R0104	3/28
BC7-30-10-F-05	GJL1313003R0105	3/28
BC7-30-10-F-07	GJL1313003R0107	3/28
BC7-30-10-F-1.4-81	GJL1313003R8101	3/33
BC7-30-10-F-16	GJL1313003R1106	3/28
BC7-30-10-F-2.4-51	GJL1313003R5101	3/33
BC7-30-10-P-01	GJL1313009R0101	3/18
BC7-30-10-P-03	GJL1313009R0103	3/18
BC7-30-10-P-04	GJL1313009R0104	3/18
BC7-30-10-P-05	GJL1313009R0105	3/18
BC7-30-10-P-07	GJL1313009R0107	3/18
BC7-30-10-P-1.4-81	GJL1313009R8101	3/25
BC7-30-10-P-16	GJL1313009R1106	3/18
BC7-30-10-P-2.4-51	GJL1313009R5101	3/25
BDT4	1SNB110122T1000	4/80
BEA140/XT2	1SFN084206R1000	5/223
BEA140/XT4	1SFN084206R1001	5/223
BEA16-3	1SNB081006T1000	4/37
BEA16-3U	1SNB081020R1000	6/9
BEA16-4	1SNB081306T1000	5/11
BEA205/T4	1SFN084806R1001	5/223
BEA205/XT4	1SFN084806R1000	5/223
BEA26-4	1SNB082306T1000	5/11
BEA370/T5	1SFN085406R1000	5/223
BEA38-4	1SNB082306T2000	5/11
BEA460H/T4	1SFN085907R1000	5/223
BEA7/132	1SNB080906R1002	3/37

Type	Order code	Page
BEA7/325	1SNB080906R1001	3/37
BEA750/T5	1SFN086106R1001	5/223
BEA750/T6	1SFN086106R1000	5/223
BEA750D/T5	1SFN086106R1003	5/223
BEA750D/T6	1SFN086106R1002	5/223
BED460	1SFN085703R1000	5/222
BED580	1SFN085903R1000	5/222
BED750	1SFN086103R1000	5/222
BEF460/OESA400	1SFN085708R1000	5/223
BEF750/OESA800	1SFN086108R1000	5/223
BEM460-30	1SFN085701R1000	5/221
BEM750-30	1SFN086101R1000	5/221
BEP140-30	1SFN084214R1000	5/221
BEP205-30	1SFN084814R1000	5/221
BEP370-30	1SFN085414R1000	5/221
BER140-4	1SFN084211R1000	5/221
BER16-4	1SNB081311R1000	5/11
BER16C-3	1SNB081012R1000	4/37
BER205-4	1SFN084811R1000	5/221
BER370-4	1SFN085411R1000	5/221
BER38-4	1SNB081313R2000	5/11
BER65-4	1SNB083411R1000	5/11
BER96-4	1SNB083911R1000	5/11
BES460	1SFN085704R1000	5/221
BES750	1SFN086104R1000	5/221
BES75-40	1SNB083302R1000	5/103
BEY140-4	1SFN084413R1000	5/222
BEY16-4	1SNB081313R2000	5/11
BEY16C-3	1SNB081018R2000	4/37
BEY190-4	1SFN084813R1000	5/222
BEY205-4	1SFN085213R1000	5/222
BEY265-4	1SFN085413R1000	5/222
BEY370-4	1SFN085813R1000	5/222
BEY38-4	1SNB082713R2000	5/11
BEY65-4	1SNB083413R2000	5/11
BEY96-4	1SNB083913R2000	5/11
BP16	1SNB111403R1000	5/241
BP38-4	1SNB112303T1000	5/217
BP65-4	1SNB113403T1000	5/217
BP96-4	1SNB113903T1000	5/217
BS1-3	1SAM201908R1001	2/8
BS4-3	1SAM401911R1008	2/42
BSM6-30	GJL1201908R0001	3/37
BSS100	SK829090-B	5/119
BSS1000	SK829090-H	5/119
BSS145	SK829090-F	5/119
BSS210	SK829090-G	5/119
BSS550	SK829090-E	5/119
BX4	1SNB110108T1000	5/183
BX4-CA	1SNB110109W1000	5/183
CA3-01	1SNB011010T1001	4/37
CA3-01S	1SNB011019T1001	6/9
CA3-10	1SNB011010T1010	4/37
CA3-10S	1SNB011019T1010	6/9
CA4-01	1SNB011010R1001	5/11
CA4-01S	1SNB011019R1001	6/47
CA4-01S-T	1SNB011019T1001	6/47
CA4-01-T	1SNB011010T1001	5/11
CA4-04E	1SAM010140R1004	5/97
CA4-04M	1SNB010140R1104	5/198
CA4-04N	1SNB010140R1204	5/183
CA4-10	1SNB011010R1010	5/11
CA4-10S	1SNB011019R1010	6/47
CA4-10S-T	1SNB011019T1010	6/47
CA4-10-T	1SNB011010T1010	5/11
CA4-13M	1SNB010140R1113	5/198
CA4-13N	1SNB010140R1213	5/183
CA4-22E	1SNB010140R1022	5/11
CA4-22ES	1SNB010145R1022	6/47
CA4-22M	1SNB010140R1122	5/11
CA4-22MS	1SNB010145R1122	6/47
CA4-22N	1SNB010140R1222	5/183
CA4-22NS	1SNB010145R1222	6/65
CA4-22U	1SNB010140R1322	5/11
CA4-31E	1SNB010140R1031	5/97
CA4-31ES	1SNB010145R1031	6/47
CA4-31M	1SNB010140R1131	5/198
CA4-31MS	1SNB010145R1131	6/47
CA4-31N	1SNB010140R1231	5/183
CA4-31NS	1SNB010145R1231	6/65
CA4-31U	1SNB010140R1331	5/198
CA4-40E	1SNB010140R1040	5/97
CA4-40ES	1SNB010145R1040	6/47
CA4-40N	1SNB010140R1240	5/183
CA4-40NS	1SNB010145R1240	6/65
CA4-40U	1SNB010140R1340	5/198
CA5-01	1SNB010010R1001	5/103
CA5-04E	1SNB010040R1004	5/228
CA5-04M	1SNB010040R1104	5/228
CA5-10	1SNB010010R1010	5/103
CA5-11/11E	1SNB010040R1018	5/228
CA5-11/11M	1SNB010040R1118	5/228
CA5-13M	1SNB010040R1113	5/228
CA5-22E	1SNB010040R1022	5/103
CA5-22M	1SNB010040R1122	5/228
CA5-31E	1SNB010040R1031	5/228
CA5-31M	1SNB010040R1131	5/228
CA5-40E	1SNB010040R1040	5/228
CA6-11E	GJL1201317R0002	3/37
CA6-11E-F	GJL1201318R0002	3/37

Type	Order code	Page
CA6-11E-P	GJL1201319R0002	3/37
CA6-11K	GJL1201317R0001	3/38
CA6-11K-F	GJL1201318R0001	3/38
CA6-11K-P	GJL1201319R0001	3/38
CA6-11M	GJL1201317R0003	3/37
CA6-11M-F	GJL1201318R0003	3/37
CA6-11M-P	GJL1201319R0003	3/37
CA6-11N	GJL1201317R0004	3/37
CA6-11N-F	GJL1201318R0004	3/37
CA6-11N-P	GJL1201319R0004	3/37
CAF6-02E	GJL1201330R0010	3/37
CAF6-02K	GJL1201330R0009	3/38
CAF6-02M	GJL1201330R0011	3/37
CAF6-02N	GJL1201330R0012	3/37
CAF6-11E	GJL1201330R0002	3/37
CAF6-11K	GJL1201330R0001	3/38
CAF6-11M	GJL1201330R0003	3/37
CAF6-11N	GJL1201330R0004	3/37
CAF6-20E	GJL1201330R0006	3/37
CAF6-20K	GJL1201330R0005	3/38
CAF6-20M	GJL1201330R0007	3/37
CAF6-20N	GJL1201330R0008	3/37
CAL16-11A	SK829002-A	5/254
CAL16-11B	SK829002-B	5/119
CAL16-11C	SK829002-C	5/119
CAL16-11D	SK829002-D	5/119
CAL18-11	1SFN010720R1011	5/23
CAL18-11B	1SFN010720R3311	5/23
CAL19-11	1SFN010820R1011	5/15
CAL19-11B	1SFN010820R3311	5/15
CAL4-11	1SNB010120R1011	5/11
CAL4-11S	1SNB010130T1011	6/47
CAL4-11-T	1SNB010120T1011	5/11
CAL5-11	1SNB010020R1011	5/103
CAT4-11E	1SNB010151R1011	5/11
CAT4-11ES	1SNB010153R1011	6/47
CAT4-11M	1SNB010151R1111	5/11
CAT4-11MS	1SNB010153R1111	6/47
CAT4-11U	1SNB010151R1311	5/11
CAT4-11US	1SNB010153R1311	6/47
CB5-01	1SNB010013R1001	5/212
CB5-10	1SNB010013R1010	5/212
CC4-01	1SNB010111R1001	5/11
CC4-10	1SNB010111R1010	5/11
CC5-01	1SNB010111R1001	5/228
CC5-10	1SNB010111R1010	5/228
COL16-11E	SK829002-E	5/119
CE5-01D0.1	1SNB010015R1001	5/230
CE5-01D2	1SNB010017R1001	5/230
CE5-01W0.1	1SNB010016R1001	5/230
CE5-01W2	1SNB010018R1001	5/230
CE5-10D0.1	1SNB010015R1010	5/230
CE5-10D2	1SNB010017R1010	5/230
CE5-10W0.1	1SNB010016R1010	5/230
CE5-10W2	1SNB010018R1010	5/230
CEL18-10	1SFN010716R1001	5/202
CEL18-10	1SFN010716R1010	5/202
CK1-02	1SAM301901R1003	2/20
CK1-11	1SAM301901R1001	2/20
CK1-20	1SAM301901R1002	2/20
DB16	1SAZ70190	

Type	Order code	Page	Type	Order code	Page	Type	Order code	Page	
EK1000-40-22	SK827044-DG	5/113	EK210-40-22	SK825441-DG	5/111	K6-31Z-F-03	GJH1211003R0313	3/34	
	SK827044-DT	5/113		SK825441-DT	5/111		K6-31Z-F-80	GJH1211003R8310	3/34
	SK827044-DU	5/113		SK825441-DU	5/111		K6-31Z-F-84	GJH1211003R8314	3/34
	SK827045-AD	5/116		SK825451-AD	5/115		K6-31Z-F-85	GJH1211003R8315	3/34
	SK827045-AR	5/116		SK825451-AE	5/115		K6-31Z-P-01	GJH1211009R0311	3/23
	SK827045-EF	5/116		SK825451-AF	5/115		K6-31Z-P-02	GJH1211009R0312	3/23
	SK827045-EG	5/116		SK825451-AL	5/115		K6-31Z-P-03	GJH1211009R0313	3/23
	SK827045-EL	5/116		SK825451-AM	5/115		K6-31Z-P-80	GJH1211009R8310	3/23
	SK827045-EM	5/116		SK825451-AN	5/115		K6-31Z-P-84	GJH1211009R8314	3/23
	SK827045-EP	5/116		SK825451-AP	5/115		K6-31Z-P-85	GJH1211009R8315	3/23
EK110-40-11	SK827045-ER	5/116	SK825451-AR	5/115	K6-40E-01	GJH1211001R0401	3/13		
	SK824440-AD	5/108	SK827040-AD	5/110	K6-40E-02	GJH1211001R0402	3/13		
	SK824440-AE	5/108	SK827040-AR	5/110	K6-40E-03	GJH1211001R0403	3/13		
	SK824440-AF	5/108	SK827040-EF	5/110	K6-40E-80	GJH1211001R8400	3/13		
	SK824440-AL	5/108	SK827040-EG	5/110	K6-40E-84	GJH1211001R8404	3/13		
	SK824440-AM	5/108	SK827040-EL	5/110	K6-40E-85	GJH1211001R8405	3/13		
	SK824440-AN	5/108	SK827040-EM	5/110	K6-40E-F-01	GJH1211003R0401	3/34		
	SK824440-AP	5/108	SK827040-EP	5/110	K6-40E-F-02	GJH1211003R0402	3/34		
	SK824440-AR	5/108	SK827040-ER	5/110	K6-40E-F-03	GJH1211003R0403	3/34		
	EK110-40-21	SK824440-DA	5/109	SK827040-DB	5/111	K6-40E-F-80	GJH1211003R8400	3/34	
SK824440-DB		5/109	SK827040-DC	5/111	K6-40E-F-84	GJH1211003R8404	3/34		
SK824440-DC		5/109	SK827040-DD	5/111	K6-40E-F-85	GJH1211003R8405	3/34		
SK824440-DD		5/109	SK827040-DE	5/111	K6-40E-P-01	GJH1211009R0401	3/23		
SK824440-DE		5/109	SK827040-DF	5/111	K6-40E-P-02	GJH1211009R0402	3/23		
SK824440-DF		5/109	SK827040-DG	5/111	K6-40E-P-03	GJH1211009R0403	3/23		
SK824440-DG		5/109	SK827040-DT	5/111	K6-40E-P-80	GJH1211009R8400	3/23		
SK824440-DT		5/109	SK827040-DU	5/111	K6-40E-P-84	GJH1211009R8404	3/23		
SK824440-DU		5/109	SK827042-AD	5/115	K6-40E-P-85	GJH1211009R8405	3/23		
EK110-40-22		SK824450-AD	5/114	SK827042-AR	5/115	K6S-22Z-1.7-71	GJH1213001R7221	3/15	
	SK824450-AE	5/114	SK827042-EF	5/115	K6S-22Z-2.8-72	GJH1213001R7222	3/15		
	SK824450-AF	5/114	SK827042-EG	5/115	K6S-31Z-1.7-71	GJH1213001R7311	3/15		
	SK824450-AL	5/114	SK827042-EL	5/115	K6S-31Z-2.8-72	GJH1213001R7312	3/15		
	SK824450-AM	5/114	SK827042-EM	5/115	K6S-40E-1.7-71	GJH1213001R7401	3/15		
	SK824450-AN	5/114	SK827042-EP	5/115	K6S-40E-2.8-72	GJH1213001R7402	3/15		
	SK824450-AP	5/114	SK827042-ER	5/115	KA450	1SAM401908R1001	2/42		
	SK824450-AR	5/114	SK827041-AD	5/110	KA495	1SAM501901R1001	2/42		
	EK150-40-11	SK824441-AD	5/108	SK827041-AR	5/110	KA495C	1SAM501902R1001	2/42	
		SK824441-AE	5/108	SK827041-EF	5/110	KC6-22Z-01	1SAM501902R0221	3/14	
SK824441-AF		5/108	SK827041-EG	5/110	KC6-22Z-04	GJH1213001R0224	3/14		
SK824441-AL		5/108	SK827041-EL	5/110	KC6-22Z-05	GJH1213001R0225	3/14		
SK824441-AM		5/108	SK827041-EM	5/110	KC6-22Z-07	GJH1213001R0227	3/14		
SK824441-AN		5/108	SK827041-EP	5/110	KC6-22Z-13	GJH1213001R1223	3/14		
SK824441-AP		5/108	SK827041-ER	5/110	KC6-22Z-16	GJH1213001R1226	3/14		
SK824441-AR		5/108	SK827041-DB	5/111	KC6-22Z-F-01	GJH1213003R0221	3/35		
EK150-40-21		SK824441-DA	5/109	SK827041-DC	5/111	KC6-22Z-F-04	GJH1213003R0224	3/35	
		SK824441-DB	5/109	SK827041-DD	5/111	KC6-22Z-F-05	GJH1213003R0225	3/35	
	SK824441-DC	5/109	SK827041-DE	5/111	KC6-22Z-F-07	GJH1213003R0227	3/35		
	SK824441-DD	5/109	SK827041-DF	5/111	KC6-22Z-F-16	GJH1213003R1226	3/35		
	SK824441-DE	5/109	SK827041-DG	5/111	KC6-22Z-P-01	GJH1213009R0221	3/24		
	SK824441-DF	5/109	SK827041-DT	5/111	KC6-22Z-P-04	GJH1213009R0224	3/24		
	SK824441-DG	5/109	SK827041-DU	5/111	KC6-22Z-P-05	GJH1213009R0225	3/24		
	SK824441-DT	5/109	SK827043-AD	5/115	KC6-22Z-P-07	GJH1213009R0227	3/24		
	SK824441-DU	5/109	SK827043-AR	5/115	KC6-22Z-P-16	GJH1213009R1226	3/24		
	EK150-40-22	SK824451-AD	5/114	SK827043-EF	5/115	KC6-31Z-01	GJH1213001R0311	3/14	
SK824451-AE		5/114	SK827043-EG	5/115	KC6-31Z-04	GJH1213001R0314	3/14		
SK824451-AF		5/114	SK827043-EL	5/115	KC6-31Z-05	GJH1213001R0315	3/14		
SK824451-AL		5/114	SK827043-EM	5/115	KC6-31Z-07	GJH1213001R0317	3/14		
SK824451-AM		5/114	SK827043-EP	5/115	KC6-31Z-1.4-81	GJH1213001R8311	3/15		
SK824451-AN		5/114	SK827043-ER	5/115	KC6-31Z-13	GJH1213001R1313	3/14		
SK824451-AP		5/114	FS116	1SAM201909R1001	2/8	KC6-31Z-16	GJH1213001R1316	3/14	
EK175-40-11		SK825440-AD	5/110	HK1-02	1SAM201902R1003	2/9	KC6-31Z-2.4-51	GJH1213001R5311	3/15
		SK825440-AE	5/110	HK1-11	1SAM201902R1001	2/9	KC6-31Z-F-01	GJH1213003R0311	3/35
		SK825440-AF	5/110	HK1-20	1SAM201902R1002	2/9	KC6-31Z-F-04	GJH1213003R0314	3/35
	SK825440-AL	5/110	HK1-20L	1SAM201902R1004	2/9	KC6-31Z-F-05	GJH1213003R0315	3/35	
	SK825440-AM	5/110	HK4-11	1SAM401901R1001	2/43	KC6-31Z-F-07	GJH1213003R0317	3/35	
	SK825440-AN	5/110	HK4-W	1SAM401901R1002	2/43	KC6-31Z-F-1.4-81	GJH1213003R8311	3/36	
	SK825440-AP	5/110	HKF1-11	1SAM201901R1001	2/9	KC6-31Z-F-16	GJH1213003R1316	3/35	
	SK825440-AR	5/110	HKF1-20	1SAM201901R1002	2/9	KC6-31Z-F-51	GJH1213003R5311	3/36	
	EK175-40-21	SK825440-DA	5/111	HK54-02	1SAM401902R1003	2/43	KC6-31Z-P-01	GJH1213009R0311	3/24
		SK825440-DB	5/111	HK54-11	1SAM401902R1001	2/43	KC6-31Z-P-04	GJH1213009R0314	3/24
SK825440-DC		5/111	HK54-20	1SAM401902R1002	2/43	KC6-31Z-P-05	GJH1213009R0315	3/24	
SK825440-DD		5/111	HTP500-BA4	1SNA235712R2400	4/80	KC6-31Z-P-1.4-81	GJH1213009R8311	3/26	
SK825440-DE		5/111	IB132-G	1SAM201911R1010	2/13	KC6-31Z-P-16	GJH1213009R1316	3/24	
SK825440-DF		5/111	IB132-Y	1SAM201911R1011	2/13	KC6-31Z-P-2.4-51	GJH1213009R5311	3/26	
SK825440-DG		5/111	K6-22Z-01	GJH1211001R0221	3/13	K6-40E-01	GJH1213001R0401	3/14	
EK175-40-22		SK825440-DT	5/111	K6-22Z-02	GJH1211001R0222	3/13	K6-40E-04	GJH1213001R0404	3/14
		SK825440-DU	5/111	K6-22Z-03	GJH1211001R0223	3/13	K6-40E-05	GJH1213001R0405	3/14
		SK825448-AD	5/115	K6-22Z-80	GJH1211001R8220	3/13	K6-40E-07	GJH1213001R0407	3/14
	SK825448-AE	5/115	K6-22Z-84	GJH1211001R8224	3/13	K6-40E-1.4-81	GJH1213001R8401	3/15	
	SK825448-AF	5/115	K6-22Z-85	GJH1211001R8225	3/13	KC6-40E-13	GJH1213001R1403	3/14	
	SK825448-AL	5/115	K6-22Z-F-01	GJH1211003R0221	3/34	KC6-40E-16	GJH1213001R1406	3/14	
	SK825448-AM	5/115	K6-22Z-F-02	GJH1211003R0222	3/34	KC6-40E-2.4-51	GJH1213001R5401	3/15	
	SK825448-AN	5/115	K6-22Z-F-03	GJH1211003R0223	3/34	KC6-40E-F-01	GJH1213003R0401	3/35	
	EK210-40-11	SK825448-AR	5/115	K6-22Z-F-80	GJH1211003R8220	3/34	KC6-40E-F-04	GJH1213003R0404	3/35
		SK825441-AD	5/110	K6-22Z-F-84	GJH1211003R8224	3/34	KC6-40E-F-05	GJH1213003R0405	3/35
SK825441-AE		5/110	K6-22Z-F-85	GJH1211003R8225	3/34	KC6-40E-F-1.4-81	GJH1213003R8401	3/36	
SK825441-AF		5/110	K6-22Z-P-01	GJH1211009R0221	3/23	KC6-40E-F-16	GJH1213003R1406	3/35	
SK825441-AL		5/110	K6-22Z-P-02	GJH1211009R0222	3/23	KC6-40E-F-51	GJH1213003R5401	3/36	
SK825441-AM		5/110	K6-22Z-P-03	GJH1211009R0223	3/23	KC6-40E-P-01	GJH1213009R0401	3/24	
SK825441-AN		5/110	K6-22Z-P-80	GJH1211009R8220	3/23	KC6-40E-P-04	GJH1213009R0404	3/24	
SK825441-AR		5/110	K6-22Z-P-84	GJH1211009R8224	3/23	KC6-40E-P-05	GJH1213009R0405	3/24	
EK210-40-21		SK825441-DA	5/111	K6-22Z-P-85	GJH1211009R8225	3/23	KC6-40E-P-07	GJH1213009R0407	3/24
		SK825441-DB	5/111	K6-31Z-01	GJH1211001R0311	3/13	KC6-40E-P-1.4-81	GJH1213009R8401	3/26
	SK825441-DC	5/111	K6-31Z-02	GJH1211001R0312	3/13	KC6-40E-P-16	GJH1213009R1406	3/24	
	SK825441-DD	5/111	K6-31Z-03	GJH1211001R0313	3/13	KC6-40E-P-2.4-51	GJH1213009R5401	3/26	
	SK825441-DE	5/111	K6-31Z-80	GJH1211001R8310	3/13	KH210	SK825400-AD	5/265	
	SK825441-DF	5/111	K6-31Z-84	GJH1211001R8314	3/13	SK825400-AE	5/265		
	SK825441-DD	5/111	K6-31Z-85	GJH1211001R8315	3/13	SK825400-AF	5/265		
	SK825441-DE	5/111	K6-31Z-F-01	GJH1211003R0311	3/34	SK825400-AL	5/265		
	SK825441-DF	5/111	K6-31Z-F-02	GJH1211003R0312	3/34	SK825400-AM	5/265		



# Index

## Type classification

Type	Order code	Page	Type	Order code	Page	Type	Order code	Page
KH300	SK825400-AN	5/265	LT800E	1SAX601904R0001	7/45	MS132-20-HKF1-11	1SAM350005R1013	2/15
	SK825400-AP	5/265	LW110	1SFN074307R1000	5/250	MS132-25	1SAM350000R1014	2/15
	SK825400-AR	5/265	LW1250	1SFN076407R1000	5/23	MS132-25-HKF1-11	1SAM350005R1014	2/15
	SK826400-AD	5/265	LW140	1SFN074207R1000	5/15	MS132-32	1SAM350000R1015	2/15
	SK826400-AE	5/265	LW205	1SFN074807R1000	5/15	MS132-32-HKF1-11	1SAM350005R1015	2/15
	SK826400-AF	5/265	LW370	1SFN075407R1000	5/15	MS132-4.0	1SAM350000R1008	2/15
	SK826400-AL	5/265	LW460	1SFN075707R1000	5/23	MS132-4.0-HKF1-11	1SAM350005R1008	2/15
	SK826400-AM	5/265	LW750	1SFN076107R1000	5/23	MS132-6.3	1SAM350000R1009	2/15
	SK826400-AN	5/265	LX140	1SFN074210R1000	5/15	MS132-6.3-HKF1-11	1SAM350005R1009	2/15
	SK826400-AP	5/265	LX205	1SFN074810R1000	5/15	MS450-40	1SAM450000R1005	2/38
KH800	SK826400-AR	5/265	LX370	1SFN075410R1000	5/15	MS450-45	1SAM450000R1006	2/38
	SK828100-AD	5/265	LX460	1SFN075710R1000	5/23	MS450-50	1SAM450000R1007	2/38
	SK828100-AR	5/265	LX750	1SFN076110R1000	5/23	MS495-100	1SAM550000R1010	2/38
	SK828100-EF	5/265	LY140	1SFN074203R1000	5/220	MS495-63	1SAM550000R1007	2/38
	SK828100-EG	5/265	LY16-4	1SBN071303T1000	5/220	MS495-75	1SAM550000R1008	2/38
	SK828100-EL	5/265	LY185	1SFN074703R1000	5/220	MS495-90	1SAM550000R1009	2/38
	SK828100-EM	5/265	LY300	1SFN075103R1000	5/220	MS497-100	1SAM580000R1010	2/38
	SK828100-EP	5/265	LY38-4	1SBN072303T1000	5/220	MS497-32	1SAM580000R1004	2/38
	SK828100-ER	5/265	LY460	1SFN075703R1000	5/220	MS497-40	1SAM580000R1005	2/38
	SK825450-DA	5/266	LY750	1SFN076103R1000	5/220	MS497-50	1SAM580000R1006	2/38
KP210	SK825450-DB	5/266	MO132-0.16	1SAM360000R1001	2/26	MS497-63	1SAM580000R1007	2/38
	SK825450-DC	5/266	MO132-0.25	1SAM360000R1002	2/26	MS497-75	1SAM580000R1008	2/38
	SK825450-DD	5/266	MO132-0.4	1SAM360000R1003	2/26	MS497-90	1SAM580000R1009	2/38
	SK825450-DE	5/266	MO132-0.63	1SAM360000R1004	2/26	MSH-AR	1SAM201920R1000	2/14
	SK825450-DF	5/266	MO132-1.0	1SAM360000R1005	2/26	MSHD-LB	1SAM201920R1001	2/14
	SK825450-DG	5/266	MO132-1.6	1SAM360000R1006	2/26	MSHD-LTB	1SAM201920R1011	2/25
	SK825450-DT	5/266	MO132-10	1SAM360000R1010	2/26	MSHD-LTY	1SAM201920R1012	2/25
	SK825450-DU	5/266	MO132-12	1SAM360000R1012	2/26	MSHD-LY	1SAM201920R1002	2/14
	SK825450-EF	5/266	MO132-16	1SAM360000R1011	2/26	MSMN	1SAM101923R0002	2/14
	SK825450-EG	5/266	MO132-2.5	1SAM360000R1007	2/26	MSMNO	1SAM101923R0012	2/14
KP300	SK825450-EL	5/266	MO132-20	1SAM360000R1013	2/26	MSOX-30	1SAM101924R0013	2/14
	SK825450-EM	5/266	MO132-25	1SAM360000R1014	2/26	MSOX-32	1SAM101924R0003	2/14
	SK825450-EP	5/266	MO132-32	1SAM360000R1015	2/26	NF22E-12	1SBH137001R1222	5/180
	SK825450-ER	5/266	MO132-4.0	1SAM360000R1008	2/26	NF22E-13	1SBH137001R1322	5/180
	SK826450-DA	5/266	MO132-6.3	1SAM360000R1009	2/26	NF22E-14	1SBH137001R1422	5/180
	SK826450-DB	5/266	MO450-40	1SAM460000R1005	2/47	NF22E-41	1SBH137001R4122	5/180
	SK826450-DC	5/266	MO450-45	1SAM460000R1006	2/47	NF22ES-12	1SBH137004R1222	6/60
	SK826450-DD	5/266	MO450-50	1SAM460000R1007	2/47	NF22ES-13	1SBH137004R1322	6/60
	SK826450-DE	5/266	MO495-100	1SAM560000R1010	2/47	NF22ES-14	1SBH137004R1422	6/60
	SK826450-DF	5/266	MO495-63	1SAM560000R1007	2/47	NF22ES-41	1SBH137004R4122	6/60
KP800	SK826450-DT	5/266	MO495-75	1SAM560000R1008	2/47	NF31E-12	1SBH137001R1231	5/180
	SK826450-DG	5/266	MO495-90	1SAM560000R1009	2/47	NF31E-13	1SBH137001R1331	5/180
	SK826450-DH	5/266	MO496-100	1SAM590000R1010	2/47	NF31E-14	1SBH137001R1431	5/180
	SK826450-DI	5/266	MO496-32	1SAM590000R1004	2/47	NF31E-41	1SBH137001R4131	5/180
	SK826450-EF	5/266	MO496-40	1SAM590000R1005	2/47	NF31ES-12	1SBH137004R1231	6/60
	SK826450-EG	5/266	MO496-50	1SAM590000R1006	2/47	NF31ES-13	1SBH137004R1331	6/60
	SK826450-EL	5/266	MO496-63	1SAM590000R1007	2/47	NF31ES-14	1SBH137004R1431	6/60
	SK826450-EM	5/266	MO496-75	1SAM590000R1008	2/47	NF31ES-41	1SBH137004R4131	6/60
	SK826450-EP	5/266	MO496-90	1SAM590000R1009	2/47	NF40E-12	1SBH137001R1240	5/180
	SK828150-DB	5/266	MS116-0.16	1SAM250000R1001	2/4	NF40E-13	1SBH137001R1340	5/180
KPR-101L	SK828150-DC	5/266	MS116-0.16-HKF1-11	1SAM250005R1001	2/4	NF40E-14	1SBH137001R1440	5/180
	SK828150-DD	5/266	MS116-0.25	1SAM250000R1002	2/4	NF40E-41	1SBH137001R4140	5/180
	SK828150-DE	5/266	MS116-0.25-HKF1-11	1SAM250005R1002	2/4	NF40ES-12	1SBH137004R1240	6/60
	SK828150-DF	5/266	MS116-0.4	1SAM250000R1003	2/4	NF40ES-13	1SBH137004R1340	6/60
	SK828150-DG	5/266	MS116-0.4-HKF1-11	1SAM250005R1003	2/4	NF40ES-14	1SBH137004R1440	6/60
	SK828150-DI	5/266	MS116-0.63	1SAM250000R1004	2/4	NF40ES-41	1SBH137004R4140	6/60
	SK828150-DJ	5/266	MS116-0.63-HKF1-11	1SAM250005R1004	2/4	NF44E-12	1SBH137001R1244	5/184
	1SFA6116162R1014	7/4	MS116-1.0	1SAM250000R1005	2/4	NF44E-13	1SBH137001R1344	5/184
	SK827204-F	5/264	MS116-1.0-HKF1-11	1SAM250005R1005	2/4	NF44E-14	1SBH137001R1444	5/184
	SK824204-A	5/264	MS116-1.6	1SAM250000R1006	2/4	NF44E-41	1SBH137001R4144	5/184
SK824204-B	5/264	MS116-1.6-HKF1-11	1SAM250005R1006	2/4	NF44ES-12	1SBH137004R1244	6/62	
KZK110	SK825204-A	5/264	MS116-10	1SAM250000R1010	2/4	NF44ES-13	1SBH137004R1344	6/62
	SK825204-B	5/264	MS116-10.0-HKF1-11	1SAM250005R1010	2/4	NF44ES-14	1SBH137004R1444	6/62
	SK827204-A	5/264	MS116-12	1SAM250000R1012	2/4	NF44ES-41	1SBH137004R4144	6/62
	SK827204-B	5/264	MS116-12.0-HKF1-11	1SAM250005R1012	2/4	NF53E-12	1SBH137001R1253	5/184
	GJL1201902R0001	3/37	MS116-16	1SAM250000R1011	2/4	NF53E-13	1SBH137001R1353	5/184
	GJL1201903R0001	3/37	MS116-16.0-HKF1-11	1SAM250005R1011	2/4	NF53E-14	1SBH137001R1453	5/184
	1SFN074208R1000	5/219	MS116-2.5	1SAM250000R1007	2/4	NF53E-41	1SBH137001R4153	5/184
	1SBN073508R1000	5/248	MS116-2.5-HKF1-11	1SAM250005R1007	2/4	NF53ES-12	1SBH137004R1253	6/62
	1SBN070156T1000	5/183	MS116-20	1SAM250000R1013	2/4	NF53ES-13	1SBH137004R1353	6/62
	1SBN070157T1000	6/47	MS116-20-HKF1-11	1SAM250005R1013	2/4	NF53ES-14	1SBH137004R1453	6/62
LD6-CA	FPTN472735R0001	5/250	MS116-25	1SAM250000R1014	2/4	NF53ES-41	1SBH137004R4153	6/62
	PFTN472734R0001	5/250	MS116-25-HKF1-11	1SAM250005R1014	2/4	NF62E-12	1SBH137001R1262	5/184
	1SBN073552R1002	5/249	MS116-32	1SAM250000R1015	2/4	NF62E-13	1SBH137001R1362	5/184
	1SBN073552R1003	5/249	MS116-32-HKF1-11	1SAM250005R1015	2/4	NF62E-14	1SBH137001R1462	5/184
	1SFN074211R1000	5/219	MS116-4.0	1SAM250000R1008	2/4	NF62E-41	1SBH137001R4162	5/184
	1SFN074712R1000	5/220	MS116-4.0-HKF1-11	1SAM250005R1008	2/4	NF62ES-12	1SBH137004R1262	6/62
	1SFN075112R1000	5/220	MS116-6.3	1SAM250000R1009	2/4	NF62ES-13	1SBH137004R1362	6/62
	1SFN075712R1000	5/220	MS116-6.3-HKF1-11	1SAM250005R1009	2/4	NF62ES-14	1SBH137004R1462	6/62
	GJL1201907R0001	3/37	MS132-0.16	1SAM350000R1001	2/15	NF62ES-41	1SBH137004R4162	6/62
	1SFN076112R1000	5/220	MS132-0.16-HKF1-11	1SAM350005R1001	2/15	NF71E-12	1SBH137001R1271	5/184
LT1000-EK	SK178001-MB	5/262	MS132-0.25	1SAM350000R1002	2/15	NF71E-13	1SBH137001R1371	5/184
	1SFN124203R1000	5/15	MS132-0.25-HKF1-11	1SAM350005R1002	2/15	NF71E-14	1SBH137001R1471	5/184
	SK178001-HB	5/262	MS132-0.4	1SAM350000R1003	2/15	NF71E-41	1SBH137001R4171	5/184
	1SAZ401901R1001	7/24	MS132-0.4-HKF1-11	1SAM350005R1003	2/15	NF71ES-12	1SBH137004R1271	6/62
	1SFN124801R1000	5/15	MS132-0.63	1SAM350000R1004	2/15	NF71ES-13	1SBH137004R1371	6/62
	1SFN124803R1000	5/15	MS132-0.63-HKF1-11	1SAM350005R1004	2/15	NF71ES-14	1SBH137004R1471	6/62
	1SFN124804R1000	5/15	MS132-1.0	1SAM350000R1005	2/15	NF71ES-41	1SBH137004R4171	6/62
	SK178001-KB	5/262	MS132-1.0-HKF1-11	1SAM350005R1005	2/15	NF80E-12	1SBH137001R1280	5/184
	1SFN125401R1000	5/15	MS132-1.6	1SAM350000R1006	2/15	NF80E-13	1SBH137001R1380	5/184
	1SFN125406R1000	5/15	MS132-1.6-HKF1-11	1SAM350005R1006	2/15	NF80E-14	1SBH137001R1480	5/184
LT370-30L	1SFN125403R1000	5/15	MS132-10	1SAM350000R1010	2/15	NF80E-41	1SBH137001R4180	5/184
	1SFN125404R1000	5/15	MS132-10.0-HKF1-11	1SAM350005R1010	2/15	NF80ES-12	1SBH137004R1280	6/62
	1SFN125701R1000	5/23	MS132-12	1SAM350000R1012	2/15	NF80ES-13	1SBH137004R1380	6/62
	1SFN125703R1000	5/23	MS132-12.0-HKF1-11	1SAM350005R1012	2/15	NF80ES-14	1SBH137004R1480	6/62
	1SAX701904R0001	7/45	MS132-16	1SAM350000R1011	2/15	NF80ES-41	1SBH137004R4180	6/62
	SK178001-LB	5/262	MS132-16.0-HKF1-11	1SAM350005R1011	2/15	NFZ22E-20	1SBH136001R2022	5/181
	GJL1201906R0001	3/37	MS132-2.5	1SAM350000R1007	2/15	NFZ22E-21	1SBH136001R2122	5/181
	1SFN126101R1000	5/23	MS132-2.5-HKF1-11	1SAM350005R1007	2/15	NFZ22E-22	1SBH136001R2222	5/181
	1SFN126103R1000	5/23	MS132-20	1SAM350000R1013	2/15	NFZ22E-23</		

# Index

## Type classification

Type	Order code	Page	Type	Order code	Page	Type	Order code	Page
NFZ22ES-20	1SBH136004R2022	6/61	NS62E-16	1SBH101001R1662	4/60	PN750-41	1SFN096103R1000	5/224
NFZ22ES-21	1SBH136004R2122	6/61	NS62E-20	1SBH101001R2062	4/60	PR146-1	1SFN094200R1000	5/225
NFZ22ES-22	1SBH136004R2222	6/61	NS62E-26	1SBH101001R2662	4/60	PR185-2	1SFN095100R1001	5/225
NFZ22ES-23	1SBH136004R2322	6/61	NS62E-28	1SBH101001R2862	4/60	PR210-1	1SFN094900R1000	5/225
NFZ31E-20	1SBH136001R2031	5/181	NS62ES-16	1SBH101004R1662	6/20	PR300-1	1SFN095300R1000	5/225
NFZ31E-21	1SBH136001R2131	5/181	NS62ES-20	1SBH101004R2062	6/20	PR300-2	1SFN095300R1001	5/225
NFZ31E-22	1SBH136001R2231	5/181	NS62ES-26	1SBH101004R2662	6/20	PR400-2	1SFN095700R1002	5/225
NFZ31E-23	1SBH136001R2331	5/181	NS62ES-28	1SBH101004R2862	6/20	PR460-1	1SFN095700R1000	5/225
NFZ31ES-20	1SBH136004R2031	6/61	NS71E-16	1SBH101001R1671	4/60	PR460-2	1SFN095700R1001	5/225
NFZ31ES-21	1SBH136004R2131	6/61	NS71E-20	1SBH101001R2071	4/60	PR580-2	1SFN096100R1002	5/225
NFZ31ES-22	1SBH136004R2231	6/61	NS71E-26	1SBH101001R2671	4/60	PR750-1	1SFN096100R1000	5/225
NFZ31ES-23	1SBH136004R2331	6/61	NS71E-28	1SBH101001R2871	4/60	PR750-2	1SFN096100R1001	5/225
NFZ40E-20	1SBH136001R2040	5/181	NS71ES-16	1SBH101004R1671	6/20	PS1-2-0-65	1SAM201906R1102	2/8
NFZ40E-21	1SBH136001R2140	5/181	NS71ES-20	1SBH101004R2071	6/20	PS1-2-1-65	1SAM201906R1112	2/8
NFZ40E-22	1SBH136001R2240	5/181	NS71ES-26	1SBH101004R2671	6/20	PS1-2-2-65	1SAM201906R1122	2/8
NFZ40E-23	1SBH136001R2340	5/181	NS71ES-28	1SBH101004R2871	6/20	PS1-3-0-100	1SAM201916R1103	2/8
NFZ40ES-20	1SBH136004R2040	6/61	NS80E-16	1SBH101001R1680	4/60	PS1-3-0-65	1SAM201906R1103	2/8
NFZ40ES-21	1SBH136004R2140	6/61	NS80E-20	1SBH101001R2080	4/60	PS1-3-1-100	1SAM201916R1113	2/8
NFZ40ES-22	1SBH136004R2240	6/61	NS80E-26	1SBH101001R2680	4/60	PS1-3-1-65	1SAM201906R1113	2/8
NFZ40ES-23	1SBH136004R2340	6/61	NS80E-28	1SBH101001R2880	4/60	PS1-3-2-100	1SAM201916R1123	2/8
NFZ44E-20	1SBH136001R2044	5/185	NS80ES-16	1SBH101004R1680	6/20	PS1-3-2-65	1SAM201906R1123	2/8
NFZ44E-21	1SBH136001R2144	5/185	NS80ES-20	1SBH101004R2080	6/20	PS1-4-0-100	1SAM201916R1104	2/8
NFZ44E-22	1SBH136001R2244	5/185	NS80ES-26	1SBH101004R2680	6/20	PS1-4-0-65	1SAM201906R1104	2/8
NFZ44E-23	1SBH136001R2344	5/185	NS80ES-28	1SBH101004R2880	6/20	PS1-4-1-100	1SAM201916R1114	2/8
NFZ44ES-20	1SBH136004R2044	6/63	NLSL22E-81	1SBH103001R8122	4/61	PS1-4-1-65	1SAM201906R1114	2/8
NFZ44ES-21	1SBH136004R2144	6/63	NLSL22E-83	1SBH103001R8322	4/61	PS1-4-2-65	1SAM201906R1124	2/8
NFZ44ES-22	1SBH136004R2244	6/63	NLSL22E-86	1SBH103001R8622	4/61	PS1-5-0-100	1SAM201916R1105	2/8
NFZ44ES-23	1SBH136004R2344	6/63	NLSL22E-88	1SBH103001R8822	4/61	PS1-5-0-65	1SAM201906R1105	2/8
NFZ53E-20	1SBH136001R2053	5/185	NLSL22E-81	1SBH103004R8122	6/21	PS1-5-1-100	1SAM201916R1115	2/8
NFZ53E-21	1SBH136001R2153	5/185	NLSL22ES-83	1SBH103004R8322	6/21	PS1-5-1-65	1SAM201906R1115	2/8
NFZ53E-22	1SBH136001R2253	5/185	NLSL22ES-86	1SBH103004R8622	6/21	PS1-5-2-65	1SAM201906R1125	2/8
NFZ53E-23	1SBH136001R2353	5/185	NLSL22ES-88	1SBH103004R8822	6/21	PS4-2-0	1SAM401911R1001	2/42
NFZ53ES-20	1SBH136004R2053	6/63	NLSL31E-81	1SBH103001R8131	4/61	PS4-2-2	1SAM401911R1004	2/42
NFZ53ES-21	1SBH136004R2153	6/63	NLSL31E-83	1SBH103001R8331	4/61	PS4-3-0	1SAM401911R1002	2/42
NFZ53ES-22	1SBH136004R2253	6/63	NLSL31E-86	1SBH103001R8631	4/61	PS4-3-2	1SAM401911R1005	2/42
NFZ53ES-23	1SBH136004R2353	6/63	NLSL31E-88	1SBH103001R8831	4/61	PS4-4-0	1SAM401911R1003	2/42
NFZ62E-20	1SBH136001R2062	5/185	NLSL31ES-81	1SBH103004R8131	6/21	PS4-4-2	1SAM401911R1006	2/42
NFZ62E-21	1SBH136001R2162	5/185	NLSL31ES-83	1SBH103004R8331	6/21	RA5-1	1SBN060300R1000	5/244
NFZ62E-22	1SBH136001R2262	5/185	NLSL31ES-86	1SBH103004R8631	6/21		1SBN060300T1000	5/244
NFZ62E-23	1SBH136001R2362	5/185	NLSL31ES-88	1SBH103004R8831	6/21	RC5-1/133	1SBN050100R1001	4/37
NFZ62ES-20	1SBH136004R2062	6/63	NLSL40E-81	1SBH103001R8140	4/61	RC5-1/250	1SBN050100R1002	4/37
NFZ62ES-21	1SBH136004R2162	6/63	NLSL40E-83	1SBH103001R8340	4/61	RC5-1/440	1SBN050100R1003	4/37
NFZ62ES-22	1SBH136004R2262	6/63	NLSL40E-86	1SBH103001R8640	4/61	RC5-1/50	1SBN050100R1000	4/37
NFZ62ES-23	1SBH136004R2362	6/63	NLSL40E-88	1SBH103001R8840	4/61	RC5-2/133	1SBN050200R1001	5/103
NFZ71E-20	1SBH136001R2071	5/185	NLSL40ES-81	1SBH103004R8140	6/21	RC5-2/250	1SBN050200R1002	5/103
NFZ71E-21	1SBH136001R2171	5/185	NLSL40ES-83	1SBH103004R8340	6/21	RC5-2/440	1SBN050200R1003	5/103
NFZ71E-22	1SBH136001R2271	5/185	NLSL40ES-86	1SBH103004R8640	6/21	RC5-2/50	1SBN050200R1000	5/103
NFZ71E-23	1SBH136001R2371	5/185	NLSL40ES-88	1SBH103004R8840	6/21	RC-EH300/415	SK829007-B	5/119
NFZ71ES-20	1SBH136004R2071	6/63	NLSL44E-81	1SBH103001R8144	4/61	RC-EH300/48	SK829007-A	5/119
NFZ71ES-21	1SBH136004R2171	6/63	NLSL44E-83	1SBH103001R8344	4/61	RC-EH800/110	SK829007-C	5/119
NFZ71ES-22	1SBH136004R2271	6/63	NLSL44E-86	1SBH103001R8644	4/61	RC-EH800/600	SK829007-D	5/119
NFZ71ES-23	1SBH136004R2371	6/63	NLSL44E-88	1SBH103001R8844	4/61		1SBN050020R1003	4/37
NFZ80E-20	1SBH136001R2080	5/185	NLSL44ES-81	1SBH103004R8144	6/21	RT5/150	1SBN050020R1004	4/37
NFZ80E-21	1SBH136001R2180	5/185	NLSL44ES-83	1SBH103004R8344	6/21	RT5/264	1SBN050020R1000	4/37
NFZ80E-22	1SBH136001R2280	5/185	NLSL44ES-86	1SBH103004R8644	6/21	RT5/32	1SBN050020R1000	4/37
NFZ80E-23	1SBH136001R2380	5/185	NLSL44ES-88	1SBH103004R8844	6/21	RT5/65	1SBN050020R1001	4/37
NFZ80ES-20	1SBH136004R2080	6/63	NLSL53E-81	1SBH103001R8153	4/61	RT5/90	1SBN050020R1002	4/37
NFZ80ES-21	1SBH136004R2180	6/63	NLSL53E-83	1SBH103001R8353	4/61	RV5/133	1SBN050010R1001	4/37
NFZ80ES-22	1SBH136004R2280	6/63	NLSL53E-86	1SBH103001R8653	4/61	RV5/250	1SBN050010R1002	4/37
NFZ80ES-23	1SBH136004R2380	6/63	NLSL53E-88	1SBH103001R8853	4/61	RV5/440	1SBN050010R1003	4/37
NS22E-16	1SBH101001R1622	4/60	NLSL53ES-81	1SBH103004R8153	6/21	RV5/50	1SBN050010R1000	4/37
NS22E-20	1SBH101001R2022	4/60	NLSL53ES-83	1SBH103004R8353	6/21	RV-BC6/250	GHV2501903R0002	3/37
NS22E-26	1SBH101001R2622	4/60	NLSL53ES-86	1SBH103004R8653	6/21	RV-BC6/380	GHV2501904R0002	3/37
NS22E-28	1SBH101001R2822	4/60	NLSL53ES-88	1SBH103004R8853	6/21	RV-BC6/60	GHV2501902R0002	3/37
NS22ES-16	1SBH101004R1622	6/20	NLSL62E-81	1SBH103001R8162	4/61	RV-BC6-F/250	GHV2501903R0003	3/37
NS22ES-20	1SBH101004R2022	6/20	NLSL62E-83	1SBH103001R8362	4/61	RV-BC6-F/380	GHV2501904R0003	3/37
NS22ES-26	1SBH101004R2622	6/20	NLSL62E-86	1SBH103001R8662	4/61	RV-BC6-F/60	GHV2501902R0003	3/37
NS22ES-28	1SBH101004R2822	6/20	NLSL62E-88	1SBH103001R8862	4/61	S1-M1-25	1SAM201907R1101	2/8
NS31E-16	1SBH101001R1631	4/60	NLSL62ES-81	1SBH103004R8162	6/21	S1-M2-25	1SAM201907R1102	2/8
NS31E-20	1SBH101001R2031	4/60	NLSL62ES-83	1SBH103004R8362	6/21	S1-M3-25	1SAM201907R1103	2/8
NS31E-26	1SBH101001R2631	4/60	NLSL62ES-86	1SBH103004R8662	6/21	S1-M3-35	1SAM201913R1103	2/8
NS31E-28	1SBH101001R2831	4/60	NLSL62ES-88	1SBH103004R8862	6/21	S4-M1	1SAM401911R1007	2/42
NS31ES-16	1SBH101004R1631	6/20	NLSL71E-81	1SBH103001R8171	4/61	S801S-SCL100-SR	2CCS801901R0639	10/2
NS31ES-20	1SBH101004R2031	6/20	NLSL71E-83	1SBH103001R8371	4/61	S801S-SCL32-SR	2CCS801901R0539	10/2
NS31ES-26	1SBH101004R2631	6/20	NLSL71E-86	1SBH103001R8671	4/61	S801S-SCL63-SR	2CCS801901R0599	10/2
NS31ES-28	1SBH101004R2831	6/20	NLSL71E-88	1SBH103001R8871	4/61	S802S-SCL100-SR	2CCS802901R0639	10/2
NS40E-16	1SBH101001R1640	4/60	NLSL71ES-81	1SBH103004R8171	6/21	S802S-SCL32-SR	2CCS802901R0539	10/2
NS40E-20	1SBH101001R2040	4/60	NLSL71ES-83	1SBH103004R8371	6/21	S802S-SCL63-SR	2CCS802901R0599	10/2
NS40E-26	1SBH101001R2640	4/60	NLSL71ES-86	1SBH103004R8671	6/21	S803S-SCL100-SR	2CCS803901R0639	10/2
NS40E-28	1SBH101001R2840	4/60	NLSL71ES-88	1SBH103004R8871	6/21	S803S-SCL32-SR	2CCS803901R0539	10/2
NS40ES-16	1SBH101004R1640	6/20	NLSL80E-81	1SBH103001R8180	4/61	S803S-SCL63-SR	2CCS803901R0599	10/2
NS40ES-20	1SBH101004R2040	6/20	NLSL80E-83	1SBH103001R8380	4/61	S803W-SCL100-SR	2CCS803917R0639	10/2
NS40ES-26	1SBH101004R2640	6/20	NLSL80E-86	1SBH103001R8680	4/61	S803W-SCL32-SR	2CCS803917R0539	10/2
NS40ES-28	1SBH101004R2840	6/20	NLSL80E-88	1SBH103001R8880	4/61	S803W-SCL63-SR	2CCS803917R0599	10/2
NS44E-16	1SBH101001R1644	4/60	NLSL80ES-81	1SBH103004R8180	6/21	SA1	GUJ1101903R0001	2/8
NS44E-20	1SBH101001R2044	4/60	NLSL80ES-83	1SBH103004R8380	6/21	SA2	GUJ1101903R0002	2/8
NS44E-26	1SBH101001R2644	4/60	NLSL80ES-86	1SBH103004R8680	6/21	SA3	GUJ1101903R0003	2/8
NS44E-28	1SBH101001R2844	4/60	NLSL80ES-88	1SBH103004R8880	6/21	SK1-02	1SAM201903R1003	2/9
NS44ES-16	1SBH101004R1644	6/20	OESA460H/OESA400	1SFN085709R1000	5/223	SK1-11	1SAM201903R1001	2/9
NS44ES-20	1SBH101004R2044	6/20	OX56X105	1SCA108043R1001	2/14	SK1-20	1SAM201903R1002	2/9
NS44ES-26	1SBH101004R2644	6/20	OX56X130	1SCA101655R1001	2/14	SK4-11	1SAM401904R1001	2/43
NS44ES-28	1SBH101004R2844	6/20	OX56X180	1SCA101659R1001	2/14	SPRC-1	1SNA360010R1500	4/80
NS53E-16	1SBH101001R1653	4/60	OX56X85	1SCA101647R1001	2/14	T16-0-13	1SAZ711201R1005	7/4
NS53E-20	1SBH101001R2053	4/60	PN2-10-22	SK829075-C	5/263	T16-0-17	1SAZ711201R1008	7/4
NS53E-26	1SBH101001R2653	4/60	PN300-22	SK829075-E	5/263	T16-0-23	1SAZ711201R1009	7/4
NS53E-28	1SBH101001R2853	4/60	PN460-11	1SFN095705R1000	5/224	T16-0-31	1SAZ711201R1013	7/4
NS53ES-16	1SBH101004R1653	6/20	PN460-21	1SFN095701R1000	5/224	T16-0-41		

Type	Order code	Page	Type	Order code	Page	Type	Order code	Page
T16-1.7	1SAZ711201R1028	7/4	TKC6-22Z-51	GJH1213061R5221	3/16	UA50-30-11	1SBL351022R8011	5/169
T16-10	1SAZ711201R1043	7/4	TKC6-22Z-55	GJH1213061R5225	3/16		1SBL351022R8111	5/169
T16-13	1SAZ711201R1045	7/4	TKC6-22Z-62	GJH1213061R6222	3/16		1SBL351022R8311	5/169
T16-16	1SAZ711201R1047	7/4	TKC6-22Z-68	GJH1213061R6228	3/16		1SBL351022R8411	5/169
T16-2.3	1SAZ711201R1031	7/4	TKC6-31Z-51	GJH1213061R5311	3/16		1SBL351022R8511	5/169
T16-3.1	1SAZ711201R1033	7/4	TKC6-31Z-55	GJH1213061R5315	3/16		1SBL351022R8611	5/169
T16-4.2	1SAZ711201R1035	7/4	TKC6-31Z-62	GJH1213061R6312	3/16		1SBL351022R8711	5/169
T16-5.7	1SAZ711201R1038	7/4	TKC6-31Z-68	GJH1213061R6318	3/16		1SBL351022R8811	5/169
T16-7.6	1SAZ711201R1040	7/4	TKC6-40E-51	GJH1213061R5401	3/16		1SBL371022R8000	5/168
TA200DU-110	1SAZ421201R1002	7/24	TKC6-40E-55	GJH1213061R5405	3/16		1SBL371022R8100	5/168
TA200DU-135	1SAZ421201R1003	7/24	TKC6-40E-62	GJH1213061R6402	3/16		1SBL371022R8300	5/168
TA200DU-150	1SAZ421201R1004	7/24	TKC6-40E-68	GJH1213061R6408	3/16		1SBL371022R8400	5/168
TA200DU-175	1SAZ421201R1005	7/24	UA110-30-00	1SFL451022R8000	5/170		1SBL371022R8500	5/168
TA200DU-200	1SAZ421201R1006	7/24		1SFL451022R8100	5/170		1SBL371022R8600	5/168
TA200DU-90	1SAZ421201R1001	7/24		1SFL451022R8300	5/170		1SBL371022R8700	5/168
TAE45-40-00	1SBL339261R5100	5/104		1SFL451022R8400	5/170		1SBL371022R8800	5/168
	1SBL339261R5200	5/104		1SFL451022R8500	5/170		1SBL371022R8000	5/159
	1SBL339261R5400	5/104		1SFL451022R8600	5/170		1SBL371024R8100	5/159
	1SBL339261R5500	5/104	UA110-30-00RA	1SFL451024R8000	5/160		1SBL371024R8300	5/159
	1SBL339261R5800	5/104		1SFL451024R8100	5/160		1SBL371024R8400	5/159
	1SBL339261R6200	5/104		1SFL451024R8300	5/160		1SBL371024R8500	5/159
	1SBL339261R6600	5/104		1SFL451024R8400	5/160		1SBL371024R8600	5/159
	1SBL339261R6800	5/104		1SFL451024R8500	5/160		1SBL371024R8800	5/159
TAE50-40-00	1SBL359261R5100	5/104		1SFL451024R8600	5/160		1SBL371022R8011	5/169
	1SBL359261R5200	5/104	UA110-30-00RA	1SFL451022R8800	5/170		1SBL371022R8111	5/169
	1SBL359261R5400	5/104		1SFL451022R9000	5/171		1SBL371022R8311	5/169
	1SBL359261R5500	5/104		1SFL451022R9100	5/171		1SBL371022R8411	5/169
	1SBL359261R5800	5/104		1SFL451022R9311	5/171		1SBL371022R8511	5/169
	1SBL359261R6200	5/104	UA110-30-11	1SFL451022R8111	5/171		1SBL371022R8611	5/169
	1SBL359261R6600	5/104		1SFL451022R8311	5/171		1SBL371022R8811	5/169
	1SBL359261R6800	5/104		1SFL451022R8411	5/171		1SBL411022R8000	5/168
TAE75-40-00	1SBL419261R5100	5/104		1SFL451022R8511	5/171		1SBL411022R8100	5/168
	1SBL419261R5200	5/104		1SFL451022R8611	5/171		1SBL411022R8300	5/168
	1SBL419261R5400	5/104		1SFL451022R8811	5/171		1SBL411022R8400	5/168
	1SBL419261R5500	5/104	UA1-110	1SAM201904R1004	2/9		1SBL411022R8500	5/168
	1SBL419261R5800	5/104		1SAM201904R1008	2/9		1SBL411022R8600	5/168
	1SBL419261R6200	5/104	UA1-208	1SAM201904R1008	2/9		1SBL411022R8800	5/168
	1SBL419261R6600	5/104	UA1-230	1SAM201904R1005	2/9		1SBL411024R8000	5/159
	1SBL419261R6800	5/104	UA1-24	1SAM201904R1001	2/9		1SBL411024R8100	5/159
	1SBL419261R6800	5/104	UA1-400	1SAM201904R1006	2/9		1SBL411024R8300	5/159
	1SBL419261R6800	5/104	UA1-415	1SAM201904R1007	2/9		1SBL411024R8400	5/159
	1SBL419261R6800	5/104	UA1-48	1SAM201904R1002	2/9		1SBL411024R8500	5/159
	1SBL419261R6800	5/104	UA1-60	1SAM201904R1003	2/9		1SBL411024R8600	5/159
	1SBL419261R6800	5/104	UA16-30-10	1SBL181022R8010	5/167		1SBL411024R8800	5/159
TB450	1SAM401910R1001	2/42		1SBL181022R8110	5/167		1SBL411024R8000	5/159
TBC7-22-00-55	GJL1313561R5005	3/12		1SBL181022R8310	5/167		1SBL411024R8100	5/159
TBC7-22-00-62	GJL1313561R6002	3/12		1SBL181022R8410	5/167		1SBL411022R8011	5/169
TBC7-22-00-68	GJL1313561R6008	3/12		1SBL181022R8510	5/167		1SBL411022R8111	5/169
TBC7-30-01-51	GJL1313061R5011	3/9		1SBL181022R8610	5/167		1SBL411022R8311	5/169
TBC7-30-01-55	GJL1313061R5015	3/9		1SBL181022R8810	5/167		1SBL411022R8411	5/169
TBC7-30-01-62	GJL1313061R6012	3/9		1SBL181024R8010	5/158		1SBL411022R8511	5/169
TBC7-30-01-68	GJL1313061R6018	3/9	UA16-30-10RA	1SBL181024R8100	5/158		1SBL411022R8611	5/169
TBC7-30-10-51	GJL1313061R5101	3/9		1SBL181024R8310	5/158		1SBL411022R8811	5/169
TBC7-30-10-55	GJL1313061R5105	3/9		1SBL181024R8410	5/158		1SFL431022R8000	5/170
TBC7-30-10-62	GJL1313061R6102	3/9		1SBL181024R8510	5/158		1SFL431022R8100	5/170
TBC7-30-10-68	GJL1313061R6108	3/9		1SBL181024R8610	5/158		1SFL431022R8300	5/170
TBC7-31-00-55	GJL1313461R5005	3/12		1SBL181024R8810	5/158		1SFL431022R8400	5/170
TBC7-31-00-62	GJL1313461R6002	3/12		1SBL241022R8010	5/167		1SFL431022R8500	5/170
TBC7-31-00-68	GJL1313461R6008	3/12		1SBL241022R8110	5/167		1SFL431022R8600	5/170
TEF3-OFF	1SBN021014R1000	4/37		1SBL241022R8310	5/167		1SFL431022R8800	5/170
TEF3-ON	1SBN021012R1000	4/37		1SBL241022R8510	5/167		1SFL431024R8000	5/160
TEF4-OFF	1SBN020114R1000	5/11		1SBL241022R8610	5/167		1SFL431024R8100	5/160
TEF4-ON	1SBN020112R1000	5/11		1SBL241022R8810	5/167		1SFL431024R8300	5/160
TEF4S-OFF	1SBN020115R1000	6/47		1SBL241024R8010	5/158		1SFL431024R8400	5/160
TEF4S-ON	1SBN020113R1000	6/47		1SBL241024R8110	5/158		1SFL431024R8500	5/160
TEF5-OFF	1SBN020314R1000	5/103		1SBL241024R8310	5/158		1SFL431024R8600	5/160
TEF5-ON	1SBN020312R1000	5/103		1SBL241024R8410	5/158		1SFL431024R8800	5/160
TF140DU-110	1SAZ431201R1002	7/20		1SBL241024R8510	5/158		1SFL431022R8011	5/171
TF140DU-135	1SAZ431201R1003	7/20		1SBL241024R8610	5/158		1SFL431022R8111	5/171
TF140DU-142	1SAZ431201R1004	7/20		1SBL241024R8810	5/158		1SFL431022R8311	5/171
TF140DU-90	1SAZ431201R1001	7/20	UA26-30-10	1SBL281022R8010	5/167		1SFL431022R8411	5/171
TF42-0.13	1SAZ721201R1005	7/8		1SBL281022R8110	5/167		1SFL431022R8511	5/171
TF42-0.17	1SAZ721201R1008	7/8		1SBL281022R8310	5/167		1SFL431022R8611	5/171
TF42-0.23	1SAZ721201R1009	7/8		1SBL281022R8410	5/167		1SFL431022R8811	5/171
TF42-0.31	1SAZ721201R1013	7/8		1SBL281022R8510	5/167		1SFL431022R8011	5/171
TF42-0.41	1SAZ721201R1014	7/8		1SBL281022R8610	5/167		1SFL431022R8111	5/171
TF42-0.55	1SAZ721201R1017	7/8		1SBL281022R8810	5/167		1SFL431022R8311	5/171
TF42-0.74	1SAZ721201R1021	7/8	UA30-30-10	1SBL281024R8010	5/158		1SFL431022R8411	5/171
TF42-1.0	1SAZ721201R1023	7/8		1SBL281024R8110	5/158		1SFL431022R8511	5/171
TF42-1.3	1SAZ721201R1025	7/8		1SBL281024R8310	5/158		1SFL431022R8611	5/171
TF42-1.7	1SAZ721201R1028	7/8		1SBL281024R8410	5/158		1SFL431022R8811	5/171
TF42-10	1SAZ721201R1043	7/8		1SBL281024R8510	5/158		1SFL431022R8011	5/171
TF42-13	1SAZ721201R1045	7/8		1SBL281024R8610	5/158		1SFL431022R8111	5/171
TF42-16	1SAZ721201R1047	7/8		1SBL281024R8810	5/158		1SFL431022R8311	5/171
TF42-2.3	1SAZ721201R1031	7/8	UA30-30-10RA	1SBL281024R8010	5/158		1SFL431022R8411	5/171
TF42-20	1SAZ721201R1049	7/8		1SBL281024R8110	5/158		1SFL431022R8511	5/171
TF42-24	1SAZ721201R1051	7/8		1SBL281024R8310	5/158		1SFL431022R8611	5/171
TF42-29	1SAZ721201R1052	7/8		1SBL281024R8410	5/158		1SFL431022R8811	5/171
TF42-3.1	1SAZ721201R1033	7/8		1SBL281024R8510	5/158		1SFL431022R8011	5/171
TF42-35	1SAZ721201R1053	7/8		1SBL281024R8610	5/158		1SFL431022R8111	5/171
TF42-38	1SAZ721201R1055	7/8		1SBL281024R8810	5/158		1SFL431022R8311	5/171
TF42-4.2	1SAZ721201R1035	7/8	UA4-110	1SAM401905R1001	2/43		1SFL431022R8411	5/171
TF42-5.7	1SAZ721201R1038	7/8		1SAM401905R1002	2/43		1SFL431022R8511	5/171
TF42-7.6	1SAZ721201R1040	7/8		1SAM401905R1004	2/43		1SFL431022R8611	5/171
TF65	1SAZ811201R1001	7/12		1SAM401905R1003	2/43		1SFL431022R8811	5/171
	1SAZ811201R1002	7/12	UA4-HK-230	1SAM401906R1001	2/43		1SFL431022R8011	5/171
	1SAZ811201R1003	7/12		1SAM401906R1002	2/43		1SFL431022R8111	5/171
	1SAZ811201R1004	7/12	UA4-HK-400	1SAM401906R1001	2/43		1SFL431022R8311	5/171
	1SAZ811201R1005	7/12	UA50-30-00	1SBL351022R8000	5/168		1SFL431022R8411	5/171
	1SAZ811201R1006	7/12		1SBL351022R8100	5/168		1SFL431022R8511	5/171
	1SAZ811201R1007	7/12		1SBL351022R8300	5/168		1SFL431022R8611	5/171
	1SAZ811201R1008	7/12		1SBL351022R8400	5/168		1SFL431022R8811	5/171
	1SAZ811201R1009	7/12		1SBL351022R8500	5/168		1SFL431024R8000	5/160
	1SAZ811201R1010	7/12		1SBL351022R8600	5/168		1SFL431024R8100	5/160
	1SAZ811201R1011	7/12		1SBL351022R8800	5/168		1SFL431024R8300	5/160
	1SAZ811201R1012	7/12		1SBL351024R8000	5/169		1SFL431024R8400	5/160
	1SAZ811201R1013	7/12		1SBL351024R8100	5/169		1SFL431024R8500	5/160
	1SAZ811201R1014	7/12		1SBL351024R8300	5/169		1SFL431024R8600	5/160
	1SAZ811201R1015	7/12		1SBL351024R8400	5/169		1SFL431024R8800	5/160
	1SAZ811201R1016	7/12		1SFL451022R8000	5/170		1SFL431022R8011	5/169





# Index

## Type classification

Type	Order code	Page
ZAF1650	1ISBN153510R8806	5/251
ZAF2650	1SFN156570R7026	5/226
ZAF460	1SFN155770R6806	5/226
	1SFN155770R6906	5/226
	1SFN155770R7006	5/226
	1SFN155770R7106	5/226
ZAF75	1ISBN153570R6906	5/251
	1ISBN153570R7006	5/251
	1ISBN153570R7206	5/251
ZAF750	1SFN156170R6806	5/226
	1SFN156170R6906	5/226
	1SFN156170R7006	5/226
	1SFN156170R7106	5/226
ZL1250	1SFN166403R1000	5/226
ZL1350	1SFN166503R1000	5/226
ZL1650	1SFN166703R1000	5/226
ZL2050	1SFN167003R1000	5/226
ZL2650	1SFN166603R1000	5/226
ZL400	1SFN165703R1000	5/226
ZL460	1SFN165903R1000	5/226
ZL580	1SFN166103R1000	5/226
ZL750	1SFN166303R1000	5/226
ZLU110	1SFN164502R1000	5/251
ZLU50	1ISBN163502R1000	5/251
ZLU63	1ISBN163702R1000	5/251
ZLU75	1ISBN164102R1000	5/251
ZLU95	1SFN164302R1000	5/251
ZP1650	1SFN166521R1070	5/226
ZP2650	1SFN166621R1070	5/226
ZW1650	1SFN166510R1000	5/226
ZW2650	1SFN166610R1000	5/226
ZW460	1SFN165710R1000	5/226
ZW750	1SFN166110R1000	5/226

Type	Order code	Page
------	------------	------

Type	Order code	Page
------	------------	------

# Contact us

**ABB France**  
**Low Voltage Products Division**  
3, rue Jean Perrin  
F-69687 Chassieu cedex / France

**ABB STOTZ-KONTAKT GmbH**  
Eppelheimer Straße 82  
D-69123 Heidelberg / Germany

**ABB AB**  
**Control Products**  
**Low Voltage Products**  
SE-721 61 Västerås / Sweden

You can find the address of your local sales organisation  
on the [ABB home page](#)



[www.abb.com/connecttocontrol](http://www.abb.com/connecttocontrol)



[www.abb.com/lowvoltage](http://www.abb.com/lowvoltage)

## Note

We reserve the right to make technical changes or modify the contents of this document without prior notice.

ABB does not accept any responsibility whatsoever for potential errors or possible lack of information in this document.

We reserve all rights in this document and in the subject matter and illustrations contained therein. Any reproduction, disclosure to third parties or utilization of its contents – in whole or in parts – is forbidden without prior written consent of ABB.

Copyright© 2013 ABB - All rights reserved