

# A22NE-PD

## Install in 22-dia. or 25-dia. Panel Cutout

(When Using a Ring)

- The small size of the control panel is realized by conserving space and changing the direction of the wiring.
- Since there is no looseness in the wiring, there is a reduction in the maintenance efforts.
- A maximum of up to four contact points can be combined together in the contact-point configuration.
- Oil-resistant to IP65 (non-lighted models) / IP65 (lighted models) / IP69K high-temperature, high-pressure cleaning (pull-reset models).
- Whether or not the Operation Unit and the Switch Unit have been properly mounted can be detected from the open/closed state of the contact (Lock-lever-linked contact function). \*
- \* All contacts are interlocked with the lock lever.  
(The statuses of both NC contacts and NO contacts are switched.)



For the most recent information on models that have been certified for safety standards, refer to your OMRON website.

Be sure to read the "Safety Precautions" on pages 18 and 56.

## Model Number Structure

**Model Number Legend (Completely Assembled)** ..... Shipped as a set which includes the Operation Unit, LED Lamp (lighted models only), and Switch Block.



### 1. Operation Unit size (diameter)

Code	Description
S	30 dia.
M	40 dia.
L	60 dia.

### 2. Reset function

Code	Description
None	Turn-reset
P	Pull-reset *

\* The pull-reset type is only available on the 40 dia. Operation Unit, non-lighted type. Not available on lighted types.

### 3. Terminal specification

Code	Description
P	Push-in plus terminal block

### 4. Lock lever function

Code	Description
D	Lock-lever-linked contact function

### 5. Contacts

Code	Number of Contacts	Contacts	
		NO	NC
01	one contact	0	1
02	two contacts	0	2
11		1	1
03	three contacts	0	3
21		2	1
12	four contacts	1	2
22		2	2
13	four contacts	1	3
04		0	4

Note. NO: 1a-contact NC: 1b-contact

### 6. LED lamp voltage

Code	Description
N	Non-lighted
C	24 VAC/VDC

\* Lighting color is red.

### 7. Others (Degree of Protection)

Code	Description
None	IP65
69K	IP69K *

\* IP69K is supported only by the Pull-reset models.

A22NE-PD

A22NE-P

A22E

Common Accessories and Tools





Common Note

# A22NE-PD

## Ordering Information

### List of Models (Completely Assembled)

#### Non-lighted Models (Without EMO/EMS Indication)

Appearance	Operation	Degree of Protection	Contact configuration *	Set Model	Color of cap
	40-dia. head Medium Pull-reset A22NE-MP-PD□□-N	IP65 oil-resistant models	2NC	A22NE-MP-PD02-N	Red
			2NC, 1NO	A22NE-MP-PD12-N	
			3NC	A22NE-MP-PD03-N	
			2NC, 2NO	A22NE-MP-PD22-N	
			3NC, 1NO	A22NE-MP-PD13-N	
			4NC	A22NE-MP-PD04-N	
	40-dia. head Medium Pull-reset A22NE-MP-PD□□-N-69K	IP69K	2NC	A22NE-MP-PD02-N-69K	
			2NC, 1NO	A22NE-MP-PD12-N-69K	
			3NC	A22NE-MP-PD03-N-69K	
			2NC, 2NO	A22NE-MP-PD22-N-69K	
			3NC, 1NO	A22NE-MP-PD13-N-69K	
			4NC	A22NE-MP-PD04-N-69K	
	30-dia. head Small Turn-reset A22NE-S-PD□□-N	IP65 oil-resistant models	2NC	A22NE-S-PD02-N	Red
			2NC, 1NO	A22NE-S-PD12-N	
			3NC	A22NE-S-PD03-N	
			2NC, 2NO	A22NE-S-PD22-N	
			3NC, 1NO	A22NE-S-PD13-N	
			4NC	A22NE-S-PD04-N	
	40-dia. head Medium Turn-reset A22NE-M-PD□□-N	IP65 oil-resistant models	2NC	A22NE-M-PD02-N	Red
			2NC, 1NO	A22NE-M-PD12-N	
			3NC	A22NE-M-PD03-N	
			2NC, 2NO	A22NE-M-PD22-N	
			3NC, 1NO	A22NE-M-PD13-N	
			4NC	A22NE-M-PD04-N	
	60-dia. head Large Turn-reset A22NE-L-PD□□-N	IP65 oil-resistant models	2NC	A22NE-L-PD02-N	Red
			2NC, 1NO	A22NE-L-PD12-N	
			3NC	A22NE-L-PD03-N	
			2NC, 2NO	A22NE-L-PD22-N	
			3NC, 1NO	A22NE-L-PD13-N	
			4NC	A22NE-L-PD04-N	

\* In addition to the above, we also provide the following contact configurations: [1NC], [1NC, 1NO], and [1NC, 2NO]. Ask your OMRON representative for details.

#### Lighted Model (Without EMO/EMS Indication)

Appearance	Operation	Degree of Protection	Contact configuration *	LED lamp voltage	Set Model	Color of cap
	40-dia. head Medium Turn-reset A22NE-M-PD□□-C	IP65	2NC	24 V AC/DC	A22NE-M-PD02-C	Red
			2NC, 1NO		A22NE-M-PD12-C	
			3NC		A22NE-M-PD03-C	
			2NC, 2NO		A22NE-M-PD22-C	
			3NC, 1NO		A22NE-M-PD13-C	
			4NC		A22NE-M-PD04-C	

\* In addition to the above, we also provide the following contact configurations: [1NC], [1NC, 1NO], and [1NC, 2NO]. Ask your OMRON representative for details.

A22NE-PD

A22NE-P

A22E







Common Accessories and Tools

Common Note

**Accessories (Order Separately)**

Operation Unit

Non-lighted

		Size	Small (30 dia.)	Medium (40 dia.)	Large (60-dia.)
Function	Degree of protection		Single item order model		
Pull-reset	IP65 oil-resistant models		---	A22NE-MP-N 	---
	IP69K		---	A22NE-MP-N-69K 	---
Turn-reset	IP65 oil-resistant models	A22NE-S-N 	A22NE-M-N 	A22NE-L-N 	
			A22NE-MRO-N A22NE-MRO-N-RD 		
			A22NE-MRS-N A22NE-MRS-N-RD 		

**Lighted**

		Size	Medium (40 dia.)
Function	Sealing capability		Single item order model
Turn-reset	IP65		A22NE-M-L 

# A22NE-PD

A22NE-PD

## LED lamp

The LED lamps are exclusively for use with the A22N/M22N series, A22NE series and A30N series.

Appearance	LED light	Rated voltage	Model	Remarks
	Red	24 V AC/DC	A22NZ-L-RC	These are provided with the completely assembled set of lighted models. Order LED Lamps only when replacing them.

A22NE-P

## Control Box

Item	Appearance	Model	Remarks
Control Box	 One hole, yellow box	A22NZ-A-B101Y	Material: Polycarbonate resin. For 22.3-mm panel hole diameter. The A22NZ-A-B101Y Control Box cannot be used in combination with the A22Z-3476-1 90-dia. Legend Plates for Emergency Stop or the A22ZEG□ E-stop Shrouds.

**Note:** For details on the accessories common to the screw terminal block models and push-in plus terminal block models, refer to "Common Accessories and Tools (Order Separately)" on page 51.

A22E

Common Accessories and Tools

Common Note

## Specifications

### Certified Standard Ratings

- UL508 (File No. E76675), CSA C22.2 No.14  
5 A at 125 VAC, 3 A at 250 VAC B300
- TÜV (EN60947-5-1) - Certified direct opening -  
(EN60947-5-5)  
AC-15 3 A at 125 VAC  
DC-13 1 A at 30 VDC
- CCC (GB/T14048.5)  
AC-15 3 A at 125 VAC  
DC-13 1 A at 30 VDC

### Applicable Standards

UL1059, UL486E

**Note:** Use a 10 A fuse type gI or gG that conforms to IEC60269 as a short-circuit protection device. This fuse is not provided in the main unit.

### Ratings

#### Contacts (Standard Load)

Rated insulation voltage (V)	Rated carry current (A)	Rated voltage (V)	Rated current (A)			
			AC15 (Inductive load)	AC12 (Resistive load)	DC13 (Inductive load)	DC12 (Resistive load)
250	5	30 VAC	---	---	---	---
		125 VAC	3 A	5 A	---	---
		250 VAC	1.5 A	3 A	---	---
		30 VDC	---	---	1 A	2 A
		125 VDC	---	---	0.22 A	0.4 A
		250 VDC	---	---	0.1 A	0.2 A

- Note:** 1. The above ratings were obtained by conducting tests under the following conditions.  
 (1) Ambient temperature: 20°±2°C  
 (2) Ambient humidity: 65±5%  
 (3) Operating frequency: 20 operations/minute
2. Minimum applicable load: 1 mA at 5 VDC (Resistive load)  
 The operating range may vary depending on the usage conditions and type of load.

### Certified Standards

Certification body	Standards	File No.
UL *	UL508, C22.2 No.14	E76675
TÜV SÜD	EN60947-5-1 (Certified direct opening), EN60947-5-5	Consult your OMRON representative for details.
CQC (CCC)	GB/T14048.5	Consult your OMRON representative for details.

**Note:** Only models with NC contacts have a direct opening mechanism.

\* UL-certification for CSA C22.2 No. 14 has been obtained.

### LED Lamp (A22NZ-L-RC)

Rated voltage	Operating voltage	Current value
24 VAC/VDC	24 VAC/VDC ± 10%	Approx. 12 mA

## Characteristics

Operation		Turn-reset		Pull-reset	
		Non-lighted model	Lighted Model	Non-lighted model	Non-lighted model (Models with IP69K)
Item		A22NE-□-PD□□-N-□	A22NE-M-PD□□-C-□	A22NE-MP-PD□□-N-□	A22NE-MP-PD□□-N-69K
Allowable operating frequency	Mechanical	30 operations/minute or less (One operation consists of set and reset operations.)			
	Electrical	30 operations/minute or less (One operation consists of set and reset operations.)			
Insulation resistance *1		100 MΩ min. (at 500 VDC)			
Contact resistance		100 mΩ max. (initial value)			
Dielectric strength	Between terminals of same polarity*1	2,000 VAC, 50/60 Hz 1 minute (initial value)			
	Between terminals of different polarity	2,000 VAC, 50/60 Hz 1 minute (initial value)			
	Between each terminal and ground	2,000 VAC, 50/60 Hz 1 minute (initial value)			
Vibration resistance	Malfunction	10 to 55 Hz, 1.5 mm double amplitude (contact separation within 1 ms)			
Shock resistance	Malfunction	250 m/s <sup>2</sup> max. (contact separation within 1 ms)			
Durability	Mechanical	300,000 operations min. (One operation consists of set and reset operations.)			100,000 operations min. (One operation consists of set and reset operations.)
	Electrical (100 mA at 24 VAC (Resistive load))	250,000 operations min. (One operation consists of set and reset operations.)			100,000 operations min. (One operation consists of set and reset operations.)
	Electrical (3 mA at 250 VAC (Resistive load))	100,000 operations min. (One operation consists of set and reset operations.)			
Ambient operating temperature *2		-20 to +70°C	-20 to +55°C	-20 to +70°C	-20 to +70°C *3
Ambient operating humidity		35 to 85% RH			
Ambient storage temperature *2		-40 to +70°C			
Degree of protection *4		IP65 oil-resistant models	IP65	IP65 oil-resistant models	IP69K
Electric shock protection class		Class II			
PTI (tracking characteristic)		175			
Degree of contamination		3 (EN 60947-5-1)			
Minimum direct opening stroke		11 mm			
Minimum direct opening force		45 N			
Conditional short-circuit current		100 A (EN 60947-5-1)			
Wight (for a 40-dia. head 2NC/2NO Operation Unit)		Approx. 95 g	Approx. 95 g	Approx. 125 g	Approx. 135 g

\*1. State when an LED is not added between terminals of the same polarity on a lighting unit.

\*2. With no icing or condensation.

\*3. Capable of operation at up to 80°C under IP□9K testing conditions per JIS D 5020.

\*4. The degree of protection from the front of the panel.

## Operating Characteristics

Item	Turn-reset	Pull-reset	
	Lighted / non-lighted models	Non-lighted model	Non-lighted model (Models with IP69K)
Total travel force (TTF)	45 N max.	60 N max.	70 N max.
Return force (RF)	0.25N·m max. *	60 N max.	70 N max.
Total travel (TT)	10 ±1 mm	5.5 ±1 mm	

\* Rotation torque value.

Terminal Arrangement (BOTTOM VIEW)

Non-lighted

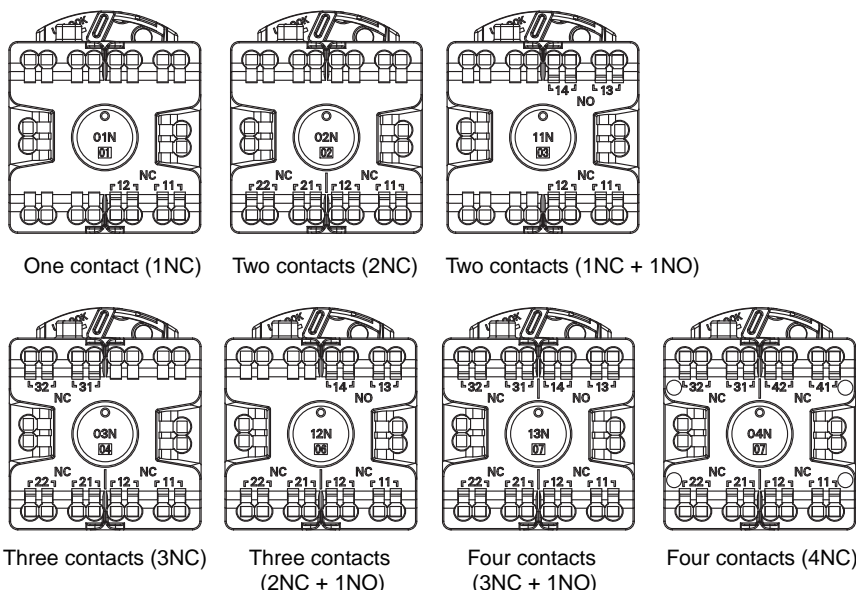

Lighted

The switch terminal is same as that in the non-lighted models. Indicates the terminals for lighting (X1-X2). (Example: Four contacts (4NC) Lighted models)

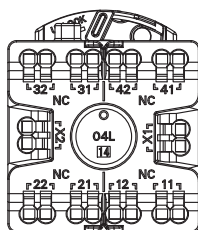

Terminal arrangement

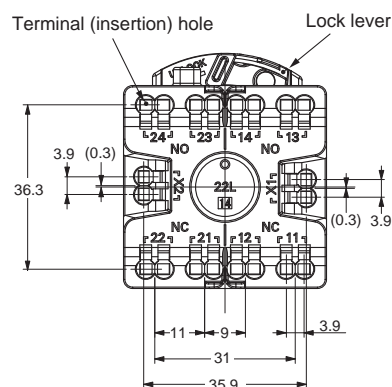

Terminal Arrangement

Type	Terminal Arrangement (BOTTOM VIEW)			
	1NC, 1NO (two contacts)	2NC, 2NO (four contacts)	3NC, 1NO (four contacts)	4NC (four contacts)
Non-lighted	NO 14 — 13	NO NO 24 — 23 14 — 13	NC NO 32 — 31 14 — 13	NC NC 32 — 31 42 — 41
	NC 12 — 11	NC NC 22 — 21 12 — 11	NC NC 22 — 21 12 — 11	NC NC 22 — 21 12 — 11
Lighted	NO 14 — 13 X2 — ⊗ — X1	NO NO 24 — 23 14 — 13 X2 — ⊗ — X1	NC NO 32 — 31 14 — 13 X2 — ⊗ — X1	NC NC 32 — 31 42 — 41 X2 — ⊗ — X1
	NC 12 — 11	NC NC 22 — 21 12 — 11	NC NC 22 — 21 12 — 11	NC NC 22 — 21 12 — 11

Note: The terminal arrangement shows the representative. It depends on the number of contacts in the series.

# Structure and Nomenclature

A22NE-PD

A22NE-P

A22E

Common Accessories and Tools

Common Note

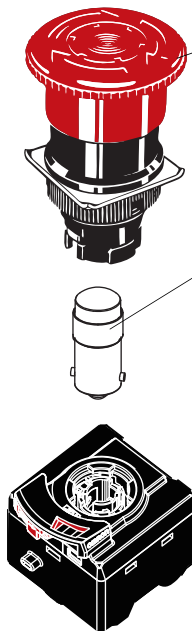

**Operation Unit**

**Color: Red**

Non-lighted  
LED lighting

**Lamp**

**Light source**

• LED Lamp

**Switch**

Mounting Latches  
Switch Blocks  
Lighting unit

**Contact Ratings**

3 A at 250 VAC  
5 A at 125 VAC

**Lighting Method**

Non-lighted  
Lighted (LED)

Dimensions

Non-lighted Models

A22NE-MP-PD□□-N

Pull-reset (40-dia.) Degree of Protection: IP65 oil-resistant models

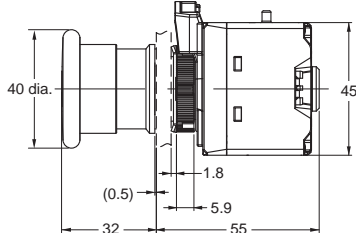

A22NE-MP-PD□□-N-69K

Pull-reset (40-dia.) Degree of Protection: IP69K

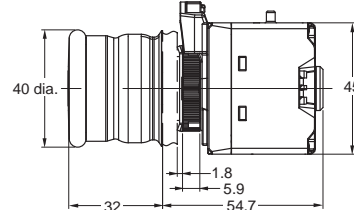

A22NE-S-PD□□-N

Small Turn-reset (30-dia.) Degree of Protection: IP65 oil-resistant models

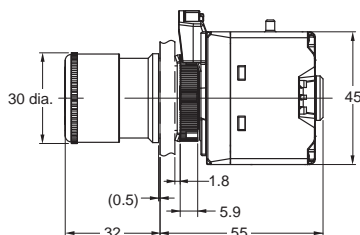

A22NE-M-PD□□-N

Medium Turn-reset (40-dia.) Degree of Protection: IP65 oil-resistant models

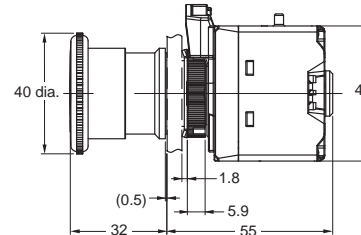

Note: The dimensions the same even if the Operation Unit is replaced with the A22NE-MR□□-N or the A22NE-MR□□-N-RD.

A22NE-L-PD□□-N

Large Turn-reset (60-dia.) Degree of Protection: IP65 oil-resistant models

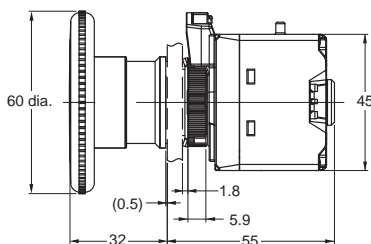

Lighted Model

A22NE-M-PD□□-C

Medium Turn-reset (40-dia.) Degree of Protection: IP65

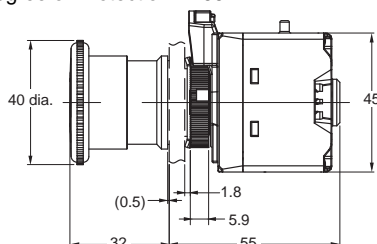

Note: Unless otherwise specified, a tolerance of ±0.8mm applies to all dimensions.

Accessories (Order Separately)

LED Lamp

A22NZ-L-RC

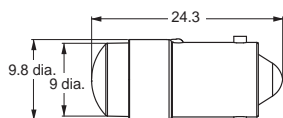

Note: For details on the accessories common to the screw terminal block types and push-in plus terminal block types, refer to "Common Accessories and Tools (Order Separately)" on page 51.

A22NE-PD

A22NE-P

A22E

Common Accessories and Tools

Common Note

Mounting to the Panel

(1) Preparing the Panel

Panel hole dimension and panel thickness

- If outer surface treatment such as coating is performed for the panel, the panel dimensions after outer surface treatment must meet the specified panel dimensions.

Panel hole dimension	Panel thickness
22.3 dia.	1 to 5 mm



When using a A22Z-3360 (Order Separately) Lock Ring

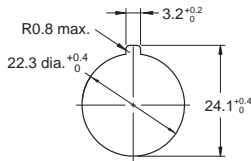

For 25-dia.

- Use the A22Z-R25 (Order Separately) rubber ring.
- \* Switches with an IP69K degree of protection do not support the 25-dia.

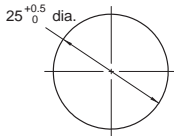

(2) Minimum mounting pitch (Dimension A, Dimension B)

Minimum mounting pitch

Type of operation unit	Dimension A (mm) min.	Dimension B (mm) min.
30-dia., 40-dia. models	50 *1	50
60-dia. model	70	70

- \*1. If the Switch Unit lock levers all face the same direction at the minimum mounting pitch, be sure to note the order the Switch Units are attached to the Operation Unit.
- \*2. When using each accessory (Order Separately), set the A and B dimensions in view of the dimensions of the accessories.
- \*3. Make sure the mounting pitch does not hinder the operation.

Panel Hole Dimensions for 22.3 Diameter

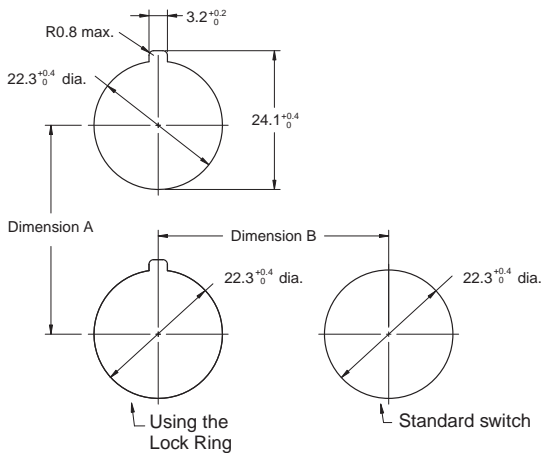

(3) Mounting the Operation Unit on the Panel

- Do not tighten the Tightening Nut more than necessary using tools such as pointed-nose pliers.
- Doing so will damage the Tightening Nut. (The tightening torque of the Tightening Nut is 1.0 to 2.0 N·m.) Tightening Wrench: A22Z-3905

Panel Hole of 22.3-mm Diameter

- Insert the Operation Unit from the front of the panel, insert the Lock Ring and Tightening Nut from the back of the panel, and tighten the Tightening Nut. Before tightening, check that the rubber washer is present between the Operation Unit and the panel.

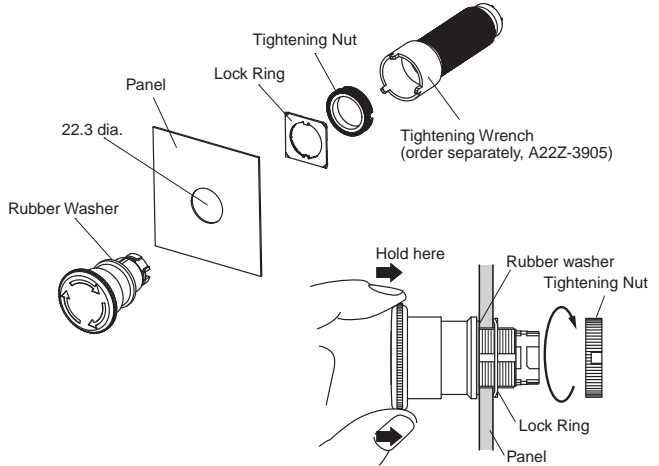

When the A22Z-3360 Lock Ring (Order Separately) is used

- Take note of the direction when mounting the Lock Ring.

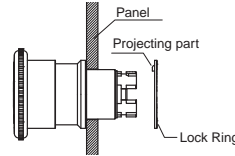

Panel Hole of 25-mm Diameter

- Insert the A22Z-R25 (Order Separately) between the Operation Unit and Panel, and tighten the Tightening Nut. Before tightening, check that the rubber washer supplied with the Operation Unit is present between the Operation Unit and the 25-dia. Ring.

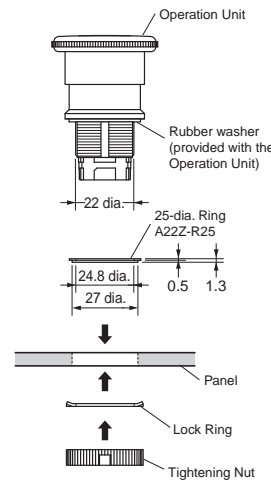

Panel Hole of 30-mm Diameter

- Insert the A22Z-A30 (Order Separately) between the Operation Unit and Panel, and tighten the Tightening Nut. Before tightening, check that the supplied rubber washer is present between the Operation Unit and the panel, and between the 30-dia. Resin Attachment and the panel.
- \* Switches with an IP69K degree of protection do not support the 30-dia.

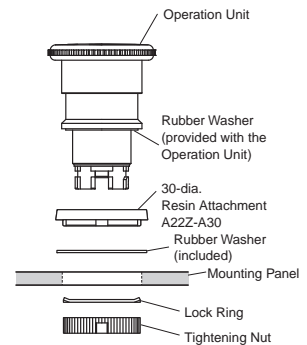

Panel Cutouts	Panel thickness
25 mm dia.	1 to 5 mm
30 mm dia.	1 to 3 mm

### Removing the Switch Unit

#### When the Switch Unit is to be Removed

Slowly push the release port (concave part) of the lock lever with a screwdriver to release the lock. The lock lever moves to the release position.

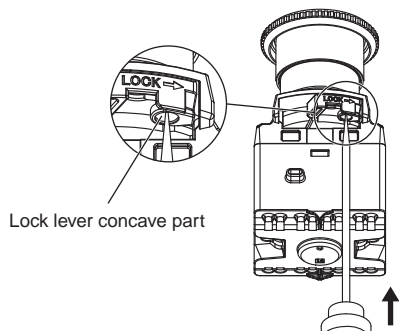

<Lock lever position>

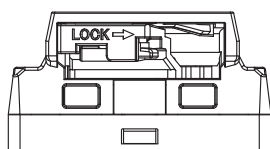

Release position

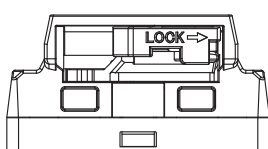

Locked position

When the lock lever is at the released position in this Switch, the NO and NC contact operation is reversed.

Set the lock lever to the locked position when using the Switch.

### Installing the LED Lamp (Lighted Models)

#### When the LED Lamp is to be Installed

Insert the protrusions on the LED Lamp into the guides on the Switch Unit in direction (1), and then turn the LED Lamp in direction (2) to lock it in place.

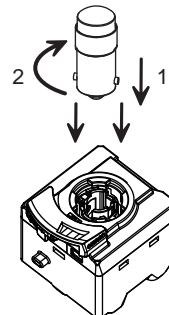

# Safety Precautions

Be sure to read the precautions for **All PushButton Switches** in the website at: <http://www.ia.omron.com/>.

## Indication and Meaning for Safe Use

 <b>Warning</b>	<b>Indicates a potentially hazardous situation that, if not avoided, could result in serious injury or death. Additionally there may be significant property damage.</b>
<b>Precautions for Safe Use</b>	<b>Comments on what to do or avoid doing, to use the product safely.</b>
<b>Precautions for Correct Use</b>	<b>Supplementary comments on what to do or avoid doing to use the product safely and prevent its malfunctioning or an adverse effect on its performance or functions.</b>

**⚠ WARNING**

Do not perform wiring with power supplied to the Switch/Indicator. Do not touch the terminals or other charged parts while power is being supplied. Doing so may result in electric shock.



**Precautions for Safe Use**

- Make sure the Operation Unit and the Switch Unit are properly assembled.

<Assembling the Operation Unit and Switch Unit>

- (1) Assembling the Operation Unit and Switch Unit  
Align the TOP indication (the mark ↓) on the Operation Unit with the TOP indication on the Switch Unit, and insert the Operation Unit while keeping the bottom A pressed.
- (2) Locking the lock lever

With a screwdriver inserted in the lock hole of the lock lever, bring the screwdriver in contact with the convex part of the case, and turn the lock lever until a clicking sound is heard.

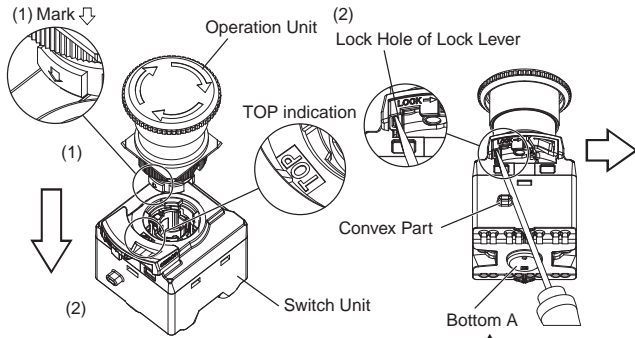

**<Lock lever position>**

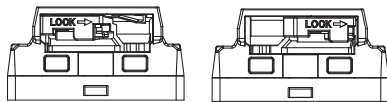

**Release position**  
When the lock lever is at the released position in this Switch, the NO and NC contact operation is reversed.  
**Locked position**  
Set the lock lever to the locked position when using the Switch.

- When transition wiring is performed, make sure the switching current inside the Switch and the current based on the transition wiring is below the rated current of the Switch.  
If a current value higher than the rated current flows, it could result in emission of heat, or damage and deformation of the Switch, which could cause fire and locking of the contact, and thus a loss of safety.

- Do not disassemble or modify the Switch/Indicator under any circumstances.
- Doing so may prevent the Switch/Indicator from functioning to its full capability. Do not drop the Switch/Indicator. Do not apply pressure that may deform or alter the Switch/Indicator.
- The durability of the Switch varies considerably depending on the switching conditions. Always test the Switch/Indicator under actual working conditions before application and use the Switch/Indicator only for the number of switching operations allowed.
- Do not allow the load voltage and current to exceed the rated value. This may damage or burn out the Switch/Indicator.
- Do not use the Switch/Indicator in locations where explosive or flammable gases or liquid may be present or scattered. The electric arc or the heat caused by switching contacts may cause a fire or explosion.
- Do not use the Switch/Indicator in locations where toxic gases, such as H<sub>2</sub>S, SO<sub>2</sub>, NH<sub>3</sub>, HNO<sub>3</sub>, and Cl<sub>2</sub>, may be present, or in locations subject to high temperature or humidity. Doing so may damage the Switch/Indicator due to contact failure or corrosion.
- Do not use the Switch/Indicator submersed in oil or water, or in locations continuously subject to splashes of oil or water. Doing so may result in oil or water entering and damaging the Switch/Indicator.
- Do not use or keep the Switch/Indicator under the following conditions:
  - Subject to severe temperature changes.
  - Subject to high humidity or condensation.
  - Subject to severe vibration or shock.
  - Where direct rays of the sun strike.
  - Where sea breeze may be present.
- Make sure that a rubber washer is present between the Operation Unit and the panel. In models with IP69K, make sure the rubber bush of the Operation Unit is properly attached. Otherwise, the specifications of the protective structure may not be satisfied.
- Do not apply excessive force to the Switch or wirings. Damage or deformation of the Switch Unit could result in an improper contact or a loss of safety.
- Use an appropriate wiring and crimp terminals (hereinafter, called ferrule terminals).
- Exercise caution to avoid wiring errors when connecting the terminals.
- To prevent wiring materials from smoking or ignition, confirm wire ratings and use the wiring materials given in the following table.

Wire Type	Wire material	Recommended Wire	Wire coating peeling amount
Solid wire/ Stranded Wire	Copper	0.25 to 1.5 mm <sup>2</sup> AWG 24 to 16	Ferrules used: 10 to 12 mm (Varies depending on the recommended ferrule conductor length) Ferrules not used: 8 mm

Use wiring crimp terminals and ferrule terminals of the specified size.

- After storing the product for a long time exceeding 1 year, perform, at a minimum, inspections of the operating characteristics, contact resistance, insulation resistance, and dielectric strength as well as evaluate the product under the working conditions.
- This product is intended for indoor use only. Using the product outdoors will result in failure.
- Do not wire anything to the release holes.
- Do not tilt or twist a flat-blade screwdriver while it is inserted into a release hole on the terminal block. The terminal block may be damaged.
- Insert a flat-blade screwdriver into the release holes at an angle. The terminal block may be damaged if you insert the screwdriver straight in.
- Do not allow the flat-blade screwdriver to fall out while it is inserted into a release hole.
- Do not bend a wire past its natural bending radius or pull on it with excessive force. Doing so may cause the wire disconnection.
- Do not insert more than one wire into each terminal insertion hole.
- When mounting on a device with high airtightness, test operation in advance. There is a risk that the negative pressure will prevent the Operation Unit of from returning.
- Although the contacts of an A22NE-PD can be used with both the standard loads and microloads, once a contact has opened or closed under a load, you cannot again connect a small-capacity load. Doing so could roughen the contact surface, and result in loss of contact reliability.
- In the case of loads where an inrush current occurs when the contact is opened or closed, the durability may reduce due to extreme wear on the contacts. If necessary, insert a contact protection circuit.
- If a contact weld, the lock lever might not return to the release position, and contact inversion might not occur. In such a case, move the lock lever to the release position, and remove the Switch Unit from the Operation Unit.

**Precautions for Correct Use**

**Wiring**

**1. Connecting Wires to the Push-In Plus Terminal Block**

**Part Names of the Terminal Block**

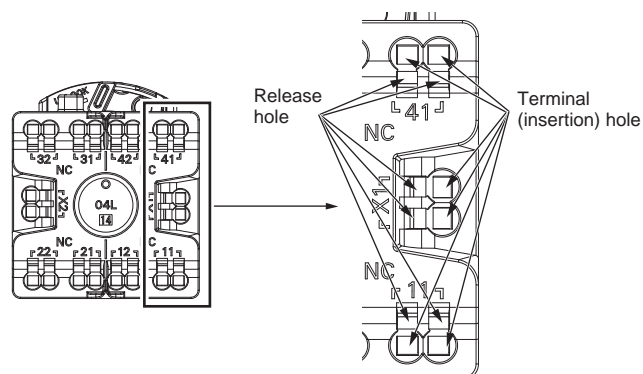

**Connecting Wires with Ferrules and Solid Wires**

- Insert the solid wire or ferrule straight into the terminal block until the end strikes the terminal block.
- If a wire is difficult to connect because it is too thin, use a flat-blade screwdriver in the same way as when connecting stranded wires.

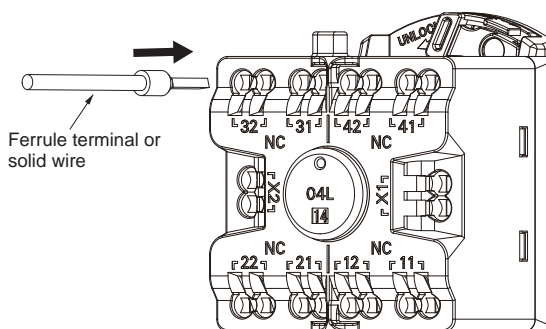

**Connecting Stranded Wires**

Use the following procedure to connect the wires to the terminal block.

1. Hold a flat-blade screwdriver at an angle and insert it into the release hole. The angle should be appropriately 10 to 15°. If the flat-blade screwdriver is inserted correctly, you will feel the spring in the release hole.
2. With the flat-blade screwdriver still inserted into the release hole, insert the wire into the terminal hole until the end strikes the terminal block.
3. Remove the flat-blade screwdriver from the release hole.

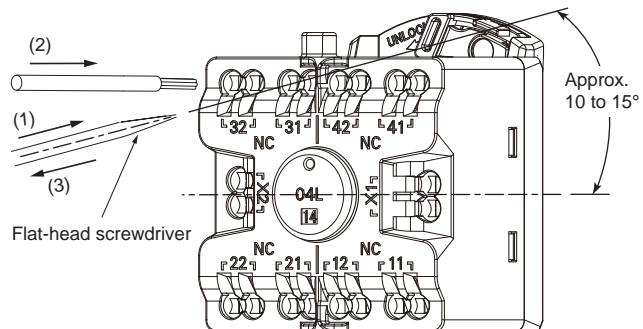

**Checking Connections**

- After the insertion, pull gently on the wire to make sure that it will not come off and it is securely fastened to the terminal block.
- If you use a ferrule with a conductor length of 10 mm, part of the conductor may be visible after the ferrule is inserted into the terminal block, but the product insulation distance will still be satisfied.

**2. Removing Wires from the Push-In Plus Terminal Block**

Use the following procedure to remove wires from the terminal block. The same method is used to remove stranded wires, solid wires, and ferrules.

1. Hold a flat-blade screwdriver at an angle and insert it into the release hole. The angle should be appropriately 10 to 15°.
2. With the flat-blade screwdriver still inserted into the release hole, remove the wire from the terminal insertion hole.
3. Remove the flat-blade screwdriver from the release hole.

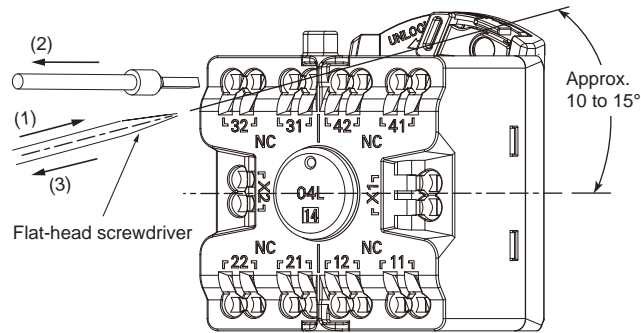

**3. Recommended Ferrules and Crimp Tools**  
**Coating peeling amount**

Recommend Wire Type	Stripping length (Ferrules not used)
0.25 to 1.5 mm <sup>2</sup> /AWG 24 to AWG 16	8 mm

**Recommended ferrules**

Applicable wire		Ferrule conductor length (mm)	Stripping length (mm) (Ferrules not used)	Recommended ferrules		
(mm <sup>2</sup> )	(AWG)			Phoenix Contact product	Weidmuller product	Wago product
0.25	24	8	10	AI 0, 25-8	H0.25/12	216-301
		10	12	AI 0, 25-10	---	---
0.34	22	8	10	AI 0, 34-8	H0.34/12	216-302
		10	12	AI 0, 34-10	---	---
0.5	20	8	10	AI 0, 5-8	H0.5/14	216-201
		10	12	AI 0, 5-10	H0.5/16	216-241
0.75	18	8	10	AI 0, 75-8	H0.75/14	216-202
		10	12	AI 0, 75-10	H0.75/16	216-242
1/1.25	18/17	8	10	AI 1-8	H1.0/14	216-203
		10	12	AI 1-10	H1.0/16	216-243
1.25/1.5	17/16	8	10	AI 1, 5-8	H1.5/14	216-204
		10	12	AI 1, 5-10	H1.5/16	216-244
Recommended Crimp Tools				CRIMPFOX6 CRIMPFOX6T-F CRIMPFOX10S	PZ6 roto	Variocri mp4

- Note:**
1. Make sure that the outer diameter of the wire coating is smaller than the inner diameter of the insulation sleeve of the recommended ferrule.
  2. Make sure that the ferrule processing dimensions conform to the following figures.

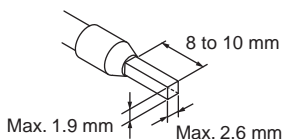

**Recommended Flat-Blade Screwdrivers**

Use a flat-blade screwdriver to connect and remove wires. Use one of the following flat-blade screwdrivers.

The following table shows manufacturers and models as of 2015/Dec.

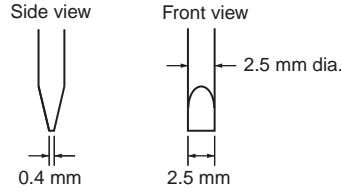

Model	Manufacture
ESD 0,40 x 2,5	Wera
SZS 0,4 x 2,5 SZF 0-0,4 x 2,5 *	Phoenix Contact
0.4 x 2.5 x 75 302	Wiha
AEF.2,5 x 75	Facom
210-719	Wago
SDI 0,4 x 2,5 x 75	Weidmuller

\* The SZF 0-0,4 x 2,5 (manufactured by Phoenix Contact) can be procured through an OMRON exclusive purchase form (XW4Z-00B).

- After wiring the Switch/Indicator, provide a sufficient insulation distance.

**LED Lamps**

- A current-limiting resistor is built in the LED lamp, so the installation of an external resistance is not required.
- Lighting malfunction of the LED lamp  
A micro-current of approximately 0.1 mA or less is sufficient to turn on the LED lamps. Take a countermeasure like adding a resistor to prevent mis-lighting in parallel to the LED lamp. The micro-current varies with the machine (leak current or stray capacity between cables, etc.). Select resistance value and allowable power consumption that meet the actual current.

**(Example of lighting malfunction prevention circuit)**

When using a 24 VAC/DC Lighted Model

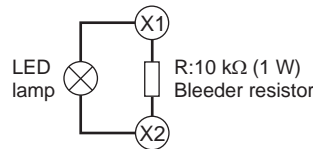

Be sure to read the "Safety Precautions" on page 56.