

# Pushbutton Switches

## A22NN/A22NL

### 22-mm Pushbutton Switches

#### Universal Design.

#### Emphasis on Color Coding, Workability, and Safety.

#### Easy to Use

- You can connect up to three Contact Blocks in one stage for multistage expansion.
- The terminals can be retightened when Contact Blocks are stacked.
- Contact Blocks can be attached in any direction for easy assembly.
- Screw terminal structure is compatible with round crimp terminals.

#### Safety

- Easy-to-operate lock lever for secure locking.
- Easy-mounting Contact Blocks provide finger protection.
- Different colors of Contact Blocks (NO: blue, NC: orange) help prevent wiring errors.

#### Product Lineup

- Meet global safety standards.
- Available with metal or plastic bezels.
- Many color variations.
- Standard-feature degree of protection: IP66, NEMA 4X, and NEMA 13.



Refer to *Safety Precautions for All Pushbutton Switches/Indicators* and *Safety Precautions* on page 23.







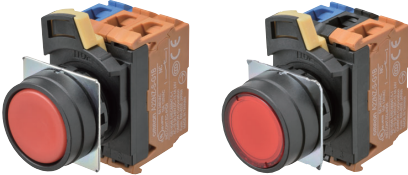

### Button Colors

		Non-lighted Switches							
		Red	Green	Yellow	White	Blue	Black		
Non-lighted Switches	A22NN-□□□-N□ Opaque								
	A22NN-□□□-U□ Transparent								
Lighted Switches	A22NL-□□□-T□ Transparent	When not lit	Red	Green	Yellow	White	Blue	Orange	White
		When lit	Red	Green	Yellow	White	Blue	Orange	Opaque white*

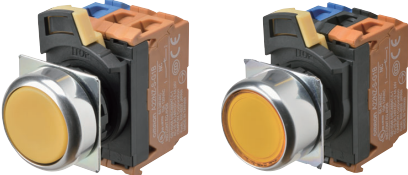
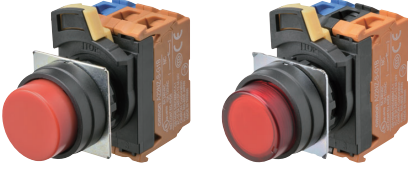
\* The colors when the Switches are lit are for transparent white buttons (code: TW) and yellow LED Lamps (code: Y).

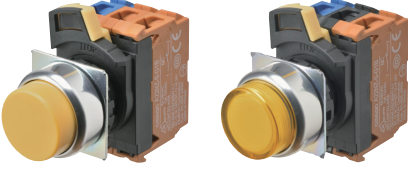
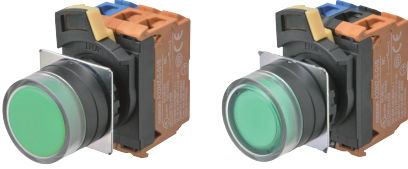
# A22NN/A22NL

## List of Models

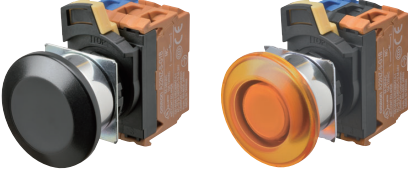
Plastic bezels A22N□-BN	Brushed metal bezels A22N□-MN	Metal bezels A22N□-RN
Flat 	Flat 	Flat 
A22N□-BP	A22N□-MP	A22N□-RP
Projected 	Projected 	Projected 
A22N□-BG	A22N□-MG	
Full guard 	Full guard 	
A22N□-BM	A22N□-MM	A22N□-RM
Mushroom 	Mushroom 	Mushroom 

## Model Number Structure

**Model Number Legend** - - - - Shipped as a set that includes the Operation Unit, LED Lamp, Mounting Collar, and Contact Block.  
For information on combinations, refer to *Ordering Information* on pages 4 to 7.

### Model Numbers for Sets

A 2 2 N <sup>(1)</sup> L - <sup>(2)</sup> BN <sup>(3)</sup> M - <sup>(4)</sup> TR <sup>(5)</sup> A - <sup>(6)</sup> G <sup>(7)</sup> 100 - <sup>(8)</sup> R <sup>(9)</sup> B

#### (1) Type

Code	Description
N	Non-lighted
L	Lighted

#### (2) Bezel Material and Button Shape

Code	Bezel material	Button shape
BN	Plastic	Flat
BP	Plastic	Projected
BG	Plastic	Full guard
BM	Plastic	Mushroom
MN	Brushed metal	Flat
MP	Brushed metal	Projected
MG	Brushed metal	Full guard
MM	Brushed metal	Mushroom
RN	Metal	Flat
RP	Metal	Projected
RM	Metal	Mushroom

#### (3) Switch Action

Code	Description
M	Momentary
A	Alternate

#### (4) Button Transparency and Color and (8) LED Lamp Color

Lighted/non-lighted	Code (4)	Code (8)	Transparency	Button color	LED lamp color
Non-lighted	NR	N	Opaque	Red	---
	NG	N	Opaque	Green	
	NY	N	Opaque	Yellow	
	NW	N	Opaque	White	
	NA	N	Opaque	Blue	
	NB	N	Opaque	Black	
	UR	N	Transparent	Red	
	UG	N	Transparent	Green	
	UY	N	Transparent	Yellow	
	UW	N	Transparent	White	
	UA	N	Transparent	Blue	
	UO	N	Transparent	Orange	
Lighted	TR	R	Transparent	Red	Red
	TG	G	Transparent	Green	Green
	TY	Y	Transparent	Yellow	Yellow
	TW	W	Transparent	White	White
	TA	A	Transparent	Blue	Blue
	TO	O	Transparent	Orange	Orange
	TW	Y	Transparent	White *	Yellow

\* The color is opaque white when the Switch is lit.

#### (5) Degree of Protection

Code	Description
A	IP66, NEMA 4X, NEMA13

#### (6) Contact Specification

Code	Description
G	General purpose

#### (7) Contacts

Code	Contact Blocks		Unit position					
	NO	NC	Non-lighted			Lighted		
			(1)	(2)	(3)	(1)	(2)	(3)
100	1	0	NO	---	---	NO	Lighting Unit	---
002	0	1	---	---	NC	---	Lighting Unit	NC
101	2	0	NO	---	NO	NO	Lighting Unit	NO
102	1	1	NO	---	NC	NO	Lighting Unit	NC
202	0	2	NC	---	NC	NC	Lighting Unit	NC
111	3	0	NO	NO	NO			
112	2	1	NO	NO	NC			
122	1	2	NO	NC	NC			
222	0	3	NC	NC	NC			

**Note:** 1. NO (blue): Normally open, NC (orange): Normally closed.  
2. Refer to the following figure for Unit positions.

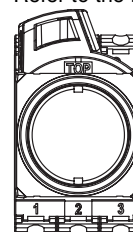

#### (9) LED Lamp Voltage

Code	LED Lamp voltage
N	Non-lighted
A	6 VAC/DC
B	12 VAC/DC
C	24 VAC/DC
D	100/110/120 VAC
E	200/220/230/240 VAC

■ Specifications: Refer to page 15.  
■ Dimensions: Refer to page 17.



■ Precautions for correct use: Refer to page 23.  
■ Accessories and tools: Refer to page 13.

# A22NN/A22NL



## Ordering Information

**Model Numbers for Sets** - - - - Shipped as a set that includes the Operation Unit, LED Lamp, Mounting Collar, and Contact Block.

### Non-lighted, Flat Switches

Appearance	Contacts	Momentary action (self-resetting)	Alternate action (self-holding)	(2)(2) Button color	(7)(7)(7) Contacts
		Model	Model		
 Plastic bezels	1	A22NN-BNM-(2)(2)A-G(7)(7)(7)-NN	A22NN-BNA-(2)(2)A-G(7)(7)(7)-NN	NR: Opaque, red NG: Opaque, green NY: Opaque, yellow NW: Opaque, white NA: Opaque, blue NB: Opaque, black UR: Transparent, red UG: Transparent, green UY: Transparent, yellow UW: Transparent, white UA: Transparent, blue UO: Transparent, orange	100 002
	2	A22NN-BNM-(2)(2)A-G(7)(7)(7)-NN	A22NN-BNA-(2)(2)A-G(7)(7)(7)-NN		101 102 202
	3	A22NN-BNM-(2)(2)A-G(7)(7)(7)-NN	A22NN-BNA-(2)(2)A-G(7)(7)(7)-NN		111 112 122 222
 Brushed metal bezels	1	A22NN-MNM-(2)(2)A-G(7)(7)(7)-NN	A22NN-MNA-(2)(2)A-G(7)(7)(7)-NN		100 002
	2	A22NN-MNM-(2)(2)A-G(7)(7)(7)-NN	A22NN-MNA-(2)(2)A-G(7)(7)(7)-NN		101 102 202
	3	A22NN-MNM-(2)(2)A-G(7)(7)(7)-NN	A22NN-MNA-(2)(2)A-G(7)(7)(7)-NN		111 112 122 222
 Metal bezels	1	A22NN-RNM-(2)(2)A-G(7)(7)(7)-NN	A22NN-RNA-(2)(2)A-G(7)(7)(7)-NN		100 002
	2	A22NN-RNM-(2)(2)A-G(7)(7)(7)-NN	A22NN-RNA-(2)(2)A-G(7)(7)(7)-NN		101 102 202
	3	A22NN-RNM-(2)(2)A-G(7)(7)(7)-NN	A22NN-RNA-(2)(2)A-G(7)(7)(7)-NN		111 112 122 222

### Lighted, Flat Switches

Appearance	Contacts	Momentary action (self-resetting)	Alternate action (self-holding)	(2)(2) Button color	(7)(7)(7) Contacts	(8) LED Lamp color	(9) LED Lamp voltage
		Model	Model				
 Plastic bezels	1	A22NL-BNM-(2)(2)A-G(7)(7)(7)-(8)(9)	A22NL-BNA-(2)(2)A-G(7)(7)(7)-(8)(9)	TR: Transparent, red TG: Transparent, green TY: Transparent, yellow TW: Transparent, white TA: Transparent, blue TO: Transparent, orange	100 002	R: Red G: Green Y: Yellow W: White A: Blue O: Orange	A: 6 VAC/DC B: 12 VAC/DC C: 24 VAC/DC D: 100/110/120 VAC E: 200/220/230/240 VAC
		2	A22NL-BNM-(2)(2)A-G(7)(7)(7)-(8)(9)				
	 Brushed metal bezels	1	A22NL-MNM-(2)(2)A-G(7)(7)(7)-(8)(9)		A22NL-MNA-(2)(2)A-G(7)(7)(7)-(8)(9)		
2			A22NL-MNM-(2)(2)A-G(7)(7)(7)-(8)(9)		A22NL-MNA-(2)(2)A-G(7)(7)(7)-(8)(9)		
 Metal bezels		1	A22NL-RNM-(2)(2)A-G(7)(7)(7)-(8)(9)		A22NL-RNA-(2)(2)A-G(7)(7)(7)-(8)(9)		
	2		A22NL-RNM-(2)(2)A-G(7)(7)(7)-(8)(9)		A22NL-RNA-(2)(2)A-G(7)(7)(7)-(8)(9)		

**Note:** Normally, the Button and LED Lamp with the same color are combined.  
 However, opaque white is available by combining a white Button and yellow LED. A22N□-□□□-TWA-G□□□-Y□



■ Subassemblies: Refer to pages 8 to 12.  
 (You can order Operation Units, LED Lamps, Mounting Collars, and Contact Blocks individually.)

■ Specifications: Refer to page 15. ■ Dimensions: Refer to page 17.  
 ■ Accessories and tools: Refer to page 13.



## Ordering Information

**Model Numbers for Sets** - - - Shipped as a set that includes the Operation Unit, LED Lamp, Mounting Collar, and Contact Block.

### Non-lighted, Projected Switches

Appearance	Contacts	Momentary action (self-resetting)	Alternate action (self-holding)	(2)(2) Button color	(7)(7)(7) Contacts
		Model	Model		
	1	A22NN-BPM-(2)(2)A-G(7)(7)(7)-NN	A22NN-BPA-(2)(2)A-G(7)(7)(7)-NN	NR: Opaque, red NG: Opaque, green NY: Opaque, yellow NW: Opaque, white NA: Opaque, blue NB: Opaque, black UR: Transparent, red UG: Transparent, green UY: Transparent, yellow UW: Transparent, white UA: Transparent, blue UO: Transparent, orange	100 002
	2	A22NN-BPM-(2)(2)A-G(7)(7)(7)-NN	A22NN-BPA-(2)(2)A-G(7)(7)(7)-NN		101 102 202
	3	A22NN-BPM-(2)(2)A-G(7)(7)(7)-NN	A22NN-BPA-(2)(2)A-G(7)(7)(7)-NN		111 112 122 222
	1	A22NN-MPM-(2)(2)A-G(7)(7)(7)-NN	A22NN-MPA-(2)(2)A-G(7)(7)(7)-NN		100 002
	2	A22NN-MPM-(2)(2)A-G(7)(7)(7)-NN	A22NN-MPA-(2)(2)A-G(7)(7)(7)-NN		101 102 202
	3	A22NN-MPM-(2)(2)A-G(7)(7)(7)-NN	A22NN-MPA-(2)(2)A-G(7)(7)(7)-NN		111 112 122 222
	1	A22NN-RPM-(2)(2)A-G(7)(7)(7)-NN	A22NN-RPA-(2)(2)A-G(7)(7)(7)-NN		100 002
	2	A22NN-RPM-(2)(2)A-G(7)(7)(7)-NN	A22NN-RPA-(2)(2)A-G(7)(7)(7)-NN		101 102 202
	3	A22NN-RPM-(2)(2)A-G(7)(7)(7)-NN	A22NN-RPA-(2)(2)A-G(7)(7)(7)-NN		111 112 122 222

### Lighted, Projected Switches

Appearance	Contacts	Momentary action (self-resetting)	Alternate action (self-holding)	(2)(2) Button color	(7)(7)(7) Contacts	(8) LED Lamp color	(9) LED Lamp voltage			
		Model	Model							
	1	A22NL-BPM-(2)(2)A-G(7)(7)(7)-(8)(9)	A22NL-BPA-(2)(2)A-G(7)(7)(7)-(8)(9)	TR: Transparent, red TG: Transparent, green TY: Transparent, yellow TW: Transparent, white TA: Transparent, blue TO: Transparent, orange	100 002	R: Red G: Green Y: Yellow W: White A: Blue O: Orange	A: 6 VAC/DC B: 12 VAC/DC C: 24 VAC/DC D: 100/110/120 VAC E: 200/220/230/240 VAC			
		A22NL-BPM-(2)(2)A-G(7)(7)(7)-(8)(9)	A22NL-BPA-(2)(2)A-G(7)(7)(7)-(8)(9)					101 102 202		
	2	A22NL-BPM-(2)(2)A-G(7)(7)(7)-(8)(9)	A22NL-BPA-(2)(2)A-G(7)(7)(7)-(8)(9)		100 002					
A22NL-BPM-(2)(2)A-G(7)(7)(7)-(8)(9)		A22NL-BPA-(2)(2)A-G(7)(7)(7)-(8)(9)	101 102 202							
	1	A22NL-MPM-(2)(2)A-G(7)(7)(7)-(8)(9)	A22NL-MPA-(2)(2)A-G(7)(7)(7)-(8)(9)		TR: Transparent, red TG: Transparent, green TY: Transparent, yellow TW: Transparent, white TA: Transparent, blue TO: Transparent, orange			100 002	R: Red G: Green Y: Yellow W: White A: Blue O: Orange	A: 6 VAC/DC B: 12 VAC/DC C: 24 VAC/DC D: 100/110/120 VAC E: 200/220/230/240 VAC
		A22NL-MPM-(2)(2)A-G(7)(7)(7)-(8)(9)	A22NL-MPA-(2)(2)A-G(7)(7)(7)-(8)(9)							
	2	A22NL-MPM-(2)(2)A-G(7)(7)(7)-(8)(9)	A22NL-MPA-(2)(2)A-G(7)(7)(7)-(8)(9)					100 002		
A22NL-MPM-(2)(2)A-G(7)(7)(7)-(8)(9)		A22NL-MPA-(2)(2)A-G(7)(7)(7)-(8)(9)	101 102 202							
	1	A22NL-RPM-(2)(2)A-G(7)(7)(7)-(8)(9)	A22NL-RPA-(2)(2)A-G(7)(7)(7)-(8)(9)					TR: Transparent, red TG: Transparent, green TY: Transparent, yellow TW: Transparent, white TA: Transparent, blue TO: Transparent, orange		
		A22NL-RPM-(2)(2)A-G(7)(7)(7)-(8)(9)	A22NL-RPA-(2)(2)A-G(7)(7)(7)-(8)(9)	101 102 202						
	2	A22NL-RPM-(2)(2)A-G(7)(7)(7)-(8)(9)	A22NL-RPA-(2)(2)A-G(7)(7)(7)-(8)(9)	100 002						
A22NL-RPM-(2)(2)A-G(7)(7)(7)-(8)(9)		A22NL-RPA-(2)(2)A-G(7)(7)(7)-(8)(9)	101 102 202							

**Note:** Normally, the Button and LED Lamp with the same color are combined.

However, opaque white is available by combining a white Button and yellow LED. A22N□-□□□-TWA-G□□□-Y□

■ Subassemblies: Refer to pages 8 to 12.  
(You can order Operation Units, LED Lamps, Mounting Collars, and Contact Blocks individually.)



■ Specifications: Refer to page 15. ■ Dimensions: Refer to page 17.  
■ Accessories and tools: Refer to page 13.

# A22NN/A22NL



## Ordering Information

**Model Numbers for Sets** - - - Shipped as a set that includes the Operation Unit, LED Lamp, Mounting Collar, and Contact Block.

### Non-lighted, Full-guard Switches

Appearance	Contacts	Momentary action (self-resetting)	Alternate action (self-holding)	(2)(2) Button color	(7)(7)(7) Contacts
		Model	Model		
Plastic bezels 	1	A22NN-BGM-(2)(2)A-G(7)(7)(7)-NN	A22NN-BGA-(2)(2)A-G(7)(7)(7)-NN	NR: Opaque, red NG: Opaque, green NY: Opaque, yellow NW: Opaque, white NA: Opaque, blue NB: Opaque, black UR: Transparent, red UG: Transparent, green UY: Transparent, yellow UW: Transparent, white UA: Transparent, blue UO: Transparent, orange	100 002
	2	A22NN-BGM-(2)(2)A-G(7)(7)(7)-NN	A22NN-BGA-(2)(2)A-G(7)(7)(7)-NN		101 102 202
	3	A22NN-BGM-(2)(2)A-G(7)(7)(7)-NN	A22NN-BGA-(2)(2)A-G(7)(7)(7)-NN		111 112 122 222
Brushed metal bezels 	1	A22NN-MGM-(2)(2)A-G(7)(7)(7)-NN	A22NN-MGA-(2)(2)A-G(7)(7)(7)-NN		100 002
	2	A22NN-MGM-(2)(2)A-G(7)(7)(7)-NN	A22NN-MGA-(2)(2)A-G(7)(7)(7)-NN		101 102 202
	3	A22NN-MGM-(2)(2)A-G(7)(7)(7)-NN	A22NN-MGA-(2)(2)A-G(7)(7)(7)-NN		111 112 122 222

### Lighted, Full-guard Switches

Appearance	Contacts	Momentary action (self-resetting)	Alternate action (self-holding)	(2)(2) Button color	(7)(7)(7) Contacts	(8) LED Lamp color	(9) LED Lamp voltage
		Model	Model				
Plastic bezels 	1	A22NL-BGM-(2)(2)A-G(7)(7)(7)-(8)(9)	A22NL-BGA-(2)(2)A-G(7)(7)(7)-(8)(9)	TR: Transparent, red TG: Transparent, green TY: Transparent, yellow TW: Transparent, white TA: Transparent, blue TO: Transparent, orange	100 002	R: Red G: Green Y: Yellow W: White A: Blue O: Orange	A: 6 VAC/DC B: 12 VAC/DC C: 24 VAC/DC D: 100/110/120 VAC E: 200/220/230/240 VAC
		A22NL-BGM-(2)(2)A-G(7)(7)(7)-(8)(9)	A22NL-BGA-(2)(2)A-G(7)(7)(7)-(8)(9)				
	2	A22NL-BGM-(2)(2)A-G(7)(7)(7)-(8)(9)	A22NL-BGA-(2)(2)A-G(7)(7)(7)-(8)(9)		101 102 202		
		A22NL-BGM-(2)(2)A-G(7)(7)(7)-(8)(9)	A22NL-BGA-(2)(2)A-G(7)(7)(7)-(8)(9)				
Brushed metal bezels 	1	A22NL-MGM-(2)(2)A-G(7)(7)(7)-(8)(9)	A22NL-MGA-(2)(2)A-G(7)(7)(7)-(8)(9)	100 002			
		A22NL-MGM-(2)(2)A-G(7)(7)(7)-(8)(9)	A22NL-MGA-(2)(2)A-G(7)(7)(7)-(8)(9)				
	2	A22NL-MGM-(2)(2)A-G(7)(7)(7)-(8)(9)	A22NL-MGA-(2)(2)A-G(7)(7)(7)-(8)(9)	101 102 202			
		A22NL-MGM-(2)(2)A-G(7)(7)(7)-(8)(9)	A22NL-MGA-(2)(2)A-G(7)(7)(7)-(8)(9)				

**Note:** Normally, the Button and LED Lamp with the same color are combined.

However, opaque white is available by combining a white Button and yellow LED. A22N□-□□□-IWA-G□□□-Y□



■ Subassemblies: Refer to pages 8 to 12.  
(You can order Operation Units, LED Lamps, Mounting Collars, and Contact Blocks individually.)

■ Specifications: Refer to page 15. ■ Dimensions: Refer to page 17.  
■ Accessories and tools: Refer to page 13.



## Ordering Information

**Model Numbers for Sets** - - - Shipped as a set that includes the Operation Unit, LED Lamp, Mounting Collar, and Contact Block.

### Non-lighted, Mushroom Switches

Appearance	Contacts	Momentary action (self-resetting)	Alternate action (self-holding)	(2)(2) Button color	(7)(7)(7) Contacts
		Model	Model		
Plastic bezels 	1	A22NN-BMM-(2)(2)A-G(7)(7)(7)-NN	A22NN-BMA-(2)(2)A-G(7)(7)(7)-NN	NR: Opaque, red NG: Opaque, green NY: Opaque, yellow NW: Opaque, white NA: Opaque, blue NB: Opaque, black UR: Transparent, red UG: Transparent, green UY: Transparent, yellow UW: Transparent, white UA: Transparent, blue UO: Transparent, orange	100 002
	2	A22NN-BMM-(2)(2)A-G(7)(7)(7)-NN	A22NN-BMA-(2)(2)A-G(7)(7)(7)-NN		101 102 202
	3	A22NN-BMM-(2)(2)A-G(7)(7)(7)-NN	A22NN-BMA-(2)(2)A-G(7)(7)(7)-NN		111 112 122 222
Brushed metal bezels 	1	A22NN-MMM-(2)(2)A-G(7)(7)(7)-NN	A22NN-MMA-(2)(2)A-G(7)(7)(7)-NN		100 002
	2	A22NN-MMM-(2)(2)A-G(7)(7)(7)-NN	A22NN-MMA-(2)(2)A-G(7)(7)(7)-NN		101 102 202
	3	A22NN-MMM-(2)(2)A-G(7)(7)(7)-NN	A22NN-MMA-(2)(2)A-G(7)(7)(7)-NN		111 112 122 222
Metal bezels 	1	A22NN-RMM-(2)(2)A-G(7)(7)(7)-NN	A22NN-RMA-(2)(2)A-G(7)(7)(7)-NN		100 002
	2	A22NN-RMM-(2)(2)A-G(7)(7)(7)-NN	A22NN-RMA-(2)(2)A-G(7)(7)(7)-NN		101 102 202
	3	A22NN-RMM-(2)(2)A-G(7)(7)(7)-NN	A22NN-RMA-(2)(2)A-G(7)(7)(7)-NN		111 112 122 222

### Lighted, Mushroom Switches

Appearance	Contacts	Momentary action (self-resetting)	Alternate action (self-holding)	(2)(2) Button color	(7)(7)(7) Contacts	(8) LED Lamp color	(9) LED Lamp voltage			
		Model	Model							
Plastic bezels 	1	A22NL-BMM-(2)(2)A-G(7)(7)(7)-(8)(9)	A22NL-BMA-(2)(2)A-G(7)(7)(7)-(8)(9)	TR: Transparent, red TG: Transparent, green TY: Transparent, yellow TW: Transparent, white TA: Transparent, blue TO: Transparent, orange	100 002	R: Red G: Green Y: Yellow W: White A: Blue O: Orange	A: 6 VAC/DC B: 12 VAC/DC C: 24 VAC/DC D: 100/110/120 VAC E: 200/220/230/240 VAC			
		2	A22NL-BMM-(2)(2)A-G(7)(7)(7)-(8)(9)					A22NL-BMA-(2)(2)A-G(7)(7)(7)-(8)(9)	101 102 202	
	1		A22NL-MMM-(2)(2)A-G(7)(7)(7)-(8)(9)		A22NL-MMA-(2)(2)A-G(7)(7)(7)-(8)(9)			100 002		
		2	A22NL-MMM-(2)(2)A-G(7)(7)(7)-(8)(9)		A22NL-MMA-(2)(2)A-G(7)(7)(7)-(8)(9)			101 102 202		
Brushed metal bezels 	1		A22NL-MMM-(2)(2)A-G(7)(7)(7)-(8)(9)		A22NL-MMA-(2)(2)A-G(7)(7)(7)-(8)(9)			TR: Transparent, red TG: Transparent, green TY: Transparent, yellow TW: Transparent, white TA: Transparent, blue TO: Transparent, orange	100 002	R: Red G: Green Y: Yellow W: White A: Blue O: Orange
		2	A22NL-MMM-(2)(2)A-G(7)(7)(7)-(8)(9)		A22NL-MMA-(2)(2)A-G(7)(7)(7)-(8)(9)					
	1		A22NL-RMM-(2)(2)A-G(7)(7)(7)-(8)(9)		A22NL-RMA-(2)(2)A-G(7)(7)(7)-(8)(9)				100 002	
		2	A22NL-RMM-(2)(2)A-G(7)(7)(7)-(8)(9)		A22NL-RMA-(2)(2)A-G(7)(7)(7)-(8)(9)				101 102 202	
Metal bezels 	1		A22NL-RMM-(2)(2)A-G(7)(7)(7)-(8)(9)	A22NL-RMA-(2)(2)A-G(7)(7)(7)-(8)(9)	TR: Transparent, red TG: Transparent, green TY: Transparent, yellow TW: Transparent, white TA: Transparent, blue TO: Transparent, orange	100 002	R: Red G: Green Y: Yellow W: White A: Blue O: Orange		A: 6 VAC/DC B: 12 VAC/DC C: 24 VAC/DC D: 100/110/120 VAC E: 200/220/230/240 VAC	
		2	A22NL-RMM-(2)(2)A-G(7)(7)(7)-(8)(9)	A22NL-RMA-(2)(2)A-G(7)(7)(7)-(8)(9)						

**Note:** Normally, the Button and LED Lamp with the same color are combined.  
 However, opaque white is available by combining a white Button and yellow LED. A22N□-□□□-TWA-G□□□-Y□

■ Subassemblies: Refer to pages 8 to 12.  
 (You can order Operation Units, LED Lamps, Mounting Collars, and Contact Blocks individually.)

■ Specifications: Refer to page 15. ■ Dimensions: Refer to page 17.  
 ■ Accessories and tools: Refer to page 13.

## Ordering Information

**Switch Structure** - - - You can order Operation Units, LED Lamp, Mounting Collars, and Contact Blocks individually. Use them in combination for models that are not available as assembled Switches. They can also be used as inventory for maintenance parts.

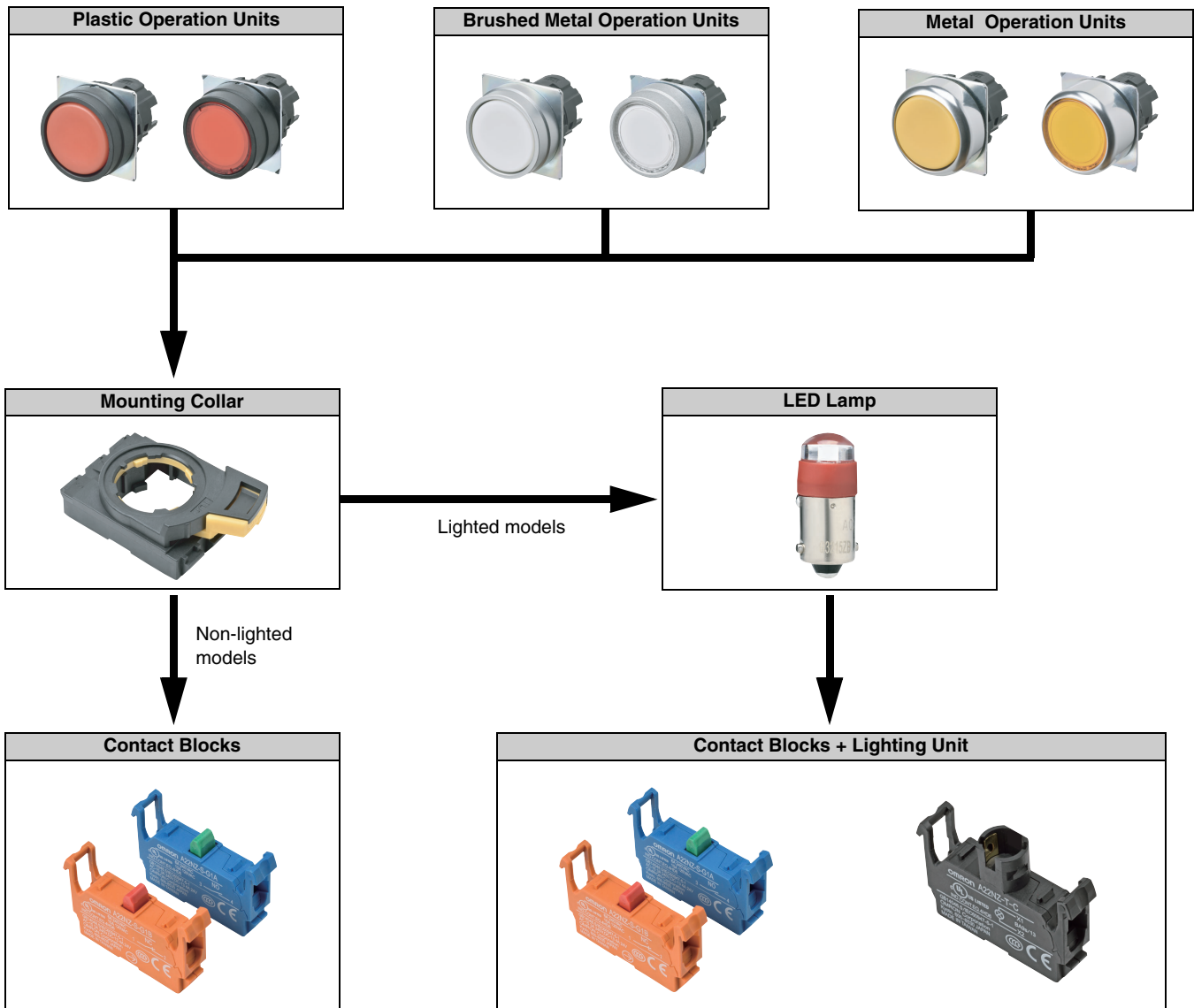

**Note:** Use a Reinforcement Plate for greater strength.

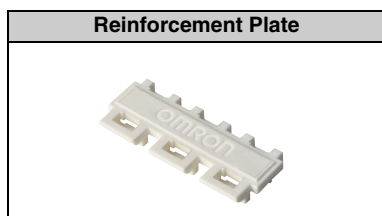

■ Model numbers of sets: Refer to pages 4 to 7.

■ Specifications: Refer to page 15. ■ Dimensions: Refer to page 17.  
 ■ Accessories and tools: Refer to page 13.

## Ordering Information

### Subassemblies

----- You can order Operation Units, LED Lamps, Mounting Collars, and Contact Blocks individually. Use them in combination for models that are not available as assembled Switches. They can also be used as inventory for maintenance parts.

### Operation Units

Bezel material and button shape			Plastic, flat		Plastic, projected	
						
Lighted/ non-lighted	Switch Action		Momentary	Alternate	Momentary	Alternate
	Transparency	Color	Model	Model	Model	Model
Non-lighted	Opaque	Red	A22NZ-BNM-NRA	A22NZ-BNA-NRA	A22NZ-BPM-NRA	A22NZ-BPA-NRA
	Opaque	Green	A22NZ-BNM-NGA	A22NZ-BNA-NGA	A22NZ-BPM-NGA	A22NZ-BPA-NGA
	Opaque	Yellow	A22NZ-BNM-NYA	A22NZ-BNA-NYA	A22NZ-BPM-NYA	A22NZ-BPA-NYA
	Opaque	White	A22NZ-BNM-NWA	A22NZ-BNA-NWA	A22NZ-BPM-NWA	A22NZ-BPA-NWA
	Opaque	Blue	A22NZ-BNM-NAA	A22NZ-BNA-NAA	A22NZ-BPM-NAA	A22NZ-BPA-NAA
	Opaque	Black	A22NZ-BNM-NBA	A22NZ-BNA-NBA	A22NZ-BPM-NBA	A22NZ-BPA-NBA
	Transparent	Red	A22NZ-BNM-URA	A22NZ-BNA-URA	A22NZ-BPM-URA	A22NZ-BPA-URA
	Transparent	Green	A22NZ-BNM-UGA	A22NZ-BNA-UGA	A22NZ-BPM-UGA	A22NZ-BPA-UGA
	Transparent	Yellow	A22NZ-BNM-UYA	A22NZ-BNA-UYA	A22NZ-BPM-UYA	A22NZ-BPA-UYA
	Transparent	White	A22NZ-BNM-UWA	A22NZ-BNA-UWA	A22NZ-BPM-UWA	A22NZ-BPA-UWA
	Transparent	Blue	A22NZ-BNM-UAA	A22NZ-BNA-UAA	A22NZ-BPM-UAA	A22NZ-BPA-UAA
Lighted	Transparent	Orange	A22NZ-BNM-UOA	A22NZ-BNA-UOA	A22NZ-BPM-UOA	A22NZ-BPA-UOA
	Transparent	Red	A22NZ-BNM-TRA	A22NZ-BNA-TRA	A22NZ-BPM-TRA	A22NZ-BPA-TRA
	Transparent	Green	A22NZ-BNM-TGA	A22NZ-BNA-TGA	A22NZ-BPM-TGA	A22NZ-BPA-TGA
	Transparent	Yellow	A22NZ-BNM-TYA	A22NZ-BNA-TYA	A22NZ-BPM-TYA	A22NZ-BPA-TYA
	Transparent	White	A22NZ-BNM-TWA	A22NZ-BNA-TWA	A22NZ-BPM-TWA	A22NZ-BPA-TWA
	Transparent	Blue	A22NZ-BNM-TAA	A22NZ-BNA-TAA	A22NZ-BPM-TAA	A22NZ-BPA-TAA
Transparent	Orange	A22NZ-BNM-TOA	A22NZ-BNA-TOA	A22NZ-BPM-TOA	A22NZ-BPA-TOA	

Bezel material and button shape			Plastic, full-guard		Plastic, mushroom	
						
Lighted/ non-lighted	Switch Action		Momentary	Alternate	Momentary	Alternate
	Transparency	Color	Model	Model	Model	Model
Non-lighted	Opaque	Red	A22NZ-BGM-NRA	A22NZ-BGA-NRA	A22NZ-BMM-NRA	A22NZ-BMA-NRA
	Opaque	Green	A22NZ-BGM-NGA	A22NZ-BGA-NGA	A22NZ-BMM-NGA	A22NZ-BMA-NGA
	Opaque	Yellow	A22NZ-BGM-NYA	A22NZ-BGA-NYA	A22NZ-BMM-NYA	A22NZ-BMA-NYA
	Opaque	White	A22NZ-BGM-NWA	A22NZ-BGA-NWA	A22NZ-BMM-NWA	A22NZ-BMA-NWA
	Opaque	Blue	A22NZ-BGM-NAA	A22NZ-BGA-NAA	A22NZ-BMM-NAA	A22NZ-BMA-NAA
	Opaque	Black	A22NZ-BGM-NBA	A22NZ-BGA-NBA	A22NZ-BMM-NBA	A22NZ-BMA-NBA
	Transparent	Red	A22NZ-BGM-URA	A22NZ-BGA-URA	A22NZ-BMM-URA	A22NZ-BMA-URA
	Transparent	Green	A22NZ-BGM-UGA	A22NZ-BGA-UGA	A22NZ-BMM-UGA	A22NZ-BMA-UGA
	Transparent	Yellow	A22NZ-BGM-UYA	A22NZ-BGA-UYA	A22NZ-BMM-UYA	A22NZ-BMA-UYA
	Transparent	White	A22NZ-BGM-UWA	A22NZ-BGA-UWA	A22NZ-BMM-UWA	A22NZ-BMA-UWA
	Transparent	Blue	A22NZ-BGM-UAA	A22NZ-BGA-UAA	A22NZ-BMM-UAA	A22NZ-BMA-UAA
Lighted	Transparent	Orange	A22NZ-BGM-UOA	A22NZ-BGA-UOA	A22NZ-BMM-UOA	A22NZ-BMA-UOA
	Transparent	Red	A22NZ-BGM-TRA	A22NZ-BGA-TRA	A22NZ-BMM-TRA	A22NZ-BMA-TRA
	Transparent	Green	A22NZ-BGM-TGA	A22NZ-BGA-TGA	A22NZ-BMM-TGA	A22NZ-BMA-TGA
	Transparent	Yellow	A22NZ-BGM-TYA	A22NZ-BGA-TYA	A22NZ-BMM-TYA	A22NZ-BMA-TYA
	Transparent	White	A22NZ-BGM-TWA	A22NZ-BGA-TWA	A22NZ-BMM-TWA	A22NZ-BMA-TWA
	Transparent	Blue	A22NZ-BGM-TAA	A22NZ-BGA-TAA	A22NZ-BMM-TAA	A22NZ-BMA-TAA
Transparent	Orange	A22NZ-BGM-TOA	A22NZ-BGA-TOA	A22NZ-BMM-TOA	A22NZ-BMA-TOA	

■ Model numbers of sets: Refer to pages 4 to 7.

■ Specifications: Refer to page 15. ■ Dimensions: Refer to page 17.  
 ■ Accessories and tools: Refer to page 13.

## Ordering Information

### Subassemblies

----- You can order Operation Units, LED Lamps, Mounting Collars, and Contact Blocks individually. Use them in combination for models that are not available as assembled Switches. They can also be used as inventory for maintenance parts.

Bezel material and button shape			Brushed metal, flat		Brushed metal, projected	
						
Lighted/ non-lighted	Switch Action		Momentary	Alternate	Momentary	Alternate
	Transparency	Color	Model	Model	Model	Model
Non-lighted	Opaque	Red	A22NZ-MNM-NRA	A22NZ-MNA-NRA	A22NZ-MPM-NRA	A22NZ-MPA-NRA
	Opaque	Green	A22NZ-MNM-NGA	A22NZ-MNA-NGA	A22NZ-MPM-NGA	A22NZ-MPA-NGA
	Opaque	Yellow	A22NZ-MNM-NYA	A22NZ-MNA-NYA	A22NZ-MPM-NYA	A22NZ-MPA-NYA
	Opaque	White	A22NZ-MNM-NWA	A22NZ-MNA-NWA	A22NZ-MPM-NWA	A22NZ-MPA-NWA
	Opaque	Blue	A22NZ-MNM-NAA	A22NZ-MNA-NAA	A22NZ-MPM-NAA	A22NZ-MPA-NAA
	Opaque	Black	A22NZ-MNM-NBA	A22NZ-MNA-NBA	A22NZ-MPM-NBA	A22NZ-MPA-NBA
	Transparent	Red	A22NZ-MNM-URA	A22NZ-MNA-URA	A22NZ-MPM-URA	A22NZ-MPA-URA
	Transparent	Green	A22NZ-MNM-UGA	A22NZ-MNA-UGA	A22NZ-MPM-UGA	A22NZ-MPA-UGA
	Transparent	Yellow	A22NZ-MNM-UYA	A22NZ-MNA-UYA	A22NZ-MPM-UYA	A22NZ-MPA-UYA
	Transparent	White	A22NZ-MNM-UWA	A22NZ-MNA-UWA	A22NZ-MPM-UWA	A22NZ-MPA-UWA
	Transparent	Blue	A22NZ-MNM-UAA	A22NZ-MNA-UAA	A22NZ-MPM-UAA	A22NZ-MPA-UAA
Lighted	Transparent	Red	A22NZ-MNM-TRA	A22NZ-MNA-TRA	A22NZ-MPM-TRA	A22NZ-MPA-TRA
	Transparent	Green	A22NZ-MNM-TGA	A22NZ-MNA-TGA	A22NZ-MPM-TGA	A22NZ-MPA-TGA
	Transparent	Yellow	A22NZ-MNM-TYA	A22NZ-MNA-TYA	A22NZ-MPM-TYA	A22NZ-MPA-TYA
	Transparent	White	A22NZ-MNM-TWA	A22NZ-MNA-TWA	A22NZ-MPM-TWA	A22NZ-MPA-TWA
	Transparent	Blue	A22NZ-MNM-TAA	A22NZ-MNA-TAA	A22NZ-MPM-TAA	A22NZ-MPA-TAA
	Transparent	Orange	A22NZ-MNM-TOA	A22NZ-MNA-TOA	A22NZ-MPM-TOA	A22NZ-MPA-TOA

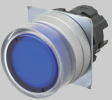
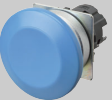
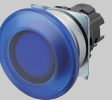
Bezel material and button shape			Brushed metal, full-guard		Brushed metal, mushroom	
						
Lighted/ non-lighted	Switch Action		Momentary	Alternate	Momentary	Alternate
	Transparency	Color	Model	Model	Model	Model
Non-lighted	Opaque	Red	A22NZ-MGM-NRA	A22NZ-MGA-NRA	A22NZ-MMM-NRA	A22NZ-MMA-NRA
	Opaque	Green	A22NZ-MGM-NGA	A22NZ-MGA-NGA	A22NZ-MMM-NGA	A22NZ-MMA-NGA
	Opaque	Yellow	A22NZ-MGM-NYA	A22NZ-MGA-NYA	A22NZ-MMM-NYA	A22NZ-MMA-NYA
	Opaque	White	A22NZ-MGM-NWA	A22NZ-MGA-NWA	A22NZ-MMM-NWA	A22NZ-MMA-NWA
	Opaque	Blue	A22NZ-MGM-NAA	A22NZ-MGA-NAA	A22NZ-MMM-NAA	A22NZ-MMA-NAA
	Opaque	Black	A22NZ-MGM-NBA	A22NZ-MGA-NBA	A22NZ-MMM-NBA	A22NZ-MMA-NBA
	Transparent	Red	A22NZ-MGM-URA	A22NZ-MGA-URA	A22NZ-MMM-URA	A22NZ-MMA-URA
	Transparent	Green	A22NZ-MGM-UGA	A22NZ-MGA-UGA	A22NZ-MMM-UGA	A22NZ-MMA-UGA
	Transparent	Yellow	A22NZ-MGM-UYA	A22NZ-MGA-UYA	A22NZ-MMM-UYA	A22NZ-MMA-UYA
	Transparent	White	A22NZ-MGM-UWA	A22NZ-MGA-UWA	A22NZ-MMM-UWA	A22NZ-MMA-UWA
	Transparent	Blue	A22NZ-MGM-UAA	A22NZ-MGA-UAA	A22NZ-MMM-UAA	A22NZ-MMA-UAA
Lighted	Transparent	Red	A22NZ-MGM-TRA	A22NZ-MGA-TRA	A22NZ-MMM-TRA	A22NZ-MMA-TRA
	Transparent	Green	A22NZ-MGM-TGA	A22NZ-MGA-TGA	A22NZ-MMM-TGA	A22NZ-MMA-TGA
	Transparent	Yellow	A22NZ-MGM-TYA	A22NZ-MGA-TYA	A22NZ-MMM-TYA	A22NZ-MMA-TYA
	Transparent	White	A22NZ-MGM-TWA	A22NZ-MGA-TWA	A22NZ-MMM-TWA	A22NZ-MMA-TWA
	Transparent	Blue	A22NZ-MGM-TAA	A22NZ-MGA-TAA	A22NZ-MMM-TAA	A22NZ-MMA-TAA
	Transparent	Orange	A22NZ-MGM-TOA	A22NZ-MGA-TOA	A22NZ-MMM-TOA	A22NZ-MMA-TOA

■ Model numbers of sets: Refer to pages 4 to 7.

■ Specifications: Refer to page 15. ■ Dimensions: Refer to page 17.  
 ■ Accessories and tools: Refer to page 13.

## Ordering Information

**Subassemblies** - - - - You can order Operation Units, LED Lamps, Mounting Collars, and Contact Blocks individually. Use them in combination for models that are not available as assembled Switches. They can also be used as inventory for maintenance parts.

Bezel material and button shape			Metal, flat		Metal, projected	
			Switch Action		Switch Action	
Lighted/ non-lighted	Transparency	Color	Momentary	Alternate	Momentary	Alternate
			Model	Model	Model	Model
Non-lighted	Opaque	Red	A22NZ-RNM-NRA	A22NZ-RNA-NRA	A22NZ-RPM-NRA	A22NZ-RPA-NRA
	Opaque	Green	A22NZ-RNM-NGA	A22NZ-RNA-NGA	A22NZ-RPM-NGA	A22NZ-RPA-NGA
	Opaque	Yellow	A22NZ-RNM-NYA	A22NZ-RNA-NYA	A22NZ-RPM-NYA	A22NZ-RPA-NYA
	Opaque	White	A22NZ-RNM-NWA	A22NZ-RNA-NWA	A22NZ-RPM-NWA	A22NZ-RPA-NWA
	Opaque	Blue	A22NZ-RNM-NAA	A22NZ-RNA-NAA	A22NZ-RPM-NAA	A22NZ-RPA-NAA
	Opaque	Black	A22NZ-RNM-NBA	A22NZ-RNA-NBA	A22NZ-RPM-NBA	A22NZ-RPA-NBA
	Transparent	Red	A22NZ-RNM-URA	A22NZ-RNA-URA	A22NZ-RPM-URA	A22NZ-RPA-URA
	Transparent	Green	A22NZ-RNM-UGA	A22NZ-RNA-UGA	A22NZ-RPM-UGA	A22NZ-RPA-UGA
	Transparent	Yellow	A22NZ-RNM-UYA	A22NZ-RNA-UYA	A22NZ-RPM-UYA	A22NZ-RPA-UYA
	Transparent	White	A22NZ-RNM-UWA	A22NZ-RNA-UWA	A22NZ-RPM-UWA	A22NZ-RPA-UWA
	Transparent	Blue	A22NZ-RNM-UAA	A22NZ-RNA-UAA	A22NZ-RPM-UAA	A22NZ-RPA-UAA
	Transparent	Orange	A22NZ-RNM-UOA	A22NZ-RNA-UOA	A22NZ-RPM-UOA	A22NZ-RPA-UOA
Lighted	Transparent	Red	A22NZ-RNM-TRA	A22NZ-RNA-TRA	A22NZ-RPM-TRA	A22NZ-RPA-TRA
	Transparent	Green	A22NZ-RNM-TGA	A22NZ-RNA-TGA	A22NZ-RPM-TGA	A22NZ-RPA-TGA
	Transparent	Yellow	A22NZ-RNM-TYA	A22NZ-RNA-TYA	A22NZ-RPM-TYA	A22NZ-RPA-TYA
	Transparent	White	A22NZ-RNM-TWA	A22NZ-RNA-TWA	A22NZ-RPM-TWA	A22NZ-RPA-TWA
	Transparent	Blue	A22NZ-RNM-TAA	A22NZ-RNA-TAA	A22NZ-RPM-TAA	A22NZ-RPA-TAA
	Transparent	Orange	A22NZ-RNM-TOA	A22NZ-RNA-TOA	A22NZ-RPM-TOA	A22NZ-RPA-TOA

Bezel material and button shape			Metal, mushroom	
			Switch Action	
Lighted/ non-lighted	Transparency	Color	Momentary	Alternate
			Model	Model
Non-lighted	Opaque	Red	A22NZ-RMM-NRA	A22NZ-RMA-NRA
	Opaque	Green	A22NZ-RMM-NGA	A22NZ-RMA-NGA
	Opaque	Yellow	A22NZ-RMM-NYA	A22NZ-RMA-NYA
	Opaque	White	A22NZ-RMM-NWA	A22NZ-RMA-NWA
	Opaque	Blue	A22NZ-RMM-NAA	A22NZ-RMA-NAA
	Opaque	Black	A22NZ-RMM-NBA	A22NZ-RMA-NBA
	Transparent	Red	A22NZ-RMM-URA	A22NZ-RMA-URA
	Transparent	Green	A22NZ-RMM-UGA	A22NZ-RMA-UGA
	Transparent	Yellow	A22NZ-RMM-UYA	A22NZ-RMA-UYA
	Transparent	White	A22NZ-RMM-UWA	A22NZ-RMA-UWA
	Transparent	Blue	A22NZ-RMM-UAA	A22NZ-RMA-UAA
	Transparent	Orange	A22NZ-RMM-UOA	A22NZ-RMA-UOA
Lighted	Transparent	Red	A22NZ-RMM-TRA	A22NZ-RMA-TRA
	Transparent	Green	A22NZ-RMM-TGA	A22NZ-RMA-TGA
	Transparent	Yellow	A22NZ-RMM-TYA	A22NZ-RMA-TYA
	Transparent	White	A22NZ-RMM-TWA	A22NZ-RMA-TWA
	Transparent	Blue	A22NZ-RMM-TAA	A22NZ-RMA-TAA
	Transparent	Orange	A22NZ-RMM-TOA	A22NZ-RMA-TOA

■ Model numbers of sets: Refer to pages 4 to 7.

■ Specifications: Refer to page 15. ■ Dimensions: Refer to page 17.  
 ■ Accessories and tools: Refer to page 13.

# A22NN/A22NL

## Ordering Information

**Subassemblies** --- You can order Operation Units, LED Lamps, Mounting Collars, and Contact Blocks individually. Use them in combination for models that are not available as assembled Switches. They can also be used as inventory for maintenance parts.

### LED Lamps

Appearance	Applied voltage	6 VAC/DC	12 VAC/DC	24 VAC/DC	100/110/120 VAC	200/220/230/240 VAC
	Color	Model	Model	Model	Model	Model
	Red	A22NZ-L-RA	A22NZ-L-RB	A22NZ-L-RC	A22NZ-L-RD	A22NZ-L-RE
	Green	A22NZ-L-GA	A22NZ-L-GB	A22NZ-L-GC	A22NZ-L-GD	A22NZ-L-GE
	Yellow	A22NZ-L-YA	A22NZ-L-YB	A22NZ-L-YC	A22NZ-L-YD	A22NZ-L-YE
	White	A22NZ-L-WA	A22NZ-L-WB	A22NZ-L-WC	A22NZ-L-WD	A22NZ-L-WE
	Blue	A22NZ-L-AA	A22NZ-L-AB	A22NZ-L-AC	A22NZ-L-AD	A22NZ-L-AE
	Orange	A22NZ-L-OA	A22NZ-L-OB	A22NZ-L-OC	A22NZ-L-OD	A22NZ-L-OE

### Mounting Collar

Appearance	Model
	A22NZ-H-01

### Contact Blocks

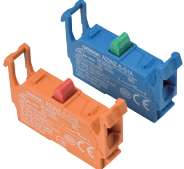
Appearance	Contacts	Model
	SPST-NO (blue)	A22NZ-S-G1A
	SPST-NC (orange)	A22NZ-S-G1B

### Lighting Units







Appearance	Applied voltage	Model
	6 VAC/DC	A22NZ-T-A
	12 VAC/DC	A22NZ-T-B
	24 VAC/DC	A22NZ-T-C
	100/110/120 VAC	A22NZ-T-D
	200/220/230/240 VAC	A22NZ-T-E

### Reinforcement Plate

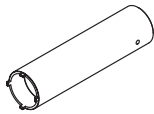
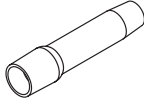
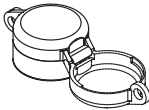
Appearance	Model
	A22NZ-A-C01

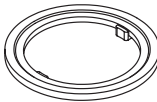
## Ordering Information

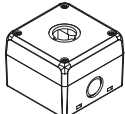
### Accessories and Tools (Order Separately)

Item	Appearance	Classification	Model	Remarks
Tightening Wrench		---	<b>A22NZ-A-301</b>	Used to tighten Mounting Nuts from the back of the panel.
LED Lamp Extractor		---	<b>A22NZ-A-302</b>	Made of rubber and used to easily remove and attach LED Lamps.
Protective Cover		---	<b>A22NZ-A-303</b>	A protector designed to prevent incorrect operation. Cannot be used together with other accessories. (Rubber seal included.)
Plastic Hole Plug		Round	<b>A22NZ-A-401</b>	Can be plugged into precut panel holes for future expansion. Applicable panel thickness: 0.8 to 3.0 mm For 22.3-mm panel hole diameter.
Metal Hole Plug		Round	<b>A22NZ-A-402</b>	Can be plugged into precut panel holes for future expansion. Applicable panel thickness: 0.8 to 6.0 mm (Rubber seal included.)
Lock Ring		Round	<b>A22NZ-A-403</b>	Used when a more secure lock is required to prevent rotation inside the Operation Unit. (Rubber seal included.) For 22.3-mm panel hole diameter.
Lock Ring		---	<b>A22NZ-A-50501</b>	Used when a more secure lock is required to prevent rotation of the Operation Unit.
Control Box		1 hole	<b>A22NZ-A-B01Y</b>	
Cap Tightening Wrench		---	<b>A22Z-3908</b>	Used to replace the Caps on Flat, Projected, and Full-guard Push-button Switches.

# A22NN/A22NL

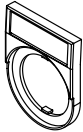
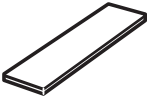
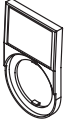
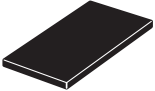
Item	Appearance	Classification	Model	Remarks
Small Legend Plate Frame		Black	<b>A22NZ-A-50103</b>	Legend Plate with no text on black background included. For 22.3-mm panel hole diameter.
Small Legend Plates		Without text	<b>A22Z-3443B</b>	Black
			<b>A22Z-3443R</b>	Red
			<b>A22Z-3443W</b>	White
			<b>A22Z-3443C</b>	Transparent
		○	<b>A22Z-3443R-2</b>	White text on red background
		STOP	<b>A22Z-3443R-4</b>	
		---	<b>A22Z-3443B-1</b>	Legend Plate with white text on black background included. For 22.3-mm panel hole diameter.
		START	<b>A22Z-3443B-3</b>	
		ON	<b>A22Z-3443B-5</b>	
		OFF	<b>A22Z-3443B-6</b>	
		UP	<b>A22Z-3443B-7</b>	
		DOWN	<b>A22Z-3443B-8</b>	
		POWER ON	<b>A22Z-3443B-9</b>	
OFF-ON	<b>A22Z-3443B-10</b>			
Large Legend Plate Frame		Black	<b>A22NZ-A-51103</b>	Legend Plate with no text on black background included. For 22.3-mm panel hole diameter.
Large Legend Plates		Without text	<b>A22Z-3453B</b>	Black
			<b>A22Z-3453R</b>	Red
			<b>A22Z-3453W</b>	White
			<b>A22Z-3453C</b>	Transparent

## Specifications

### Certified Safety Standard Ratings

UL 508 (File No. E76675), CSA C22.2 No.14

6 A 240 VAC, 10 A 120 VAC

TÜV (EN60947-5-1)

AC-15 3 A 240 VAC

DC-13 4 A 24 VDC

CCC (GB14048.5)

AC-15 3 A 240 VAC

DC-13 4 A 24 VDC

### Ratings

#### Contacts (Standard Load)

<b>Rated insulation voltage</b>		600 V				
<b>Rated carry current</b>		10 A				
<b>Applied voltage</b>		24 V	120 V	240 V	380 V	440 V
<b>AC at 50/60 Hz</b>	Resistive load (AC-12)	10 A	10 A	6 A	2A	2 A
	Inductive load (AC-15)	10 A	6 A	3 A	1.9 A	1.6 A
<b>DC</b>	Resistive load (DC-12)	8 A	2.2 A	1.1 A	---	---
	Inductive load (DC-13)	4 A	1.1 A	0.55 A	---	---

**Note: 1.** The above ratings were obtained by conducting tests under the following conditions.

(1) Ambient temperature: 20 ±2°C

(2) Ambient humidity: 65% ±5% RH

(3) Operating frequency: 30 operations/minute

**2.** Minimum applicable load: 10 mA at 5 VDC.

### LED Lamps

Rated voltage	Applied voltage	Rated current
6 VAC/DC	6 VAC/DC ±10%	Approx. 11 mA (red, orange, yellow, or blue)
		Approx. 5 mA (white or green)
12 VAC/DC	12 VAC/DC ±10%	Approx. 12 mA (red, orange, yellow, or blue)
		Approx. 5 mA (white or green)
24 VAC/DC	24 VAC/DC ±10%	Approx. 12 mA (red, orange, yellow, or blue)
		Approx. 5 mA (white or green)
100 VAC	100 VAC ±10%	Approx. 2 mA
110 VAC	110 VAC ±10%	
120 VAC	100 to 130 VAC	
200 VAC	200 VAC ±10%	Approx. 2 mA
220 VAC	220 VAC ±10%	
230 VAC	230 VAC ±10%	
240 VAC	220 to 250 VAC	

## Specifications

### Characteristics

Item	Type	Pushbutton Switches	
		Non-lighted models	Lighted models
Allowable operating frequency	Mechanical	60 operations/minute max.	
	Electrical	30 operations/minute max.	
Insulation resistance		100 MΩ min. (at 500 VDC)	
Contact resistance		100 mΩ max. (initial value)	
Dielectric strength	Between terminals of same polarity	2,500 VAC at 50/60 Hz for 1 min	
	Between each terminal and ground	2,500 VAC at 50/60 Hz for 1 min	
Vibration resistance	Malfunction	10 to 55 Hz, 1.5-mm double amplitude (malfunction within 1 ms)	
Shock resistance	Malfunction	1,000 m/s <sup>2</sup> max. (malfunction within 1 ms)	
Durability	Mechanical	Momentary action: 5,000,000 operations min. Alternate action: 500,000 operations min.	
	Electrical	500,000 operations min.	
Ambient operating temperature <sup>*1</sup>		-25 to 70°C	-25 to 55°C
Ambient operating humidity		35% to 85% RH	
Ambient storage temperature <sup>*1</sup>		-40 to 80°C	
Degree of protection <sup>*2</sup>		IP66, NEMA 4X, NEMA13	
Electric shock protection class		Class II	
PTI (tracking characteristic)		175	
Degree of contamination (application environment)		3 (IEC 60947-5-1)	
Weight		Approx. 50 g (for 1NC/1NO)	Approx. 65 g (for 1NC/1NO)

\*1. With no icing or condensation.

\*2. Degree of protection from the front of the panel.

### Operating Characteristics (for SPST-NO/SPST-NC)

Item	Type	Pushbutton Switches	
		Lighted/non-lighted	
Total travel force (torque) (maximum TTF)		18 N	
Total travel (TT)		6 mm max.	
Resetting force (torque) (RF)		---	

### Examples of Linked Contact Blocks

Contact Blocks

Lighting Units

	Pushbutton Switches			
	Momentary		Alternate	
	Lighted	Non-lighted	Lighted	Non-lighted
Linking example				

**Note:** If you increase the number of Contact Blocks, evaluate the Switch under actual working conditions before permanent installation and use the Switch within a number of switching operations that will not adversely affect the Switch's performance.

## Dimensions

### Lighted and Non-lighted Pushbutton Switches

#### Flat Switches with Plastic Bezels

A22NN-BN□-N□A-G□-NN

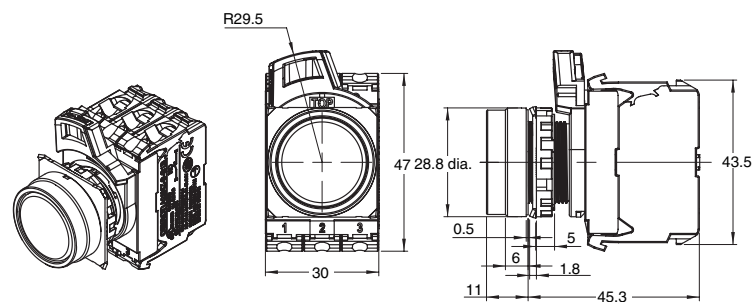

A22NL-BN□-T□A-G□-□□

A22NN-BN□-U□A-G□-NN

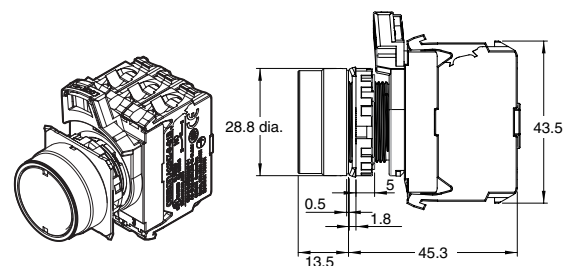

#### Projected Switches with Plastic Bezels

A22N□-BP□-□A-G□-□□

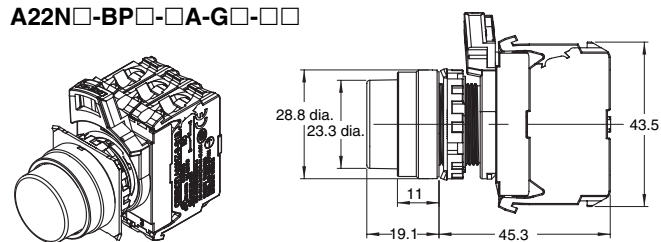

#### Full-guard Switches with Plastic Bezels

A22N□-BG□-□A-G□-□□

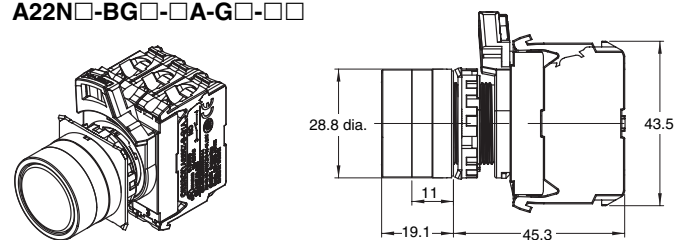

#### Mushroom Switches with Plastic Bezels

A22N□-BM□-□A-G□-□□

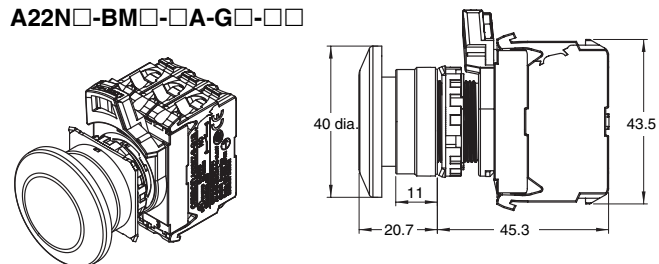

# A22NN/A22NL

## Dimensions

(Unit: mm)

### Flat Switches with Brushed Metal Bezels

A22NN-MN□-N□A-G□-NN

A22NL-MN□-T□A-G□-□□

A22NN-MN□-U□A-G□-NN

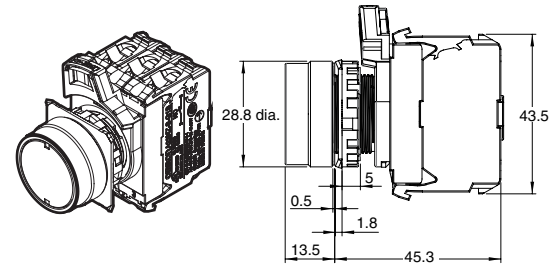
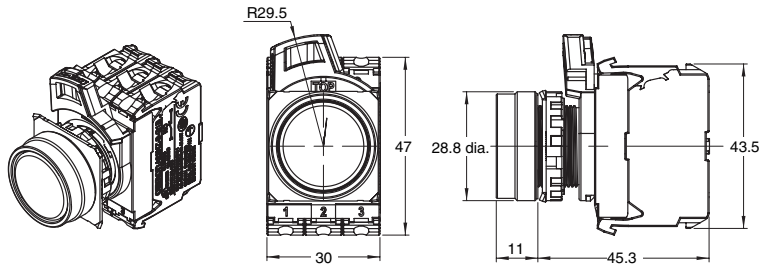

### Projected Switches with Brushed Metal Bezels

A22N□-MP□-□A-G□-□□

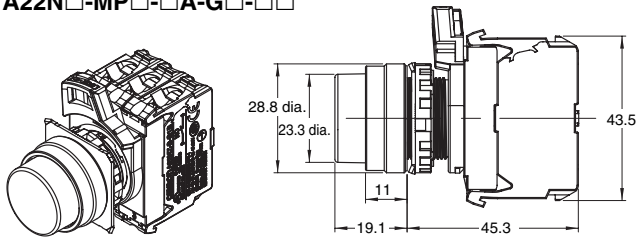

### Full-guard Switches with Brushed Metal Bezels

A22N□-MG□-□A-G□-□□

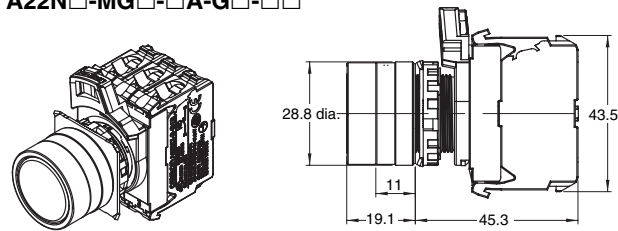

### Mushroom Switches with Brushed Metal Bezels

A22N□-MM□-□A-G□-□□

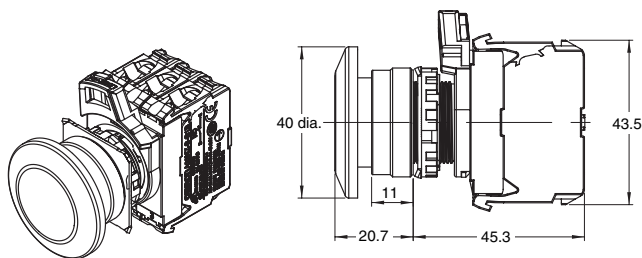

# Dimensions

## Flat Switches with Metal Bezels

A22NN-RN□-N□A-G□-NN

A22NL-RN□-T□A-G□-□□

A22NN-RN□-U□A-G□-NN

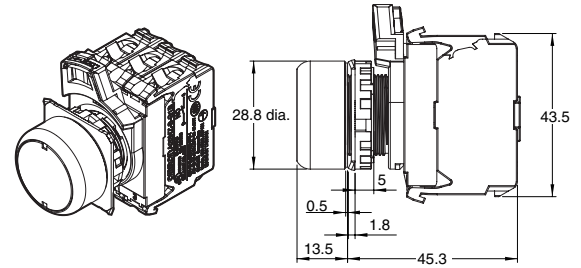
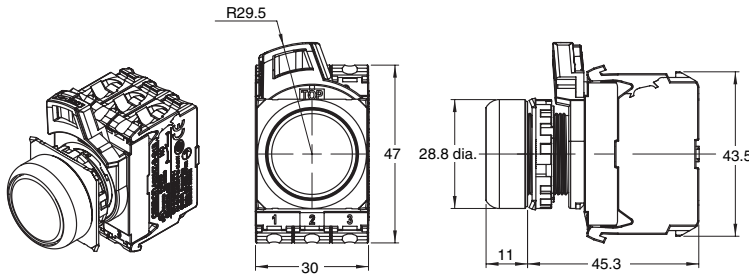

## Projected Switches with Metal Bezels

A22N□-RP□-□A-G□-□□

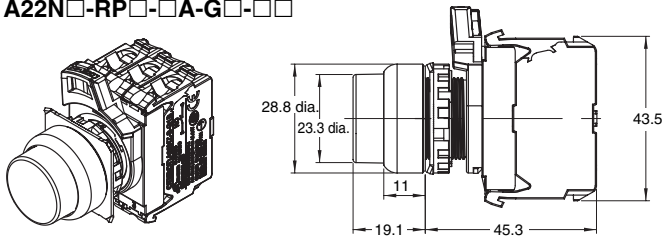

## Mushroom Switches with Metal Bezels

A22N□-RM□-□A-G□-□□

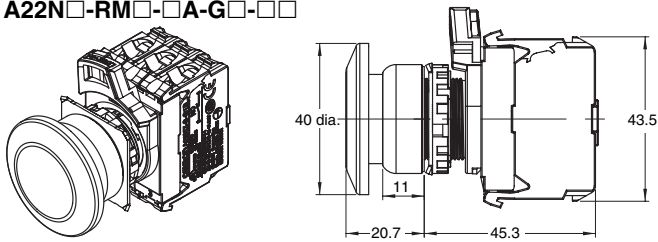

## Depth with Linked Units

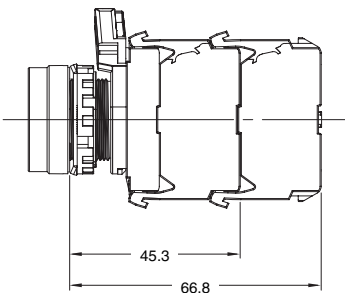

## Terminal Wiring Diagrams

### Bottom View

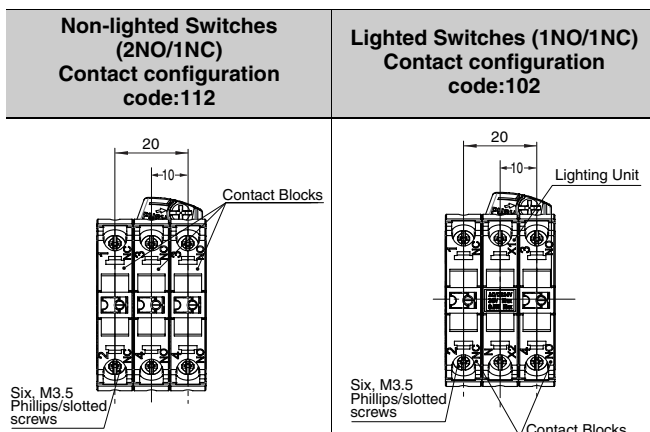

## Terminal Connection Diagrams

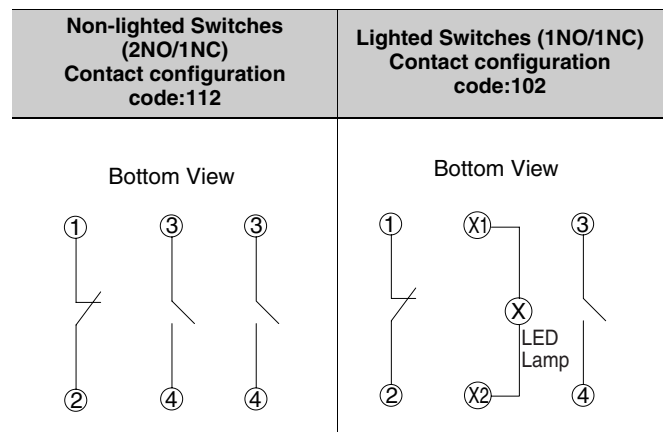

# A22NN/A22NL

## Dimensions

(Unit: mm)

### LED Lamps A22NZ-L-□□

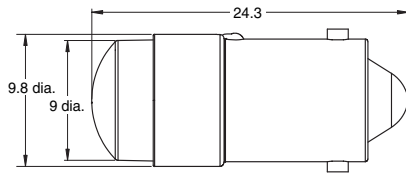
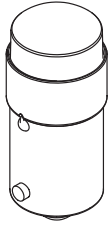

### Mounting Collar A22NZ-H-01

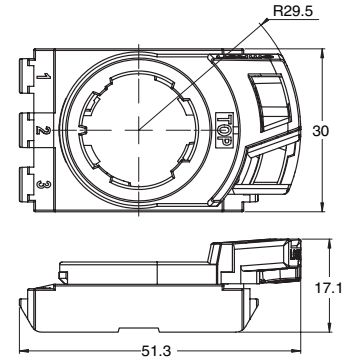
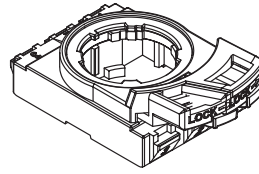

### Contact Blocks A22NZ-S-G1□

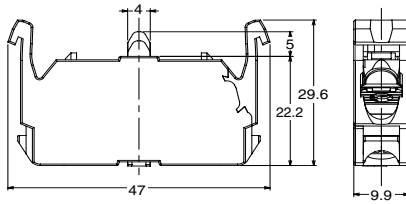
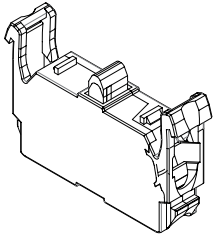

### Lighting Units A22NZ-Z-□

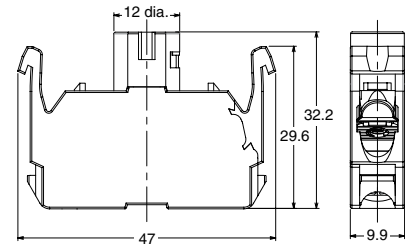
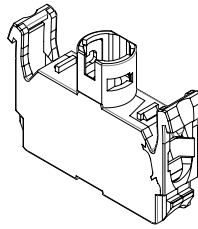

### Reinforcement Plate A22NZ-A-C01

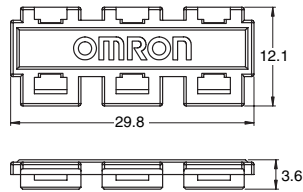
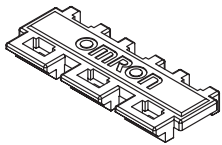

Dimensions

(Unit: mm)

Dimensions of Accessories

**Tightening Wrench**  
A22NZ-A-301

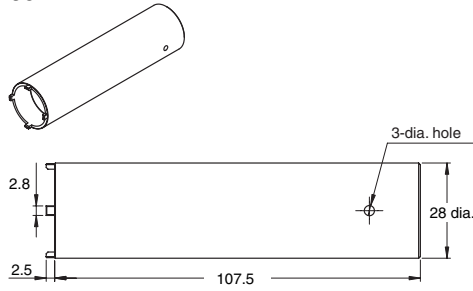

**LED Extractor**  
A22NZ-A-302

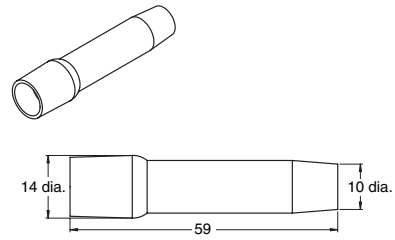

**Protective Cover**  
A22NZ-A303

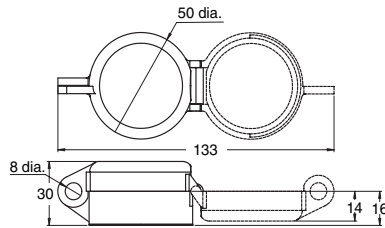
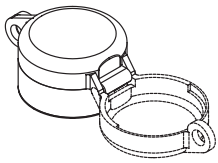

**Plastic Hole Plug**  
A22NZ-A-401

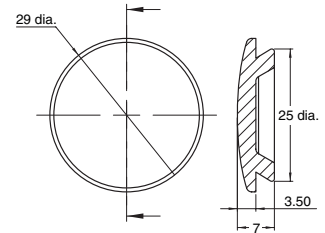

**Metal Hole Plug**  
A22NZ-A-402

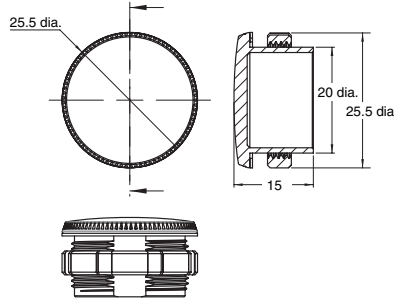
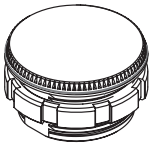

**Lock Ring**  
A22NZ-A-403

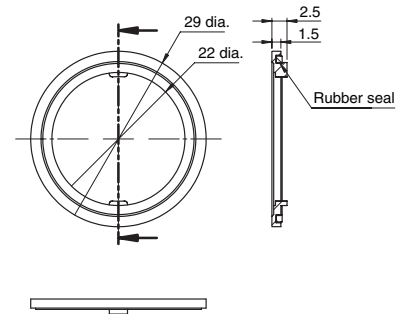
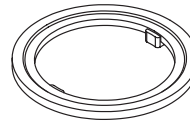

**Control Box**  
A22NZ-A-B01Y

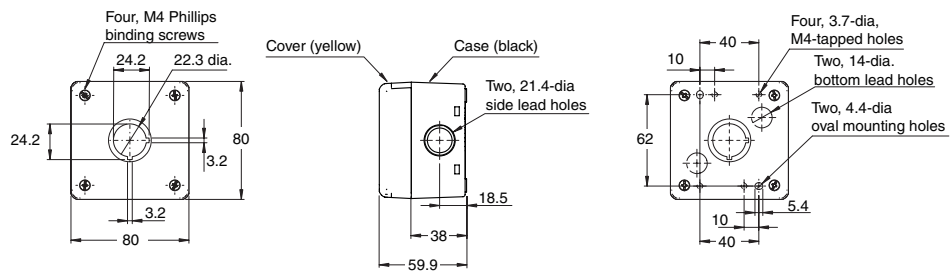
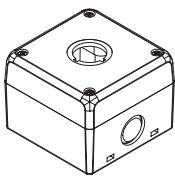

**Lock Ring**

A22NZ-A-50501

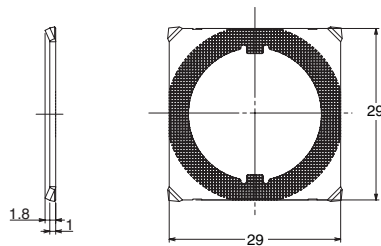
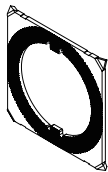

# A22NN/A22NL

## Dimensions

(Unit: mm)

### Legend Plate Frames

Small A22NZ-A-50103

Large A22NZ-A-51103

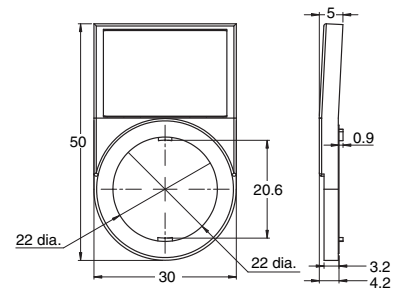
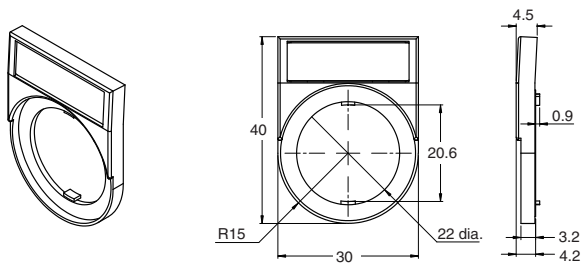

### Legend Plates

Small A22Z-3443 □ □

Large A22Z-3453 □

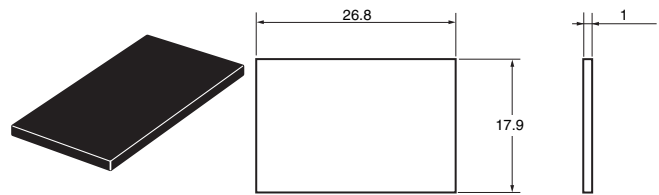
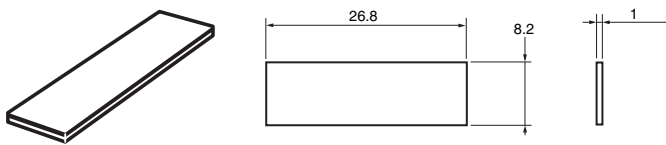

### Cap Tightening Wrench

A22Z-3908

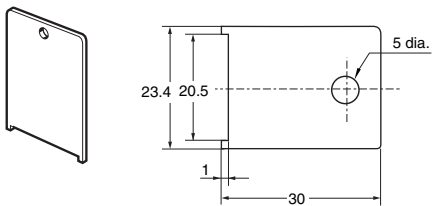

## Safety Precautions

Refer to Safety Precautions for All Pushbutton Switches/Indicators.

### Precautions for Safe Use

- Never perform wiring work on a Switch while power is being supplied. Never touch terminals and other charged parts while power is being supplied. Doing so may result in electrical shock.
- Never attempt to disassemble or modify the Switch in any way. Doing so may prevent correct operation.
- Switch functionality may be inhibited. Do not drop the Switch. Never apply a force that would deform or alter the nature of the Switch.
- The durability of the Switch is greatly affected by operating conditions. Evaluate the Switch under actual working conditions before permanent installation and use the Switch within a number of switching operations that will not adversely affect the Switch's performance.
- Do not use a load voltage or current that exceeds the rating. Doing so may damage or cause burning in the Switch.
- Do not use the Switch in a location with inflammable or explosive gases, or where the Switch would be subjected to inflammable solvents. The arcs and heat generated when the Switch is operated can cause ignition or explosions.
- Do not use the Switch where sulfur gas (H<sub>2</sub>S, SO<sub>2</sub>), ammonia gas (NH<sub>3</sub>), nitric acid gas (HNO<sub>3</sub>), chlorine gas (Cl<sub>2</sub>), or other harmful gases are present or where high humidity is present. Contact faults and damage due to corrosion may interfere with the functionality of the Switch.
- Do not use the Switch in oil or water or in an environment subject to constant contact with oil or water. The oil or water may enter the Switch, causing failure.
- Do not use or store the Switch in the following locations.
  - Locations subject to rapid temperature changes
  - Locations subject to condensation due to high humidity
  - Locations subject to vibration
  - Locations subject to direct sunlight
  - Locations subject to salty air
- Make sure that the rubber washer is in place between the Operation Unit and the panel. Otherwise, the specifications of the protective structure may not be satisfied.
- Do not subject the Contact Block or wiring to excessive force. The Contact Block may be damaged or deformed and faulty contact may occur.

### Precautions for Correct Use

#### Mounting

- Do not tighten the Mounting Nut more than necessary using tools such as pointed-nose pliers. Doing so will damage the Mounting Nut. (The tightening torque of the Mounting Nut is 1.0 to 2.0 N·m.)

#### Wiring

- Terminal screws must be M3.5 Phillips or slotted screws with a square washer.
- The terminal screw tightening torque is 1.0 to 1.3 N·m.
- Solid wires, stranded wires, and crimp terminals can be connected to the Switch.

Stranded wires: AWG14 to AWG16

Solid wire: 1.6 dia. max.

Bare Crimp Terminals

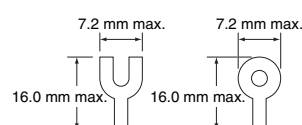

Crimp Terminals with Insulating Sheaths

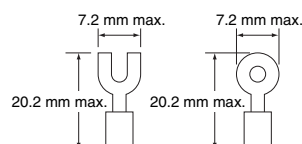

- After wiring the Switch, maintain appropriate clearance and creepage distances.

#### Operating Environment

- The Switch is intended for indoor use only. Using the Switch outdoors will result in failure.

#### LED Lamps

- A current-limiting resistor is built into the LED Lamp, so external resistance is not required.
- False Lighting of the LED Lamp  
The LED Lamp will light with a microcurrent of approx. 0.1 mA or less. Take countermeasures, such as adding a resistor in parallel to the LED Lamp, to prevent false lighting.  
The micro-current varies with the machine (due to leakage current, stray capacity between cables, etc.). Select a resistance value and allowable power consumption according to the actual current.

#### Example of Circuit to Prevent False Lighting

For 24 VAC/VDC Lighting Unit

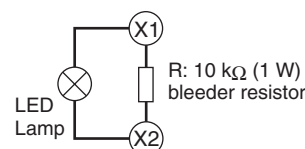

## Application

### Mounting to the Panel

#### Panel Hole Dimensions

- Panel hole dimensions are given below.
- The recommended panel thicknesses are given below.

Panel hole dimension	Panel thickness
22.3 dia.	0.8 to 5 mm
25.5 dia.	0.8 to 6 mm

- If outer surface treatment such as coating is performed for the panel, the panel dimensions after outer surface treatment must meet the specified panel dimensions.
- The following figure gives pitch dimension A and pitch dimension B between the centers of the mounting holes.

#### Panel Hole Dimensions for 22.3 Diameter

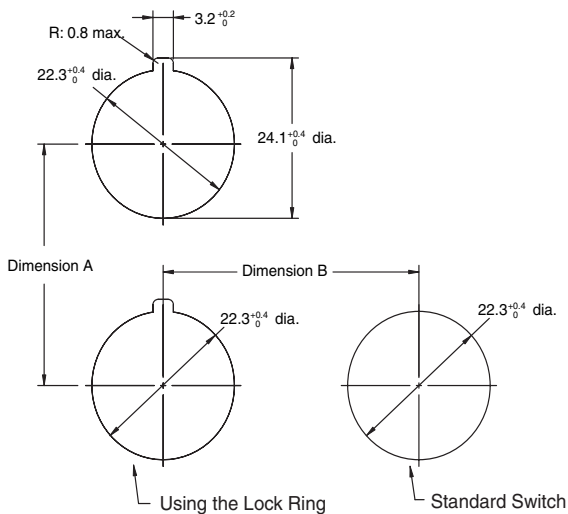

#### Panel Hole Dimensions for 25.5 Diameter

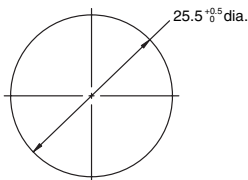

#### Dimension A

Wire type	Number of linked Contact Blocks	Number of wires per terminal	Minimum allowable pitch Dimension A (mm) or larger
Leads (twisted wires or solid wire)	1	1	50
Bare crimp terminals	1	1	50
Crimp terminals with insulating sheathes	1	1	60

**Note:** The minimum mounting pitch is based on three Contact Blocks in stage 1 with one wire attached to each terminal. If you attach two wires or link Units, determine the mounting pitch based on the dimensions diagrams and ease of operation and wiring.

#### Dimension A When Using Accessory

- Dimension A is 50 mm minimum when a Standard Legend Plate Frame is attached.
- Dimension A is 51 mm minimum when a Large Legend Plate Frame is attached.
- Dimension A is 75 mm minimum when a Protective Cover is attached.

#### Dimension B

Operation Unit shape	Dimension B
Mushroom	40 mm min.
Other than the above	30 mm min.

#### Mounting the Operation Unit

- **Panel Hole of 22.3-mm Diameter**  
Insert the Operation Unit from the front of the panel, insert the Lock Ring and Mounting Nut from the back of the panel, and tighten the Mounting Nut. Before tightening, check that the rubber washer is present between the Operation Unit and the panel.

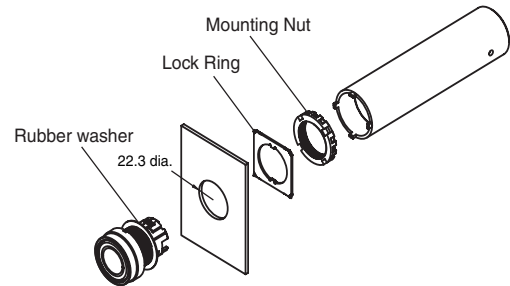

- **Panel Hole of 25.5-mm Diameter**  
Do not use the Lock Ring, and tighten the Mounting Nut while confirming that the projecting part (see following figure) on the Mounting Nut is aligned with mounting hole. Before tightening, check that the rubber washer is present between the Operation Unit and the panel.

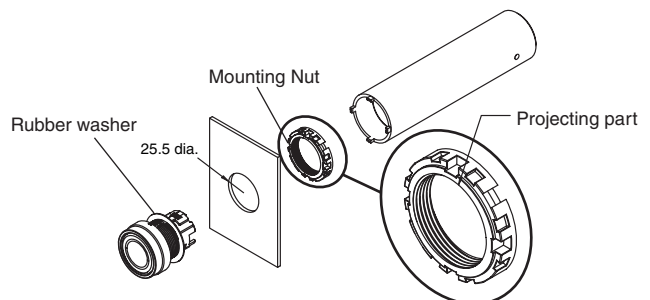

- Align the Lock Ring with the slot on the case and insert it so that the edge is flush with the panel.

#### Mounting the Contact Block to the Operation Unit

- Insert the Operation Unit into the Mounting Collar, aligning the TOP mark inscribed on the Operation Unit with the lever on the Mounting Collar, and then turn the lever in the direction indicated by the arrow in the following figure all of the way until it clicks into place.

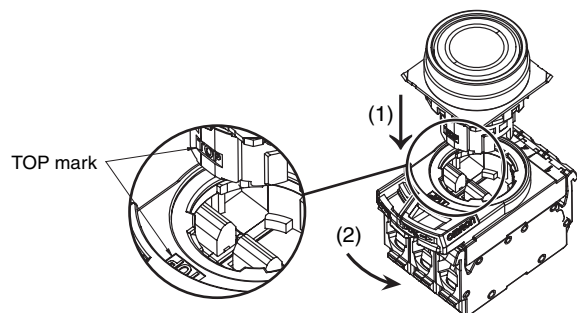

### Removing the Mounting Collar

- Press the lock lever in from the back side to release the lock, and then hook the Mounting Collar with a screwdriver, move it in the direction indicated at (2), and remove it. Turn the lever all of the way until it clicks into place.

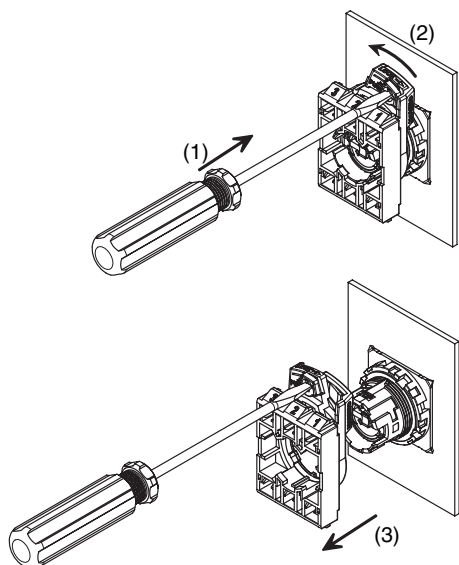

### Contact Block

#### Attaching the Contact Block

- Catch the projection on the opposite side of the Mounting Collar from the lever side and press the Contact Block in the direction indicated at (1).

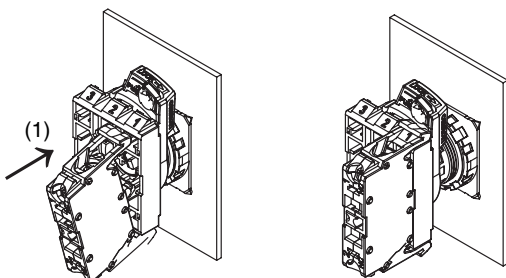

### Removing the Contact Block

- Insert a screwdriver into the gap between the Mounting Collar and Contact Block and press it inward in the direction shown at (2).

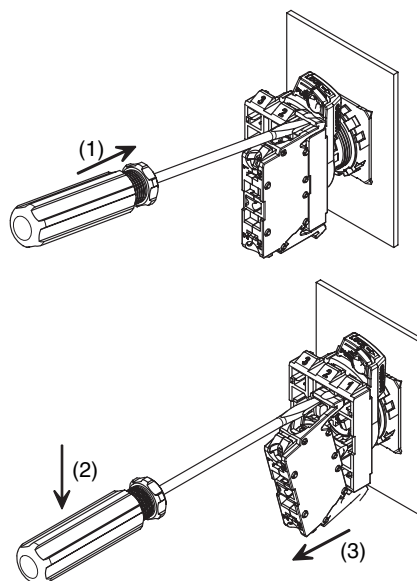

### Attaching the Reinforcement Plate

- To link Contact Blocks together, attach a Reinforcement Plate in the direction shown in the following figure. To remove the Plate, insert a screwdriver in the direction indicated at (1) and rotate it in the direction indicated at (2).

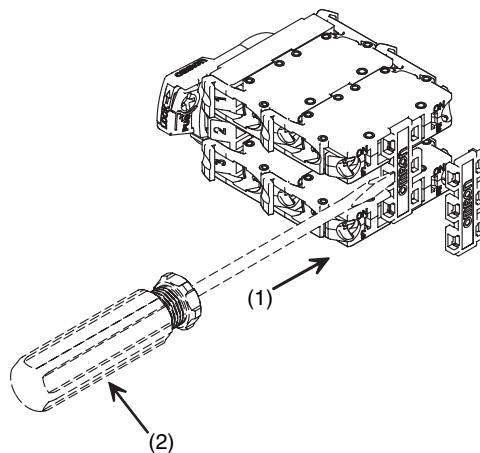

### Engraving

- Engrave legends on the Legend Plates.  
Do so with the straight part of the Legend Plate positioned on the right and left.
- The characters must be engraved no deeper than 0.5 mm. Use an alcohol-based paint, such as a melamine, phthalic acid, or acrylic resin based paint.

Projected, Full-guard, or Mushroom Switches	Flat Switches
<p>15.4 dia.</p>	<p>17.7 dia.</p>

## Attaching Character Films

- To attach a character film, remove the Button and attach the film, aligning it with the straight portions of the Legend Plate.

### Projected Switches

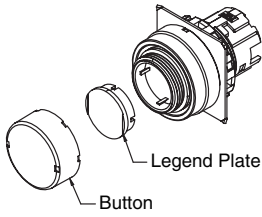

### Full-guard Switches

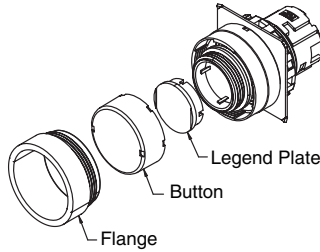

### Mushroom Switches

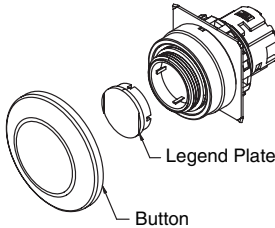

### Flat Switches

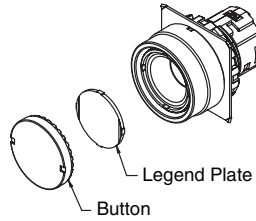

- Prepare films of the following sizes depending on the type of Legend Plate.

Projected, Full-guard, or Mushroom Switches	Legend Plate dimensions	
	Film dimensions	
Flat Switches	Legend Plate dimensions	
	Film dimensions	

## Removing and Tightening the Cap

For all Switches except for Mushroom Switches, use the A22Z-3908 Cap Tightening Tool to loosen the cap. When you tighten the cap, make sure that the Legend Plate is in the correct position and then turn the cap in the direction opposite of the direction shown in the following figure. Tighten it to a torque of 0.5 to 1.0 N·m so that it will not become loose.

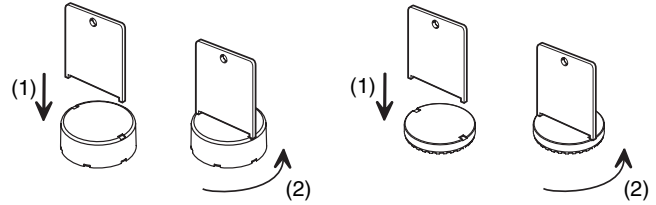

## Attaching the LED Lamp to the Lighting Unit

- Insert the protrusions on the LED Lamp into the guides on the Lighting Unit and then turn the LED Lamp in direction (2) to lock it in place.

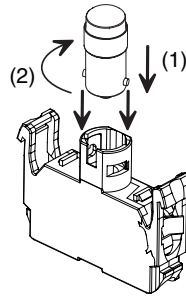

## Attaching and Replacing LED Lamps

### Removing the LED Lamp from the Panel Surface

- Insert the LED Lamp Extractor as shown in the following figure and then rotate the Extractor in the direction shown at (2) while pressing it inward.

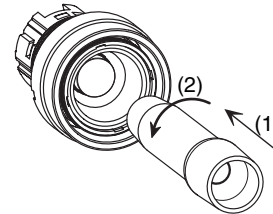

### Attaching the LED Lamp from the Panel Surface

- Insert the LED Lamp into the LED Lamp Extractor as shown in the following figure. Align the projections on the LED Lamp with the LED Lamp insertion guides, insert the LED Lamp, and turn it in the direction indicated at (2).

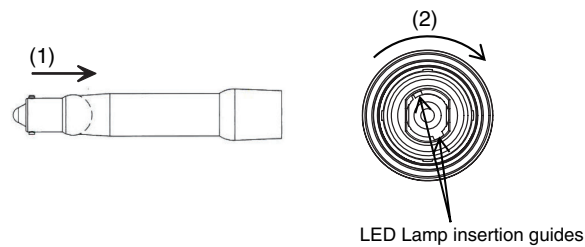

### Control Box

You can attach a Legend Plate Frame.  
 Attach it in the direction shown in the following figure.  
 Mount the Switch in the same way as for a standard panel. The tightening torque of the Box screws is 1.4 to 2.0 N·m.

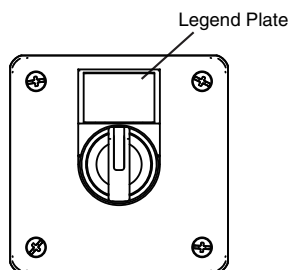

### Creating a Cable Hole

To open a cable hole, leave the cover attached, place the tip of a screwdriver in the grooves at four locations around the cable hole, and strike the screwdriver with a hammer to open the hole.

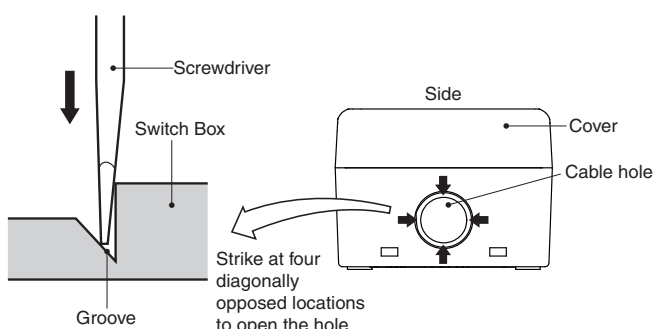

### Attaching and Removing Legend Plates

- Press the Legend Plate into the depression in the Legend Plate Frame. The Legend Plate Frame can be separate or it can be mounted on the panel when you attach the Legend Plate.
- The direction of the characters will depend on the mounting direction of the Operation Unit if the Switch is a Selector Switch or Key Selector Switch.

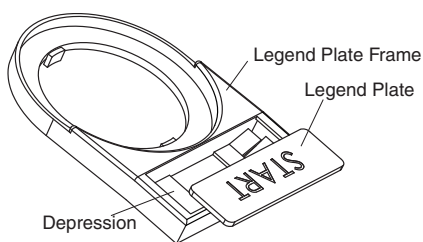

- You can easily remove the Legend Plate by pressing it forwards from the back of the Legend Plate Frame.
- The acrylic plastic Legend Plate is easily damaged by shock. Handle it with care.

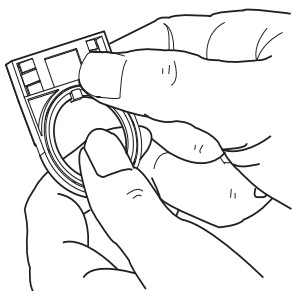

### Attaching the Lock Ring

Attach the Lock Ring as shown in the following figure.  
 To ensure water resistance, attach the rubber washer in the specified location.

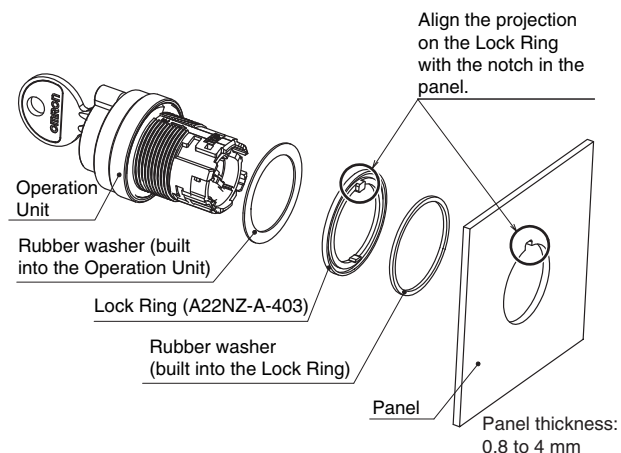

- Align the TOP mark on the Operation Unit, part A on the Legend Plate, and the notch in the panel, and insert the Operation Unit.

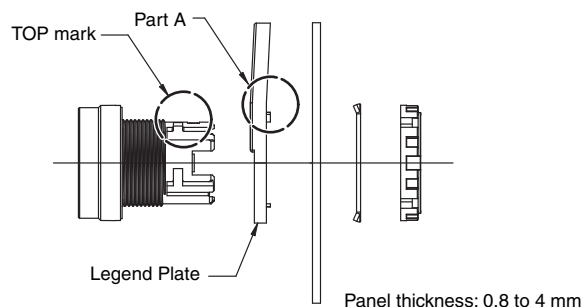

- If there is no notch in the panel, remove part A from the Legend Plate with pliers.

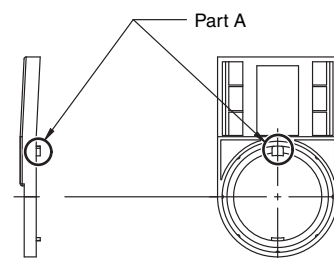

### Attaching the Protective Cover

Attach the Protective Cover (A22NZ-A-303) to a panel that is 0.8 to 1.0 mm thick. To ensure water resistance, attach the rubber washer in the specified location.

