

Across the line Contactors

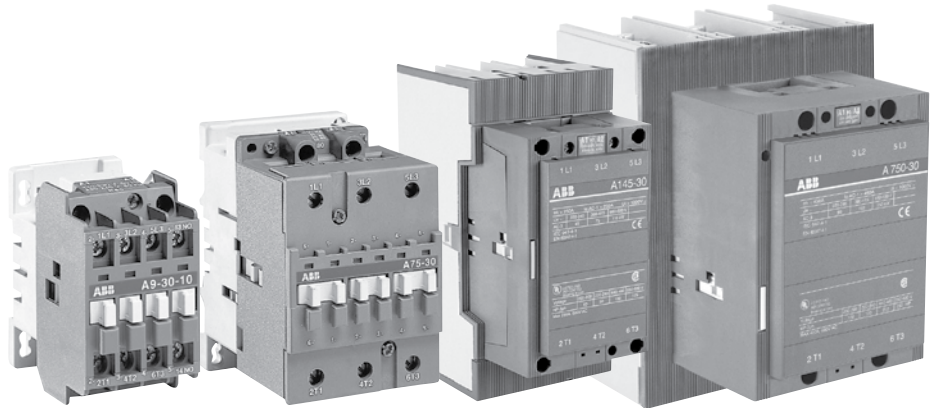

Across the line contactors A9 - AF1650

1



A9 - A110

- Maximum UL/CSA horsepower ratings according to UL508 and CSA22.2 No. 14
- Includes NEMA sizes 00 - 3
- CE mark
- Compact space saving design
- Standard auxiliary contact configurations:
 - A9 - A40 1 NO or 1 NC
 - A50 - A110 1 NO & 1 NC
- Contactor sizes A50 - A110 can be supplied without auxiliaries
- Additional auxiliary contact blocks are available
- D.C. ratings & D.C. control operation available
- Fast, snap-on DIN rail mounting
- Double break contact design
- Snap-on front mounted accessories include mechanical latch, pneumatic timer, and 1 & 4 pole auxiliary contact blocks
- Contactors ensure positive safety between their auxiliary contact blocks.
- Easy coil change
- Captive terminal screws
- NEMA, UL, IEC, CSA, VDE and most other international standards
- Touch safe design: All connection terminals are protected against accidental touch
- Terminals supplied open for ease of wiring
- Operates over an extended voltage range of 85% to 110% of rated control voltage
- Screwdriver guide holes
- UL File No: E39231 (A9 - A75); (AE9 - AE75); (AL9 - AL40); (AF50 - AF75)
- UL File No: E79416 (A95 - A110); (AE95 - AE110); (AF145 - AF750)
- CSA File No: LR56745 (A9 - A75); (AE9 - AE75); (AF50 - AF75)
- CSA File No: LR19700 (A95 - A110); (AE95 - AE110); (AF145 - AF750)
- CSA approved for elevator service

A145 - AF1650

- Maximum UL/CSA horsepower ratings according to UL508 and CSA22.2 No. 14
- Includes NEMA sizes 4 - 8
- CE mark
- 1 NO & 1 NC auxiliary contacts are standard and up to 6 additional auxiliary contacts may be added to provide a total of 8 (4 NO & 4 NC)
- Contactors ensure positive safety between their auxiliary contact blocks.
- D.C. ratings and D.C. control operation available
- Easy maintenance of main contacts and coil inspection
- Can be mounted in any position
- Terminal lugs sold separately. See page 1.25.
- Operates over an extended voltage range of 85% to 110% of rated control voltage
- NEMA, UL, IEC, CSA, VDE and most other international standards
- UL File No: E79416 (A/AF145 - AF750)
- UL File No: E73397 (AF1350 - AF1650)
- CSA File No: LR19700

General information

AE9 - AE110, DC operated

UL rated, 3 phase

Application

A-Line contactors are mainly used for controlling 3-phase motors and for controlling power circuits corresponding to their operating characteristics up to 690 and even 1000 VAC, and 440 VDC.

Control circuit types

AE types: with laminated magnetic circuit and double-winding coil fed from DC supply via a CDL5 insertion contact mounted on the device. The CDL5 has an NC lagging contact for insertion of the second winding. (See schematic.)

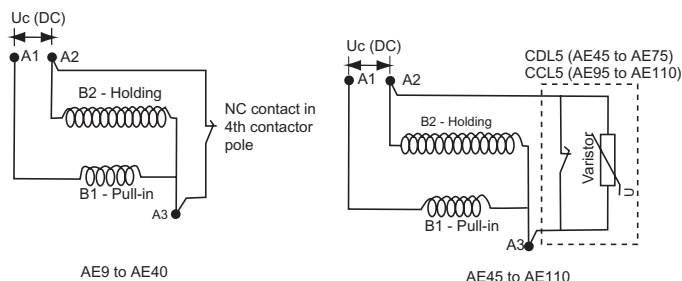

Quick mounting on DIN rail: EN 50022 and EN 50023 standards:

- 35 x 7.5mm for AE9 - AE40
- 35 x 15mm for AE9 - AE75
- 75mm for AE45 - AE110

Location of side mounted accessories: on right or left hand side. Factory mounted on left hand side for CAL5 on A50 - A300

- right hand side for CDL5/CCL5 on AE45 - AE110

Holes for screw mounting (screws not supplied). Distance between holes according to EN 50003.

Terminals delivered in open position with captive screws (unused terminal screws must be tightened).

Screwdriver guidance for all terminals makes it possible to use motorized screwdrivers.

All terminals provide protection against accidental direct contact with live parts according to VDE0106 - Part. 100.

All AE9 - AE40 contactor terminals as well as AE45 - AE110 contactor auxiliary contact and coil terminals ensure IP20 degree of protection according to IEC 947-1.

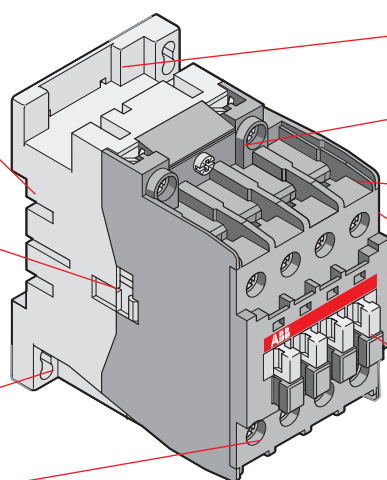

AE9 - AE110

Location of surge suppressors.

Clear marking of coil voltages and frequencies.

Connecting point for control leads in top part of main terminals of AE50 - AE75 contactors. For AE95 & AE110 contactors these are additional power connections.

Terminal marking according to IEC 947-4-1, EN 50005, EN 50012 and NEMA standards.

Location of function marker.

Stops for attaching front mounted accessories.

Terminal screws:

- Posidrive (+, -) No° 2 for all AE9 - AE75
- M8 hex threaded socket screw for AE95 & AE110

Catalog number explanation

AE9-30-00-81

Frame size

Power pole

- 30 = 3 NO
- 40 = 4 NO
- 22 = 2 NO & 2 NC

Coil voltage

(see coil voltage selection chart)

Auxiliary contacts

- 00 = No auxiliary provided
- 11 = 1 NO & 1 NC

Coil voltage selection chart

Hz	Contr. type	Volts							
		12	24	48	110	125	220	240	
DC	AE	80	81	83	86	87	88	89	

For other voltages, see page 1.26.

AE9 - AE110

Non-reversing, mechanically interlocked, reversing
DC operated, UL rated, 3 phase

Across the line
1
contactors



AE26-30-11-81

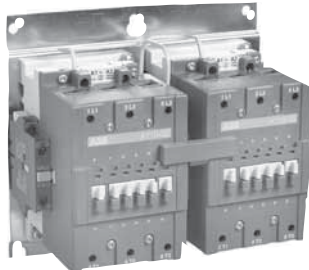

AE110M-30-11-81

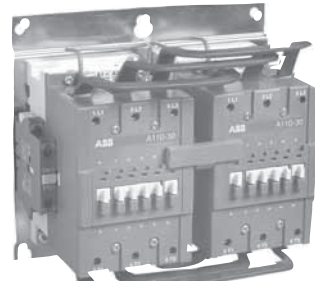

AE110R-30-11-81

General purpose current	UL motor switching current	Maximum motor horsepower ratings				Standard Aux. contacts		Non-reversing		Mechanically interlocked		Reversing	
		208V	240V	480V	575/600V	NO	NC	Catalog number	List price	Catalog number	List price	Catalog number	List price
AC1		UL rated											
21	9	2	2	5	7.5	1	1	AE9-30-11-81	\$ 118	AE9M-30-11-81	\$ 335	AE9R-30-11-81	\$ 395
25	11	3	3	7.5	10	1	1	AE12-30-11-81	124	AE12M-30-11-81	395	AE12R-30-11-81	455
30	17	5	5	10	15	1	1	AE16-30-11-81	142	AE16M-30-11-81	425	AE16R-30-11-81	493
40	28	7.5	10	20	25	1	1	AE26-30-11-81	223	AE26M-30-11-81	485	AE26R-30-11-81	560
50	34	10	10	25	30	1	1	AE30-30-11-81	292	AE30M-30-11-81	628	AE30R-30-11-81	703
60	42	10	15	30	40	1	1	AE40-30-11-81	337	AE40M-30-11-81	720	AE40R-30-11-81	830
80	54	15	20	40	50	1	1	AE50-30-11-81	375	AE50M-30-11-81	803	AE50R-30-11-81	930
90	65	20	25	50	60	1	1	AE63-30-11-81	477	AE63M-30-11-81	1080	AE63R-30-11-81	1208
105	80	25	30	60	75	1	1	AE75-30-11-81	518	AE75M-30-11-81	1365	AE75R-30-11-81	1493
125	95	30	30	60	75	1	1	AE95-30-11-81	555	AE95M-30-11-81	1440	AE95R-30-11-81	1635
140	110	30	40	75	100	1	1	AE110-30-11-81	690	AE110M-30-11-81	1785	AE110R-30-11-81	2048
230	130	40	50	100	125	1	1						
250	156	50	60	125	150	1	1						
300	192	60	75	150	200	1	1						
350	248	75	100	200	250	1	1						
400	302	100	100	250	300	1	1						
550	414	125	150	350	400	1	1						
650	480	150	200	400	500	1	1						
750	602	200	250	500	600	1	1						
900	810	250	300	600	700	1	1						
1350	960	—	400	800	900	1	1						
1650	1080	—	450	900	1000	1	1						

See AF contactors, page 1.9

Coil voltage selection

All DC operated catalog numbers include a 24VDC coil. To select other coil voltages, substitute the code from the Coil Voltage Selection Chart for the two digits after the last dash in the catalog number.

Ex.: A 110V coil is required for an AE75 contactor: AE75-30-11-86

Auxiliary contact blocks

For additional auxiliary contact blocks, see catalog number explanation on page 1.4. Add \$ 20 to list price for each additional auxiliary, and see page 1.18 for available combinations.

Mechanical interlock

Mechanically interlocked contactors are designed for reversing, 2 speed, reduced voltage, etc. type starter applications. The complete assembly consists of two mechanically and electrically interlocked contactors mounted as follows with line and load terminals:

- AE9 - AE16 — mounted on 35mm DIN rail
- AE26 - AE110 — mounted on common baseplate

Power wiring is not included.

The NC electrical interlock is provided with the mechanical interlock.

Coil voltage selection chart

Hz	Contr. type	Volts						
		12	24	48	110	125	220	240
DC	AE	80	81	83	86	87	88	89

For other voltages, see page 1.26.

Reversing

Reversing contactors are designed for reversing type starter applications. The complete assembly consists of two mechanically and electrically interlocked contactors mounted as follows with line and load terminals:

- AE9 - AE16 — mounted on 35mm DIN rail
- AE26 - AE110 — mounted on common baseplate

The NC electrical interlock is provided with the mechanical interlock.

Contactors for ring tongue termination

A/AE9 - A/AE110, AC & DC operated

UL rated, 3 phase

UL general purpose current AC1	UL Motor switching current	UL/CSA horsepower ratings			Auxiliary contacts		AC operated		DC operated	
		240V	480V	575/600V	NO	NC	Catalog number	List price	Catalog number	List price
21	9	2	5	7.5	1 0	0 1	A93010RT-84 A93001RT-84	\$ 81	AE93000RT-81 —	\$ 91 —
25	11	3	7.5	10	1 0	0 1	A123010RT-84 A123001RT-84	87	AE123000RT-81 —	97 —
30	17	5	10	15	1 0	0 1	A163010RT-84 A163001RT-84	106	AE163000RT-81 —	116 —
40	28	10	20	25	1 0	0 1	A263010RT-84 A263001RT-84	189	AE263000RT-81 —	199 —
80	54	20	40	50	0	0	A503000RT-84	311	AE503000RT-81	356
90	65	25	50	60	0	0	A633000RT-84	354	AE633000RT-81	459
105	80	30	60	75	0	0	A753000RT-84	396	AE753000RT-81	501
125	95	30	60	75	0	0	A953000RT-84	466	AE953000RT-81	571
140	110	40	75	100	0	0	A1103000RT-84	543	AE1103000RT-81	753

Coil voltage selection – AC coils

All AC operated catalog numbers include a 120VAC coil. To select other coil voltages, substitute the code from the AC coils Coil Voltage Selection Chart for the two digits after the last dash in the catalog number.

Ex.: A 240V coil is required for an A75 contactor: A753000RT-80

Coil voltage selection – DC coils

All DC operated catalog numbers include a 24VDC coil. To select other coil voltages, substitute the code from the DC coils Coil Voltage Selection Chart for the two digits after the last dash in the catalog number.

Ex.: A 110V coil is required for an AE75 contactor: AE753000RT-86

Auxiliary contact blocks

For additional auxiliary contact blocks, see catalog number explanation on page 1.2. Add \$ 20 to list price for each additional auxiliary, and see page 1.18 for available combinations. Only side-mounted blocks are allowed to be factory installed.

Auxiliary contact block with ring tongue termination

Positioning	Maximum number of contact blocks	Contact description	Catalog number	List price
Front mounting (C4-pole)	1 block A/AE9 – A/AE110	2 NO & 2 NC 3 NO & 1 NC 4 NO	CA5-22ERT CA5-31ERT CA5-40ERT	\$ 35

Coil voltage selection chart – AC coils

Hz	Cntr type	Volts															
		12	24	48	110	120	125	208	220	240	277	380	415	440	480	500	600
60	A		81	83	84	84		34	36	80	42		86	86	51	53	55
50	A		81	83	84				80				85	86			55

For other voltages, see page 1.26.

Coil voltage selection chart – DC coils

Hz	Contr. type	Volts					
		24	48	110	125	220	240
DC	AE	81	83	86	87	88	89

For other voltages, see page 1.26.

AE9 – AF1650, AL9 – AL26

Non-reversing, mechanically interlocked, reversing
NEMA rated, DC operated, 3 phase



AE26N1-30-11-81



AF145N4-30-11-68



AF460N6R-11-68

AE & AF Contactors

NEMA size	Continuous current	Maximum motor horsepower ratings			Standard Aux. contacts		Non-reversing		Mechanically interlocked		Reversing	
		200V	230V	460/575V	NO	NC	Catalog number	List price	Catalog number	List price	Catalog number	List price
NEMA rated												
00	9	1.5	1.5	2	1	0	AE9N00-30-11-81	\$ 118	AE9N00M-11-81	\$ 335	AE9N00R-11-81	\$ 395
0	18	3	3	5	1	0	AE16N0-30-11-81	142	AE16N0M-11-81	425	AE16N0R-11-81	493
1	27	7.5	7.5	10	1	0	AE26N1-30-11-81	223	AE26N1M-11-81	485	AE26N1R-11-81	560
2	45	10	15	25	1	1	AE50N2-30-11-81	375	AE50N2M-11-81	803	AE50N2R-11-81	930
3	90	25	30	50	1	1	AE75N3-30-11-81	518	AE75N3M-11-81	1365	AE75N3R-11-81	1493
4	135	40	50	100	1	1	AF145N4-3011-70	1110	AF145N4M-11-70	2655	AF145N4R-11-70	2670
5	270	75	100	200	1	1	AF260N5-3011-70	2235	AF260N5M-11-70	5055	AF260N5R-11-70	5070
6	540	150	200	400	1	1	AF460N6-3011-70	4425	AF460N6M-11-70	13,275	AF460N6R-11-70	13,290
7	810	—	300	600	1	1	AF750N7-3011-70	7200	AF750N7M-11-70	19,725	AF750N7R-11-70	19,740
8	1215	—	450	900	1	1	AF1650N83011-70	10,230	—	—	—	—

AL Contactors

NEMA size	Continuous current	Maximum motor horsepower ratings			Standard Aux. contacts		Non-reversing		Mechanically interlocked		Reversing	
		208V	240V	460/575V	NO	NC	Catalog number	List price	Catalog number	List price	Catalog number	List price
NEMA rated												
00	9	1.5	1.5	2	1	0	AL9N00-30-10-81	\$ 110	AL9N00M-10-81	\$ 319	AL9N00R-10-81	\$ 379
0	18	3	3	5	1	0	AL16N0-30-10-81	150	AL16N0M-10-81	441	AL16N0R-10-81	501
1	27	7.5	7.5	10	1	0	AL26N1-30-10-81	190	AL26N1M-10-81	473	AL26N1R-10-81	533

Coil voltage selection – AE contactors

All DC operated catalog numbers include a 24VDC coil. To select other coil voltages, substitute the code from the Coil Voltage Selection Chart for the two digits after the last dash in the catalog number.

Ex.: A 125V coil is required for an AE75 contactor: AE75N3-30-11-87

Coil voltage selection – AF wide range AC/DC coils

All catalog numbers include a 100-250V AC/DC coil. To select other coil voltages, substitute the code from the Coil Voltage Selection Chart for the two digits after the last dash in the catalog number.

Ex.: A 24V coil is required for a AF145 contactor: AF145N4-30-11-72

Auxiliary contact blocks

For additional auxiliary contact blocks, see catalog number explanation on page 1.2. Add \$ 20 to list price for each additional auxiliary, and see page 1.18 for available combinations.

Mechanical interlock

Mechanically interlocked contactors are designed for reversing, 2 speed, reduced voltage, etc. type starter applications. The complete assembly consists of two mechanically and electrically interlocked contactors mounted as follows with line and load terminals:

- AE9 - AE16 — mounted on 35mm DIN rail
- AE26 - AE75 — mounted on common baseplate

Power wiring is not included.

For AE9 - AE75 contactors the NC electrical interlock is provided with the mechanical interlock.

① AF400 – AF750, DC only.
② AF50 – AF300, DC only.

③ AF400 - AF750 only.
④ Only option for AF1650.

Reversing

Reversing contactors are designed for reversing type starter applications. The complete assembly consists of two mechanically and electrically interlocked contactors mounted as follows with line and load terminals:

- AE9 - AE16 — mounted on 35mm DIN rail
- AE26 - AE75 — mounted on common baseplate

For AE9 - AE75 contactors the NC electrical interlock is provided with the mechanical interlock.

Coil voltage selection – AF50 to AF1650

AC/DC VOLTS, 40 - 60 Hz				
24 - 60 DC	20 - 60 DC	48 - 130 AC/DC	100 - 250 AC/DC	250 - 500 AC/DC
68 ①	72 ②	69	70 ④	71 ③

Coil voltage selection – AE & AL contactors

Hz	Contactor type	Volts						
		12	24	48	110	125	220	240
DC	AE, AL	—	81	83	86	87	88	89

A9 – A/AE75 , EK110 – EK1000, AL9 – AL26

AC & DC operated

UL rated, 4 pole

Across the line
1



A9-40-00

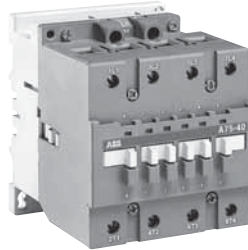

A75-40-00

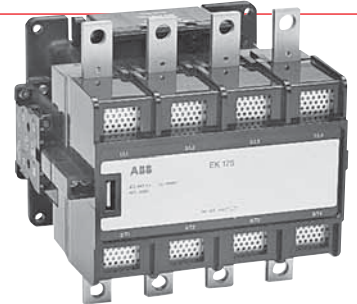

EK175C4P-PL

4 Pole – 4 NO power poles

UL general purpose current		AC operated		DC operated	
AC operated	DC operated	Catalog number	List price	Catalog number	List price
21	21	A9-40-00-84	\$ 120	AL9-40-00-81	\$ 133
30	30	A16-40-00-84	165	AL16-40-00-81	172
40	40	A26-40-00-84	228	AL26-40-00-81	224
65	65	A45-40-00-84	360	AE45-40-00-86	420
80	80	A50-40-00-84	413	AE50-40-00-86	473
105	105	A75-40-00-84	525	AE75-40-00-86	570
150	150	EK110C4P-1L	743	EK110C4P-PL	953
200	200	EK150C4P-1L	1013	EK150C4P-PL	1238
250	250	EK175C4P-1L	1763	EK175C4P-PL	1988
300	300	EK210C4P-1L	2025	EK210C4P-PL	2280
400	400	EK370C4P-1L	4650	EK370C4P-PL	5010
600	600	EK550C4P-1L	6510	EK550C4P-PL	7005
1000 ①	1000 ①	EK1000C4P-1L	9000	EK1000C4P-PL	9700

4 Pole – 4 NC power poles

UL general purpose current	AC operated	List price
AC operated	Catalog number	
30	A16-04-00-84	\$ 165

4 Pole – 2 NO & 2 NC power poles

UL general purpose current		AC operated		DC operated	
AC operated	DC operated	Catalog number	List price	Catalog number	List price
21	21	A9-22-00-84	\$ 120	AL9-22-00-81	\$ 133
30	21	A16-22-00-84	165	AL16-22-00-81	172
40	30	A26-22-00-84	228	AL26-22-00-81	224
65	65	A45-22-00-84	360	AE45-22-00-86	420
105	105	A75-22-00-84	525	AE75-22-00-86	570

Coil voltage selection

All AC operated catalog numbers include a 120VAC coil. All DC operated catalog numbers include a 110VDC coil. To select other coil voltages, substitute the code from the Coil Voltage Selection Chart for the two digits after the last dash in the catalog number.

Ex.: A 240V coil is required for an A75 contactor: A75-30-00-80

Auxiliary contact blocks

For additional auxiliary contact blocks, see catalog number explanation on page 1.2. Add \$ 20 to list price for each additional auxiliary, and see page 1.18 for available combinations.

Accessories for EK

Please consult factory.

Coil voltage selection – A contactors

Hz	Cntr type	Volts															
		12	24	48	110	120	125	208	220	240	277	380	415	440	480	500	600
60	A	81	83	84	84		34	36	80	42		86	86	51	53	55	
50	A	81	83	84				80				85	86			55	

For other voltages, see page 1.26.

Coil voltage selection – EK contactors

Hz	Contr. type	Volts														
		24	48	110	120	125	208	220	240	277	380	415	440	480	500	600
60	EK	F	G		1		B		2	C	Z		3	4		6
50	EK	N		1			J				3	M			5	
DC	EK	Y	W	P		Q		R					T			

- For other voltages, consult factory.
- 24 & 48VAC coils are not available for sizes EK550. For these applications, use an interposing control relay.

Coil voltage selection – AE & AL contactors

Hz	Contr. type	Volts						
		12	24	48	110	125	220	240
DC	AE, AL	-	81	83	86	87	88	89

For other voltages, see page 1.26.

① Not UL Listed. IEC value AC1 for 40°C.