

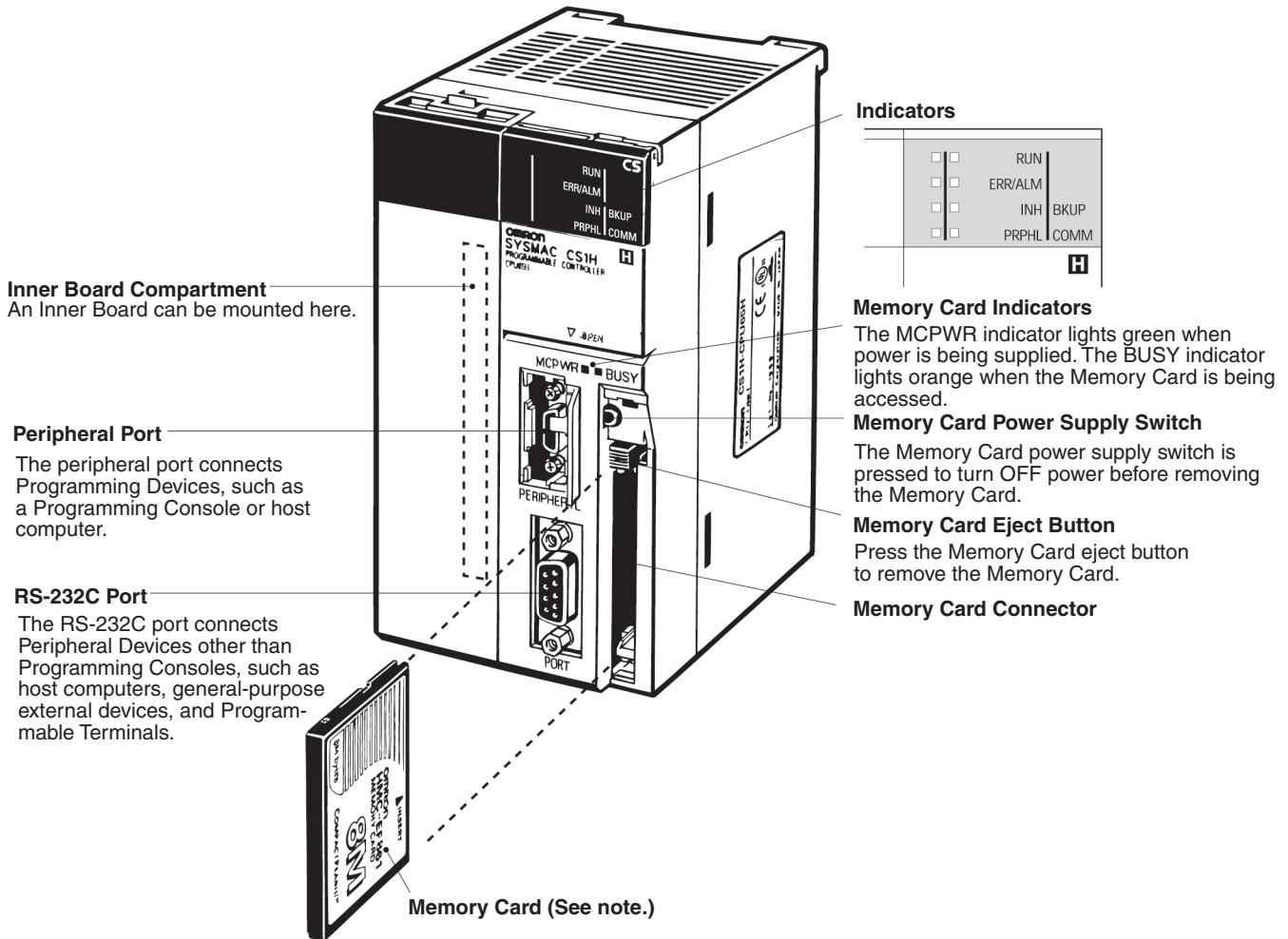

CS1H/G-CPU□□H

CS1-series

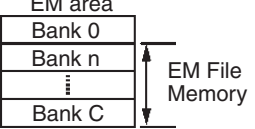

With the CS1 PLCs, Memory Cards and specified ranges of the EM Area can be used as file memory. File memory can be used to store the entire user program, I/O memory contents, and/or parameter area contents.

File memory	Memory type	Capacity	Model
	Flash memory	30 MB	HMC-EF372
		64 MB	HMC-EF672
EM File Memory 	RAM	EM Area capacity of CPU Unit (Max. capacity for CS1H-CPU67: 832 KB).	From the specified bank in the EM area of I/O memory to the last bank (specified in PC Setup).

Note: Memory Card Adapter: HMC-AP001 (The Memory Card Adapter can be used to mount Memory Cards in PC card slots to use the Cards on a personal computer.)

Specifications

CPU Units

Model	I/O bits	Program capacity	Data memory capacity (See Note.)	LD instruction processing speed	Built-in ports	Options
CS1H-CPU67H CS1D-CPU67H CS1D-CPU67S CS1D-CPU67P	5,120 bits (Up to 7 Expansion Racks)	250 kSteps	448 kWords	0.02 μs	Peripheral port and RS-232C port.	Memory Cards Inner Board such as Serial Communications Board, Loop Control Board (See note 1.)
CS1H-CPU66H		120 kSteps	256 kWords			
CS1H-CPU65H CS1D-CPU65H CS1D-CPU65S CS1D-CPU65P		60 kSteps	128 kWords			
CS1H-CPU64H		30 kSteps	64 kWords			
CS1H-CPU63H		20 kSteps				
CS1G-CPU45H		5,120 bits (Up to 7 Expansion Racks)	60 kSteps			
CS1G-CPU44H CS1D-CPU44S	1,280 bits (Up to 3 Expansion Racks)	30 kSteps	64 kWords			
CS1G-CPU43H	960 bits	20 kSteps				
CS1G-CPU42H CS1D-CPU42S	(Up to 2 Expansion Racks)	10 kSteps				

Note: The available data memory capacity is the sum of the Data Memory (DM) and the Extended Data Memory (EM).

Note: 1. A Loop Control Board cannot be mounted in CS1D-CPU□□D, use CS1D-CPU□□P instead.
A Serial communications Board cannot be mounted in CS1D-CPU□□P.

Common Specifications

Item	Specification	
Control method	Stored program	
I/O control method	Cyclic scan and immediate processing	
Programming	Ladder diagram	
Instruction length	1 to 7 steps per instruction	
Ladder instructions	Approx. 400 (3-digit function codes)	
Execution time	Basic instructions: 0.02 μs min., Special instructions: 0.04 μs min.	
Function Blocks (CPU Ver. 3.0 or higher)	Languages supported for use in function block programming: Ladder program language and IEC 61131-3 Structured Text.	
Number of tasks	288 (256 of which are also used as interrupt tasks) Cyclic tasks are executed each cycle and are controlled with TKON(820) and TKOF(821) instructions. The following 4 types of interrupt tasks are supported: Power OFF tasks:1 max., Scheduled interrupt tasks: 2 max., I/O interrupt tasks: 32 max., External interrupt tasks: 256 max.	
Interrupt types (not applicable for CS1D CPUs)	Scheduled Interrupts:Interrupts generated at a time scheduled by CPU Unit's built-in timer. I/O Interrupts:Interrupts from Interrupt Input Units. Power OFF Interrupts:Interrupts executed when CPU Unit's power is turned OFF. External I/O Interrupts:Interrupts from Special I/O Units, CS1 Special Units, or Inner Board.	
CIO (Core I/O) Area (The CIO Area can be used as work bits if not used as shown here.)	I/O Area	5,120: CIO 000000 to CIO 031915 (320 words from CIO 0000 to CIO 0319) Setting of first rack words can be changed from default (CIO 0000) so that CIO 0000 to CIO 0999 can be used. I/O bits are allocated to Basic I/O Units, such as CS1 Basic I/O Units, C200H Basic I/O Units, and C200H Group-2 High-density I/O Units.
	Link Area	3,200 (200 words): CIO 10000 to CIO 119915 (words CIO 1000 to CIO 1199) Link bits are used for data links and are allocated to Units in Controller Link Systems and PC Link Systems.
	CS1 CPU Bus Unit Area	6,400 (400 words): CIO 150000 to CIO 189915 (words CIO 1500 to CIO 1899) CS1 CPU Bus Unit bits store operating status of CS1 CPU Bus Units. (25 words per Unit, 16 Units max.)
	Special I/O Unit Area	15,360 (960 words): CIO 200000 to CIO 295915 (words CIO 2000 to CIO 2959) Special I/O Unit bits are allocated to CS1 Special I/O Units and C200H Special I/O Units. (See Note.) (10 words per Unit, 96 Units max.) The maximum number of slots, however, is limited to 80 including expansion slots, so maximum number of Units is actually 80. Note: Some I/O Units are classified as Special I/O Units.
	Inner Board Area	1,600 (100 words): CIO 190000 to CIO 199915 (words CIO 1900 to CIO 1999) Inner Board bits are allocated to Inner Boards. (100 I/O words max.)
	SYSMAC BUS Area	800 (50 words): CIO 300000 to CIO 304915 (words CIO 3000 to CIO 3049) SYSMAC BUS bits are allocated to Slave Racks connected to SYSMAC BUS Remote I/O Master Units. (10 words per Rack, 5 Racks max.)

Note: A max. of 10 or 16 C200H Special I/O Units can be used depending on the CPU Unit. Some I/O Units are Special I/O Units.

Item		Specification
CIO (Core I/O) Area, contd. (The CIO Area can be used as work bits if not used as shown here.)	I/O Terminal Area	512 (32 words): CIO 310000 to CIO 313115 (words CIO 3100 to CIO 3131) I/O Terminal bits are allocated to I/O Terminal Units (but not to Slave Racks) connected to SYSMAC BUS Remote I/O Master Units. (1 word per Terminal, 32 Terminals max.)
	C200H Special I/O Unit Area	8,196 (512 words): CIO 000000 to CIO 051115 (words CIO 0000 to CIO 0511) C200H Special I/O Unit bits are allocated to C200H Special I/O Units and allow access separate from I/O refreshing.
	DeviceNet/PROFIBUS-DP Area	1,600 (100 words): Outputs: CIO 005000 to CIO 009915 (words CIO 0050 to CIO 0099) Inputs: CIO 035000 to CIO 039915 (words CIO 0350 to CIO 0399) DeviceNet bits are allocated to Slaves according to DeviceNet remote I/O communications.
	PC Link Area	64 bits (4 words): CIO 027400 to CIO 025015 (words CIO 0247 to CIO 0250) When a PC Link Unit is used in a PC Link, use these bits to monitor PC Link errors and operating status of other CPU Units in PC Link.
Internal I/O Area		4,800 (300 words): CIO 120000 to CIO 149915 (words CIO 1200 to CIO 1499) 37,504 (2,344 words): CIO 380000 to CIO 614315 (words CIO 3800 to CIO 6143) These bits in CIO Area are used as work bits in programming to control program execution. They cannot be used for external I/O.
Work Area		8,192 bits (512 words): W00000 to W51115 (words W000 to W511) Control programs only. (I/O from external I/O terminals is not possible.) Note: When using work bits in programming, use bits in Work Area first before using bits from other areas.
Holding Area		8,192 bits (512 words): H00000 to H51115 (words H000 to H511) Holding bits are used to control execution of program, and maintain their ON/OFF status when PLC is turned OFF or operating mode is changed. Part of the Holding area is used for allocation of Function Block variables in CPU Ver. 3.0 and higher.
Auxiliary Area		Read only: 7,168 bits (448 words): A00000 to A44715 (words A000 to A447) Read/write: 8,192 bits (512 words): A44800 to A95915 (words A448 to A959) Auxiliary bits are allocated specific functions.
Temporary Area		16 bits (TR00 to TR15) Temporary bits are used to store ON/OFF execution conditions at program branches.
Timer Area		4,096: T0000 to T4095 (used for timers only)
Counter Area		4,096: C0000 to C4095 (used for counters only)
DM Area		32 kWords: D00000 to D32767 Used as a general-purpose data area for reading and writing data in word units (16 bits). Words in DM Area maintain their status when PLC is turned OFF or operating mode is changed. Internal Special I/O Unit DM Area: D20000 to D29599 (100 words × 96 Units). Used to set parameters. CS1 CPU Bus Unit DM Area: D30000 to D31599 (100 words × 16 Units). Used to set parameters. Inner Board DM Area: D32000 to D32099. Used to set parameters for Inner Boards.
EM Area		32 kWords per bank, 13 banks max.: E0_00000 to EC_32767 max. (Not available on some CPU Units.) Used as a general-purpose data area for reading and writing data in word units (16 bits). Words in EM Area maintain their status when PLC is turned OFF or operating mode is changed. The EM Area is divided into banks, and addresses can be set by either of following methods. Changing current bank using EMBC(281) instruction and setting addresses for current bank. Setting bank numbers and addresses directly. EM data can be stored in files by specifying number of first bank. (EM file memory)
Data Registers		DR0 to DR15. Store offset values for indirect addressing. Data registers can be used independently in each task. One register is 16 bits (1 word).
Index Registers		IR0 to IR15. Store PLC memory addresses for indirect addressing. Index registers can be used independently in each task. One register is 32 bits (2 words).
Task Flag Area		32 (TK0000 to TK0031). Task Flags are read-only flags that are ON when corresponding cyclic task is executable and OFF when corresponding task is not executable or in standby status.
Trace Memory		4,000 words (500 data trace samples at the maximum sample size of 31 bits and 6 words)
File Memory		Memory Cards: Compact flash memory cards can be used (MS-DOS format). EM file memory: Part of EM Area can be converted to file memory (MS-DOS format). CompactFlash Memory Cards with 15-MB, 30-MB, or 64-MB capacities can be used.

Function Specifications

Item	Specification
Parallel Processing Mode	The program can be executed simultaneously with peripheral servicing (CS1G/CS1H only).
Battery-free operation	Flash memory is provided as a standard feature and automatically backs up the user program and system parameters.
Constant cycle time	1 to 32,000 ms (Unit: 1 ms)
Cycle time monitoring	Possible (Unit stops operating if cycle is too long): 1 to 40,000 ms (Unit: 10 ms)
I/O refreshing	Cyclic refreshing, immediate refreshing, refreshing by IORF(097).
I/O memory holding when changing operating modes	Possible (Depends on ON/OFF status of IOM Hold Bit in Auxiliary Area.)
Load OFF	All outputs on Output Units can be turned OFF.
Input time constant setting	Time constants can be set for inputs from CS1 Basic I/O Units. The time constant can be increased to reduce influence of noise and chattering or it can be decreased to detect shorter pulses on inputs. (CS1 Basic I/O Units only)
Mode setting at power-up	Possible
Memory Card functions	Automatic reading programs from Memory Card (autoboot). Memory Card Storage Data User program: Program file format (binary) PC System Setup: Data file format (binary) I/O Memory: Data file format (binary), text format, CSV format Memory Card Read/Write User program instructions, Peripheral Devices (such as Programming Console), Host Link computer.
Filing	Memory Card data and EM (Extended Data Memory) Area can be handled as files.
Debugging	Force-set/reset, differential monitoring, data tracing (scheduled, each cycle, or when instruction is executed), instruction error tracing.
Online editing	One or more program blocks in user programs can be overwritten when CPU Unit is in PROGRAM or MONITOR mode. This function is not available for block programming areas.
Program protection	Overwrite protection: Set using DIP switch. Copy protection: Password set using Peripheral Device.
Error check	User-defined errors (i.e., user can define fatal errors and non-fatal errors) The FPD(269) instruction can be used to check execution time and logic of each programming block.
Error log	Up to 20 errors are stored in error log. Information includes error code, error details, and time error occurred.
Serial communications	Built-in peripheral port: Peripheral Device (including Programming Console), Host Links, NT Links Built-in RS-232C port: Peripheral Device (excluding Programming Console), Host Links, no-protocol communications, NT Links Communications Board (sold separately): Protocol macros, Host Links, NT Links
Clock	Provided on all models. Note: Used to store time when power is turned ON and when errors occur.
Power OFF detection time	10 to 25 ms (not fixed)
Power OFF detection delay time	0 to 10 ms (user-defined, default: 0 ms)
Memory protection	Held Areas: Holding bits, contents of Data Memory and Extended Data Memory, and status of counter Completion Flags and present values. Note: If IOM Hold Bit in Auxiliary Area is turned ON, and PC Setup is set to maintain IOM Hold Bit status when power to PLC is turned ON, contents of CIO Area, Work Area, part of Auxiliary Area, timer Completion Flag and PVs, Index Registers, and Data Registers will be saved.
Sending commands to a Host Link computer	FINS commands can be sent to a computer connected via Host Link System by executing Network Communications Instructions from PLC.
Remote programming and monitoring	Host Link communications can be used for remote programming and remote monitoring through a Controller Link System or Ethernet network.
Eight-level communications (CPU Ver. 3.0 and higher)	Host Link communications can be used for remote programming and remote monitoring from devices on networks up to seven levels away (Controller Link Network, Ethernet Network, or other network).
Storing comments in CPU Unit	I/O comments can be stored in CPU Unit in Memory Cards, EM file memory, or the built-in Comment memory (CPU Ver. 3.0 and higher)
Program check	Program checks are performed at beginning of operation for items such as no END instruction and instruction errors. A Peripheral Device (excluding Programming Console) can also be used to check programs.
Control output signals	RUN output: The contacts will turn ON (close) while CPU Unit is operating. These terminals are provided only on C200HW-PA204R and C200HW-PA209R Power Supply Units.
Battery life	5 years at 25° C (Depending on the ambient operating temperature and communications conditions, 1.1 years min. Battery Set: CS1W-BAT01) Note: Use a replacement battery that is no more than 2 years old from the date of manufacture.
Self-diagnostics	CPU errors (watchdog timer), I/O verification errors, I/O bus errors, memory errors, and battery errors.
Other functions	Storage of number of times power has been interrupted, the times of the interrupts, and system operation time (in Auxiliary Area).

Specifications - Power Supply Units

Item	Specifications					
Power Supply Unit	C200HW-PA204	C200HW-PA204S	C200HW-PA204R	C200HW-PA209R	C200HW-PD024	C200HW-PD106R
Supply voltage	100 to 120 V AC or 200 to 240 V AC, 50/60 Hz				24 V DC	100 V DC
Operating voltage range	85 to 132 V AC or 170 to 264 V AC				19.2 to 28.8 V DC	85 to 143 V DC
Power consumption	120 VA max.			180 VA max.	40 W max.	50 W max.
Inrush current	30 A max.			30 A max./100 to 120 V AC 40 A max./200 to 240 V AC	30 A max.	
Output capacity	4.6 A, 5 V DC (including CPU Unit power)			9 A, 5 V DC (including CPU Unit power)	4.6 A, 5 V DC (including CPU Unit power)	6 A, 5 V DC (including CPU Unit power)
	0.625 A, 26 V DC Total: 30 W	0.625 A, 26 V DC or 0.8 A, 24 V DC Total: 30 W	0.625 A, 24 V DC Total: 30 W	1.3 A, 26 V DC Total: 45 W	0.625 A, 26 V DC Total: 30 W	1 A, 26 V DC Total: 30 W
Output terminal	Not provided	24 V DC load current consumption Less than 0.3 A: +17%/-11% 0.3 A or greater: +10%/-11% (Lot No. 0197 or higher)	Not provided		Not provided	
RUN output (See Note 2.)	Not provided		Contact configuration: SPST-NO Switch capacity: 250 V AC, 2 A (resistive load) 250 V AC, 0.5 A (inductive load), 24 V DC, 2 A	Contact configuration: SPST-NO Switch capacity: 240 V AC, 2 A (resistive load) 120 V AC, 0.5 A (inductive load) 24 V DC, 2 A (resistive load) 24 V DC, 2 A (inductive load)	Not provided	
Insulation resistance	20 MΩ min. (at 500 V DC) between AC external and GR terminals (See Note 1.)				20 MΩ min. (at 500 V DC) between DC external and GR terminals (See Note 1.)	
Dielectric strength	2,300 V AC 50/60 Hz for 1 min between AC external and GR terminals (See Note 1.) Leakage current: 10 mA max.				1,000 V AC 50/60 Hz for 1 min between DC external and GR terminals, leakage current: 10 mA max. (See Note 1.)	
	1,000 V AC 50/60 Hz for 1 min between AC external and GR terminals (See Note 1.) Leakage current: 10 mA max.				2,300 V AC 50/60 Hz for 1 min between AC external and GR terminals (See Note 1.) Leakage current: 10 mA max.	
Noise immunity	Conforms to IEC61000-4-4, 2 kV (power lines)					
Vibration resistance	10 to 57 Hz, 0.075-mm amplitude, 57 to 150 Hz, acceleration: 9.8 m/s ² in X, Y, and Z directions for 80 minutes (Sweep time 8 min × 10 = total time 80 min.) CPU Unit mounted to a DIN rail: 2 to 55 Hz, 2.9 m/s ² in X, Y, and Z directions for 20 minutes. According to JIS C0040 / IEC 60068-2-6					
Shock resistance	147 m/s ² , 3 times each in X, Y, and Z directions According to JIS C0041 / IEC 60068-2-27					
Ambient operating temperature	0 to 55°C					
Ambient operating humidity	10% to 90% (with no condensation)					
Atmosphere	Must be free from corrosive gases.					
Ambient storage temperature	-20 to 75°C (excluding battery)					
Grounding	Less than 100 Ω					
Enclosure	IP20, intended for panel mounting.					
Weight	All models are each 6 kg max.					
CPU Rack Dimensions (mm) (See note 3.)	2 slots: 198.5 × 157 × 123 (W × H × D) 8 slots: 435 × 130 × 123 (W × H × D) 3 slots: 260 × 130 × 123 (W × H × D) 10 slots: 505 × 130 × 123 (W × H × D) 5 slots: 330 × 130 × 123 (W × H × D)					
Product standards	Conforms to UL, CSA, cULus, cUL, NK, Lloyd's, and EC directives.					cULus

- Note:**
1. Disconnect the Power Supply Unit's LG terminal from the GR terminal when testing insulation and dielectric strength.
 2. Only when mounted to a Backplane.
 3. Depth is 153 mm for C200HW-PA209R.
 4. Enquire separately for general specifications of Process I/O Units.

Specifications - Duplex Power Supply Units

Item	Specifications	
Power Supply Unit	CS1D-PA207R	CS1D-PD024
Supply voltage	100 to 120 V AC or 200 to 240 V AC, 50/60 Hz	24 V DC
Operating voltage range	85 to 132 V AC or 170 to 264 V AC	19.2 to 28.8 V DC
Power consumption	150 VA max.	40 W max.
Inrush current	30 A max./100 to 120 V AC 40 A max./200 to 240 V AC	30 A max.
Output capacity	7 A, 5 V DC (including CPU Unit power) 1.3 A, 26 V DC Total: 35 W	4.3 A, 5 V DC (including CPU Unit power) 0.56 A, 26 V DC Total: 28 W
Output terminal	Not provided	Not provided
RUN output (See Note 2.)	Contact configuration: SPST-NO Switch capacity: 240 V AC, 2 A (resistive load) 120 V AC, 0.5 A (inductive load) 24 V DC, 2 A (resistive load) 24 V DC, 2 A (inductive load)	Not provided
Insulation resistance	20 MΩ min. (at 500 V DC) between AC external and GR terminals (See Note 2.)	20 MΩ min. (at 500 V DC) between DC external and GR terminals (See Note 2.)
Dielectric strength	2,300 V AC 50/60 Hz for 1 min between AC external and GR terminals (See Note 2.) Leakage current: 10 mA max.	1,000 V AC 50/60 Hz for 1 min between DC external and GR terminals, leakage current: 10 mA max. (See Note 2.)
	1,000 V AC 50/60 Hz for 1 min between AC external and GR terminals (See Note 1.) Leakage current: 10 mA max.	
Noise immunity	Conforms to IEC61000-4-4, 2 kV (power lines)	
Vibration resistance	10 to 57 Hz, 0.075-mm amplitude, 57 to 150 Hz, acceleration: 9.8 m/s ² in X, Y, and Z directions for 80 minutes (Sweep time 8 min × 10 = total time 80 min.) CPU Unit mounted to a DIN rail: 2 to 55 Hz, 2.9 m/s ² in X, Y, and Z directions for 20 minutes. According to JIS C0040 / IEC 60068-2-6	
Shock resistance	147 m/s ² , 3 times each in X, Y, and Z directions According to JIS C0041 / IEC 60068-2-27	
Ambient operating temperature	0 to 55° C	
Ambient operating humidity	10% to 90% (with no condensation)	
Atmosphere	Must be free from corrosive gases.	
Ambient storage temperature	-20 to 75° C (excluding battery)	
Grounding	Less than 100 Ω	
Enclosure	Mounted in a panel.	
Weight	All models are each 6 kg max.	

Basic System Configuration

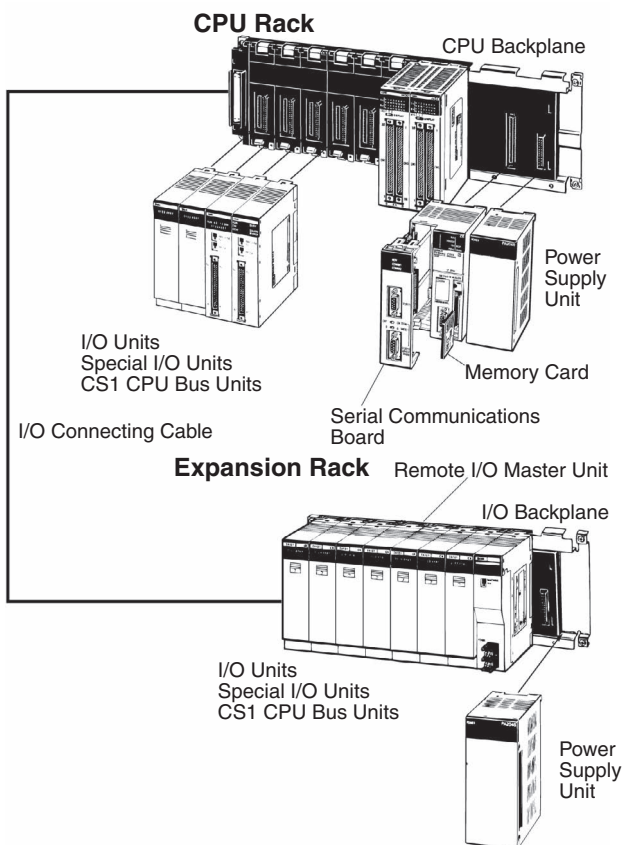

CPU Rack

A CPU Rack consists of a CPU Unit, Power Supply Unit, CPU Backplane, Basic I/O Units, Special I/O Units, and CPU Bus Units. The Serial Communications Board and Memory Cards are optional.

Note: The Backplane depends on the type of CPU Rack, Expansion I/O Racks, and Slave Racks that are used.

Expansion Racks

Both C200H and CS1 Expansion Racks can be used.

- C200H Expansion I/O Racks can be connected to CPU Racks, CS1 Expansion Racks, or other C200H Expansion I/O Racks.
- CS1 Expansion Racks can be connected to CPU Racks or other CS1 Expansion Racks.

An Expansion Rack consists of a Power Supply Unit, a CS1 or C200H Expansion I/O Backplane, Basic I/O Units, Special I/O Units, and a CS1 CPU Bus Units.

Long-distance Expansion Racks

An I/O Control Unit and I/O Interface Units can be used to extend the normal limit of 12 m to 50 m for each of two series of CS1 Expansion Racks. The following Units can be mounted to Long-distance Expansion Racks: CS1 Basic I/O Units, CS1 Special I/O Units, and CS1 CPU Bus Units. (C200H Units cannot be mounted to Long-distance Expansion Racks.)

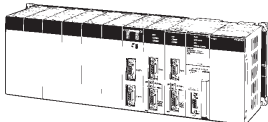

CPU Rack

Configuration

Name	Configuration	Remarks
	CPU Backplane	One of each Unit required for every CPU Rack.
	CPU Unit	Refer to the following table for model number.
	Power Supply Unit	
	Memory Card	Install as required.
	Serial Communications Board	Refer to the following table for model number.

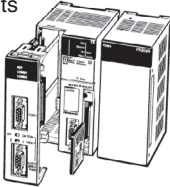
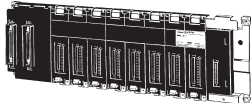
Products Used in CPU Racks

Name	Model	Specifications
	CS1H-CPU67H	I/O bits: 5,120, Program capacity: 250 kSteps Data Memory: 448 kWords (DM: 32 kWords, EM: 32 kWords x 13 banks)
	CS1H-CPU66H	I/O bits: 5,120, Program capacity: 120 kSteps Data Memory: 256 kWords (DM: 32 kWords, EM: 32 kWords x 7 banks)
	CS1H-CPU65H	I/O bits: 5,120, Program capacity: 60 kSteps Data Memory: 128 kWords (DM: 32 kWords, EM: 32 kWords x 3 banks)
	CS1H-CPU64H	I/O bits: 5,120, Program capacity: 30 kSteps Data Memory: 64 kWords (DM: 32 kWords, EM: 32 kWords x 1 bank)
	CS1H-CPU63H	I/O bits: 5,120, Program capacity: 20 kSteps Data Memory: 32 kWords (DM: 32 kWords, EM: 32 kWords x 1 bank)
	CS1G-CPU45H	I/O bits: 5,120, Program capacity: 60 kSteps Data Memory: 128 kWords (DM: 32 kWords, EM: 32 kWords x 3 banks)
	CS1G-CPU44H	I/O bits: 1,280, Program capacity: 30 kSteps Data Memory: 64 kWords (DM: 32 kWords, EM: 32 kWords x 1 banks)
	CS1G-CPU43H	I/O bits: 960, Program capacity: 20 kSteps Data Memory: 64 kWords (DM: 32 kWords, EM: 32 kWords x 1 bank)
	CS1G-CPU42H	I/O bits: 960, Program capacity: 10 kSteps Data Memory: 64 kWords (DM: 32 kWords, EM: 32 kWords x 1 bank)
	CS1W-BC022	2 slots (Connection to Expansion Backplane is not possible.)
	CS1W-BC032	3 slots
	CS1W-BC052	5 slots
	CS1W-BC082	8 slots
	CS1W-BC102	10 slots

Name	Model	Specifications
Power Supply Units 	C200HW-PA204	100 to 120 V AC or 200 to 240 V AC, Output capacity: 4.6 A, 5 V DC
	C200HW-PA204S	100 to 120 V AC or 200 to 240 V AC (0.8 A 24 V DC service power) Output capacity: 4.6 A, 5 V DC
	C200HW-PA204R	100 to 120 V AC or 200 to 240 V AC (with RUN output) Output capacity: 4.6 A, 5 V DC
	C200HW-PD024	24 V DC, Output capacity: 4.6 A, 5 V DC
	C200HW-PA209R	100 to 120 V AC or 200 to 240 V AC (with RUN output) Output capacity: 9 A, 5 V DC
I/O Control Unit	CS1W-IC102	Connects to CS1 Expansion Racks (two Terminating Resistors included). Must be used together with I/O Interface Units to connect Long-distance Expansion Racks (50 m max.). Not required to connect CS1 Expansion Racks within 12 m.
Memory Cards 	HMC-EF372	Flash memory, 30 MB
	HMC-EF672	Flash memory, 64 MB
	HMC-AP001	Memory Card adapter
Serial Communications Boards	CS1W-SCB21-V1	2 x RS-232C ports, protocol macro function
	CS1W-SCB41-V1	1 x RS-232C port + 1 x RS-422/485 port, protocol macro function
Programming Consoles	CQM1-PRO01-E	An English Keyboard Sheet (CS1W-KS001-E) is required.
	C200H-PRO27-E	
Programming Console Connection Cables	CS1W-CN114	Connects the CQM1-PRO01-E Programming Console. (Length: 0.05 m)
	CS1W-CN224	Connects the C200H-PRO27-E Programming Console. (Length: 2.0 m)
	CS1W-CN624	Connects the C200H-PRO27-E Programming Console. (Length: 6.0 m)
CX-One	CX-ONE-AL##C-E ^{*1}	Omron's integrated software for programming and configuration of all control system components, including PLCs, HMI, drives, temperature controllers and advanced sensors.
Programming Device Connecting Cables (for peripheral port)	CS1W-CN118	Connects DOS computer, D-Sub 9-pin receptacle (Length: 0.1 m)
	CS1W-CN226	Connects DOS computer, D-Sub 9-pin (Length: 2.0 m)
	CS1W-CN626	Connects DOS computer, D-Sub 9-pin (Length: 6.0 m)
	XW2Z-200S-CV	Connects DOS computer, D-Sub 9-pin (Length: 2.0 m)
	XW2Z-500S-CV	Connects DOS computer, D-Sub 9-pin (Length: 5.0 m)
Programming Device Connecting Cable (for RS-232C port)	XW2Z-200S-V	Connects DOS computer, D-Sub 9-pin (Length: 2.0 m) (For Host Link connection)
	XW2Z-500S-V	Connects DOS computer, D-Sub 9-pin (Length: 5.0 m) (For Host Link connection)
Battery Set	CS1W-BAT01	For CS1 Series only. Note: Use a replacement battery that is no more than 2 years old from the date of manufacture.

*1 ## = Number of licences; 01, 03, 10

Expansion Racks

Expansion Rack Configuration

Rack	Configuration	Remarks
CS1 Expansion Rack	CS1 Expansion I/O Backplane	One of each Unit is required.
	Power Supply Unit	
	For connection to a CPU Backplane or CS1 Expansion I/O Backplane: CS1 I/O Connecting Cable	
	For connection to a C200H Expansion I/O Backplane: CS1 to C200H I/O Connecting Cable	
C200H Expansion I/O Rack	C200H Expansion I/O Backplane	One of each Unit is required. A CS1 Expansion Rack cannot be connected after a C200H Expansion I/O Rack.
	Power Supply Unit	
	For connection to a CPU Backplane or CS1 Expansion I/O Backplane: CS1 to C200H I/O Connecting Cable	
	For connection to a C200H Expansion I/O Backplane: C200H I/O Connecting Cable	

Products Used in Expansion Racks

Name	Model	Specifications	Cable Length
CS1 Expansion I/O Backplanes	CS1W-BI032	3 slots	These Backplanes are for CS1 Units only. Use CS1W-BI□□3 Backplanes if C200H Units are to be installed.
	CS1W-BI052	5 slots	
	CS1W-BI082	8 slots	
	CS1W-BI102	10 slots	
C200H Expansion I/O Backplanes	C200HW-BI031	3 slots	---
	C200HW-BI051	5 slots	
	C200HW-BI081-V1	8 slots	
	C200HW-BI101-V1	10 slots	
Power Supply Units	C200HW-PA204	100 to 120 V AC or 200 to 240 V AC Output capacity: 4.6 A, 5 V DC	---
	C200HW-PA204S	100 to 120 V AC or 200 to 240 V AC (with power output terminal: 0.8 A, 24 V DC) Output capacity: 4.6 A, 5 V DC	
	C200HW-PA204R	100 to 120 V AC or 200 to 240 V AC (with RUN output) Output capacity: 4.6 A, 5 V DC	
	C200HW-PA209R	100 to 120 V AC or 200 to 240 V AC (with RUN output) Output capacity: 9 A, 5 V DC	
	C200HW-PD024	24 V DC	

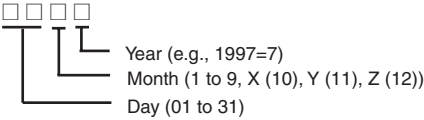
Name	Model	Specifications	Cable Length
I/O Interface Unit	CS1W-II102	Connects CS1 Expansion Racks. Must be used together with I/O Control Unit to connect Long-distance Expansion Racks (50 m max.). Not required to connect CS1 Expansion Racks within 12 m.	---
CS1 I/O Connecting Cables	CS1W-CN313	Connects CS1 Expansion I/O Backplanes to CPU Backplanes or other CS1 Expansion I/O Backplanes. When using a CS1W-CN313 or CS1W-CN713 I/O Connecting Cable with a CS1□-CPU□□H CPU Unit, use only Cables produced on or after September 20, 2001 (production number 2091). Cables with no production number, a 6-digit production number, or produced before September 20, 2001, cannot be used. Reading the production number 	0.3 m
	CS1W-CN713		0.7 m
	CS1W-CN223		2 m
	CS1W-CN323		3 m
	CS1W-CN523		5 m
	CS1W-CN133		10 m
	CS1W-CN133-B2		12 m
Long-distance Connecting Cables	CV500-CN312	For Long-distance Expansion Racks Connects the I/O Control Unit to I/O Interface Units or connects one I/O Interface Unit to the next I/O Interface Unit.	0.3 m
	CV500-CN612		0.6 m
	CV500-CN122		1 m
	CV500-CN222		2 m
	CV500-CN322		3 m
	CV500-CN522		5 m
	CV500-CN132		10 m
	CV500-CN232		20 m
	CV500-CN332		30 m
	CV500-CN432		40 m
	CV500-CN532		50 m
CS1-C200H I/O Connecting Cables	CS1W-CN311	Connects C200H Expansion I/O Backplanes to CPU Backplanes or CS1 Expansion I/O Backplanes.	0.3 m
	CS1W-CN711		0.7 m
	CS1W-CN221		2 m
	CS1W-CN321		3 m
	CS1W-CN521		5 m
	CS1W-CN131		10 m
C200H I/O Connecting Cables	CS1W-CN131-B2	12 m	
	C200H-CN311	Connects C200H Expansion I/O Backplanes to other C200H Expansion I/O Backplanes.	0.3 m
	C200H-CN711		0.7 m
	C200H-CN221		2 m
	C200H-CN521		5 m
C200H-CN131	10 m		

Expansion Rack Patterns

The following diagrams show the 5 possible patterns of Expansion Racks.

CPU Rack with CS1 Expansion Racks

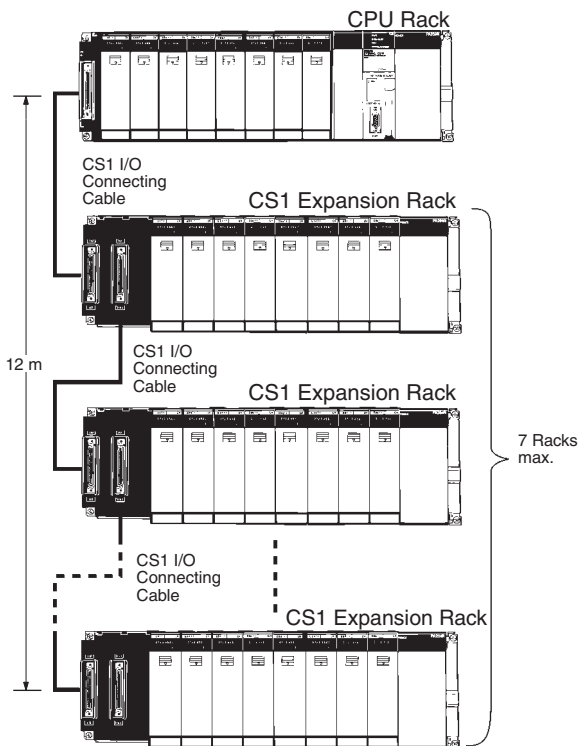

CPU Rack with CS1 Expansion Racks and C200H Expansion I/O Racks

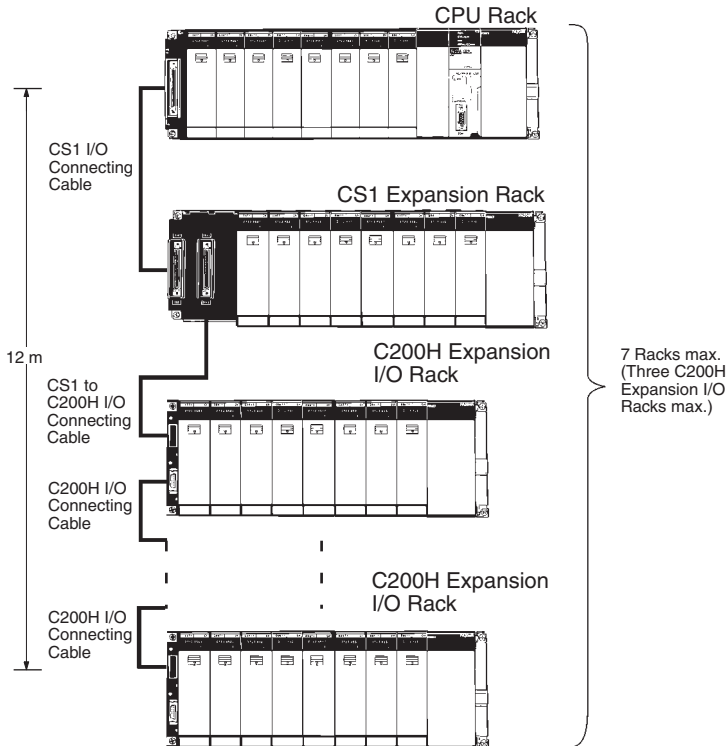

CPU Rack with CS1 Long-Distance Expansion Racks

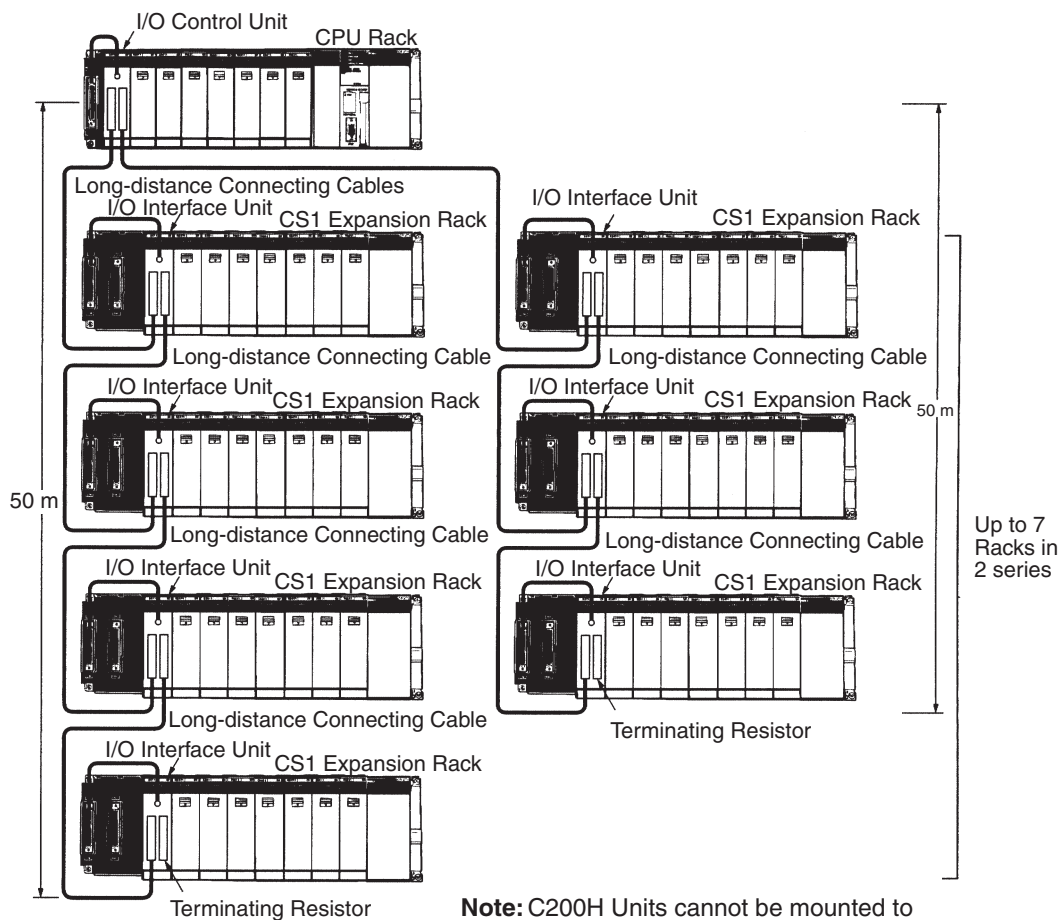

Note: C200H Units cannot be mounted to Long-distance Expansion Racks.

CPU Rack with C200H Expansion I/O Racks

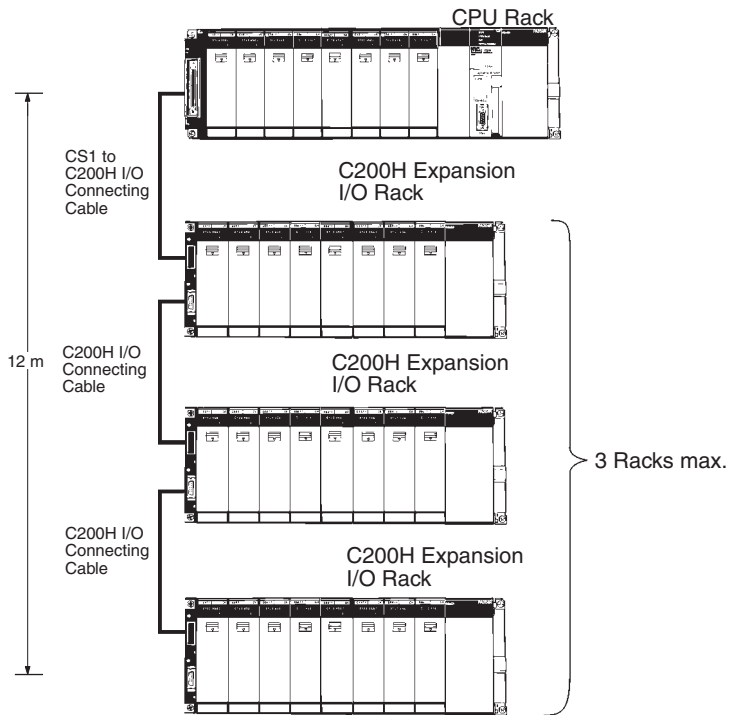

CPU Rack with CS1 Expansion Rack and CS1 Long-Distance Expansion Racks

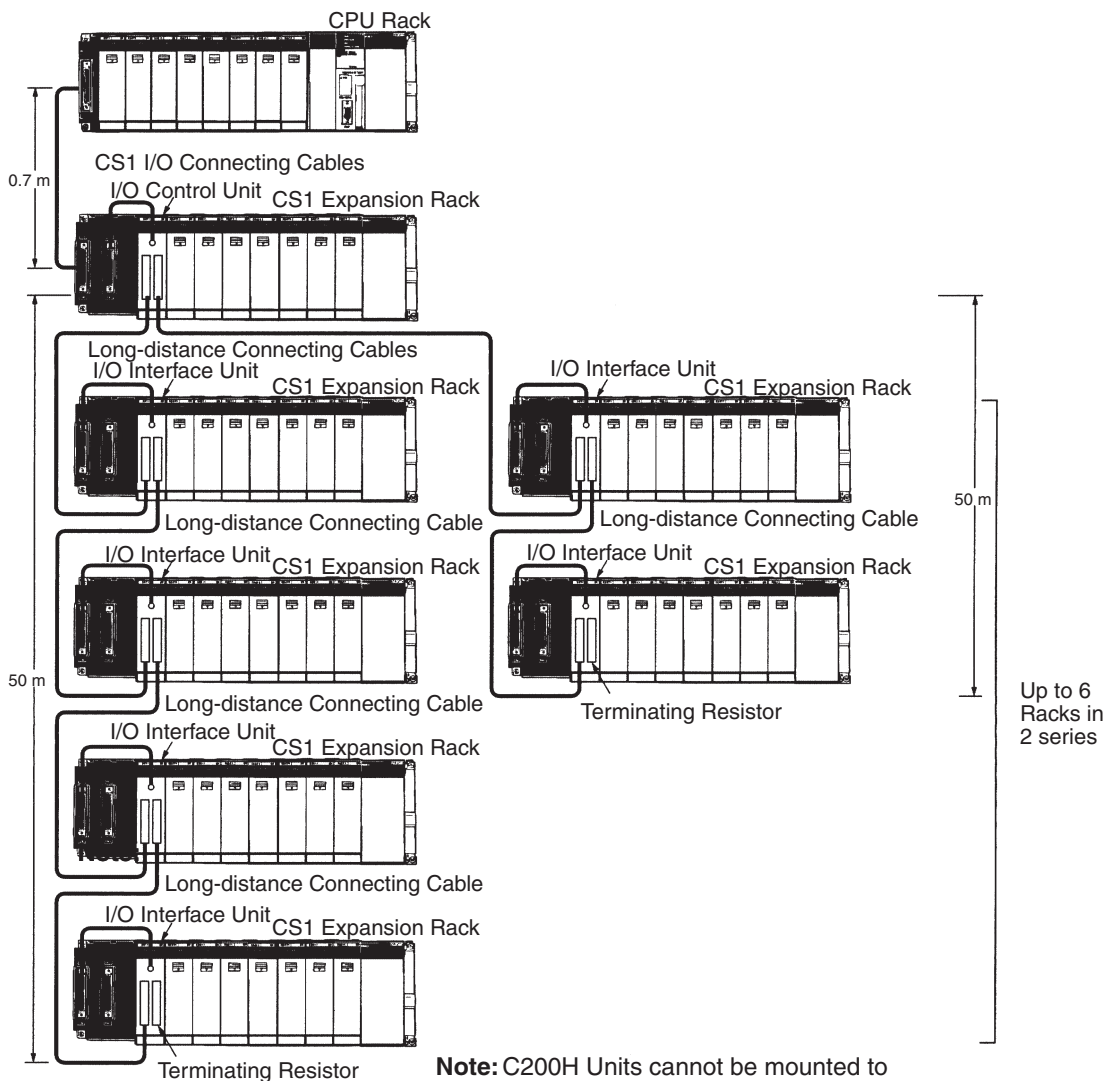

Note: C200H Units cannot be mounted to Long-distance Expansion Racks. (They can be mounted to the CS1 Expansion Rack with the I/O Control Unit mounted.)

System Configuration (Duplex Systems)

Duplex-CPU System

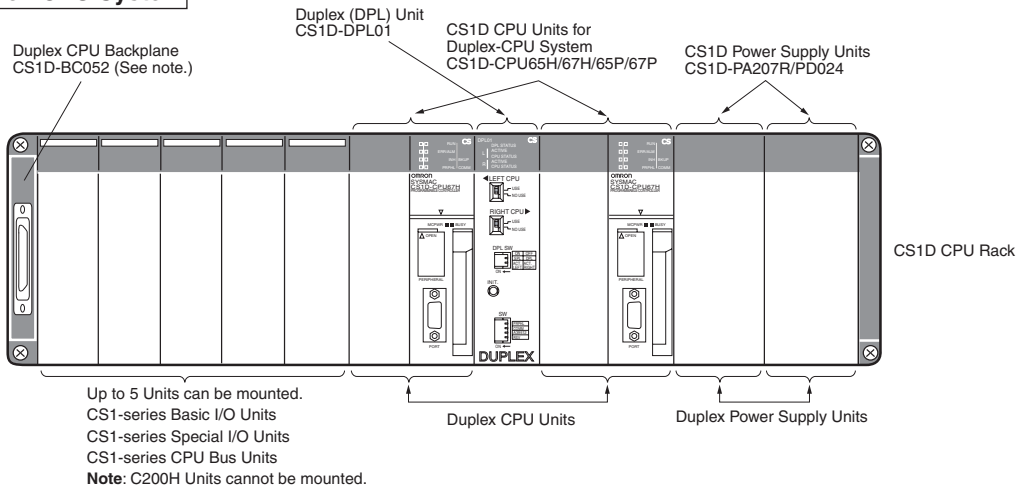

Single-CPU System

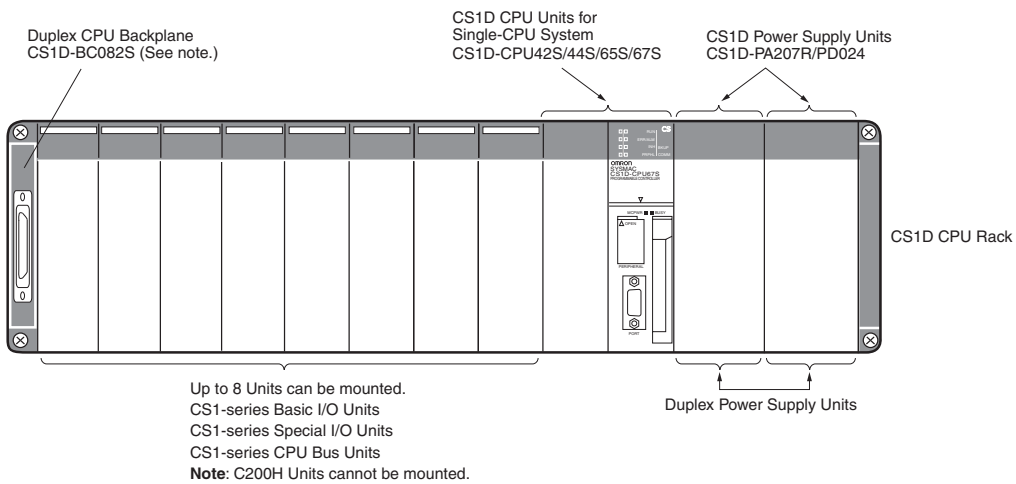

CPU Rack

A CPU Rack consists of a Duplex CPU Backplane to which CPU Units, Power Supply Units, a Duplex Unit, CS1-series Basic I/O Units, CS1-series Special I/O Units, and CS1-series CPU Bus Units are mounted. Memory Cards and Inner Boards to mount in the CPU Units are optional. (Inner Board cannot be mounted to the CS1D-CPU□□H/P) The CPU Units, Power Supply Units, Duplex CPU Backplane, and Duplex Unit are all designed specifically for CS1D PLCs.

Note: Different Backplanes are used for the CPU Rack and Expansion Racks. Be sure to use the correct Backplane.

Expansion Racks

An Expansion Rack consists of an Expansion Backplane to which Power Supply Units, CS1-series Basic I/O Units, CS1-series Special I/O Units, and CS1-series CPU Bus Units are mounted.

The Power Supply Units and Expansion Backplane are designed specifically for CS1D PLCs.

CS1-series Expansion Backplanes and C200H Backplanes cannot be connected.

Long-distance Expansion Racks

A Long-distance Expansion Rack consists of an Expansion Backplane to which an I/O Interface Unit, CS1-series Basic I/O Units, CS1-series Special I/O Units, and CS1-series CPU Bus Units are mounted. An I/O Control Unit is used to connect to the Long-distance Expansion Racks. Using Long-distance Expansion Rack increases the normal limit of 12 m for the Rack to 50 m.

CS1D PLCs

With a CS1D Duplex-CPU System, two CPU Units can be mounted to the CPU Rack for Duplex Mode operation (Duplex Mode), or just one CPU Unit can be mounted for Simplex Mode operation. In either case, a Duplex Unit is required.

With a CS1D Single-CPU System, just one CPU Unit is mounted and a Duplex Unit is not required.

Also, two Power Supply Units can be mounted to any Rack to increase redundancy. (Racks can also be operated with only one Power Supply Unit.) With any of these combinations, there are no further restrictions if the system configuration, e.g., the same number of Expansion Racks can be used as with the other CS1-series PLCs.

Note: C200H Basic I/O Units, C200H Special I/O Units, and C200H CPU Bus Units cannot be mounted on any Rack.

Expansion Patterns for CS1D PLCs

CS1D CPU Rack + CS1D Expansion Rack

CS1D CPU Rack + CS1D Long-distance Expansion Racks

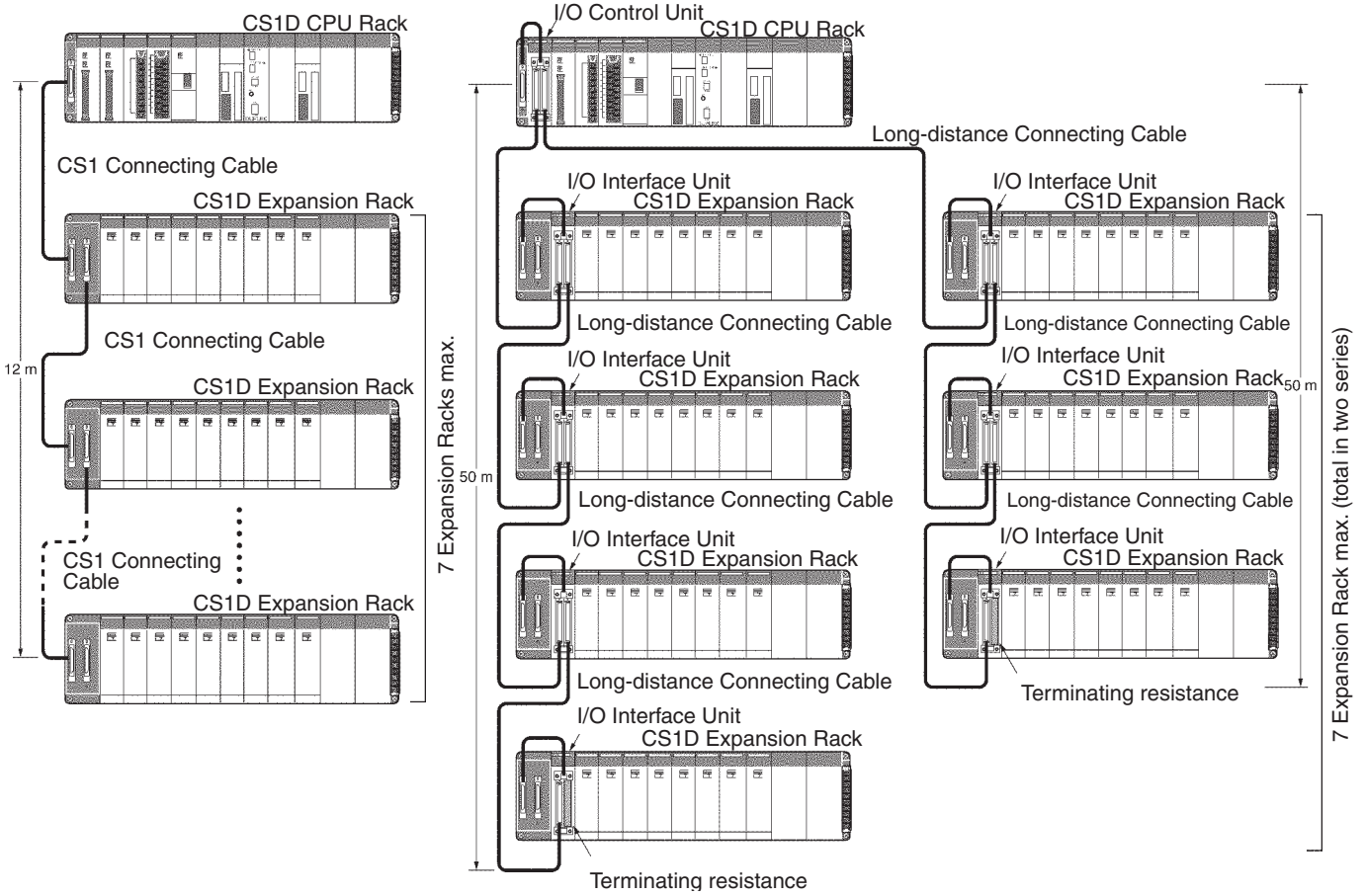

Name	Model	Specifications	Cable Length
Long-distance Connecting Cables	CV500-CN312	For Long-distance Expansion Racks Connects the I/O Control Unit to I/O Interface Units or connects one I/O Interface Unit to the next I/O Interface Unit.	0.3 m
	CV500-CN612		0.6 m
	CV500-CN122		1 m
	CV500-CN222		2 m
	CV500-CN322		3 m
	CV500-CN522		5 m
	CV500-CN132		10 m
	CV500-CN232		20 m
	CV500-CN332		30 m
	CV500-CN432		40 m
CV500-CN532	50 m		
CS1-C200H I/O Connecting Cables	CS1W-CN311	Connects C200H Expansion I/O Backplanes to CPU Backplanes or CS1 Expansion I/O Backplanes.	0.3 m
	CS1W-CN711		0.7 m
	CS1W-CN221		2 m
	CS1W-CN321		3 m
	CS1W-CN521		5 m
	CS1W-CN131		10 m
C200H I/O Connecting Cables	CS1W-CN131-B2	Connects C200H Expansion I/O Backplanes to other C200H Expansion I/O Backplanes.	12 m
	C200H-CN311		0.3 m
	C200H-CN711		0.7 m
	C200H-CN221		2 m
	C200H-CN521		5 m
C200H-CN131	10 m		

Connections to Programming Devices

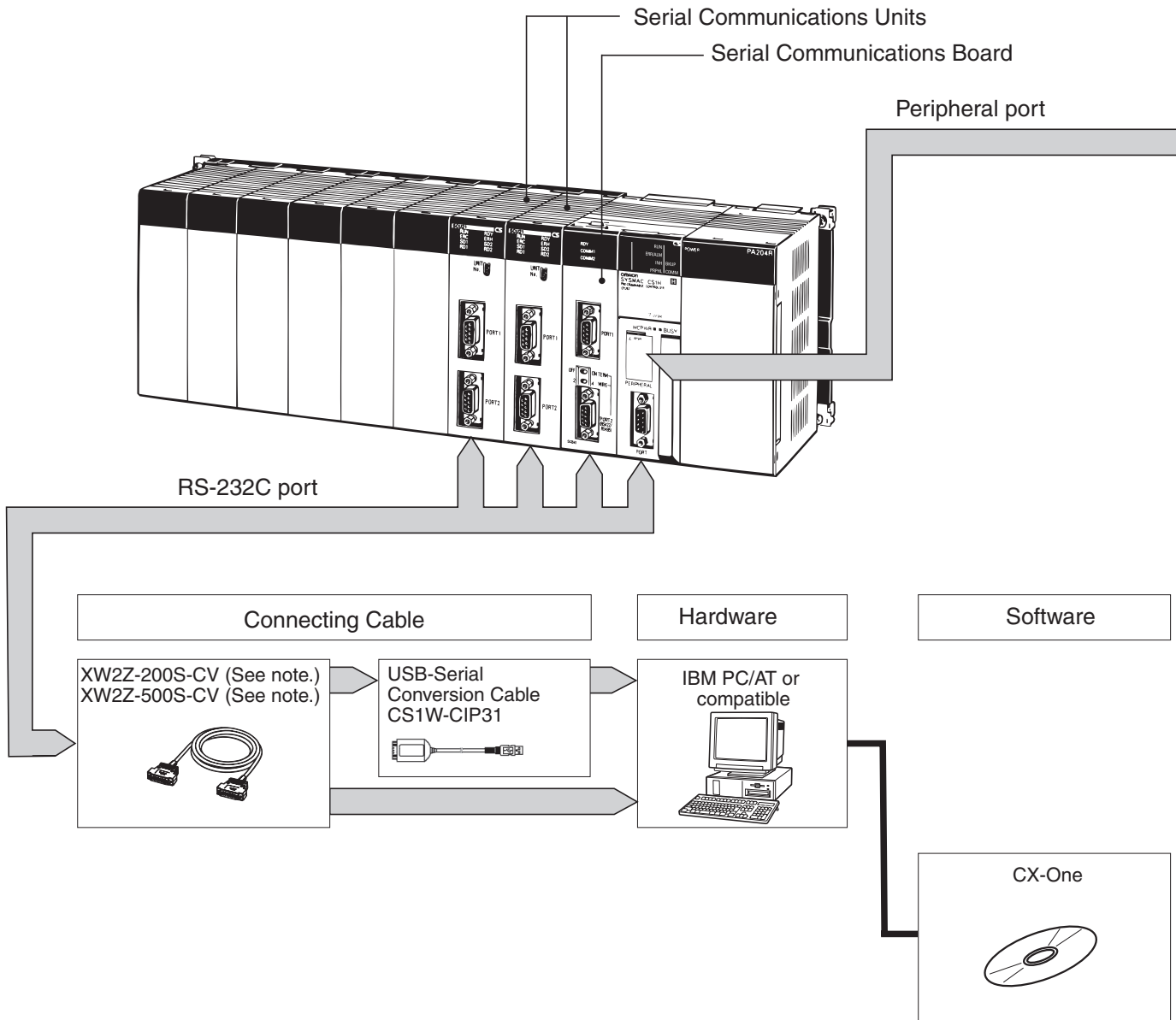

Note: Refer to the next page for details of cables for connecting to computers. Choose the appropriate cable for the communications mode.

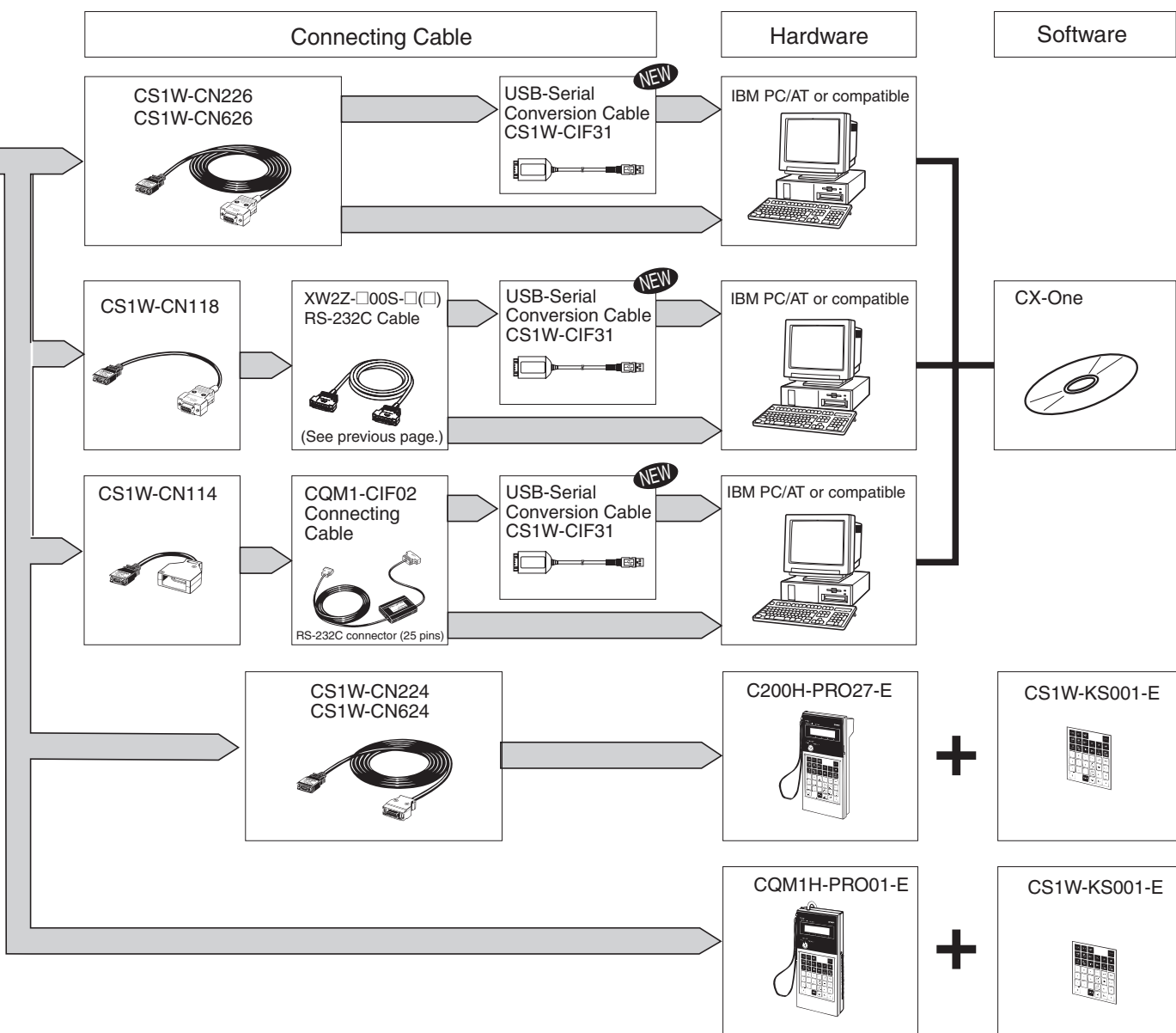

Programming Consoles

CQM1H-PRO01-E

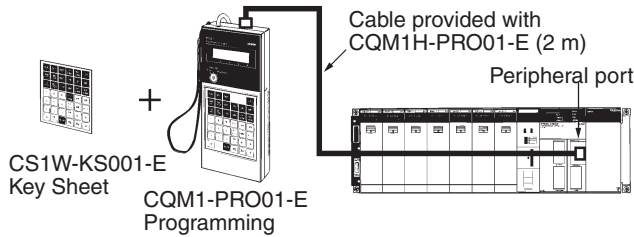

Model	Cable	Cable length
CQM1H-PRO01-E	Not required.	---

C200H-PRO27-E

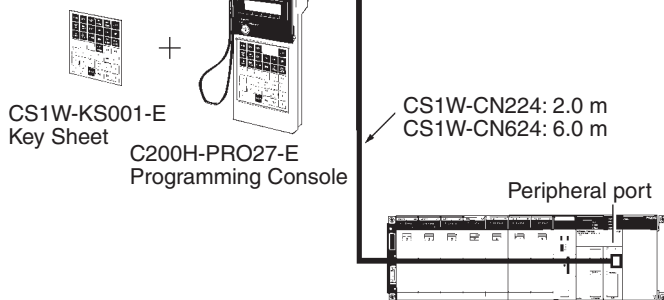

Model	Cable	Cable length
C200H-PR027-E	CS1W-CN224	2.0 m
	CS1W-CN624	6.0 m

Windows-based Programming Software: CX-Programmer

Name	Model	Specifications
CX-Pro-grammer	WS02-CXPC1-EV□□	For 1 license OS: Windows 95/98 or Windows NT/Me/2000/XP
	WS02-CXPC1-EL03-V□□	For 3 licenses
	WS02-CXPC1-EL10-V□□	For 10 licenses

Connecting to the Peripheral Port

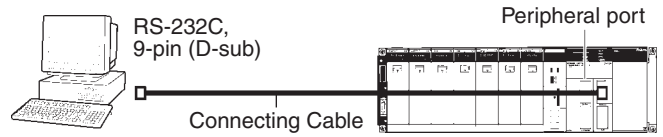

Peripheral Port Connecting Cables

Cable	Length	Computer connector
CS1W-CN226	2.0 m	D-sub, 9-pin, male
CS1W-CN626	6.0 m	

The following cables can be used for an RS-232C connection from the computer to the peripheral port.

Mode	Connecting cables	Length	Computer connector
Peripheral bus or Host Link	XW2Z-200S-CV or XW2Z-500S-CV	CS1W-CN118	2 or 5 m + 0.1 m
	XW2Z-200S-V or XW2Z-500S-V		

Connecting to the RS-232C Port

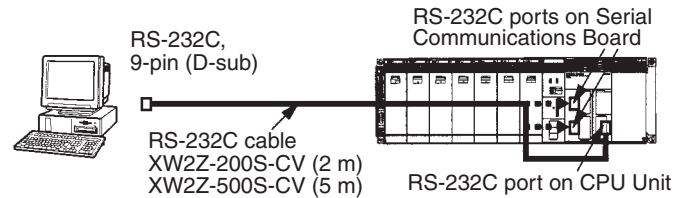

RS-232C Port Connecting Cables

Mode	Cable	Length	Computer connector
Peripheral bus or Host Link	XW2Z-200S-CV	2.0 m	D-sub, 9-pin, male
	XW2Z-500S-CV	5.0 m	

Note: Cables with model numbers ending in "CV" are antistatic. The following cables can be used for an RS-232C connection from the computer to an RS-232C port. (Unlike cables with model numbers ending in "-CV," however, these cables do not support peripheral bus connection and do not have anti-static specifications.)

Mode	Cable	Length	Computer connector
Host Link	XW2Z-200S-V	2.0 m	D-sub, 9-pin, male
	XW2Z-500S-V	5.0 m	

The following serial communications modes can be used to connect a computer with the CX-Programmer to a CS1 PLC.

Mode	Features
Peripheral bus	The faster mode, peripheral bus is generally used for CX-Programmer connections. Only 1:1 connections are possible. The baud rate is automatically detected with the CS1.
Host Link	A standard protocol for host computers. Slower than peripheral bus, but allows modem or optical adapter connections, or long-distance or 1:N connections via RS422A/485.

Using a USB-Serial Conversion Cable to Connect to a Peripheral or RS-232C Port

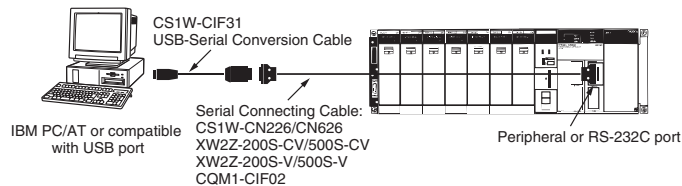

Applicable Software

CX-Programmer, CX-Simulator, CX-Protocol, CX-Motion, CX-Positioner, CS-Process, DeviceNet Configurator, PLC Reporter 32, CX-Designer, and NT Support Software for Windows (NTST) (See note.)

Note: There are restrictions to the COM port numbers that can be used for the NTST.

Applicable Communications Middleware

FinsGateway and CX-Server

Applicable PLCs and PTs

The OMRON PLCs and PTs supported by the applicable software can be used. These are listed below.

PLCs

CS Series, CJ Series, C Series (C200HS, C200HX/HG/HE, C200H, C1000H, C2000H, CQM1, CPM1, CPM1A, SRMT, CQM1H, and CPM2C), CVM1, and CV Series

PTs

NS Series and NT Series

General Specifications of USB-Serial Conversion Cable

USB interface standard		Conforms to USB Specification 1.1.
DTE speed		115.2 Kbits/s
Connectors	On computer	USB (A plug connector, male)
	On PLC	RS-232C (D-sub, 9-pin, female)
Power supply		Bus power (supplied from upstream, 5 V DC)
Current consumption		35 mA
Operating environment	Ambient temperature	0 to 55 °C
	Ambient humidity	10% to 90% (with no condensation)
	Ambient atmosphere	No corrosive gases
Weight		50 g

OS with Drivers for USB-Serial Conversion Cable

Windows 98, ME, 2000, or XP

Peripheral Port Connecting Cables

Computer	Serial Communications Node	Connecting Cable model number		Length	Computer connector
IBM PC/AT or compatible	Tool bus or SYSMAC WAY	CS1W-CIF31	CS1W-CN226	0.5 m + 2.0 m	USB (A plug connector)
			CS1W-CN626	0.5 m + 6.0 m	
	CS1W-CIF31	XW2Z-200S-CV/ XW2Z-500S-CV	CS1W-CN118	0.5 m + (2.0 m or 5.0 m) + 0.1 m	
	SYSMAC WAY	CS1W-CIF31	XW2Z-200S-V/ XW2Z-500S-V	0.5 m + (2.0 m or 5.0 m) + 0.1 m	

RS-232C Port Connecting Cables

Computer	Serial Communications Node	Connecting Cable model number		Length	Computer connector
IBM PC/AT or compatible	Tool bus or SYSMAC WAY	CS1W-CIF31	XW2Z-200S-CV	0.5 m + 2.0 m	USB (A plug connector)
			XW2Z-500S-CV	0.5 m + 5.0 m	
	SYSMAC WAY	CS1W-CIF31	XW2Z-200S-V (See note.) XW2Z-500S-V (See note.)	0.5 m + 2.0 m 0.5 m + 5.0 m	

Connection in Tool Bus Mode is not possible. The connector does not have ESD measures.

Dimensions

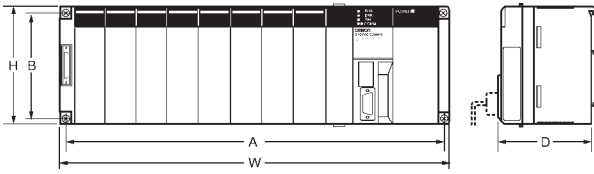

Unit: mm

Backplane	A	B	W	H	D
CS1W-BC022/023 (2 slots)	172.3	145	198.5	157	123
CS1W-BC032/033 (3 slots)	246	118	260	132	
CS1W-BC052/053 (5 slots)	316		330		
CS1W-BC082/083 (8 slots)	421		435		
CS1W-BC102/103 (10 slots)	491		505		
CS1D-BC052/082S (Duplex System)					

Backplanes

CPU Backplane with 2 Slots

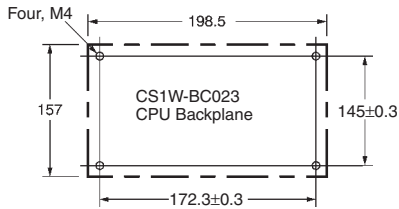

Note: Expansion Backplanes cannot be connected to 2-slot CPU Backplanes.

CPU Backplane with 3, 5, 8, or 10 Slots

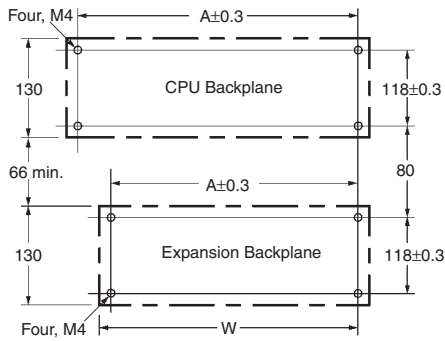

Unit: mm

Backplane	Model	A	W
CPU Backplanes	CS1W-BC022/023 (2 slots)	172.3	198.5
	CS1W-BC032/033 (3 slots)	246	260
	CS1W-BC052/053 (5 slots)	316	330
	CS1W-BC082/083 (8 slots)	421	435
	CS1W-BC102/103 (10 slots)	491	505
CS1 Expansion Backplanes	CS1D-BC052/082S (Duplex System)		
	CS1W-BI032/033 (3 slots)	246	260
	CS1W-BI052/053 (5 slots)	316	330
	CS1W-BI082/083 (8 slots)	421	435
	CS1W-BI102/103 (10 slots)	491	505
C200H Expansion I/O Backplanes	CS1D-BI092 (Duplex System)		
	C200HW-BI031 (3 slots)	175	189
	C200HW-BI051 (5 slots)	245	259
	C200HW-BI081-V1 (8 slots)	350	364
	C200HW-BI101-V1 (10 slots)	420	434

Mounting Depth

The depth of all Racks is from 118 to 153 mm depending on the Units that are mounted. Additional depth is required to connect Peripheral Devices and Cables. Be sure to allow sufficient mounting depth.

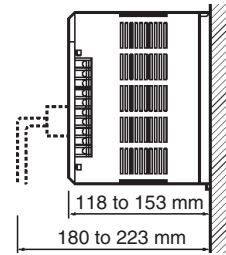

Note: I/O Connecting Cables require sufficient space to maintain the min. bending radius.

CS1 I/O Connecting Cable (Cable diameter: 8.6 mm)

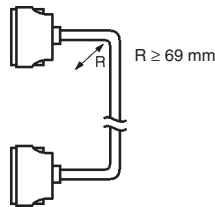

C200H I/O Connecting Cable (Cable diameter: 5.1 mm)

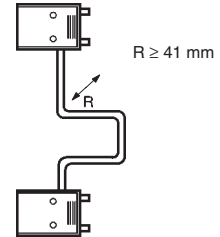

CS1 to C200H I/O Connecting Cable (Cable diameter: 5.1 mm)

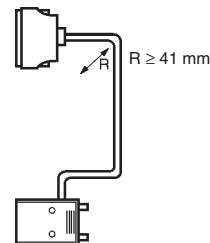

Long-distance Connecting Cable (Cable diameter: 10 mm)

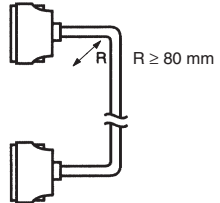

I/O Allocations

I/O Allocations

In CS1 PLCs, part of the I/O memory is allocated to each Unit. Units are divided into the following 3 groups for allocations.

- Basic I/O Units
- Special I/O Units
- CS1 CPU Bus Units

Basic I/O Units

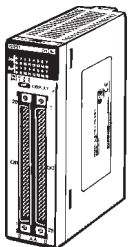

CS1 Basic I/O Units

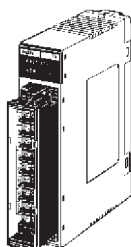

C200H Basic I/O Units

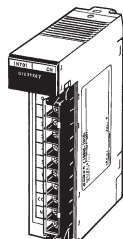

C200H Group-2 High-density I/O Units
(See Note 2.)

Allocations

CIO Area:
CIO 0000 to CIO 0319 (See Note 1.)
(Memory is allocated in word units in order of mounting position in the Racks.)

- Note
1. The Rack's first word setting can be changed from the default setting (CIO 0000) to any word from CIO 0000 to CIO 9999. The first word setting can be changed only with a Programming Device other than a Programming Console.
 2. The unit number setting on the front of C200H Group-2 High-density I/O Units is ignored. Words are allocated to these Units based on their location in the Rack.

Special I/O Units

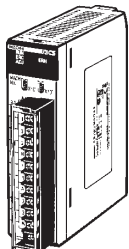

CS1 Special I/O Units

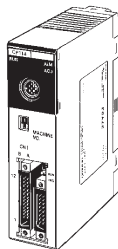

C200H Special I/O Units
(See Note 2.)

Allocations

Special I/O Unit Area:
CIO 2000 to CIO 2959
(Each Unit is allocated ten words based on its unit number.)

- Note
1. Although there are 96 unit number settings, a maximum of 80 Units can actually be mounted to a PLC because that is the maximum number of slots possible.
 2. Some Units classified as I/O Units (namely C200H High-density I/O Units) are actually treated as Special I/O Units.

CS1 CPU Bus Units

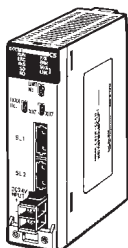

CS1 CPU Bus Units

Allocations

CS1 CPU Bus Unit Area:
CIO 1500 to CIO 1899
(Each Unit is allocated 25 words based on its unit number.)

Allocations to Basic I/O Unit Groups

Basic I/O Units include CS1 Basic I/O Units, C200H Basic I/O Units, and C200H Group-2 High-density I/O Units.

Allocated words in the CIO Area: CIO 0000 to CIO 0319

Basic I/O Units can be mounted to the CPU Rack, CS1 Expansion Racks, and C200HX/HG/HE Expansion I/O Racks.

Note: CS1 Basic I/O Units cannot be mounted to C200HX/HG/HE Expansion I/O Racks.

Allocation Methods

1. CPU Rack

Basic I/O Units on the CPU Rack are allocated words left to right; Units are allocated as many words as required in word units. With CPU Ver. 2.0 and higher it is possible to specify start addresses per rack or per slot.

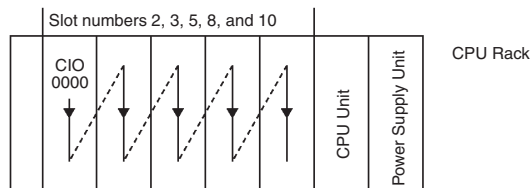

Example

0	1	2	3	4		
IN 8 CIO 0000	IN 16 CIO 0001	IN 64 CIO 0002 to 0005	OUT 8 CIO 0006	OUT 32 CIO 0007 to 0008	CPU Unit	Power Supply Unit

CPU Rack

2. Allocations to CS1 Expansion and C200H Expansion I/O Racks
 I/O allocations to Basic I/O Units continue from the CPU Rack to the Expansion Racks. Words are allocated from left to right and each Unit is allocated as many words as it requires in word units, just like Units in the CPU Rack.

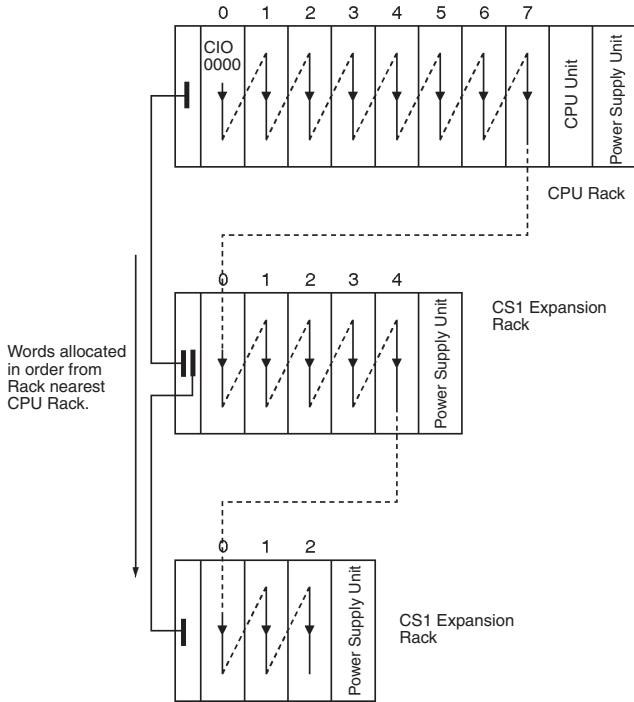

3. CS1 Long-distance Expansion Racks

Words are allocated to series A and then series B. Otherwise, allocations are the same as for other Racks.

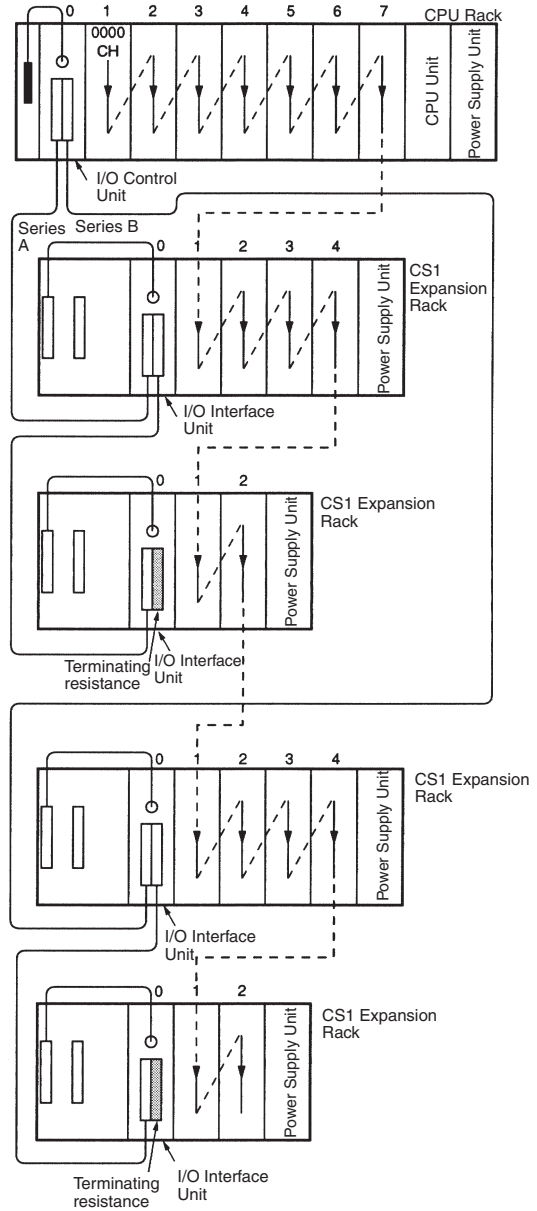

Allocations to Special I/O Units

Special I/O Units include CS1 Special I/O Units and C200H Special I/O Units.

Each of these Units is allocated ten words in the Special I/O Unit Area (CIO 2000 to CIO 2959).

Special I/O Units can be mounted to the CPU Rack, CS1 Expansion Racks, and C200H Expansion I/O Racks. (See note.)

Note: CS1 Special I/O Units cannot be mounted to C200H Expansion I/O Racks.

Each Unit is allocated 10 words in the Special I/O Unit Area, as shown in the following table.

Unit number	Words allocated
0	CIO 2000 to CIO 2009
1	CIO 2010 to CIO 2019
2	CIO 2020 to CIO 2029
...	...
15	CIO 2150 to CIO 2159
...	...
95	CIO 2950 to CIO 2959

Note: Special I/O Units are ignored during I/O allocation to Basic I/O Units. Slots containing Special I/O Units are treated as empty slots.

Allocations to CS1 CPU Bus Units

Each CS1 CPU Bus Unit is allocated 25 words in the CS1 CPU Bus Unit Area (CIO 1500 to CIO 1899).

CS1 CPU Bus Units can be mounted to the CPU Rack or CS1 Expansion Racks.

Each Unit is allocated 25 words in the CPU Bus Unit Area, as shown in the following table.

Unit number	Words allocated
0	CIO 1500 to CIO 1524
1	CIO 1525 to CIO 1549
2	CIO 1550 to CIO 1574
...	...
15	CIO 1875 to CIO 1899

Note: CS1 CPU Bus Units are ignored during I/O allocation to Basic I/O Units. Slots containing CS1 CPU Bus Units are treated as empty slots.

Current Consumption

The amount of current/power that can be supplied to the Units mounted in a Rack is limited by the capacity of the Rack's Power Supply Unit. The system must be designed so that the total current consumption of the Units does not exceed the maximum current for each voltage group and the total power consumption does not exceed the maximum for the Power Supply Unit.

CPU Racks and Expansion Racks

The following table shows the maximum currents and power that can be supplied by Power Supply Units on CPU Racks and Expansion Racks (both CS1 Expansion Racks and C200H Expansion I/O Racks).

- Note:**
- When calculating current/power consumption in a CPU Rack, be sure to include the power required by the CPU Backplane and CPU Unit themselves.
 - Likewise, be sure to include the power required by the Expansion Backplane itself when calculating current/power consumption in an Expansion Rack.

Power Supply Unit	Max. Current Consumption			Max. Total Power Consumption
	5-V group	26-V group	24-V group	
C200HW-PA204	4.6 A	0.6 A	None	30 W
C200HW-PA204S	4.6 A	0.6 A	0.8 A	30 W
C200HW-PA204R	4.6 A	0.6 A	None	30 W
C200HW-PD204	4.6 A	0.6 A	None	30 W
C200HW-PA209R	9.0 A	1.3 A	None	45 W
C200HW-PD106R	6.0 A	1.0 A	None	30 W
CS1D-PA207R	7.0 A	1.3 A	None	35 W
CS1D-PD024	4.3 A	0.56 A	None	28 W

Be sure both Condition 1 and Condition 2 are met.

Condition 1: Maximum Current Supply

- Current required at 5 V DC by all Units (A) \leq Max. Current shown in table
- Current required at 26 V DC by all Units (B) \leq Max. Current shown in table
- Current required at 24 V DC by all Units (C) \leq Max. Current shown in table

Condition 2: Maximum Total Current Supply

- $A \times 5 \text{ V DC} + B \times 26 \text{ V DC} + C \times 24 \text{ V DC} \leq$ Max. Power shown in table

Example Calculations

In this example, the following Units are mounted to a CPU Rack with a C200HW-PA204S Power Supply Unit.

Unit	Model	Quantity	5- V DC	26- V DC	24- V DC
CPU Backplane (8 slots)	CS1W-BC083	1	0.11 A	---	---
CPU Unit	CS1H-CPU67-EV1	1	1.10 A	---	---
Input Units	C200H-ID216	2	0.10 A	---	---
	CS1W-ID291	2	0.20 A	---	---
Output Units	C200H-OC221	2	0.01 A	0.075 A	---
Special I/O Unit	C200H-NC213	1	0.30 A	---	---
CPU Bus Unit	CS1W-CLK21	1	0.50 A	---	---
Service Power Supply Unit (24 V DC)		0.3 A used	---	---	0.3 A
Total current/power consumption			2.63 A (≤ 4.6) x 5 V = 13.15W	0.15 A (≤ 0.6 A) x 26 V = 3.9 W	0.3 A (≤ 0.8 A) x 24 V = 7.2 W
13.15+3.9+7.2 = 24.25 (30 W)					

Current Consumption Tables

5- V DC Voltage Group

Name	Model	Consumption (A)
CPU Units (These values include current consumption by a Programming Console.)	CS1H-CPU67H	0.82 (See note.)
	CS1D-CPU67H	
	CS1D-CPU67S	
	CS1H-CPU66H	0.82 (See note.)
	CS1H-CPU65H	
	CS1D-CPU65H	0.82 (See note.)
	CS1D-CPU65S	
	CS1H-CPU64H	0.82 (See note.)
	CS1H-CPU63H	
	CS1G-CPU45H	0.78 (See note.)
	CS1G-CPU44H	0.78 (See note.)
	CS1D-CPU44S	
	CS1G-CPU43H	0.78 (See note.)
	CS1G-CPU42H	
CS1D-CPU42S		
Duplex Process CPU Units	CS1D-CPU67P CS1D-CPU65P	1.04
Loop Control Boards	CS1W-LCB01	0.22 (See note.)
	CS1W-LCB05	
Serial Communication Boards	CS1W-SCB21-V1	0.28 (See note.)
	CS1W-SCB41-V1	
CPU Backplanes (for CS1 Units only)	CS1W-BC022	0.11
	CS1W-BC032	0.11
	CS1W-BC052	0.11
	CS1W-BC082	0.11
	CS1W-BC102	0.11
CPU Backplanes	CS1W-BC023	0.11
	CS1W-BC033	0.11
	CS1W-BC053	0.11
	CS1W-BC083	0.11
	CS1W-BC103	0.11
I/O Control Unit	CS1W-IC102	0.92
CS1 Expansion Backplanes (for CS1 Units only)	CS1W-BI032	0.23
	CS1W-BI052	0.23
	CS1W-BI082	0.23
	CS1W-BI102	0.23
CS1 Expansion Backplanes	CS1W-BI033	0.23
	CS1W-BI053	0.23
	CS1W-BI083	0.23
	CS1W-BI103	0.23
I/O Interface Unit	CS1W-II102	0.23
C200H Expansion I/O Backplanes	C200HW-BI031	0.15
	C200HW-BI051	0.15
	C200HW-BI081-V1	0.15
	C200HW-BI101-V1	0.15
CS1 Duplex Backplane	CS1D-BC052	Total
CS1 Duplex Unit	CS1D-DPL01	0.55
CS1D Single CPU Backplane	CS1D-BC082S	0.17
CS1D Expansion Backplane	CS1D-BI092	0.28

Note: Add 0.15 A per port when the NT-AL001-E is connected.

Basic I/O Units

Category	Name	Model	Consumption (A)
C200H Input Units	DC Input Units	C200H-ID211	0.01
		C200H-ID212	0.01
	AC Input Units	C200H-IA121	0.01
		C200H-IA122	0.01
		C200H-IA122V	0.01
		C200H-IA221	0.01
		C200H-IA222	0.01
		C200H-IA222V	0.01
C200H Input Units	AC/DC Input Units	C200H-IM211	0.01
		C200H-IM212	0.01
	B7A Interface Units	C200H-B7A11	0.10
		C200H-B7A12	0.10
Interrupt Input Unit	C200HS-INT01	0.02	
C200H Group-2 High-density Input Units	DC Input Units	C200H-ID216	0.10
		C200H-ID217	0.12
		C200H-ID218	0.10
		C200H-ID219	0.12
		C200H-ID111	0.12

Category	Name	Model	Consumption (A)	
CS1 Input Units	DC Input Units	CS1W-ID211	0.10	
		CS1W-ID231	0.15	
		CS1W-ID261	0.15	
		CS1W-ID291	0.20	
	AC Input Units	CS1W-IA111	0.11	
		CS1W-IA211	0.11	
	Interrupt Input Unit	CS1W-INT01	0.10	
	High-speed Input Unit	CS1W-IDP01	0.10	
Safety Relay Unit	CS1W-SF200	0.10		
C200H Output Units	Relay Output Units	C200H-OC221	0.01	
		C200H-OC222	0.01	
		C200H-OC222N	0.008	
		C200H-OC225	0.05	
		C200H-OC226N	0.03	
		C200H-OC223	0.01	
		C200H-OC224	0.01	
		C200H-OC224N	0.01	
		Transistor Output Units	C200H-OD411	0.14
			C200H-OD213	0.14
			C200H-OD214	0.14
			C200H-OD216	0.01
	C200H-OD211		0.16	
	C200H-OD217		0.01	
	B7A Interface Units	C200H-OD212	0.18	
		C200H-OD21A	0.16	
	Triac Output Units	C200H-B7A01	0.10	
		C200H-B7A02	0.10	
	Triac Output Units	C200H-OA223	0.18	
		C200H-OA222V	0.20	
		C200H-OA224	0.27	
	CS1 Output Units	Relay Output Units	CS1W-OC201	0.10
			CS1W-OC211	0.13
Transistor Output Units		CS1W-OD211	0.17	
		CS1W-OD212	0.17	
		CS1W-OD231	0.27	
		CS1W-OD232	0.27	
		CS1W-OD261	0.39	
		CS1W-OD262	0.39	
		CS1W-OD291	0.48	
		CS1W-OD292	0.48	
Triac Output Units		CS1W-OA201	0.23 max. (0.07+0.02× No. of points ON)	
		CS1W-OA211	0.406 max. (0.07+0.021×No. of points ON)	
C200H Group-2 High-density Output Units		Transistor Output Units	C200H-OD218	0.27
			C200H-OD21B	0.48
	C200H-OD219		0.48	
CS1 I/O Units	DC Input/Transistor Output Units	CS1W-MD261	0.27	
		CS1W-MD262	0.27	
		CS1W-MD291	0.35	
		CS1W-MD292	0.35	
	TTL I/O Unit	CS1W-MD561	0.27	
C200H I/O Units	B7A Interface Units	C200H-B7A21	0.10	
		C200H-B7A22	0.10	
	Analog Timer Unit	C200H-TM001	0.06	

Note: This table may contain Units that are no longer in production