

Prior to Use

Auto Switches Common Specifications 1

⚠ Specific Product Precautions

Refer to the Auto Switch Precautions on pages 101 to 104 before using auto switches.

Auto Switches Common Specifications

Type	Reed auto switch	Solid state auto switch
Leakage current	None	3-wire: 100 μ A or less, 2-wire: 0.8 mA or less
Operating time	1.2 ms	1 ms or less
Impact resistance	300 m/s ²	1000 m/s ²
Insulation resistance	50 M Ω or more at 500 VDC Mega (Between lead wire and case)	
Withstand voltage	1500 VAC for 1 minute (Between lead wire and case)	1000 VAC for 1 minute (Between lead wire and case)
Ambient temperature	-10 to 60°C	
Enclosure	IEC60529 Standard IP67	

Lead Wire

Lead wire length indication
(Example)

D-M9BW **L**

● Lead wire length

Nil	0.5 m
M	1 m
L	3 m
Z	5 m

- Note 1) Lead wire length Z: 5 m
Applicable auto switches
Solid state auto switch: Manufactured upon receipt of order as standard.
- Note 2) 1 m (M): D-M9□(W)(V) only
- Note 3) Lead wire length tolerance

Lead wire length	Tolerance
0.5 m	\pm 15 mm
1 m	\pm 30 mm
3 m	\pm 90 mm
5 m	\pm 150 mm

Prior to Use

Auto Switches Common Specifications 2

⚠ Specific Product Precautions

Refer to the Auto Switch Precautions on pages 101 to 104 before using auto switches.

Auto Switch Hysteresis

Hysteresis is the distance between the position at which piston movement operates an auto switch to the position at which reverse movement turns the switch off. This hysteresis is included in part of the operating range (one side).

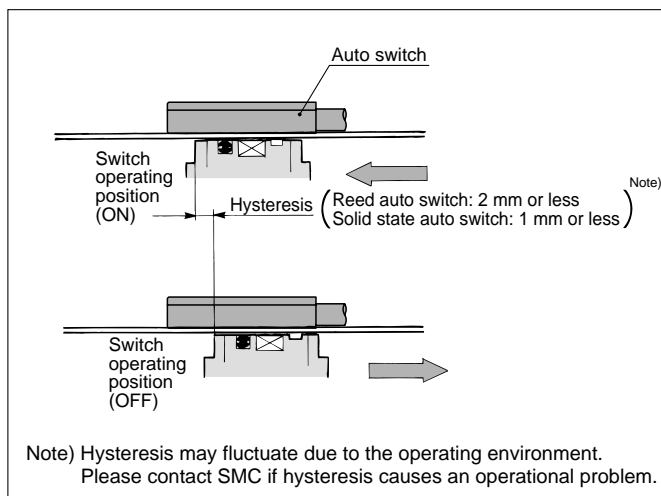

Contact Protection Box: CD-P11, CD-P12

<Applicable switch models>

D-A7/A8, D-A7□H/A80H, D-A73C/A80C, D-C7/C8, D-C73C/C80C, D-E7□A, E80A, D-Z7/Z8, D-9/9□A, D-A9/A9□V, and D-A79W type

The auto switches above do not have a built-in contact protection circuit. A contact protection box is not required for solid state auto switches due to their construction.

- ① Where the operation load is an inductive load.
- ② Where the wiring length to load is greater than 5 m.
- ③ Where the load voltage is 100/200 VAC.

Therefore, use a contact protection box with the switch for any of the above cases:

The contact life may be shortened (due to permanent energizing conditions.)

D-A72(H) must be used with the contact protection box regardless of load types and lead wire length since it is greatly affected by loads.

(Where the load voltage is 110 VAC)

When the load voltage is increased by more than 10% to the rating of applicable auto switches (except D-A73C/A80C/C73C/C80C/90/97/A79W) above, use a contact protection box (CD-P11) to reduce the upper limit of the load current by 10% so that it can be set within the range of the load current range, 110 VAC.

Even for the built-in contact protection circuit type (D-A34[A][C], D-A44[A][C], D-A54/A64, D-A59W, D-B59W), use the contact protection box when the wiring length to load is very long (over 30 m) and PLC (Programmable Logic Controller) with a large inrush current is used.

Contact Protection Box Specifications

Part no.	CD-P11		CD-P12
Load voltage	100 VAC or less	200 VAC	24 VDC
Max. load current	25 mA	12.5 mA	50 mA

* Lead wire length — Auto switch connection side 0.5 m
Load connection side 0.5 m

Contact Protection Box Internal Circuit

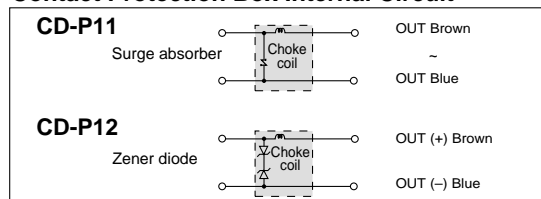

Contact Protection Box/Dimensions

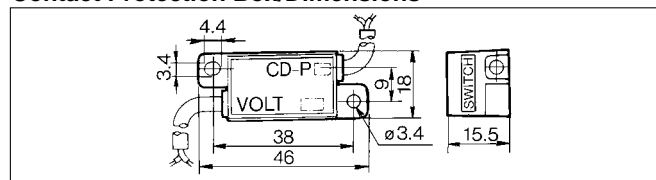

Contact Protection Box Connection

To connect a switch unit to a contact protection box, connect the lead wire from the side of the contact protection box marked SWITCH to the lead wire coming out of the switch unit. Keep the switch as close as possible to the contact protection box, with a lead wire length of no more than 1 meter.

XL□
XL□Q
XM□
XY□
D-□
XVD
XGT
CYV

Prior to Use

Auto Switches Connection and Example

Basic Wiring

Solid state 3-wire, NPN

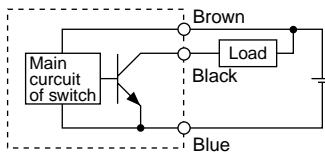

(Power supply for switch and load are separate)

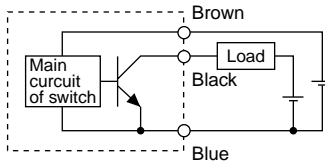

Solid state 3-wire, PNP

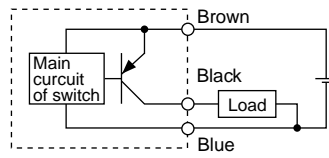

2-wire (Solid state)

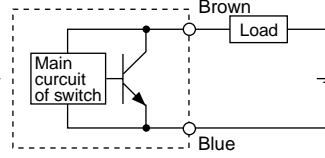

2-wire (Reed switch)

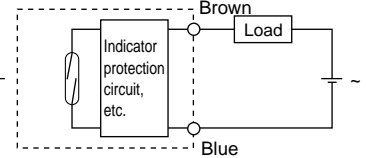

Example of Connection with PLC (Programmable Logic Controller)

• Sink input specifications 3-wire, NPN

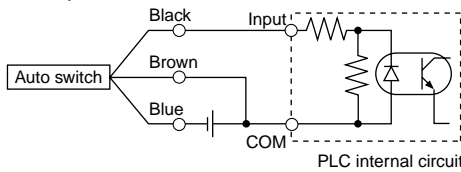

• Source input specifications 3-wire, PNP

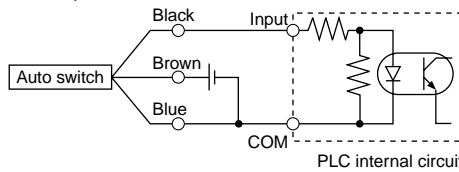

Connect according to the applicable PLC input specifications, as the connection method will vary depending on the PLC input specifications.

2-wire

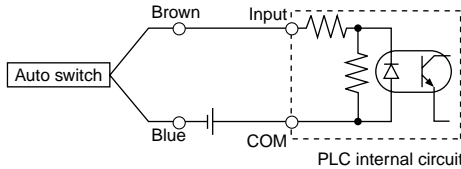

2-wire

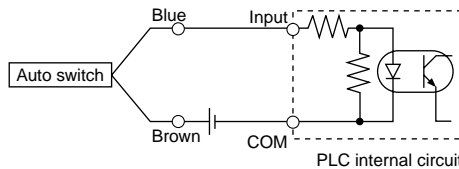

Example of AND (Series) and OR (Parallel) Connection

• 3-wire

AND connection for NPN output (Using relays)

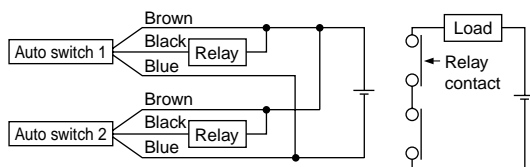

AND connection for NPN output (Performed with auto switches only)

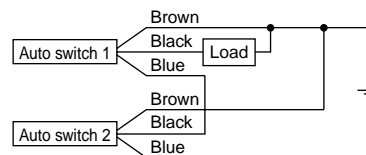

OR connection for NPN output

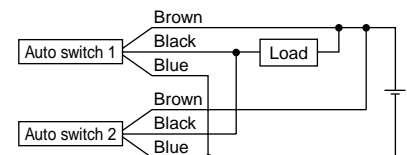

The indicator lights will light up when both auto switches are turned ON.

• 2-wire

2-wire with 2-switch AND connection

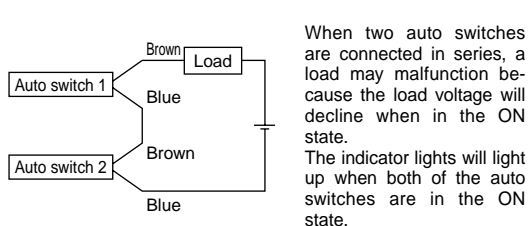

When two auto switches are connected in series, a load may malfunction because the load voltage will decline when in the ON state. The indicator lights will light up when both of the auto switches are in the ON state.

Load voltage at ON = Power supply voltage – Residual voltage x 2 pcs.
= 24 V – 4 V x 2 pcs.
= 16 V

Example: Power supply is 24 VDC
Internal voltage drop in auto switch is 4 V.

2-wire with 2-switch OR connection

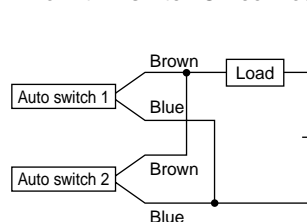

(Solid state auto switch) When two auto switches are connected in parallel, malfunction may occur because the load voltage will increase when in the OFF state.

Load voltage at OFF = Leakage current x 2 pcs. x Load impedance
= 1 mA x 2 pcs. x 3 kΩ
= 6 V

Example: Load impedance is 3 kΩ.
Leakage current from auto switch is 1 mA.

(Reed auto switch) Because there is no current leakage, the load voltage will not increase when turned OFF. However, depending on the number of auto switches in the ON state, the indicator lights may sometimes grow dim or not light up, due to the dispersion and reduction of the current flowing to the auto switches.

Solid State Auto Switch Direct Mounting Style D-M9N/D-M9P/D-M9B



Refer to SMC website for the details of the products conforming to the international standards.

Auto Switch Specifications

PLC: Programmable Logic Controller

D-M9□ (With indicator light)			
Auto switch model	D-M9N	D-M9P	D-M9B
Electrical entry direction	In-line	In-line	In-line
Wiring type	3-wire		2-wire
Output type	NPN	PNP	—
Applicable load	IC circuit, Relay, PLC		24 VDC relay, PLC
Power supply voltage	5, 12, 24 VDC (4.5 to 28 V)		
Current consumption	10 mA or less		
Load voltage	28 VDC or less	—	24 VDC (10 to 28 VDC)
Load current	40 mA or less		2.5 to 40 mA
Internal voltage drop	0.8 V or less at 10 mA (2 V or less at 40 mA)		4 V or less
Leakage current	100 μA or less at 24 VDC		0.8 mA or less
Indicator light	Red LED illuminates when turned ON.		
Standard	CE marking		

- Lead wires — Oilproof flexible heavy-duty vinyl cord: $\phi 2.7 \times 3.2$ ellipse, 0.15 mm², 2 cores (D-M9B), 3 cores (D-M9N, D-M9P)

Note 1) Refer to page 96 for solid state auto switch common specifications.

Note 2) Refer to page 96 for lead wire lengths.

Mass

(g)

Auto switch model	D-M9N	D-M9P	D-M9B	
Lead wire length (m)	0.5	8	8	7
	1	14	14	13
	3	41	41	38
	5	68	68	63

Dimensions

(mm)

D-M9□

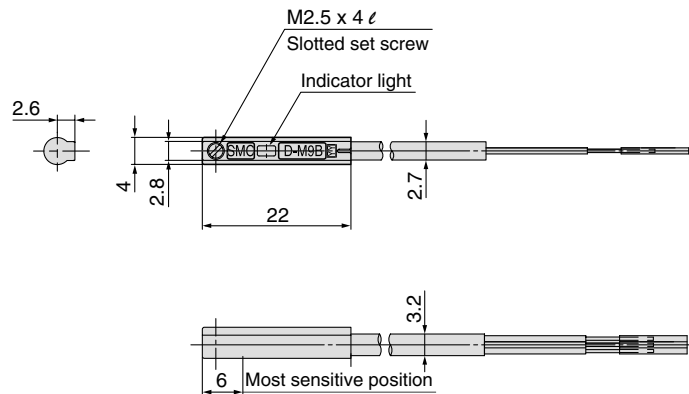

Grommet

- 2-wire load current is reduced (2.5 to 40 mA).
- Flexibility is 1.5 times greater than the conventional model (SMC comparison).
- Using flexible cable as standard spec.



Caution

Precautions

Fix the auto switch with the existing screw installed on the auto switch body. The auto switch may be damaged if a screw other than the one supplied is used.

Auto Switch Internal Circuit

D-M9N

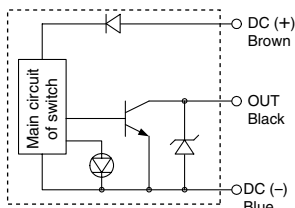

D-M9P

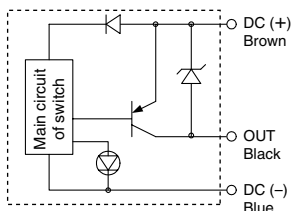

D-M9B

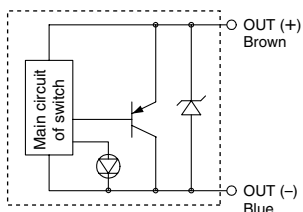

Reed Auto Switch Direct Mounting Style D-A90/D-A93/D-A96



Refer to SMC website for the details of the products conforming to the international standards.

Auto Switch Specifications

PLC: Programmable Logic Controller

Grommet



Caution

Precautions

Fix the auto switch with the existing screw installed on the auto switch body. The auto switch may be damaged if a screw other than the one supplied is used.

Auto Switch Internal Circuit

D-A90

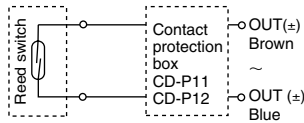

D-A93

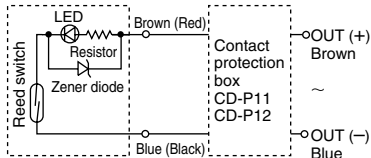

D-A96

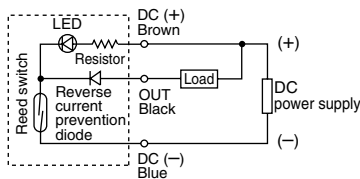

Note 1) Operating load is an induction load.
Note 2) Wiring to the load is 5 m or longer.
Note 3) Load voltage is 100 VAC.
Use the contact protection box in any of the above listed situations. The contact point life may decrease. (Refer to page 96 for contact protection box.)

D-A90 (Without indicator light)			
Auto switch model	D-A90		
Applicable load	IC circuit, Relay, PLC		
Load voltage	24 V _{DC} ^{AC} or less	48 V _{DC} ^{AC} or less	100 V _{DC} ^{AC} or less
Maximum load current	50 mA	40 mA	20 mA
Contact protection circuit	None		
Internal resistance	1 Ω or less (Including lead wire length of 3 m)		
Standard	CE marking		
D-A93, D-A96 (With indicator light)			
Auto switch model	D-A93	D-A96	
Applicable load	Relay, PLC		IC circuit
Load voltage	24 VDC	100 VAC	4 to 8 VDC
Load current range and Maximum load current ⁽³⁾	5 to 40 mA	5 to 20 mA	20 mA
Contact protection circuit	None		
Internal voltage drop	D-A93: 2.4 V or less (up to 20 mA)/ 3 V or less (up to 40 mA)		0.8 V or less
Indicator light	Red LED illuminates when turned ON.		
Standard	CE marking		

Lead wires

D-A90/D-A93—Oilproof heavy-duty vinyl cord, ø2.7, 0.18 mm² x 2 cores (Brown, Blue), 0.5 m

D-A96—Oilproof heavy-duty vinyl cord, ø2.7, 0.15 mm² x 3 cores (Brown, Black, Blue), 0.5 m

Note 1) Refer to page 96 for reed auto switch common specifications.

Note 2) Refer to page 96 for lead wire lengths.

Note 3) Under 5 mA, the strength of the indicator light is poor. In some cases, visibility of the indicator light will not be possible where the output signal is less than 2.5 mA. However, there is no problem in terms of contact output, when an output signal exceeds 1 mA or more.

Mass

(g)

Model	D-A90	D-A93	D-A96
Lead wire length (m)	0.5	6	8
	3	30	41

Dimensions

(mm)

D-A90/D-A93/D-A96

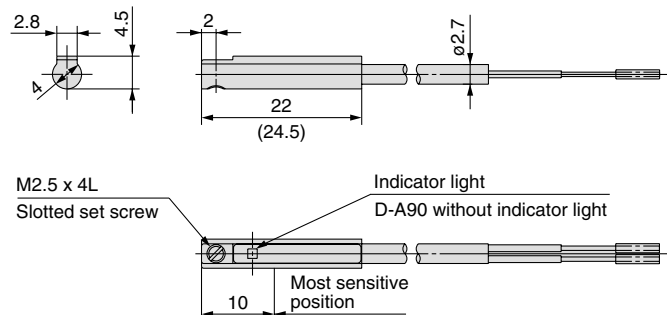

(): dimensions for D-A93.



Auto Switches Precautions 1

Be sure to read this before handling.

Design / Selection

Warning

1. Confirm the specifications.

Read the specifications carefully and use this product appropriately. The product may be damaged or malfunction if it is used outside the specification range for current load, voltage, temperature or impact.

We do not guarantee against any damage if the product is used outside of the specification range.

2. Cautions for use in an interlock circuit

When an auto switch is used for an interlock signal requiring high reliability, devise a double interlock system to avoid trouble by providing a mechanical protection function, or by also using another switch (sensor) together with the auto switch.

Also, perform periodic maintenance and confirm proper operation.

3. Do not make any modifications (including exchanging the printed circuit boards) to the product.

It may cause human injuries and accidents.

Caution

1. Pay attention to the length of time that a switch is ON at an intermediate stroke position.

When an auto switch is placed at an intermediate position of the stroke and a load is driven at the time the piston passes, the auto switch will operate, but if the speed is too great the operating time will be shortened and the load may not operate properly. The maximum detectable piston speed is:

$$V \text{ (mm/s)} = \frac{\text{Auto switch operating range (mm)}}{\text{Time load applied (ms)}} \times 1000$$

In cases of high piston speed, the use of an auto switch (D-F5NNTL, F7NNTL, G5NNTL, M5NNTL, M5PTL) with a built-in OFF delay timer (≈ 200 ms) makes it possible to extend the load operating time.

The wide-range detection type D-G5NBL (operating range 35 to 50 mm) may also be useful, depending on the application. Please consult with SMC for other models.

2. Keep wiring as short as possible.

<Reed>

As the length of the wiring to a load gets longer, the rush current at switching ON becomes greater, and this may shorten the product's life. (The switch will stay ON all the time.)

1) Use a contact protection box when the wire length is 5 m or longer.

2) Even if an auto switch has a built-in contact protection circuit, when the wiring is more than 30 m long, it is not able to adequately absorb the rush current and its life may be reduced. It is again necessary to connect a contact protection box in order to extend its life. Please consult with SMC in this case.

Caution

<Solid state>

3) Although wire length should not affect switch function, use a wire 100 m or shorter.

If the wiring is longer it will likely increase noise although the length is less than 100 m.

When the wire length is long, we recommend the ferrite core is attached to the both ends of the lead wire to prevent excess noise.

A contact protection box is not necessary for solid state switches due to the nature of this product construction.

3. Do not use a load that generates surge voltage. If a surge voltage is generated, the discharge occurs at the contact, possibly resulting in the shortening of product life.

If driving a load such as a relay that generates a surge voltage,

<Reed>

Use an auto switch with built-in contact protection circuit or use a contact protection box.

<Solid state>

Use a built-in surge absorbing element type device.

4. Take precautions when multiple cylinders/actuators are used close together.

When multiple auto switch cylinders/actuators are used in close proximity, magnetic field interference may cause the auto switches to malfunction. Maintain a minimum cylinder separation of 40 mm. (When the allowable interval is specified for each cylinder series, use the indicated value.)

The auto switches may malfunction due to the interference from the magnetic fields.

Use of a magnetic screen plate (MU-S025) or commercially available magnetic screen tape can reduce the interference of magnetic force.

5. Pay attention to the internal voltage drop of the auto switch.

<Reed>

1) Auto switch with an indicator light (Except D-A56, A76H, A96, A96V, C76, E76A, Z76)

• If auto switches are connected in series as shown below, take note that there will be a large voltage drop because of internal resistance in the light emitting diodes. (Refer to the internal voltage drop in the auto switch specifications.) [The voltage drop will be "n" times larger when "n" auto switches are connected.]

Even though an auto switch operates normally, the load may not operate.



• In the same way, when operating under a specified voltage, although an auto switch may operate normally, the load may not operate. Therefore, the formula below should be satisfied after confirming the minimum operating voltage of the load.

$$\text{Supply voltage} - \text{Internal voltage drop of auto switch} > \text{Minimum operating voltage of load}$$

XL□

XL□Q

XM□
XY□

D-□

XVD

XGT

CYV



Auto Switches Precautions 2

Be sure to read this before handling.

Design / Selection

⚠ Caution

2) If the internal resistance of a light emitting diode causes a problem, select an auto switch without an indicator light (D-A6□, A80, A80H, A90, A90V, C80, R80, 90, E80A, Z80).

<Solid state/2-wire type>

3) Generally, the internal voltage drop will be greater with a 2-wire solid state auto switch than with a reed auto switch. Take the same precautions as in 1).

Also, take note that a 12 VDC relay is not applicable.

6. Pay attention to leakage current.

<Solid state/2-wire type>

Current (leakage current) flows to the load to operate the internal circuit when in the OFF state.

Operating current of load (OFF condition) > Leakage current

If the criteria given in the above formula are not met, it will not reset correctly (stays ON). Use a 3-wire auto switch if this specification will not be satisfied.

Moreover, leakage current flow to the load will be “n” times larger when “n” auto switches are connected in parallel.

7. Ensure sufficient clearance for maintenance activities.

When designing an application, be certain to allow sufficient clearance for maintenance.

8. When multiple auto switches are required.

“n” indicates the number of auto switches which can be physically mounted on the cylinders/actuators. Detection intervals depends on the auto switch mounting structure and set position, therefore some required interval and set positions may not be available.

9. Limitations of detectable positioning

When using certain mounting brackets, the surface and position where an auto switch can be mounted maybe restricted due to physical interference. For example, when using some bracket types the auto switch cannot be surface mounted at the bottom side of foot bracket, etc.

Select the set position of the auto switch so that it does not interfere with the mounting bracket of the cylinders/actuators (such as trunnion or reinforcement ring).

10. Use the cylinder and auto switch in proper combination.

The auto switch is pre-adjusted to activate properly for an auto-switch-capable SMC cylinder/actuator.

If the auto switch is mounted improperly, used for another brand of cylinders/actuators or used after the alternation of the machine installation, the auto switch may not activate properly.

Mounting / Adjustment

⚠ Caution

1. Do not drop or bump.

Do not drop, bump or apply excessive impacts (300 m/s² or more for reed auto switches and 1000 m/s² or more for solid state auto switches) while handling. Although the body of the auto switch may not be damaged, the inside of the auto switch could be damaged and cause malfunction.

2. Observe the proper tightening torque for mounting an auto switch.

When an auto switch is tightened beyond the range of tightening torque, auto switch mounting screws, auto switch mounting brackets or auto switch may be damaged.

On the other hand, tightening below the range of tightening torque may allow the auto switch to slip out of position.

3. Do not carry a cylinder by the auto switch lead wires.

Never carry a cylinder by its lead wires. This may not only cause broken lead wires, but it may cause internal elements of the auto switch to be damaged by the stress.

4. Fix the auto switch with appropriate screw installed on the switch body. If using other screws, auto switch may be damaged.

5. Mount an auto switch at the center of the operating range. In the case of 2-color display auto switch, mount it at the center of the green LED illuminating range.

Adjust the mounting position of the auto switch so that the piston stops at the center of the operating range. (The mounting position shown in the catalog indicates the optimum position at stroke end.)

If mounted at the end of the operating range (around the borderline of ON and OFF), operation will be unstable depending on the operating environment. Also there are some cylinders or actuators with individual setting methods for auto switches. If so, mount it in accordance with the indicated method.

Even if 2-color indication solid state auto switches are fixed at a proper operating range (the green light lights up), the operation may become unstable depending on the installation environment or magnetic field disturbance.

(Magnetic body, external magnetic field, proximal installation of cylinders with built-in magnet and actuators, temperature change, other factors for magnetic force fluctuation during operation, etc.)



Auto Switches Precautions 3

Be sure to read this before handling.

Wiring

⚠ Caution

1. Confirm proper insulation of wiring.

Be certain that there is no faulty wiring insulation (contact with other circuits, ground fault, improper insulation between terminals, etc.). Damage may occur due to excess current flow into a switch.

2. Do not wire with power lines or high voltage lines.

Wire separately from power lines or high voltage lines, avoiding parallel wiring or wiring in the same conduit with these lines. Control circuits containing auto switches may malfunction due to noise from these other lines.

3. Avoid repeatedly bending or stretching lead wires.

Broken lead wires will result from repeatedly applying bending stress or stretching force to the lead wires. Stress and tensile force applied to the connection between the lead wire and auto switch increases the possibility of disconnection. Keep the lead wire from moving especially in the area where it connects with the auto switch.

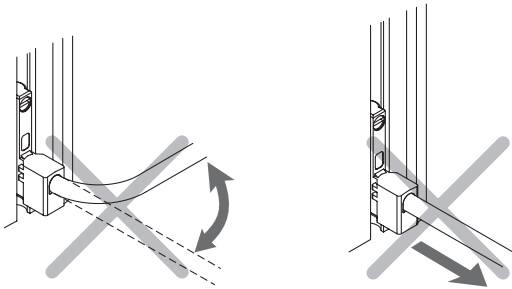

4. Be certain to connect the load before power is applied.

<2-wire type>

If the power is turned ON when an auto switch is not connected to a load, the auto switch will be instantly damaged because of excess current (short circuit). It is the same as when the 2-wire brown lead wire (+, output) is directly connected to the (+) power supply terminal.

5. Do not allow short-circuit of loads.

<Reed>

If the power is turned ON with a load in a short circuited condition, the auto switch will be instantly damaged because of excess current flow into the switch.

<Solid state>

All models of D-J51, G5NB and PNP output type auto switches do not have built-in short circuit protection circuits. If a load is short circuited, the auto switch will be instantly damaged as in the case of reed auto switches. Take special care to avoid reverse wiring with the brown power supply line and the black output line on 3-wire type auto switches.

6. Avoid incorrect wiring.

<Reed>

A 24 VDC auto switch with indicator light has polarity. The brown lead wire or terminal No. 1 is (+), and the blue lead wire or terminal No. 2 is (-).

[For D-97, (+) is on the no-displayed side, (-) is on the black line side.]

1) If connections are reversed, an auto switch will operate, however, the light emitting diode will not light up. Also, take note that a current greater than that specified will damage a light emitting diode and it will no longer operate.

Applicable model:

D-A73, A73H, A73C, C73, C73C, E73A, Z73

D-R73, R73C, 97, 93A, A93, A93V

D-A33, A34, A33A, A34A, A44, A44A

D-A53, A54, B53, B54

2) When using a 2-color indicator type auto switch (D-A79W, A59W and B59W), the auto switch will constantly remain ON if the connections are reversed.

<Solid state>

1) If connections are reversed on a 2-wire type auto switch, the auto switch will not be damaged if protected by a protection circuit, but the auto switch will always stay in an ON state. However, it is still necessary to avoid reversed connections, since the auto switch could be damaged by a load short circuit in this condition.

2) If connections are reversed (power supply line + and power supply line -) on a 3-wire type auto switch, the auto switch will be protected by a protection circuit. However, if the power supply line (+) is connected to the blue wire and the power supply line (-) is connected to the black wire, the auto switch will be damaged.

7. When the lead wire sheath is stripped, confirm the stripping direction. The insulator may be split or damaged depending on the direction. (D-M9□ only)

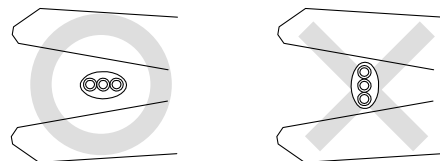

Recommended Tool

Description	Model
Wire stripper	D-M9N-SWY

* Stripper for a round cable (ø2.0) can be used for a 2-wire type cable.

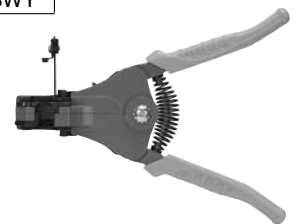

XL□

XL□Q

XM□
XY□

D-□

XVD

XGT

CYV



Auto Switches Precautions 4

Be sure to read this before handling.

Operating Environment

⚠ Warning

1. Never use in an atmosphere of explosive gases.

The structure of auto switches is not intended to prevent explosion. Never use in an atmosphere with an explosive gas since this may cause a serious explosion.

Please contact SMC concerning ATEX compliant products.

⚠ Caution

1. Do not use in an area where a magnetic field is generated.

Auto switches will malfunction or magnets inside cylinders/actuators will become demagnetized. (Please consult with SMC if a magnetic field resistant auto switch can be used.)

2. Do not use in an environment where the auto switch will be continually exposed to water.

Although auto switches satisfy IEC standard IP67 construction except some models (D-A3□, A44□, G39□, K39□, RNK, RPK) do not use auto switches in applications where continually exposed to water splash or spray. Poor insulation or swelling of the potting resin inside auto switches may cause malfunction.

3. Do not use in an environment with oil or chemicals.

Please consult with SMC if auto switches will be used in an environment with coolant, cleaning solvent, various oils or chemicals. If auto switches are used under these conditions for even a short time, they may be adversely affected by improper insulation, malfunction due to swelling of the potting resin, or hardening of the lead wires.

4. Do not use in an environment with temperature cycles.

Please consult with SMC if auto switches are used where there are temperature cycles other than normal temperature changes, as there may be adverse effects inside the auto switches.

5. Do not use in an environment where there is excessive impact shock.

<Reed>

When excessive impact (300 m/s² or more) is applied to a reed auto switch during operation, the contact point will malfunction and generate or cut off a signal momentarily (1 ms or less). Please consult with SMC if a solid state auto switch can be used according to the environment.

6. Do not use in an area where surges are generated.

<Solid state>

When there are units (solenoid type lifter, high frequency induction furnace, motor, radio equipment etc.) which generate a large amount of surge in the area around cylinders/actuators with solid state auto switches, this may cause deterioration or damage to the auto switch's internal circuit elements. Avoid sources of surge generation and disorganized lines.

⚠ Caution

7. Avoid accumulation of iron waste or close contact with magnetic substances.

When a large amount of iron waste such as machining chips or spatter is accumulated, or a magnetic substance (something attracted by a magnet) is brought into close proximity with a cylinder with auto switches, or an actuator, it may cause the auto switch to malfunction due to a loss of the magnetic force inside the cylinder/actuator.

8. Please contact SMC concerning water resistance, elasticity of lead wires, usage at welding sites, etc.

9. Do not use in direct sunlight.

10. Do not mount the product in locations where it is exposed to radiant heat.

Maintenance

⚠ Warning

1. Removal of equipment, and supply/exhaust of compressed air

Before any machinery or equipment is removed, first ensure that the appropriate measures are in place to prevent the fall or erratic movement of driven objects and equipment, then cut off the electric power and reduce the pressure in the system to zero. Only then should you proceed with the removal of any machinery and equipment.

When machinery is restarted, proceed with caution after confirming that appropriate measures are in place to prevent actuators from moving suddenly.

⚠ Caution

1. Perform the following maintenance periodically in order to prevent possible danger due to unexpected auto switch malfunction.

1) Secure and tighten auto switch mounting screws.

If screws become loose or the mounting position is dislocated, retighten them after readjusting the mounting position.

2) Confirm that there is no damage to lead wires.

To prevent faulty insulation, replace auto switches or repair lead wires, etc., if damage is discovered.

3) Confirm the display of the green light on the 2-color display auto switch.

Confirm that the piston stops at the center of the operating range (the green LED is on). If the red LED is on, the mounting position is not appropriate.

Readjust to the center of the operating range. Also there are some cylinders or actuators with individual setting methods for auto switches. If so, mount it in accordance with the indicated method.