

22.5 mm Modular Pushbuttons—M22



Product Description

Eaton’s M22 industrial heavy-duty pushbutton line offers a wide array of functional, attractive and ergonomically designed illuminated and non-illuminated pushbuttons, selector switches, push-pulls, alternate action and twist-to-release operators. The complete illuminated line is only offered in LED light units to ensure high-quality brightness and up to 100,000 hours of LED illumination. M22 operators are available with either a silver or black nylon colored or chrome metal bezel. The space-saving modular construction of the M22 line makes on-the-job assembly fast and simplifies the stocking of both components and complete devices.

NEW

Eaton has expanded M22 pilot devices with a metal bezel option. The new M22M pushbutton is an elegant chrome metal bezel that is attractive, durable and rugged for heavy-duty environments. M22M devices are configurable and complement components within the M22 line.

Highly Modular and Versatile Line

- Field convertible functions (pushbuttons and selector switches), maintained to momentary
- Customizable laser engraving capabilities

LED Indicators

- 100,000 hours of life in high-vibration environments
- Lenses specifically designed for LED illumination

Rugged Design

- Most pushbutton operators and contact blocks exceed 5 million mechanical operations
- All components have IP66 rating, and some carry IP67 and IP69K for washdown environment; see **Page V7-T1-119** for further technical data

Innovative Technologies

- ASi communicating devices
- Palm switches

Contents

Description

Page

22.5 mm Modular Pushbuttons—M22	
Product Selection Guide	V7-T1-48
Accessories	V7-T1-111
Coding Adapter Guide	V7-T1-118
Technical Data and Specifications	V7-T1-119
Dimensions	V7-T1-123
Symbols Library.	V7-T1-129



Standards and Certifications

All operators and components are IEC/EN 60947 VDE 0660.

All operators carry an IP66 rating with some rated for washdown environment with IP67 and IP69K.

All pushbuttons, emergency-stops, indicating lights, potentiometers and selector switches carry NEMA 4X, 13.

Marine classification societies: Bureau Veritas (BV), Germanischer Lloyd (GL), and Lloyd’s Register of Shipping (LR) approved.



1

Features

- Field convertible pushbuttons and mushroom operators from maintained to momentary status
- Field convertible selector switches from momentary to maintained operation and vice versa
- LED offering only for all illuminated operators
- Laser engraved pushbuttons, lenses and enclosures
- Heavy-duty construction with a minimum of IP66 and UL NEMA® type 4X / 13 on front of panel operators. Many operators even carry IP67 and IP69K, for the toughest applications
- Silver, black or chrome metal bezel now available
- Snap-lock contact blocks and light units for front or base mounting
- Notched hole mounting with anti-rotation tab and central nut mounting on each operator
- Over 5 million mechanical operations and 1.6 million electrical (reference specification sheet)
- Direct opening action normally closed contacts
- Unique and innovative offerings, such as four-way pushbuttons and USB/ RJ45 bulkhead interfaces
- Screw or spring-cage terminals

Benefits

- Modular construction makes assembly fast and simplifies stocking of components and complete devices
- Field convertibility of operator status for pushbuttons and selector switches helps distributors and customers reduce inventory and increase functionality
- LED offering only for improved brightness quality and up to 100,000 hours of operation
- Plastic construction is corrosion resistant. Operators are designed for rugged environments, ideal for washdown applications (reference each operator's IP ratings and IEC/EN 60529 for ingress protection definition)
- Anti-rotation tab saves installation time and prevents operator rotation
- High mechanical and electrical life allows for use in tough and challenging applications
- Laser inscription capabilities allow for high-quality, wear-resistant markings
- All normally closed (NC) contacts are direct opening action, i.e., NC contacts are physically forced open by direct linkage with the pushbutton operator in the unlikely event of contact weld
- Some M22 operators are capable of communication via ASi protocol
- M22 offers USB and RJ45 connections

Product Selection Guide

Pushbuttons



Description	Non-illuminated, flush		Non-illuminated, extended		Illuminated, flush		Illuminated, extended	
Operator	Momentary	Maintained	Momentary	Maintained	Momentary	Maintained	Momentary	Maintained
Product Selection	Pages V7-T1-53 to V7-T1-55	Pages V7-T1-56, V7-T1-57	Pages V7-T1-58, V7-T1-59	Pages V7-T1-60, V7-T1-61	Pages V7-T1-63 to V7-T1-65	Pages V7-T1-66, V7-T1-67	Pages V7-T1-68, V7-T1-69	Pages V7-T1-70, V7-T1-71

Indicating Lights



Description	Flat	Conical
Product Selection	Pages V7-T1-72, V7-T1-73	Pages V7-T1-72, V7-T1-73

Emergency Stops



Description	Non-illuminated	Illuminated	Key release	Mechanical indication
Product Selection	Page V7-T1-75	Page V7-T1-75	Page V7-T1-76	Page V7-T1-76

Selector Switches



Description	Non-illuminated knob type	Non-illuminated rotary type	Illuminated	Key-operated
Product Selection	Pages V7-T1-80, V7-T1-81	Pages V7-T1-82, V7-T1-83	Pages V7-T1-85 to V7-T1-87	Pages V7-T1-88 to V7-T1-91

Mushroom Head Pushbuttons



Description	Non-illuminated	Non-illuminated
Operator	Momentary	Maintained
Product Selection	Pages V7-T1-94, V7-T1-95	Pages V7-T1-96, V7-T1-97

Double Pushbuttons



Description	Extended pushbuttons and center light	Flush top and center light, extended bottom	Flush pushbuttons and center light
Operator	Momentary	Momentary	—
Product Selection	Page V7-T1-99	Page V7-T1-100	Page V7-T1-100

Four-Way Pushbuttons



Description	Non-interlocked	Interlocked
Operator	Momentary	Maintained
Product Selection	Page V7-T1-103	Page V7-T1-103

Joysticks



Description	Joysticks
Product Selection	Page V7-T1-104

Potentiometers



Description	Potentiometers
Product Selection	Page V7-T1-106

Acoustic Devices



Description	Acoustic devices
Product Selection	Page V7-T1-106

Through-the-Door Operators



Description	Through-the-door operators
Product Selection	Page V7-T1-107

Bulkhead Interfaces



Description	Bulkhead interfaces
Product Selection	Page V7-T1-107

ASi Adapter Modules



Description	ASi adapter modules
Product Selection	Page V7-T1-108

Palm Switches



Description	Palm switches
Product Selection	Page V7-T1-109

Assembled Control Stations



Description	Assembled control stations
Product Selection	Page V7-T1-16

M22-



Point-of-Purchase Units

Color	Type	Contact Configuration ^①	Catalog Number
Black	Flush momentary	NO/NC	M22-D-S-K11-P
Red	Extended momentary	NO/NC	M22-DH-R-K11-P
Green	Flush momentary	NO/NC	M22-D-G-K11-P
Red	Ext. illuminated (12–30V) momentary	NO/NC	M22-DLH-R-K11-R-P
Red	Ext. illuminated (85–264V) momentary	NO/NC	M22-DLH-R-K11-230R-P
White	Flush illuminated (12–30V) maintained	NO/NC	M22-DRL-W-K11-W-P
White	Flush illuminated (85–264V) maintained	NO/NC	M22-DRL-W-K11-230W-P
Red	Indicating light (12–30V)	—	M22-L-R-R-P
Green	Indicating light (12–30V)	—	M22-L-G-G-P
Red	Indicating light (85–264V)	—	M22-L-R-230R-P
Green	Indicating light (85–264 Vac)	—	M22-L-G-230G-P
Red	Twist-to-release E-stop	1NO/2NC	M22-PVT-K12-P
Red	Illuminated (12–30V) push-pull E-stop	1NO/2NC	M22-PVL-K12-R-P
Red	Illuminated (85–264V) push-pull E-stop	1NO/2NC	M22-PVL-K12-230R-P
—	Two-position maintained V selector switch	NO/NC	M22-WKV-K11-P
—	Three-position momentary selector switch	NO/NC	M22-WK3-K22-P

Note

① All NC contact blocks are positively driven contact. ⊖

Pushbuttons—Non-Illuminated and Illuminated



Contents

Description

Page

Pushbuttons—Non-Illuminated and Illuminated	
Non-Illuminated, Flush, Momentary	V7-T1-53
Non-Illuminated, Flush, Maintained	V7-T1-56
Non-Illuminated, Extended, Momentary	V7-T1-58
Non-Illuminated, Extended, Maintained	V7-T1-60
Illuminated, Flush, Momentary	V7-T1-63
Illuminated, Flush, Maintained	V7-T1-66
Illuminated, Extended, Momentary	V7-T1-68
Illuminated, Extended, Maintained	V7-T1-70

Pushbuttons—Non-Illuminated and Illuminated

Product Description

Eaton’s M22 pushbutton line is a complete, modular and versatile offering. From field-convertible maintained operators to customizable laser engraved buttons, the M22 pushbutton line provides endless opportunity for flexibility and reduced inventory. Each operator type provides options for ordering as complete or component parts allowing for a perfect fit for each application. All of this flexibility comes in a very rugged design.

Features

- Field convertible from maintained to momentary (available on maintained pushbuttons only)
- Customizable laser engraving on all buttons
- LED offering only for improved brightness quality and up to 100,000 hours of operation
- More than five million mechanical operations on momentary and 1 million on maintained pushbuttons
- Modular construction makes assembly fast and simplifies stocking of components and complete devices
- Capable of communicating via ASi protocol with ASi adapter modules

Protection Type

- IP67, IP69K
- NEMA 4X, 13

Catalog Number Selection

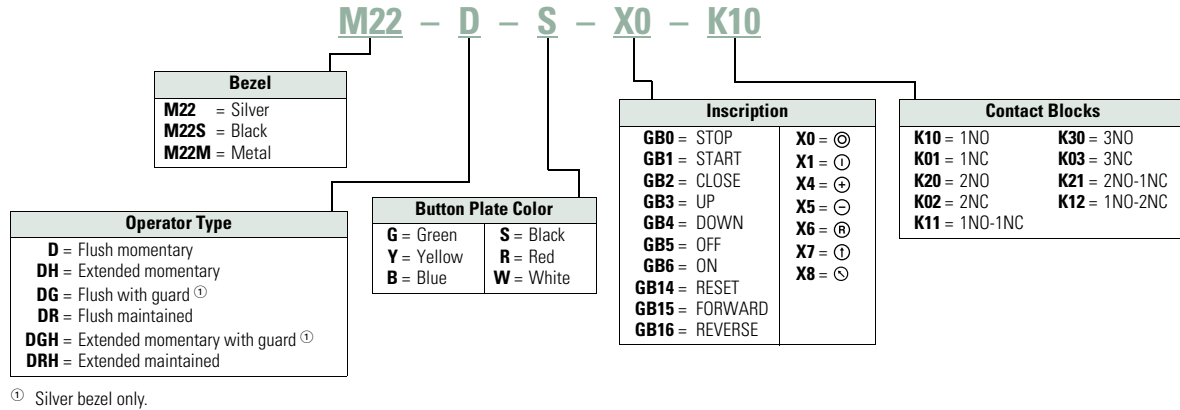

Catalog Number Selection is for illustrative purposes only and not to be used to create new catalog numbers.

Non-Illuminated Pushbuttons



Product Selection

Non-Illuminated Pushbuttons, Flush, Momentary

	Complete Devices				
M22-D-G-K10	Button Color	Contact Block Configuration ①	Silver Bezel Catalog Number	Black Bezel Catalog Number	Metal Bezel Catalog Number
	Black	NO	M22-D-S-K10	M22S-D-S-K10	M22M-D-S-K10
		NC	M22-D-S-K01	M22S-D-S-K01	M22M-D-S-K01
		2NO	M22-D-S-K20	M22S-D-S-K20	M22M-D-S-K20
		2NC	M22-D-S-K02	M22S-D-S-K02	M22M-D-S-K02
		1NO-1NC	M22-D-S-K11	M22S-D-S-K11	M22M-D-S-K11
	Red	NO	M22-D-R-K10	M22S-D-R-K10	M22M-D-R-K10
		NC	M22-D-R-K01	M22S-D-R-K01	M22M-D-R-K01
		2NO	M22-D-R-K20	M22S-D-R-K20	M22M-D-R-K20
		2NC	M22-D-R-K02	M22S-D-R-K02	M22M-D-R-K02
		1NO-1NC	M22-D-R-K11	M22S-D-R-K11	M22M-D-R-K11
	Green	NO	M22-D-G-K10	M22S-D-G-K10	M22M-D-G-K10
		NC	M22-D-G-K01	M22S-D-G-K01	M22M-D-G-K01
		2NO	M22-D-G-K20	M22S-D-G-K20	M22M-D-G-K20
		2NC	M22-D-G-K02	M22S-D-G-K02	M22M-D-G-K02
		1NO-1NC	M22-D-G-K11	M22S-D-G-K11	M22M-D-G-K11

Note

① All NC contact blocks are positively driven contact. ⊖

1

Non-Illuminated Pushbuttons, Flush, Momentary

M22-D-G



Operators Only ^①

Button Color	Inscription	Silver Bezel Catalog Number	Black Bezel Catalog Number	Metal Bezel Catalog Number
Black	—	M22-D-S	M22S-D-S	M22M-D-S
Red	—	M22-D-R	M22S-D-R	M22M-D-R
	STOP	M22-D-R-GB0	M22S-D-R-GB0	—
	⊙	M22-D-R-X0	M22S-D-R-X0	M22M-D-R-X0
Green	—	M22-D-G	M22S-D-G	M22M-D-G
	START	M22-D-G-GB1	M22S-D-G-GB1	M22M-D-G-GB1
	①	M22-D-G-X1	M22S-D-G-X1	M22M-D-G-X1
White	—	M22-D-W	M22S-D-W	M22M-D-W
Blue	—	M22-D-B	M22S-D-B	M22M-D-B
Yellow	—	M22-D-Y	M22S-D-Y	M22M-D-Y
—	—	M22-D-X-SRSG ^②	M22S-D-X-SRSG ^②	M22M-D-X-SRSG ^②
	—	M22-D-X-SWRGYB ^③	M22S-D-X-SWRGYB ^③	M22M-D-X-SWRGYB ^③

M22S-D-G



M22M-D-G



M22-DG-G



Silver Guarded

Button Color	Inscription	Silver Bezel Catalog Number
Black	—	M22-DG-S
Red	—	M22-DG-R
Green	—	M22-DG-G
White	—	M22-DG-W
Blue	—	M22-DG-B
Yellow	—	M22-DG-Y
—	—	M22-DG-X-SRSG ^②
	—	M22-DG-X-SWRGYB ^③

Notes

- ① Includes contact block mounting adapter.
- ② Buttonless operator comes with three color buttons (black, red, green).
- ③ Buttonless operator comes with all six color buttons (black, white, red, green, yellow, blue).

Non-Illuminated Pushbuttons, Flush, Momentary

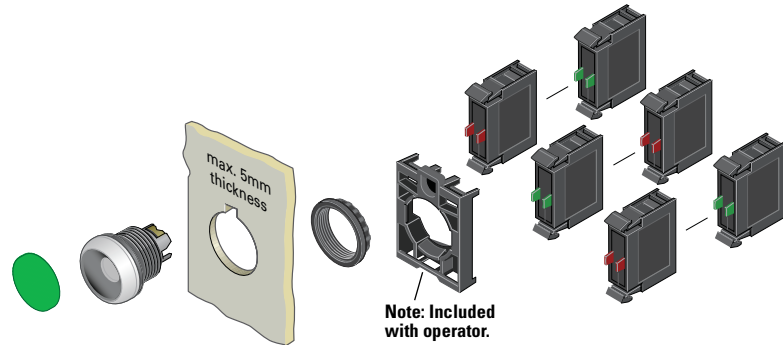

Components

M22-XD-G



Button Plates ^①

Color	Inscription	Catalog Number
Black	—	M22-XD-S ^②
	Custom	M22-XD-S-ETCH ^③
	STOP	M22-XD-S-GB0
	START	M22-XD-S-GB1
	CLOSE	M22-XD-S-GB2
	UP	M22-XD-S-GB3
	DOWN	M22-XD-S-GB4
	OFF	M22-XD-S-GB5
	ON	M22-XD-S-GB6
	TEST	M22-XD-S-GB9
	FORWARD	M22-XD-S-GB15
	REVERSE	M22-XD-S-GB16
	RAISE	M22-XD-S-GB17
	LOWER	M22-XD-S-GB18
	Ⓞ	M22-XD-S-X0
	Ⓛ	M22-XD-S-X1
	Ⓜ	M22-XD-S-X2
+	M22-XD-S-X4	
−	M22-XD-S-X5	
Ⓛ	M22-XD-S-X7	
Red	—	M22-XD-R ^②
	Custom	M22-XD-R-ETCH ^③
	STOP	M22-XD-R-GB0
	OFF	M22-XD-R-GB5
	Ⓞ	M22-XD-R-X0
Green	—	M22-XD-G ^②
	Custom	M22-XD-G-ETCH ^③
	START	M22-XD-G-GB1
	ON	M22-XD-G-GB6
Blue	—	M22-XD-B ^②
	Custom	M22-XD-B-ETCH ^③
	RESET	M22-XD-B-GB14
	Ⓜ	M22-XD-B-X6
White	—	M22-XD-W ^②
	Custom	M22-XD-W-ETCH ^③
	START	M22-XD-W-GB1
	Ⓛ	M22-XD-W-X1
Yellow	—	M22-XD-Y ^②
	Custom	M22-XD-Y-ETCH ^③
Black, red, green	—	M22-XD-SRGR
Black, white, red, green, yellow, blue	—	M22-XD-SWRGVB

M22-D-X



M22S-D-X



M22M-D-X



Buttonless Operator

Silver Bezel Catalog Number ^④	Black Bezel Catalog Number ^④	Metal Bezel Catalog Number ^④
M22-D-X	M22S-D-X	M22M-D-X

M22-DG-X



Silver Guarded

Silver Bezel Catalog Number ^④
M22-DG-X

M22-K10



Contact Blocks ^①

Terminal Type	Contact Configuration ^⑤	Catalog Number
Screw	NO	M22-K10
	NO, early-make	M22-K10P
	NC	M22-K01
	NC, late-break	M22-K01D
Spring-cage	NO	M22-CK10
	NC	M22-CK01
	NC, late-break	M22-CK01D
	2NO	M22-CK20
	2NC	M22-CK02
	NO-NC	M22-CK11

Notes

- For complete listing of available button plates and contact blocks, see Accessories, Pages V7-T1-111 to V7-T1-116.
- Minimum order quantity of (10).
- When ordering, specify inscription per catalog number suffix from the Symbols Library (see Pages V7-T1-129 to V7-T1-136) into the Order Notes. For example, M22-XD-S-ETCH; Order Notes: Mark with symbol X91, Line item #_.
- Includes contact block mounting adapter.
- All NC contact blocks are positively driven contact. Ⓞ

1

Non-Illuminated Pushbuttons, Flush, Maintained ^①

M22-DR-S



M22S-DR-S



M22M-DR-S



Operators Only ^②

Button Color	Silver Bezel Catalog Number	Black Bezel Catalog Number	Metal Bezel Catalog Number
Black	M22-DR-S	M22S-DR-S	M22M-DR-S
Red	M22-DR-R	M22S-DR-R	M22M-DR-R
Green	M22-DR-G	M22S-DR-G	M22M-DR-G
White	M22-DR-W	M22S-DR-W	M22M-DR-W
Blue	M22-DR-B	M22S-DR-B	M22M-DR-B
Yellow	M22-DR-Y	M22S-DR-Y	M22M-DR-Y
③	M22-DR-X-SRG	M22S-DR-X-SRG	M22M-DR-X-SRG
④	M22-DR-X-SWRGYB	M22S-DR-X-SWRGYB	M22M-DR-X-SWRGYB

Notes

- ① Maintained pushbuttons can be converted in the field to momentary operation by switching the locking ring, which is accessible through the side of the operator body.
- ② Includes contact block mounting adapter.
- ③ Buttonless operator comes with three color buttons (black, red, green).
- ④ Buttonless operator comes with all six color buttons (black, white, red, green, yellow, blue).

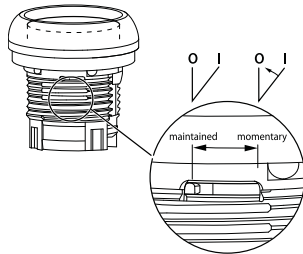

Note: This pilot device features a selectable function switch that enables the device to be set to either maintained or momentary operation.

Non-Illuminated Pushbuttons, Flush, Maintained ^①

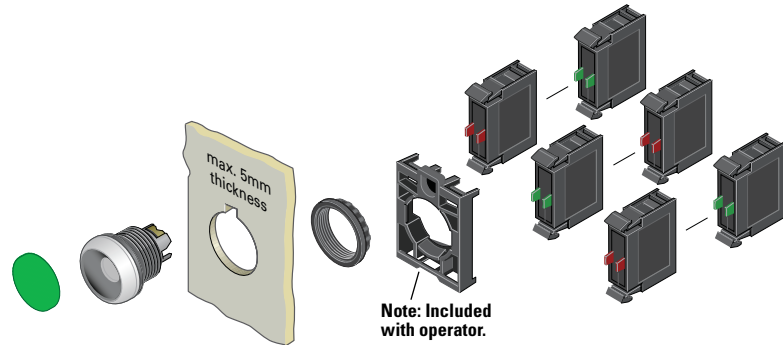

Components

M22-XD-S



Button Plates ^②

Color	Inscription	Catalog Number
Black	—	M22-XD-S ^③
	Custom	M22-XD-S-ETCH ^④
	STOP	M22-XD-S-GB0
	START	M22-XD-S-GB1
	CLOSE	M22-XD-S-GB2
	UP	M22-XD-S-GB3
	DOWN	M22-XD-S-GB4
	OFF	M22-XD-S-GB5
	ON	M22-XD-S-GB6
	TEST	M22-XD-S-GB9
	FORWARD	M22-XD-S-GB15
	REVERSE	M22-XD-S-GB16
	RAISE	M22-XD-S-GB17
	LOWER	M22-XD-S-GB18
	⊙	M22-XD-S-X0
	⓪	M22-XD-S-X1
	Ⓛ	M22-XD-S-X2
	+	M22-XD-S-X4
−	M22-XD-S-X5	
Ⓛ	M22-XD-S-X7	
Red	—	M22-XD-R ^③
	Custom	M22-XD-R-ETCH ^④
	STOP	M22-XD-R-GB0
	OFF	M22-XD-R-GB5
	⊙	M22-XD-R-X0
	⓪	M22-XD-R-X1
Green	—	M22-XD-G ^③
	Custom	M22-XD-G-ETCH ^④
	START	M22-XD-G-GB1
	ON	M22-XD-G-GB6
	⓪	M22-XD-G-X1
Blue	—	M22-XD-B ^③
	Custom	M22-XD-B-ETCH ^④
	RESET	M22-XD-B-GB14
	Ⓡ	M22-XD-B-X6
White	—	M22-XD-W ^③
	Custom	M22-XD-W-ETCH ^④
	START	M22-XD-W-GB1
Yellow	⓪	M22-XD-W-X1
	—	M22-XD-Y ^③
Black, red, green	—	M22-XD-S-ETCH ^④
	—	M22-XD-SRG
Black, white, red, green, yellow, blue	—	M22-XD-SWRGYB

M22-DR-X



M22S-DR-X



M22M-DR-X



Buttonless Operator

Silver Bezel Catalog Number ^⑤	Black Bezel Catalog Number ^⑤	Metal Bezel Catalog Number ^⑤
M22-DR-X	M22S-DR-X	M22M-DR-X

M22-K10



Contact Blocks ^②

Terminal Type	Contact Configuration ^⑥	Catalog Number
Screw	NO	M22-K10
	NO, early-make	M22-K10P
	NC	M22-K01
	NC, late-break	M22-K01D
Spring-cage	NO	M22-CK10
	NC	M22-CK01
	NC, late-break	M22-CK01D
	2NO	M22-CK20
	2NC	M22-CK02
	NO-NC	M22-CK11

Notes

- ① Maintained pushbuttons can be converted in the field to momentary operation by switching the locking ring, which is accessible through the side of the operator body.
- ② For complete listing of available button plates and contact blocks, see Accessories, Pages V7-T1-111 to V7-T1-116.
- ③ Minimum order quantity of (10).
- ④ When ordering, specify inscription per catalog number suffix from the Symbols Library (see Pages V7-T1-129 to V7-T1-136) into the Order Notes. For example, M22-XD-S-ETCH; Order Notes: Mark with symbol X91, Line item #_.
- ⑤ Includes contact block mounting adapter.
- ⑥ All NC contact blocks are positively driven contact. ⊖

1 Non-Illuminated Pushbuttons, Extended, Momentary

M22-DH-R-K10



M22S-DH-R-K10



M22M-DH-R-K10



Complete Devices

Button Color	Contact Block Configuration ^①	Silver Bezel Catalog Number	Black Bezel Catalog Number	Metal Bezel Catalog Number
Red	NO	M22-DH-R-K10	M22S-DH-R-K10	M22M-DH-R-K10
	NC	M22-DH-R-K01	M22S-DH-R-K01	M22M-DH-R-K01
	2NO	M22-DH-R-K20	M22S-DH-R-K20	M22M-DH-R-K20
	2NC	M22-DH-R-K02	M22S-DH-R-K02	M22M-DH-R-K02
	1NO-1NC	M22-DH-R-K11	M22S-DH-R-K11	M22M-DH-R-K11

M22-DGH-R-K10



Silver Guarded

Button Color	Contact Block Configuration ^①	Silver Bezel Catalog Number
Red	NO	M22-DGH-R-K10
	NC	M22-DGH-R-K01
	2NO	M22-DGH-R-K20
	2NC	M22-DGH-R-K02
	1NO-1NC	M22-DGH-R-K11

M22-DH-R



M22S-DH-R



M22M-DH-R



Operators Only ^②

Button Color	Inscription	Silver Bezel Catalog Number	Black Bezel Catalog Number	Metal Bezel Catalog Number
Black	—	M22-DH-S	M22S-DH-S	M22M-DH-S
Red	—	M22-DH-R	M22S-DH-R	M22M-DH-R
	STOP	M22-DH-R-GB0	M22S-DH-R-GB0	M22M-DH-R-GB0
Green	⊙	M22-DH-R-X0	M22S-DH-R-X0	M22M-DH-R-X0
	—	M22-DH-G	M22S-DH-G	M22M-DH-G
White	—	M22-DH-W	M22S-DH-W	M22M-DH-W
Blue	—	M22-DH-B	M22S-DH-B	M22M-DH-B
Yellow	—	M22-DH-Y	M22S-DH-Y	M22M-DH-Y
⊙	—	M22-DH-X-SRGR	M22S-DH-X-SRGR	M22M-DH-X-SRGR
	—	M22-DH-X-SWRGR	M22S-DH-X-SWRGR	M22M-DH-X-SWRGR

M22-DGH-R-K10



Silver Guarded

Button Color	Inscription	Silver Bezel Catalog Number
Black	—	M22-DGH-S
Red	—	M22-DGH-R
	STOP	M22-DGH-R-GB0
Green	⊙	M22-DGH-R-X0
	—	M22-DGH-G
White	—	M22-DGH-W
Blue	—	M22-DGH-B
Yellow	—	M22-DGH-Y

Notes

- ① All NC contact blocks are positively driven contact. ⊖
- ② Includes contact block mounting adapter.
- ③ Buttonless operator comes with three color buttons (black, red, green).
- ④ Buttonless operator comes with all six color buttons (black, white, red, green, yellow, blue).

Non-Illuminated Pushbuttons, Extended, Momentary

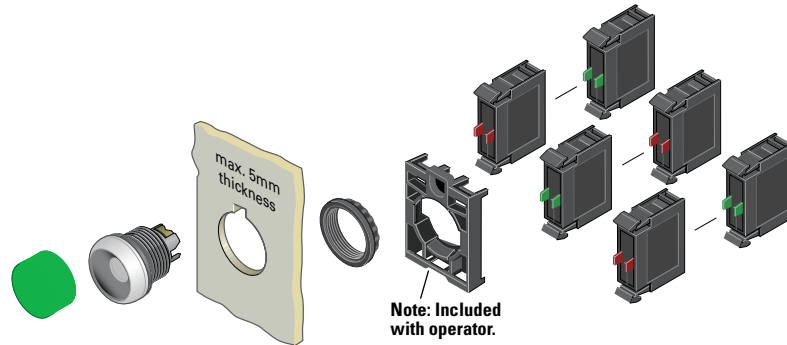

Components

M22-XDH-R



Button Plates ^①

Color	Inscription	Catalog Number
Black	—	M22-XDH-S ^②
	Custom	M22-XDH-S-ETCH ^③
	STOP	M22-XDH-S-GB0
	START	M22-XDH-S-GB1
	CLOSE	M22-XDH-S-GB2
	UP	M22-XDH-S-GB3
	DOWN	M22-XDH-S-GB4
	OFF	M22-XDH-S-GB5
	ON	M22-XDH-S-GB6
	TEST	M22-XDH-S-GB9
	FORWARD	M22-XDH-S-GB15
	REVERSE	M22-XDH-S-GB16
	RAISE	M22-XDH-S-GB17
	LOWER	M22-XDH-S-GB18
	⊙	M22-XDH-S-X0
	⓪	M22-XDH-S-X1
	Ⓛ	M22-XDH-S-X2
	+	M22-XDH-S-X4
−	M22-XDH-S-X5	
Ⓛ	M22-XDH-S-X7	
Red	—	M22-XDH-R ^②
	Custom	M22-XDH-R-ETCH ^③
	STOP	M22-XDH-R-GB0
	OFF	M22-XDH-R-GB5
	⊙	M22-XDH-R-X0
Green	—	M22-XDH-G ^②
	Custom	M22-XDH-G-ETCH ^③
	START	M22-XDH-G-GB1
	ON	M22-XDH-G-GB6
	⓪	M22-XDH-G-X1
Blue	—	M22-XDH-B ^②
	Custom	M22-XDH-B-ETCH ^③
	RESET	M22-XDH-B-GB14
	Ⓡ	M22-XDH-B-X6
White	—	M22-XDH-W ^②
	Custom	M22-XDH-W-ETCH ^③
	START	M22-XDH-W-GB1
	⓪	M22-XDH-W-X1
Yellow	—	M22-XDH-Y ^②
	Custom	M22-XDH-Y-ETCH ^③
Black, red, green	—	M22-XDH-SRG
Black, white, red, green, yellow, blue	—	M22-XDH-SWRGYB

M22-D-X



M22S-D-X



M22M-D-X



M22-DG-X



M22-K10



Buttonless Operator

Silver Bezel Catalog Number ^④	Black Bezel Catalog Number ^④	Metal Bezel Catalog Number ^④
M22-D-X	M22S-D-X	M22M-D-X

Silver Guarded

Silver Bezel Catalog Number ^④
M22-DG-X

Contact Blocks ^①

Terminal Type	Contact Configuration ^⑤	Catalog Number
Screw	NO	M22-K10
	NO, early-make	M22-K10P
	NC	M22-K01
Spring-cage	NC, late-break	M22-K01D
	NO	M22-CK10
	NC	M22-CK01
	NC, late-break	M22-CK01D
	2NO	M22-CK20
	2NC	M22-CK02
	NO-NC	M22-CK11

Notes

- ① For complete listing of available button plates and contact blocks, see Accessories, Pages V7-T1-111 to V7-T1-116.
- ② Minimum order quantity of (10).
- ③ When ordering, specify inscription per catalog number suffix from the Symbols Library (see Pages V7-T1-129 to V7-T1-136) into the Order Notes. For example, M22-XDH-S-ETCH; Order Notes: Mark with symbol X91, Line item # _.
- ④ Includes contact block mounting adapter.
- ⑤ All NC contact blocks are positively driven contact. ⊖

1 Non-Illuminated Pushbuttons, Extended, Maintained ^①

Operators Only ^②

M22-DRH-W



M22S-DRH-W



M22M-DRH-W



Button Color	Silver Bezel Catalog Number	Black Bezel Catalog Number	Metal Bezel Catalog Number
Black	M22-DRH-S	M22S-DRH-S	M22M-DRH-S
Red	M22-DRH-R	M22S-DRH-R	M22M-DRH-R
Green	M22-DRH-G	M22S-DRH-G	M22M-DRH-G
White	M22-DRH-W	M22S-DRH-W	M22M-DRH-W
Blue	M22-DRH-B	M22S-DRH-B	M22M-DRH-B
Yellow	M22-DRH-Y	M22S-DRH-Y	M22M-DRH-Y
③	M22-DRH-X-SRG	M22S-DRH-X-SRG	M22M-DRH-X-SRG
④	M22-DRH-X-SWRGYB	M22S-DRH-X-SWRGYB	M22M-DRH-X-SWRGYB

Notes

- ① Maintained pushbuttons can be converted in the field to momentary operation by switching the locking ring, which is accessible through the side of the operator body.
- ② Includes contact block mounting adapter.
- ③ Buttonless operator comes with three color buttons (black, red, green).
- ④ Buttonless operator comes with all six color buttons (black, white, red, green, yellow, blue).

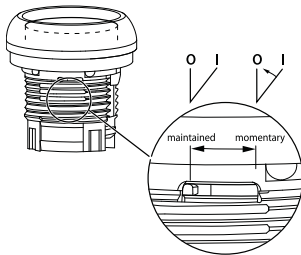

Note: This pilot device features a selectable function switch that enables the device to be set to either maintained or momentary operation.

Non-Illuminated Pushbuttons, Extended, Maintained ^①

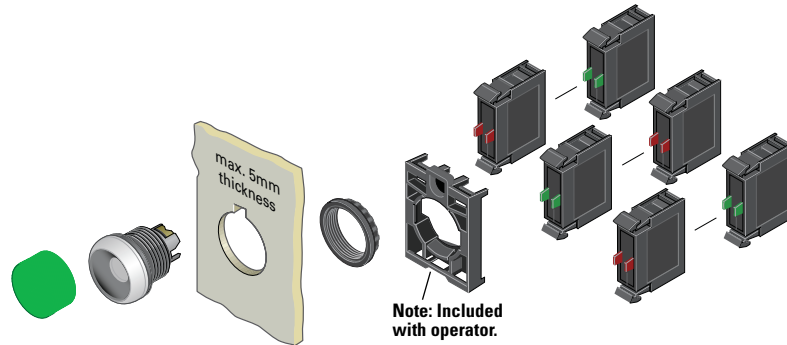

Components

M22-XDH-W



Button Plates ^②

Color	Inscription	Catalog Number
Black	—	M22-XDH-S ^③
	Custom	M22-XDH-S-ETCH ^④
	STOP	M22-XDH-S-GB0
	START	M22-XDH-S-GB1
	CLOSE	M22-XDH-S-GB2
	UP	M22-XDH-S-GB3
	DOWN	M22-XDH-S-GB4
	OFF	M22-XDH-S-GB5
	ON	M22-XDH-S-GB6
	TEST	M22-XDH-S-GB9
	FORWARD	M22-XDH-S-GB15
	REVERSE	M22-XDH-S-GB16
	RAISE	M22-XDH-S-GB17
	LOWER	M22-XDH-S-GB18
	⊙	M22-XDH-S-X0
	①	M22-XDH-S-X1
	②	M22-XDH-S-X2
	+	M22-XDH-S-X4
−	M22-XDH-S-X5	
①	M22-XDH-S-X7	
Red	—	M22-XDH-R ^③
	Custom	M22-XDH-R-ETCH ^④
	STOP	M22-XDH-R-GB0
	OFF	M22-XDH-R-GB5
	⊙	M22-XDH-R-X0
	①	M22-XDH-R-X1
Green	—	M22-XDH-G ^③
	Custom	M22-XDH-G-ETCH ^④
	START	M22-XDH-G-GB1
	ON	M22-XDH-G-GB6
	①	M22-XDH-G-X1
Blue	—	M22-XDH-B ^③
	Custom	M22-XDH-B-ETCH ^④
	RESET	M22-XDH-B-GB14
	Ⓜ	M22-XDH-B-X6
White	—	M22-XDH-W ^③
	Custom	M22-XDH-W-ETCH ^④
	START	M22-XDH-W-GB1
	①	M22-XDH-W-X1
Yellow	—	M22-XDH-Y ^③
	Custom	M22-XDH-Y-ETCH ^④
Black, red, green	—	M22-XDH-SRG
Black, white, red, green, yellow, blue	—	M22-XDH-SWRGYB

M22-DR-X



M22S-DR-X



M22M-DR-X



Buttonless Operator

Silver Bezel Catalog Number ^⑤	Black Bezel Catalog Number ^⑤	Metal Bezel Catalog Number ^⑤
M22-DR-X	M22S-DR-X	M22M-DR-X

M22-K10



Contact Blocks ^②

Terminal Type	Contact Configuration ^⑥	Catalog Number
Screw	NO	M22-K10
	NO, early-make	M22-K10P
	NC	M22-K01
	NC, late-break	M22-K01D
Spring-cage	NO	M22-CK10
	NC	M22-CK01
	NC, late-break	M22-CK01D
	2NO	M22-CK20
	2NC	M22-CK02
	NO-NC	M22-CK11

Notes

- ① Maintained pushbuttons can be converted in the field to momentary operation by switching the locking ring, which is accessible through the side of the operator body.
- ② For complete listing of available button plates and contact blocks, see Accessories, Pages V7-T1-111 to V7-T1-116.
- ③ Minimum order quantity of (10).
- ④ When ordering, specify inscription per catalog number suffix from the Symbols Library (see Pages V7-T1-129 to V7-T1-136) into the Order Notes. For example, M22-XDH-S-ETCH; Order Notes: Mark with symbol X91, Line item # _.
- ⑤ Includes contact block mounting adapter.
- ⑥ All NC contact blocks are positively driven contact. ⊖

1

Catalog Number Selection

Catalog Number Selection is for illustrative purposes only and not to be used to create new catalog numbers.

Illuminated Pushbuttons

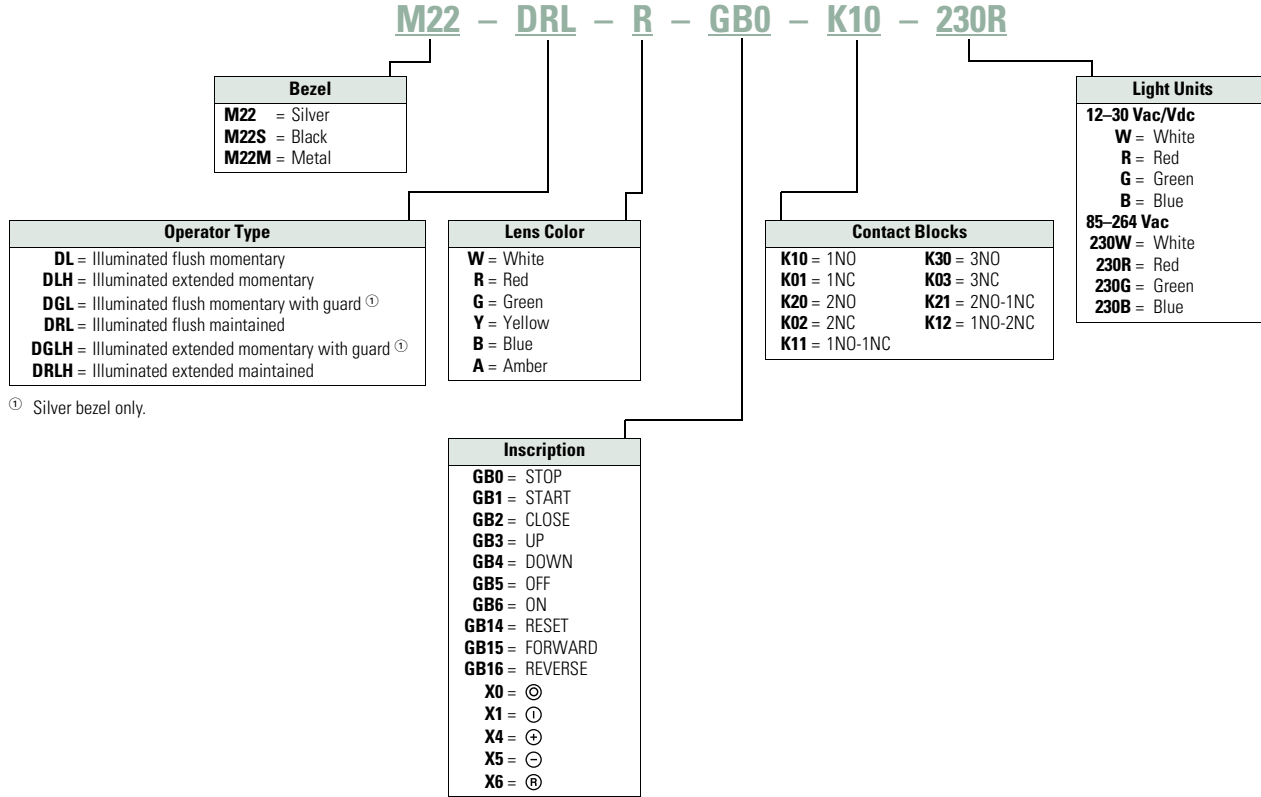

Product Selection

Illuminated Pushbuttons, Flush, Momentary

M22-DL-G-K01-G



Complete Devices

Button Color	Contact Block Configuration ^①	Light Unit Voltage	Silver Bezel Catalog Number	Black Bezel Catalog Number	Metal Bezel Catalog Number
Red	NC	12–30 Vac/Vdc	M22-DL-R-K01-R	M22S-DL-R-K01-R	M22M-DL-R-K01-R
	NC	85–264 Vac	M22-DL-R-K01-230R	M22S-DL-R-K01-230R	M22M-DL-R-K01-230R
	2NC	12–30 Vac/Vdc	M22-DL-R-K02-R	M22S-DL-R-K02-R	M22M-DL-R-K02-R
	2NC	85–264 Vac	M22-DL-R-K02-230R	M22S-DL-R-K02-230R	M22M-DL-R-K02-230R
Green	1NO/1NC	12–30 Vac/Vdc	M22-DL-R-K11-R	M22S-DL-R-K11-R	M22M-DL-R-K11-R
	1NO/1NC	85–264 Vac	M22-DL-R-K11-230R	M22S-DL-R-K11-230R	M22M-DL-R-K11-230R
	NO	12–30 Vac/Vdc	M22-DL-G-K10-G	M22S-DL-G-K10-G	M22M-DL-G-K10-G
	NO	85–264 Vac	M22-DL-G-K10-230G	M22S-DL-G-K10-230G	M22M-DL-G-K10-230G
M22M-DL-G-K01-G	2NO	12–30 Vac/Vdc	M22-DL-G-K20-G	M22S-DL-G-K20-G	M22M-DL-G-K20-G
	2NO	85–264 Vac	M22-DL-G-K20-230G	M22S-DL-G-K20-230G	M22M-DL-G-K20-230G
	1NO/1NC	12–30 Vac/Vdc	M22-DL-G-K11-G	M22S-DL-G-K11-G	M22M-DL-G-K11-G
	1NO/1NC	85–264 Vac	M22-DL-G-K11-230G	M22S-DL-G-K11-230G	M22M-DL-G-K11-230G
White	NO	12–30 Vac/Vdc	M22-DL-W-K10-W	M22S-DL-W-K10-W	—
	NO	85–264 Vac	M22-DL-W-K10-230W	M22S-DL-W-K10-230W	M22M-DL-W-K10-230W
	2NO	12–30 Vac/Vdc	M22-DL-W-K20-W	M22S-DL-W-K20-W	—
	2NO	85–264 Vac	M22-DL-W-K20-230W	M22S-DL-W-K20-230W	M22M-DL-W-K20-230W
	1NO/1NC	12–30 Vac/Vdc	M22-DL-W-K11-W	M22S-DL-W-K11-W	—
	1NO/1NC	85–264 Vac	M22-DL-W-K11-230W	M22S-DL-W-K11-230W	M22M-DL-W-K11-230W

Note

^① All NC contact blocks are positively driven contact. ⊖

1

Illuminated Pushbuttons, Flush, Momentary

M22-DL-G



M22S-DL-G



M22M-DL-G



M22-DGL-G



Operators Only [Ⓢ]

Button Color	Silver Bezel Catalog Number	Black Bezel Catalog Number	Metal Bezel Catalog Number
Red	M22-DL-R	M22S-DL-R	M22M-DL-R
Green	M22-DL-G	M22S-DL-G	M22M-DL-G
White	M22-DL-W	M22S-DL-W	M22M-DL-W
Blue	M22-DL-B	M22S-DL-B	M22M-DL-B
Yellow	M22-DL-Y	M22S-DL-Y	M22M-DL-Y
Amber	M22-DL-A	M22S-DL-A	M22M-DL-A

Silver Guarded

Button Color	Silver Bezel Catalog Number
Red	M22-DGL-R
Green	M22-DGL-G
White	M22-DGL-W
Blue	M22-DGL-B
Yellow	M22-DGL-Y

Note

[Ⓢ] Includes contact block mounting adapter.

Illuminated Pushbuttons, Flush, Momentary

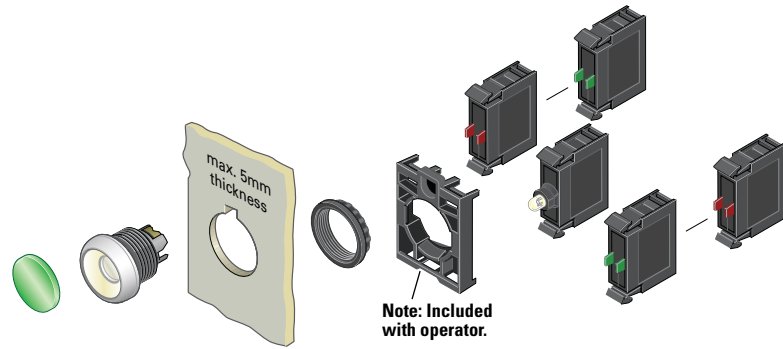

Components

M22-XDL-G



Button Lenses ①

Color	Inscription	Catalog Number
Red	—	M22-XDL-R ②
	Custom	M22-XDL-R-ETCH ③
	STOP	M22-XDL-R-GB0
	OFF	M22-XDL-R-GB5
	Ⓞ	M22-XDL-R-X0
Green	—	M22-XDL-G ②
	Custom	M22-XDL-G-ETCH ③
	START	M22-XDL-G-GB1
	ON	M22-XDL-G-GB6
	Ⓢ	M22-XDL-G-X1
Blue	—	M22-XDL-B ②
	Custom	M22-XDL-B-ETCH ③
	RESET	M22-XDL-B-GB14
	Ⓡ	M22-XDL-B-X6
White	—	M22-XDL-W ②
Yellow	—	M22-XDL-Y ②
Amber	—	M22-XDL-A
	Custom	M22-XDL-A-ETCH ③

M22-LED-W



Light Units ①

Terminal Type	LED Color	Light Unit Voltage	Catalog Number
Screw	White	12–30 Vac/Vdc	M22-LED-W
	Red		M22-LED-R
	Green		M22-LED-G
	Blue		M22-LED-B
Screw	White	85–264 Vac	M22-LED230-W
	Red		M22-LED230-R
	Green		M22-LED230-G
	Blue		M22-LED230-B

M22-K10



Contact Blocks ①

Terminal Type	Contact Configuration ⑤	Catalog Number
Screw	NO	M22-K10
	NO, early-make	M22-K10P
	NC	M22-K01
	NC, late-break	M22-K01D
Spring-cage	NO	M22-CK10
	NC	M22-CK01
	NC, late-break	M22-CK01D
	2NO	M22-CK20
	2NC	M22-CK02
	NO-NC	M22-CK11

M22-DL-X



Buttonless Operator

Silver Bezel Catalog Number ④	Black Bezel Catalog Number ④	Metal Bezel Catalog Number ④
M22-DL-X	M22S-DL-X	M22M-DL-X

M22S-DL-X



M22M-DL-X



M22-DGL-X



Silver Guarded

Silver Bezel Catalog Number ④
M22-DGL-X

Notes

- ① For complete listing of available button lenses, light units and contact blocks, see Accessories, **Pages V7-T1-111 to V7-T1-116**.
- ② Minimum order quantity of (10).
- ③ When ordering, specify inscription per catalog number suffix from the Symbols Library (see **Pages V7-T1-129 to V7-T1-136**) into the Order Notes. For example, M22-XDL-R-ETCH; Order Notes: Mark with symbol X91, Line item #_.
- ④ Includes contact block mounting adapter.
- ⑤ All NC contact blocks are positively driven contact. Ⓢ

1

Illuminated Pushbuttons, Flush, Maintained ^②

M22-DRL-W-K10-W



M22S-DRL-W-K10-W



M22M-DRL-W-K10-W



Complete Devices

Button Color	Contact Block Configuration ^①	Light Unit Voltage	Silver Bezel Catalog Number	Black Bezel Catalog Number	Metal Bezel Catalog Number
White	NO	12–30 Vac/Vdc	M22-DRL-W-K10-W	M22S-DRL-W-K10-W	M22M-DRL-W-K10-W
	NO	85–264 Vac	M22-DRL-W-K10-230W	M22S-DRL-W-K10-230W	M22M-DRL-W-K10-230W
	NC	12–30 Vac/Vdc	M22-DRL-W-K01-W	M22S-DRL-W-K01-W	M22M-DRL-W-K01-W
	NC	85–264 Vac	M22-DRL-W-K01-230W	M22S-DRL-W-K01-230W	M22M-DRL-W-K01-230W
	2NO	12–30 Vac/Vdc	M22-DRL-W-K20-W	M22S-DRL-W-K20-W	M22M-DRL-W-K20-W
	2NO	85–264 Vac	M22-DRL-W-K20-230W	M22S-DRL-W-K20-230W	M22M-DRL-W-K20-230W
	2NC	12–30 Vac/Vdc	M22-DRL-W-K02-W	M22S-DRL-W-K02-W	M22M-DRL-W-K02-W
	2NC	85–264 Vac	M22-DRL-W-K02-230W	M22S-DRL-W-K02-230W	M22M-DRL-W-K02-230W
	1NO/1NC	12–30 Vac/Vdc	M22-DRL-W-K11-W	M22S-DRL-W-K11-W	M22M-DRL-W-K11-W
	1NO/1NC	85–264 Vac	M22-DRL-W-K11-230W	M22S-DRL-W-K11-230W	M22M-DRL-W-K11-230W

M22-DRL-W



M22S-DRL-W



M22M-DRL-W



Operators Only ^③

Button Color	Silver Bezel Catalog Number	Black Bezel Catalog Number	Metal Bezel Catalog Number
Red	M22-DRL-R	M22S-DRL-R	M22M-DRL-R
Green	M22-DRL-G	M22S-DRL-G	M22M-DRL-G
White	M22-DRL-W	M22S-DRL-W	M22M-DRL-W
Blue	M22-DRL-B	M22S-DRL-B	M22M-DRL-B
Yellow	M22-DRL-Y	M22S-DRL-Y	M22M-DRL-Y
Amber	M22-DRL-A	M22S-DRL-A	M22M-DRL-A

Notes

- ① All NC contact blocks are positively driven contact. ⊖
- ② Maintained pushbuttons can be converted in the field to momentary operation by switching the locking ring, which is accessible through the side of the operator body.
- ③ Includes contact block mounting adapter.

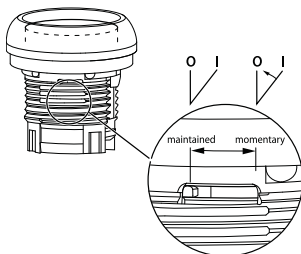

Note: This pilot device features a selectable function switch that enables the device to be set to either maintained or momentary operation.

Illuminated Pushbuttons, Flush, Maintained ^①

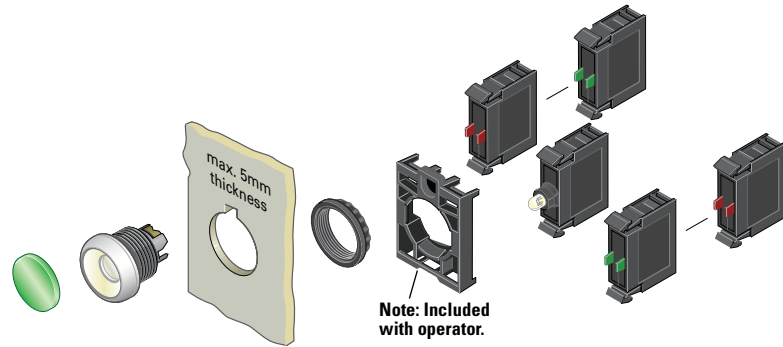

Components

M22-XDL-W



Button Lenses ^②

Color	Inscription	Catalog Number
Red	—	M22-XDL-R ^③
	Custom	M22-XDL-R-ETCH ^④
	STOP	M22-XDL-R-GB0
	OFF	M22-XDL-R-GB5
	⊙	M22-XDL-R-X0
Green	—	M22-XDL-G ^③
	Custom	M22-XDL-G-ETCH ^④
	START	M22-XDL-G-GB1
	ON	M22-XDL-G-GB6
	⓪	M22-XDL-G-X1
Blue	—	M22-XDL-B ^③
	Custom	M22-XDL-B-ETCH ^④
	RESET	M22-XDL-B-GB14
White	Ⓜ	M22-XDL-B-X6
	Custom	M22-XDL-W-ETCH ^④
Yellow	—	M22-XDL-Y ^③
	Custom	M22-XDL-Y-ETCH ^④
Amber	—	M22-XDL-A
	Custom	M22-XDL-A-ETCH

M22-LED-W



Light Units ^②

Terminal Type	LED Color	Light Unit Voltage	Catalog Number
Screw	White	12–30 Vac/Vdc	M22-LED-W
	Red		M22-LED-R
	Green	M22-LED-G	
	Blue	M22-LED-B	
Screw	White	85–264 Vac	M22-LED230-W
	Red		M22-LED230-R
	Green		M22-LED230-G
	Blue		M22-LED230-B

M22-K10



Contact Blocks ^②

Terminal Type	Contact Configuration ^⑤	Catalog Number
Screw	NO	M22-K10
	NO, early-make	M22-K10P
	NC	M22-K01
	NC, late-break	M22-K01D
Spring-cage	NO	M22-CK10
	NC	M22-CK01
	NC, late-break	M22-CK01D
	2NO	M22-CK20
	2NC	M22-CK02
	NO-NC	M22-CK11

M22-DRL-X



Buttonless Operator

Silver Bezel Catalog Number ^⑤	Black Bezel Catalog Number ^⑤	Metal Bezel Catalog Number ^⑤
M22-DRL-X	M22S-DRL-X	M22M-DRL-X

M22S-DRL-X



M22M-DRL-X



Notes

- ① Maintained pushbuttons can be converted in the field to momentary operation by switching the locking ring, which is accessible through the side of the operator body.
- ② For complete listing of available button lenses, light units and contact blocks, see Accessories, **Pages V7-T1-111 to V7-T1-116**.
- ③ Minimum order quantity of (10).
- ④ When ordering, specify inscription per catalog number suffix from the Symbols Library (see **Pages V7-T1-129 to V7-T1-136**) into the Order Notes. For example, M22-XDL-R-ETCH; Order Notes: Mark with symbol X91, Line item #_.
- ⑤ Includes contact block mounting adapter.
- ⑥ All NC contact blocks are positively driven contact. ⊖

1

Illuminated Pushbuttons, Extended, Momentary

M22-DLH-R-K11-R



M22S-DLH-R-K11-R



Complete Devices

Button Color	Contact Block Configuration ^①	Light Unit Voltage	Silver Bezel Catalog Number	Black Bezel Catalog Number	Metal Bezel Catalog Number
Red	1NO/1NC	12–30 Vac/Vdc	M22-DLH-R-K11-R	M22S-DLH-R-K11-R	M22M-DLH-R-K11-R
	1NO/1NC	85–264 Vac	M22-DLH-R-K11-230R	M22S-DLH-R-K11-230R	M22M-DLH-R-K11-230R
Green	2NO	12–30 Vac/Vdc	M22-DLH-G-K20-G	M22S-DLH-G-K20-G	M22M-DLH-G-K20-G
	2NO	85–264 Vac	M22-DLH-G-K20-230G	M22S-DLH-G-K20-230G	M22M-DLH-G-K20-230G
White	2NO	12–30 Vac/Vdc	M22-DLH-W-K20-W	M22S-DLH-W-K20-W	M22M-DLH-W-K20-W
	2NO	85–264 Vac	M22-DLH-W-K20-230W	M22S-DLH-W-K20-230W	M22M-DLH-W-K20-230W

Complete Press-to-Test Units

Button Color	Light Unit Voltage	Silver Bezel Catalog Number	Black Bezel Catalog Number
Red	12–30 Vac/Vdc	M22-T-R-R	M22S-T-R-R
Blue		M22-T-B-B	M22S-T-B-B
Yellow		M22-T-Y-W	M22S-T-Y-W
Green		M22-T-G-G	M22S-T-G-G
White		M22-T-W-W	M22S-T-W-W
Red	85–264 Vac	M22-T-R-230R	M22S-T-R-230R
Blue		M22-T-R-230B	M22S-T-B-230B
Yellow		M22-T-Y-230W	M22S-T-Y-230W
Green		M22-T-G-230G	M22S-T-G-230G
White		M22-T-W-230W	M22S-T-W-230W

Operators Only ^②

M22-DLH-R



M22S-DLH-R



M22M-DLH-R



Button Color	Silver Bezel Catalog Number	Black Bezel Catalog Number	Metal Bezel Catalog Number
Red	M22-DLH-R	M22S-DLH-R	M22M-DLH-R
Green	M22-DLH-G	M22S-DLH-G	M22M-DLH-G
White	M22-DLH-W	M22S-DLH-W	M22M-DLH-W
Blue	M22-DLH-B	M22S-DLH-B	M22M-DLH-B
Yellow	M22-DLH-Y	M22S-DLH-Y	M22M-DLH-Y
Amber	M22-DLH-A	M22S-DLH-A	M22M-DLH-A

M22-DGLH-R



Silver Guarded

Button Color	Silver Bezel Catalog Number
Red	M22-DGLH-R
Green	M22-DGLH-G
White	M22-DGLH-W
Blue	M22-DGLH-B
Yellow	M22-DGLH-Y

Notes

- ① All NC contact blocks are positively driven contact. ⊖
- ② Includes contact block mounting adapter.

Illuminated Pushbuttons, Extended, Momentary

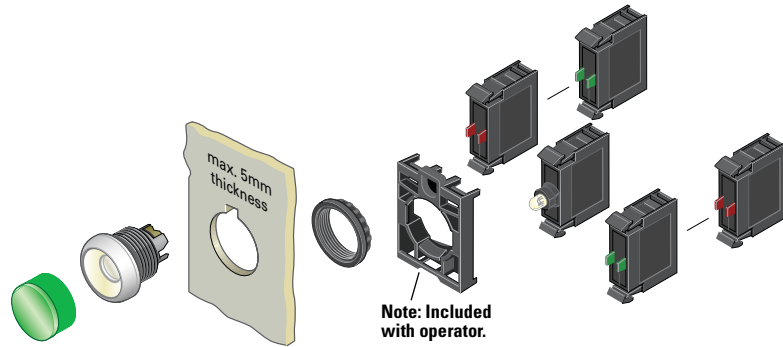

Components

M22-XDH-R



Button Lenses ①

Color	Inscription	Catalog Number
Red	—	M22-XDLH-R ②
	Custom	M22-XDLH-R-ETCH ③
	STOP	M22-XDLH-R-GB0
	OFF	M22-XDLH-R-GB5
	⊙	M22-XDLH-R-X0
Green	—	M22-XDLH-G ②
	Custom	M22-XDLH-G-ETCH ③
	START	M22-XDLH-G-GB1
	ON	M22-XDLH-G-GB6
	Ⓛ	M22-XDLH-G-X1
	Blue	—
Blue	Custom	M22-XDLH-B-ETCH ③
	RESET	M22-XDLH-B-GB14
	Ⓡ	M22-XDLH-B-X6
White	—	M22-XDLH-W ②
	Custom	M22-XDLH-W-ETCH ③
Yellow	—	M22-XDLH-Y ②
	Custom	M22-XDLH-Y-ETCH ③
Amber	—	M22-XDLH-A
	Custom	M22-XDLH-A-ETCH

M22-LED-W



Light Units ①

Terminal Type	LED Color	Light Unit Voltage	Catalog Number
Screw	White	12–30 Vac/Vdc	M22-LED-W
	Red		M22-LED-R
	Green		M22-LED-G
	Blue		M22-LED-B
Screw	White	85–264 Vac	M22-LED230-W
	Red		M22-LED230-R
	Green		M22-LED230-G
	Blue		M22-LED230-B

M22-K10



Contact Blocks ①

Terminal Type	Contact Configuration ⑤	Catalog Number
Screw	NO	M22-K10
	NO, early-make	M22-K10P
	NC	M22-K01
	NC, late-break	M22-K01D
Spring-cage	NO	M22-CK10
	NC	M22-CK01
	NC, late-break	M22-CK01D
	2NO	M22-CK20
	2NC	M22-CK02
	NO-NC	M22-CK11

M22-DL-X



Buttonless Operator

Silver Bezel Catalog Number ④	Black Bezel Catalog Number ④	Metal Bezel Catalog Number ④
M22-DL-X	M22S-DL-X	M22M-DL-X

M22S-DL-X



M22M-DL-X



M22-DGL-X



Silver Guarded

Silver Bezel Catalog Number ④
M22-DGL-X

Notes

- ① For complete listing of available button lenses, light units and contact blocks, see Accessories, Pages V7-T1-111 to V7-T1-116.
- ② Minimum order quantity of (10).
- ③ When ordering, specify inscription per catalog number suffix from the Symbols Library (see Pages V7-T1-129 to V7-T1-136) into the Order Notes. For example, M22-XDH-S-ETCH; Order Notes: Mark with symbol X91, Line item #...
- ④ Includes contact block mounting adapter.
- ⑤ All NC contact blocks are positively driven contact. ⊖

1

Illuminated Pushbuttons, Extended, Maintained ^①

M22-DRLH-W



M22S-DRLH-W



M22M-DRLH-W



Operators Only ^②

Button Color	Silver Bezel Catalog Number	Black Bezel Catalog Number	Metal Bezel Catalog Number
Red	M22-DRLH-R	M22S-DRLH-R	M22M-DRLH-R
Green	M22-DRLH-G	M22S-DRLH-G	M22M-DRLH-G
White	M22-DRLH-W	M22S-DRLH-W	M22M-DRLH-W
Blue	M22-DRLH-B	M22S-DRLH-B	M22M-DRLH-B
Yellow	M22-DRLH-Y	M22S-DRLH-Y	M22M-DRLH-Y
Amber	M22-DRLH-A	M22S-DRLH-A	M22M-DRLH-A

Notes

- ① Maintained pushbuttons can be converted in the field to momentary operation by switching the locking ring, which is accessible through the side of the operator body.
- ② Includes contact block mounting adapter.

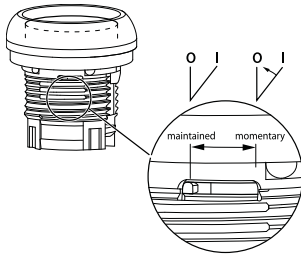

Note: This pilot device features a selectable function switch that enables the device to be set to either maintained or momentary operation.

Illuminated Pushbuttons, Extended, Maintained ^①

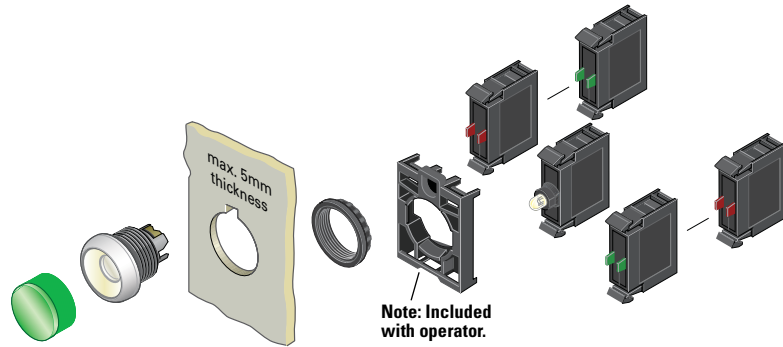

Components

M22-XDLH-W



Button Lenses ^②

Color	Inscription	Catalog Number
Red	—	M22-XDLH-R ^③
	Custom	M22-XDLH-R-ETCH ^④
	STOP	M22-XDLH-R-GB0
	OFF	M22-XDLH-R-GB5
	⊙	M22-XDLH-R-X0
Green	—	M22-XDLH-G ^③
	Custom	M22-XDLH-G-ETCH ^④
	START	M22-XDLH-G-GB1
	ON	M22-XDLH-G-GB6
	Ⓜ	M22-XDLH-G-X1
Blue	—	M22-XDLH-B ^③
	Custom	M22-XDLH-B-ETCH ^④
	RESET	M22-XDLH-B-GB14
	Ⓜ	M22-XDLH-B-X6
White	—	M22-XDLH-W ^③
	Custom	M22-XDLH-W-ETCH ^④
Yellow	—	M22-XDLH-Y ^③
	Custom	M22-XDLH-Y-ETCH ^④
Amber	—	M22-XDLH-A
	Custom	M22-XDLH-A-ETCH

M22-LED-W



Light Units ^②

Terminal Type	LED Color	Light Unit Voltage	Catalog Number
Screw	White	12–30 Vac/Vdc	M22-LED-W
	Red		M22-LED-R
	Green		M22-LED-G
	Blue		M22-LED-B
Screw	White	85–264 Vac	M22-LED230-W
	Red		M22-LED230-R
	Green		M22-LED230-G
	Blue		M22-LED230-B

M22-K10



Contact Blocks ^②

Terminal Type	Contact Configuration ^⑥	Catalog Number
Screw	NO	M22-K10
	NO, early-make	M22-K10P
	NC	M22-K01
	NC, late-break	M22-K01D
Spring-cage	NO	M22-CK10
	NC	M22-CK01
	NC, late-break	M22-CK01D
	2NO	M22-CK20
	2NC	M22-CK02
	NO-NC	M22-CK11

M22-DRL-X



Buttonless Operator

Silver Bezel Catalog Number ^⑤	Black Bezel Catalog Number ^⑤	Metal Bezel Catalog Number ^⑤
M22-DRL-X	M22S-DRL-X	M22M-DRL-X

M22S-DRL-X



M22M-DRL-X



Notes

- ① Maintained pushbuttons can be converted in the field to momentary operation by switching the locking ring, which is accessible through the side of the operator body.
- ② For complete listing of available button lenses, light units and contact blocks, see Accessories, Pages V7-T1-111 to V7-T1-116.
- ③ Minimum order quantity of (10).
- ④ When ordering, specify inscription per catalog number suffix from the Symbols Library (see Pages V7-T1-129 to V7-T1-136) into the Order Notes. For example, M22-XDLH-S-ETCH; Order Notes: Mark with symbol X91, Line item #_.
- ⑤ Includes contact block mounting adapter.
- ⑥ All NC contact blocks are positively driven contact. ⊖

1

Indicating Lights

Product Description

Eaton's M22 indicating lights use the combination of a durable, bright LED unit and modern lenses designed specifically for this type of LED to create a bright and visible indicating light.

As with the pushbuttons, the indicating light lenses can be laser engraved. Indicating lights can be ordered as complete devices, including lens and LED unit, or as modular components.

Features

- Customizable laser engraving on all lenses
- LED offering only for improved brightness quality and up to 100,000 hours of operation
- Lenses designed specifically for LED illumination
- Modular construction makes assembly fast and simplifies stocking of components and complete devices
- Capable of communicating via ASi protocol with ASi adapter modules

Protection Type

- IP67, IP69K
- NEMA 4X, 13

Catalog Number Selection

Catalog Number Selection is for illustrative purposes only and not to be used to create new catalog numbers.

Indicating Lights

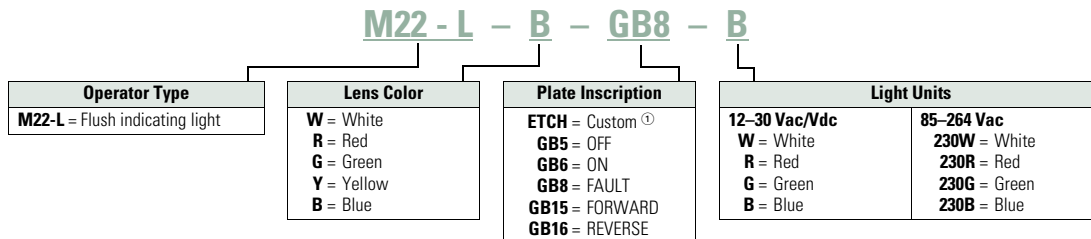

Note: Light unit should match color of lens. Use white light unit with yellow lens.

^① When ordering, specify inscription per catalog number suffix from the Symbols Library (see **Pages V7-T1-129 to V7-T1-136**) into the Order Notes. For example, M22-L-B-ETCH; Order Notes: Mark with symbol X91, Line item #_.

Product Selection

Indicating Lights, Flush

M22-L-R-R



Complete Devices

Lens Color	Light Color	Light Unit Voltage	Catalog Number
White	White	12-30 Vac/Vdc	M22-L-W-W
Red	Red		M22-L-R-R
Green	Green		M22-L-G-G
Yellow	White		M22-L-Y-W
Blue	Blue		M22-L-B-B
Amber	White		M22-L-A-W
White	White	85-264 Vac	M22-L-W-230W
Red	Red		M22-L-R-230R
Green	Green		M22-L-G-230G
Yellow	White		M22-L-Y-230W
Blue	Blue		M22-L-B-230B
Amber	White		M22-L-A-230W

Operators Only ^①

M22-L-R



Lens Color	Catalog Number
Flat	
White	M22-L-W
Red	M22-L-R
Green	M22-L-G
Yellow	M22-L-Y
Blue	M22-L-B
Amber	M22-L-A

M22-LH-R



Lens Color	Catalog Number
Conical	
White	M22-LH-W
Red	M22-LH-R
Green	M22-LH-G
Yellow	M22-LH-Y
Blue	M22-LH-B
Amber	M22-LH-A

Note

^① Includes contact block mounting adapter.

Indicating Lights, Flush

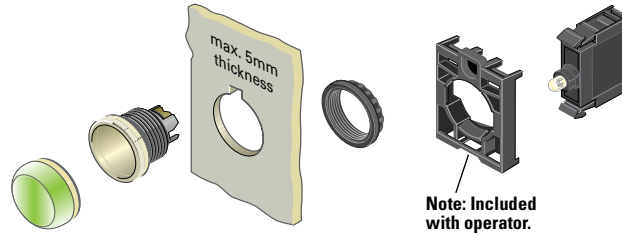

Components

M22-XL-R



Lenses ①

Color	Inscription	Catalog Number
Flat		
Red	—	M22-XL-R ②
	Custom	M22-XL-R-ETCH ③
	OFF	M22-XL-R-GB5
Green	—	M22-XL-G ②
	Custom	M22-XL-G-ETCH ③
	ON	M22-XL-G-GB6
	REVERSE	M22-XL-G-GB16
Blue	—	M22-XL-B ②
	Custom	M22-XL-B-ETCH ③
	FAULT	M22-XL-B-GB8
White	—	M22-XL-W ②
	Custom	M22-XL-W-ETCH ③
	OFF	M22-XL-W-GB5
	ON	M22-XL-W-GB6
	FAULT	M22-XL-W-GB8
Yellow	—	M22-XL-Y ②
	Custom	M22-XL-Y-ETCH ③
Amber	—	M22-XL-A ②
	Custom	M22-XL-A-ETCH ③
Conical		
Red	—	M22-XLH-R
Green	—	M22-XLH-G
Blue	—	M22-XLH-B
White	—	M22-XLH-W
Yellow	—	M22-XLH-Y
Amber	—	M22-XLH-A

M22-LED-W



Light Units ①④

Terminal Type	LED Color	Light Unit Voltage	Catalog Number
Screw	White	12–30	M22-LED-W
	Red	Vac/Vdc	M22-LED-R
	Green		M22-LED-G
	Blue		M22-LED-B
Screw	White	85–264	M22-LED230-W
	Red	Vac	M22-LED230-R
	Green		M22-LED230-G
	Blue		M22-LED230-B

Notes

- ① For complete listing of available lenses and light units, see Accessories, **Pages V7-T1-111 to V7-T1-116**.
- ② Minimum order quantity of (10).
- ③ When ordering, specify inscription per catalog number suffix from the Symbols Library (see **Pages V7-T1-129 to V7-T1-136**) into the Order Notes. For example, M22-XL-R-ETCH; Order Notes: Mark with symbol X91, Line item #_.
- ④ Select the same color LED element as lens color; for yellow and amber lenses, choose a white LED.

M22-L-X



Lensless Indicating Light

Catalog Number

M22-L-X

1

Emergency Stops

Product Description

Eaton's M22 emergency stops are a durable and reliable solution to a variety of e-stop applications. With standard push-pull, as well as twist-to-release and key-release, illuminated options and red or black operators, the M22 e-stop is a robust solution. As with all operators, they can be ordered as a ready to install complete device or as modular components for the perfect fit.

Features

- Push-pull and twist to release options available as well as illuminated and keyed release
- LED offering only for improved brightness quality and up to 100,000 hours of operation
- More than 100,000 mechanical operations
- Capable of communicating via ASi protocol with ASi adapter modules
- Suitable for use in safety applications up to Category-4 or Sil-3

Protection Type

- IP67, IP69K (IP66 key-release)
- NEMA 4X, 13

Catalog Number Selection

Catalog Number Selection is for illustrative purposes only and not to be used to create new catalog numbers.

Emergency Stops

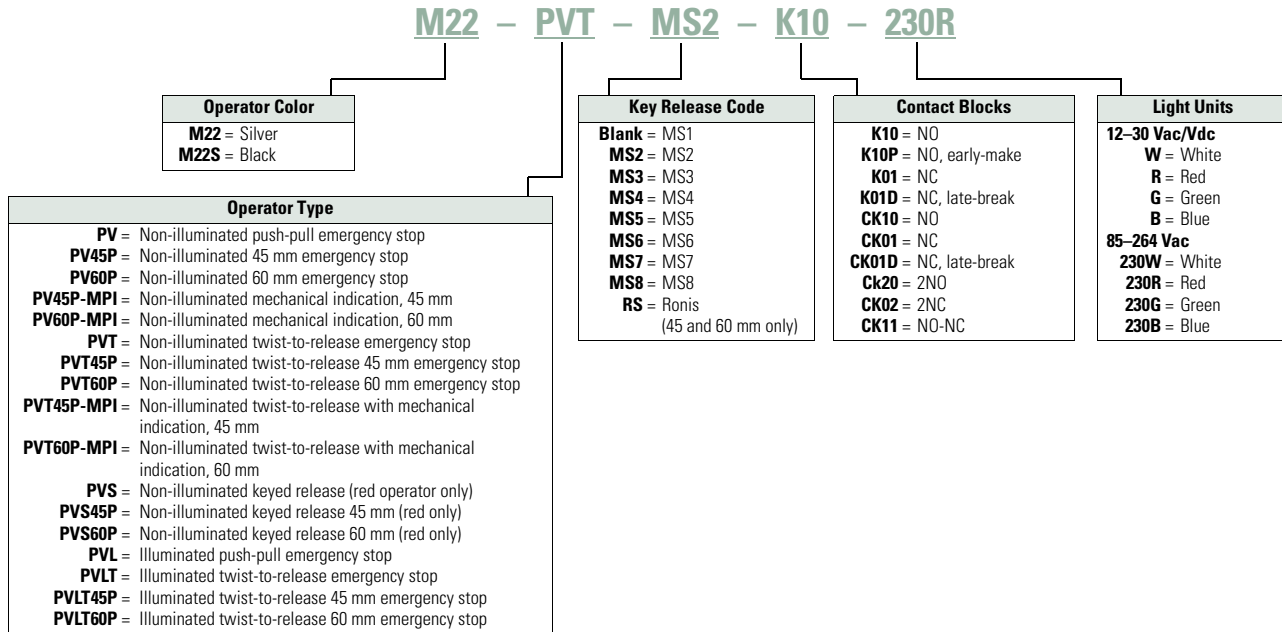

Product Selection

Non-Illuminated and Illuminated Emergency Stops

Complete Devices

Type	Button Color	LED Color	Contact Block Configuration ^①	Light Unit Voltage	Catalog Number		
M22-PV-K01							
	Non-Illuminated						
	Push-pull	Red	—	NC	—	M22-PV-K01	
				2NC		M22-PV-K02	
				1NO-2NC		M22-PV-K12	
	Twist-to-release	Red	—	NC	—	M22-PVT-K01	
				2NC		M22-PVT-K02	
				1NO-2NC		M22-PVT-K12	
	Key release	Red	—	NC	—	M22-PVS-K01	
				2NC		M22-PVS-K02	
1NO-2NC				M22-PVS-K12			
M22-PVL-K01-R							
	Illuminated						
	Push-pull	Red	Red	NC	12–30 Vac/Vdc	M22-PVL-K01-R	
				2NC		M22-PVL-K02-R	
				1NO-2NC		M22-PVL-K12-R	
				NC		85–264 Vac	M22-PVL-K01-230R
				2NC			M22-PVL-K02-230R
				1NO-2NC			M22-PVL-K12-230R
	Twist-to-release	Red	Red	NC	12–30 Vac/Vdc	M22-PVLT-K01-R	
				2NC		M22-PVLT-K02-R	
				1NO-2NC		M22-PVLT-K12-R	
				NC		85–264 Vac	M22-PVLT-K01-230R
				2NC			M22-PVLT-K02-230R
1NO-2NC				M22-PVLT-K12-230R			

Note

^① All NC contact blocks are positively driven contact. ⊖

Non-Illuminated and Illuminated Emergency Stops

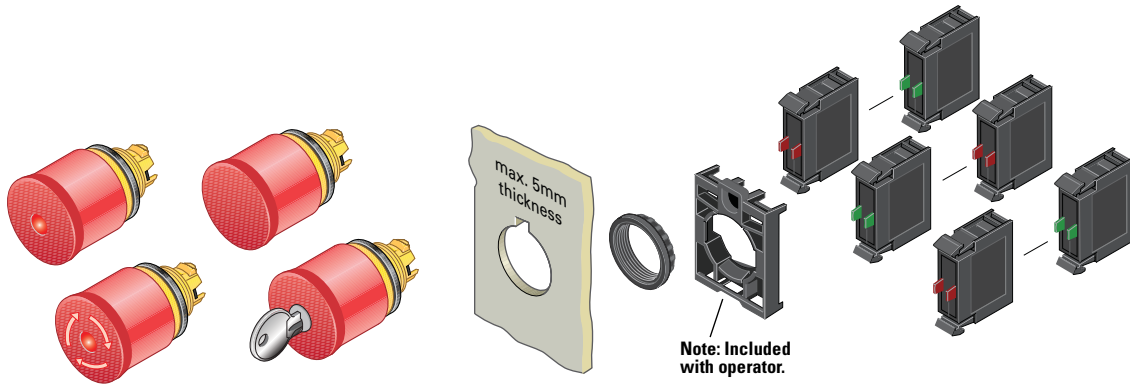

Components

M22-PVL



Push-Pull Emergency Stops

Illumination/Indication	Actuator Size	Catalog Number
None	35 mm	M22-PV
	45 mm	M22-PV45P
	60 mm	M22-PV60P
LED illumination	35 mm	M22-PVL
	45 mm	M22-PVL45P
	60 mm	M22-PVL60P
Mechanical indication	45 mm	M22-PV45P-MPI
	60 mm	M22-PV60P-MPI

M22-PVS60P-MS1



Key Release Emergency Stops ②

Actuator Size	Key Code	Catalog Number	
35 mm	MS1	M22-PVS ③	
	MS2	M22-PVS-MS2	
	MS3	M22-PVS-MS3	
	MS4	M22-PVS-MS4	
	MS5	M22-PVS-MS5	
	MS6	M22-PVS-MS6	
	MS7	M22-PVS-MS7	
	MS8	M22-PVS-MS8	
45 mm	MS1	M22-PVS45P	
	MS2	M22-PVS45P-MS2	
	MS3	M22-PVS45P-MS3	
	MS4	M22-PVS45P-MS4	
	MS5	M22-PVS45P-MS5	
	MS6	M22-PVS45P-MS6	
	MS7	M22-PVS45P-MS7	
	MS8	M22-PVS45P-MS8	
	Ronis	M22-PVS45P-RS	
	60 mm	MS1	M22-PVS60P
		MS2	M22-PVS60P-MS2
		MS3	M22-PVS60P-MS3
		MS4	M22-PVS60P-MS4
		MS5	M22-PVS60P-MS5
		MS6	M22-PVS60P-MS6
		MS7	M22-PVS60P-MS7
MS8		M22-PVS60P-MS8	
Ronis	M22-PVS60P-RS		

M22-PVT45P-MPI



Twist-to-Release Emergency Stops

Illumination/Indication	Actuator Size	Catalog Number
None	35 mm	M22-PVT
	45 mm	M22-PVT45P
	60 mm	M22-PVT60P
LED illumination	35 mm	M22-PVLT
	45 mm	M22-PVLT45P
	60 mm	M22-PVLT60P
Mechanical indication	45 mm	M22-PVT45P-MPI
	60 mm	M22-PVT60P-MPI

M22S-PVLT



Machine Stop Operators (Black) ①

Illumination	Type	Actuator Size	Catalog Number
Non-illuminated	Push-pull	35 mm	M22S-PV
	Twist-to-release	35 mm	M22S-PVT
LED illumination	Push-pull	35 mm	M22S-PVL
	Twist-to-release	35 mm	M22S-PVLT

Notes

- ① Includes contact block mounting adapter.
- ② Key included. For identical locks and keys, use the same key code. One key is included with actuator; additional keys are available as accessories.
- ③ Includes Key Code MS1.

M22-K10



Contact Blocks ①

Terminal Type	Mounting Location ②	Contact Configuration ③	Catalog Number
Screw	Front	NO	M22-K10
		NO, early-make	M22-K10P
		NC	M22-K01
		NC, late-break	M22-K01D
		SMCB, NC	M22-K01SMC10
		SMCB, 2NC	M22-K02SMC10
Base	SMCB, NC		M22-KC01SMC10
		SMCB, 2NC	M22-KC02SMC10
Spring-cage	Front	NO	M22-CK10
		NC	M22-CK01
		NC, late-break	M22-CK01D
		2NO	M22-CK20
		2NC	M22-CK02
		NO-NC	M22-CK11

M22-LED-W



Light Units ①

Terminal Type	LED Color	Light Unit Voltage	Catalog Number
Screw	White	12–30 Vac/Vdc	M22-LED-W
	Red	12–30 Vac/Vdc	M22-LED-R
Screw	White	85–264 Vac	M22-LED230-W
	Red	85–264 Vac	M22-LED230-R
Screw	White	207–264 Vac	M22-LED230H-W
	Red	207–264 Vac	M22-LED230H-R





M22-ES-MS1



Extra Keys ④

For Key Code	Catalog Number
MS1	M22-ES-MS1
MS2	M22-ES-MS2
MS3	M22-ES-MS3
MS4	M22-ES-MS4
MS5	M22-ES-MS5
MS6	M22-ES-MS6
MS7	M22-ES-MS7
MS8	M22-ES-MS8

Accessories

Description	Voltage	Catalog Number
M22-XGVP 	—	M22-XGVP
M22G-XGVP 	—	M22G-XGVP
M22-MGTA 	—	M22-MGTA
M22-PL-PV 	—	M22-PL-PV
M22-XPV60-Y-120 	24 Vac/Vdc	M22-XPV60-Y-24
	120 Vac	M22-XPV60-Y-120
	230 Vac	M22-XPV60-Y-230

Notes

- ① For complete listing of available contact blocks, see Accessories, Pages V7-T1-111 to V7-T1-116.
- ② Self-monitoring contact blocks (SMCB type) cannot be used with illuminated emergency stops.
- ③ All NC contact blocks are positively driven contact. ⊖
- ④ For use with key release operators only. One key included with operator.

Selector Switches



Contents

Description

	<i>Page</i>
Selector Switches	
Non-Illuminated Switches	V7-T1-79
Illuminated Switches	V7-T1-84
Key Operated	V7-T1-88

Selector Switches

Product Description

Eaton’s M22 selector switch line offers an almost endless variety of options in maintained/momentary, key-removal and illuminated devices. The coding adapters used for maintained/momentary and key removal positions make the M22 stand out from competitive devices. By simply adding or removing a coding adapter from inside the operator, the end-user can change the function of the button. Operator options include standard knob, rotary head, illuminated and keyed versions. As with all operators, they can be ordered as a ready to install complete device or as modular components to meet application specific requirements.

Features

- Adding or removing coding adapters allows for field convertibility of maintained/momentary and key removal positions
- LED offering only for improved brightness quality and up to 100,000 hours of operation
- More than 100,000 mechanical operations
- Coding adapter options make assembly fast and simplify stocking of different configurations of selector switches
- Capable of communicating via ASi protocol with ASi adapter modules

Protection Type

- IP66
- NEMA 4X, 13

Catalog Number Selection

Catalog Number Selection is for illustrative purposes only and not to be used to create new catalog numbers.

Non-Illuminated Selector Switches

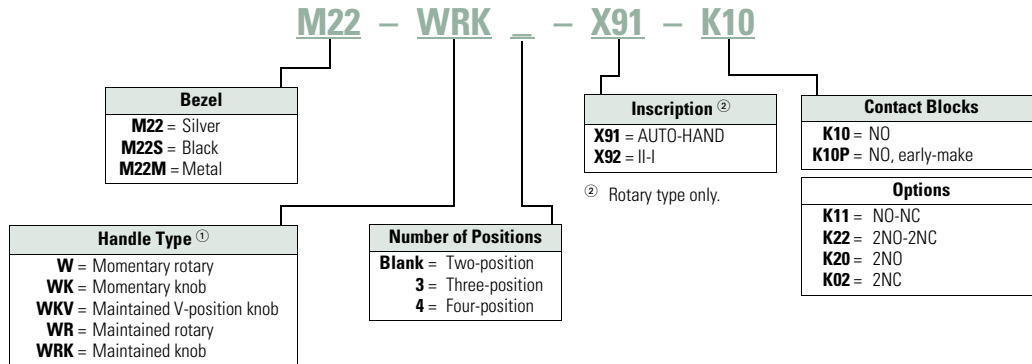

^① All momentary selector switches can be converted in the field to maintained operation with the removal of a color-coded adapter.

1

Product Selection

Non-Illuminated Selector Switches



M22-WKV-K10



M22M-WKV-K10

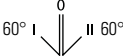

Complete Devices, Knob Type ①

Type	Switching Position	Contact Block Configuration ②	Silver Bezel Catalog Number	Black Bezel Catalog Number	Metal Bezel Catalog Number
Two-position	Maintained 	NO	M22-WRK-K10	M22S-WRK-K10	M22M-WRK-K10
		1NO-1NC	M22-WRK-K11	M22S-WRK-K11	M22M-WRK-K11
		2NO-2NC	M22-WRK-K22	M22S-WRK-K22	M22M-WRK-K22
Two-position	Maintained V 	NO	M22-WKV-K10	M22S-WKV-K10	M22M-WKV-K10
		1NO-1NC	M22-WKV-K11	M22S-WKV-K11	M22M-WKV-K11
		2NO-2NC	M22-WKV-K22	M22S-WKV-K22	M22M-WKV-K22
Three-position	Maintained 	2NO	M22-WRK3-K20	M22S-WRK3-K20	M22M-WRK3-K20
		2NO-2NC	M22-WRK3-K22	M22S-WRK3-K22	M22M-WRK3-K22

Notes

- ① Includes contact block mounting adapter.
- ② All NC contact blocks are positively driven contact. ⊖

Non-Illuminated Selector Switches

Components





M22-WK



M22M-WK

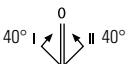
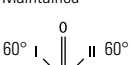
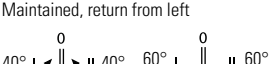
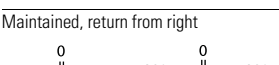
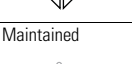

Operators Only, Knob Type ①

Type	Switching Position	Silver Bezel Catalog Number	Black Bezel Catalog Number	Metal Bezel Catalog Number
Two-position	Momentary ② 	M22-WK	M22S-WK	M22M-WK
	Maintained 	M22-WRK	M22S-WRK	M22M-WRK
	Maintained V 	M22-WKV	M22S-WKV	M22M-WKV
Three-position	Momentary ② 	M22-WK3	M22S-WK3	M22M-WK3
	Maintained 	M22-WRK3	M22S-WRK3	M22M-WRK3
	Maintained, return from left 	M22-WRK3-2	M22S-WRK3-2	M22M-WRK3-2
	Maintained, return from right 	M22-WRK3-1	M22S-WRK3-1	M22M-WRK3-1
	Maintained 	M22-WRK4	M22S-WRK4	M22M-WRK4
	Maintained 			

Notes

- ① Includes contact block mounting adapter.
- ② Momentary selector switches can be converted in the field to maintained operation with the removal of a color coded adapter. See **Page V7-T1-118**.

1

Non-Illuminated Selector Switches

Components

M22S-WR3-X94



Operators Only, Rotary Type ①

Type	Switching Position	Inscription	Silver Bezel Catalog Number	Black Bezel Catalog Number	Metal Bezel Catalog Number
Two-position	Momentary ②	I-O	M22-W	M22S-W	M22M-W
	Maintained	I-O	M22-WR	M22S-WR	M22M-WR
		Custom	M22-WR-ETCH ③	M22S-WR-ETCH ③	M22M-WR-ETCH ③
		AUTO-HAND	M22-WR-X91	M22S-WR-X91	M22M-WR-X91
		II-I	M22-WR-X92	M22S-WR-X92	M22M-WR-X92
Three-position	Momentary ②	I-O-II	M22-W3	M22S-W3	M22M-W3
	Maintained	I-O-II	M22-WR3	M22S-WR3	M22M-WR3
		Custom	M22-WR3-ETCH ③	M22S-WR3-ETCH ③	M22M-WR3-ETCH ③
		AUTO-O-MAN	M22-WR3-X94	M22S-WR3-X94	M22M-WR3-X94
		0-1-0-2-0-3-0-4	M22-WR4	M22S-WR4	M22M-WR4

Notes

- ① Includes contact block mounting adapter.
- ② Momentary selector switches can be converted in the field to maintained operation with the removal of a color coded adapter. See **Page V7-T1-118**.
- ③ When ordering, specify inscription per catalog number suffix from the Symbols Library (see **Pages V7-T1-129 to V7-T1-136**) into the Order Notes. For example, M22-WR3-ETCH; Order Notes: Mark with symbol X88, Line item #_.

Non-Illuminated Selector Switches

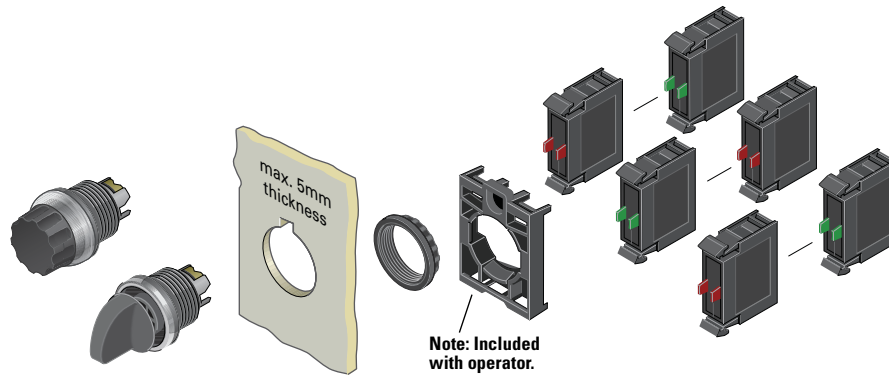

Components





M22-K10



Contact Blocks ①

Terminal Type	Contact Configuration ②	Catalog Number
Screw	NO	M22-K10
	NO, early-make	M22-K10P
	NC	M22-K01
	NC, late-break	M22-K01D
Spring-cage	NO	M22-CK10
	NC	M22-CK01
	NC, late-break	M22-CK01D
	2NO	M22-CK20
	2NC	M22-CK02
	NO-NC	M22-CK11

Accessories

	Description	Catalog Number
M22-XW 	Plunger bridge ③	M22-XW
M22-XWS 	Key cover	M22-XWS
M22-XC-R 	Key withdraw adapter ④	M22-XC-R
M22-XC-Y 	Coding adapter	M22-XC-Y
M22-XGWK 	Guard ring	M22-XGWK

Notes

- ① For complete listing of available contact blocks, see Accessories, Pages V7-T1-111 to V7-T1-116.
- ② All NC contact blocks are positively driven contact. ⊖
- ③ Plunger needed to actuate center-mounted contact blocks. Used for non-illuminated three-position selector switches only.
- ④ Enables a keyed selector switch to be set to user-selected key withdraw position.

1

Catalog Number Selection

Catalog Number Selection is for illustrative purposes only and not to be used to create new catalog numbers.

Illuminated Selector Switches

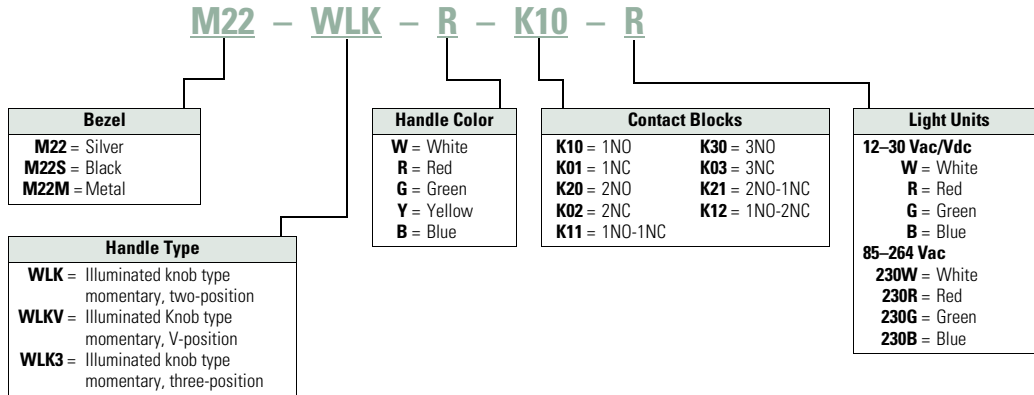

Product Selection



Illuminated Selector Switches

Components

M22-WLK-W

Operators Only, Knob Type ^①



Type	Switching Position	Button Color	Silver Bezel Catalog Number	Black Bezel Catalog Number	Metal Bezel Catalog Number
Two-position	Momentary ^② 	White	M22-WLK-W	M22S-WLK-W	M22M-WLK-W
		Red	M22-WLK-R	M22S-WLK-R	M22M-WLK-R
		Green	M22-WLK-G	M22S-WLK-G	M22M-WLK-G
		Yellow	M22-WLK-Y	M22S-WLK-Y	M22M-WLK-Y
		Blue	M22-WLK-B	M22S-WLK-B	M22M-WLK-B
	Maintained 	White	M22-WRLK-W	M22S-WRLK-W	M22M-WRLK-W
		Red	M22-WRLK-R	M22S-WRLK-R	M22M-WRLK-R
		Green	M22-WRLK-G	M22S-WRLK-G	M22M-WRLK-G
		Yellow	M22-WRLK-Y	M22S-WRLK-Y	M22M-WRLK-Y
		Blue	M22-WRLK-B	M22S-WRLK-B	M22M-WRLK-B
	Maintained V 	White	M22-WLKV-W	M22S-WLKV-W	M22M-WLKV-W
		Red	M22-WLKV-R	M22S-WLKV-R	M22M-WLKV-R
		Green	M22-WLKV-G	M22S-WLKV-G	M22M-WLKV-G
		Yellow	M22-WLKV-Y	M22S-WLKV-Y	M22M-WLKV-Y
		Blue	M22-WLKV-B	M22S-WLKV-B	M22M-WLKV-B

Notes

^① Includes contact block mounting adapter.

^② Momentary selector switches can be converted in the field to maintained operation with the removal of a color coded adapter. See **Page V7-T1-118**.

1



Illuminated Selector Switches

Components

M22-WLK3-W

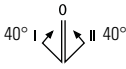
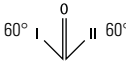

Operators Only, Knob Type ①

Type	Switching Position	Button Color	Silver Bezel Catalog Number	Black Bezel Catalog Number	Metal Bezel Catalog Number
Three-position	Momentary ② 	White	M22-WLK3-W	M22S-WLK3-W	M22M-WLK3-W
		Red	M22-WLK3-R	M22S-WLK3-R	M22M-WLK3-R
		Green	M22-WLK3-G	M22S-WLK3-G	M22M-WLK3-G
		Yellow	M22-WLK3-Y	M22S-WLK3-Y	M22M-WLK3-Y
		Blue	M22-WLK3-B	M22S-WLK3-B	M22M-WLK3-B
	Maintained 	White	M22-WRLK3-W	M22S-WRLK3-W	M22M-WRLK3-W
		Red	M22-WRLK3-R	M22S-WRLK3-R	M22M-WRLK3-R
		Green	M22-WRLK3-G	M22S-WRLK3-G	M22M-WRLK3-G
		Yellow	M22-WRLK3-Y	M22S-WRLK3-Y	M22M-WRLK3-Y
		Blue	M22-WRLK3-B	M22S-WRLK3-B	M22M-WRLK3-B
	Maintained, return from right 	White	M22-WRLK3-1-W	M22S-WRLK3-1-W	M22M-WRLK3-1-W
		Red	M22-WRLK3-1-R	M22S-WRLK3-1-R	M22M-WRLK3-1-R
Green		M22-WRLK3-1-G	M22S-WRLK3-1-G	M22M-WRLK3-1-G	
Yellow		M22-WRLK3-1-Y	M22S-WRLK3-1-Y	M22M-WRLK3-1-Y	
Blue		M22-WRLK3-1-B	M22S-WRLK3-1-B	M22M-WRLK3-1-B	
Maintained, return from left 	White	M22-WRLK3-2-W	M22S-WRLK3-2-W	M22M-WRLK3-2-W	
	Red	M22-WRLK3-2-R	M22S-WRLK3-2-R	M22M-WRLK3-2-R	
	Green	M22-WRLK3-2-G	M22S-WRLK3-2-G	M22M-WRLK3-2-G	
	Yellow	M22-WRLK3-2-Y	M22S-WRLK3-2-Y	M22M-WRLK3-2-Y	
	Blue	M22-WRLK3-2-B	M22S-WRLK3-2-B	M22M-WRLK3-2-B	

Notes

- ① Includes contact block mounting adapter.
- ② Momentary selector switches can be converted in the field to maintained operation with the removal of a color coded adapter. See [Page V7-T1-118](#).

Illuminated Selector Switches

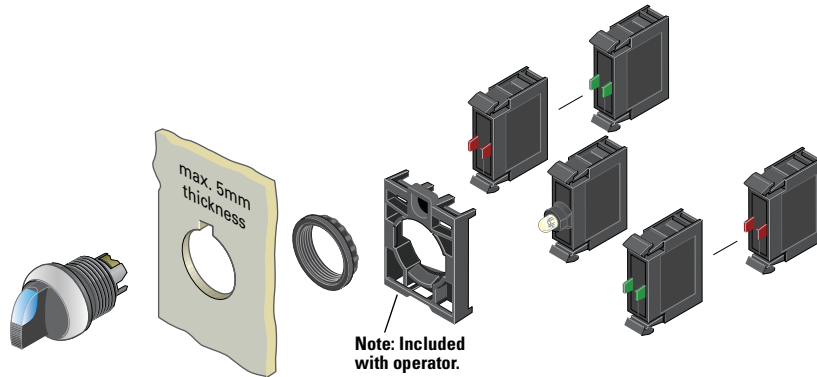

M22-LED-W



Light Units ①⑤

Terminal Type	LED Color	Light Unit Voltage	Catalog Number
Screw	White	12–30 Vac/Vdc	M22-LED-W
	Red		M22-LED-R
	Green		M22-LED-G
	Blue		M22-LED-B
Screw	White	85–264 Vac	M22-LED230-W
	Red		M22-LED230-R
	Green		M22-LED230-G
	Blue		M22-LED230-B

Accessories

	Description	Catalog Number
M22-XW	Plunger bridge ②	M22-XW
M22-XWS	Key cover	M22-XWS
M22-XC-R	Key withdraw adapter ④	M22-XC-R
M22-XC-Y	Coding adapter	M22-XC-Y
M22-XGWK	Guard ring	M22-XGWK

M22-K10



Contact Blocks ①

Terminal Type	Contact Configuration ③	Catalog Number
Screw	NO	M22-K10
	NO, early-make	M22-K10P
	NC	M22-K01
	NC, late-break	M22-K01D
Spring-cage	NO	M22-CK10
	NC	M22-CK01
	NC, late-break	M22-CK01D
	2NO	M22-CK20
	2NC	M22-CK02
	NO-NC	M22-CK11

Notes

- ① For complete listing of available light units and contact blocks, see Accessories, **Pages V7-T1-111 to V7-T1-116.**
- ② Plunger needed to actuate center-mounted contact blocks. Used for non-illuminated three-position selector switches only.
- ③ All NC contact blocks are positively driven contact. ⊖
- ④ Enables a keyed selector switch to be set to user-selected key withdraw position.
- ⑤ Select the same color LED element as lens color; for yellow lens, choose a white LED.

1

Catalog Number Selection

Catalog Number Selection is for illustrative purposes only and not to be used to create new catalog numbers.

Key-Operated Selector Switches

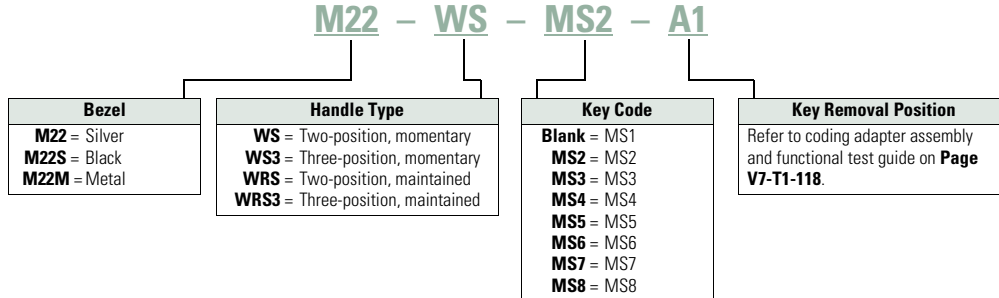

Product Selection

Key-Operated Selector Switches ^{①②}

Components

M22-WS



Operators Only ^③

M22S-WRS



Type	Switching Position	Key Removal Position	Key Code	Silver Bezel Catalog Number	Black Bezel Catalog Number	Metal Bezel Catalog Number	
Two-position	Momentary ^④ 40°	Return from right, key removable left	MS1	M22-WS	M22S-WS	M22M-WS	
			MS2	M22-WS-MS2	M22S-WS-MS2	M22M-WS-MS2	
			MS3	M22-WS-MS3	M22S-WS-MS3	M22M-WS-MS3	
			MS4	M22-WS-MS4	M22S-WS-MS4	M22M-WS-MS4	
			MS5	M22-WS-MS5	M22S-WS-MS5	M22M-WS-MS5	
			MS6	M22-WS-MS6	M22S-WS-MS6	M22M-WS-MS6	
			MS7	M22-WS-MS7	M22S-WS-MS7	M22M-WS-MS7	
			MS8	M22-WS-MS8	M22S-WS-MS8	M22M-WS-MS8	
Two-position	Maintained 40°	Key removable left	MS1	M22-WRS-A1	M22S-WRS-A1	M22M-WRS-A1	
			MS2	M22-WRS-MS2-A1	M22S-WRS-MS2-A1	M22M-WRS-MS2-A1	
			MS3	M22-WRS-MS3-A1	M22S-WRS-MS3-A1	M22M-WRS-MS3-A1	
			MS4	M22-WRS-MS4-A1	M22S-WRS-MS4-A1	M22M-WRS-MS4-A1	
			MS5	M22-WRS-MS5-A1	M22S-WRS-MS5-A1	M22M-WRS-MS5-A1	
			MS6	M22-WRS-MS6-A1	M22S-WRS-MS6-A1	M22M-WRS-MS6-A1	
			MS7	M22-WRS-MS7-A1	M22S-WRS-MS7-A1	M22M-WRS-MS7-A1	
			MS8	M22-WRS-MS8-A1	M22S-WRS-MS8-A1	M22M-WRS-MS8-A1	
	Key removable left/right			MS1	M22-WRS	M22S-WRS	M22M-WRS
				MS2	M22-WRS-MS2	M22S-WRS-MS2	M22M-WRS-MS2
				MS3	M22-WRS-MS3	M22S-WRS-MS3	M22M-WRS-MS3
				MS4	M22-WRS-MS4	M22S-WRS-MS4	M22M-WRS-MS4
				MS5	M22-WRS-MS5	M22S-WRS-MS5	M22M-WRS-MS5
				MS6	M22-WRS-MS6	M22S-WRS-MS6	M22M-WRS-MS6
				MS7	M22-WRS-MS7	M22S-WRS-MS7	M22M-WRS-MS7
				MS8	M22-WRS-MS8	M22S-WRS-MS8	M22M-WRS-MS8

Notes

- ① Includes one key.
- ② Key removal positions can be modified in the field using coding adapters; see chart on **Page V7-T1-118**.
- ③ Includes contact block mounting adapter.
- ④ Momentary selector switches can be converted in the field to maintained operation with the removal of a color coded adapter. See **Page V7-T1-118**.

Key-Operated Selector Switches ①②

Components

M22-WS3-X93

Operators Only, continued ③



M22M-WS3-X93

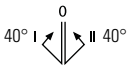
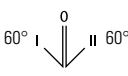

Type	Switching Position	Key Removal Position	Key Code	Silver Bezel Catalog Number	Black Bezel Catalog Number	Metal Bezel Catalog Number
Three-position	Momentary ④ 	Return from left/right, key removable center	MS1	M22-WS3	M22S-WS3	M22M-WS3
			MS2	M22-WS3-MS2	M22S-WS3-MS2	M22M-WS3-MS2
			MS3	M22-WS3-MS3	M22S-WS3-MS3	M22M-WS3-MS3
			MS4	M22-WS3-MS4	M22S-WS3-MS4	M22M-WS3-MS4
			MS5	M22-WS3-MS5	M22S-WS3-MS5	M22M-WS3-MS5
			MS6	M22-WS3-MS6	M22S-WS3-MS6	M22M-WS3-MS6
			MS7	M22-WS3-MS7	M22S-WS3-MS7	M22M-WS3-MS7
			MS8	M22-WS3-MS8	M22S-WS3-MS8	M22M-WS3-MS8
			Three-position	Maintained 	Key removable left/center/right	MS1
MS2	M22-WRS3-MS2-A1	M22S-WRS3-MS2-A1				M22M-WRS3-MS2-A1
MS3	M22-WRS3-MS3-A1	M22S-WRS3-MS3-A1				M22M-WRS3-MS3-A1
MS4	M22-WRS3-MS4-A1	M22S-WRS3-MS4-A1				M22M-WRS3-MS4-A1
MS5	M22-WRS3-MS5-A1	M22S-WRS3-MS5-A1				M22M-WRS3-MS5-A1
MS6	M22-WRS3-MS6-A1	M22S-WRS3-MS6-A1				M22M-WRS3-MS6-A1
MS7	M22-WRS3-MS7-A1	M22S-WRS3-MS7-A1				M22M-WRS3-MS7-A1
MS8	M22-WRS3-MS8-A1	M22S-WRS3-MS8-A1				M22M-WRS3-MS8-A1
Key removable center/left	MS1	M22-WRS3-A2			M22S-WRS3-A2	M22M-WRS3-A2
	MS2	M22-WRS3-MS2-A2			M22S-WRS3-MS2-A2	M22M-WRS3-MS2-A2
	MS3	M22-WRS3-MS3-A2			M22S-WRS3-MS3-A2	M22M-WRS3-MS3-A2
	MS4	M22-WRS3-MS4-A2			M22S-WRS3-MS4-A2	M22M-WRS3-MS4-A2
	MS5	M22-WRS3-MS5-A2			M22S-WRS3-MS5-A2	M22M-WRS3-MS5-A2
	MS6	M22-WRS3-MS6-A2			M22S-WRS3-MS6-A2	M22M-WRS3-MS6-A2
	MS7	M22-WRS3-MS7-A2			M22S-WRS3-MS7-A2	M22M-WRS3-MS7-A2
	MS8	M22-WRS3-MS8-A2			M22S-WRS3-MS8-A2	M22M-WRS3-MS8-A2
Key removable center/right	MS1	M22-WRS3-A3			M22S-WRS3-A3	M22M-WRS3-A3
	MS2	M22-WRS3-MS2-A3			M22S-WRS3-MS2-A3	M22M-WRS3-MS2-A3
	MS3	M22-WRS3-MS3-A3			M22S-WRS3-MS3-A3	M22M-WRS3-MS3-A3
	MS4	M22-WRS3-MS4-A3			M22S-WRS3-MS4-A3	M22M-WRS3-MS4-A3
	MS5	M22-WRS3-MS5-A3			M22S-WRS3-MS5-A3	M22M-WRS3-MS5-A3
	MS6	M22-WRS3-MS6-A3			M22S-WRS3-MS6-A3	M22M-WRS3-MS6-A3
	MS7	M22-WRS3-MS7-A3			M22S-WRS3-MS7-A3	M22M-WRS3-MS7-A3
	MS8	M22-WRS3-MS8-A3			M22S-WRS3-MS8-A3	M22M-WRS3-MS8-A3
Key removable left/right	MS1	M22-WRS3			M22S-WRS3	M22M-WRS3
	MS2	M22-WRS3-MS2			M22S-WRS3-MS2	M22M-WRS3-MS2
	MS3	M22-WRS3-MS3			M22S-WRS3-MS3	M22M-WRS3-MS3
	MS4	M22-WRS3-MS4			M22S-WRS3-MS4	M22M-WRS3-MS4
	MS5	M22-WRS3-MS5			M22S-WRS3-MS5	M22M-WRS3-MS5
	MS6	M22-WRS3-MS6			M22S-WRS3-MS6	M22M-WRS3-MS6
	MS7	M22-WRS3-MS7			M22S-WRS3-MS7	M22M-WRS3-MS7
	MS8	M22-WRS3-MS8			M22S-WRS3-MS8	M22M-WRS3-MS8

Notes

- ① Includes one key.
- ② Key removal positions can be modified in the field using coding adapters; see chart on **Page V7-T1-118**.
- ③ Includes contact block mounting adapter.
- ④ Momentary selector switches can be converted in the field to maintained operation with the removal of a color coded adapter. See **Page V7-T1-118**.

Key-Operated Selector Switches ^{①②}

Components

M22-WS3-X93



M22M-WS3-X93

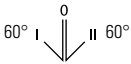
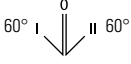

Operators Only, continued ^③

Type	Switching Position	Key Removal Position	Key Code	Silver Bezel Catalog Number	Black Bezel Catalog Number	Metal Bezel Catalog Number
Three-position	Maintained 	Return from left, key removable center	MS1	M22-WRS3-A7	M22S-WRS3-A7	M22M-WRS3-A7
			MS2	M22-WRS3-MS2-A7	M22S-WRS3-MS2-A7	M22M-WRS3-MS2-A7
			MS3	M22-WRS3-MS3-A7	M22S-WRS3-MS3-A7	M22M-WRS3-MS3-A7
			MS4	M22-WRS3-MS4-A7	M22S-WRS3-MS4-A7	M22M-WRS3-MS4-A7
			MS5	M22-WRS3-MS5-A7	M22S-WRS3-MS5-A7	M22M-WRS3-MS5-A7
			MS6	M22-WRS3-MS6-A7	M22S-WRS3-MS6-A7	M22M-WRS3-MS6-A7
			MS7	M22-WRS3-MS7-A7	M22S-WRS3-MS7-A7	M22M-WRS3-MS7-A7
			MS8	M22-WRS3-MS8-A7	M22S-WRS3-MS8-A7	M22M-WRS3-MS8-A7
	Return from left, key removable center/right	MS1	M22-WRS3-A6	M22S-WRS3-A6	M22M-WRS3-A6	
		MS2	M22-WRS3-MS2-A6	M22S-WRS3-MS2-A6	M22M-WRS3-MS2-A6	
		MS3	M22-WRS3-MS3-A6	M22S-WRS3-MS3-A6	M22M-WRS3-MS3-A6	
		MS4	M22-WRS3-MS4-A6	M22S-WRS3-MS4-A6	M22M-WRS3-MS4-A6	
		MS5	M22-WRS3-MS5-A6	M22S-WRS3-MS5-A6	M22M-WRS3-MS5-A6	
		MS6	M22-WRS3-MS6-A6	M22S-WRS3-MS6-A6	M22M-WRS3-MS6-A6	
		MS7	M22-WRS3-MS7-A6	M22S-WRS3-MS7-A6	M22M-WRS3-MS7-A6	
		MS8	M22-WRS3-MS8-A6	M22S-WRS3-MS8-A6	M22M-WRS3-MS8-A6	
Three-position	Maintained 	Return from right, key removable left/center	MS1	M22-WRS3-A4	M22S-WRS3-A4	M22M-WRS3-A4
			MS2	M22-WRS3-MS2-A4	M22S-WRS3-MS2-A4	M22M-WRS3-MS2-A4
			MS3	M22-WRS3-MS3-A4	M22S-WRS3-MS3-A4	M22M-WRS3-MS3-A4
			MS4	M22-WRS3-MS4-A4	M22S-WRS3-MS4-A4	M22M-WRS3-MS4-A4
			MS5	M22-WRS3-MS5-A4	M22S-WRS3-MS5-A4	M22M-WRS3-MS5-A4
			MS6	M22-WRS3-MS6-A4	M22S-WRS3-MS6-A4	M22M-WRS3-MS6-A4
			MS7	M22-WRS3-MS7-A4	M22S-WRS3-MS7-A4	M22M-WRS3-MS7-A4
			MS8	M22-WRS3-MS8-A4	M22S-WRS3-MS8-A4	M22M-WRS3-MS8-A4
	Return from right, key removable center	MS1	M22-WRS3-A5	M22S-WRS3-A5	M22M-WRS3-A5	
		MS2	M22-WRS3-MS2-A5	M22S-WRS3-MS2-A5	M22M-WRS3-MS2-A5	
		MS3	M22-WRS3-MS3-A5	M22S-WRS3-MS3-A5	M22M-WRS3-MS3-A5	
		MS4	M22-WRS3-MS4-A5	M22S-WRS3-MS4-A5	M22M-WRS3-MS4-A5	
		MS5	M22-WRS3-MS5-A5	M22S-WRS3-MS5-A5	M22M-WRS3-MS5-A5	
		MS6	M22-WRS3-MS6-A5	M22S-WRS3-MS6-A5	M22M-WRS3-MS6-A5	
		MS7	M22-WRS3-MS7-A5	M22S-WRS3-MS7-A5	M22M-WRS3-MS7-A5	
		MS8	M22-WRS3-MS8-A5	M22S-WRS3-MS8-A5	M22M-WRS3-MS8-A5	

Notes

- ① Includes one key.
- ② Key removal positions can be modified in the field using coding adapters; see chart on [Page V7-T1-118](#).
- ③ Includes contact block mounting adapter.

Key-Operated Selector Switches

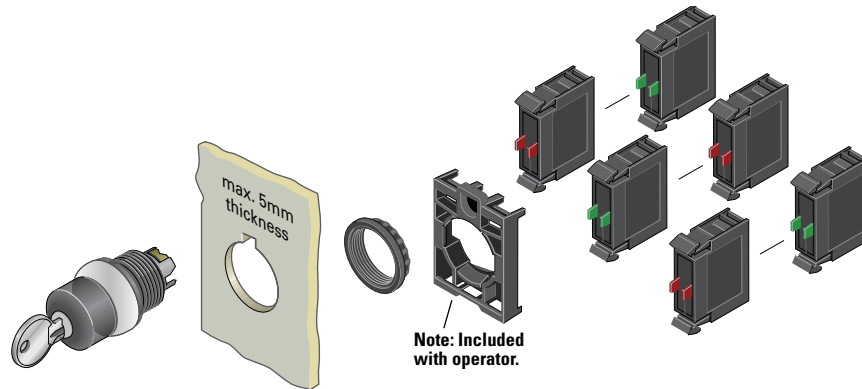

Components

M22-K10



Contact Blocks ^①

Terminal Type	Contact Configuration ^②	Catalog Number
Screw	NO	M22-K10
	NO, early-make	M22-K10P
	NC	M22-K01
	NC, late-break	M22-K01D
Spring-cage	NO	M22-CK10
	NC	M22-CK01
	NC, late-break	M22-CK01D
	2NO	M22-CK20
	2NC	M22-CK02
	NO-NC	M22-CK11





M22-ES-MS1



Extra Keys

Key Code	Catalog Number
MS1	M22-ES-MS1
MS2	M22-ES-MS2
MS3	M22-ES-MS3
MS4	M22-ES-MS4
MS5	M22-ES-MS5
MS6	M22-ES-MS6
MS7	M22-ES-MS7
MS8	M22-ES-MS8

Accessories

	Description	Catalog Number
M22-XW 	Plunger bridge ^③	M22-XW
M22-XWS 	Key cover	M22-XWS
M22-XC-R 	Key withdraw adapter ^④	M22-XC-R
M22-XC-Y 	Coding adapter	M22-XC-Y
M22-XGWK 	Guard ring	M22-XGWK

Notes

- ① For complete listing of available contact blocks, see Accessories, Pages V7-T1-111 to V7-T1-116.
- ② All NC contact blocks are positively driven contact. ⊖
- ③ Plunger needed to actuate center-mounted contact blocks. Used for non-illuminated three-position selector switches only.
- ④ Enables a keyed selector switch to be set to user-selected key withdraw position.

1

Mushroom Head Pushbuttons**Product Description**

Eaton's M22 mushroom head operators are a durable and unique way to include standard pushbutton functionality. Like the standard pushbutton line, the maintained pushbuttons are field convertible to momentary. They also offer laser engraving and a robust five million mechanical operations on the standard momentary operator. As with all operators, they can be ordered as a ready to install complete device or as modular components.

Features

- Field convertible from maintained to momentary (available on maintained pushbuttons only)
- Customizable laser engraving on all buttons
- More than five million mechanical operations on momentary and one million on maintained pushbuttons
- Modular construction makes assembly fast and simplifies stocking of components and complete devices
- Capable of communicating via ASi protocol with ASi adapter modules

Protection Type

- IP67, IP69K
- NEMA 4X, 13

Catalog Number Selection

Catalog Number Selection is for illustrative purposes only and not to be used to create new catalog numbers.

Mushroom Head Pushbuttons

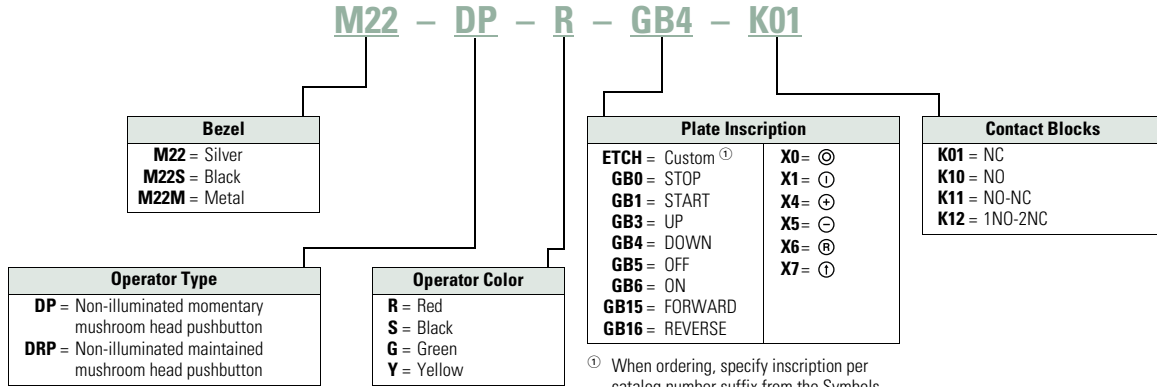

^① When ordering, specify inscription per catalog number suffix from the Symbols Library (see **Pages V7-T1-129 to V7-T1-136**) into the Order Notes. For example, M22-DP-R-ETCH; Order Notes: Mark with symbol X91, Line item #_.

1

Product Selection

Mushroom Head Pushbuttons, Momentary ^①

M22-DP-R-K01



M22S-DP-R-K01



M22M-DP-R-K01



Complete Devices

Button Color	Contact Block Configuration ^②	Silver Bezel Catalog Number	Black Bezel Catalog Number	Metal Bezel Catalog Number
Red	NC	M22-DP-R-K01	M22S-DP-R-K01	M22M-DP-R-K01
	2NC	M22-DP-R-K02	M22S-DP-R-K02	M22M-DP-R-K02
	1NO-2NC	M22-DP-R-K12	M22S-DP-R-K12	M22M-DP-R-K12
	1NO-1NC	M22-DP-R-K11	M22S-DP-R-K11	M22M-DP-R-K11

M22-DP-G



M22S-DP-G



M22M-DP-G

Operators Only ^②

Button Color	Silver Bezel Catalog Number	Black Bezel Catalog Number	Metal Bezel Catalog Number
Black	M22-DP-S	M22S-DP-S	M22M-DP-S
Red	M22-DP-R	M22S-DP-R	M22M-DP-R
Green	M22-DP-G	M22S-DP-G	M22M-DP-G
Yellow	M22-DP-Y	M22S-DP-Y	M22M-DP-Y

Notes

- ① 35 mm diameter mushroom head button.
- ② Includes contact block mounting adapter.

Non-Illuminated Mushroom Head Pushbuttons, Momentary ^①

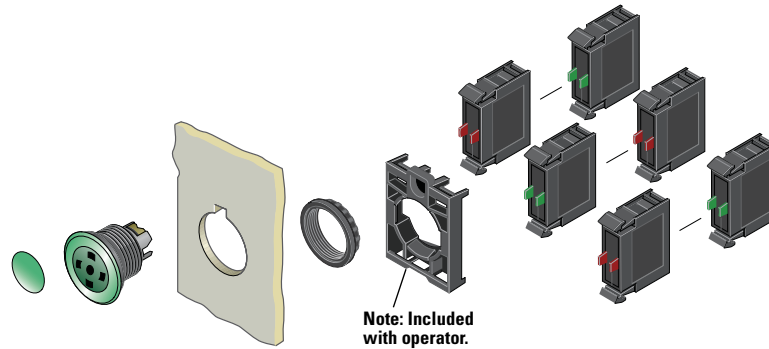

Components

M22-XDP-G



Mushroom Head Plates

Color	Inscription	Catalog Number
Black	—	M22-XDP-S ^②
	Custom	M22-XDP-S-ETCH ^③
	STOP	M22-XDP-S-GB0
	START	M22-XDP-S-GB1
	FORWARD	M22-XDP-S-GB15
	REVERSE	M22-XDP-S-GB16
	UP	M22-XDP-S-GB3
	DOWN	M22-XDP-S-GB4
	OFF	M22-XDP-S-GB5
	ON	M22-XDP-S-GB6
	⊙	M22-XDP-S-X0
	①	M22-XDP-S-X1
	+	M22-XDP-S-X4
	−	M22-XDP-S-X5
①	M22-XDP-S-X7	
Red	—	M22-XDP-R ^②
	Custom	M22-XDP-R-ETCH ^③
	STOP	M22-XDP-R-GB0
	OFF	M22-XDP-R-GB5
Green	—	M22-XDP-G ^②
	Custom	M22-XDP-G-ETCH ^③
	START	M22-XDP-G-GB1
	ON	M22-XDP-G-GB6
	⊙	M22-XDP-G-X0
White	—	M22-XDP-W ^②
	Custom	M22-XDP-W-ETCH ^③
	—	M22-XDP-Y ^②
Yellow	—	M22-XDP-Y ^②
	Custom	M22-XDP-Y-ETCH ^③

M22-DP-G-X



Insertless Mushroom Head Operators

Bezel	Color	Catalog Number
Silver	Black	M22-DP-S-X
	Red	M22-DP-R-X
	Green	M22-DP-G-X
	Yellow	M22-DP-Y-X
Black	Black	M22S-DP-S-X
	Red	M22S-DP-R-X
	Green	M22S-DP-G-X
Metal	Black	M22M-DP-S-X
	Red	M22M-DP-R-X
	Green	M22M-DP-G-X
	Yellow	M22M-DP-Y-X

M22-K10



Contact Blocks ^④

Terminal Type	Contact Configuration ^⑤	Catalog Number
Screw	NO	M22-K10
	NO, early-make	M22-K10P
	NC	M22-K01
	NC, late-break	M22-K01D
Spring-cage	NO	M22-CK10
	NC	M22-CK01
	NC, late-break	M22-CK01D
	2NO	M22-CK20
	2NC	M22-CK02
	NO-NC	M22-CK11

Notes

- ① 35 mm diameter mushroom head button.
- ② Minimum order quantity of (10).
- ③ When ordering, specify inscription per catalog number suffix from the Symbols Library (see **Pages V7-T1-129 to V7-T1-136**) into the Order Notes. For example, M22-XDP-S-ETCH; Order Notes: Mark with symbol X91, Line item #_.
- ④ For complete listing of available contact blocks, see Accessories, **Pages V7-T1-111 to V7-T1-116**.
- ⑤ All NC contact blocks are positively driven contact. ⊖

1

Product Selection

Non-Illuminated Mushroom Head Pushbuttons, Maintained ^{① ②}

M22-DRP-R-K01



M22S-DRP-R-K01



M22M-DRP-R-K01



Complete Devices

Button Color	Contact Block Configuration ^③	Silver Bezel Catalog Number	Black Bezel Catalog Number	Metal Bezel Catalog Number
Red	NC	M22-DRP-R-K01	M22S-DRP-R-K01	M22M-DRP-R-K01
	2NC	M22-DRP-R-K02	M22S-DRP-R-K02	M22M-DRP-R-K02
	1NO-2NC	M22-DRP-R-K12	M22S-DRP-R-K12	M22M-DRP-R-K12
	1NO-1NC	M22-DRP-R-K11	M22S-DRP-R-K11	M22M-DRP-R-K11

M22-DRP-G



M22S-DRP-G



M22M-DRP-G



Operators Only

Button Color	Silver Bezel Catalog Number	Black Bezel Catalog Number	Metal Bezel Catalog Number
Black	M22-DRP-S	M22S-DRP-S	M22M-DRP-S
Red	M22-DRP-R	M22S-DRP-R	M22M-DRP-R
Green	M22-DRP-G	M22S-DRP-G	M22M-DRP-G
Yellow	M22-DRP-Y	M22S-DRP-Y	M22M-DRP-Y

Notes

- ① 35 mm diameter mushroom head button.
- ② Maintained pushbuttons can be converted in the field to momentary operation by switching the locking ring, which is accessible through the side of the operator body.
- ③ All NC contact blocks are positively driven contact. 

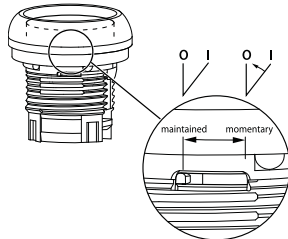

Note: This pilot device features a selectable function switch that enables the device to be set to either maintained or momentary operation.

Non-Illuminated Mushroom Head Pushbuttons, Maintained ^{①②}

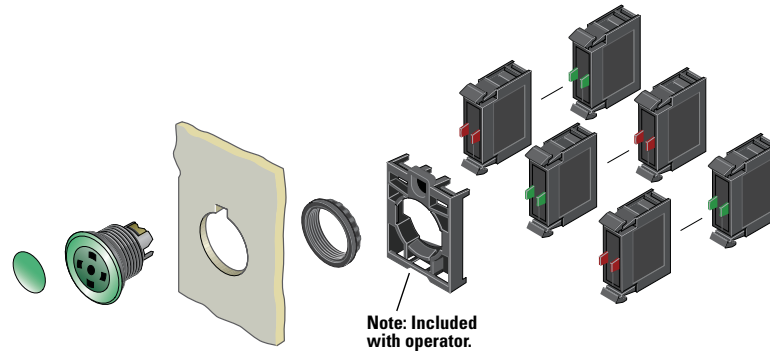

Components

M22-XDP-G



Mushroom Head Plates ^③

Color	Inscription	Catalog Number
Black	—	M22-XDP-S ^③
	Custom	M22-XDP-S-ETCH ^④
	STOP	M22-XDP-S-GB0
	START	M22-XDP-S-GB1
	FORWARD	M22-XDP-S-GB15
	REVERSE	M22-XDP-S-GB16
	UP	M22-XDP-S-GB3
	DOWN	M22-XDP-S-GB4
	OFF	M22-XDP-S-GB5
	ON	M22-XDP-S-GB6
	⊙	M22-XDP-S-X0
	①	M22-XDP-S-X1
	+	M22-XDP-S-X4
	−	M22-XDP-S-X5
Ⓜ	M22-XDP-S-X7	
Red	—	M22-XDP-R ^③
	Custom	M22-XDP-R-ETCH ^④
	STOP	M22-XDP-R-GB0
	OFF	M22-XDP-R-GB5
Green	—	M22-XDP-G ^③
	Custom	M22-XDP-G-ETCH ^④
	START	M22-XDP-G-GB1
	ON	M22-XDP-G-GB6
	⊙	M22-XDP-G-X0
White	—	M22-XDP-W ^③
	Custom	M22-XDP-W-ETCH ^④
	—	M22-XDP-Y ^③
Yellow	Custom	M22-XDP-Y-ETCH ^④

M22-DRP-G-X



Insertless Mushroom Head Operators

Bezel	Color	Catalog Number
Silver	Black	M22-DRP-S-X
	Red	M22-DRP-R-X
	Green	M22-DRP-G-X
	Yellow	M22-DRP-Y-X
Black	Black	M22S-DRP-S-X
	Red	M22S-DRP-R-X
	Green	M22S-DRP-G-X
	Yellow	M22S-DRP-Y-X
Metal	Black	M22M-DRP-S-X
	Red	M22M-DRP-R-X
	Green	M22M-DRP-G-X
	Yellow	M22M-DRP-Y-X

M22-K10



Contact Blocks ^⑤

Terminal Type	Contact Configuration ^⑥	Catalog Number
Screw	NO	M22-K10
	NO, early-make	M22-K10P
	NC	M22-K01
	NC, late-break	M22-K01D
Spring-cage	NO	M22-CK10
	NC	M22-CK01
	NC, late-break	M22-CK01D
	2NO	M22-CK20
	2NC	M22-CK02
	NO-NC	M22-CK11

Notes

- ① 35 mm diameter mushroom head button.
- ② Maintained pushbuttons can be converted in the field to momentary operation by switching the locking ring, which is accessible through the side of the operator body.
- ③ Minimum order quantity of (10).
- ④ When ordering, specify inscription per catalog number suffix from the Symbols Library (see **Pages V7-T1-129 to V7-T1-136**) into the Order Notes. For example, M22-XDP-S-ETCH; Order Notes: Mark with symbol X91, Line item #_.
- ⑤ For complete listing of available button plates and contact blocks, see Accessories, **Pages V7-T1-111 to V7-T1-116**.
- ⑥ All NC contact blocks are positively driven contact. ⊖

1

Double Pushbuttons

Product Description

Eaton's M22 double pushbutton line is perfect for applications such as motor and pump starting, as well as anytime space is limited. In addition to the two buttons that fit in one 22 mm hole is the integrated white indicating light between them. These three operators allow for multiple functions to occur in a single space. Green/red, black/white and black/black color options along with laser engraving allow for further custom applications.

Features

- Flush and extended, as well as color options allow for the perfect combination button
- Integrated indicating light adds even more functionality in one standard 22 mm hole
- Customizable laser engraving on all buttons
- LED offering only for improved brightness quality and up to 100,000 hours of operation
- More than 200,000 mechanical operations
- Capable of communicating via ASi protocol with ASi adapter modules

Protection Type

- IP66
- NEMA 4X, 13

Catalog Number Selection

Catalog Number Selection is for illustrative purposes only and not to be used to create new catalog numbers.

Double Pushbuttons

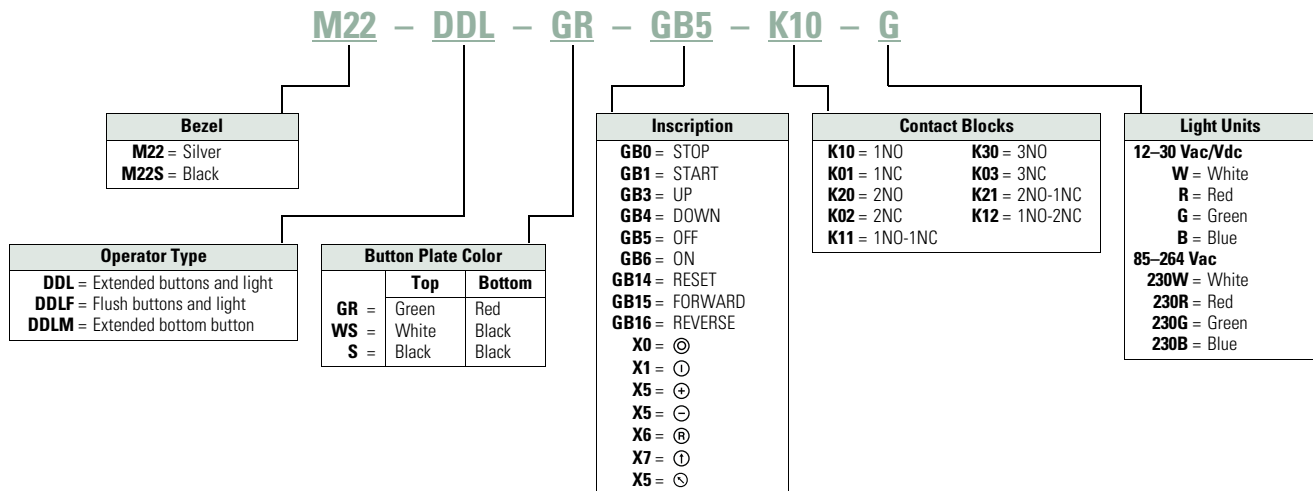



Product Selection

Components

Double Pushbuttons, Extended Pushbuttons and Center Light, Momentary

Operators Only ^①



	Bezel	Color Top	Bottom	Inscription Top	Bottom	Catalog Number		
 <p>M22-DDL-GR-GB1-GB0</p>	Silver	Green	Red	—	—	M22-DDL-GR		
				Custom	Custom	M22-DDL-GR-ETCH ^②		
				Ⓜ	Ⓜ	M22-DDL-GR-X1-X0		
				START	STOP	M22-DDL-GR-GB1-GB0		
		White	Black	—	—	—	—	M22-DDL-WS
				Custom	Custom	M22-DDL-WS-ETCH ^②		
				Ⓜ	Ⓜ	M22-DDL-WS-X1-X0		
				START	STOP	M22-DDL-WS-GB1-GB0		
		Black	Black	—	—	—	—	M22-DDL-S
				Custom	Custom	M22-DDL-S-ETCH ^②		
				—	—	M22-DDL-S-X4-X5		
				Ⓜ	Ⓜ	M22-DDL-S-X7-X7		
 <p>M22S-DDL-GR-X1-X0</p>	Black	Green	Red	—	—	M22S-DDL-GR		
				Custom	Custom	M22S-DDL-GR-ETCH ^②		
				Ⓜ	Ⓜ	M22S-DDL-GR-X1-X0		
				START	STOP	M22S-DDL-GR-GB1-GB0		
		White	Black	—	—	—	—	M22S-DDL-WS
				Custom	Custom	M22S-DDL-WS-ETCH ^②		
				Ⓜ	Ⓜ	M22S-DDL-WS-X1-X0		
				START	STOP	M22S-DDL-WS-GB1-GB0		
		Black	Black	—	—	—	—	M22S-DDL-S
				Custom	Custom	M22S-DDL-S-ETCH ^②		
				+	—	M22S-DDL-S-X4-X5		
				Ⓜ	Ⓜ	M22S-DDL-S-X7-X7		

Notes

- ① Includes contact block mounting adapter.
- ② When ordering, specify inscription per catalog number suffix from the Symbols Library (see **Pages V7-T1-129 to V7-T1-136**) into the Order Notes. For example, M22-DDL-S-ETCH; Order Notes: Mark with symbol X91, Line item #_.



Double Pushbuttons, Flush Top Pushbuttons and Center Light, Momentary

Operators Only ^①

	Bezel	Color Top	Bottom	Inscription Top	Bottom	Catalog Number
M22-DDLF-GR 	Silver	Green	Red	—	—	M22-DDLF-GR
				Custom	Custom	M22-DDLF-GR-ETCH ^②
		White	Black	—	—	M22-DDLF-WS
				Custom	Custom	M22-DDLF-WS-ETCH ^②
		Green	Red	①	⊙	M22-DDLF-GR-X1-X0
White	Black	①	⊙	M22-DDLF-WS-X1-X0		
M22S-DDLF-GR-X1-X0 	Black	Green	Red	—	—	M22S-DDLF-GR
				Custom	Custom	M22S-DDLF-GR-ETCH ^②
		White	Black	—	—	M22S-DDLF-WS
				Custom	Custom	M22S-DDLF-WS-ETCH ^②
		Green	Red	①	⊙	M22S-DDLF-GR-X1-X0
White	Black	①	⊙	M22S-DDLF-WS-X1-X0		

Double Pushbuttons, Flush Top Pushbutton and Center Light, Extended Bottom Pushbutton, Momentary

Operators Only ^①

	Bezel	Color Top	Bottom	Inscription Top	Bottom	Catalog Number
M22-DDLM-GR 	Silver	Green	Red	—	—	M22-DDLM-GR
				Custom	Custom	M22-DDLM-GR-ETCH ^②
		White	Black	—	—	M22-DDLM-WS
				Custom	Custom	M22-DDLM-WS-ETCH ^②
		Green	Red	①	⊙	M22-DDLM-GR-X1-X0
White	Black	①	⊙	M22-DDLM-WS-X1-X0		
M22S-DDLM-GR-X1-X0 	Black	Green	Red	—	—	M22S-DDLM-GR
				Custom	Custom	M22S-DDLM-GR-ETCH ^②
		White	Black	—	—	M22S-DDLM-WS
				Custom	Custom	M22S-DDLM-WS-ETCH ^②
		Green	Red	①	⊙	M22S-DDLM-GR-X1-X0
White	Black	①	⊙	M22S-DDLM-WS-X1-X0		

Notes

- ^① Includes contact block mounting adapter.
- ^② When ordering, specify inscription per catalog number suffix from the Symbols Library (see **Pages V7-T1-129 to V7-T1-136**) into the Order Notes. For example, M22-DDLM-GR-ETCH; Order Notes: Mark with symbol X91, Line item #_.

Double Pushbuttons

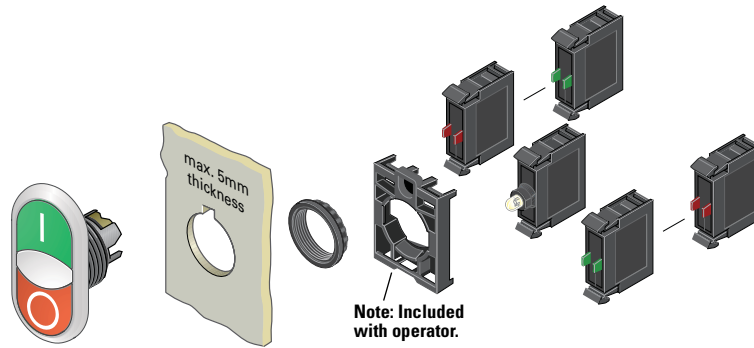

M22-LED-W



Light Units ①

Terminal Type	LED Color	Light Unit Voltage	Catalog Number
Screw	White	12–30 Vac/Vdc	M22-LED-W
		85–264 Vac	M22-LED230-W

M22-K10



Contact Blocks ①

Terminal Type	Contact Configuration ②	Catalog Number
Screw	NO	M22-K10
	NO, early-make	M22-K10P
	NC	M22-K01
	NC, late-break	M22-K01D
Spring-cage	NO	M22-CK10
	NC	M22-CK01
	NC, late-break	M22-CK01D
	2NO	M22-CK20
	2NC	M22-CK02
	NO-NC	M22-CK11

Notes

- ① For complete listing of available light units and contact blocks, see Accessories, Pages V7-T1-111 to V7-T1-116.
- ② All NC contact blocks are positively driven contact. ⊖

1

Four-Way Pushbuttons

Product Description

Eaton's M22 four-way pushbutton is a truly unique offering. A four-way pushbutton offers four different buttons mounted in a single 22 mm hole. This is ideal not only for an application with limited space, but also directional applications (when ordered with the four arrow engraving option). Another unique option is the interlocked version, which prevents two opposite buttons from being actuated at the same time.

Features

- Four buttons in one operator allows for increased functionality in limited space
- Optional interlocking option, which prevents two buttons from being actuated at the same time
- Customizable laser engraving on all buttons for directional or other applications
- Capable of communicating via ASi protocol with ASi adapter modules

Protection Type

- IP66

Catalog Number Selection

Catalog Number Selection is for illustrative purposes only and not to be used to create new catalog numbers.

Four-Way Pushbuttons

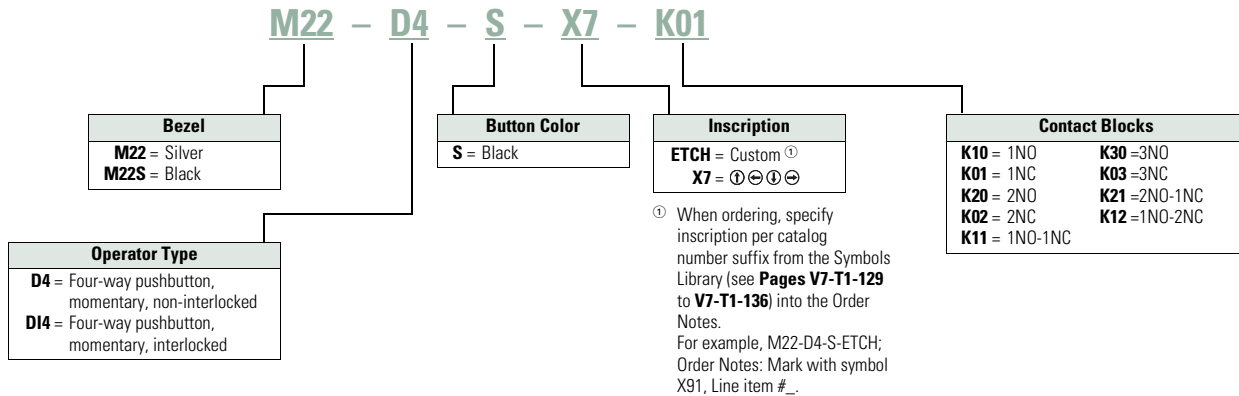

Product Selection

Four-Way Pushbuttons, Momentary

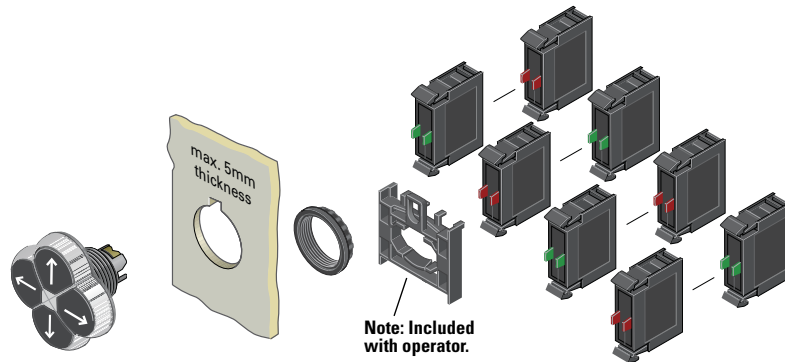

Components

M22-D4-S-X7



Operators Only ①

Type	Bezel	Color	Inscription	Catalog Number
Non-interlocked	Silver	Black	—	M22-D4-S
			Custom	M22-D4-S-ETCH ③
			Directional arrows	M22-D4-S-X7
	Black	Black	—	M22S-D4-S
			Custom	M22S-D4-S-ETCH ③
			Directional arrows	M22S-D4-S-X7
Interlocked	Silver	Black	—	M22-DI4-S
			Custom	M22-DI4-S-ETCH ③
			Directional arrows	M22-DI4-S-X7
	Black	Black	—	M22S-DI4-S
			Custom	M22S-DI4-S-ETCH ③
			Directional arrows	M22S-DI4-S-X7

M22-K10



Contact Blocks ②

Terminal Type	Contact Configuration	Catalog Number
Screw	NO	M22-K10
	NO, early-make	M22-K10P
	NC	M22-K01
	NC, late-break	M22-K01D
Spring-cage	NO	M22-CK10
	NC	M22-CK01
	NC, late-break	M22-CK01D
	2NO	M22-CK20
	2NC	M22-CK02
	NO-NC	M22-CK11

Notes

- ① Includes contact block mounting adapter.
- ② For complete listing of available contact blocks, see Accessories, **Pages V7-T1-111 to V7-T1-116**.
- ③ When ordering, specify inscription per catalog number suffix from the Symbols Library (see **Pages V7-T1-129 to V7-T1-136**) into the Order Notes.
For example, M22-D4-S-ETCH; Order Notes: Mark with symbol X91, Line item #_.
- ④ All NC contact blocks are positively driven contact. (⊖)

1

Joysticks

Product Description

Eaton's M22 joystick line comes in a wide variety of options. From vertical and horizontal two-position switches to the maintained four-position, these operators fit a variety of applications. An additional option, two switch points, allows for eight isolated circuits to be actuated individually on a single operator.

Features

- Available in four-position and two-position
- Two switch point option allows for two contacts in each direction (up to eight total contacts in one operator)
- Capable of communicating via ASi protocol with ASi adapter modules

Protection Type

- IP66

Product Selection

Joysticks

Components

M22-WJ2H



M22M-WJ2H



Operators ^①

Number of Directions	Switching Position	Silver Bezel Catalog Number	Black Bezel Catalog Number	Metal Bezel Catalog Number
Two-position horizontal	Momentary	M22-WJ2H	M22S-WJ2H	M22M-WJ2H
Two switch points		M22-WJ2H-2P	M22S-WJ2H-2P	M22M-WJ2H-2P
Two-position horizontal	Maintained	M22-WRJ2H	M22S-WRJ2H	M22M-WRJ2H
Two-position vertical	Momentary	M22-WJ2V	M22S-WJ2V	M22M-WJ2V
Two switch points		M22-WJ2V-2P	M22S-WJ2V-2P	M22M-WJ2V-2P
Two-position vertical	Maintained	M22-WRJ2V	M22S-WRJ2V	M22M-WRJ2V
Four-position	Momentary	M22-WJ4	M22S-WJ4	M22M-WJ4
Two switch points		M22-WJ4-2P	M22S-WJ4-2P	M22M-WJ4-2P
Four-position	Maintained	M22-WRJ4	M22S-WRJ4	M22M-WRJ4

Note

^① Includes contact block mounting adapter.

Joysticks

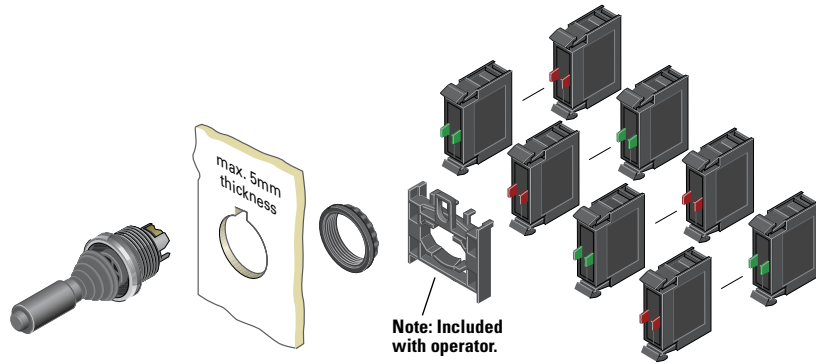

M22-K10



Contact Blocks ^{①②}

Terminal Type	Contact Configuration ^③	Catalog Number
Screw	NO	M22-K10
	NO, early-make	M22-K10P
	NC	M22-K01
Spring-cage	NC, late-break	M22-K01D
	NO	M22-CK10
	NC	M22-CK01
	NC, late-break	M22-CK01D
	2NO	M22-CK20
	2NC	M22-CK02
	NO-NC	M22-CK11

Notes

- ① Includes contact block mounting adapter.
- ② For complete listing of available contact blocks, see Accessories, **Pages V7-T1-111 to V7-T1-116.**
- ③ All NC contact blocks are positively driven contact. ⊖

Joystick with Double Contact

The joystick allows the control of up to four directions of movement on machines. Different variants of the joystick have two/four-positions and other variants have two settings for each position. This allows, for example, two-speed settings for each direction. For this application, a standard normally open contact and an early-make contact are fitted in series. Momentary contact and latching contact versions are available.

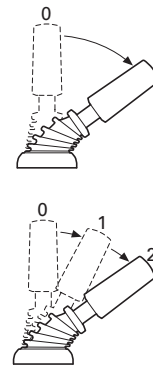

Potentiometers

Product Description

Eaton's M22 potentiometers allow for a ready to use operator in a conveniently sized package. M22 potentiometers include the resistive element, instead of just a knob, and a built in legend surrounding the knob. The slim design, with integrated contacts and the range of resistances available, allows for a quick install.

Features

- Scale markings on the knob allows the operator to be used without an additional legend plate
- Oversized knob option available
- Slim design allows for space saving and simple wiring and installation

Protection Type

- IP66
- NEMA 4X, 13

Product Selection

Potentiometers

M22-R10K



M22M-R10K



Complete Devices

Bezel	Resistance Rk	Catalog Number	
Silver	1	M22-R1K	
	4.7	M22-R4K7	
	10	M22-R10K	
	47	M22-R47K	
	100	M22-R100K	
Black	470	M22-R470K	
	1	M22S-R1K	
	4.7	M22S-R4K7	
	10	M22S-R10K	
	47	M22S-R47K	
Metal	100	M22S-R100K	
	470	M22S-R470K	
	1	M22M-R1K	
	4.7	M22M-R4K7	
	10	M22M-R10K	
	47	M22M-R47K	
	100	M22M-R100K	
	470	M22M-R470K	
	Oversized Knob		
	Silver	1	M22-R1K-RH
4.7		M22-R4K7-RH	
10		M22-R10K-RH	
47		M22-R47K-RH	
100		M22-R100K-RH	
Black	470	M22-R470K-RH	
	1	M22S-R1K-RH	
	4.7	M22S-R4K7-RH	
	10	M22S-R10K-RH	
	47	M22S-R47K-RH	
Metal	100	M22S-R100K-RH	
	470	M22S-R470K-RH	
	1	M22M-R1K-RH	
	4.7	M22M-R4K7-RH	
	10	M22M-R10K-RH	
	47	M22M-R47K-RH	
	100	M22M-R100K-RH	
	470	M22M-R470K-RH	

Acoustic Devices

Product Description

Eaton's M22 acoustic devices are a simple and aesthetic way to add a buzzer or indicator to any application. Fitting in the same 22 mm hole, these devices can be ordered in continuous or pulsed tone and with or without the IP40 enclosure.

Features

- Continuous or pulsed tone available
- 83 dB / 10 cm decibel rating
- Slim design allows for space saving and simple wiring and installation

Protection Type

- IP40
- NEMA 12

Product Selection

Acoustic Devices

M22-AMC-XAM



Complete Devices

Description	Decibel Rating	Catalog Number
Indicator with buzzer, black continuous tone, 18–30 Vac/Vdc	83 dB/ 10 cm	M22-AMC-XAM
Indicator with buzzer, black pulsed tone, 18–30 Vac/Vdc	83 dB/ 10 cm	M22-AMC-XAMP

M22-XAM



Buzzers

Description	Decibel Rating	Catalog Number
Indicator without buzzer, black	83 dB/ 10 cm	M22-AMC
Buzzer only, continuous tone, 18–30 Vac/Vdc	83 dB/ 10 cm	M22-XAM
Buzzer only, pulsed tone, 18–30 Vac/Vdc	83 dB/ 10 cm	M22-XAMP

Through-the-Door Operators

Product Description

Eaton’s M22 through-the-door operators use the same familiar flush pushbutton look with the addition of a cut-to-length rod that allows for a simple reset operator.

Features

- Customizable laser engraving on all buttons
- More than five million mechanical operations
- Pushrod can be cut to length

Protection Type

- IP67, IP69K
- NEMA 4X, 13

Product Selection

Through-the-Door Operators ^①

M22-DZ-B-X6



Complete Devices

Color	Inscription	Catalog Number
Blue	—	M22-DZ-B
	RESET	M22-DZ-B-GB14
	Ⓡ	M22-DZ-B-X6
Red	—	M22-DZ-R
	Ⓢ	M22-DZ-R-X0
	STOP	M22-DZ-R-GB0

M22-DZ-X



Buttonless Operator

Bezel	Catalog Number
Silver	M22-DZ-X
Metal	M22M-DZ-X

M22-XD-B



Button Plates ^②

Color	Inscription	Catalog Number
Blue	—	M22-XD-B ^③
	RESET	M22-XD-B-GB14
	Ⓡ	M22-XD-B-X6
Red	—	M22-XD-R ^③
	Ⓢ	M22-XD-R-X0
	STOP	M22-XD-R-GB0

Bulkhead Interfaces

Product Description

Eaton’s M22 bulkhead interfaces are another unique offering in the M22 line. This device allows for a secure connection to any USB or RJ45 connected device within an enclosure or panel. With an IP65 rating when closed, these devices are not only convenient, but robust and reliable.

Features

- Convenient and safe way to make a data connection to inside of the panel without opening the panel door

Protection Type

- IP65 when closed, IP20 when connected

Product Selection

Bulkhead Interfaces

M22-USB-SA



USB Socket ^{④⑤}

Used for USB connection plug IP65 when closed, IP20 when connected.

Bezel	Catalog Number
Silver	M22-USB-SA

M22-RJ45-SA



RJ45 Socket ^⑥

Used for RJ45 Ethernet connection IP65 when closed, IP20 when connected.

Bezel	Catalog Number
Silver	M22-RJ45-SA

Notes

- ① The pushrod is 3.24 in long and can be cut to length.
- ② Any combination of plate color and inscription is available.
- ③ Minimum order quantity of (10).
- ④ USB interface is complete with 2-ft-long USB cable.
- ⑤ USB interface is UL Listed, CSA approved and USB 3.0.
- ⑥ RJ45 interface is an eight-wire connector.

ASi Adapter Modules

Product Description

Eaton's M22 ASi adapter modules add functionality to every operator in the M22 line. These devices can be connected to any operator that uses contact blocks or LED units. The simple snap-on design allows for a quick integration of an entire application of operators to a communicating network.

Features

- Allows compatible operators to communicate on an ASi network
- Not only can the status of a contact block be read, but LEDs can be illuminated by an ASi adapter
- ASi adapters simply clip on to the back of the contact blocks and LEDs
- Insulation displacement connectors allow for installation of adapters without any tools
- Two integrated LEDs indicate status of communications

Protection Type

- IP20

Product Selection

ASi Adapter Modules

M22-ASi



Complete Devices

Description	Catalog Number
ASi adapter module	M22-ASi
ASi adapter module for base mounting	M22-ASi-C
ASi adapter module for E-stop	M22-ASi-S
ASi adapter module for E-stop base mounting	M22-ASi-CS

Palm Switches

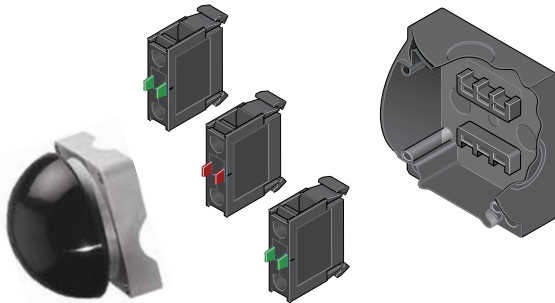

Product Description

Eaton’s M22 palm switches are an oversized button that mount directly to an enclosure base. This allows for a standalone button that can be mounted anywhere. The enclosure uses base-mounted contact blocks, which allows for quick wiring and mounting. The palm switches come in momentary or maintained versions. As with other M22 operators, the palm switches are available as complete devices, including the enclosure and contact blocks or as modular components.

Features

- Oversized operator in black, red and yellow color options
- Button integrated directly into an enclosure
- Base mounting contact blocks allow for simple wiring and installation
- More than one million mechanical operations on momentary and 100,000 on maintained operators

Protection Type

- IP67, IP69K
- NEMA 4X, 13

Catalog Number Selection

Catalog Number Selection is for illustrative purposes only and not to be used to create new catalog numbers.

Palm Switches, Type 4X/13 Enclosure

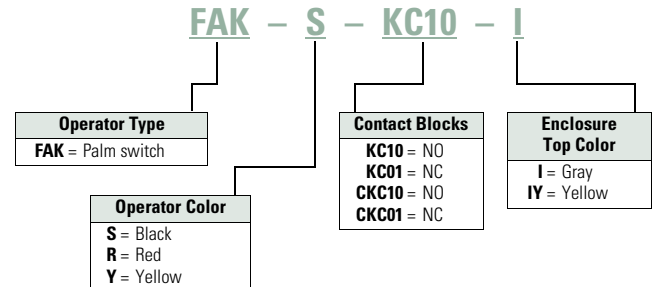

Product Selection

Complete Devices

Operator, Base and Contact Blocks ①

Button Color	Contact Block Configuration ②	Catalog Number
FAK-S-KC11-I		
Momentary		
Black	1NO-1NC	FAK-S-KC11-I
Red	1NO-1NC	FAK-R-KC11-I
Yellow	1NO-1NC	FAK-Y-KC11-I
FAK-R-V-KC01-IY		
Maintained		
Red	NC	FAK-R-V-KC01-IY
	2NC	FAK-R-V-KC02-IY
	1NO-2NC	FAK-R-V-KC12-IY
	1NO-1NC	FAK-R-V-KC11-IY

Notes

① For complete listing of available contact blocks, see Accessories, Pages V7-T1-111 to V7-T1-116.

② All NC contact blocks are positively driven contact. ⊖

Components

FAK-S



Operators Only

Type	Button Color	Catalog Number
Momentary	Black	FAK-S
	Red	FAK-R
	Yellow	FAK-Y
Maintained	Red	FAK-R-V-Y

FAK-IU



Palm Switch Enclosure Base

Catalog Number

FAK-IU

M22-KC10

Contact Blocks ^①

Terminal Type	Contact Configuration ^②	Catalog Number
Screw	NO	M22-KC10
	NC	M22-KC01
Spring-cage	NO	M22-CKC10
	NC	M22-CKC01

Notes

^① For complete listing of available contact blocks, see Accessories, **Pages V7-T1-111 to V7-T1-116**.

^② All NC contact blocks are positively driven contact. 

Accessories

M22-XD-S



M22-XDH-R



M22-XDP-G



Button Plates

Color	Inscription	Catalog Number Flush Pushbutton	Catalog Number Extended Pushbutton	Catalog Number Mushroom Head Button
Black	—	M22-XD-S	M22-XDH-S	M22-XDP-S
White	—	M22-XD-W	M22-XDH-W	M22-XDP-W
Red	—	M22-XD-R	M22-XDH-R	M22-XDP-R
Green	—	M22-XD-G	M22-XDH-G	M22-XDP-G
Yellow	—	M22-XD-Y	M22-XDH-Y	M22-XDP-Y
Blue	—	M22-XD-B	M22-XDH-B	—
Black, white, red, green, yellow, blue	—	M22-XD-SWRGYB	M22-XDH-SWRGYB	—
Black, red, green	—	M22-XD-SRG	M22-XDH-SRG	—
Black	Custom	M22-XD-S-ETCH	M22-XDH-S-ETCH	M22-XDP-S-ETCH
White	Custom	M22-XD-W-ETCH	M22-XDH-W-ETCH	M22-XDP-W-ETCH
Red	Custom	M22-XD-R-ETCH	M22-XDH-R-ETCH	M22-XDP-R-ETCH
Green	Custom	M22-XD-G-ETCH	M22-XDH-G-ETCH	M22-XDP-G-ETCH
Yellow	Custom	M22-XD-Y-ETCH	M22-XDH-Y-ETCH	M22-XDP-Y-ETCH
Blue	Custom	M22-XD-B-ETCH	M22-XDH-B-ETCH	—
Black	STOP	M22-XD-S-GB0	M22-XDH-S-GB0	M22-XDP-S-GB0
Red	STOP	M22-XD-R-GB0	M22-XDH-R-GB0	M22-XDP-R-GB0
Black	START	M22-XD-S-GB1	M22-XDH-S-GB1	M22-XDP-S-GB1
White	START	M22-XD-W-GB1	M22-XDH-W-GB1	—
Green	START	M22-XD-G-GB1	M22-XDH-G-GB1	M22-XDP-G-GB1
Black	CLOSE	M22-XD-S-GB2	M22-XDH-S-GB2	—
Black	UP	M22-XD-S-GB3	M22-XDH-S-GB3	M22-XDP-S-GB3
Black	DOWN	M22-XD-S-GB4	M22-XDH-S-GB4	M22-XDP-S-GB4
Black	OFF	M22-XD-S-GB5	M22-XDH-S-GB5	M22-XDP-S-GB5
Red	OFF	M22-XD-R-GB5	M22-XDH-R-GB5	M22-XDP-R-GB5
Black	ON	M22-XD-S-GB6	M22-XDH-S-GB6	M22-XDP-S-GB6
Green	ON	M22-XD-G-GB6	M22-XDH-G-GB6	M22-XDP-G-GB6
Black	TEST	M22-XD-S-GB9	M22-XDH-S-GB9	—
Blue	RESET	M22-XD-B-GB14	M22-XDH-B-GB14	—
Black	FORWARD	M22-XD-S-GB15	M22-XDH-S-GB15	M22-XDP-S-GB15
Black	REVERSE	M22-XD-S-GB16	M22-XDH-S-GB16	M22-XDP-S-GB16
Black	RAISE	M22-XD-S-GB17	M22-XDH-S-GB17	—
Black	LOWER	M22-XD-S-GB18	M22-XDH-S-GB18	—
Black	⊙	M22-XD-S-X0	M22-XDH-S-X0	M22-XDP-S-X0
Red	⊙	M22-XD-R-X0	M22-XDH-R-X0	M22-XDP-R-X0
Green	⊙	—	—	M22-XDP-G-X0
Black	①	M22-XD-S-X1	M22-XDH-S-X1	M22-XDP-S-X1
White	①	M22-XD-W-X1	M22-XDH-W-X1	—
Green	①	M22-XD-G-X1	M22-XDH-G-X1	M22-XDP-G-X1
Black	②	M22-XD-S-X2	M22-XDH-S-X2	—
Green	②	M22-XD-G-X2	M22-XDH-G-X2	—
Black	+	M22-XD-S-X4	M22-XDH-S-X4	M22-XDP-S-X4
Black	−	M22-XD-S-X5	M22-XDH-S-X5	M22-XDP-S-X5
Blue	Ⓜ	M22-XD-B-X6	M22-XDH-B-X6	—
Black	①	M22-XD-S-X7	M22-XDH-S-X7	M22-XDP-S-X7
Black	①	M22-XD-S-X8	M22-XDH-S-X8	—
Black	See ① below	M22-XD-S-X9	M22-XDH-S-X9	—
Black	See ① below	M22-XD-S-X10	M22-XDH-S-X10	—
Black	See ① below	M22-XD-S-X11	M22-XDH-S-X11	—
Black	See ① below	M22-XD-S-X12	M22-XDH-S-X12	—
Black	See ① below	M22-XD-S-X13	M22-XDH-S-X13	—
Black	See ① below	M22-XD-S-X14	M22-XDH-S-X14	—
Black	See ① below	M22-XD-S-X15	M22-XDH-S-X15	—
Black	See ① below	M22-XD-S-X16	M22-XDH-S-X16	—
Black	See ① below	M22-XD-S-X17	M22-XDH-S-X17	—

Note

① Refer to the Symbols Library, (see Pages V7-T1-129 to V7-T1-136), for symbol image.

1

M22-XDLH-W



M22-XDL-G



Button Lenses

Color	Inscription	Catalog Number Flush	Catalog Number Extended	Color	Inscription	Catalog Number Flush	Catalog Number Extended
White	—	M22-XDL-W	M22-XDLH-W	Blue	Custom	M22-XDL-B-ETCH	M22-XDLH-B-ETCH
Red	—	M22-XDL-R	M22-XDLH-R	Red	STOP	M22-XDL-R-GB0	M22-XDLH-R-GB0
Green	—	M22-XDL-G	M22-XDLH-G	Green	START	M22-XDL-G-GB1	M22-XDLH-G-GB1
Yellow	—	M22-XDL-Y	M22-XDLH-Y	Red	OFF	M22-XDL-R-GB5	M22-XDLH-R-GB5
Blue	—	M22-XDL-B	M22-XDLH-B	Green	ON	M22-XDL-G-GB6	M22-XDLH-G-GB6
White	Custom	M22-XDL-W-ETCH	M22-XDLH-W-ETCH	Blue	RESET	M22-XDL-B-GB14	M22-XDLH-B-GB14
Red	Custom	M22-XDL-R-ETCH	M22-XDLH-R-ETCH	Red	Ⓢ	M22-XDL-R-X0	M22-XDLH-R-X0
Green	Custom	M22-XDL-G-ETCH	M22-XDLH-G-ETCH	Green	Ⓛ	M22-XDL-G-X1	M22-XDLH-G-X1
Yellow	Custom	M22-XDL-Y-ETCH	M22-XDLH-Y-ETCH	Blue	Ⓜ	M22-XDL-B-X6	M22-XDLH-B-X6

Mounting Adapters

Description	Catalog Number
Contact block mounting adapter	M22-A

M22-A



M22-A4



Contact block mounting adapter, four-position (for use with four-way pushbuttons, joysticks and four-position selector switches only).	M22-A4
--	--------

M22-LS



Allows mounting of M22 pushbuttons to LS-Titan limit switch bodies (for the full LS-Titan catalog section, see PG08301004E).	M22-LS
--	--------

M22-K10



Contact Blocks

Mounting Location	Terminal Type	Contact Configuration ^①	Package Qty.	Catalog Number		
Front	Screw	NO	1	M22-K10		
		NO	25	M22-K10-B25		
		NO	100	M22-K10-B100		
		NO, early-make	1	M22-K10P		
		NC	1	M22-K01		
		NC	25	M22-K01-B25		
		NC	100	M22-K01-B100		
		NC, late-break	1	M22-K01D		
		SMCB, NC	1	M22-K01SMC10		
		SMCB, 2NC	1	M22-K02SMC10		
Base		NO	1	M22-KC10		
		NO	25	M22-KC10-B25		
		NO	100	M22-KC10-B100		
		NC	1	M22-KC01		
		NC	25	M22-KC01-B25		
		NC	100	M22-KC01-B100		
		SMCB, NC	1	M22-KC01SMC10		
		SMCB, 2NC	1	M22-KC02SMC10		
		Front	Spring-cage	NO	1	M22-CK10
				NC	1	M22-CK01
NC, late-break	1			M22-CK01D		
2NO ^②	1			M22-CK20		
2NC ^②	1			M22-CK02		
NO-NC ^②	1			M22-CK11		
Base		NO	1	M22-CKC10		
		NC	1	M22-CKC01		

Notes

^① All NC contact blocks are positively driven contact. Ⓢ

^② Not stackable.

M22-LED-W



Light Units

Terminal Type	Mounting Location	LED Color	Light Unit Voltage	Catalog Number	
Screw	Front	White	12–30 Vac/Vdc	M22-LED-W	
		Red		M22-LED-R	
		Green		M22-LED-G	
		Blue		M22-LED-B	
		White	85–264 Vac	M22-LED230-W	
		Red		M22-LED230-R	
		Green		M22-LED230-G	
		Blue		M22-LED230-B	
		White	207–264 Vac	M22-LED230H-W	
		Red		M22-LED230H-R	
		Green		M22-LED230H-G	
		Blue		M22-LED230H-B	
	Base	White	12–30 Vac/Vdc	M22-LEDC-W	
				M22-LEDC-R	
				M22-LEDC-G	
				M22-LEDC-B	
		White	85–264 Vac	M22-LEDC230-W	
				M22-LEDC230-R	
				M22-LEDC230-G	
				M22-LEDC230-B	
		White	207–264 Vac	M22-LEDC230H-W	
				M22-LEDC230H-R	
				M22-LEDC230H-G	
				M22-LEDC230H-B	
Spring-cage	Front	White	12–30 Vac/Vdc	M22-CLED-W	
		Red		M22-CLED-R	
		Green		M22-CLED-G	
		Blue		M22-CLED-B	
		White	85–264 Vac	M22-CLED230-W	
		Red		M22-CLED230-R	
		Green		M22-CLED230-G	
		Blue		M22-CLED230-B	
		Base	White	12–30 Vac/Vdc	M22-CLEDC-W
					M22-CLEDC-R
					M22-CLEDC-G
					M22-CLEDC-B
	White		85–264 Vac	M22-CLEDC230-W	
				M22-CLEDC230-R	
				M22-CLEDC230-G	
				M22-CLEDC230-B	

M22-XLED60



LED Resistor and Test Elements

Terminal Type	Mounting Location	Element Type	Voltage	Catalog Number
Screw	Front	Resistor ^{①②}	42–60 Vac/Vdc	M22-XLED60
			220 Vdc	M22-XLED220
		Test	12–240 Vac/Vdc	M22-XLED-T
			85–264 Vac	M22-XLED230-T

Notes

- ① Resistor units to be used with 12–30V light units.
- ② Refer to **IL04716002E** for use of resistor elements in series for higher DC voltage.

Legend Plate Holders and Inserts, Pushbuttons and Double Pushbuttons ^②**M22S-ST-X**

Description	Inscription	Catalog Number
Legend plate holder, without legend plate insert, for pushbuttons	—	M22S-ST-X
Legend plate holder, without legend plate insert, for double pushbuttons	—	M22S-STDD-X
M22-XST-GB0		
Legend plate insert	—	M22-XST
	Custom	M22-XST-ETCH ^①
	STOP	M22-XST-GB0
	START	M22-XST-GB1
	OFF	M22-XST-GB5
	ON	M22-XST-GB6
	RUN	M22-XST-GB7
	FAULT	M22-XST-GB8
	OFF ON	M22-XST-GB10
	MAN. AUTO	M22-XST-GB11
	MAN. O AUTO	M22-XST-GB12
	HAND AUTO	M22-XST-D11
	HAND O AUTO	M22-XST-D12
	1	M22-XST-X52
	2	M22-XST-X53
	O I	M22-XST-X88
	O - I	M22-XST-X89
	I O II	M22-XST-X93

Notes

^① When ordering, specify inscription per catalog number suffix from the Symbols Library (see **Pages V7-T1-129 to V7-T1-136**) into the Order Notes.

For example, M22-XD-S-ETCH; Order Notes: Mark with symbol X91, Line item # __.







^② Legend plates are IP66 and NEMA 4X/13.

Example

To order a legend plate for a pushbutton with non-standard markings (FORWARD):

1. Select legend plate holder—M22S-ST-X.
2. Select legend plate insert—M22-XST-ETCH.
3. Select FORWARD from the Symbols Library, **Pages V7-T1-129 to V7-T1-136**, identified by GB15 suffix.
4. Indicate on the order form in the order notes—suffix GB15, line item # ____ .

Legend Plates, Complete ^②

	Description	Inscription	Catalog Number	
M22S-ST-GB0 	For use with pushbuttons and indicating lights	Legend plate holder with insert	STOP M22S-ST-GB0	
			START M22S-ST-GB1	
			OFF M22S-ST-GB5	
			ON M22S-ST-GB6	
			RUN M22S-ST-GB7	
			FAULT M22S-ST-GB8	
			1 M22S-ST-X52	
			2 M22S-ST-X53	
		Selector switches	—	OFF ON M22S-ST-GB10
				MAN. AUTO M22S-ST-GB11
				MAN. 0 AUTO M22S-ST-GB12
				HAND AUTO M22S-ST-D11
	HAND 0 AUTO M22S-ST-D12			
	0 I M22S-ST-X88			
	0 - I M22S-ST-X89			
	I 0 II M22S-ST-X93			
M22-XZK 	Emergency-stop operators		Rectangular yellow legend plate	— M22-XZK
				Custom M22-XZK-ETCH ^①
			EMERGENCY-STOP M22-XZK-GB99	
M22-XYK 	Emergency-stop operators	Square yellow legend plate	— M22-XYK	
			— M22-XYK-ETCH ^①	
			EMERGENCY-STOP four-language M22-XYK1	
			EMERGENCY-STOP (top and bottom) M22-XYK5	
		M22-XBK1 	Emergency-stop operators	Round yellow legend plate, 90 mm
	Custom M22-XBK-ETCH ^①			
	EMERGENCY-STOP four-language M22-XBK1			
	EMERGENCY-STOP (top and bottom) M22-XBK5			
M22-XBK1 	Emergency-stop operators			Round yellow legend plate, 60 mm
			Custom M22-XBK-ETCH ^①	
			EMERGENCY-STOP four-language M22-XBK1	
			EMERGENCY-STOP (top and bottom) M22-XBK5	
		M22-XCK1 	Four-way pushbutton, joystick and four-position selector switches	Silver square legend plate
	Custom M22-XCK-ETCH ^①			
	Four directional arrows M22-XCK1			
	0-1-0-2-0-3-0-4 M22-XCK2			
	Two directional arrows M22-XCK3			

Notes

^① When ordering, specify inscription per catalog number suffix from the Symbols Library (see **Pages V7-T1-129 to V7-T1-136**) into the Order Notes.

For example, M22-XD-S-ETCH; Order Notes: Mark with symbol X91, Line item #_.

^② Legend plates are IP66 and NEMA 4X/13.

Surface Mounting Enclosures ^①

Description	Catalog Number
M22-IY1-PG Yellow top, black base for emergency-stop operators	M22-IY1-PG
M22-IY-PG One-element enclosure	M22-I1-PG
Two-element enclosure	M22-I2-PG
Three-element enclosure	M22-I3-PG
Four-element enclosure	M22-I4-PG
Six-element enclosure	M22-I6-PG
M20 connecting screw	M22-XI
M20 cord grip	V-M20

Flush Mounting Plates, Aluminum

Finish	Rating	Catalog Number
One Hole		
Yellow paint for emergency-stop operators	—	M22-EY1
Gray anodized	IP65	M22-E1
Two Holes		
Gray anodized	IP65	M22-E2
Three Holes		
Gray anodized	IP65	M22-E3
Four Holes		
Gray anodized	IP65	M22-E4
Five Holes		
Gray anodized	IP65	M22-E5
Six Holes		
Anodized	IP40	M22-E6

Shrouds, Plastic

Description	Rating	Catalog Number
M22-H1 One-element	IP55	M22-H1
Two-element	IP55	M22-H2
Three-element	IP55	M22-H3
Four-element	IP40	M22-H4
Five-element	IP40	M22-H5
Six-element	IP40	M22-H6
Mounting plate	—	M22-XE5
Plaster keys for flush mounting	—	M22-UPE





Selector Switch Accessories

Description	Catalog Number
M22-XW Plunger bridge ^②	M22-XW
M22-XWS Key cover	M22-XWS
M22-XC-R Key withdraw adapter ^③	M22-XC-R
M22-XC-Y Coding adapter	M22-XC-Y
M22-XGWK Guard ring	M22-XGWK

Notes

- ① Requires use of base mounted contact blocks.
- ② Plunger needed to actuate center-mounted contact blocks. Used for non-illuminated three-position selector switches only.
- ③ Enables a keyed selector switch to be set to user-selected key withdraw position.

Emergency Stop Operator Accessories

	Description	Voltage	Catalog Number
	Yellow guard ring	—	M22-XGPV
	Gray guard ring	—	M22G-XGPV
	Rectangular guard	—	M22-MGTA
	Sealing shroud	—	M22-PL-PV
	Illuminated ring	24 Vac/Vdc	M22-XPV60-Y-24
		120 Vac	M22-XPV60-Y-120
		230 Vac	M22-XPV60-Y-230

Blanking Plugs

M22-B	Color	Catalog Number
	Gray	M22-B
	Black	M22S-B

Mounting Accessories

	Description	Catalog Number
	Telescopic clip with top-hat rail	M22-TC
	Telescopic clip	M22-TA
	Telescopic clip extension	M22-TCV
	DIN rail mounting adapter	M22-IVS
	Mounting ring	M22-GR
	Mounting ring tool	M22-MS
	Adapter ring set for 30 mm holes	M22S-R30

Protective Diaphragm

M22-T-D and M22-T-DD	For Use with ...	Catalog Number
	Flush pushbuttons and indicating lights	M22-T-D
	Double pushbuttons	M22-T-DD

Dust Covers

M22-ADC4	Description	Catalog Number
	Contact block dust cover	M22-XKDP
	Operator dust cover, max three contact blocks	M22-ADC
	Operator dust cover, max four contact blocks	M22-ADC4

Kits

Description	Catalog Number
Includes one each: M22-XW, M22-XC-R, M22-XC-Y, M22S-B, M22-A, M22-XD-SWRGYB	M22-KT1

Coding Adapter Guide Selector Switches

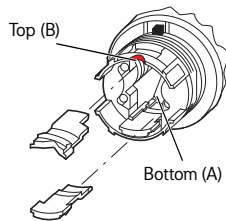

Two-Position Selector Switch

Top (B)	Bottom (A)	Catalog Number	Function
		M22(S)-W(L)(K)	Momentary
		M22(S)-WR(L)(K)	Maintained

Three-Position Selector Switch

Top (B)	Bottom (A)	Catalog Number	Function Left	Right
		M22(S)-W(L)(K)3	Momentary	Momentary
		M22(S)-WR(L)(K)3	Maintained	Maintained
		M22(S)-WR(L)(K)3-1	Maintained	Momentary
		M22(S)-WR(L)(K)3-2	Momentary	Maintained

Two-Position Key-Operated Selector Switch

Top (B)	Bottom (A)	Catalog Number	Center Key Withdraw	Right Function	Key Withdraw
		M22(S)-WS	Yes	Momentary	No
		M22(S)-WRS	Yes	Maintained	Yes
		M22(S)-WRS-A1	Yes	Maintained	No

Three-Position Key-Operated Selector Switch

Top (B)	Bottom (A)	Catalog Number	Left Function	Key Withdraw	Center Key Withdraw	Right Function	Key Withdraw
		M22(S)-WS3	Momentary	No	Yes	Momentary	No
		M22(S)-WRS3	Maintained	Yes	Yes	Maintained	Yes
		M22(S)-WRS3-A1	Maintained	No	Yes	Maintained	No
		M22(S)-WRS3-A2	Maintained	Yes	Yes	Maintained	No
		M22(S)-WRS3-A3	Maintained	No	Yes	Maintained	Yes
		M22(S)-WRS3-A4	Maintained	Yes	Yes	Momentary	No
		M22(S)-WRS3-A5	Maintained	No	Yes	Momentary	No
		M22(S)-WRS3-A6	Momentary	No	Yes	Maintained	Yes
		M22(S)-WRS3-A7	Momentary	No	Yes	Maintained	No

Technical Data and Specifications

Pushbuttons, Indicating Lights, Selector Switches and Emergency-Stop Operators

Description		Momentary Pushbuttons	Maintained Pushbuttons	Indicating Lights, Buzzers and Potentiometers	Emergency-Stop Operators	Selector Switches	Key-Operated Operators	Double Pushbuttons
General								
Standards		IEC/EN 60947 VDE 0660 UL #E29184	IEC/EN 60947 VDE 0660 UL #E29184	IEC/EN 60947 VDE 0660 UL #E29184	IEC/EN 60947 VDE 0660 UL #340491	IEC/EN 60947 VDE 0660 UL #E29184	IEC/EN 60947 VDE 0660 UL #E29184	IEC/EN 60947 VDE 0660 UL #E29184
Lifespan, mechanical	Operations	x 10 ⁶	>5	>1	—	>0.1	>0.1	>0.2
Operating frequency	Operations/h		≥3600	≥1800	—	≥600	≥2000	≥3600
Actuating force	n		≥5	≥5	—	≥50	—	≥5
Operating torque (screw terminals)	Nm		—	—	—	≥0.3	≥0.5	—
Protection Type								
IP		IP67, IP69K	IP67, IP69K	Indicating lights: IP67, 69K Buzzers: IP40 Potentiometers: IP66	IP67, IP69K	IP66	IP66	IP66
UL type		4X, 13	4X, 13	Indicating lights: 4X/13 Buzzers: 12 Potentiometers: 4X/13	4X, 13	4X, 13	4X, 13	4X, 13
Climatic proofing		Damp heat, constant, according to IEC 60068-2-78 Damp heat, cyclical to IEC 60068-2-30						
Ambient temperature, operating		°F (°C)	–13 to 158 (–25 to 70)	–13 to 158 (–25 to 70)	–13 to 158 (–25 to 70)	–13 to 158 (–25 to 70)	–13 to 158 (–25 to 70)	–13 to 158 (–25 to 70)
Mounting position			As required	As required	As required	As required	As required	As required
Mechanical shock resistance to IEC 60068-2-27 shock duration 11 ms, half-sinusoidal		g	>30	>30	>30	>50	>30	>30
Terminal Capacities								
Solid		AWG	—	—	20-16	—	—	—
		mm ²	—	—	0.5–1.5	—	—	—
Stranded		AWG	—	—	20-16	—	—	—
		mm ²	—	—	0.5–1.5	—	—	—
Contacts								
Rated impulse withstand voltage		U _{imp}	Vac	—	4000	—	—	—
Rated insulation voltage		U _i	V	—	2500	—	—	—
Overvoltage category/pollution degree			—	—	III/3	—	—	—

Contact Blocks and Light Units

Description			Contact Blocks	LED Light Units
General				
Standards			IEC/EN 60947 VDE 0660 UL #E29184	IEC/EN 60947 VDE 0660 UL #E29184
Lifespan, mechanical	Operations	$\times 10^6$	>5	—
Operating frequency	Operations/h		≥ 3600	—
Actuating force	n		≥ 5	—
Operating torque (screw terminals)	Nm		≤ 0.8	—
Protection Type				
IP			IP20	IP20
UL type			—	—
Climatic proofing			Damp heat, constant, according to IEC 60068-2-78 Damp heat, cyclical to IEC 60068-2-30	
Ambient temperature, operating		°F (°C)	–13 to 158 (–25 to 70)	–13 to 158 (–25 to 70)
Mounting position			As required	As required
Mechanical shock resistance to IEC 60068-2-27 shock duration 11 ms, half-sinusoidal		g	>30	>30
Terminal Capacities				
Solid		AWG	18–14	18–14
		mm ²	0.75–2.5	0.75–2.5
Stranded		AWG	20–14	20–14
		mm ²	0.5–2.5	0.5–2.5
Contacts				
Rated impulse withstand voltage	U_{imp}	Vac	6000	6000
Rated insulation voltage	U_i	V	500	500
Overvoltage category/ pollution degree			III/3	III/3
NEMA contact ratings			A600, Q300	—
Current draw			—	5–15 mA
Control Circuit Reliability				
at 24 Vdc/5 mA	H_f	Fault probability	$<10^{-7}$, <1 fault in 10^7 operations	—
at 5 Vdc/1 mA	H_f	Fault probability	$<5 \times 10^{-6}$, <1 fault in 5×10^6 operations	—
Max. Short-Circuit Protective Device				
Fuse	gG/gL	A	10	—
Switching Capacity				
Rated Operational Current				
AC-15				
115V	I_e	A	6	—
230V	I_e	A	6	—
400V	I_e	A	4	—
500V	I_e	A	2	—
DC-13				
24V	I_e	A	3	—
42V	I_e	A	1.7	—
60V	I_e	A	1.2	—
110V	I_e	A	0.6	—
220V	I_e	A	0.3	—
Lifespan, Electrical				
AC-15				
230V/0.5A	Operations	$\times 10^6$	1.6	—
230V/1.0A	Operations	$\times 10^6$	1	—
230V/3.0A	Operations	$\times 10^6$	0.7	—
DV-13				
12V/2.8A	Operations	$\times 10^6$	1.2	—

Contact Element Note: >200 Vac/60 Hz: –25/55°C

Palm Switches

Description		Momentary	Maintained	FAK-R-V-KC11-I
General				
Standards		IEC/EN 60947 VDE 0660	IEC/EN 60947 VDE 0660	IEC/EN 60947 VDE 0660
Lifespan, mechanical	Operations x 10 ⁶	>1	>0.1	>0.1
Operating frequency	Operations/h	≥3600	≥600	≥600
Actuating force	n	20–40	40–60	15–25
Operating torque	Nm	—	—	—
Degree of protection, IEC/EN 60529	IP	IP67, IP69K	IP67, IP69K	IP65
	UL Type	4X, 13	4X, 13	4X, 13
Climatic proofing		Damp heat, constant, to IEC 60068-2-78 Damp heat, cyclic, to IEC 60068-2-30		
Ambient temperature, operating	°F (°C)	–73 to 104 (–25 to 40)	–73 to 104 (–25 to 40)	–73 to 104 (–25 to 40)
Mounting position		As required		
Mechanical shock resistance to IEC 60068-2-27 shock duration 11 ms, half-sinusoidal	g	>15	>15	>15

ASi Adapter Modules

Description		M22-ASI	M22-ASI-C
General			
Standards		IEC/EN 60947, DIN EN 50295	IEC/EN 60947, DIN EN 50295
Radio interference suppression		EN 55011, EN 55022	EN 55011, EN 55022
Limit value class		—	—
Protection type		IP20	IP00
Climatic proofing		Damp heat, constant, to IEC 60068-2-78, cyclical, to IEC 60068-2-30	
Ambient temperature, operating	°F (°C)	–13 to 131 (–25 to 55)	–13 to 131 (–25 to 55)
Shock resistance shock duration 11 ms	g	>30	>30
Vibration to IEC 60068-2-27 (amplitude 1 mm)	Hz	—	—
Dimensions	mm	—	—
Weight	kg	—	—
Mounting		Front mounting	Front mounting
Mounting position		As required	As required
Power Supply			
Rated voltage to AS-interface specification	Vdc	26.5–31.6	26.5–31.6
Connection technique		Yellow plug-in terminal as insulation piercing terminal	Two cables onboard
Power supply		Completely from the AS-interface cable	
Addressing		Via connection to AS-interface cable	
Total power consumption of the AS-interface	mA	≥40	≥40
AS-interface		—	—
Rated operational current at full load	mA	—	—
Rated operational current when idle (no I, O set)	mA	—	—
Status LEDs		POWER AS-interface cable: green LED on the rear side of the element ERROR AS-interface, AS-interface master failure: red LED on the rear side of the element	POWER AS-interface cable: green LED on the board ERROR AS-interface, AS-interface master failure: red LED on the board

ASI-S Adapter Modules

Description		M22-ASI-S	M22-ASI-CS
Inputs			
Inputs, protected against short-circuit	Number	Two (normally 22V/5 mA)	Two (normally 22V/5 mA)
Voltage range	Vdc	—	—
Rated current per input	mA	—	—
High signal level	V	—	—
Low signal	mA	—	—
Length of connecting cables	cm	—	—
Outputs			
Outputs, protected against short-circuit	Number	One (normally 19V/8 mA)	One (normally 19V/8 mA)
Voltage range	Vdc	—	—
Max. Current Carrying Capacity			
All outputs		—	—
Σ three external outputs		—	—
Length of connecting cables	cm	—	—
Profile		S-3.A.E	S-3.A.E
Specification		2.1	2.1
Addresses	Number	62	62
Emergency-Stop Circuits			
Connection of the AS-interface line		Yellow plug terminal with insulation piercing	Two cables on the circuit board
Power supply		Complete from AS-interface, cable 26.5–31.6 Vdc	Complete from AS-interface, cable 26.5–31.6 Vdc
Fixing		Front mounted	Base mounted
Addressing		Via AS-interface cable	Via AS-interface cable
Max. total current	A	45 mA	45 mA
Ambient temperature, operating	°F (°C)	–13 to 131 (–25 to 55)	–13 to 131 (–25 to 55)
Shock resistance		30g/11 ms as per IEC 60068-2-27	30g/11 ms as per IEC 60068-2-27
Protection type		IP20	IP00
Climatic proofing		Damp heat, constant, to IEC 60068-2-78, cyclical, to IEC 60068-2-30	Damp heat, constant, to IEC 60068-2-78, cyclical, to IEC 60068-2-30
Mounting position		As required	As required
Standards		EN 50178 EN 50 295	EN 50178 EN 50 295
Inputs		Two-channel input (22V/5 mA) (moduled by code sequence) (two break contact sets M22-K01)	Two-channel input (22V/5 mA) (moduled by code sequence) (two break contact sets M22-K01)
Outputs		One output, typically 19V/8 mA, short-circuit proof	One output, typically 19V/8 mA, short-circuit proof
Status Displays			
Power, AS-interface cable		Green LED on the back	Green LED on the back
AS-interface error, AS-interface master failure		Red LED on the back	Red LED on the back
Profile		S-7.B.E	S-7.B.E

Dimensions

Approximate Dimensions in Inches (mm)

Operators and Indicating Lights

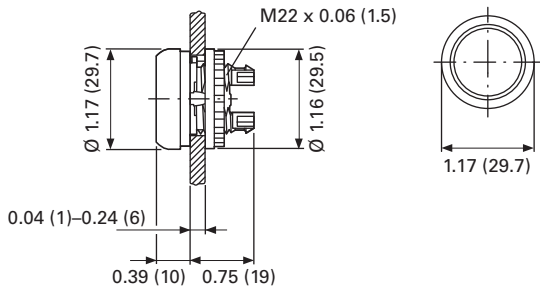

Pushbuttons

M22...-D-

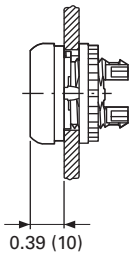

M22...-DH-

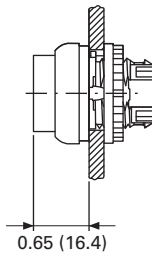

Selector Switches Operators

M22...-W-

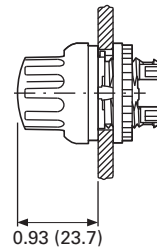

M22...-WL-

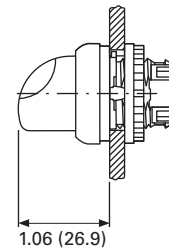

M22-DG(L)-

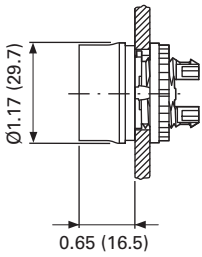

M22...-DD-

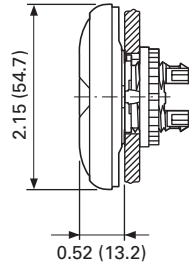

Key-Operated Selector Switches

M22...-W(R)S-

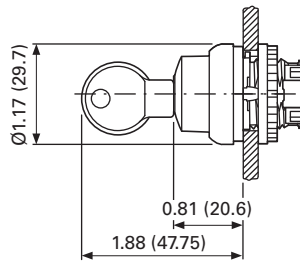

M22-D, Base Mounted

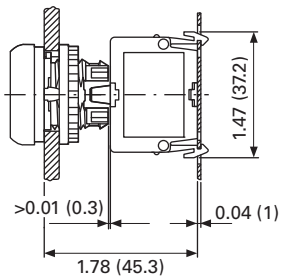

Indicating Light

M22-L

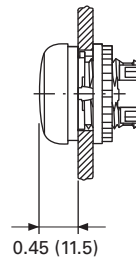

1.5

Pushbuttons and Indicating Lights

22.5 mm Modular Pushbuttons—M22

1

Approximate Dimensions in Inches (mm)

Illuminated Pushbuttons

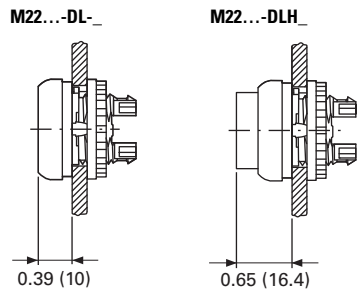

Mushroom Head Pushbutton

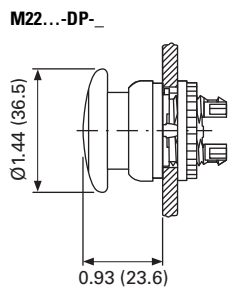

Emergency-Stop Operators

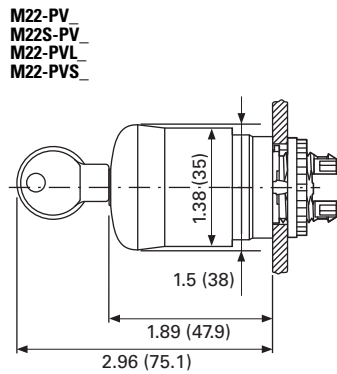

Potentiometer

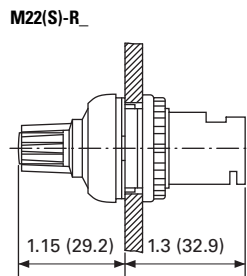

Contact Block Mounting Adapter

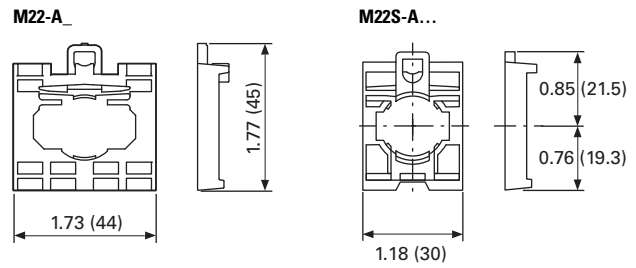

Front Mounted Centering Adapter

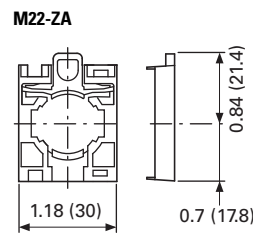

Front Mounted Indicating Light

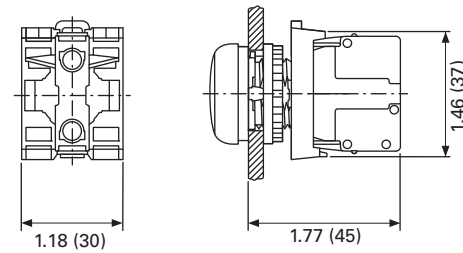

Pushbutton, Complete Devices

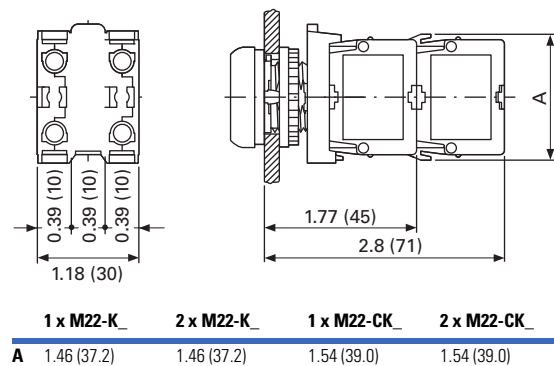

Approximate Dimensions in Inches (mm)

DIN-Rail Mounting Adapter

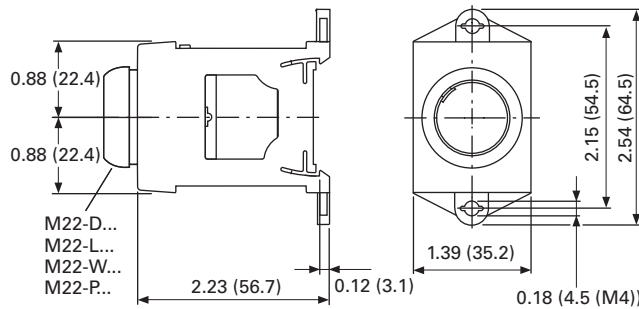

Pushbuttons and Indicating Lights with M22-TC Telescopic Clip and M22-TVC Extension

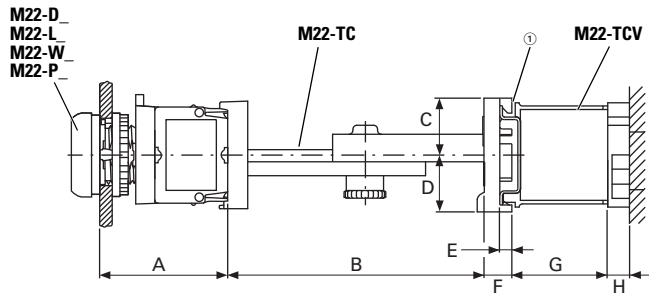

A	B	C	D	E	F	G	H
1.77 (45)	2.36–3.94 (60–100)	0.79 (20)	0.79 (20)	0.18 (4.5)	0.39 (10)	154 (39)	0.39 (10)

① Top-hat rail to IEC/EN 60715.

Palm Switches

FAK_

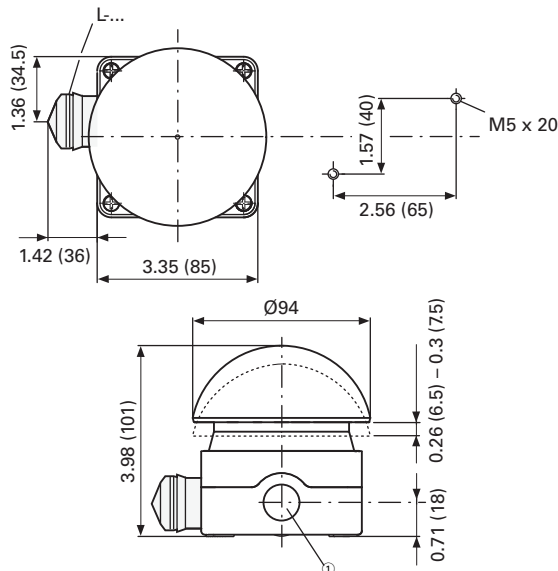

① 3 x M20 lateral, 1 x M16 in bottom.

Front Mounted Mounting Plate

M22-E_

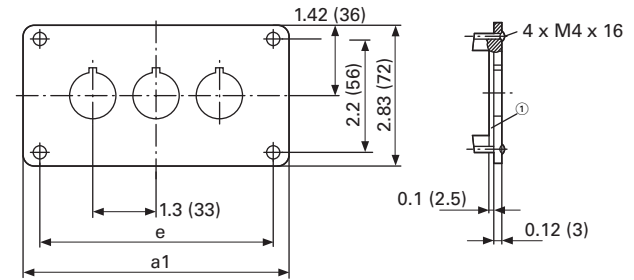

Catalog Number	a1	e
M22-E(Y) ①	2.83 (72)	2.21 (56)
M22-E2	4.13 (105)	3.50 (89)
M22-E3	5.43 (138)	4.80 (122)

Catalog Number	a1	e
M22-E4	6.73 (171)	6.10 (155)
M22-E5	8.03 (204)	7.40 (188)
M22-E6	9.33 (237)	8.70 (221)

Base Mounted Surface Mounting Enclosure

M22-I_

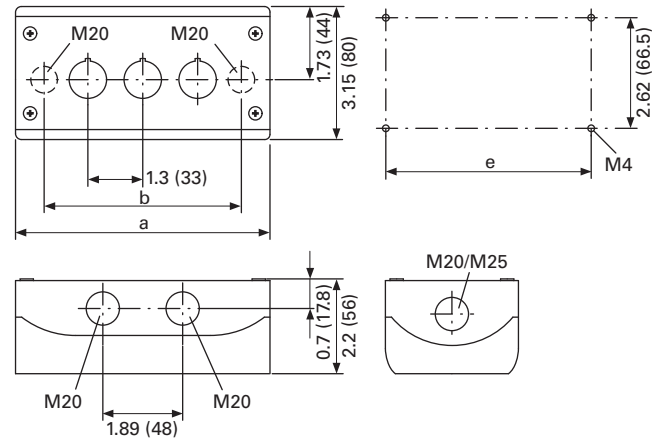

Catalog Number	Mounting Locations	a	b	e	Cable Entries
M22-I(Y)1	1	2.83 (72.0)	1.68 (42.6)	2.30 (58.5)	2 x M16 3 x M20 2 x M25
M22-I2	2	4.72 (120.0)	3.37 (85.6)	4.19 (106.5)	2 x M20 3 x M20 2 x M25
M22-I3	3	6.02 (153.0)	4.67 (118.6)	5.49 (139.5)	2 x M20 2 x M25 4 x M20
M22-I4	4	7.32 (186.0)	5.97 (151.6)	6.79 (172.5)	2 x M20 2 x M25 4 x M20
M22-I6	6	9.92 (252.0)	8.57 (217.6)	9.39 (238.5)	2 x M20 2 x M25 4 x M20

1.5

Pushbuttons and Indicating Lights

22.5 mm Modular Pushbuttons—M22

1

Approximate Dimensions in Inches (mm)

Covers

M22-H_

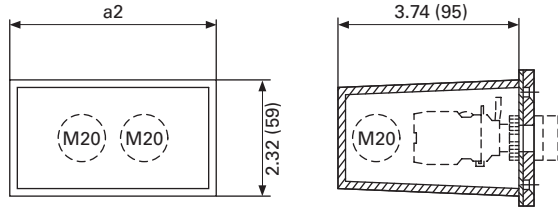

Catalog Number	a2	Cable Entry	Style
M22-H1	1.65 (42)	3 x M20	One-piece
M22-H2	2.95 (75)	4 x M20	
M22-H3	4.25 (108)	4 x M20	
M22-H4	5.55 (141)	4 x M20	Split
M22-H5	6.85 (174)	5 x M20	
M22-HE6	8.15 (207)	6 x M20	

Connecting Screw

M22-XI

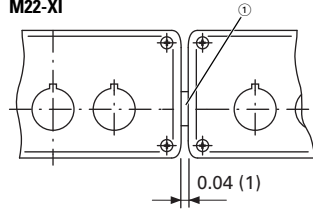

① Gasket.

Shroud with Plaster Keys

M22-UPE

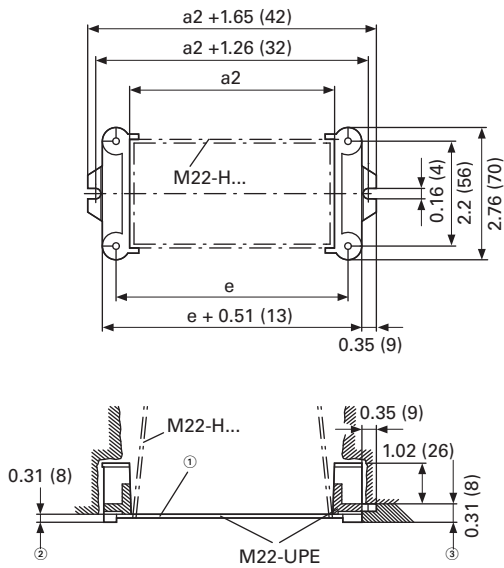

- ② Box for closing off when plastering.
- ③ Plaster thickness less than 8 mm.
- ④ Plaster thickness more than 8 mm.

Legend Plates

M22S-ST_

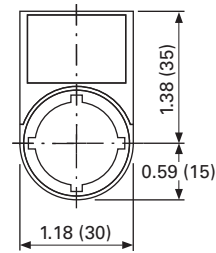

M22S-STDD-X

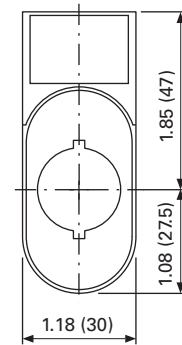

Mounting Hole with Lug Slot

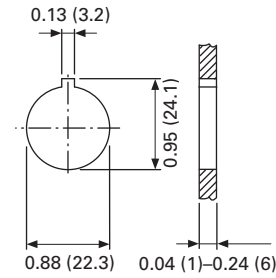

USB Socket

Approximate Dimensions in Inches (mm)

Grid Dimension to IEC/EN 60947

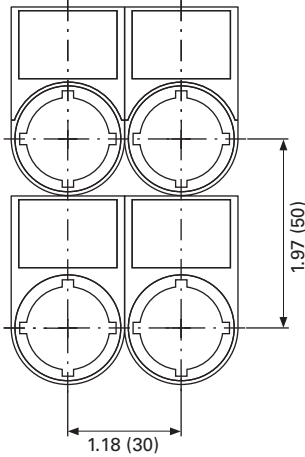

Grid Dimension for Various Combinations

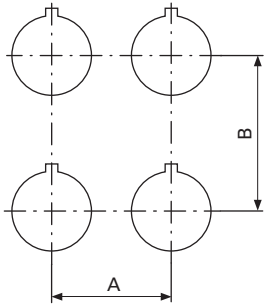

Pushbutton Diaphragm

Pushbutton diaphragm cannot be combined with label mount.

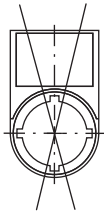

Catalog Number	A ≥	B ≥
M22(S)-_ (IEC/EN 60947)	1.18 (30.0)	1.97 (50.0)
RMQ-Titan min.	1.18 (30.0)	1.58 (40.0)
M22-D_ + M22-T-D	1.30 (33.0)	1.58 (40.0)
M22-D(R)P_	1.50 (38.0)	1.58 (40.0)
M22-PV_	1.50 (38.0)	1.58 (40.0)
M22-PV(L) + M22-PL-PV	1.89 (48.0)	2.20 (56.0)
M22-PV(L)(S_) + M22-D_	1.30 (33.0)	1.58 (40.0)
M22-DDL_	1.18 (30.0)	2.17 (55.0)
M22-DDL_ + M22-T-DD	1.30 (33.0)	2.28 (58.0)
M22-ST_	1.18 (30.0)	1.97 (50.0)
M22-STDD_	1.18 (30.0)	2.95 (75.0)
M22-CK_	1.18 (30.0)	1.77 (45.0)
M22-CLED_	1.18 (30.0)	1.77 (45.0)
M22-XAK_	3.54 (90.0)	3.54 (90.0)
M22-XZK_	1.30 (33.0)	2.04 (52.0)
M22-XBK_	2.36 (60.0)	2.36 (60.0)
M22-XYK_	1.97 (50.0)	1.97 (50.0)
M22-D4	2.17 (55.0)	2.17 (55.0)
M22-WR...4	1.97 (50.0)	1.97 (50.0)
M22-W...J4	1.97 (50.0)	1.97 (50.0)

Grid Dimension for M22-DD_

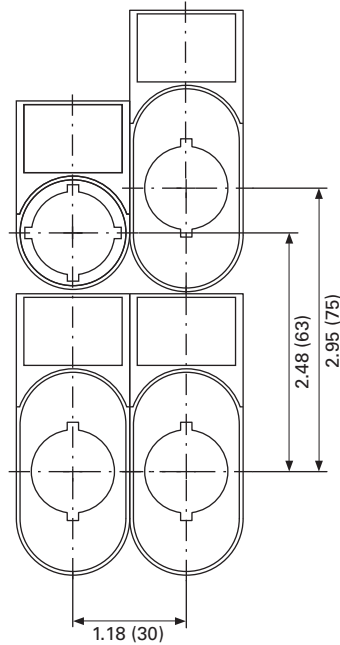

Grid Dimension for M22-DDL_

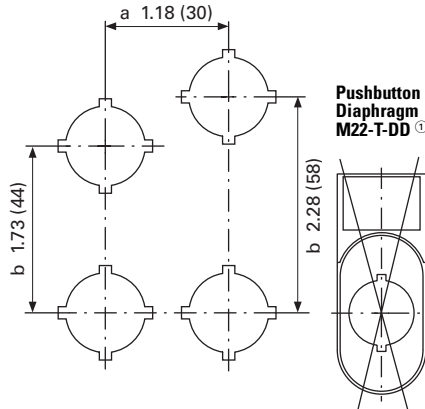

① Pushbutton diaphragm cannot be combined with label mount.

Emergency Stop Sealing Cover

M22-PL-PV

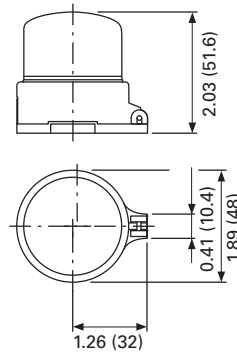

1.5

Pushbuttons and Indicating Lights

22.5 mm Modular Pushbuttons—M22

1

Approximate Dimensions in Inches (mm)

Blanking Plugs

M22...B-₋

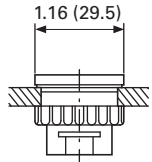

Pushbutton Diaphragm

M22-T-D

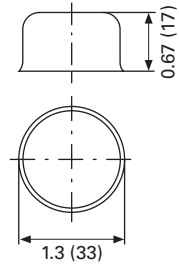

M22-T-D

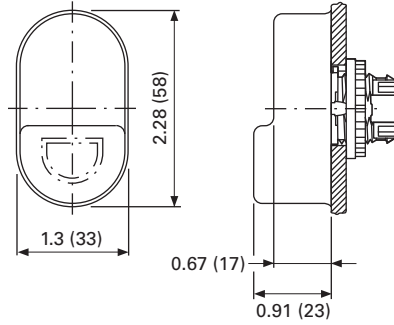

Guard Ring

M22-XGWK

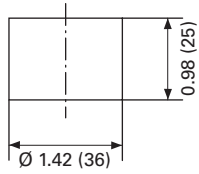

M22-XGPV

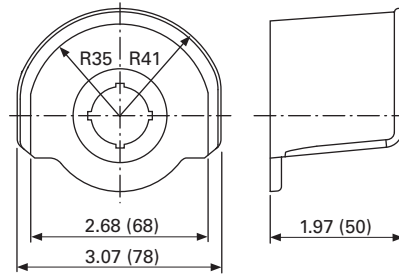

Key Cover

M22-XWS

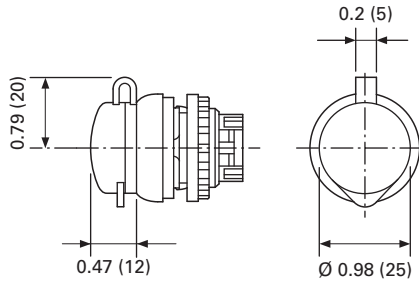

Emergency Stop Legend Plate

M22-XAK-₋

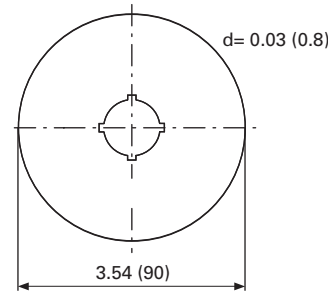

M22-X(Y)ZK-₋

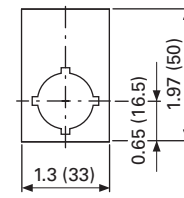

M22-XBK-₋

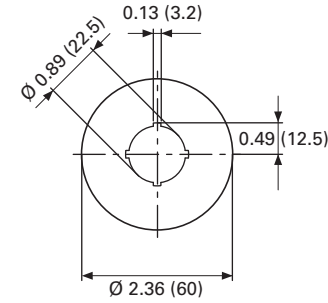

M22-XYK-₋

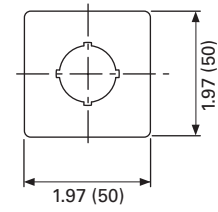

Joystick

M22...W...J-₋

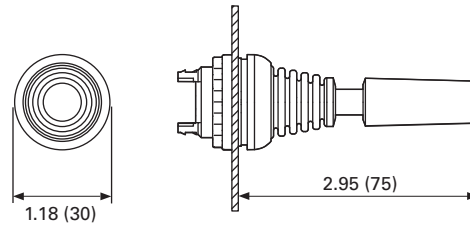

Four-Way Pushbutton

M22...D...4-₋

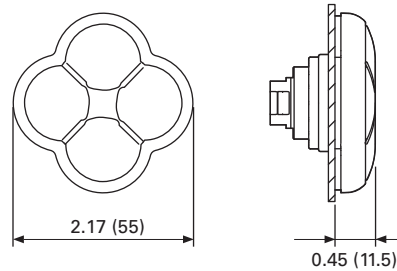

Symbols Library

Instructions for Ordering Laser Inscriptions

1. Identify part number to be inscribed.
2. Pick symbol from library and identify suffix code associated with the symbol.
3. Order part number already listed in the catalog with -ETCH suffix.
4. When placing an order by fax or Vistaline on the Web, reference order item number and indicate appropriate suffix code.

Example

To order a green flush button plate with the inscription AUTO HAND:

Order Catalog Number: M22-XD-G-ETCH (see **Page V7-T1-55**).

AUTO HAND inscription is found on **Page V7-T1-133** in the Symbols Library, suffix code is X91.

In the order notes, reference item number and suffix X91.

Letter height 3 mm: max. three lines, max. 12 characters per line.

Letter height 5 mm: max. two lines, max. eight characters per line.

Note: For symbols or text not found in the Symbols Library, please contact the Eaton Technical Resource Center at 1-877-ETN CARE (386-2273) or TRC@eaton.com.

Letter Height Specifications: ≤ five characters; letter height = 0.197 in (5 mm). > five characters; letter height = 0.118 in (3 mm).

Text—English

Inscription	Catalog Number Suffix
STOP	GB0
START	GB1
CLOSE	GB2
UP	GB3
DOWN	GB4
OFF	GB5
ON	GB6
RUN	GB7
FAULT	GB8
TEST	GB9
OFF ON	GB10
MAN. AUTO	GB11
MAN. 0 AUTO	GB12
RESET	GB14
FORWARD	GB15
REVERSE	GB16
RAISE	GB17

Text—German

Inscription	Catalog Number Suffix
LOWER	GB18
LEFT	GB19
RIGHT	GB20
BRAKE	GB21
HIGH	GB22
LOW	GB23
FAST	GB24
SLOW	GB25
FASTER	GB26
SLOWER	GB27
OPEN	GB32
PROG	GB62
CALL	GB63
OCCUPIED	GB64
BYPASS 0 1	GB65
BYPASS UP	GB66
EMERGENCY-STOP	GB99

Inscription	Catalog Number Suffix
Halt	D0
Start	D1
Zu	D2
Auf	D3
Ab	D4
Aus	D5
En	D6
Betrieb	D7
Störung	D8
Prüfung	D9
Aus Ein	D10
HAND AUTO	D11
HAND 0 AUTO	D12
Antrieb	D13
Entsperren	D14
Vorwärts	D15
Rückwärts	D16
Heben	D17
Senken	D18
Links	D19
Rechts	D20
Bremsen	D21
Hoch	D22
Niedrig	D23
Schnell	D24

Inscription	Catalog Number Suffix
Langsam	D25
HAND	D28
AUTO	D29
Einrichten	D30
Tippen	D31
Öffnen	D32
Steuerspannung	D33
Start Automatik	D34
Lampentest	D35
Phasenkontrolle	D36
Alarm	D37
Alarm - Reset	D38
Sammelstörung	D39
Quittieren	D40
Quittierung	D41
Steuerung Ein	D42
Steuerung Aus	D43
Störung quittieren	D44
FÜHLER int. ext.	D72
HEIZUNG 1 2	D73
AUS- BLASEN	D74
SOLLWERT int. ext.	D75
Not-Aus	D99
Not - Aus quittieren	D100

Text Size: 3 mm—Max. eight characters in first line; 10 characters in second line; eight characters in third line.



Text Size: 5 mm—Max. five characters per line.



Letter Height Specifications: ≤ five characters; letter height = 0.197 in (5 mm). > five characters; letter height = 0.118 in (3 mm).











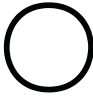





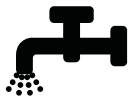







Text—French

Inscription	Catalog Number Suffix
ARRÊT	F0
MARCHE	F1
FERMÉ	F2
MONTÉE	F3
DESCENTE	F4
ARRÊT	F5
MARCHE	F6
EN SERVICE	F7
PANNE	F8
ESSAI	F9
ARRÊT MARCHÉ	F10
MAN. AUTO	F11
MAN. 0 AUTO	F12
REARM.	F14
AVANT	F15
ARRIÈRE	F16
MONTER	F17
DESCENDRE	F18
GAUCHE	F19
DROITE	F20
DEFAULT	F67
SOUS TENSION	F68
ARRÊT D'URGENCE	F99

Text—Swedish

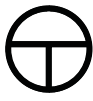
Inscription	Catalog Number Suffix
STOPP	S0
START	S1
STÄNG	S2
UPP	S3
NED	S4
FRÅN	S5
TILL	S6
KÖR	S7
FEL	S8
PROV	S9
FRÅN TILL	S10
MAN. AUTO	S11
MAN. 0 AUTO	S12
ÅTERSTÄLLNING	S14
FRAM	S15
BACK	S16
ÖKA	S17
MINSKA	S18
VÄNSTER	S19
HÖGER	S20
BROMS	S21
HÖG	S22
LÅG	S23
ÖPPNA	S32
IN	S45
UT	S46
NÖDSTOPP	S99

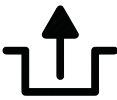
Symbols

Inscription	Catalog Number Suffix	Inscription	Catalog Number Suffix
	X0		X13
	X1		X14
	X2		X15
	X3		X16
	X4		X17
	X5		X18
	X6		X19
	X7		X20
	X8		X21
	X9		X22
	X10		X23
	X11		X24
	X12		X25

Text Size: 3 mm—Max. eight characters in first line; 10 characters in second line; eight characters in third line.



Text Size: 5 mm—Max. five characters per line.















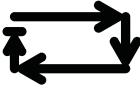
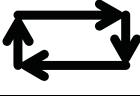







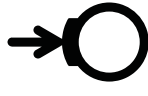

1.5

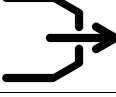





Pushbuttons and Indicating Lights



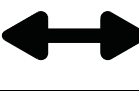









22.5 mm Modular Pushbuttons—M22

1

Inscription	Catalog Number Suffix
	X26
	X27
	X28
	X29
	X30
	X31
	X32
	X33
	X34
	X35
	X36
	X37
	X38
	X39

Inscription	Catalog Number Suffix
	X40
	X41
	X42
	X43
	X44
	X45
	X46
	X47
	X48
	X49
	X50
0	X51
1	X52
2	X53

Inscription	Catalog Number Suffix
3	X54
4	X55
5	X56
6	X57
7	X58
8	X59
9	X60
	X61
	X62
	X63
	X64
	X65
	X66
	X67

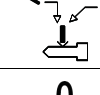
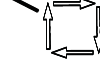
Inscription	Catalog Number Suffix
	X68
	X69
	X70
	X71
	X72
	X73
	X74
	X75
	X76
	X77
	X78
	X79
	X80
	X81

Text Size: 3 mm—Max. eight characters in first line; 10 characters in second line; eight characters in third line.



Text Size: 5 mm—Max. five characters per line.



Inscription	Catalog Number Suffix	Inscription	Catalog Number Suffix	Inscription	Catalog Number Suffix	Inscription	Catalog Number Suffix
	X82		X104		X118		X132
	X83		X105		X119		X133
0 I	X88		X106		X120		X134
0 I	X89		X107		X121		X135
I 0	X90		X108		X122		X136
AUTO HAND	X91		X109		X123		X137
II I	X92		X110		X124		X138
I 0 II	X93		X111		X125		X139
Auto 0 Man.	X94		X112		X126		X140
I II	X95		X113		X127		X141
	X100		X114		X128		X142
	X101		X115		X129		X143
	X102		X116		X130		X144
	X103		X117		X131		X145

Text Size: 3 mm—Max. eight characters in first line; 10 characters in second line; eight characters in third line.



Text Size: 5 mm—Max. five characters per line.













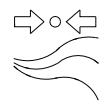



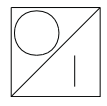
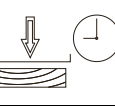

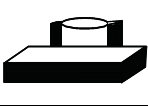
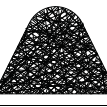
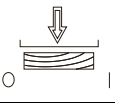

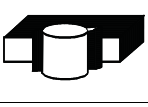
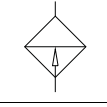

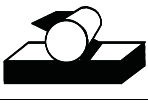
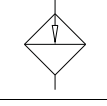
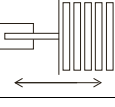

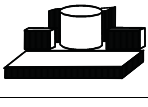
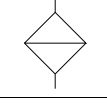
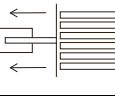

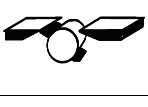
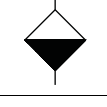
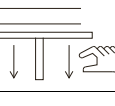

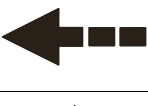
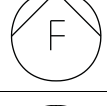
1.5

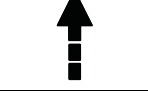
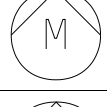
Pushbuttons and Indicating Lights

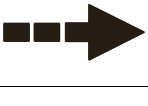
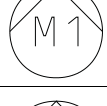
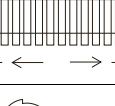
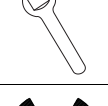
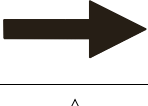
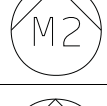
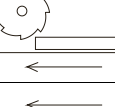
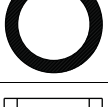
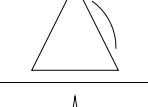
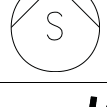
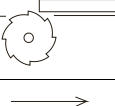
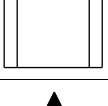
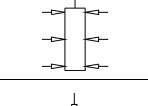
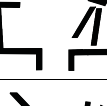
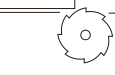
22.5 mm Modular Pushbuttons—M22

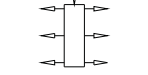
1











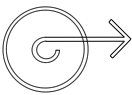



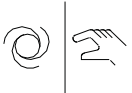

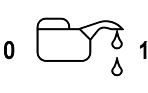
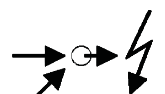



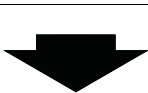

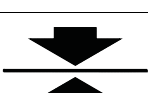

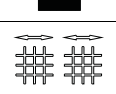
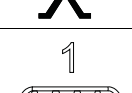







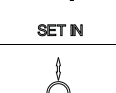



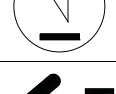
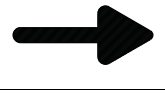

Inscription	Catalog Number Suffix	Inscription	Catalog Number Suffix	Inscription	Catalog Number Suffix	Inscription	Catalog Number Suffix
	X146		X160		X174		X188
	X147		X161		X175		X189
	X148		X162		X176		X190
	X149		X163		X177		X191
	X150		X164		X178		X192
	X151		X165		X179		X193
	X152		X166		X180		X194
	X153		X167		X181		X195
	X154		X168		X182		X196
	X155		X169		X183		X197
	X156		X170		X184		X198
	X157		X171		X185		X199
	X158		X172		X186		X200
	X159		X173		X187		X201

Text Size: 3 mm—Max. eight characters in first line; 10 characters in second line; eight characters in third line.



Text Size: 5 mm—Max. five characters per line.



Inscription	Catalog Number Suffix	Inscription	Catalog Number Suffix	Inscription	Catalog Number Suffix	Inscription	Catalog Number Suffix
	X202		X216		X230		X244
	X203		X217		X231		X245
L 1	X204		X218		X232		X246
L 2	X205		X219		X233		X247
L 3	X206		X220		X234		X248
↑ A	X207		X221		X235		X249
↓ A	X208		X222		X236		X250
↓ B	X209		X223		X237		X251
↑ B	X210		X224		X238		X252
I	X211		X225		X239		X253
II	X212		X226		X240		X254
III	X213		X227		X241		X255
	X214		X228		X242		X256
	X215		X229		X243		X257

Text Size: 3 mm—Max. eight characters in first line; 10 characters in second line; eight characters in third line.



Text Size: 5 mm—Max. five characters per line.



1.5

Pushbuttons and Indicating Lights

22.5 mm Modular Pushbuttons—M22

1

Inscription	Catalog Number Suffix	Inscription	Catalog Number Suffix	Inscription	Catalog Number Suffix	Inscription	Catalog Number Suffix
	X258		X265	CHEM II	X272		X279
	X259		X266	CHEM III	X273		X280
	X260		X267		X274	OUT OF SERVICE	X281
	X261		X268		X275		X282
	X262		X269	CONTI → CUT	X276		X283
	X263		X270		X277		X284
	X264	CHEM I	X271		X278		X285

Text Size: 3 mm—Max. eight characters in first line; 10 characters in second line; eight characters in third line.



Text Size: 5 mm—Max. five characters per line.

