

10250T Pushbuttons



RMQ-Titan M22 Series



RMQ Compact C22 Series



| | | |
|-------------|--|------------------|
| 1.1 | Toggle Switches—E10 | |
| | Product Description | V7-T1-2 |
| | Product Selection | V7-T1-4 |
| 1.2 | Pushbutton Control Stations—Assembled | |
| | Product Description | V7-T1-8 |
| | Product Selection | V7-T1-10 |
| 1.3 | 16.2 mm Pushbuttons—RMQ-16 | |
| | Product Selection Guide | V7-T1-25 |
| | Product Selection | V7-T1-26 |
| 1.4 | 22.5 mm RMQ-Titan Modular Pushbuttons—M22 | |
| | Product Selection Guide | V7-T1-42 |
| | Product Selection | V7-T1-47 |
| 1.5 | 22.5 mm RMQ Compact Pushbuttons—C22 | |
| | Product Selection Guide | V7-T1-133 |
| | Product Selection | V7-T1-135 |
| 1.6 | Global Modular 30 mm Pilot Devices—M30 Flat Operators | |
| | Product Description | V7-T1-168 |
| | Product Selection | V7-T1-172 |
| 1.7 | Global Compact 30 mm Pilot Devices—C30 Flat with Pigtail | |
| | Product Description | V7-T1-186 |
| | Product Selection | V7-T1-188 |
| 1.8 | 30.5 mm Square Multifunction Watertight/Oiltight—E30 | |
| | Product Description | V7-T1-195 |
| | Product Selection | V7-T1-197 |
| 1.9 | 30.5 mm Heavy-Duty Watertight/Oiltight—10250T | |
| | Product Description | V7-T1-213 |
| | Product Selection | V7-T1-217 |
| 1.10 | 30.5 mm Corrosion Resistant Watertight/Oiltight—E34 | |
| | Product Description | V7-T1-284 |
| | Product Selection | V7-T1-290 |
| 1.11 | 30.5 mm Watertight/Oiltight—HT800 | |
| | Product Description | V7-T1-326 |
| | Product Selection | V7-T1-328 |
| 1.12 | 30.5 mm Class I Division 2 Hazardous Locations—10250T/E34 | |
| | Product Description | V7-T1-351 |
| | Catalog Number Selection | V7-T1-353 |

Volume 7—Logic Control, Operator Interface and Connectivity Solutions, CA08100008E

Tab 1—Pushbuttons and Indicating Lights

| Revision date | Section | Change page(s) | Description |
|---------------|---------|----------------|----------------------------------|
| 03/27/2019 | 1.5 | V7-T1-132 | Content edits |
| 03/27/2019 | 1.5 | V7-T1-153 | Content edits |
| 03/27/2019 | 1.7 | V7-T1-192 | Content edits, tech data updates |



Powering Business Worldwide



Product Description

The E10 switches from Eaton's Electrical Sector are intended for general purpose light industrial use. Designed for retrofit and OEM applications.

Features

General Purpose Toggles

- Various circuit functions include maintained and momentary
- Poles include from single-pole single-throw to four-pole double-throw
- Spade, screw, and solder terminations available
- Numerous ratings
- Short 11/32 in and tall 15/32 in bat lever available
- Standard 15/32–32 thd.
- Hardware furnished assembled

Contents

Description

| | <i>Page</i> |
|---|----------------|
| Toggle Switches—E10 | |
| Standards and Certifications | V7-T1-3 |
| Catalog Number Selection | V7-T1-3 |
| Product Selection | |
| Toggle Switches | V7-T1-4 |
| Hesitation Switches | V7-T1-5 |
| Pushbuttons | V7-T1-5 |
| Accessories | V7-T1-5 |
| Technical Data and Specifications | V7-T1-6 |
| Circuit Diagrams | V7-T1-6 |
| Dimensions | V7-T1-7 |

Heavy-Duty Hesitation Switches

- One-hole panel mount
- Three position switch offers unique positive center stop feature to assure lever cannot be thrown from one side through the center OFF position without stopping
 - Design feature is a major acceptance for motor reversing and speed control applications
- Prevents motor damage resulting from high current generation by counter EMF of the armature at the time of reversing
- Known as anti-plugging, hesitation, positive stop or positive off switch

Non-Illuminated AC Rated Pushbuttons

- One-hole panel mount
- Medium-duty
- Spade and screw terminations available
- Various bushing lengths and button extensions
- Numerous ampere ratings with horsepower ratings

Standards and Certifications

- UL Recognized
- CSA—File No. LR40068



Catalog Number Selection

Catalog Number Selection is for illustrative purposes only and not to be used to create new catalog numbers.

Toggle Switches—E10 Series

Not to be used for ordering purposes

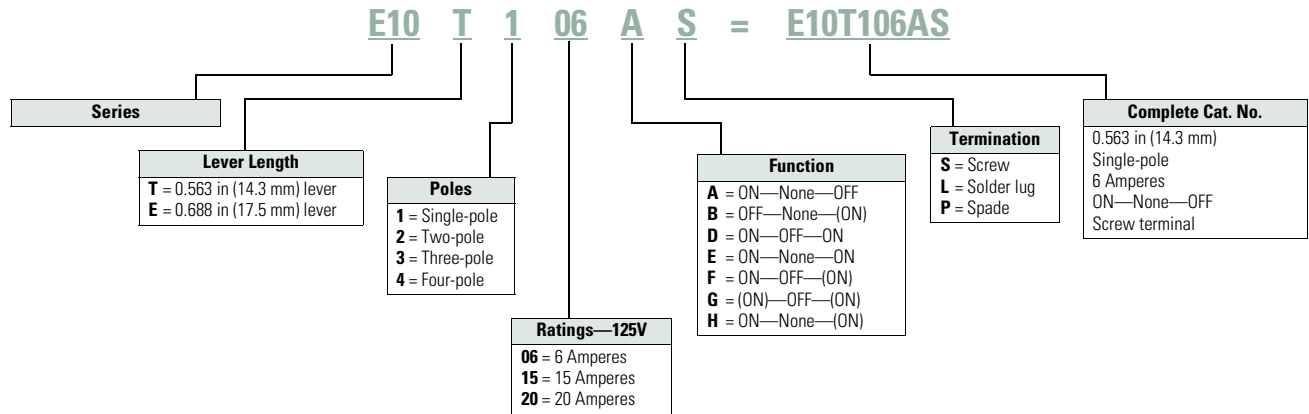

Product Selection

Toggle Switches

E10 Series—AC Rated—Minimum Order Quantity 10 Pieces

| | Nominal AC Ratings | | | Poles and Throw ① | Function—Circuit with Lever In | | | Screw Terminal Catalog Number | 0.250 in (6.4 mm) Spade Terminal Catalog Number | Solder Lug Catalog Number |
|---|--------------------|---------|----------|-------------------|--------------------------------|-----------------|----------------------|-------------------------------|---|---------------------------|
| | Amperes 125V | hp 250V | hp 50V | | UP Position | CENTER Position | DOWN Position—Keyway | | | |
| Single-Pole | | | | | | | | | | |
|  | Single-Pole | | | | | | | | | |
| | 6 | 3 | — | 1 P.S.T. | ON | None | OFF | E10T106AS | E10T106AP | E10T106AL |
| | 15 | 10 | 3/4 | | | | | E10T115AS | E10T115AP | E10T115AL |
| | 20 | 10 | 3/4 | | | | | E10E120AS | E10E120AP | E10E120AL |
| | 6 | 3 | — | 1 P.D.T. | ON | OFF | ON | E10T106DS | E10T106DP | — |
| | 15 | 10 | 3/4 | | | | | E10T115DS | E10T115DP | E10T115DL |
| | 20 | 10 | 3/4 | | | | | E10E120DS | — | — |
| | 6 | 3 | — | 1 P.D.T. | ON | None | ON | E10T106ES | — | — |
| | 15 | 10 | 3/4 | | | | | E10T115ES | E10T115EP | E10T115EL |
| | 20 | 10 | 3/4 | | | | | E10E120ES | — | — |
| | — | 10 | 1/2 | 1 P.S.T. | OFF | None | (ON) | E10T115BS | E10T115BP | — |
| | | | | 1 P.D.T. | ON | OFF | (ON) | E10T115FS | E10T115FP | — |
| | | | | 1 P.D.T. | ON | None | (ON) | E10T115HS | E10T115HP | — |
| | | | 1 P.D.T. | (ON) | OFF | (ON) | E10T115GS | E10T115GP | — | |
| Two-Pole | | | | | | | | | | |
|  | Two-Pole | | | | | | | | | |
| | 6 | 3 | — | 2 P.S.T. | ON | None | OFF | E10T206AS | E10T206AP | — |
| | 15 | 10 | 3/4 | | | | | E10T215AS | E10T215AP | E10T215AL |
| | 20 | 10 | 3/4 | | | | | E10E220AS | E10E220AP | E10E220AL |
| | 6 | 3 | — | 2 P.D.T. | ON | OFF | ON | E10T206DS | E10T206DP | — |
| | 15 | 10 | 3/4 | | | | | E10T215DS | E10T215DP | E10T215DL |
| | 20 | 10 | 3/4 | | | | | E10E220DS | E10E220DP | — |
| | 6 | 3 | — | 2 P.D.T. | ON | None | ON | E10T206ES | — | — |
| | 15 | 10 | 3/4 | | | | | E10T215ES | E10T215EP | E10T215EL |
| | 20 | 10 | 3/4 | | | | | E10E220ES | — | — |
| | 15 | 10 | 1/2 | 2 P.S.T. | OFF | None | (ON) | E10T215BS | — | — |
| | | | | 2 P.D.T. | ON | None | (ON) | E10T215HS | E10T215HP | — |
| | | | | 2 P.D.T. | (ON) | OFF | (ON) | E10T215GS | E10T215GP | — |
| Three-Pole | | | | | | | | | | |
|  | Three-Pole | | | | | | | | | |
| | 15 | 10 | 3/4 | 3 P.S.T. | ON | None | OFF | E10E315AS | E10E315AP | — |
| | | | | 3 P.D.T. | ON | OFF | ON | E10E315DS | E10E315DP | E10E315DL |
| | | | 3 P.D.T. | ON | None | ON | E10E315ES | E10E315EP | E10E315EL | |
| Four-Pole | | | | | | | | | | |
|  | Four-Pole | | | | | | | | | |
| | 15 | 10 | 3/4 | 4 P.S.T. | ON | None | OFF | E10E415AS | — | E10E415AL |
| | | | | 4 P.D.T. | ON | OFF | ON | E10E415DS | — | E10E415DL |
| | | | 4 P.D.T. | ON | None | ON | E10E415ES | — | E10E415EL | |

Note

① See Circuit Diagrams on Page V7-T1-6.

Hesitation Switches

Heavy-Duty Hesitation Switch



E10 Series—Special Purpose—Minimum Order Quantity 10 Pieces

| Nominal Ratings | | | | Function—Circuit with Lever In... | | | | | Poles and Throw ① | Screw Terminal Catalog Number |
|-----------------|---------|---------|---------|-----------------------------------|-------------|-----------------|----------------------|----------|-------------------|-------------------------------|
| Amperes | | hp | | Operation | UP Position | CENTER Position | DOWN Position—Keyway | | | |
| 28 Vdc | 125 Vac | 250 Vac | 250 Vac | | | | | | | |
| 15 | 15 | 10 | 3/4 | Maintained | ON | OFF | ON | 2 P.D.T. | E10E215SS | |
| | | | | | | | | 3 P.D.T. | E10E315SS | |
| | | | | | | | | 4 P.D.T. | E10E415SS | |

Pushbuttons

One-Hole Mounted Medium-Duty, Mom. Contact



E10 Series—Minimum Order Quantity 10 Pieces

| Nominal Ratings | | | | Poles and Throw ① | Contacts | Bushing Length in (mm) Dim. "A" | Button Extension in (mm) Dim. "B" | Typical Maximum Operating Force | Screw Terminal Catalog Number | Spade Terminal 0.250 in (6.4 mm) Catalog Number | |
|-----------------|---------|----------|----|-------------------|----------|---------------------------------|-----------------------------------|---------------------------------|-------------------------------|---|-----------------------|
| Amperes | | hp | | | | | | | | | |
| 125 Vac | 250 Vac | 125–250V | | | | | | | | | |
| NO | NC | NO | NC | | | | | | | | |
| 6 | — | 3 | — | — | 1 P.S.T. | NO | 0.69 (17.5) 0.34 (8.6) | 0.53 (13.5) 0.25 (6.4) | 0.9 lbs | E10P106RS E10P106JS | E10P106RP — |
| 15 | — | 10 | — | 1/3 | 1 P.S.T. | NO | 0.69 (17.5) 0.34 (8.6) | 0.53 (13.5) 0.25 (6.4) | 0.9 lbs | E10P115RS E10P115JS | E10P115RP — |
| 15 | 10 | 10 | 5 | 1/4 ② | 1 P.D.T. | NO, NC | 0.69 (17.5) | 0.53 (13.5) | 1.0 lbs | E10P115LS | — |

Accessories

Toggle Switches Accessories—Minimum Order Quantity 100 Pieces

| Description | Material/Notes | Catalog Number |
|--|-------------------------------|-----------------|
| Hexagon locknut | Zinc-chromate treated steel | E10TA101 |
| Knurled face nut | Zinc-chromate treated steel | E10TA102 |
| Internal tooth lockwasher | Cadmium plated steel | E10TA103 |
| Terminal screws | #6-32 x 3/16 in binding head | E10TA201 |
| Spade terminal adapter—0.250 in (6.4 mm) | Assembles to screw terminals | E10TA202 |
| ON-OFF indicating plate—vertical orientation | Burnished nickel finish steel | E10TA301 |
| OFF-ON indicating plate—horizontal orientation | Burnished nickel finish steel | E10TA302 |

E10TA104



Flip-up guard for toggle switches **E10TA104**

E10TA105



Fixed shroud for toggle switches **E10TA105**

Notes

Interlock mechanism prevents operation of lever through the center position until pressure is momentarily relieved. Designed for control and protection of reversing motors.

① See Circuit Diagrams on **Page V7-T1-6**.

② Rated 1/4 hp at 125V, 1/2 hp at 250V.

Technical Data and Specifications

Toggle Switches

| Description | Specification |
|-----------------|---|
| AC ratings | 6–20A, 125 Vac 3–10A, 250 Vac Max. 3/4 hp at 250 Vac |
| DC ratings | 6–20A, 28 Vdc |
| Electrical life | 6,000 cycles make/break at switch ampere rating |
| Operation | Slow make/slow break mechanism with butt action for AC and low voltage DC applications Maintained and momentary contacts |
| Poles/throws | 1 through 4, single and double throw |
| Mounting | One hole with threaded 0.468 in-32 bushing and 0.068 x 0.035 in (1.7 x 0.9 mm) deep keyway that serves as anti-rotational feature |
| Lever lengths | 0.563 in (14.3 mm) or 0.688 in (17.5 mm), bright nickel plated |
| Terminals | Screw, 0.250 in (6.4 mm) spade and solder lug |

Hesitation Switches

| Description | Specification |
|--------------|--|
| Operation | Slow make/slow break mechanism with butt action for AC and low voltage DC applications; maintained contacts; ideal for reversing motor applications; interlock mechanism prevents operation of lever through center position until manual pressure is momentarily relieved |
| AC ratings | 15A, 125 Vac 10A, 250 Vac Max. 3/4 hp at 250 Vac |
| DC ratings | 15A, 28 Vdc |
| Poles/throws | 2, 3 and 4, double throw only |
| Mounting | Single-pole with threaded 0.468 in-32 bushing and 0.068 x 0.049 in (1.7 x 1.2 mm) deep keyway |
| Lever length | 0.687 in (17.4 mm), stainless steel |
| Terminals | Screw |

Pushbutton Actuators

| Description | Specification |
|-------------------|---|
| AC ratings | 6–15A, 125 Vac (NO) 3–10A, 250 Vac (NO) Max. 1/3 hp at 125/250 Vac |
| Operation | Slow make/slow break mechanism Normally open contacts |
| Poles/throws | Single, single and double throw |
| Mounting | One hole with 0.468 in-32 threaded bushing and 0.068 x 0.035 in (1.7 x 0.9 mm) deep keyway Two bushing heights: 11/16 in (17.5 mm) and 11/32 in (8.7 mm) |
| Button extensions | 17/32 in (13.5 mm) and 1/4 in (6.4 mm), bright nickel plated |
| Terminals | Screw |

Circuit Diagrams

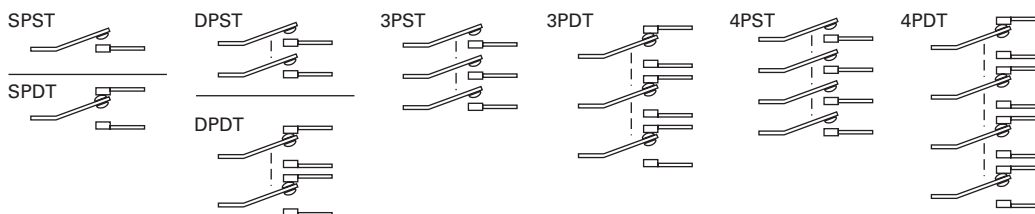

Dimensions

Approximate Dimensions in Inches (mm)

Toggle Switch Dimensions

| No. of Poles | Operation | Bushing Length A | Lever Length B | Screw Terminals | | | Spade Terminals | | | Solder Lug | | |
|--------------|--------------------------|---------------------|-------------------|-----------------|----------------|----------------|-----------------|----------------|----------------|----------------|----------------|----------------|
| | | | | C | D | E | C ^① | D | E | C | D | E |
| 1 | Momentary and maintained | 0.47 (11.9) | 0.56 (14.2) | 1.00 (25.4) | 1.17 (29.7) | 0.63 (16.0) | 1.13 (28.7) | 1.13 (28.7) | 0.63 (16.0) | 1.00 (25.4) | 1.13 (28.7) | 0.63 (16.0) |
| 2 | Maintained | 0.47 (11.9) | 0.56 (14.2) | 1.06 (26.9) | 1.31 (33.3) | 0.75 (19.1) | 1.19 (30.2) | 1.31 (33.3) | 0.75 (19.1) | 1.06 (26.9) | 1.31 (33.3) | 0.75 (19.1) |
| | Momentary | 0.47 (11.9) | 0.56 (14.2) | 1.25 (31.8) | 1.31 (33.3) | 0.75 (19.1) | 1.31 (33.3) | 1.31 (33.3) | 0.75 (19.1) | 1.25 (31.8) | 1.31 (33.3) | 0.75 (19.1) |
| 3 | Maintained | 0.47 (11.9) | 0.69 (17.5) | 1.27 (32.3) | 1.34 (34.0) | 1.44 (36.6) | 1.37 (34.8) | 1.34 (34.0) | 1.44 (36.6) | 1.23 (31.2) | 1.34 (34.0) | 1.44 (36.6) |
| 4 | Maintained | 0.47 (11.9) | 0.69 (17.5) | 1.20 (30.5) | 1.30 (33.0) | 1.40 (35.6) | 1.30 (33.0) | 1.34 (34.0) | 1.40 (35.6) | 1.23 (31.2) | 1.34 (34.0) | 1.44 (36.6) |

Toggle Switch

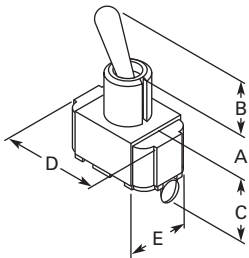

Hesitation Switch

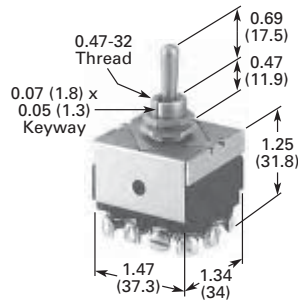

Pushbutton Actuator

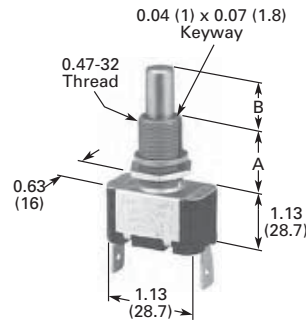

Accessories

E10TA101 Hexagon Locknut

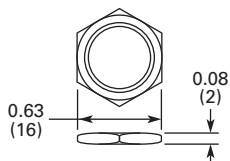

E10TA102 Knurled Face Nut

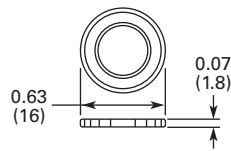

E10TA301 ON-OFF Indicating Plate—Vertical Orientation

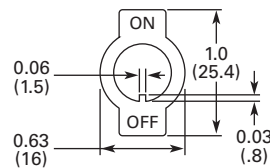

E10TA302 ON-OFF Indicating Plate—Horizontal Orientation



Note

① Spade terminal adapters are used on 6 ampere and momentary screw terminal switches, adding 0.42 in (10.7 mm) to dimension C.

Pushbutton Control Stations



Contents

| <i>Description</i> | <i>Page</i> |
|--|-----------------|
| Pushbutton Control Stations—Assembled | |
| Features | V7-T1-9 |
| Product Selection | |
| M22 Assembled Control Stations | V7-T1-10 |
| Commercial Control Stations | V7-T1-11 |
| General Purpose Control Stations | V7-T1-12 |
| Special Purpose Control Stations | V7-T1-13 |
| 10250H Series Heavy-Duty Control Stations | V7-T1-14 |
| 10250T Series Heavy-Duty 30.5 mm Control Stations | V7-T1-15 |
| Class I Division 2 10250T Series Heavy-Duty 30.5 mm Control Stations | V7-T1-16 |
| Class I Division 2 E34 Series Corrosion Resistant 30.5 mm Control Stations | V7-T1-17 |
| Accessories | V7-T1-17 |
| Custom Assembled Stations | |
| Specification Form | V7-T1-18 |
| Renewal Parts | V7-T1-20 |
| Technical Data and Specifications | V7-T1-22 |
| Dimensions | V7-T1-22 |

Product Description

M22 Assembled Control Stations

- M22 series operators
- Available in horizontal and vertical configurations
- Impact resistant polycarbonate enclosures
- Optional yellow covers
- Base mounting contact blocks and light units for quick wiring and vibration resistance

Commercial Control Stations

- 10250T series operators
- Full front label
- Specific function labels on front of enclosure

General Purpose Control Stations

- Construction grade
- General purpose wall mount
- Popular with contractors
- UL (NEMA) Type 1

Special Purpose Control Stations

- Standard grade
- Polyester enclosure
- UL (NEMA) Type 3, 3R, 4, 4X, 13

10250H Series Heavy-Duty Control Stations

- 10250H Series operators
- Dark brown polyester enclosure
- Protective rubber gaskets provide NEMA 3S rating on pushbuttons
- Top and bottom 3/4 in NPT conduit entrances
- Includes alternate legend plates and spare mounting screws

10250T Series Heavy-Duty 30.5 mm Control Stations

- 10250T Series operators
- ASA 61 gray die-cast zinc enclosures
- Surface or flush mounting
- Single 3/4 in NPT conduit entrance on one and two element stations
- Single 1 in NPT conduit entrance on three element stations

Class I Division 2 10250T Series Heavy-Duty 30.5 mm Control Stations

- 10250T Series operators
- Factory sealed contact blocks
- Die-cast, polyester or stainless steel enclosures
- Approved for NEC Class I Division 2, Groups B, C and D or Class I Zone 2 Group IIB plus Hydrogen type hazardous locations

Class I Division 2 E34 Series Corrosion Resistant 30.5 mm Control Stations

- E34 Series operators
- Factory sealed contact blocks
- Die-cast, polyester or stainless steel enclosures
- Approved for NEC Class I Division 2 Groups B, C and D or Class I Zone 2 Group IIB plus Hydrogen type hazardous locations

Features

M22 Assembled Control Stations

- IP66, UL (NEMA) Type 4X, 13
- Impact resistant polycarbonate enclosures
- Optional yellow cover
- 25% smaller depth than most competitor enclosures
- Base mounting contact blocks and light units for faster wiring and vibration resistance

Commercial Control Stations

- ASA 61 gray die-cast zinc enclosures
- Pre-assembled and labeled for functions such as “Fuel Shut-Off”
- Great for commercial applications

General Purpose Control Stations

- Construction grade
- General purpose wall mount
- Popular with contractors
- UL (NEMA) Type 1

Special Purpose Control Stations

- Standard grade
- Polyester enclosure
- UL (NEMA) Type 3, 3R, 4, 4X, 13

10250H Series Heavy-Duty Control Stations

- Industrial grade
- Extra heavy-duty
- Polyester enclosure
- Booted buttons
- Outdoor installation
- UL (NEMA) Type 3, 3R, 3S, 4, 4X, 12, 13

10250T Series Heavy-Duty 30.5 mm Control Stations

- 30.5 mm operators
- Industrial grade
- Zinc die cast enclosure
- Popular with industrial end users
- UL (NEMA) Type 4, 4X, 12, 13

Class I Division 2 Control Stations

- Available with 10250T or E34 30.5 mm operators
- Zinc die cast, polyester or stainless steel enclosures
- Factory-sealed contact blocks
- Popular with industrial end users
- UL (NEMA) Type 4, 4X, 12, 13
- NEC Class I Division 2 Groups B, C and D

Product Selection

M22 Assembled Control Stations



One Element Control Stations

| Orientation | Description | Color | ① | Inscription | Enclosure Cover Color | Catalog Number |
|-------------|---|-------|-------|-------------|-----------------------|----------------|
| Horizontal | 40 mm mushroom head push-pull emergency stop operator | Red | NC | — | Yellow | M22-C1-M1H |
| Horizontal | 40 mm illuminated mushroom head push-pull emergency stop operator, 85–264 Vac | Red | NO-NC | — | Yellow | M22-C1-M2H |
| Horizontal | 40 mm mushroom head twist-to-release emergency stop operator | Red | NC | — | Yellow | M22-C1-M3H |
| Horizontal | 40 mm mushroom head key-release emergency stop operator | Red | NC | — | Yellow | M22-C1-M4H |
| Horizontal | Flush pushbutton | Green | NO | ① | Gray | M22-C1-M5H |
| Horizontal | Flush pushbutton | Green | NO | START | Gray | M22-C1-M6H |
| Horizontal | Extended pushbutton | Red | NC | ⊙ | Gray | M22-C1-M7H |
| Horizontal | Extended pushbutton | Red | NC | STOP | Gray | M22-C1-M8H |
| Horizontal | Key-operated selector switch, two-position maintained | — | NO | OFF-ON | Gray | M22-C1-M9H |
| Horizontal | Knob type selector switch, three-position maintained | — | 2NO | HAND 0 AUTO | Gray | M22-C1-M10H |
| Horizontal | Double pushbutton | Green | NO | START | Gray | M22-C1-M11H |
| | | Red | NC | STOP | | |

Two Element Control Stations

| Orientation | Element 1 Description | Color | ① | Inscription | Element 2 Description | Color | ① | Inscription | Enclosure Cover Color | Catalog Number |
|-------------|-----------------------|-------|----|-------------|-----------------------|-------|----|-------------|-----------------------|----------------|
| Horizontal | Extended pushbutton | Red | NC | ⊙ | Flush pushbutton | Green | NO | ① | Gray | M22-C2-M1H |
| Vertical | Flush pushbutton | Green | NO | START | Extended pushbutton | Red | NC | STOP | Gray | M22-C2-M2V |
| Vertical | Flush pushbutton | Black | NO | FORWARD | Flush pushbutton | Black | NO | REVERSE | Gray | M22-C2-M3V |

Three Element Control Stations

| Orientation | Element 1 Description | Color | ① | Inscription | Element 2 Description | Color | ① | Inscription | Element 3 Description | Color | ① | Inscription | Enclosure Cover Color | Catalog Number |
|-------------|-----------------------|-------|------------|-------------|-----------------------|-------|------------|-------------|-----------------------|-------|----|-------------|-----------------------|----------------|
| Horizontal | Extended pushbutton | Red | NC | ⊙ | Indicating light | White | 85–264 Vac | — | Flush pushbutton | Green | NO | ① | Gray | M22-C3-M1H |
| Vertical | Indicating light | White | 85–264 Vac | — | Flush pushbutton | Green | NO | START | Extended pushbutton | Red | NC | STOP | Gray | M22-C3-M2V |
| Horizontal | Flush pushbutton | Green | NO | ① | Extended pushbutton | Red | NC | ⊙ | Flush pushbutton | Green | NO | ② | Gray | M22-C3-M3H |
| Vertical | Flush pushbutton | Black | NO | OPEN | Extended pushbutton | Red | NC | STOP | Flush pushbutton | Black | NO | CLOSE | Gray | M22-C3-M4V |
| Vertical | Flush pushbutton | Black | NO | FORWARD | Flush pushbutton | Red | NC | STOP | Flush pushbutton | Black | NO | REVERSE | Gray | M22-C3-M5V |
| Vertical | Flush pushbutton | Black | NO | UP | Flush pushbutton | Red | NC | STOP | Flush pushbutton | Black | NO | DOWN | Gray | M22-C3-M6V |

Notes

For assembled control stations not found in this selection, please contact the Eaton Technical Resource Center at 1-877-ETN CARE (386-2273) or TRC@eaton.com.

① Contact block configuration.

Commercial Control Stations



Key Specifications

- 30.5 mm (10250T series) operators
- ASA 61 gray die-cast zinc enclosures
- Industrial grade
- UL® Type 4, 4X, 12, 13
- Single 3/4 in NPT conduit entrance
- Dimensions—in (mm)
 - Enclosure: 3.88 W x 4.00 H x 3.00 D (98.6 x 101.6 x 76.3)
 - Operator: 1.63 D (to enclosure) x 1.50 diameter (41.4 x 38.1)

What is included?

Eaton’s pre-assembled, enclosed emergency stop pushbutton stations include an operator, an enclosure, contact blocks and a variety of unique labels. Each label has white lettering on a red background indicating the function and red lettering on a white background indicating the operator type.

Available Catalog Numbers

| Catalog Number ^① | Operator | Enclosure Color | Label |
|-----------------------------|-----------|-----------------|---------------------------------|
| 10250T5B62-S101 | Push-Pull | Gray | EMERGENCY STOP |
| 10250T5B62-S102 | Push-Pull | Gray | EMERGENCY SHUT-OFF |
| 10250T5B62-S103 | Push-Pull | Gray | EMERGENCY GENERATOR STOP |
| 10250T5B62-S104 | Push-Pull | Gray | EMERGENCY HVAC SHUT-DOWN |
| 10250T5B62-S105 | Push-Pull | Gray | EMERGENCY ELECTRICAL DISCONNECT |
| 10250T5B62-S106 | Push-Pull | Gray | EMERGENCY BOILER SHUT-DOWN |
| 10250T5B62-S107 | Push-Pull | Gray | EMERGENCY CHILLER STOP |
| 10250T5B62-S108 | Push-Pull | Gray | EMERGENCY FUEL SHUT-OFF |
| 10250T5B62-S109 | Push-Pull | Gray | EMERGENCY REFRIGERATION STOP |
| 10250T5B62-S110 | Push-Pull | Gray | EMERGENCY POWER OFF |
| 10250T5B62-S111 | Push-Pull | Gray | EMERGENCY GAS SHUT-OFF |
| 10250T5B62-S112 | Push-Pull | Gray | EMERGENCY VENTILATION SHUT-DOWN |
| 10250T5B62-S113 | Push-Pull | Gray | GENERATOR |

Additional Contact Blocks

(Sold Separately)























| Catalog Number | Circuit Configuration |
|----------------|-----------------------|
| 10250T51 | 1NC |
| 10250T53 | 1NO |
| 10250T1 | NO-NC |
| 10250T3 | 2NC |
| 10250T2 | 2NO |

Note

① Includes 1NO-1NC contact block.

General Purpose Control Stations

Type N Control Stations—UL (NEMA) Type 1



| | Contact Symbol | Button Type/Color | Legends | Catalog Number |
|---|---|---|-------------------|-------------------------------|
| Single Button Station for Padlock Attachment ^①  | One Element Enclosure Type | | | |
| |  | Flush/green | START | 10250H5100 |
| |  | Flush/red | STOP | 10250H5101 |
| |  | Extended/red | STOP | 10250H5104 |
| |  | Palm operated/black | None | 10250H89 ^② |
| Selector Switch  |  | Three-position selector switch/black knob | RUN/OFF/AUTO | 10250H289 ^② |
| Two Button Station  | Two Element Enclosure Type | | | |
| |  | Flush/red | START/STOP | 10250H5200 |
| |  | Flush/green extended/red | START/STOP | 10250H5207 |
| |  | Flush/black (all) | RAISE/LOWER | 10250H5201 |
| | | | FOR/REV | 10250H5202 |
| | | | OPEN/CLOSE | 10250H5203 |
| | | | UP/DOWN | 10250H5204 |
| HIGH/LOW | | | 10250H5205 | |
| FAST/SLOW | 10250H5208 | | | |
| Three Button Station  | Three Element Enclosure Type | | | |
| |  | Flush/black (all) | FOR/REV/STOP | 10250H5300 |
| |  | | UP/DOWN/STOP | 10250H5301 |
| |  | | RAISE/LOWER/STOP | 10250H5302 |
| |  | | OPEN/CLOSE/STOP | 10250H5303 |
|  | FAST/SLOW/STOP | | 10250H5304 | |
| Three Button Station with Indicating Light  |  | 110/220V neon indicating light | START/STOP | |
| |  | Clear—flush/green; flush/red | | 10250H5310 |
| |  | Red—flush/green; flush/red | | 10250ED853 |
| |  | Amber—flush/green; flush/red | | 10250ED853-2 |

Notes

① Padlock attachment (10250H5110) must be purchased separately.





② Round button.

Type N Control Stations—Open Type Construction (No Cover)

| Contact Symbol | Button Type/Color | Legends | Catalog Number |
|---|---|-------------------|-------------------|
| Selector Switch | | | |
| One Element Enclosure Type | | | |
|  | Three-position selector switch/black knob | RUN/OFF/AUTO | 10250H2538 |
| Two Button Station | | | |
| Two Element Enclosure Type | | | |
|  | Flush/green | START/STOP | 10250H2747 |
|  | Flush/black (all) mech. interlocked | None ^① | 10250H2544 |

Special Purpose Control Stations

Special Purpose Control Stations—UL (NEMA) Type 3, 3R, 4, 4X, 13



| Contact Symbol | Feature | Legends | Catalog Number |
|---|---------------------|------------|-------------------|
| 10250H_ | | | |
| One Element Pushbutton Type | | | |
|  | Flush | START | 10250H2738 |
|  | | STOP | 10250H658 |
| | With lock hasp | STOP | 10250H665 |
| 10250H_ | | | |
| Two Element Pushbutton Type | | | |
|  | Flush | START/STOP | 10250H364 |
|  | With lock hasp | START/STOP | 10250H671 |
|  | Buttons interlocked | FAST/SLOW | 10250ED664 |
| | | FOR/REV | 10250H2740 |
| | | UP/DOWN | 10250H2741 |
| | | OPEN/CLOSE | 10250H2742 |

Note

^① No legend on buttons. Specify any standard legend.





10250H Series Heavy-Duty Control Stations

Type H Control Stations—UL (NEMA) Type 3, 3S, 4, 4X, 12, 13

| Element Type | Feature | Circuit | Assembled Legend Plate | Unassembled Alternate Legend Plate | Catalog Number | |
|--|----------------|---|------------------------|------------------------------------|--|-------------------|
| 10250H_ One Element | | | | | | |
|  | Pushbuttons | Without padlock hasp | 1NO-1NC | JOG | START STOP RUN | 10250H1881 |
| | | With padlock hasp | 1NC | STOP | — | 10250H4239 |
| Knob selector switch | Two-position | 1NO-1NC | OFF/ON | — | 10250H4526 | |
| | Three-position | 1NO-1NC | MAN/OFF/AUTO | — | 10250H4527 | |
| 10250H_ Two Element | | | | | | |
|  | Pushbuttons | Standard | 1NO-2NC | START/STOP | — | 10250H1884 |
| | | | 2NO-2NC | RAISE/LOWER | FORWARD REVERSE OPEN CLOSE | 10250H1885 |
| | | Standard and standard with padlock hasp | 1NO-2NC | START/STOP | — | 10250H4240 |
| 10250H_ Three Element | | | | | | |
|  | Pushbuttons | Standard | 2NO-3NC | FOR/REV/STOP | START OPEN | 10250H1890 |
| | | Two standard and standard with padlock hasp | | | JOG CLOSE RAISE FAST LOWER SLOW | 10250H4241 |
| Indicating light and pushbuttons | 120V | Light-red lens and two plain | 1NO-2NC | MOTOR RUNNING START/STOP | — | 10250H1913 |

10250T Series Heavy-Duty 30.5 mm Control Stations

Complete Assembled Stations—UL (NEMA) Type 4, 4X, 12, 13

| Element Type ^① | Features | Contact Block(s) | Legend | Surface Mounting Catalog Number | Flush Mounting ^② Catalog Number | |
|---|---|---|------------------|---------------------------------|--|-------------------|
| Break Glass Station | | | | | | |
|  | Break glass station ^③ | Gray enclosure | NC (logic level) | EMERG. OFF | 10250TGS | — |
| | | Red enclosure | | | 10250TGR | — |
| One Element | | | | | | |
|  | Pushbutton | Standard | NO-NC | START | 10250T3516 | 10250T3573 |
| | | | NC | STOP | 10250T3518 | 10250T3575 |
| | | | NO-NC | None | 10250T3540 | 10250T3597 |
| | | Mushroom head | NO-NC | START | 10250T3517 | 10250T3574 |
| | | NC | STOP | 10250T3519 | 10250T3576 | |
| | | With lock hasp ^④ | NC | STOP | 10250T3520 | 10250T3577 |
| | Selector switch | Two-position black knob | NO-NC | OFF/ON | 10250T3523 | 10250T3580 |
| | | Three-position black knob | 2NO | MAN/OFF/AUTO | 10250T3524 | 10250T3581 |
| Push-pull three-position | Momentary red button | 2NC | START/STOP | 10250T3545 | 10250T3602 | |
| Two Element | | | | | | |
|  | Pushbuttons | Standard | 1NO-2NC | START/STOP | 10250T3525 | 10250T3582 |
| | | | 2NO-2NC | RAISE/LOWER | 10250T3672 | 10250T3673 |
| | | | 2NO-2NC | None | 10250T3541 | 10250T3598 |
| | | With lock hasp ^④ | 1NO-2NC | START/STOP | 10250T3542 | 10250T3599 |
| | | Standard and mushroom head | 1NO-2NC | START/STOP | 10250T3526 | 10250T3583 |
| | | Standard with maintained contact ^⑤ | NO-NC Plus NC | START/STOP | 10250T3528 | 10250T3585 |
| Three Element | | | | | | |
|  | Pushbuttons | Standard | 2NO-3NC | FOR, REV, STOP | 10250T3532 | 10250T3589 |
| | | | 2NO-3NC | UP, DOWN, STOP | 10250T3615 | — |
| | | | 2NO-3NC | OPEN, CLOSE, STOP | 10250T3614 | — |
| | | | 2NO-3NC | None, None, STOP | 10250T3543 | 10250T3600 |
| | | Two standard and with lock hasp | 2NO-3NC | None, None, STOP | 10250T3544 | 10250T3601 |
| | Indicating light (transformer type) and pushbuttons | Red lens — 120V | 1NO-2NC | MOTOR RUN, START/STOP | 10250T3536 | 10250T3593 |
| | | Red lens — 240V | | | 10250T3537 | 10250T3594 |
| Red lens — 480V | | | | 10250T3538 | 10250T3595 | |
| | Red lens — 600V | | | 10250T3539 | 10250T3596 | |

Break Glass Operator ^⑥



Break Glass Kit

| Description | Catalog Number |
|---|-----------------|
| Operator with hammer and five glass discs | 10250TBG |
| Glass discs only (5) | 10250TGL |

Notes

- ① Stop buttons are red—all others are black.
- ② NEMA 4–13, if properly mounted on a flat surface. Consists of front plate, legend, operator and contact blocks.
- ③ Break glass stations will not function with Normally Open contact blocks.
- ④ Lock is 10250TA2.
- ⑤ Uses deep cover instead of shallow cover. Switch component is 10250TA67—mechanically interlocked operators.
- ⑥ Shown assembled to contact block (contact block supplied separately).

1 Custom Assembled Stations Specification Form

Ordering Instructions

Step 1

Copy this ordering guide from catalog.

Step 2

Specify 10250T or E34 pushbutton lines in the corresponding box on the following page.

| | |
|----------------------------------|--|
| 10250T | Pages V7-T1-213 to V7-T1-283 |
| E34 | Pages V7-T1-284 to V7-T1-325 |
| 10250T and E34 Class I Div. 2 | Pages V7-T1-351 to V7-T1-391 |

Step 3

Check back of panel dimensions—specify single or double depth enclosure in the corresponding box on the following page.

Step 4

Specify enclosure catalog number and price in the corresponding box on the following page. Enclosures can be found on **Pages V7-T1-110, V7-T1-263 and V7-T1-313**. For pricing, reference the most recent PAD or VISTA-line.

Step 5

Specify catalog numbers for desired operator, legend plate, light unit, accessory and contact block(s) for each location in the enclosure in the corresponding box on the following page. (See position locations on this page.)

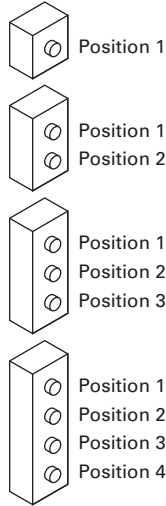

Position Locations

Step 6

For non-standard legends, specify legend desired, letter size and location on the layout sketches on the following page. For limitations see **Page V7-T1-262**. For pricing, use the blank legend catalog number and "STAMP" Suffix (Ex.: **10250TS36STAMP**) and reference the most recent PAD or VISTA-line.

Example: 10250TS36

Special Legend for Position # _____

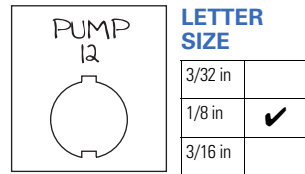

Step 7

Fax Sheet 2 of this form to Eaton's TRC, Technical Resource Center, at 828-651-0549 to the attention of—**Custom Stations Order** or email to TRC@eaton.com.

Within a few days you will receive a confirmation fax with the custom station part number and price.

Step 8

Place your order over the VISTA System.

For Selector and Roto-Push Operators

10250T or E34

For single contact blocks or 1NO-1NC contact blocks, the mounting position of contacts must be specified. For example: If a 1NO-1NC contact block is required, specify if NO is to be mounted in Top A position or Bottom B position.



To — **Eaton's TRC, Custom Station Order**
(828) 651-0549 FAX, or email to TRC@eaton.com

From — Customer Name _____
 Customer Contact _____
 Phone Number _____
 Fax Number _____
 Email Address _____

| FACTORY USE ONLY | |
|------------------|--|
| Part Number | |
| Product Code | |
| Suffix | |
| Date | |
| Engineer | |

Step 2)

10250T **STD** **Class I Division 2**
E34 **STD** **Class I Division 2**

Step 3)

| | |
|------------------------|---|
| Single Depth Enclosure | ✓ |
| Double Depth Enclosure | |

Step 4)

| Enclosure Catalog Number | Price |
|--------------------------|-------|
| | |

Step 5)

| Position | Operator | Price U.S. \$ | Light Unit | Price U.S. \$ | Contact Block | Price U.S. \$ | A/L | B/R | Contact Block | Price U.S. \$ | A/L | B/R | Total Price |
|----------|----------|---------------|------------|---------------|---------------|---------------|-----|-----|---------------|---------------|-----|-----|-------------|
| 1 | | | | | | | | | | | | | |
| 2 | | | | | | | | | | | | | |
| 3 | | | | | | | | | | | | | |
| 4 | | | | | | | | | | | | | |

| Position | Legend Plate | Price U.S. \$ | Lens or Caps | Price U.S. \$ | Accessory | Price U.S. \$ | Total Price |
|----------|--------------|---------------|--------------|---------------|-----------|---------------|-------------|
| 1 | | | | | | | |
| 2 | | | | | | | |
| 3 | | | | | | | |
| 4 | | | | | | | |

Total:

| |
|--|
| |
|--|

**10% Adder
for Assembled Stations**

Step 6) Non-standard Legends

Special Legend for Position # _____

Special Legend for Position # _____

Special Legend for Position # _____

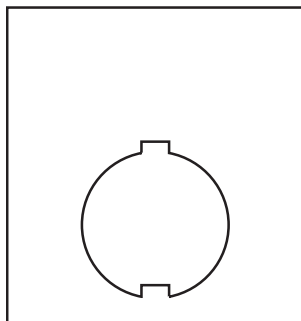

LETTER SIZE ✓

| | |
|--------------------|--|
| 3/32 inch (2.4 mm) | |
| 1/8 inch (3.2 mm) | |
| 3/16 inch (4.8 mm) | |

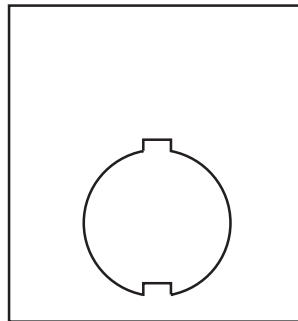

LETTER SIZE ✓

| | |
|--------------------|--|
| 3/32 inch (2.4 mm) | |
| 1/8 inch (3.2 mm) | |
| 3/16 inch (4.8 mm) | |

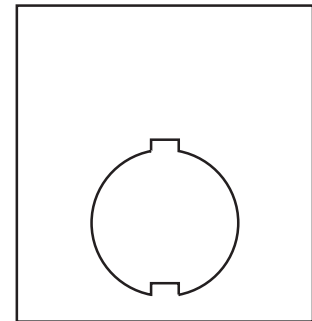

LETTER SIZE ✓

| | |
|--------------------|--|
| 3/32 inch (2.4 mm) | |
| 1/8 inch (3.2 mm) | |
| 3/16 inch (4.8 mm) | |

1

Renewal Parts

Type N Renewal Parts

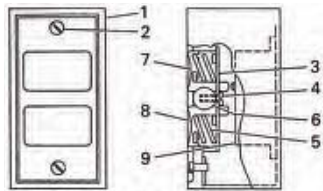

One and Two Element Station

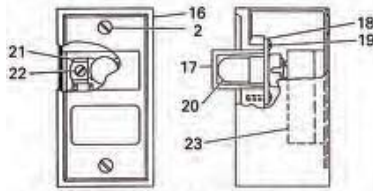

One Element Indicating Light

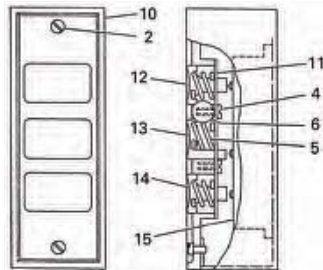

Three Element Station

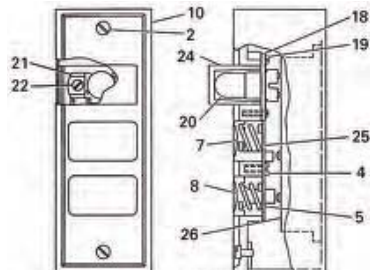

Two Element Station with Indicating Light



Open Type Two Element

Assembled Stations—Type N

| Item No. | Description | No. Req. | Part Number |
|------------------------------|---------------------------------------|----------|-------------|
| Type N—Square Buttons | | | |
| 1 | Cover | 1 | |
| | Two element | | 49-3524 |
| | One element—top button | | 49-3524-2 |
| | One element—bottom button | | 49-3524-3 |
| 2 | Cover screw | 2 | 11-2168 |
| 3 | Pushbutton support bracket | 1 | 79-6649 |
| 4 | Pushbutton support bracket screw | 1 | 11-2090 |
| 5 | Pushbutton spring | 2 | 69-2571 |
| 6 | Disc (when used—two element assembly) | 2 | 16-1960 |
| 7 | Pushbutton—top position | 1 | |
| | START/green | | 53-1169-3 |
| | RAISE/black | | 53-1169-66 |
| | FORWARD/black | | 53-1169-7 |
| | OPEN/black | | 53-1169-9 |
| | UP/blank | | 53-1169-11 |
| | Blank/green | | 53-1169 |
| 8 | Pushbutton—bottom position | 1 | |
| | STOP/red | | 53-1202-2 |
| | Extended STOP/red | | 53-1202-5 |
| | REVERSE/black | | 53-1169-8 |
| | CLOSE/black | | 53-1169-10 |
| | DOWN/black | | 53-1169-12 |
| | LOWER/black | | 53-1169-6 |
| | Blank/red | | 53-1202 |

| Item No. | Description | No. Req. | Part Number |
|---|----------------------------|----------|-------------|
| Type N—Square Buttons, continued | | | |
| 9 | Pushbutton element | 1 | |
| | 1NO-1NC | | 86-2588 |
| | 2NO | | 86-2588-2 |
| | 1NO | | 86-2588-3 |
| | 1NC | | 86-2588-4 |
| 10 | Cover | 1 | 49-3464 |
| 11 | Pushbutton support bracket | 1 | 79-6650 |
| 12 | Pushbutton—top position | 1 | |
| | FORWARD/black | | 53-1170-7 |
| | UP/black | | 53-1170-4 |
| | RAISE/black | | 53-1170-5 |
| | OPEN/black | | 53-1170-9 |
| | FAST/black | | 53-1170-6 |
| 13 | Pushbutton middle position | 1 | |
| | REVERSE/black | | 53-1169-15 |
| | DOWN/black | | 53-1169-18 |
| | LOWER/black | | 53-1169-16 |
| | CLOSE/black | | 53-1169-17 |
| | SLOW/black | | 53-1169-13 |
| 14 | Pushbutton—bottom position | 1 | |
| | STOP/red | | 53-1201-2 |
| 15 | Pushbutton element | 1 | |
| | 2NO-3NC | | 86-2593 |
| 16 | Cover | 1 | 49-3524-4 |

Assembled Stations—Type N, continued

| Item No. | Description | No. Req. | Part Number |
|---|----------------------------|----------|-------------|
| Type N—Square Buttons, continued | | | |
| 17 | Lens | 1 | |
| | Clear | | 28-494 |
| | Red | | 28-887-2 |
| | Amber | | 28-887-3 |
| 18 | Shield | 1 | 73-1337 |
| 19 | Shield screws | 4 | 11-2012 |
| 20 | Lamp (neon NE48) | 1 | 28-494 |
| 21 | Lamp receptacle | 1 | 28-902 |
| 22 | Lamp receptacle screw | 1 | 911-330F1 |
| 23 | Pilot light terminal base | 1 | 86-2586 |
| 24 | Lens | 1 | |
| | Clear | | 28-887 |
| | Red | | 28-887-2 |
| | Amber | | 28-887-3 |
| 25 | Pushbutton support bracket | 1 | 79-6650-2 |
| 26 | Pushbutton element | 1 | |
| | 1NO-1NC | | 86-2594 |

| Item No. | Description | No. Req. | Part Number |
|-----------------------------|--------------------------------------|----------|-------------|
| Type N—Round Buttons | | | |
| Similar to 27 | Pushbutton assembly and element for: | | |
| | 10250H289 | 1 | 10250H2538 |
| | 10250H364 | 1 | 86-353 |
| | 10250H685 | 1 | 86-353-8 |
| | 10250H665 | 1 | 86-353-8 |
| | 10250H671 | 1 | 86-353 |
| | 10250H2738 | 1 | 86-353-3 |
| | 10250H2740 | 1 | 86-356 |
| | 10250H2741 | 1 | 86-356 |
| | 10250H2742 | 1 | 86-356 |

Type H Renewal Parts

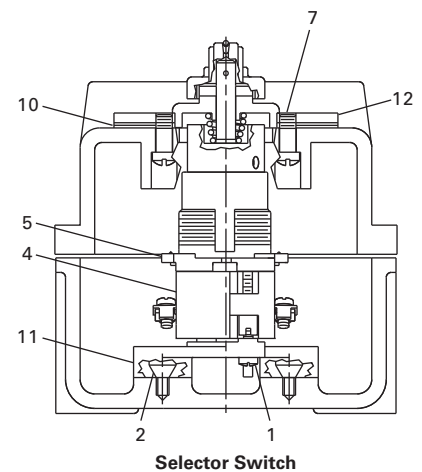
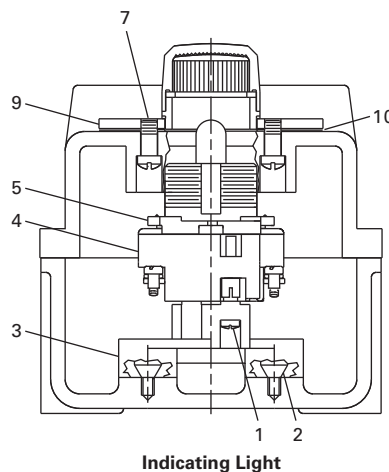
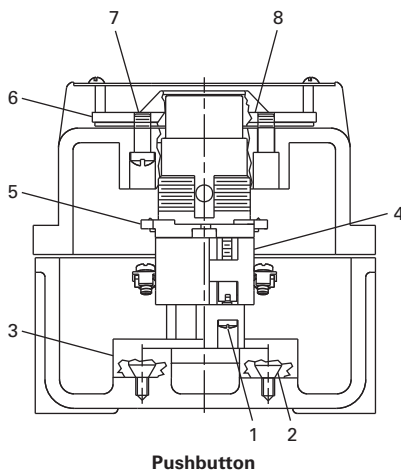

Assembled Stations—Type H

| Item No. | Description | No. Req. | Part Number |
|----------------------------------|-----------------|----------------------------------|-------------|
| Type H—Assembled Stations | | | |
| 1 | Screw | 2 | 11-4654 |
| 2 | Screw | 2 | 11-5719 |
| 3 | Base | 1 | 17-16560 |
| 4 | Contact blocks | See Page V7-T1-265 | |
| 5 | 10250T operator | See Pages V7-T1-219 to V7-T1-255 | |
| 6 | Mounting plate | 1 | 17-19524 |

| Item No. | Description | No. Req. | Part Number |
|----------------------------------|----------------|----------|-------------|
| Type H—Assembled Stations | | | |
| 7 | Screw | 4 | 11-953 |
| 8 | Diaphragm | 1 | 32-253-2 |
| 9 | Mounting plate | 1 | 17-19522 |
| 10 | Gasket | 1 | 32-254 |
| 11 | Base | 1 | 17-16561 |
| 12 | Mounting plate | 1 | 17-19523 |

Technical Data and Specifications

Ratings

Maximum Ampere Ratings for Type N Control Stations

| Description | Volts AC | | | | Volts DC | | |
|---------------------------------------|----------|-----|------|-----|----------|-----|-----|
| | 110 | 220 | 440 | 550 | 120 | 240 | 600 |
| Make and emergency interrupt capacity | 30 | 15 | 7.5 | 6 | 1.0 | 0.5 | 0.1 |
| Normal load break | 3 | 1.5 | 0.75 | 0.6 | 1.0 | 0.5 | 0.1 |
| Continuous current | 10 | 10 | 10 | 10 | 10 | 10 | 10 |

Maximum Ampere Ratings for Type H Control Stations

| Description | Volts AC 50/60 Hz | | | | Volts DC | |
|---------------------------------------|-------------------|------|------|------|----------|------|
| | 120 | 240 | 480 | 600 | 125 | 250 |
| Make and emergency interrupt capacity | 60 | 30 | 15 | 12 | 1.1 | 0.55 |
| Normal load break | 6 | 3 | 1.5 | 1.2 | 1.1 | 0.55 |
| Continuous amperes | 10 | 10 | 10 | 10 | 10 | 10 |
| Voltamperes — | | | | | | |
| Make and emergency interrupt capacity | 7200 | 7200 | 7200 | 7200 | 138 | 138 |
| Normal load break | 720 | 720 | 720 | 720 | 138 | 138 |

Dimensions

Approximate Dimensions in Inches (mm)

Type N Control Stations

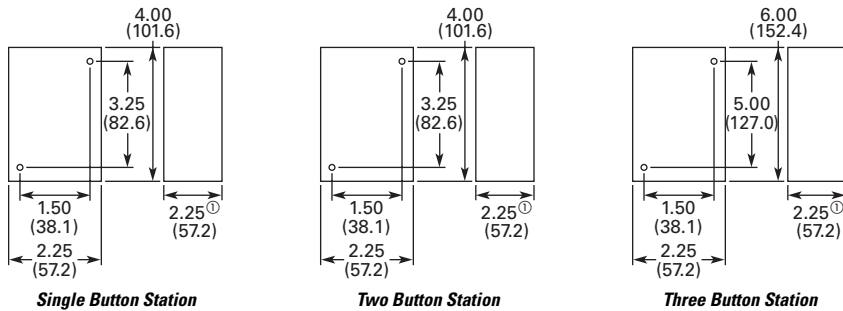

Special Purpose Control Stations

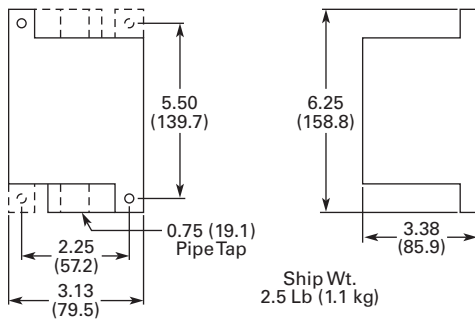

Note

⊙ 2.38 (60.5) for neon indicating light.

Approximate Dimensions in Inches (mm)

Type H Control Stations

NEMA Type 3, 3R, 3S, 4, 4X, 13

| No. of Elements | Dimensions | | |
|-----------------|--------------|---------------|--------------|
| | Wide | High | Deep |
| 1 and 2 | 4.50 (114.3) | 8.25 (209.6) | 4.50 (114.3) |
| 3 | 4.50 (114.3) | 10.75 (273.1) | 4.25 (108.0) |

10250T and E34

Approximate Enclosure Dimensions

| Number of Elements | Surface Mounting Dimensions in In (mm) | | | Mounting D | E | Conduit Entrance |
|------------------------|--|---------------|-------------|-------------|---------------|------------------|
| | Wide A | High B | Deep C | | | |
| Cast | | | | | | |
| 1 | 3.88 (98.6) | 4.00 (101.6) | 3.00 (76.3) | 2.69 (68.3) | 3.25 (82.6) | 3/4 |
| 2 | 3.88 (98.6) | 5.88 (149.4) | 3.00 (76.3) | 2.69 (68.3) | 5.13 (130.3) | 3/4 |
| 3 | 3.88 (98.6) | 7.75 (196.9) | 3.00 (76.3) | 2.69 (68.3) | 7.00 (177.8) | 1 |
| 4 | 33.88 (98.6) | 9.63 (244.6) | 3.00 (76.3) | 2.69 (68.3) | 8.88 (225.6) | 1 |
| Polyester | | | | | | |
| 1 | 3.81 (96.8) | 6.63 (168.4) | 3.38 (85.9) | 2.94 (74.7) | 4.88 (124.0) | ① |
| 2 | 3.81 (96.8) | 6.63 (168.4) | 3.38 (85.9) | 2.94 (74.7) | 4.88 (124.0) | ① |
| 3 | 3.81 (96.8) | 8.88 (225.6) | 3.38 (85.9) | 2.94 (74.7) | 7.13 (181.1) | ① |
| 4 | 3.81 (96.8) | 6.63 (168.4) | 3.38 (85.9) | 2.94 (74.7) | 4.88 (124.0) | ① |
| Stainless Steel | | | | | | |
| 1 | 3.00 (76.2) | 3.50 (88.9) | 3.00 (76.2) | 1.50 (38.1) | 4.25 (108.0) | ① |
| 2 | 3.50 (88.9) | 6.75 (171.5) | 3.00 (76.2) | 1.50 (38.1) | 7.50 (190.5) | ① |
| 3 | 3.50 (88.9) | 9.00 (228.6) | 3.00 (76.2) | 1.50 (38.1) | 9.00 (228.6) | ① |
| 4 | 3.50 (88.9) | 11.25 (285.8) | 3.00 (76.2) | 1.50 (38.1) | 12.00 (304.8) | ① |

Note

① No conduit entrance holes provided. Drill as required.

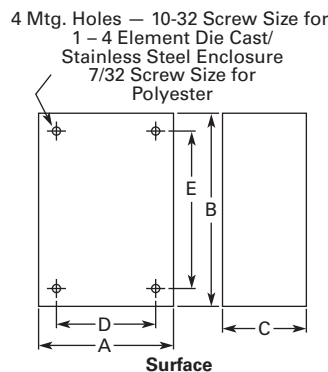

16.2 mm Pushbuttons—RMQ-16



Contents

| <i>Description</i> | <i>Page</i> |
|--|-----------------|
| 16.2 mm Pushbuttons—RMQ-16 | |
| Product Selection Guide | V7-T1-25 |
| Pushbuttons—Non-Illuminated and Illuminated | V7-T1-26 |
| Indicating Lights | V7-T1-28 |
| Emergency Stops | V7-T1-29 |
| Selector Switches—Non-Illuminated, Illuminated and Keyed | V7-T1-30 |
| Accessories | V7-T1-34 |
| Technical Data and Specifications | V7-T1-37 |
| Dimensions | V7-T1-39 |

Product Overview

Product Description

The RMQ-16 pushbutton line offers a wide array of functional and attractively designed illuminated and non-illuminated pushbuttons, selector switches, emergency stops and indicating lights. The illuminated line is offered with either incandescent or LED. RMQ-16 devices are designed with two front-of-panel operator sizes. The 18 x 18 mm or 25 x 25 mm square operators can help the user achieve over three times the information density compared with 22 mm ranges.

Features

- *Wide product breadth:* RMQ-16 offers illuminated and non-illuminated pushbuttons, keyed, non-keyed, and illuminated selector switches, emergency stops, and a large variety of accessories
- *Custom laser etching:* Hundreds of standard markings available in addition to infinite possible custom images with laser etching
- *High durability:* Pushbuttons and selector switches rated for 3 million mechanical operations
- *High information density:* Square operators (18 mm or 25 mm) allow for side-by-side mounting and achieve over three times the information density of typical 22 mm installations

Standards and Certifications

- UL Listed
- CSA Certified
- IEC/EN 60947-5 VDE-0660
- IP65



- Laser etched operators
- Heavy-duty construction with IP65 on front of panel operators
- LED or incandescent illumination available
- Front-of-panel operators available in either 18 x 18 mm or 25 x 25 mm sizes
- Safety rated emergency stops (IEC 60947-5, positively driven contacts)
- Mounting diameter 16.2 mm to EN 50007

Product Selection Guide

Pushbuttons



| | | |
|--------------------------|----------------------|----------------------|
| Description | Non-Illuminated | Illuminated |
| Product Selection | Page V7-T1-26 | Page V7-T1-27 |

Indicating Lights



| | | |
|--------------------------|----------------------|----------------------|
| Description | Flush | Extended |
| Product Selection | Page V7-T1-28 | Page V7-T1-28 |

Emergency Stops



| | | |
|--------------------------|----------------------|----------------------|
| Description | Non-Illuminated | Illuminated |
| Product Selection | Page V7-T1-29 | Page V7-T1-29 |

Selector Switches



| | | | |
|--------------------------|----------------------|----------------------|----------------------|
| Description | Non-Illuminated | Illuminated | Keyed |
| Product Selection | Page V7-T1-30 | Page V7-T1-31 | Page V7-T1-32 |

1 Pushbuttons—Non-Illuminated and Illuminated

Catalog Number Selection

Catalog Number Selection is for illustrative purposes only and not to be used to create new catalog numbers.

Pushbuttons—Non-Illuminated and Illuminated

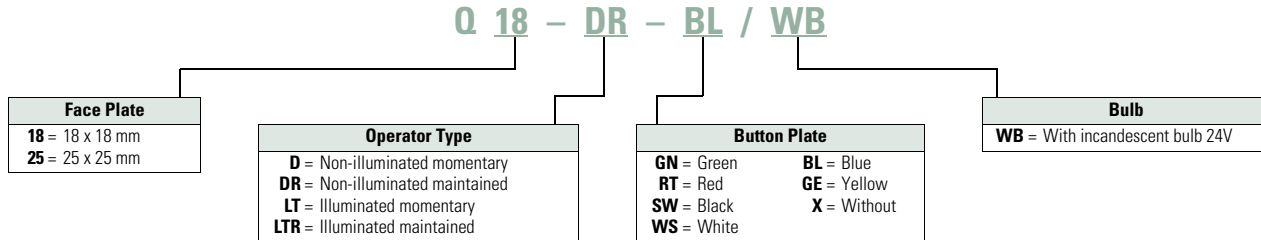

Product Selection

Non-Illuminated Pushbuttons

- Momentary or maintained
- Customizable laser etched pushbutton operators
- 18 mm or 25 mm square operator
- 3 million mechanical operations
- IEC/EN 60947-5
- IP65

Q18-D-GN



Non-Illuminated Pushbuttons

| Type | Button Color | Catalog Number | |
|------------|--------------|------------------|------------------|
| | | 18 x 18 mm | 25 x 25 mm |
| Momentary | Green | Q18D-GN | Q25D-GN |
| | Red | Q18D-RT | Q25D-RT |
| | Black | Q18D-SW | Q25D-SW |
| | White | Q18D-WS | Q25D-WS |
| | Blue | Q18D-BL | Q25D-BL |
| | Yellow | Q18D-GE | Q25D-GE |
| | Without | Q18D-X ① | Q25D-X ① |
| Maintained | Green | Q18DR-GN | Q25DR-GN |
| | Red | Q18DR-RT | Q25DR-RT |
| | Black | Q18DR-SW | Q25DR-SW |
| | White | Q18DR-WS | Q25DR-WS |
| | Blue | Q18DR-BL | Q25DR-BL |
| | Yellow | Q18DR-GE | Q25DR-GE |
| | Without | Q18DR-X ① | Q25DR-X ① |

Note

① To order separate button plates, see **Page V7-T1-36**.

Illuminated Pushbuttons

- Momentary or maintained
- LED or incandescent
- 18 mm or 25 mm square operator
- 3 million mechanical operations
- IEC/EN 60947-5
- IP65

Q18-LT-GE



Illuminated Pushbuttons Without Bulb ^①

| Type | Button Color | Catalog Number ^② | |
|------------|--------------|-----------------------------|------------------|
| | | 18 x 18 mm | 25 x 25 mm |
| Momentary | Green | Q18LT-GN | Q25LT-GN |
| | Red | Q18LT-RT | Q25LT-RT |
| | Black | Q18LT-SW | Q25LT-SW |
| | White | Q18LT-WS | Q25LT-WS |
| | Blue | Q18LT-BL | Q25LT-BL |
| | Yellow | Q18LT-GE | Q25LT-GE |
| Maintained | Green | Q18LTR-GN | Q25LTR-GN |
| | Red | Q18LTR-RT | Q25LTR-RT |
| | Black | Q18LTR-SW | Q25LTR-SW |
| | White | Q18LTR-WS | Q25LTR-WS |
| | Blue | Q18LTR-BL | Q25LTR-BL |
| | Yellow | Q18LTR-GE | Q25LTR-GE |

Notes

^① To order with incandescent 24V bulb, insert a **/WB** at the end of the catalog number. Example, Q18LT-GN/**WB**.

^② For a complete selection of incandescent 24V bulbs and LEDs, see **Page V7-T1-34**.

1

Indicating Lights

Catalog Number Selection

Catalog Number Selection is for illustrative purposes only and not to be used to create new catalog numbers.

Indicating Lights—Flush and Extended

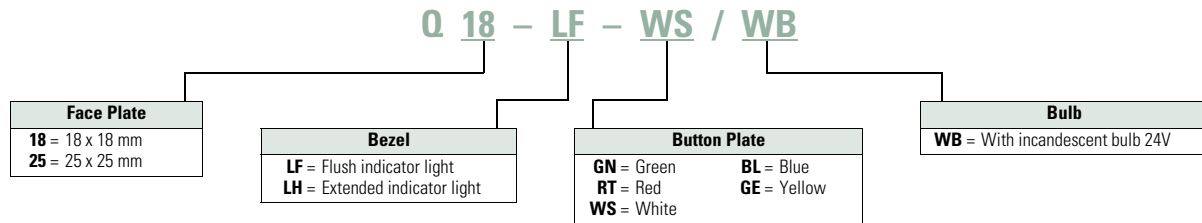



Product Selection

Indicating Lights

- LED or incandescent
- Flush and extended lenses
- 18 mm or 25 mm square operator
- 3 million mechanical operations
- IEC/EN 60947-5
- IP65

Indicating Lights Without Bulb ^①

| | Type | Button Color | Catalog Number ^② | |
|---|----------|--------------|-----------------------------|-----------------|
| | | | 18 x 18 mm | 25 x 25 mm |
| Q18-LF-GE  | Flush | Green | Q18LF-GN | Q25LF-GN |
| | | Red | Q18LF-RT | Q25LF-RT |
| | | White | Q18LF-WS | Q25LF-WS |
| | | Blue | Q18LF-BL | Q25LF-BL |
| | | Yellow | Q18LF-GE | Q25LF-GE |
| Q18-LH-BL  | Extended | Green | Q18LH-GN | Q25LH-GN |
| | | Red | Q18LH-RT | Q25LH-RT |
| | | White | Q18LH-WS | Q25LH-WS |
| | | Blue | Q18LH-BL | Q25LH-BL |
| | | Yellow | Q18LH-GE | Q25LH-GE |

Notes

- ^① To order with incandescent 24V bulb, insert a /WB at the end of the catalog number. Example, Q18-LF-GN/WB.
- ^② For a complete selection of incandescent 24V bulbs and LEDs, see **Page V7-T1-34**.

Emergency Stops

Catalog Number Selection

Catalog Number Selection is for illustrative purposes only and not to be used to create new catalog numbers.

Emergency Stops—Non-Illuminated and Illuminated

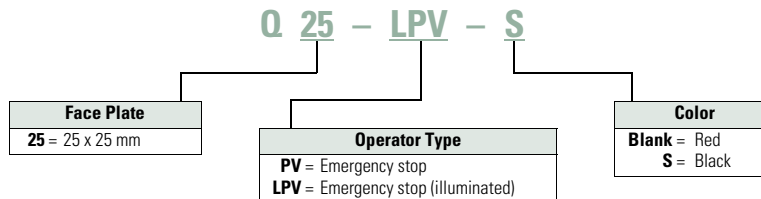

Product Selection

Emergency Stops

- Push/pull operation
- Illuminated or non-illuminated
- Emergency stop (red) or Machine stop (black) available
- Suitable for use in safety applications
- IEC/EN 60947-5
- IP65

Q25PV



Emergency Stops—Non-Illuminated

| Button Color | Catalog Number |
|--------------|----------------|
| Red | Q25PV |
| Black | Q25PV-S |

Q25LPV



Emergency Stops—Illuminated ①

| Button Color | Catalog Number |
|--------------|-----------------|
| Red | Q25LPV |
| Black | Q25LPV-S |

Note

① Includes built-in multiple LED 24 Vdc.

1

Selector Switches—Non-Illuminated, Illuminated and Keyed

Catalog Number Selection

Catalog Number Selection is for illustrative purposes only and not to be used to create new catalog numbers.

Selector Switches—Non-Illuminated

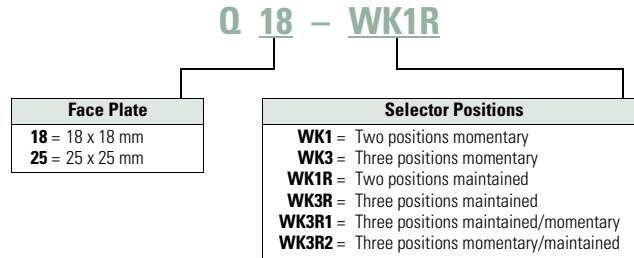

Product Selection

Non-Illuminated Selector Switches

- Momentary or maintained
- 18 mm or 25 mm square operator
- VS Anti-rotation feature
- 3 million mechanical operations
- IP65

Q18WK1



Selector Switches—Non-Illuminated

| Function | Position | Switch Position | Catalog Number | |
|----------------------|----------|-----------------|-----------------|-----------------|
| | | | 18 x 18 mm | 25 x 25 mm |
| Momentary | 2 | | Q18WK1 | Q25WK1 |
| Maintained | | | Q18WK1R | Q25WK1R |
| Momentary | 3 | | Q18WK3 | Q25WK3 |
| Maintained | | | Q18WK3R | Q25WK3R |
| Maintained/momentary | | | Q18WK3R1 | Q25WK3R1 |
| Momentary/maintained | | | Q18WK3R2 | Q25WK3R2 |

Catalog Number Selection

Catalog Number Selection is for illustrative purposes only and not to be used to create new catalog numbers.

Selector Switches—Illuminated

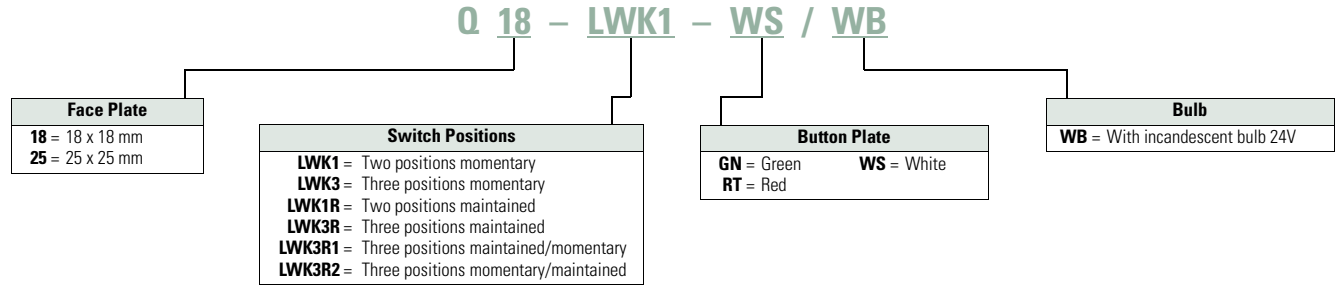

Product Selection

Illuminated Selector Switches

- LED or incandescent
- Momentary or maintained
- 18 mm or 25 mm square operator
- VS Anti-rotation feature
- 3 million mechanical operations
- IP65

Q18LWK1-GN



Selector Switches—Illuminated without Bulb ①

| Function | Position | Button Color | Switch Position | Catalog Number ② | |
|--------------------------|----------|--------------|-----------------|---------------------|---------------------|
| | | | | 18 x 18 mm | 25 x 25 mm |
| Momentary | 2 | Green | | Q18LWK1-GN | Q25LWK1-GN |
| | | Red | | Q18LWK1-RT | Q25LWK1-RT |
| | | White | | Q18LWK1-WS | Q25LWK1-WS |
| Maintained | | Green | | Q18LWK1R-GN | Q25LWK1R-GN |
| | | Red | | Q18LWK1R-RT | Q25LWK1R-RT |
| | | White | | Q18LWK1R-WS | Q25LWK1R-WS |
| Momentary | 3 | Green | | Q18LWK3-GN | Q25LWK3-GN |
| | | Red | | Q18LWK3-RT | Q25LWK3-RT |
| | | White | | Q18LWK3-WS | Q25LWK3-WS |
| Maintained | | Green | | Q18LWK3R-GN | Q25LWK3R-GN |
| | | Red | | Q18LWK3R-RT | Q25LWK3R-RT |
| | | White | | Q18LWK3R-WS | Q25LWK3R-WS |
| Maintained/ momentary | | Green | | Q18LWK3R1-GN | Q25LWK3R1-GN |
| | | Red | | Q18LWK3R1-RT | Q25LWK3R1-RT |
| | | White | | Q18LWK3R1-WS | Q25LWK3R1-WS |
| Momentary/ maintained | | Green | | Q18LWK3R2-GN | Q25LWK3R2-GN |
| | | Red | | Q18LWK3R2-RT | Q25LWK3R2-RT |
| | | White | | Q18LWK3R2-WS | Q25LWK3R2-WS |

Notes

- ① To order with incandescent 24V bulb, insert a /WB at the end of the catalog number. Example, Q18LWK1-GN/WB.
- ② For a complete selection of incandescent 24V bulbs and LEDs, see Page V7-T1-34.

1

Catalog Number Selection

Catalog Number Selection is for illustrative purposes only and not to be used to create new catalog numbers.

Keyed Selector Switches—Two- and Three-Position

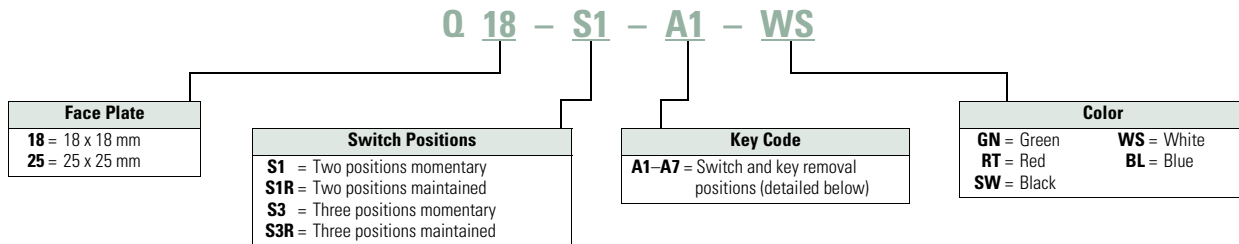

Product Selection

Keyed Selector Switches

- 5 color options
- Momentary or maintained
- 18 mm or 25 mm square operator
- VS Anti-rotation feature
- 3 million mechanical operations
- IP65

Q18S1



Keyed Selector Switches—Two-Position

| Function | Button Color | Switch Position | Key Removal Position ① | Catalog Number | |
|------------|--------------|-----------------|------------------------|------------------|------------------|
| | | | | 18 x 18 mm | 25 x 25 mm |
| Momentary | Black | ↓ | 0 | Q18S1 | Q25S1 |
| Maintained | Black | ↙ | 0 | Q18S1R | Q25S1R |
| Maintained | Black | ↘ | 0 | Q18S1R-A1 | Q25S1R-A1 |

Keyed Selector Switches—Three-Position

| Function | Button Color | Switch Position | Key Removal Position ① | Catalog Number | |
|----------------------|--------------|-----------------|------------------------|------------------|------------------|
| | | | | 18 x 18 mm | 25 x 25 mm |
| Momentary | Black | ↕ | 0 | Q18S3 | Q25S3 |
| Maintained | | ↕ | 0, II | Q18S3R | Q25S3R |
| Maintained | | ↕ | 0 | Q18S3R-A1 | Q25S3R-A1 |
| | | ↕ | I, 0 | Q18S3R-A2 | Q25S3R-A2 |
| | | ↕ | 0, II | Q18S3R-A3 | Q25S3R-A3 |
| Maintained/momentary | | ↕ | I, 0 | Q18S3R-A4 | Q25S3R-A4 |
| | | ↕ | 0 | Q18S3R-A5 | Q25S3R-A5 |
| Momentary/maintained | | ↕ | 0, II | Q18S3R-A6 | Q25S3R-A6 |
| | | ↕ | 0 | Q18S3R-A7 | Q25S3R-A7 |

Note

- ① I = Key is removed at the left.
- 0 = Key is removed at the center.
- II = Key is removed at the right.

Q18S1-BL

Keyed Selector Switches, Multicolor—Two-Position



| Function | Button Color | Switch Position | Key Removal Position ① | Catalog Number | |
|------------|--------------|-----------------|------------------------|------------------|------------------|
| | | | | 18 x 18 mm | 25 x 25 mm |
| Momentary | Green | | 0 | Q18S1-GN | Q25S1-GN |
| | Red | | | Q18S1-RT | Q25S1-RT |
| | White | | | Q18S1-WS | Q25S1-WS |
| | Blue | | | Q18S1-BL | Q25S1-BL |
| Maintained | Green | | 0 | Q18S1R-GN | Q25S1R-GN |
| | Red | | | Q18S1R-RT | Q25S1R-RT |
| | White | | | Q18S1R-WS | Q25S1R-WS |
| | Blue | | | Q18S1R-BL | Q25S1R-BL |

Q18S3-RT

Keyed Selector Switches, Multicolor—Three-Position



| Function | Button Color | Switch Position | Key Removal Position ① | Catalog Number | |
|------------|--------------|-----------------|------------------------|------------------|------------------|
| | | | | 18 x 18 mm | 25 x 25 mm |
| Momentary | Green | | 0 | Q18S3-GN | Q25S3-GN |
| | Red | | | Q18S3-RT | Q25S3-RT |
| | White | | | Q18S3-WS | Q25S3-WS |
| | Blue | | | Q18S3-BL | Q25S3-BL |
| Maintained | Green | | 0, II | Q18S3R-GN | Q25S3R-GN |
| | Red | | | Q18S3R-RT | Q25S3R-RT |
| | White | | | Q18S3R-WS | Q25S3R-WS |
| | Blue | | | Q18S3R-BL | Q25S3R-BL |

Note

- ① I = Key is removed at the left.
- 0 = Key is removed at the center.
- II = Key is removed at the right.

Accessories

| E10 | | Contact Elements |
|---------------------|----------------|------------------|
| Feature | Catalog Number | |
| Normally open (N/O) | E10 | |



| | | |
|-----------------------|-----|--|
| Normally closed (N/C) | E01 | |
|-----------------------|-----|--|



| SRA10 | | Screw Adapter |
|-----------------------|----------------|---------------|
| Feature | Catalog Number | |
| Normally open (N/O) | SRA10 | |
| Normally closed (N/C) | SRA01 | |
| Lamp sockets | SRAL | |



| WBGL6 | | Incandescent 24V Bulbs | |
|---------|---------|------------------------|----------------|
| Voltage | Current | Color | Catalog Number |
| 6V | 1W | White | WBGL6 |
| 12V | | | WBGL12 |
| 24–28V | | | WBGL24 |



| WBLED-GN6 | | LEDs (AC/DC) | |
|--------------------------|-----------|--------------|----------------|
| Voltage | Current | Color | Catalog Number |
| Multiple Chip LED | | | |
| 6V | 45 mA | Green | WBLED-GN6 |
| 12V | 24 mA | | WBLED-GN12 |
| 6V | 45 mA | Red | WBLED-RT6 |
| 12V | 24 mA | | WBLED-RT12 |
| 6V | 45 mA | Yellow | WBLED-GE6 |
| 12V | 24 mA | | WBLED-GE12 |
| Single Chip LED ① | | | |
| 18–30V | 7–12.5 mA | Green | LEDWB-G |
| | | Red | LEDWB-R |
| | | White | LEDWB-W |
| | | Blue | LEDWB-B |
| | | Yellow | LEDWB-Y |



| ISH2,8 | | Insulated Ferrule |
|-------------------|----------------|-------------------|
| Description | Catalog Number | |
| Insulated ferrule | ISH2,8 | |



| R16-MS | | Combination Box Spanner |
|--------------------|----------------|-------------------------|
| Description | Catalog Number | |
| Mounting ring tool | R16-MS | |



| VS | | Anti-Rotation Tab |
|-------------|----------------|-------------------|
| Description | Catalog Number | |
| Guard ring | VS | |



| E8-SW | | Housing |
|-------------------------|-------|----------------|
| Description | Color | Catalog Number |
| Surface mount enclosure | White | I8 |
| Flush mount panel | White | E8 |
| | Black | E8-SW |



| Q18BS | | Blanking Plug |
|------------|----------------|---------------|
| Size | Catalog Number | |
| 18 x 18 mm | Q18BS | |
| 25 x 25 mm | Q25BS | |



| Q25AGR | | Cover Plate |
|------------|-------|----------------|
| Size | Color | Catalog Number |
| 25 x 38 mm | Black | Q25AS |
| | Gray | Q25AGR |



Note

① Positive pole to X1. Integral suppressor circuit up to 1000V.

Q2SQ25

Insert Plate



| Size | | Catalog Number |
|------------|-------|----------------|
| 10 x 22 mm | BLANK | Q2SQ25 |

Q25TS-X

Legend Plate



| Size | Color | Catalog Number |
|------------|-------|-----------------|
| 25 x 38 mm | Black | Q25TS-X |
| | Gray | Q25TGR-X |

Q25TS_

Legend Plate—Complete



| Size | Etching | Catalog Number |
|---------|-------------|------------------|
| 25 x 38 | START | Q25TS-111 |
| | STOP | Q25TS-110 |
| | FAULT | Q25TS-250 |
| | HAND 0 AUTO | Q25TS-197 |
| | MAN 0 AUTO | Q25TS-397 |
| | 0 | Q25TS-10 |
| | I | Q25TS-11 |
| | 0 I | Q25TS-90 |
| | I 0 II | Q25TS-93 |

SQT11

Emergency Stop Labels



| Type | Feature | Catalog Number |
|--------|-------------|----------------|
| Square | 4 Languages | SQT11 |
| | Blank | SQT-GE |

SRT11



| | | |
|--------|-------------|---------------|
| Circle | 4 Languages | SRT11 |
| | Blank | SRT-GE |

Extra Keys

ES16



Codes for Extra Keys

| Color | Catalog Number |
|-------|----------------|
| Green | ES16-GN |
| Red | ES16-RT |
| Black | ES16 |
| White | ES16-WS |
| Blue | ES16-BL |

Button Plates



Button Plates

| Type | Color | Etching | Catalog Number |
|------------|--------|---------|--------------------|
| 18 x 18 mm | Black | — | 01TQ18 |
| | | CUSTOM | 01TQ18-ETCH |
| | | | 21TQ18 |
| | White | | 19TQ18 |
| | | — | 02TQ18 |
| | | CUSTOM | 02TQ18-ETCH |
| | Green | | 20TQ18 |
| | | — | 03TQ18 |
| | | CUSTOM | 03TQ18-ETCH |
| | Red | | 11TQ18 |
| | | — | 04TQ18 |
| | | CUSTOM | 04TQ18-ETCH |
| | Yellow | | 10TQ18 |
| | | — | 05TQ18 |
| | | CUSTOM | 05TQ18-ETCH |
| | Blue | — | 06TQ18 |
| | | CUSTOM | 06TQ18-ETCH |

| Type | Color | Etching | Catalog Number |
|------------|--------|--------------------|--------------------|
| 25 x 25 mm | Black | — | 01TQ25 |
| | | CUSTOM | 01TQ25-ETCH |
| | | | 21TQ25 |
| | White | | 19TQ25 |
| | | "STOP" | 112TQ25 |
| | | "ON" | 221TQ25 |
| | White | — | 02TQ25 |
| | | CUSTOM | 02TQ25-ETCH |
| | | | 20TQ25 |
| | Green | — | 03TQ25 |
| | | CUSTOM | 03TQ25-ETCH |
| | | | 111TQ25 |
| | Red | "START" | 111TQ25 |
| | | | 11TQ25 |
| | | — | 04TQ25 |
| | Red | CUSTOM | 04TQ25-ETCH |
| | | "STOP" | 110TQ25 |
| | | | 10TQ25 |
| Yellow | "OFF" | 217TQ25 | |
| | — | 05TQ25 | |
| | CUSTOM | 05TQ25-ETCH | |
| Blue | — | 06TQ25 | |
| | CUSTOM | 06TQ25-ETCH | |

Instructions for Ordering Laser Inscriptions

1. Identify part number to be inscribed.
2. Pick symbol from library and identify suffix code associated with the symbol.
3. Order part number already listed in the catalog with -ETCH suffix.
4. When placing an order by fax or Vistaline on the web, reference order item number and indicate appropriate symbol code or desired text.

Example

To order a 25 mm green flush button plate with the inscription AUTO HAND:

Order Catalog Number **03TQ25-ETCH**.

AUTO HAND inscription is found on **Page V7-T1-127** in the M22 Symbols Library, suffix code is **X91**. In the order notes, reference item number and suffix **X91**.

Note: For a complete list of available symbols, see **Pages V7-T1-124 to V7-T1-130**, M22 Symbols Library.

Technical Data and Specifications

RMQ-16

| Description | Unit | Specification Contact Elements | Illuminated Pushbutton Operators (Maintained) | Illuminated Selector Switches | Indicating Lights |
|---|-------------------|--|--|--------------------------------------|-----------------------------------|
| General Technical Data | | | | | |
| Standards | | | | UL, CSA, IEC/EN 60 947, VDE 0660, CE | |
| Lifespan, mechanical (operations) | x 10 ⁵ | 100 | 30 (3) | 3 | — |
| Maximum operating frequency | Ops/h | 3600 | 3600 (1800) | 1800 | — |
| Operating force | N | 3 | 4 | — | — |
| Operating torque | Nm | | — | ≤ 0.2 | — |
| Degree of protection to IEC/EN 60 529 | | IP20 with ISH2,8 | IP65 | IP65 | IP65 |
| Climatic proofing | | | Damp heat, constant, to IEC 60 068-2-3/Damp heat, cyclical, to IEC 60 068-2-30 | | |
| Ambient temperature | | | | | |
| Open | °C | –25 to 60 | –25 to 60 | –25 to 60 | –25 to 60 |
| Enclosed | °C | –25 to 40 | –25 to 40 | –25 to 40 | –25 to 40 |
| Mounting position | | As required | As required | As required | As required |
| Mechanical shock resistance to IEC 60 068-2-27 (half-sinusoidal shock, duration 11 ms) | g | 40 | 40 | 40 | 40 |
| Terminal capacity (min./max.) | mm ² | 0.5/1.0 | 0.5/1.0 | 0.5/1.0 | 0.5/1.0 |
| Blade terminal | | | 2.8 mm x 0.8 mm to DIN 46 244 | | |
| Ferrule | | | 2.8 mm x 0.8 mm to DIN 46 247 and IEC 60 760 | | |
| Dimensions | | See Page V7-T1-39 | See Page V7-T1-39 | See Page V7-T1-39 | See Page V7-T1-39 |
| Contacts | | | | | |
| Rated impulse withstand voltage U_{imp} | V | 4000 | 800 | 800 | 800 |
| Rated insulation voltage U_i | V | 250 | 250 | 250 | 250 |
| Overvoltage category/pollution degree | | III/3 | III/3 | III/3 | III/3 |
| Rated operational voltage U_e (max.) | V | 250 | 24 | 24 | 24 |
| Rated operational current I_e (max.) | A | 4 | — | — | — |
| Control circuit reliability at | | | | | |
| 24 Vdc/5 mA (Fault probability Hr) | | | <10 ⁻⁷ , <1 fault in 10 ⁷ operations | | |
| 5 Vdc/1 mA (Fault probability Hr) | | | <5 x 10 ⁻⁶ , < fault in 5 x 10 ⁶ operations | | |
| Use of insulated ferrule ISH 2.8 | | | | | |
| From U_e | | >24 Vac/dc recommended | >24 Vac/dc recommended | >24 Vac/dc recommended | >24 Vac/dc recommended |
| From U_e | | | >50 Vac or 120 Vdc is mandatory, even on unused blade terminals | | |
| Maximum short-circuit protective device | | | | | |
| Fuseless | Type | FAZ-B6 | — | — | — |
| Fuse | A gG/gL | 10 | — | — | — |
| Switching Capacity | | | | | |
| Rated operational current I_e | | | | | |
| AC-15 | | | | | |
| 24V | A | 4 | — | — | — |
| 48V | A | 4 | — | — | — |
| 110V | A | 4 | — | — | — |
| 230V | A | 4 | — | — | — |
| DC-13 | | | | | |
| 24V | A | 3 | — | — | — |
| 42V | A | 1.0 | — | — | — |
| 60V | A | 0.8 | — | — | — |
| 110V | A | 0.5 | — | — | — |
| 220V | A | 0.2 | — | — | — |
| UL/CSA Data | | | | | |
| | | UL listed File No. E 29 184, Guide No. NKCR/CSA certified File No. 46 552 Class No. 321103 | | | |
| Blade terminal | | 0.110 x 0.032 in | 0.110 x 0.032 in | 0.110 x 0.032 in | 0.110 x 0.032 in |
| Fast-on connector | | 0.110 x 0.032 in AMP #60 197-1, 62 050-1 or equivalent | | | |
| Rated voltage maximum AC | Vac | 300 | 24 | 24 | 24 |
| Contact rating code AC | E10/E01 | C300/Q300 | — | — | — |
| Thermal continuous test current | A | 2.5 | — | — | — |
| Rated voltage maximum DC | Vdc | 300 | — | — | — |
| Contact rating code DC | E10/E01 | C300/R300 | — | — | — |
| Thermal continuous test current | A | 2.5 | — | — | — |

1.3

Pushbuttons and Indicating Lights

16.2 mm Pushbuttons—RMQ-16

1

RMQ-16, continued

| Description | Unit | Specification | | | Emergency Stop Operators | Emergency Stop Operators (Illuminated) ① |
|--|-------------------|-----------------------------------|-------------------|------------------------|---|--|
| | | Pushbutton Operators (Maintained) | Selector Switches | Key-Released Operators | | |
| General Technical Data | | | | | | |
| Standards | | | | | UL, CSA, IEC/EN 60 947, VDE 0660, CE | |
| Lifespan, mechanical (operations) | x 10 ⁵ | 30 (3) | 3 | 3 | 0.5 | 0.5 |
| Maximum operating frequency | Ops/h | 3600 (1800) | 1800 | 1800 | 600 | 600 |
| Operating force | N | 4 | — | — | 25 | 25 |
| Operating torque | Nm | — | ≤ 0.2 | ≤ 0.4 | — | — |
| Degree of protection to IEC/EN 60 529 | | IP65 | IP65 | IP65 | IP65 | IP65 |
| Climatic proofing | | | | | Damp heat, constant, to IEC 60 068-2-3 Damp heat, cyclical, to IEC 60 068-2-30 | |
| Ambient temperature | | | | | | |
| Open | °C | –25 to 60 | –25 to 60 | –25 to 60 | –25 to 60 | –25 to 60 |
| Enclosed | °C | –25 to 40 | –25 to 40 | –25 to 40 | –25 to 40 | –25 to 40 |
| Mounting position | | As required | As required | As required | As required | As required |
| Mechanical shock resistance to IEC 60 068-2-27 (half-sinusoidal shock, duration 11 ms) | g | 40 | 40 | 40 | 40 | 40 |
| Terminal capacity (min./max.) | mm ² | — | — | — | — | 0.5/1.0 |
| Blade terminal | | — | — | — | — | 2.8 x 0.8 mm |
| Ferrule | | — | — | — | — | 2.8 x 0.8 mm |
| Dimensions | | See Page V7-T1-39 | See Page V7-T1-39 | See Page V7-T1-39 | See Page V7-T1-39 | See Page V7-T1-39 |

Lifespan, Electrical AC-15 to IEC/EN 60 947-5-1 at 230V

I_e = Rated operational current

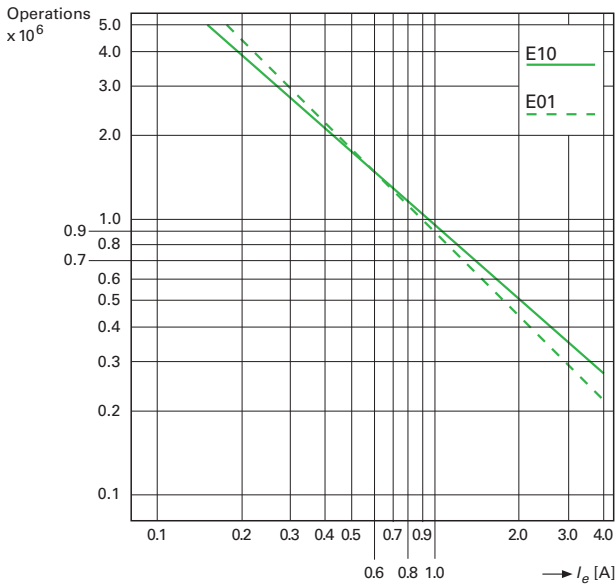

Note

① See illuminated selector switches on Page V7-T1-31 for contact values.

Dimensions

Approximate Dimensions in mm [in]

Actuating and Indicator Elements

Square Style

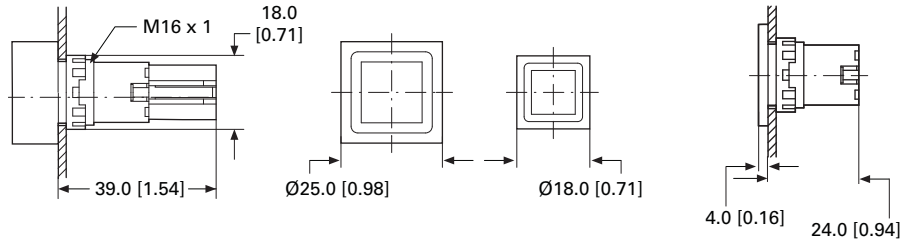

Q...D-_, Q...DR-_ Q...S_

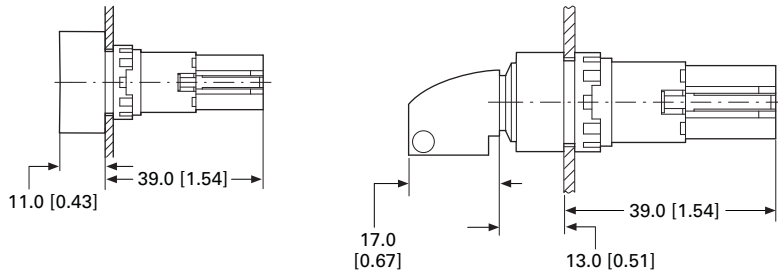

Q...WK_

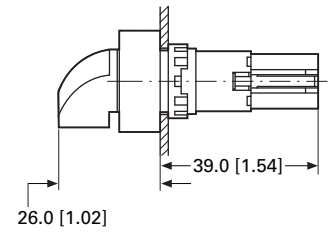

Q...LT-_, Q...LTR-_, Q...LF-_ Q...LH-_ Q...LWK_

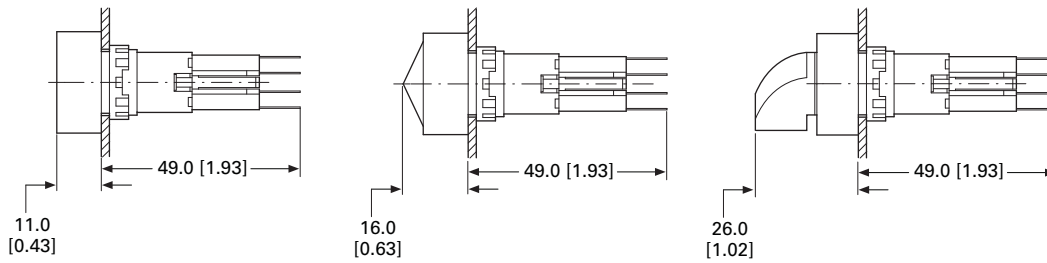

Q25PV_ Q25LPV_

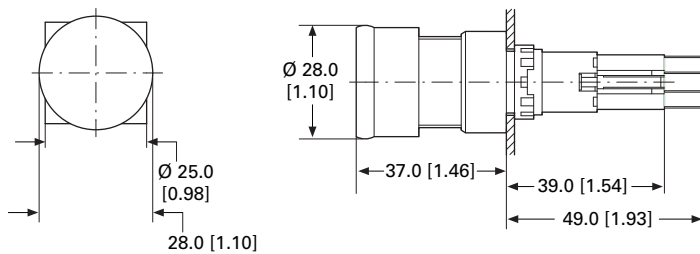

1.3

Pushbuttons and Indicating Lights

16.2 mm Pushbuttons—RMQ-16

1

Approximate Dimensions in mm [in]

Front Fixing

Q18, Q25, E89, SRA, VS, M16

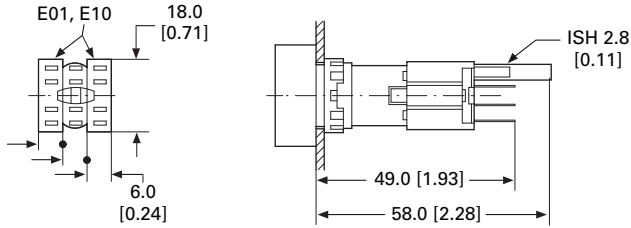

Drilling Dimensions

Drilling

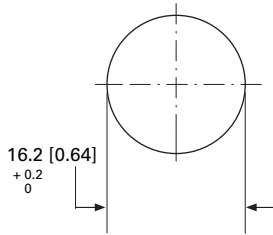

Grid Dimension to IEC/EN 60947

Q25

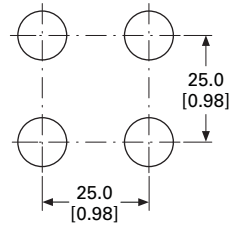

Minimum Grid Spacing Dimension

Q18

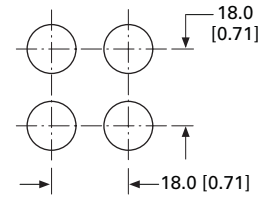

Mounting Distance

Mounting

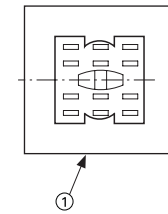

RMQ Screw Adapter

SRA_

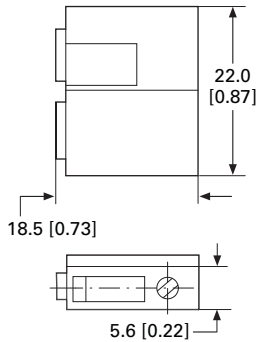

Anti-Rotation Feature

VS

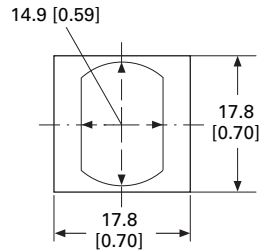

RMQ-16 Label Mount

Q25TS_

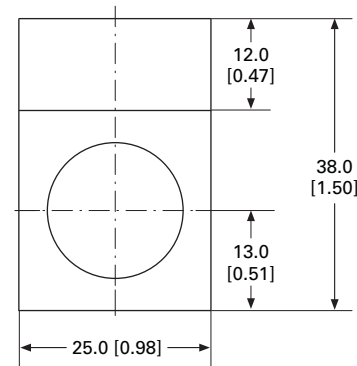

Blanking Plates

Q25AS

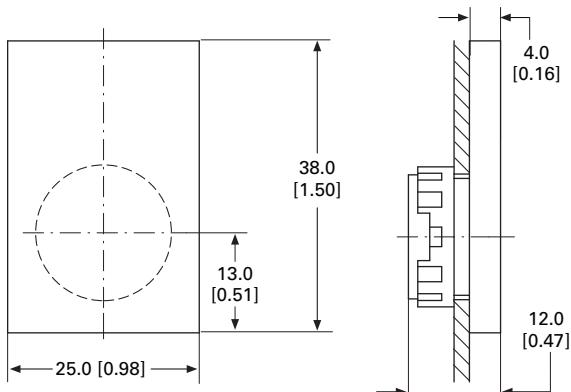

Note

① Exposed conductive part (metal).

22.5 mm RMQ-Titan Modular Pushbuttons—M22



Product Description

Eaton’s M22 industrial heavy-duty pushbutton line offers a wide array of functional, attractive and ergonomically designed illuminated and non-illuminated pushbuttons, selector switches, push-pulls, alternate action and twist-to-release operators. The complete illuminated line is only offered in LED light units to ensure high-quality brightness and up to 100,000 hours of LED illumination. M22 operators are available with either a silver or black nylon colored or chrome metal bezel. The space-saving modular construction of the M22 line makes on-the-job assembly fast and simplifies the stocking of both components and complete devices.

NEW

Eaton has expanded M22 pilot devices with a metal bezel option. The new M22M pushbutton is an elegant chrome metal bezel that is attractive, durable and rugged for heavy-duty environments. M22M devices are configurable and complement components within the M22 line.

Highly Modular and Versatile Line

- Field convertible functions (pushbuttons and selector switches), maintained to momentary
- Customizable laser engraving capabilities

LED Indicators

- 100,000 hours of life in high-vibration environments
- Lenses specifically designed for LED illumination
- Multi-color LED in the flat contact family allows versatility in design and reduces installation costs and footprint

Rugged Design

- Most pushbutton operators and contact blocks exceed 5 million mechanical operations
- All components have IP66 rating, and some carry IP67 and IP69K for washdown environment; see **Page V7-T1-113** for further technical data

Innovative Technologies

- ASi communicating devices
- Palm switches

Contents

Description

| | <i>Page</i> |
|---|------------------|
| 22.5 mm RMQ-Titan Modular Pushbuttons—M22 | |
| Product Selection Guide | V7-T1-42 |
| Accessories | V7-T1-105 |
| Coding Adapter Guide | V7-T1-112 |
| Technical Data and Specifications | V7-T1-113 |
| Dimensions | V7-T1-117 |
| Symbols Library. | V7-T1-123 |

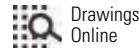

Standards and Certifications

All operators and components are IEC/EN 60947 VDE 0660.

All operators carry an IP66 rating with some rated for washdown environment with IP67 and IP69K.

All pushbuttons, emergency-stops, indicating lights, potentiometers and selector switches carry NEMA 4X, 13.

Marine classification societies: Bureau Veritas (BV), Germanischer Lloyd (GL), and Lloyd’s Register of Shipping (LR) approved.



1.4

Pushbuttons and Indicating Lights

22.5mm 22.5 mm RMQ-Titan Modular Pushbuttons—M22

1

Features

- Field convertible pushbuttons and mushroom operators from maintained to momentary status
- Field convertible selector switches from momentary to maintained operation and vice versa
- LED offering only for all illuminated operators
- Laser engraved pushbuttons, lenses and enclosures
- Heavy-duty construction with a minimum of IP66 and UL NEMA® type 4X / 13 on front of panel operators. Many operators even carry IP67 and IP69K, for the toughest applications
- Silver, black or chrome metal bezel now available
- Snap-lock contact blocks and light units for front or base mounting
- Notched hole mounting with anti-rotation tab and central nut mounting on each operator
- Over 5 million mechanical operations and 1.6 million electrical (reference specification sheet)
- Direct opening action normally closed contacts
- Unique and innovative offerings, such as four-way pushbuttons and USB/ RJ45 bulkhead interfaces
- Screw or spring-cage terminals

Benefits

- Modular construction makes assembly fast and simplifies stocking of components and complete devices
- Field convertibility of operator status for pushbuttons and selector switches helps distributors and customers reduce inventory and increase functionality
- LED offering only for improved brightness quality and up to 100,000 hours of operation
- Plastic construction is corrosion resistant. Operators are designed for rugged environments, ideal for washdown applications (reference each operator's IP ratings and IEC/EN 60529 for ingress protection definition)
- Anti-rotation tab saves installation time and prevents operator rotation
- High mechanical and electrical life allows for use in tough and challenging applications
- Laser inscription capabilities allow for high-quality, wear-resistant markings
- All normally closed (NC) contacts are direct opening action, i.e., NC contacts are physically forced open by direct linkage with the pushbutton operator in the unlikely event of contact weld
- Some M22 operators are capable of communication via ASi protocol
- M22 offers USB and RJ45 connections

Product Selection Guide

Pushbuttons



| | | | | | | | | |
|--------------------------|-----------------------------------|---------------------------------|---------------------------------|---------------------------------|-----------------------------------|---------------------------------|---------------------------------|---------------------------------|
| Description | Non-illuminated, flush | | Non-illuminated, extended | | Illuminated, flush | | Illuminated, extended | |
| Operator | Momentary | Maintained | Momentary | Maintained | Momentary | Maintained | Momentary | Maintained |
| Product Selection | Pages V7-T1-47 to V7-T1-49 | Pages V7-T1-50, V7-T1-51 | Pages V7-T1-52, V7-T1-53 | Pages V7-T1-54, V7-T1-55 | Pages V7-T1-57 to V7-T1-59 | Pages V7-T1-60, V7-T1-61 | Pages V7-T1-62, V7-T1-63 | Pages V7-T1-64, V7-T1-65 |

Indicating Lights



| | | |
|--------------------------|---------------------------------|---------------------------------|
| Description | Flat | Conical |
| Product Selection | Pages V7-T1-66, V7-T1-67 | Pages V7-T1-66, V7-T1-67 |

Emergency Stops



| | | | | |
|--------------------------|----------------------|----------------------|----------------------|-----------------------|
| Description | Non-illuminated | Illuminated | Key release | Mechanical indication |
| Product Selection | Page V7-T1-69 | Page V7-T1-69 | Page V7-T1-70 | Page V7-T1-70 |

Selector Switches



| | | | | |
|--------------------------|---------------------------------|---------------------------------|-----------------------------------|-----------------------------------|
| Description | Non-illuminated knob type | Non-illuminated rotary type | Illuminated | Key-operated |
| Product Selection | Pages V7-T1-74, V7-T1-75 | Pages V7-T1-76, V7-T1-77 | Pages V7-T1-79 to V7-T1-81 | Pages V7-T1-82 to V7-T1-85 |

Mushroom Head Pushbuttons



| | | |
|--------------------------|---------------------------------|---------------------------------|
| Description | Non-illuminated | Non-illuminated |
| Operator | Momentary | Maintained |
| Product Selection | Pages V7-T1-88, V7-T1-89 | Pages V7-T1-90, V7-T1-91 |

Double Pushbuttons



| | | | |
|--------------------------|---------------------------------------|---|------------------------------------|
| Description | Extended pushbuttons and center light | Flush top and center light, extended bottom | Flush pushbuttons and center light |
| Operator | Momentary | Momentary | — |
| Product Selection | Page V7-T1-93 | Page V7-T1-94 | Page V7-T1-94 |

1.4

Pushbuttons and Indicating Lights

22.5 mm RMQ-Titan Modular Pushbuttons—M22

1

Four-Way Pushbuttons



| | | |
|--------------------------|-------------------------------|-------------------------------|
| Description | Non-interlocked | Interlocked |
| Operator | Momentary | Maintained |
| Product Selection | Page V7-T1-97 | Page V7-T1-97 |

Joysticks



| | |
|--------------------------|-------------------------------|
| Description | Joysticks |
| Product Selection | Page V7-T1-98 |

Potentiometers



| | |
|--------------------------|--------------------------------|
| Description | Potentiometers |
| Product Selection | Page V7-T1-100 |

Acoustic Devices



| | |
|--------------------------|--------------------------------|
| Description | Acoustic devices |
| Product Selection | Page V7-T1-100 |

Through-the-Door Operators



| | |
|--------------------------|--------------------------------|
| Description | Through-the-door operators |
| Product Selection | Page V7-T1-101 |

Bulkhead Interfaces



| | |
|--------------------------|--------------------------------|
| Description | Bulkhead interfaces |
| Product Selection | Page V7-T1-101 |

ASi Adapter Modules



| | |
|--------------------------|--------------------------------|
| Description | ASi adapter modules |
| Product Selection | Page V7-T1-102 |

Palm Switches



| | |
|--------------------------|--------------------------------|
| Description | Palm switches |
| Product Selection | Page V7-T1-103 |

Assembled Control Stations



| | |
|--------------------------|-------------------------------|
| Description | Assembled control stations |
| Product Selection | Page V7-T1-10 |

M22_



Point-of-Purchase Units

| Color | Type | Contact Configuration ^① | Catalog Number |
|-------|---|------------------------------------|-----------------------------|
| Black | Flush momentary | NO/NC | M22-D-S-K11-P |
| Red | Extended momentary | NO/NC | M22-DH-R-K11-P |
| Green | Flush momentary | NO/NC | M22-D-G-K11-P |
| Red | Ext. illuminated (12–30V) momentary | NO/NC | M22-DLH-R-K11-R-P |
| Red | Ext. illuminated (85–264V) momentary | NO/NC | M22-DLH-R-K11-230R-P |
| White | Flush illuminated (12–30V) maintained | NO/NC | M22-DRL-W-K11-W-P |
| White | Flush illuminated (85–264V) maintained | NO/NC | M22-DRL-W-K11-230W-P |
| Red | Indicating light (12–30V) | — | M22-L-R-R-P |
| Green | Indicating light (12–30V) | — | M22-L-G-G-P |
| Red | Indicating light (85–264V) | — | M22-L-R-230R-P |
| Green | Indicating light (85–264 Vac) | — | M22-L-G-230G-P |
| Red | Twist-to-release E-stop | 1NO/2NC | M22-PVT-K12-P |
| Red | Illuminated (12–30V) push-pull E-stop | 1NO/2NC | M22-PVL-K12-R-P |
| Red | Illuminated (85–264V) push-pull E-stop | 1NO/2NC | M22-PVL-K12-230R-P |
| — | Two-position maintained V selector switch | NO/NC | M22-WKV-K11-P |
| — | Three-position momentary selector switch | NO/NC | M22-WK3-K22-P |

Note

① All NC contact blocks are positively driven contact. ⊖

Pushbuttons—Non-Illuminated and Illuminated



Contents

Description

Page

| | |
|---|-----------------|
| Pushbuttons—Non-Illuminated and Illuminated | |
| Non-Illuminated, Flush, Momentary | V7-T1-47 |
| Non-Illuminated, Flush, Maintained | V7-T1-50 |
| Non-Illuminated, Extended, Momentary | V7-T1-52 |
| Non-Illuminated, Extended, Maintained | V7-T1-54 |
| Illuminated, Flush, Momentary | V7-T1-57 |
| Illuminated, Flush, Maintained | V7-T1-60 |
| Illuminated, Extended, Momentary | V7-T1-62 |
| Illuminated, Extended, Maintained | V7-T1-64 |

Pushbuttons—Non-Illuminated and Illuminated

Product Description

Eaton’s M22 pushbutton line is a complete, modular and versatile offering. From field-convertible maintained operators to customizable laser engraved buttons, the M22 pushbutton line provides endless opportunity for flexibility and reduced inventory. Each operator type provides options for ordering as complete or component parts allowing for a perfect fit for each application. All of this flexibility comes in a very rugged design.

Features

- Field convertible from maintained to momentary (available on maintained pushbuttons only)
- Customizable laser engraving on all buttons
- LED offering only for improved brightness quality and up to 100,000 hours of operation
- More than five million mechanical operations on momentary and 1 million on maintained pushbuttons
- Modular construction makes assembly fast and simplifies stocking of components and complete devices
- Capable of communicating via ASi protocol with ASi adapter modules

Protection Type

- IP67, IP69K
- NEMA 4X, 13

Catalog Number Selection

Catalog Number Selection is for illustrative purposes only and not to be used to create new catalog numbers.

Non-Illuminated Pushbuttons

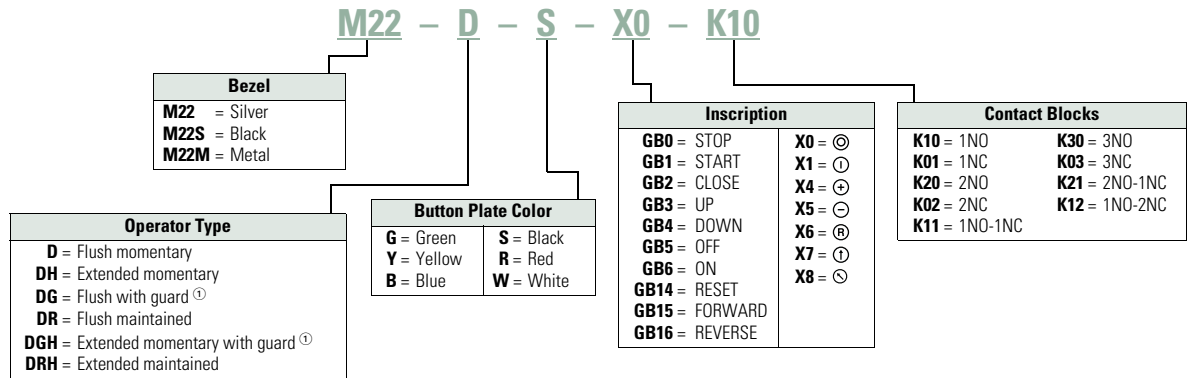

Product Selection

Non-Illuminated Pushbuttons, Flush, Momentary

M22-D-G-K10



M22S-D-G-K10



M22M-D-G-K10



Complete Devices

| Button Color | Contact Block Configuration ① | Silver Bezel Catalog Number | Black Bezel Catalog Number | Metal Bezel Catalog Number |
|--------------|-------------------------------|-----------------------------|----------------------------|----------------------------|
| Black | NO | M22-D-S-K10 | M22S-D-S-K10 | M22M-D-S-K10 |
| | NC | M22-D-S-K01 | M22S-D-S-K01 | M22M-D-S-K01 |
| | 2NO | M22-D-S-K20 | M22S-D-S-K20 | M22M-D-S-K20 |
| | 2NC | M22-D-S-K02 | M22S-D-S-K02 | M22M-D-S-K02 |
| | 1NO-1NC | M22-D-S-K11 | M22S-D-S-K11 | M22M-D-S-K11 |
| Red | NO | M22-D-R-K10 | M22S-D-R-K10 | M22M-D-R-K10 |
| | NC | M22-D-R-K01 | M22S-D-R-K01 | M22M-D-R-K01 |
| | 2NO | M22-D-R-K20 | M22S-D-R-K20 | M22M-D-R-K20 |
| | 2NC | M22-D-R-K02 | M22S-D-R-K02 | M22M-D-R-K02 |
| | 1NO-1NC | M22-D-R-K11 | M22S-D-R-K11 | M22M-D-R-K11 |
| Green | NO | M22-D-G-K10 | M22S-D-G-K10 | M22M-D-G-K10 |
| | NC | M22-D-G-K01 | M22S-D-G-K01 | M22M-D-G-K01 |
| | 2NO | M22-D-G-K20 | M22S-D-G-K20 | M22M-D-G-K20 |
| | 2NC | M22-D-G-K02 | M22S-D-G-K02 | M22M-D-G-K02 |
| | 1NO-1NC | M22-D-G-K11 | M22S-D-G-K11 | M22M-D-G-K11 |

Note

① All NC contact blocks are positively driven contact. ⊖

1

Non-Illuminated Pushbuttons, Flush, Momentary

M22-D-G



Operators Only ^①

| Button Color | Inscription | Silver Bezel Catalog Number | Black Bezel Catalog Number | Metal Bezel Catalog Number |
|--------------|-------------|-----------------------------|------------------------------|------------------------------|
| Black | — | M22-D-S | M22S-D-S | M22M-D-S |
| Red | — | M22-D-R | M22S-D-R | M22M-D-R |
| Green | STOP | M22-D-R-GB0 | M22S-D-R-GB0 | — |
| | ⊙ | M22-D-R-X0 | M22S-D-R-X0 | M22M-D-R-X0 |
| | — | M22-D-G | M22S-D-G | M22M-D-G |
| White | START | M22-D-G-GB1 | M22S-D-G-GB1 | M22M-D-G-GB1 |
| | ① | M22-D-G-X1 | M22S-D-G-X1 | M22M-D-G-X1 |
| | — | M22-D-W | M22S-D-W | M22M-D-W |
| Blue | — | M22-D-B | M22S-D-B | M22M-D-B |
| Yellow | — | M22-D-Y | M22S-D-Y | M22M-D-Y |
| — | — | M22-D-X-SRG ^② | M22S-D-X-SRG ^② | M22M-D-X-SRG ^② |
| — | — | M22-D-X-SWRGYB ^③ | M22S-D-X-SWRGYB ^③ | M22M-D-X-SWRGYB ^③ |

M22S-D-G



M22M-D-G



M22-DG-G



Silver Guarded

| Button Color | Inscription | Silver Bezel Catalog Number |
|--------------|-------------|------------------------------|
| Black | — | M22-DG-S |
| Red | — | M22-DG-R |
| Green | — | M22-DG-G |
| White | — | M22-DG-W |
| Blue | — | M22-DG-B |
| Yellow | — | M22-DG-Y |
| — | — | M22-DG-X-SRG ^② |
| — | — | M22-DG-X-SWRGYB ^③ |

Notes

- ① Includes contact block mounting adapter.
- ② Buttonless operator comes with three color buttons (black, red, green).
- ③ Buttonless operator comes with all six color buttons (black, white, red, green, yellow, blue).

Non-Illuminated Pushbuttons, Flush, Momentary

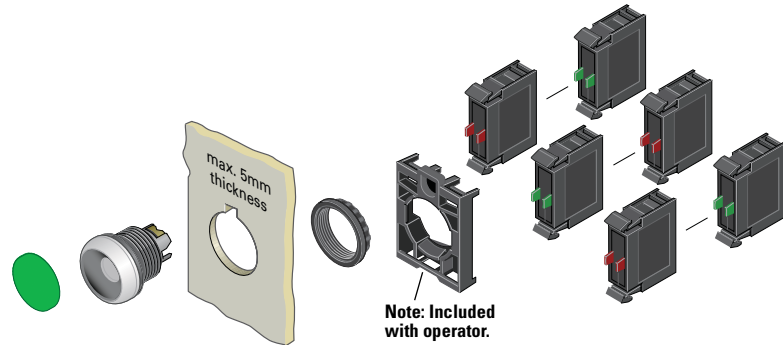

Components

M22-XD-G



Button Plates ^①

| Color | Inscription | Catalog Number |
|--|-------------|----------------------------|
| Black | — | M22-XD-S ^② |
| | Custom | M22-XD-S-ETCH ^③ |
| | STOP | M22-XD-S-GB0 |
| | START | M22-XD-S-GB1 |
| | CLOSE | M22-XD-S-GB2 |
| | UP | M22-XD-S-GB3 |
| | DOWN | M22-XD-S-GB4 |
| | OFF | M22-XD-S-GB5 |
| | ON | M22-XD-S-GB6 |
| | TEST | M22-XD-S-GB9 |
| | FORWARD | M22-XD-S-GB15 |
| | REVERSE | M22-XD-S-GB16 |
| | RAISE | M22-XD-S-GB17 |
| | LOWER | M22-XD-S-GB18 |
| | ⊙ | M22-XD-S-X0 |
| | ⓪ | M22-XD-S-X1 |
| | Ⓛ | M22-XD-S-X2 |
| + | M22-XD-S-X4 | |
| − | M22-XD-S-X5 | |
| Ⓛ | M22-XD-S-X7 | |
| Red | — | M22-XD-R ^② |
| | Custom | M22-XD-R-ETCH ^③ |
| | STOP | M22-XD-R-GB0 |
| | OFF | M22-XD-R-GB5 |
| Green | — | M22-XD-G ^② |
| | Custom | M22-XD-G-ETCH ^③ |
| | START | M22-XD-G-GB1 |
| Blue | ON | M22-XD-G-GB6 |
| | ⓪ | M22-XD-G-X1 |
| | — | M22-XD-B ^② |
| | Custom | M22-XD-B-ETCH ^③ |
| White | RESET | M22-XD-B-GB14 |
| | Ⓡ | M22-XD-B-X6 |
| | — | M22-XD-W ^② |
| Yellow | Custom | M22-XD-W-ETCH ^③ |
| | START | M22-XD-W-GB1 |
| | ⓪ | M22-XD-W-X1 |
| Black, red, green | — | M22-XD-Y ^② |
| | Custom | M22-XD-Y-ETCH ^③ |
| Black, white, red, green, yellow, blue | — | M22-XD-SRG |
| | — | M22-XD-SRWGYB |

Buttonless Operator



Silver Guarded



M22-K10



M22-FK01



Contact Blocks ^①

| Terminal Type | Contact Configuration ^⑤ | Catalog Number |
|---------------|------------------------------------|-----------------------|
| Screw | NO | M22-K10 |
| | NO, early-make | M22-K10P |
| | NC | M22-K01 |
| | NC, late-break | M22-K01D |
| Spring-cage | NO | M22-CK10 |
| | NC | M22-CK01 |
| | NC, late-break | M22-CK01D |
| | 2NO | M22-CK20 |
| | 2NC | M22-CK02 |
| | NO-NC | M22-CK11 |
| | NC | M22-FK01 ^⑥ |
| | NO | M22-FK10 ^⑥ |

Notes

- ① For complete listing of available button plates and contact blocks, see Accessories, Pages V7-T1-105 to V7-T1-110.
- ② Minimum order quantity of (10).
- ③ When ordering, specify inscription per catalog number suffix from the Symbols Library (see Pages V7-T1-123 to V7-T1-130) into the Order Notes. For example, M22-XD-S-ETCH; Order Notes: Mark with symbol X91, Line item #_.
- ④ Includes contact block mounting adapter.
- ⑤ All NC contact blocks are positively driven contact. ⊖
- ⑥ Additional contacts may not be stacked behind M22-F type contact blocks, M22-F can be stacked behind standard M22 contacts only.

1

Non-Illuminated Pushbuttons, Flush, Maintained ^①

M22-DR-S



M22S-DR-S



M22M-DR-S



Operators Only ^②

| Button Color | Silver Bezel Catalog Number | Black Bezel Catalog Number | Metal Bezel Catalog Number |
|--------------|--------------------------------|-------------------------------|-------------------------------|
| Black | M22-DR-S | M22S-DR-S | M22M-DR-S |
| Red | M22-DR-R | M22S-DR-R | M22M-DR-R |
| Green | M22-DR-G | M22S-DR-G | M22M-DR-G |
| White | M22-DR-W | M22S-DR-W | M22M-DR-W |
| Blue | M22-DR-B | M22S-DR-B | M22M-DR-B |
| Yellow | M22-DR-Y | M22S-DR-Y | M22M-DR-Y |
| ③ | M22-DR-X-SRG | M22S-DR-X-SRG | M22M-DR-X-SRG |
| ④ | M22-DR-X-SWRGYB | M22S-DR-X-SWRGYB | M22M-DR-X-SWRGYB |

Notes

- ① Maintained pushbuttons can be converted in the field to momentary operation by switching the locking ring, which is accessible through the side of the operator body.
- ② Includes contact block mounting adapter.
- ③ Buttonless operator comes with three color buttons (black, red, green).
- ④ Buttonless operator comes with all six color buttons (black, white, red, green, yellow, blue).

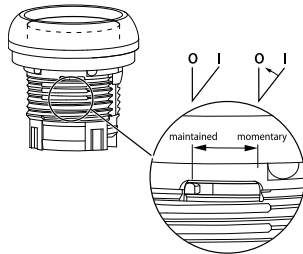

Note: This pilot device features a selectable function switch that enables the device to be set to either maintained or momentary operation.

Non-Illuminated Pushbuttons, Flush, Maintained ^①

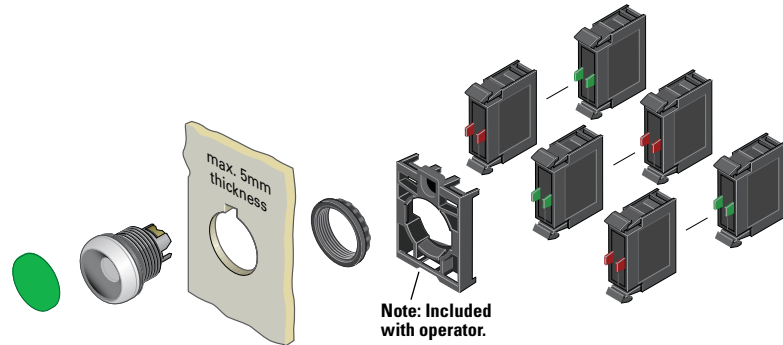

Components

M22-XD-S



Button Plates ^②

| Color | Inscription | Catalog Number |
|--|-------------|----------------------------|
| Black | — | M22-XD-S ^③ |
| | Custom | M22-XD-S-ETCH ^④ |
| | STOP | M22-XD-S-GB0 |
| | START | M22-XD-S-GB1 |
| | CLOSE | M22-XD-S-GB2 |
| | UP | M22-XD-S-GB3 |
| | DOWN | M22-XD-S-GB4 |
| | OFF | M22-XD-S-GB5 |
| | ON | M22-XD-S-GB6 |
| | TEST | M22-XD-S-GB9 |
| | FORWARD | M22-XD-S-GB15 |
| | REVERSE | M22-XD-S-GB16 |
| | RAISE | M22-XD-S-GB17 |
| | LOWER | M22-XD-S-GB18 |
| | ⊙ | M22-XD-S-X0 |
| | ⓪ | M22-XD-S-X1 |
| | Ⓛ | M22-XD-S-X2 |
| | ⊕ | M22-XD-S-X4 |
| ⊖ | M22-XD-S-X5 | |
| Ⓛ | M22-XD-S-X7 | |
| Red | — | M22-XD-R ^③ |
| | Custom | M22-XD-R-ETCH ^④ |
| | STOP | M22-XD-R-GB0 |
| | OFF | M22-XD-R-GB5 |
| | ⊙ | M22-XD-R-X0 |
| | ⊕ | M22-XD-R-X4 |
| Green | — | M22-XD-G ^③ |
| | Custom | M22-XD-G-ETCH ^④ |
| | START | M22-XD-G-GB1 |
| | ON | M22-XD-G-GB6 |
| | ⓪ | M22-XD-G-X1 |
| Blue | — | M22-XD-B ^③ |
| | Custom | M22-XD-B-ETCH ^④ |
| | RESET | M22-XD-B-GB14 |
| White | — | M22-XD-W ^③ |
| | Custom | M22-XD-W-ETCH ^④ |
| | START | M22-XD-W-GB1 |
| Yellow | — | M22-XD-Y ^③ |
| | Custom | M22-XD-Y-ETCH ^④ |
| Black, red, green | — | M22-XD-SRG |
| Black, white, red, green, yellow, blue | — | M22-XD-SWRGYB |

Buttonless Operator



Silver Bezel
Catalog Number ^⑤

M22-DR-X



Black Bezel
Catalog Number ^⑤

M22S-DR-X



Metal Bezel
Catalog Number ^⑤

M22M-DR-X

M22-K10



M22-FK01



Contact Blocks ^②

| Terminal Type | Contact Configuration ^⑥ | Catalog Number |
|---------------|------------------------------------|-----------------------|
| Screw | NO | M22-K10 |
| | NO, early-make | M22-K10P |
| | NC | M22-K01 |
| | NC, late-break | M22-K01D |
| Spring-cage | NO | M22-CK10 |
| | NC | M22-CK01 |
| | NC, late-break | M22-CK01D |
| | 2NO | M22-CK20 |
| | 2NC | M22-CK02 |
| | NO-NC | M22-CK11 |
| NC | NC | M22-FK01 ^⑦ |
| | NO | M22-FK10 ^⑦ |

Notes

- ① Maintained pushbuttons can be converted in the field to momentary operation by switching the locking ring, which is accessible through the side of the operator body.
- ② For complete listing of available button plates and contact blocks, see Accessories, Pages V7-T1-105 to V7-T1-110.
- ③ Minimum order quantity of (10).
- ④ When ordering, specify inscription per catalog number suffix from the Symbols Library (see Pages V7-T1-123 to V7-T1-130) into the Order Notes. For example, M22-XD-S-ETCH; Order Notes: Mark with symbol X91, Line item #_.
- ⑤ Includes contact block mounting adapter.
- ⑥ All NC contact blocks are positively driven contact. ⊖
- ⑦ Additional contacts may not be stacked behind M22-F type contact blocks, M22-F can be stacked behind standard M22 contacts only.

1 Non-Illuminated Pushbuttons, Extended, Momentary

M22-DH-R-K10



M22S-DH-R-K10



M22M-DH-R-K10



Complete Devices

| Button Color | Contact Block Configuration ^① | Silver Bezel Catalog Number | Black Bezel Catalog Number | Metal Bezel Catalog Number |
|--------------|--|-----------------------------|----------------------------|----------------------------|
| Red | NO | M22-DH-R-K10 | M22S-DH-R-K10 | M22M-DH-R-K10 |
| | NC | M22-DH-R-K01 | M22S-DH-R-K01 | M22M-DH-R-K01 |
| | 2NO | M22-DH-R-K20 | M22S-DH-R-K20 | M22M-DH-R-K20 |
| | 2NC | M22-DH-R-K02 | M22S-DH-R-K02 | M22M-DH-R-K02 |
| | 1NO-1NC | M22-DH-R-K11 | M22S-DH-R-K11 | M22M-DH-R-K11 |

M22-DGH-R-K10



Silver Guarded

| Button Color | Contact Block Configuration ^① | Silver Bezel Catalog Number |
|--------------|--|-----------------------------|
| Red | NO | M22-DGH-R-K10 |
| | NC | M22-DGH-R-K01 |
| | 2NO | M22-DGH-R-K20 |
| | 2NC | M22-DGH-R-K02 |
| | 1NO-1NC | M22-DGH-R-K11 |

M22-DH-R



M22S-DH-R



M22M-DH-R



Operators Only ^②

| Button Color | Inscription | Silver Bezel Catalog Number | Black Bezel Catalog Number | Metal Bezel Catalog Number |
|--------------|-------------|-----------------------------|----------------------------|----------------------------|
| Black | — | M22-DH-S | M22S-DH-S | M22M-DH-S |
| Red | — | M22-DH-R | M22S-DH-R | M22M-DH-R |
| | STOP | M22-DH-R-GB0 | M22S-DH-R-GB0 | M22M-DH-R-GB0 |
| | ⊙ | M22-DH-R-X0 | M22S-DH-R-X0 | M22M-DH-R-X0 |
| Green | — | M22-DH-G | M22S-DH-G | M22M-DH-G |
| White | — | M22-DH-W | M22S-DH-W | M22M-DH-W |
| Blue | — | M22-DH-B | M22S-DH-B | M22M-DH-B |
| Yellow | — | M22-DH-Y | M22S-DH-Y | M22M-DH-Y |
| ③ | — | M22-DH-X-SRGR | M22S-DH-X-SRGR | M22M-DH-X-SRGR |
| ④ | — | M22-DH-X-SWRGR | M22S-DH-X-SWRGR | M22M-DH-X-SWRGR |

M22-DGH-R-K10



Silver Guarded

| Button Color | Inscription | Silver Bezel Catalog Number |
|--------------|-------------|-----------------------------|
| Black | — | M22-DGH-S |
| Red | — | M22-DGH-R |
| | STOP | M22-DGH-R-GB0 |
| | ⊙ | M22-DGH-R-X0 |
| Green | — | M22-DGH-G |
| White | — | M22-DGH-W |
| Blue | — | M22-DGH-B |
| Yellow | — | M22-DGH-Y |

Notes

- ① All NC contact blocks are positively driven contact. ⊖
- ② Includes contact block mounting adapter.
- ③ Buttonless operator comes with three color buttons (black, red, green).
- ④ Buttonless operator comes with all six color buttons (black, white, red, green, yellow, blue).

Non-Illuminated Pushbuttons, Extended, Momentary

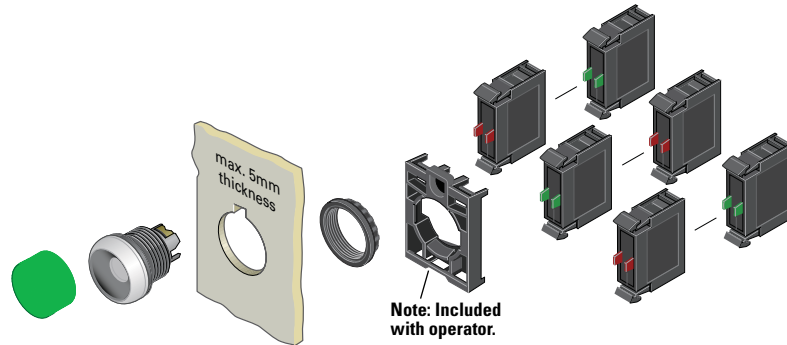

Components

M22-XDH-R



Button Plates ^①

| Color | Inscription | Catalog Number |
|--|--------------|-----------------------------|
| Black | — | M22-XDH-S ^② |
| | Custom | M22-XDH-S-ETCH ^③ |
| | STOP | M22-XDH-S-GB0 |
| | START | M22-XDH-S-GB1 |
| | CLOSE | M22-XDH-S-GB2 |
| | UP | M22-XDH-S-GB3 |
| | DOWN | M22-XDH-S-GB4 |
| | OFF | M22-XDH-S-GB5 |
| | ON | M22-XDH-S-GB6 |
| | TEST | M22-XDH-S-GB9 |
| | FORWARD | M22-XDH-S-GB15 |
| | REVERSE | M22-XDH-S-GB16 |
| | RAISE | M22-XDH-S-GB17 |
| | LOWER | M22-XDH-S-GB18 |
| | ⊙ | M22-XDH-S-X0 |
| | ① | M22-XDH-S-X1 |
| | ② | M22-XDH-S-X2 |
| | + | M22-XDH-S-X4 |
| − | M22-XDH-S-X5 | |
| ① | M22-XDH-S-X7 | |
| Red | — | M22-XDH-R ^② |
| | Custom | M22-XDH-R-ETCH ^③ |
| | STOP | M22-XDH-R-GB0 |
| | OFF | M22-XDH-R-GB5 |
| Green | — | M22-XDH-G ^② |
| | Custom | M22-XDH-G-ETCH ^③ |
| | START | M22-XDH-G-GB1 |
| Blue | ON | M22-XDH-G-GB6 |
| | ① | M22-XDH-G-X1 |
| | — | M22-XDH-B ^② |
| | Custom | M22-XDH-B-ETCH ^③ |
| White | RESET | M22-XDH-B-GB14 |
| | Ⓜ | M22-XDH-B-X6 |
| | — | M22-XDH-W ^② |
| Yellow | Custom | M22-XDH-W-ETCH ^③ |
| | START | M22-XDH-W-GB1 |
| | ① | M22-XDH-W-X1 |
| Black, red, green | — | M22-XDH-Y ^② |
| | Custom | M22-XDH-Y-ETCH ^③ |
| Black, red, green | — | M22-XDH-SRG |
| Black, white, red, green, yellow, blue | — | M22-XDH-SWRGYB |

Buttonless Operator



Silver Bezel
Catalog
Number ^④

M22-D-X



Black Bezel
Catalog
Number ^④

M22S-D-X



Metal Bezel
Catalog
Number ^④

M22M-D-X

Silver Guarded



Silver Bezel
Catalog
Number ^④

M22-DG-X

M22-K10



M22-FK01



Contact Blocks ^①

| Terminal Type | Contact Configuration ^⑤ | Catalog Number |
|---------------|------------------------------------|-----------------------|
| Screw | NO | M22-K10 |
| | NO, early-make | M22-K10P |
| | NC | M22-K01 |
| | NC, late-break | M22-K01D |
| Spring-cage | NO | M22-CK10 |
| | NC | M22-CK01 |
| | NC, late-break | M22-CK01D |
| | 2NO | M22-CK20 |
| | 2NC | M22-CK02 |
| | NO-NC | M22-CK11 |
| | NC | M22-FK01 ^⑥ |
| | NO | M22-FK10 ^⑥ |

Notes

- ① For complete listing of available button plates and contact blocks, see Accessories, Pages V7-T1-105 to V7-T1-110.
- ② Minimum order quantity of (10).
- ③ When ordering, specify inscription per catalog number suffix from the Symbols Library (see Pages V7-T1-123 to V7-T1-130) into the Order Notes. For example, M22-XDH-S-ETCH; Order Notes: Mark with symbol X91, Line item #...
- ④ Includes contact block mounting adapter.
- ⑤ All NC contact blocks are positively driven contact. ⊖
- ⑥ Additional contacts may not be stacked behind M22-F type contact blocks, M22-F can be stacked behind standard M22 contacts only.

1 Non-Illuminated Pushbuttons, Extended, Maintained ^①

M22-DRH-W



M22S-DRH-W



M22M-DRH-W



Operators Only ^②

| Button Color | Silver Bezel Catalog Number | Black Bezel Catalog Number | Metal Bezel Catalog Number |
|--------------|-----------------------------|----------------------------|----------------------------|
| Black | M22-DRH-S | M22S-DRH-S | M22M-DRH-S |
| Red | M22-DRH-R | M22S-DRH-R | M22M-DRH-R |
| Green | M22-DRH-G | M22S-DRH-G | M22M-DRH-G |
| White | M22-DRH-W | M22S-DRH-W | M22M-DRH-W |
| Blue | M22-DRH-B | M22S-DRH-B | M22M-DRH-B |
| Yellow | M22-DRH-Y | M22S-DRH-Y | M22M-DRH-Y |
| ③ | M22-DRH-X-SRG | M22S-DRH-X-SRG | M22M-DRH-X-SRG |
| ④ | M22-DRH-X-SWRGYB | M22S-DRH-X-SWRGYB | M22M-DRH-X-SWRGYB |

Notes

- ① Maintained pushbuttons can be converted in the field to momentary operation by switching the locking ring, which is accessible through the side of the operator body.
- ② Includes contact block mounting adapter.
- ③ Buttonless operator comes with three color buttons (black, red, green).
- ④ Buttonless operator comes with all six color buttons (black, white, red, green, yellow, blue).

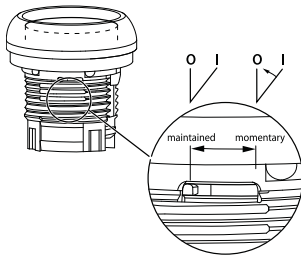

Note: This pilot device features a selectable function switch that enables the device to be set to either maintained or momentary operation.

Non-Illuminated Pushbuttons, Extended, Maintained ^①

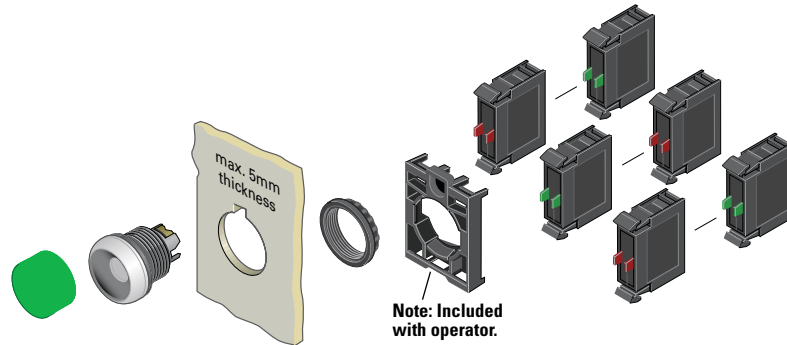

Components

M22-XDH-W



Button Plates ^②

| Color | Inscription | Catalog Number |
|--|--------------|-----------------------------|
| Black | — | M22-XDH-S ^③ |
| | Custom | M22-XDH-S-ETCH ^④ |
| | STOP | M22-XDH-S-GB0 |
| | START | M22-XDH-S-GB1 |
| | CLOSE | M22-XDH-S-GB2 |
| | UP | M22-XDH-S-GB3 |
| | DOWN | M22-XDH-S-GB4 |
| | OFF | M22-XDH-S-GB5 |
| | ON | M22-XDH-S-GB6 |
| | TEST | M22-XDH-S-GB9 |
| | FORWARD | M22-XDH-S-GB15 |
| | REVERSE | M22-XDH-S-GB16 |
| | RAISE | M22-XDH-S-GB17 |
| | LOWER | M22-XDH-S-GB18 |
| | ⊙ | M22-XDH-S-X0 |
| | ⓪ | M22-XDH-S-X1 |
| | Ⓛ | M22-XDH-S-X2 |
| + | M22-XDH-S-X4 | |
| − | M22-XDH-S-X5 | |
| Ⓛ | M22-XDH-S-X7 | |
| Red | — | M22-XDH-R ^③ |
| | Custom | M22-XDH-R-ETCH ^④ |
| | STOP | M22-XDH-R-GB0 |
| | OFF | M22-XDH-R-GB5 |
| | ⊙ | M22-XDH-R-X0 |
| | ⓪ | M22-XDH-R-X1 |
| Green | — | M22-XDH-G ^③ |
| | Custom | M22-XDH-G-ETCH ^④ |
| | START | M22-XDH-G-GB1 |
| | ON | M22-XDH-G-GB6 |
| | ⓪ | M22-XDH-G-X1 |
| Blue | — | M22-XDH-B ^③ |
| | Custom | M22-XDH-B-ETCH ^④ |
| | RESET | M22-XDH-B-GB14 |
| White | Ⓡ | M22-XDH-B-X6 |
| | — | M22-XDH-W ^③ |
| | Custom | M22-XDH-W-ETCH ^④ |
| Yellow | START | M22-XDH-W-GB1 |
| | ⓪ | M22-XDH-W-X1 |
| | — | M22-XDH-Y ^③ |
| Black, red, green | Custom | M22-XDH-Y-ETCH ^④ |
| | — | M22-XDH-SRG |
| Black, white, red, green, yellow, blue | — | M22-XDH-SWRGYB |

Buttonless Operator



Silver Bezel
Catalog Number ^⑤

M22-DR-X



Black Bezel
Catalog Number ^⑤

M22S-DR-X



Metal Bezel
Catalog Number ^⑤

M22M-DR-X

M22-K10



M22-FK01



Contact Blocks ^②

| Terminal Type | Contact Configuration ^⑥ | Catalog Number |
|---------------|------------------------------------|-----------------------|
| Screw | NO | M22-K10 |
| | NO, early-make | M22-K10P |
| | NC | M22-K01 |
| | NC, late-break | M22-K01D |
| Spring-cage | NO | M22-CK10 |
| | NC | M22-CK01 |
| | NC, late-break | M22-CK01D |
| | 2NO | M22-CK20 |
| | 2NC | M22-CK02 |
| | NO-NC | M22-CK11 |
| | NC | M22-FK01 ^⑦ |
| | NO | M22-FK10 ^⑦ |

Notes

- ① Maintained pushbuttons can be converted in the field to momentary operation by switching the locking ring, which is accessible through the side of the operator body.
- ② For complete listing of available button plates and contact blocks, see Accessories, Pages V7-T1-105 to V7-T1-110.
- ③ Minimum order quantity of (10).
- ④ When ordering, specify inscription per catalog number suffix from the Symbols Library (see Pages V7-T1-123 to V7-T1-130) into the Order Notes. For example, M22-XDH-S-ETCH; Order Notes: Mark with symbol X91, Line item #_.
- ⑤ Includes contact block mounting adapter.
- ⑥ All NC contact blocks are positively driven contact. ⊖
- ⑦ Additional contacts may not be stacked behind M22-F type contact blocks, M22-F can be stacked behind standard M22 contacts only.

1

Catalog Number Selection

Catalog Number Selection is for illustrative purposes only and not to be used to create new catalog numbers.

Illuminated Pushbuttons

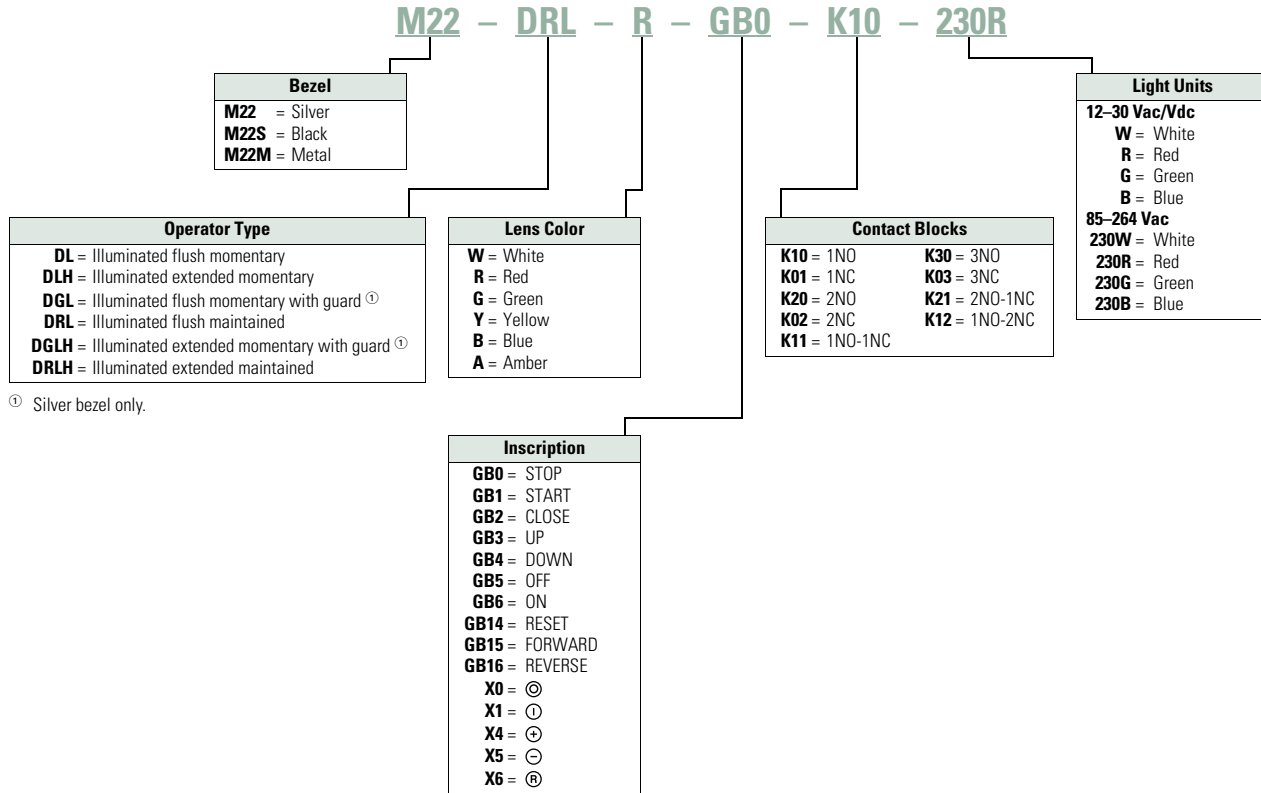

Product Selection

Illuminated Pushbuttons, Flush, Momentary

M22-DL-G-K01-G



M22S-DL-G-K01-G



M22M-DL-G-K01-G



Complete Devices

| Button Color | Contact Block Configuration ^① | Light Unit Voltage | Silver Bezel Catalog Number | Black Bezel Catalog Number | Metal Bezel Catalog Number |
|--------------|--|--------------------|-----------------------------|----------------------------|----------------------------|
| Red | NC | 12–30 Vac/Vdc | M22-DL-R-K01-R | M22S-DL-R-K01-R | M22M-DL-R-K01-R |
| | NC | 85–264 Vac | M22-DL-R-K01-230R | M22S-DL-R-K01-230R | M22M-DL-R-K01-230R |
| | 2NC | 12–30 Vac/Vdc | M22-DL-R-K02-R | M22S-DL-R-K02-R | M22M-DL-R-K02-R |
| | 2NC | 85–264 Vac | M22-DL-R-K02-230R | M22S-DL-R-K02-230R | M22M-DL-R-K02-230R |
| Green | 1NO/1NC | 12–30 Vac/Vdc | M22-DL-R-K11-R | M22S-DL-R-K11-R | M22M-DL-R-K11-R |
| | 1NO/1NC | 85–264 Vac | M22-DL-R-K11-230R | M22S-DL-R-K11-230R | M22M-DL-R-K11-230R |
| | NO | 12–30 Vac/Vdc | M22-DL-G-K10-G | M22S-DL-G-K10-G | M22M-DL-G-K10-G |
| | NO | 85–264 Vac | M22-DL-G-K10-230G | M22S-DL-G-K10-230G | M22M-DL-G-K10-230G |
| White | 2NO | 12–30 Vac/Vdc | M22-DL-G-K20-G | M22S-DL-G-K20-G | M22M-DL-G-K20-G |
| | 2NO | 85–264 Vac | M22-DL-G-K20-230G | M22S-DL-G-K20-230G | M22M-DL-G-K20-230G |
| | 1NO/1NC | 12–30 Vac/Vdc | M22-DL-G-K11-G | M22S-DL-G-K11-G | M22M-DL-G-K11-G |
| | 1NO/1NC | 85–264 Vac | M22-DL-G-K11-230G | M22S-DL-G-K11-230G | M22M-DL-G-K11-230G |
| White | NO | 12–30 Vac/Vdc | M22-DL-W-K10-W | M22S-DL-W-K10-W | — |
| | NO | 85–264 Vac | M22-DL-W-K10-230W | M22S-DL-W-K10-230W | M22M-DL-W-K10-230W |
| | 2NO | 12–30 Vac/Vdc | M22-DL-W-K20-W | M22S-DL-W-K20-W | — |
| | 2NO | 85–264 Vac | M22-DL-W-K20-230W | M22S-DL-W-K20-230W | M22M-DL-W-K20-230W |
| | 1NO/1NC | 12–30 Vac/Vdc | M22-DL-W-K11-W | M22S-DL-W-K11-W | — |
| | 1NO/1NC | 85–264 Vac | M22-DL-W-K11-230W | M22S-DL-W-K11-230W | M22M-DL-W-K11-230W |

Note

^① All NC contact blocks are positively driven contact. ⊖

1

Illuminated Pushbuttons, Flush, Momentary

M22-DL-G



M22S-DL-G



M22M-DL-G



M22-DGL-G



Operators Only [Ⓢ]

| Button Color | Silver Bezel Catalog Number | Black Bezel Catalog Number | Metal Bezel Catalog Number |
|--------------|--------------------------------|-------------------------------|-------------------------------|
| Red | M22-DL-R | M22S-DL-R | M22M-DL-R |
| Green | M22-DL-G | M22S-DL-G | M22M-DL-G |
| White | M22-DL-W | M22S-DL-W | M22M-DL-W |
| Blue | M22-DL-B | M22S-DL-B | M22M-DL-B |
| Yellow | M22-DL-Y | M22S-DL-Y | M22M-DL-Y |
| Amber | M22-DL-A | M22S-DL-A | M22M-DL-A |

Silver Guarded

| Button Color | Silver Bezel Catalog Number |
|--------------|--------------------------------|
| Red | M22-DGL-R |
| Green | M22-DGL-G |
| White | M22-DGL-W |
| Blue | M22-DGL-B |
| Yellow | M22-DGL-Y |

Note

[Ⓢ] Includes contact block mounting adapter.

Illuminated Pushbuttons, Flush, Momentary

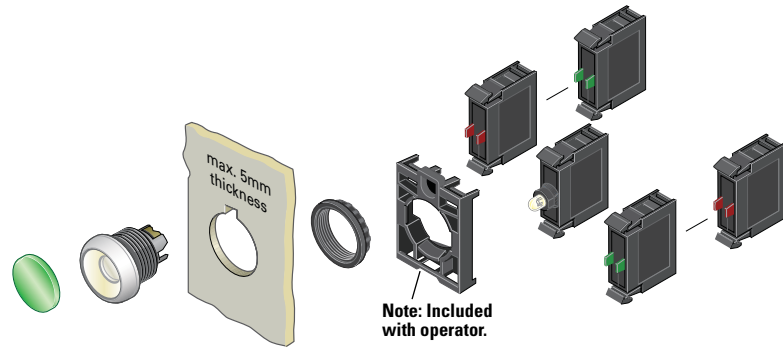

Components

M22-XDL-G



Button Lenses ^①

| Color | Inscription | Catalog Number |
|--------|-------------|-----------------------------|
| Red | — | M22-XDL-R ^② |
| | Custom | M22-XDL-R-ETCH ^③ |
| | STOP | M22-XDL-R-GB0 |
| | OFF | M22-XDL-R-GB5 |
| | Ⓞ | M22-XDL-R-X0 |
| Green | — | M22-XDL-G ^② |
| | Custom | M22-XDL-G-ETCH ^③ |
| | START | M22-XDL-G-GB1 |
| | ON | M22-XDL-G-GB6 |
| | Ⓛ | M22-XDL-G-X1 |
| Blue | — | M22-XDL-B ^② |
| | Custom | M22-XDL-B-ETCH ^③ |
| | RESET | M22-XDL-B-GB14 |
| | Ⓜ | M22-XDL-B-X6 |
| White | — | M22-XDL-W ^② |
| Yellow | Custom | M22-XDL-W-ETCH ^③ |
| | — | M22-XDL-Y ^② |
| Amber | Custom | M22-XDL-Y-ETCH ^③ |
| | — | M22-XDL-A |
| | Custom | M22-XDL-A-ETCH |

M22-DL-X



M22S-DL-X



M22M-DL-X



M22-DGL-X



Buttonless Operator

| Silver Bezel Catalog Number ^④ | Black Bezel Catalog Number ^④ | Metal Bezel Catalog Number ^④ |
|--|---|---|
| M22-DL-X | M22S-DL-X | M22M-DL-X |

Silver Guarded

| Silver Bezel Catalog Number ^④ |
|--|
| M22-DGL-X |

M22-LED-W



M22-FLED-



Light Units ^①

| Terminal Type | LED Color | Light Unit Voltage | Catalog Number |
|---------------|--|--------------------|---------------------------|
| Screw | White | 12–30 | M22-LED-W |
| | Red | Vac/Vdc | M22-LED-R |
| | Green | | M22-LED-G |
| | Blue | | M22-LED-B |
| Screw | White | 85–264 | M22-LED230-W |
| | Red | Vac | M22-LED230-R |
| | Green | | M22-LED230-G |
| Spring-cage | Blue | | M22-LED230-B |
| | White | 12–30 | M22-FLED-W |
| | Red | Vac/Vdc | M22-FLED-R |
| | Green | | M22-FLED-G |
| | Blue | | M22-FLED-B |
| | Red/Green/Yellow | 24 Vdc | M22-FLED-RG ^⑤ |
| | Red, Green, Blue, Yellow, White, Violet, Turquoise | | M22-FLED-RGB ^⑤ |

M22-K10



M22-FK01



Contact Blocks ^①

| Terminal Type | Contact Configuration ^⑥ | Catalog Number |
|---------------|------------------------------------|-----------------------|
| Screw | NO | M22-K10 |
| | NO, early-make | M22-K10P |
| | NC | M22-K01 |
| | NC, late-break | M22-K01D |
| Spring-cage | NO | M22-CK10 |
| | NC | M22-CK01 |
| | NC, late-break | M22-CK01D |
| | 2NO | M22-CK20 |
| | 2NC | M22-CK02 |
| | NO-NC | M22-CK11 |
| | NC | M22-FK01 ^⑦ |
| | NO | M22-FK10 ^⑦ |

Notes

- ① For complete listing of available button lenses, light units and contact blocks, see Accessories, **Pages V7-T1-105 to V7-T1-110.**
- ② Minimum order quantity of (10).
- ③ When ordering, specify inscription per catalog number suffix from the Symbols Library (see **Pages V7-T1-123 to V7-T1-130**) into the Order Notes. For example, M22-XDL-R-ETCH; Order Notes: Mark with symbol X91, Line item #_.
- ④ Includes contact block mounting adapter.
- ⑤ Please see color input key on **Page V7-T1-108.**
- ⑥ All NC contact blocks are positively driven contact. Ⓞ
- ⑦ Additional contacts may not be stacked behind M22-F type contact blocks, M22-F can be stacked behind standard M22 contacts only.

1

Illuminated Pushbuttons, Flush, Maintained ^①

M22-DRL-W-K10-W



M22S-DRL-W-K10-W



M22M-DRL-W-K10-W



Complete Devices

| Button Color | Contact Block Configuration ^② | Light Unit Voltage | Silver Bezel Catalog Number | Black Bezel Catalog Number | Metal Bezel Catalog Number |
|--------------|--|--------------------|-----------------------------|----------------------------|----------------------------|
| White | NO | 12–30 Vac/Vdc | M22-DRL-W-K10-W | M22S-DRL-W-K10-W | M22M-DRL-W-K10-W |
| | NO | 85–264 Vac | M22-DRL-W-K10-230W | M22S-DRL-W-K10-230W | M22M-DRL-W-K10-230W |
| | NC | 12–30 Vac/Vdc | M22-DRL-W-K01-W | M22S-DRL-W-K01-W | M22M-DRL-W-K01-W |
| | NC | 85–264 Vac | M22-DRL-W-K01-230W | M22S-DRL-W-K01-230W | M22M-DRL-W-K01-230W |
| | 2NO | 12–30 Vac/Vdc | M22-DRL-W-K20-W | M22S-DRL-W-K20-W | M22M-DRL-W-K20-W |
| | 2NO | 85–264 Vac | M22-DRL-W-K20-230W | M22S-DRL-W-K20-230W | M22M-DRL-W-K20-230W |
| | 2NC | 12–30 Vac/Vdc | M22-DRL-W-K02-W | M22S-DRL-W-K02-W | M22M-DRL-W-K02-W |
| | 2NC | 85–264 Vac | M22-DRL-W-K02-230W | M22S-DRL-W-K02-230W | M22M-DRL-W-K02-230W |
| | 1NO/1NC | 12–30 Vac/Vdc | M22-DRL-W-K11-W | M22S-DRL-W-K11-W | M22M-DRL-W-K11-W |
| | 1NO/1NC | 85–264 Vac | M22-DRL-W-K11-230W | M22S-DRL-W-K11-230W | M22M-DRL-W-K11-230W |

M22-DRL-W



M22S-DRL-W



M22M-DRL-W



Operators Only ^③

| Button Color | Silver Bezel Catalog Number | Black Bezel Catalog Number | Metal Bezel Catalog Number |
|--------------|-----------------------------|----------------------------|----------------------------|
| Red | M22-DRL-R | M22S-DRL-R | M22M-DRL-R |
| Green | M22-DRL-G | M22S-DRL-G | M22M-DRL-G |
| White | M22-DRL-W | M22S-DRL-W | M22M-DRL-W |
| Blue | M22-DRL-B | M22S-DRL-B | M22M-DRL-B |
| Yellow | M22-DRL-Y | M22S-DRL-Y | M22M-DRL-Y |
| Amber | M22-DRL-A | M22S-DRL-A | M22M-DRL-A |

Notes

- ① Maintained pushbuttons can be converted in the field to momentary operation by switching the locking ring, which is accessible through the side of the operator body.
- ② All NC contact blocks are positively driven contact.
- ③ Includes contact block mounting adapter.

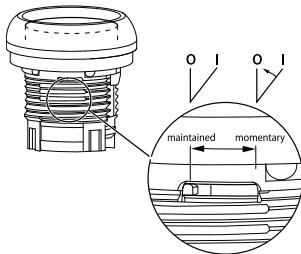

Note: This pilot device features a selectable function switch that enables the device to be set to either maintained or momentary operation.

Illuminated Pushbuttons, Flush, Maintained ^①

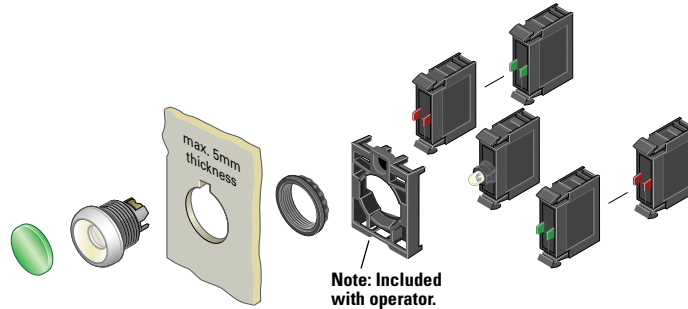

Components

M22-XDL-W



Button Lenses ^②

| Color | Inscription | Catalog Number |
|--------|-------------|------------------------------------|
| Red | — | M22-XDL-R ^③ |
| | Custom | M22-XDL-R-ETCH ^④ |
| | STOP | M22-XDL-R-GB0 |
| | OFF | M22-XDL-R-GB5 |
| | Ⓞ | M22-XDL-R-X0 |
| Green | — | M22-XDL-G ^③ |
| | Custom | M22-XDL-G-ETCH ^④ |
| | START | M22-XDL-G-GB1 |
| | ON | M22-XDL-G-GB6 |
| | Ⓛ | M22-XDL-G-X1 |
| Blue | — | M22-XDL-B ^③ |
| | Custom | M22-XDL-B-ETCH ^④ |
| | RESET | M22-XDL-B-GB14 |
| | Ⓡ | M22-XDL-B-X6 |
| | White | — |
| Yellow | Custom | M22-XDL-W-ETCH ^④ |
| | Custom | M22-XDL-Y-ETCH ^④ |
| Amber | — | M22-XDL-A |
| | Custom | M22-XDL-A-ETCH |

M22-DRL-X



Buttonless Operator

| Silver Bezel Catalog Number ^⑤ | Black Bezel Catalog Number ^⑤ | Metal Bezel Catalog Number ^⑤ |
|--|---|---|
| M22-DRL-X | M22S-DRL-X | M22M-DRL-X |

M22S-DRL-X



M22M-DRL-X



M22-LED-W



Light Units ^②

| Terminal Type | LED Color | Light Unit Voltage | Catalog Number |
|---------------|--|----------------------------------|---------------------|
| Screw | White | 12–30 Vac/Vdc | M22-LED-W |
| | Red | | M22-LED-R |
| | Green | | M22-LED-G |
| | Blue | | M22-LED-B |
| Screw | White | 85–264 Vac | M22-LED230-W |
| | Red | | M22-LED230-R |
| | Green | | M22-LED230-G |
| Spring-cage | Blue | 12–30 Vac/Vdc | M22-LED230-B |
| | White | | M22-FLED-W |
| | Red | | M22-FLED-R |
| | Green | | M22-FLED-G |
| | Blue | | M22-FLED-B |
| | Red/Green/Yellow | | 24 Vdc |
| | Red, Green, Blue, Yellow, White, Violet, Turquoise | M22-FLED-RGB ^⑥ | |

M22-FLED-



M22-K10



Contact Blocks ^②

| Terminal Type | Contact Configuration ^⑦ | Catalog Number |
|---------------|------------------------------------|------------------------------|
| Screw | NO | M22-K10 |
| | NO, early-make | M22-K10P |
| | NC | M22-K01 |
| | NC, late-break | M22-K01D |
| Spring-cage | NO | M22-CK10 |
| | NC | M22-CK01 |
| | NC, late-break | M22-CK01D |
| | 2NO | M22-CK20 |
| | 2NC | M22-CK02 |
| | NO-NC | M22-CK11 |
| | NC | M22-FK01 ^⑧ |
| | NO | M22-FK10 ^⑧ |

M22-FK01



Notes

- ① Maintained pushbuttons can be converted in the field to momentary operation by switching the locking ring, which is accessible through the side of the operator body.
- ② For complete listing of available button lenses, light units and contact blocks, see Accessories, **Pages V7-T1-105 to V7-T1-110**.
- ③ Minimum order quantity of (10).
- ④ When ordering, specify inscription per catalog number suffix from the Symbols Library (see **Pages V7-T1-123 to V7-T1-130**) into the Order Notes. For example, M22-XDL-R-ETCH; Order Notes: Mark with symbol X91, Line item #_.
- ⑤ Includes contact block mounting adapter.
- ⑥ Please see color input key on **Page V7-T1-108**.
- ⑦ All NC contact blocks are positively driven contact. Ⓞ
- ⑧ Additional contacts may not be stacked behind M22-F type contact blocks, M22-F can be stacked behind standard M22 contacts only.

1

Illuminated Pushbuttons, Extended, Momentary

M22-DLH-R-K11-R



M22S-DLH-R-K11-R



Complete Devices

| Button Color | Contact Block Configuration ^① | Light Unit Voltage | Silver Bezel Catalog Number | Black Bezel Catalog Number | Metal Bezel Catalog Number |
|--------------|--|--------------------|-----------------------------|----------------------------|----------------------------|
| Red | 1NO/1NC | 12–30 Vac/Vdc | M22-DLH-R-K11-R | M22S-DLH-R-K11-R | M22M-DLH-R-K11-R |
| | 1NO/1NC | 85–264 Vac | M22-DLH-R-K11-230R | M22S-DLH-R-K11-230R | M22M-DLH-R-K11-230R |
| Green | 2NO | 12–30 Vac/Vdc | M22-DLH-G-K20-G | M22S-DLH-G-K20-G | M22M-DLH-G-K20-G |
| | 2NO | 85–264 Vac | M22-DLH-G-K20-230G | M22S-DLH-G-K20-230G | M22M-DLH-G-K20-230G |
| White | 2NO | 12–30 Vac/Vdc | M22-DLH-W-K20-W | M22S-DLH-W-K20-W | M22M-DLH-W-K20-W |
| | 2NO | 85–264 Vac | M22-DLH-W-K20-230W | M22S-DLH-W-K20-230W | M22M-DLH-W-K20-230W |

Complete Press-to-Test Units

| Button Color | Light Unit Voltage | Silver Bezel Catalog Number | Black Bezel Catalog Number |
|--------------|--------------------|-----------------------------|----------------------------|
| Red | 12–30 Vac/Vdc | M22-T-R-R | M22S-T-R-R |
| Blue | | M22-T-B-B | M22S-T-B-B |
| Yellow | | M22-T-Y-W | M22S-T-Y-W |
| Green | | M22-T-G-G | M22S-T-G-G |
| White | | M22-T-W-W | M22S-T-W-W |
| Red | 85–264 Vac | M22-T-R-230R | M22S-T-R-230R |
| Blue | | M22-T-R-230B | M22S-T-B-230B |
| Yellow | | M22-T-Y-230W | M22S-T-Y-230W |
| Green | | M22-T-G-230G | M22S-T-G-230G |
| White | | M22-T-W-230W | M22S-T-W-230W |

Operators Only ^②

M22-DLH-R



M22S-DLH-R



M22M-DLH-R



| Button Color | Silver Bezel Catalog Number | Black Bezel Catalog Number | Metal Bezel Catalog Number |
|--------------|-----------------------------|----------------------------|----------------------------|
| Red | M22-DLH-R | M22S-DLH-R | M22M-DLH-R |
| Green | M22-DLH-G | M22S-DLH-G | M22M-DLH-G |
| White | M22-DLH-W | M22S-DLH-W | M22M-DLH-W |
| Blue | M22-DLH-B | M22S-DLH-B | M22M-DLH-B |
| Yellow | M22-DLH-Y | M22S-DLH-Y | M22M-DLH-Y |
| Amber | M22-DLH-A | M22S-DLH-A | M22M-DLH-A |

Silver Guarded

M22-DGLH-R



| Button Color | Silver Bezel Catalog Number |
|--------------|-----------------------------|
| Red | M22-DGLH-R |
| Green | M22-DGLH-G |
| White | M22-DGLH-W |
| Blue | M22-DGLH-B |
| Yellow | M22-DGLH-Y |

Notes

- ^① All NC contact blocks are positively driven contact. ⊖
- ^② Includes contact block mounting adapter.

Illuminated Pushbuttons, Extended, Momentary

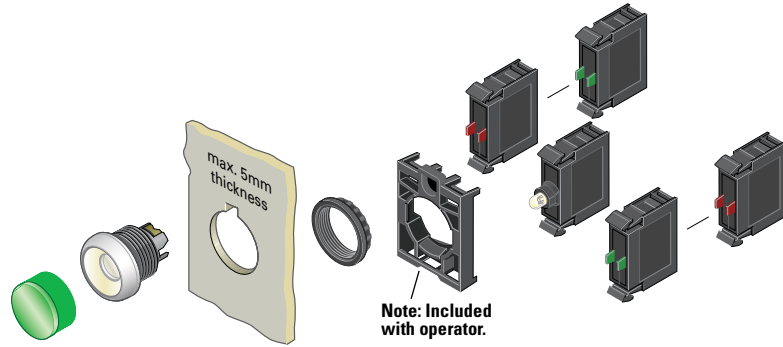

Components

M22-XDH-R



Button Lenses ^①

| Color | Inscription | Catalog Number |
|--------|-------------|------------------------------|
| Red | — | M22-XDLH-R ^② |
| | Custom | M22-XDLH-R-ETCH ^③ |
| | STOP | M22-XDLH-R-GB0 |
| | OFF | M22-XDLH-R-GB5 |
| | ⊙ | M22-XDLH-R-X0 |
| Green | — | M22-XDLH-G ^② |
| | Custom | M22-XDLH-G-ETCH ^③ |
| | START | M22-XDLH-G-GB1 |
| | ON | M22-XDLH-G-GB6 |
| | ⓪ | M22-XDLH-G-X1 |
| Blue | — | M22-XDLH-B ^② |
| | Custom | M22-XDLH-B-ETCH ^③ |
| | RESET | M22-XDLH-B-GB14 |
| | Ⓜ | M22-XDLH-B-X6 |
| White | — | M22-XDLH-W ^② |
| Yellow | Custom | M22-XDLH-W-ETCH ^③ |
| | — | M22-XDLH-Y ^② |
| Amber | Custom | M22-XDLH-Y-ETCH ^③ |
| | — | M22-XDLH-A |
| | Custom | M22-XDLH-A-ETCH |

M22-DL-X



Buttonless Operator

| Silver Bezel Catalog Number ^④ | Black Bezel Catalog Number ^④ | Metal Bezel Catalog Number ^④ |
|--|---|---|
| M22-DL-X | M22S-DL-X | M22M-DL-X |

M22S-DL-X



M22M-DL-X



M22-DGL-X



Silver Guarded

| Silver Bezel Catalog Number ^④ |
|--|
| M22-DGL-X |

M22-LED-W



M22-FLED-



Light Units ^①

| Terminal Type | LED Color | Light Unit Voltage | Catalog Number |
|---------------|--|--------------------|---------------------------|
| Screw | White | 12–30 Vac/Vdc | M22-LED-W |
| | Red | | M22-LED-R |
| | Green | | M22-LED-G |
| | Blue | | M22-LED-B |
| Screw | White | 85–264 Vac | M22-LED230-W |
| | Red | | M22-LED230-R |
| | Green | | M22-LED230-G |
| Spring-cage | White | 12–30 Vac/Vdc | M22-FLED-W |
| | Red | | M22-FLED-R |
| | Green | M22-FLED-G | |
| | Blue | M22-FLED-B | |
| | Red/Green/Yellow | 24 Vdc | M22-FLED-RG ^⑤ |
| | Red, Green, Blue, Yellow, White, Violet, Turquoise | | M22-FLED-RGB ^⑤ |

M22-K10



M22-FK01



Contact Blocks ^①

| Terminal Type | Contact Configuration ^⑥ | Catalog Number |
|---------------|------------------------------------|-----------------------|
| Screw | NO | M22-K10 |
| | NO, early-make | M22-K10P |
| | NC | M22-K01 |
| | NC, late-break | M22-K01D |
| Spring-cage | NO | M22-CK10 |
| | NC | M22-CK01 |
| | NC, late-break | M22-CK01D |
| | 2NO | M22-CK20 |
| | 2NC | M22-CK02 |
| | NO-NC | M22-CK11 |
| | NC | M22-FK01 ^⑦ |
| | NO | M22-FK10 ^⑦ |

Notes

- ① For complete listing of available button lenses, light units and contact blocks, see Accessories, **Pages V7-T1-105 to V7-T1-110**.
- ② Minimum order quantity of (10).
- ③ When ordering, specify inscription per catalog number suffix from the Symbols Library (see **Pages V7-T1-123 to V7-T1-130**) into the Order Notes. For example, M22-XDH-S-ETCH; Order Notes: Mark with symbol X91, Line item # _.
- ④ Includes contact block mounting adapter.
- ⑤ Please see color input key on **Page V7-T1-108**.
- ⑥ All NC contact blocks are positively driven contact. ⊖
- ⑦ Additional contacts may not be stacked behind M22-F type contact blocks, M22-F can be stacked behind standard M22 contacts only.

1.4

Pushbuttons and Indicating Lights

22.5 mm RMQ-Titan Modular Pushbuttons—M22

1

Illuminated Pushbuttons, Extended, Maintained ^①

M22-DRLH-W



M22S-DRLH-W



M22M-DRLH-W



Operators Only ^②

| Button Color | Silver Bezel Catalog Number | Black Bezel Catalog Number | Metal Bezel Catalog Number |
|--------------|--------------------------------|-------------------------------|-------------------------------|
| Red | M22-DRLH-R | M22S-DRLH-R | M22M-DRLH-R |
| Green | M22-DRLH-G | M22S-DRLH-G | M22M-DRLH-G |
| White | M22-DRLH-W | M22S-DRLH-W | M22M-DRLH-W |
| Blue | M22-DRLH-B | M22S-DRLH-B | M22M-DRLH-B |
| Yellow | M22-DRLH-Y | M22S-DRLH-Y | M22M-DRLH-Y |
| Amber | M22-DRLH-A | M22S-DRLH-A | M22M-DRLH-A |

Notes

- ① Maintained pushbuttons can be converted in the field to momentary operation by switching the locking ring, which is accessible through the side of the operator body.
- ② Includes contact block mounting adapter.

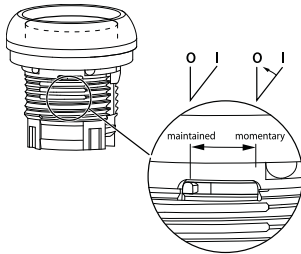

Note: This pilot device features a selectable function switch that enables the device to be set to either maintained or momentary operation.

Illuminated Pushbuttons, Extended, Maintained ^①

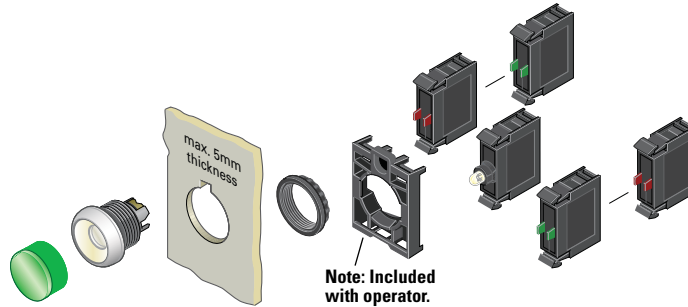

Components

M22-XDLH-W



Button Lenses ^②

| Color | Inscription | Catalog Number |
|--------|-------------|-------------------------------------|
| Red | — | M22-XDLH-R ^③ |
| | Custom | M22-XDLH-R-ETCH ^④ |
| | STOP | M22-XDLH-R-GB0 |
| | OFF | M22-XDLH-R-GB5 |
| | ⊙ | M22-XDLH-R-X0 |
| Green | — | M22-XDLH-G ^③ |
| | Custom | M22-XDLH-G-ETCH ^④ |
| | START | M22-XDLH-G-GB1 |
| | ON | M22-XDLH-G-GB6 |
| | ⓪ | M22-XDLH-G-X1 |
| Blue | — | M22-XDLH-B ^③ |
| | Custom | M22-XDLH-B-ETCH ^④ |
| | RESET | M22-XDLH-B-GB14 |
| | Ⓜ | M22-XDLH-B-X6 |
| White | — | M22-XDLH-W ^③ |
| Yellow | Custom | M22-XDLH-W-ETCH ^④ |
| | — | M22-XDLH-Y ^③ |
| Amber | — | M22-XDLH-A |
| | Custom | M22-XDLH-A-ETCH |

Buttonless Operator

| Silver Bezel Catalog Number ^⑤ | Black Bezel Catalog Number ^⑤ | Metal Bezel Catalog Number ^⑤ |
|--|---|---|
| M22-DRL-X | M22S-DRL-X | M22M-DRL-X |

M22-DRL-X



M22S-DRL-X



M22M-DRL-X



M22-LED-W



M22-FLED-



Light Units ^②

| Terminal Type | LED Color | Light Unit Voltage | Catalog Number |
|---------------|--|--------------------|----------------------------------|
| Screw | White | 12–30 Vac/Vdc | M22-LED-W |
| | Red | | M22-LED-R |
| | Green | | M22-LED-G |
| | Blue | | M22-LED-B |
| Screw | White | 85–264 Vac | M22-LED230-W |
| | Red | | M22-LED230-R |
| | Green | | M22-LED230-G |
| Spring-cage | White | 12–30 Vac/Vdc | M22-FLED-W |
| | Red | | M22-FLED-R |
| | Green | M22-FLED-G | |
| | Blue | M22-FLED-B | |
| | Red/Green/Yellow | 24 Vdc | M22-FLED-RG ^⑥ |
| | Red, Green, Blue, Yellow, White, Violet, Turquoise | | M22-FLED-RGB ^⑥ |

M22-K10



M22-FK01



Contact Blocks ^②

| Terminal Type | Contact Configuration ^⑦ | Catalog Number |
|---------------|------------------------------------|------------------------------|
| Screw | NO | M22-K10 |
| | NO, early-make | M22-K10P |
| | NC | M22-K01 |
| | NC, late-break | M22-K01D |
| Spring-cage | NO | M22-CK10 |
| | NC | M22-CK01 |
| | NC, late-break | M22-CK01D |
| | 2NO | M22-CK20 |
| | 2NC | M22-CK02 |
| | NO-NC | M22-CK11 |
| | NC | M22-FK01 ^⑧ |
| | NO | M22-FK10 ^⑧ |

Notes

- ① Maintained pushbuttons can be converted in the field to momentary operation by switching the locking ring, which is accessible through the side of the operator body.
- ② For complete listing of available button lenses, light units and contact blocks, see Accessories, **Pages V7-T1-105 to V7-T1-110**.
- ③ Minimum order quantity of (10).
- ④ When ordering, specify inscription per catalog number suffix from the Symbols Library (see **Pages V7-T1-123 to V7-T1-130**) into the Order Notes. For example, M22-XDLH-S-ETCH; Order Notes: Mark with symbol X91, Line item #_.
- ⑤ Includes contact block mounting adapter.
- ⑥ Please see color input key on **Page V7-T1-108**.
- ⑦ All NC contact blocks are positively driven contact. ⊖
- ⑧ Additional contacts may not be stacked behind M22-F type contact blocks, M22-F can be stacked behind standard M22 contacts only.

1

Indicating Lights

Product Description

Eaton's M22 indicating lights use the combination of a durable, bright LED unit and modern lenses designed specifically for this type of LED to create a bright and visible indicating light.

As with the pushbuttons, the indicating light lenses can be laser engraved. Indicating lights can be ordered as complete devices, including lens and LED unit, or as modular components.

Features

- Customizable laser engraving on all lenses
- LED offering only for improved brightness quality and up to 100,000 hours of operation
- Lenses designed specifically for LED illumination
- Modular construction makes assembly fast and simplifies stocking of components and complete devices
- Capable of communicating via ASi protocol with ASi adapter modules

Protection Type

- IP67, IP69K
- NEMA 4X, 13

Catalog Number Selection

Catalog Number Selection is for illustrative purposes only and not to be used to create new catalog numbers.

Indicating Lights

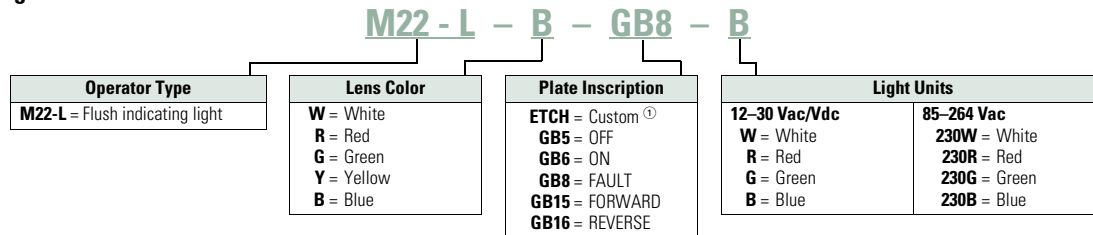

Note: Light unit should match color of lens. Use white light unit with yellow lens.

^① When ordering, specify inscription per catalog number suffix from the Symbols Library (see **Pages V7-T1-123 to V7-T1-130**) into the Order Notes. For example, M22-L-B-ETCH; Order Notes: Mark with symbol X91, Line item #_.

Product Selection

Indicating Lights, Flush

M22-L-R-R



Complete Devices

| Lens Color | Light Color | Light Unit Voltage | Catalog Number |
|------------|-------------|--------------------|---------------------|
| White | White | 12–30 Vac/Vdc | M22-L-W-W |
| Red | Red | | M22-L-R-R |
| Green | Green | | M22-L-G-G |
| Yellow | White | | M22-L-Y-W |
| Blue | Blue | | M22-L-B-B |
| Amber | White | | M22-L-A-W |
| White | White | 85–264 Vac | M22-L-W-230W |
| Red | Red | | M22-L-R-230R |
| Green | Green | | M22-L-G-230G |
| Yellow | White | | M22-L-Y-230W |
| Blue | Blue | | M22-L-B-230B |
| Amber | White | | M22-L-A-230W |

Operators Only ^①

M22-L-R



| Lens Color | Catalog Number |
|-------------|----------------|
| Flat | |
| White | M22-L-W |
| Red | M22-L-R |
| Green | M22-L-G |
| Yellow | M22-L-Y |
| Blue | M22-L-B |
| Amber | M22-L-A |

M22-LH-R



| Lens Color | Catalog Number |
|----------------|-----------------|
| Conical | |
| White | M22-LH-W |
| Red | M22-LH-R |
| Green | M22-LH-G |
| Yellow | M22-LH-Y |
| Blue | M22-LH-B |
| Amber | M22-LH-A |

Note

^① Includes contact block mounting adapter.

Indicating Lights, Flush

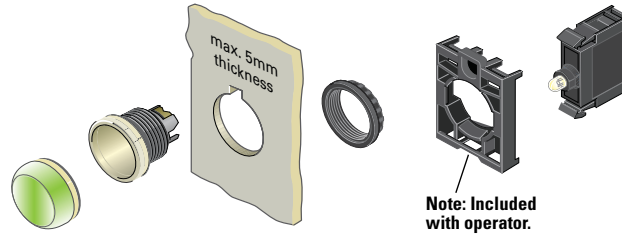

Components

M22-XL-R



Lenses ①

| Color | Inscription | Catalog Number |
|----------------|-------------|------------------------|
| Flat | | |
| Red | — | M22-XL-R ② |
| | Custom | M22-XL-R-ETCH ③ |
| | OFF | M22-XL-R-GB5 |
| Green | — | M22-XL-G ② |
| | Custom | M22-XL-G-ETCH ③ |
| | ON | M22-XL-G-GB6 |
| | REVERSE | M22-XL-G-GB16 |
| Blue | — | M22-XL-B ② |
| | Custom | M22-XL-B-ETCH ③ |
| | FAULT | M22-XL-B-GB8 |
| | — | M22-XL-W ② |
| White | — | M22-XL-W ② |
| | Custom | M22-XL-W-ETCH ③ |
| | OFF | M22-XL-W-GB5 |
| | ON | M22-XL-W-GB6 |
| | FAULT | M22-XL-W-GB8 |
| Yellow | — | M22-XL-Y ② |
| | Custom | M22-XL-Y-ETCH ③ |
| | — | M22-XL-A ② |
| Amber | — | M22-XL-A ② |
| | Custom | M22-XL-A-ETCH ③ |
| Conical | | |
| Red | — | M22-XLH-R |
| Green | — | M22-XLH-G |
| Blue | — | M22-XLH-B |
| White | — | M22-XLH-W |
| Yellow | — | M22-XLH-Y |
| Amber | — | M22-XLH-A |

M22-LED-W



M22-FLED-__



Light Units ③④

| Terminal Type | LED Color | Light Unit Voltage | Catalog Number |
|---------------|--|--------------------|-----------------------|
| Screw | White | 12–30 | M22-LED-W |
| | Red | Vac/Vdc | M22-LED-R |
| | Green | | M22-LED-G |
| | Blue | | M22-LED-B |
| Screw | White | 85–264 | M22-LED230-W |
| | Red | Vac | M22-LED230-R |
| | Green | | M22-LED230-G |
| | Blue | | M22-LED230-B |
| Spring-cage | White | 12–30 | M22-FLED-W |
| | Red | Vac/Vdc | M22-FLED-R |
| | Green | | M22-FLED-G |
| | Blue | | M22-FLED-B |
| | Red/Green/Yellow | 24 Vdc | M22-FLED-RG ⑤ |
| | Red, Green, Blue, Yellow, White, Violet, Turquoise | | M22-FLED-RGB ⑤ |

Notes

- ① For complete listing of available lenses and light units, see Accessories, Pages V7-T1-105 to V7-T1-110.
- ② Minimum order quantity of (10).
- ③ When ordering, specify inscription per catalog number suffix from the Symbols Library (see Pages V7-T1-123 to V7-T1-130) into the Order Notes. For example, M22-XL-R-ETCH; Order Notes: Mark with symbol X91, Line item #__.
- ④ Select the same color LED element as lens color; for yellow and amber lenses, choose a white LED.
- ⑤ Please see color input key on Page V7-T1-108.

M22-L-X



Lensless Indicating Light

Catalog Number

M22-L-X

1

Emergency Stops

Product Description

Eaton's M22 emergency stops are a durable and reliable solution to a variety of e-stop applications. With standard push-pull, as well as twist-to-release and key-release, illuminated options and red or black operators, the M22 e-stop is a robust solution. As with all operators, they can be ordered as a ready to install complete device or as modular components for the perfect fit.

Features

- Push-pull and twist to release options available as well as illuminated and keyed release
- LED offering only for improved brightness quality and up to 100,000 hours of operation
- More than 100,000 mechanical operations
- Capable of communicating via ASi protocol with ASi adapter modules
- Suitable for use in safety applications up to Category-4 or Sil-3

Protection Type

- IP67, IP69K (IP66 key-release)
- NEMA 4X, 13

Catalog Number Selection

Catalog Number Selection is for illustrative purposes only and not to be used to create new catalog numbers.

Emergency Stops

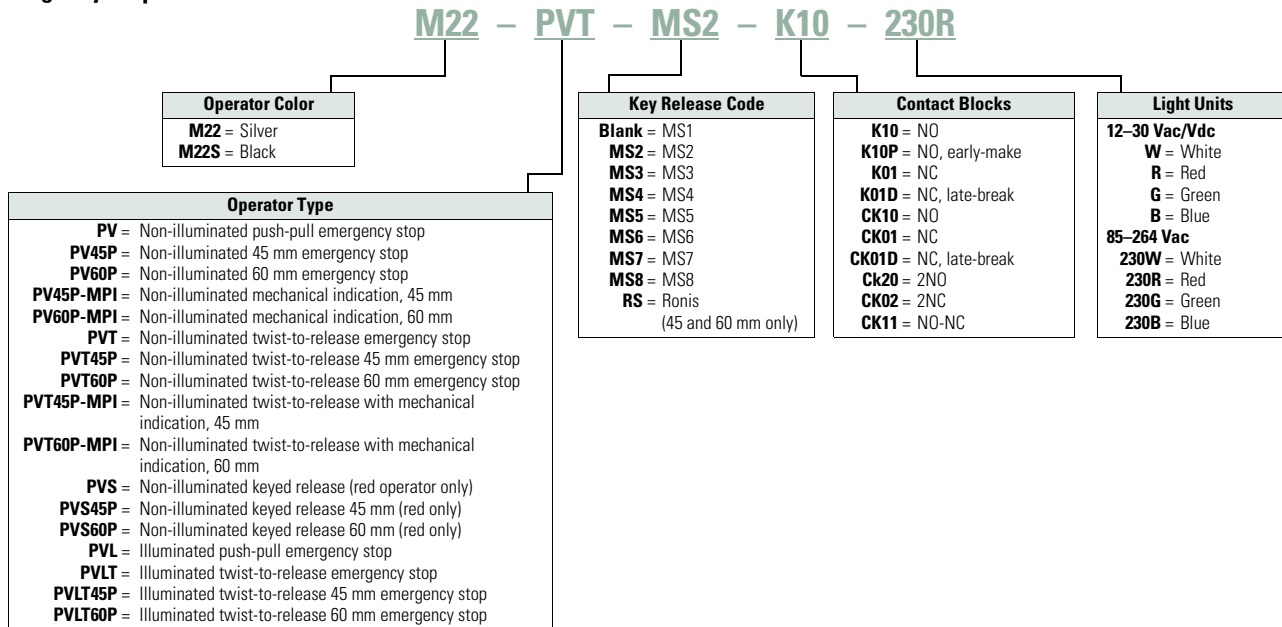

Product Selection

Non-Illuminated and Illuminated Emergency Stops

Complete Devices

| Type | Button Color | LED Color | Contact Block Configuration ^① | Light Unit Voltage | Catalog Number |
|------------------------|--------------|-----------|--|--------------------|--------------------------|
| M22-PV-K01 | | | | | |
| Non-Illuminated | | | | | |
| Push-pull | Red | — | NC | — | M22-PV-K01 |
| | | | 2NC | | M22-PV-K02 |
| | | | 1NO-2NC | | M22-PV-K12 |
| Twist-to-release | Red | — | NC | — | M22-PVT-K01 |
| | | | 2NC | | M22-PVT-K02 |
| | | | 1NO-2NC | | M22-PVT-K12 |
| Key release | Red | — | NC | — | M22-PVS-K01 |
| | | | 2NC | | M22-PVS-K02 |
| | | | 1NO-2NC | | M22-PVS-K12 |
| M22-PVL-K01-R | | | | | |
| Illuminated | | | | | |
| Push-pull | Red | Red | NC | 12–30 Vac/Vdc | M22-PVL-K01-R |
| | | | 2NC | | M22-PVL-K02-R |
| | | | 1NO-2NC | | M22-PVL-K12-R |
| | | | NC | 85–264 Vac | M22-PVL-K01-230R |
| | | | 2NC | | M22-PVL-K02-230R |
| | | | 1NO-2NC | | M22-PVL-K12-230R |
| Twist-to-release | Red | Red | NC | 12–30 Vac/Vdc | M22-PVLT-K01-R |
| | | | 2NC | | M22-PVLT-K02-R |
| | | | 1NO-2NC | | M22-PVLT-K12-R |
| | | | NC | 85–264 Vac | M22-PVLT-K01-230R |
| | | | 2NC | | M22-PVLT-K02-230R |
| | | | 1NO-2NC | | M22-PVLT-K12-230R |

Note

^① All NC contact blocks are positively driven contact. 



Non-Illuminated and Illuminated Emergency Stops

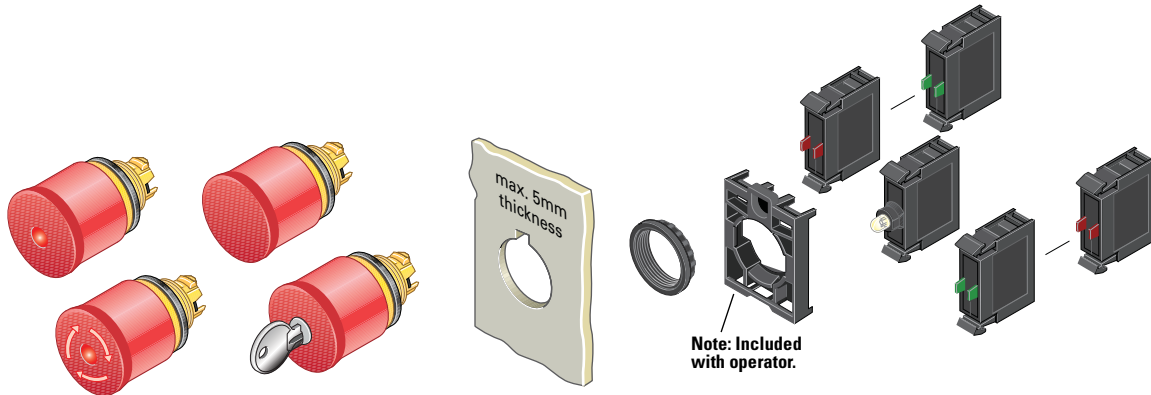

Components

M22-PVL



Push-Pull Emergency Stops

| Illumination/Indication | Actuator Size | Catalog Number |
|-------------------------|---------------|----------------------|
| None | 35 mm | M22-PV |
| | 45 mm | M22-PV45P |
| | 60 mm | M22-PV60P |
| LED illumination | 35 mm | M22-PVL |
| | 45 mm | M22-PVL45P |
| | 60 mm | M22-PVL60P |
| Mechanical indication | 45 mm | M22-PV45P-MPI |
| | 60 mm | M22-PV60P-MPI |

M22-PVS60P-MS1



Key Release Emergency Stops ②

| Actuator Size | Key Code | Catalog Number | |
|---------------|----------------------|-----------------------|-----------------------|
| 35 mm | MS1 | M22-PVS ③ | |
| | MS2 | M22-PVS-MS2 | |
| | MS3 | M22-PVS-MS3 | |
| | MS4 | M22-PVS-MS4 | |
| | MS5 | M22-PVS-MS5 | |
| | MS6 | M22-PVS-MS6 | |
| | MS7 | M22-PVS-MS7 | |
| | MS8 | M22-PVS-MS8 | |
| 45 mm | MS1 | M22-PVS45P | |
| | MS2 | M22-PVS45P-MS2 | |
| | MS3 | M22-PVS45P-MS3 | |
| | MS4 | M22-PVS45P-MS4 | |
| | MS5 | M22-PVS45P-MS5 | |
| | MS6 | M22-PVS45P-MS6 | |
| | MS7 | M22-PVS45P-MS7 | |
| | MS8 | M22-PVS45P-MS8 | |
| | Ronis | M22-PVS45P-RS | |
| | 60 mm | MS1 | M22-PVS60P |
| | | MS2 | M22-PVS60P-MS2 |
| | | MS3 | M22-PVS60P-MS3 |
| | | MS4 | M22-PVS60P-MS4 |
| | | MS5 | M22-PVS60P-MS5 |
| | | MS6 | M22-PVS60P-MS6 |
| | | MS7 | M22-PVS60P-MS7 |
| MS8 | | M22-PVS60P-MS8 | |
| Ronis | M22-PVS60P-RS | | |

M22-PVT45P-MPI



Twist-to-Release Emergency Stops

| Illumination/Indication | Actuator Size | Catalog Number |
|-------------------------|---------------|-----------------------|
| None | 35 mm | M22-PVT |
| | 45 mm | M22-PVT45P |
| | 60 mm | M22-PVT60P |
| LED illumination | 35 mm | M22-PVLT |
| | 45 mm | M22-PVLT45P |
| | 60 mm | M22-PVLT60P |
| Mechanical indication | 45 mm | M22-PVT45P-MPI |
| | 60 mm | M22-PVT60P-MPI |

M22S-PVLT



Machine Stop Operators (Black) ①





| Illumination | Type | Actuator Size | Catalog Number |
|------------------|------------------|---------------|------------------|
| Non-illuminated | Push-pull | 35 mm | M22S-PV |
| | Twist-to-release | 35 mm | M22S-PVT |
| LED illumination | Push-pull | 35 mm | M22S-PVL |
| | Twist-to-release | 35 mm | M22S-PVLT |

Notes



- ① Includes contact block mounting adapter.
- ② Key included. For identical locks and keys, use the same key code. One key is included with actuator; additional keys are available as accessories.
- ③ Includes Key Code MS1.

Maximum number of contacts: four M22-(C)K01, ...10, or two M22-(C)K02, ...20, ...11. Refer to IL or technical data sheet for more information.

Contact Blocks ①

| | Terminal Type | Mounting Location ② | Contact Configuration ③ | Catalog Number | |
|--|-----------------------------|----------------------|--|---|----------------------|
| M22-K10  | Screw | Front | NO | M22-K10 | |
| | | | NO, early-make | M22-K10P | |
| | | | NC | M22-K01 | |
| | | | NC, late-break | M22-K01D | |
| | | | NC ④ | M22-K01PV6 | |
| | | | SMCB, NC | M22-K01SMC10 | |
| | | | SMCB, 2NC | M22-K02SMC10 | |
| | | | Base | SMCB, NC | M22-KC01SMC10 |
| | | | SMCB, 2NC | M22-KC02SMC10 | |
| | | | M22-K01SMC10  | Self-monitoring (1NC and 1NO in series) | Front |
| 2NC | M22-K02SMC10 | | | | |
| Base | 1NC | M22-KC01SMC10 | | | |
| | 2NC | M22-KC02SMC10 | | | |
| FK01SMC10  | Self-monitoring spring-cage | | NC | M22-FK01SMC10 | |
| | | | 3NC | M22-AFK03SMC10 | |
| M22-FK01  | Spring-cage | Front | NO | M22-CK10 | |
| | | | NC | M22-CK01 | |
| | | | NC, late-break | M22-CK01D | |
| | | | 2NO | M22-CK20 | |
| | | | 2NC | M22-CK02 | |
| | | | NO-NC | M22-CK11 | |
| | | | NC | M22-FK01 ⑤ | |
| | | | NO | M22-FK10 ⑤ | |

Light Units ①

| | Terminal Type | LED Color | Light Unit Voltage | Catalog Number |
|---|---------------|-----------|--------------------|----------------------|
| M22-LED-W  | Screw | White | 12–30 Vac/Vdc | M22-LED-W |
| | | Red | 12–30 Vac/Vdc | M22-LED-R |
| | Screw | White | 85–264 Vac | M22-LED230-W |
| | | Red | 85–264 Vac | M22-LED230-R |
| M22-FLED-  | Screw | White | 207–264 Vac | M22-LED230H-W |
| | | Red | 207–264 Vac | M22-LED230H-R |
| | Spring-cage | White | 12–30 Vac/Vdc | M22-FLED-W |
| | | Red | 12–30 Vac/Vdc | M22-FLED-R |





M22-ES-MS1



Extra Keys ⑥

| For Key Code | Catalog Number |
|--------------|-------------------|
| MS1 | M22-ES-MS1 |
| MS2 | M22-ES-MS2 |
| MS3 | M22-ES-MS3 |
| MS4 | M22-ES-MS4 |
| MS5 | M22-ES-MS5 |
| MS6 | M22-ES-MS6 |
| MS7 | M22-ES-MS7 |
| MS8 | M22-ES-MS8 |

Accessories

| Description | Voltage | Catalog Number |
|---|------------|------------------------|
| M22-XGPV  | — | M22-XGPV |
| M22G-XGPV  | — | M22G-XGPV |
| M22-MGTA  | — | M22-MGTA |
| M22-PL-PV  | — | M22-PL-PV |
| M22-XPV60-Y-120  | 24 Vac/Vdc | M22-XPV60-Y-24 |
| | 120 Vac | M22-XPV60-Y-120 |
| | 230 Vac | M22-XPV60-Y-230 |

Notes

- ① For complete listing of available contact blocks, see Accessories, Pages V7-T1-105 to V7-T1-110.
- ② Self-monitoring contact blocks (SMCB type) cannot be used with illuminated emergency stops.
- ③ All NC contact blocks are positively driven contact. ⊖
- ④ Allows up to six contact blocks to be utilized, For use only with only M22-PV_.
- ⑤ Additional contacts may not be stacked behind M22-F type contact blocks, M22-F can be stacked behind standard M22 contacts only.
- ⑥ For use with key release operators only. One key included with operator.

Maximum number of contacts: four M22-(C)K01, ..., 10, or two M22-(C)K02, ..., 20, ..., 11. Refer to IL or technical data sheet for more information.

Selector Switches



Contents

Description

| | Page |
|------------------------------------|-----------------|
| Selector Switches | |
| Non-Illuminated Switches | V7-T1-73 |
| Illuminated Switches | V7-T1-78 |
| Key Operated | V7-T1-82 |

Selector Switches

Product Description

Eaton’s M22 selector switch line offers an almost endless variety of options in maintained/momentary, key-removal and illuminated devices. The coding adapters used for maintained/momentary and key removal positions make the M22 stand out from competitive devices. By simply adding or removing a coding adapter from inside the operator, the end-user can change the function of the button. Operator options include standard knob, rotary head, illuminated and keyed versions. As with all operators, they can be ordered as a ready to install complete device or as modular components to meet application specific requirements.

Features

- Adding or removing coding adapters allows for field convertibility of maintained/momentary and key removal positions
- LED offering only for improved brightness quality and up to 100,000 hours of operation
- More than 100,000 mechanical operations
- Coding adapter options make assembly fast and simplify stocking of different configurations of selector switches
- Capable of communicating via ASi protocol with ASi adapter modules

Protection Type

- IP66
- NEMA 4X, 13

Catalog Number Selection

Catalog Number Selection is for illustrative purposes only and not to be used to create new catalog numbers.

Non-Illuminated Selector Switches

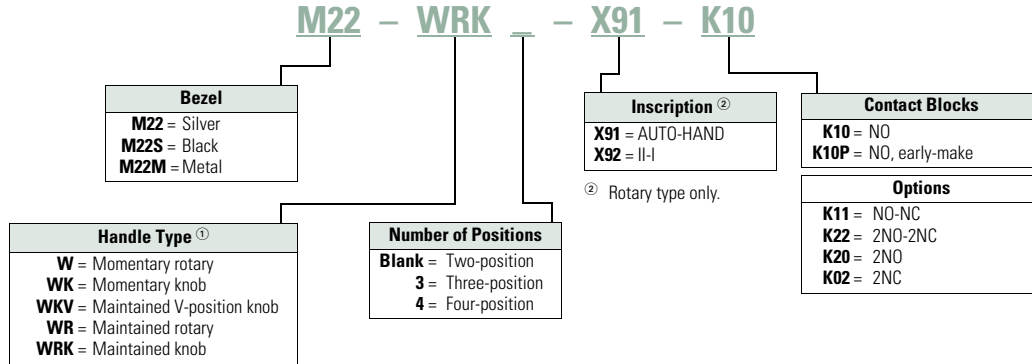

^① All momentary selector switches can be converted in the field to maintained operation with the removal of a color-coded adapter.

1

Product Selection

Non-Illuminated Selector Switches

M22-WKV-K10



M22M-WKV-K10



Complete Devices, Knob Type ①

| Type | Switching Position | Contact Block Configuration ② | Silver Bezel Catalog Number | Black Bezel Catalog Number | Metal Bezel Catalog Number |
|----------------|------------------------------|-------------------------------|-----------------------------|----------------------------|----------------------------|
| Two-position | Maintained 40° | NO | M22-WRK-K10 | M22S-WRK-K10 | M22M-WRK-K10 |
| | | 1NO-1NC | M22-WRK-K11 | M22S-WRK-K11 | M22M-WRK-K11 |
| | | 2NO-2NC | M22-WRK-K22 | M22S-WRK-K22 | M22M-WRK-K22 |
| Two-position | Maintained V 60° | NO | M22-WKV-K10 | M22S-WKV-K10 | M22M-WKV-K10 |
| | | 1NO-1NC | M22-WKV-K11 | M22S-WKV-K11 | M22M-WKV-K11 |
| | | 2NO-2NC | M22-WKV-K22 | M22S-WKV-K22 | M22M-WKV-K22 |
| Three-position | Maintained 60° I 0 II 60° | 2NO | M22-WRK3-K20 | M22S-WRK3-K20 | M22M-WRK3-K20 |
| | | 2NO-2NC | M22-WRK3-K22 | M22S-WRK3-K22 | M22M-WRK3-K22 |

Notes

- ① Includes contact block mounting adapter.
- ② All NC contact blocks are positively driven contact. ⊖

Non-Illuminated Selector Switches

Components





M22-WK



M22M-WK

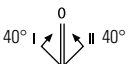
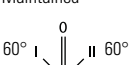
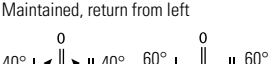
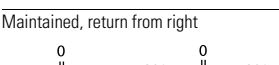
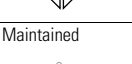

Operators Only, Knob Type ①

| Type | Switching Position | Silver Bezel Catalog Number | Black Bezel Catalog Number | Metal Bezel Catalog Number |
|----------------|--|-----------------------------|----------------------------|----------------------------|
| Two-position | Momentary ②  | M22-WK | M22S-WK | M22M-WK |
| | Maintained  | M22-WRK | M22S-WRK | M22M-WRK |
| | Maintained V  | M22-WKV | M22S-WKV | M22M-WKV |
| Three-position | Momentary ②  | M22-WK3 | M22S-WK3 | M22M-WK3 |
| | Maintained  | M22-WRK3 | M22S-WRK3 | M22M-WRK3 |
| | Maintained, return from left  | M22-WRK3-2 | M22S-WRK3-2 | M22M-WRK3-2 |
| | Maintained, return from right  | M22-WRK3-1 | M22S-WRK3-1 | M22M-WRK3-1 |
| | Maintained  | M22-WRK4 | M22S-WRK4 | M22M-WRK4 |
| | Maintained  | M22-WRK4 | M22S-WRK4 | M22M-WRK4 |

Notes

- ① Includes contact block mounting adapter.
- ② Momentary selector switches can be converted in the field to maintained operation with the removal of a color coded adapter. See **Page V7-T1-112**.

1

Non-Illuminated Selector Switches

Components

M22S-WR3-X94



Operators Only, Rotary Type ①

| Type | Switching Position | Inscription | Silver Bezel Catalog Number | Black Bezel Catalog Number | Metal Bezel Catalog Number |
|----------------|--------------------|-----------------|-----------------------------|----------------------------|----------------------------|
| Two-position | Momentary ② | I-O | M22-W | M22S-W | M22M-W |
| | Maintained | I-O | M22-WR | M22S-WR | M22M-WR |
| | | Custom | M22-WR-ETCH ③ | M22S-WR-ETCH ③ | M22M-WR-ETCH ③ |
| | | AUTO-HAND | M22-WR-X91 | M22S-WR-X91 | M22M-WR-X91 |
| | | II-I | M22-WR-X92 | M22S-WR-X92 | M22M-WR-X92 |
| Three-position | Momentary ② | I-O-II | M22-W3 | M22S-W3 | M22M-W3 |
| | Maintained | I-O-II | M22-WR3 | M22S-WR3 | M22M-WR3 |
| | | Custom | M22-WR3-ETCH ③ | M22S-WR3-ETCH ③ | M22M-WR3-ETCH ③ |
| | | AUTO-O-MAN | M22-WR3-X94 | M22S-WR3-X94 | M22M-WR3-X94 |
| | | | | | |
| Four-position | Maintained | 0-1-0-2-0-3-0-4 | M22-WR4 | M22S-WR4 | M22M-WR4 |

Notes

- ① Includes contact block mounting adapter.
- ② Momentary selector switches can be converted in the field to maintained operation with the removal of a color coded adapter. See **Page V7-T1-112**.
- ③ When ordering, specify inscription per catalog number suffix from the Symbols Library (see **Pages V7-T1-123 to V7-T1-130**) into the Order Notes. For example, M22-WR3-ETCH; Order Notes: Mark with symbol X88, Line item #_.

Non-Illuminated Selector Switches

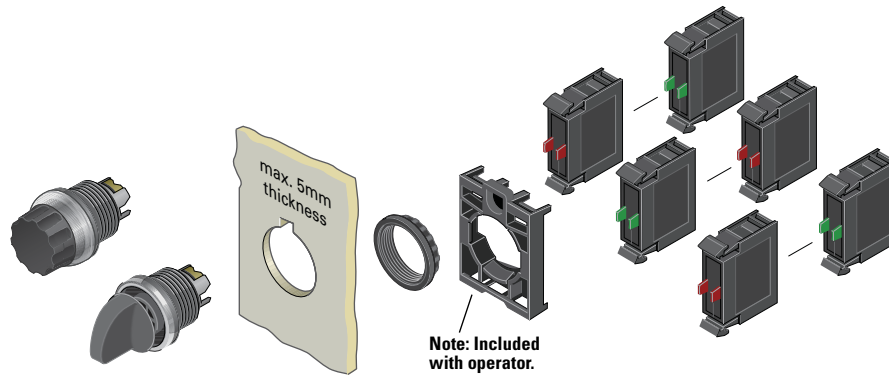

Components

M22-K10







M22-FK01



Contact Blocks ^①

| Terminal Type | Contact Configuration ^② | Catalog Number |
|---------------|------------------------------------|------------------------------|
| Screw | NO | M22-K10 |
| | NO, early-make | M22-K10P |
| | NC | M22-K01 |
| | NC, late-break | M22-K01D |
| Spring-cage | NO | M22-CK10 |
| | NC | M22-CK01 |
| | NC, late-break | M22-CK01D |
| | 2NO | M22-CK20 |
| | 2NC | M22-CK02 |
| | NO-NC | M22-CK11 |
| | NC | M22-FK01 ^③ |
| | NO | M22-FK10 ^③ |

Accessories

| | Description | Catalog Number |
|--|-----------------------------------|-----------------|
| M22-XW  | Plunger bridge ^④ | M22-XW |
| M22-XWS  | Key cover | M22-XWS |
| M22-XC-R  | Key withdraw adapter ^⑤ | M22-XC-R |
| M22-XC-Y  | Coding adapter | M22-XC-Y |
| M22-XGWK  | Guard ring | M22-XGWK |

Notes

- ① For complete listing of available contact blocks, see Accessories, **Pages V7-T1-105 to V7-T1-110**.
- ② All NC contact blocks are positively driven contact. ⊖
- ③ Additional contacts may not be stacked behind M22-F type contact blocks, M22-F can be stacked behind standard M22 contacts only.
- ④ Plunger needed to actuate center-mounted contact blocks. Used for non-illuminated three-position selector switches only.
- ⑤ Enables a keyed selector switch to be set to user-selected key withdraw position.

1.4

Pushbuttons and Indicating Lights

22.5 mm RMQ-Titan Modular Pushbuttons—M22

1

Catalog Number Selection

Catalog Number Selection is for illustrative purposes only and not to be used to create new catalog numbers.

Illuminated Selector Switches

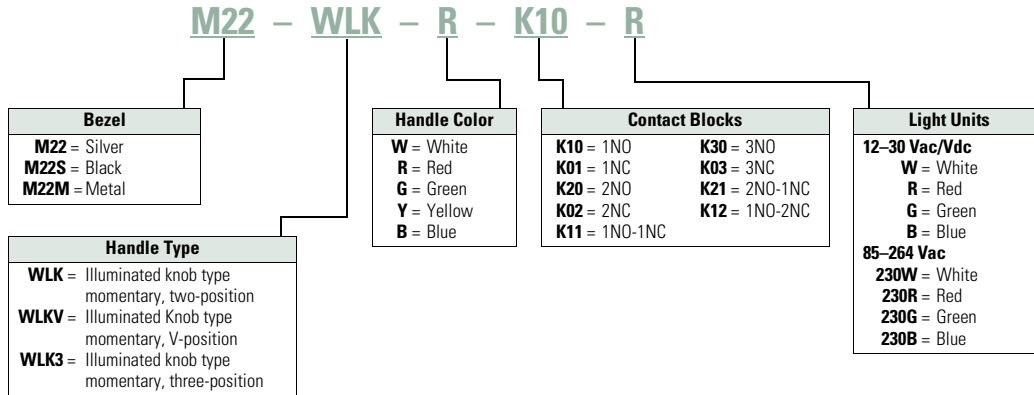

Product Selection



Illuminated Selector Switches

Components

M22-WLK-W

Operators Only, Knob Type ^①



| Type | Switching Position | Button Color | Silver Bezel Catalog Number | Black Bezel Catalog Number | Metal Bezel Catalog Number |
|--------------|---|--------------|-----------------------------|----------------------------|----------------------------|
| Two-position | Momentary ^②  | White | M22-WLK-W | M22S-WLK-W | M22M-WLK-W |
| | | Red | M22-WLK-R | M22S-WLK-R | M22M-WLK-R |
| | | Green | M22-WLK-G | M22S-WLK-G | M22M-WLK-G |
| | | Yellow | M22-WLK-Y | M22S-WLK-Y | M22M-WLK-Y |
| | | Blue | M22-WLK-B | M22S-WLK-B | M22M-WLK-B |
| | Maintained  | White | M22-WRLK-W | M22S-WRLK-W | M22M-WRLK-W |
| | | Red | M22-WRLK-R | M22S-WRLK-R | M22M-WRLK-R |
| | | Green | M22-WRLK-G | M22S-WRLK-G | M22M-WRLK-G |
| | | Yellow | M22-WRLK-Y | M22S-WRLK-Y | M22M-WRLK-Y |
| | | Blue | M22-WRLK-B | M22S-WRLK-B | M22M-WRLK-B |
| | Maintained V  | White | M22-WLKV-W | M22S-WLKV-W | M22M-WLKV-W |
| | | Red | M22-WLKV-R | M22S-WLKV-R | M22M-WLKV-R |
| | | Green | M22-WLKV-G | M22S-WLKV-G | M22M-WLKV-G |
| | | Yellow | M22-WLKV-Y | M22S-WLKV-Y | M22M-WLKV-Y |
| | | Blue | M22-WLKV-B | M22S-WLKV-B | M22M-WLKV-B |

Notes

- ① Includes contact block mounting adapter.
- ② Momentary selector switches can be converted in the field to maintained operation with the removal of a color coded adapter. See **Page V7-T1-112**.

1



Illuminated Selector Switches

Components

M22-WLK3-W

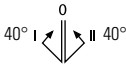
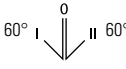

Operators Only, Knob Type ^①

| Type | Switching Position | Button Color | Silver Bezel Catalog Number | Black Bezel Catalog Number | Metal Bezel Catalog Number |
|--|--|---------------|-----------------------------|----------------------------|----------------------------|
| Three-position | Momentary ^②  | White | M22-WLK3-W | M22S-WLK3-W | M22M-WLK3-W |
| | | Red | M22-WLK3-R | M22S-WLK3-R | M22M-WLK3-R |
| | | Green | M22-WLK3-G | M22S-WLK3-G | M22M-WLK3-G |
| | | Yellow | M22-WLK3-Y | M22S-WLK3-Y | M22M-WLK3-Y |
| | | Blue | M22-WLK3-B | M22S-WLK3-B | M22M-WLK3-B |
| | Maintained  | White | M22-WRLK3-W | M22S-WRLK3-W | M22M-WRLK3-W |
| | | Red | M22-WRLK3-R | M22S-WRLK3-R | M22M-WRLK3-R |
| | | Green | M22-WRLK3-G | M22S-WRLK3-G | M22M-WRLK3-G |
| | | Yellow | M22-WRLK3-Y | M22S-WRLK3-Y | M22M-WRLK3-Y |
| | | Blue | M22-WRLK3-B | M22S-WRLK3-B | M22M-WRLK3-B |
| | Maintained, return from right  | White | M22-WRLK3-1-W | M22S-WRLK3-1-W | M22M-WRLK3-1-W |
| | | Red | M22-WRLK3-1-R | M22S-WRLK3-1-R | M22M-WRLK3-1-R |
| Green | | M22-WRLK3-1-G | M22S-WRLK3-1-G | M22M-WRLK3-1-G | |
| Yellow | | M22-WRLK3-1-Y | M22S-WRLK3-1-Y | M22M-WRLK3-1-Y | |
| Blue | | M22-WRLK3-1-B | M22S-WRLK3-1-B | M22M-WRLK3-1-B | |
| Maintained, return from left  | White | M22-WRLK3-2-W | M22S-WRLK3-2-W | M22M-WRLK3-2-W | |
| | Red | M22-WRLK3-2-R | M22S-WRLK3-2-R | M22M-WRLK3-2-R | |
| | Green | M22-WRLK3-2-G | M22S-WRLK3-2-G | M22M-WRLK3-2-G | |
| | Yellow | M22-WRLK3-2-Y | M22S-WRLK3-2-Y | M22M-WRLK3-2-Y | |
| | Blue | M22-WRLK3-2-B | M22S-WRLK3-2-B | M22M-WRLK3-2-B | |

Notes

- ^① Includes contact block mounting adapter.
- ^② Momentary selector switches can be converted in the field to maintained operation with the removal of a color coded adapter. See [Page V7-T1-112](#).

Illuminated Selector Switches

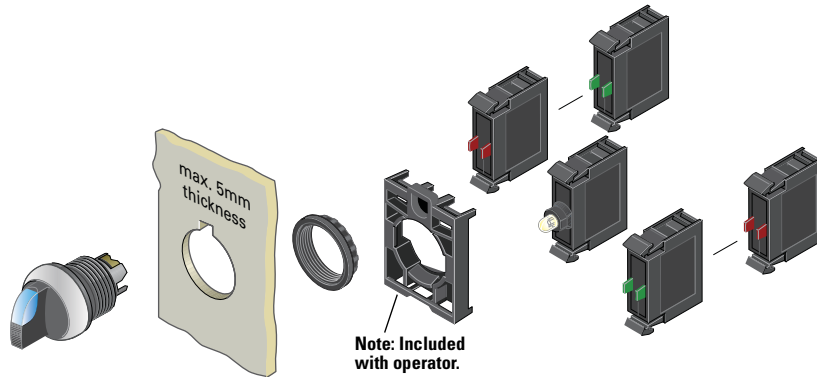

M22-LED-W



M22-FLED-__



Light Units ①

| Terminal Type | LED Color ② | Light Unit Voltage | Catalog Number |
|---------------|---|--------------------|-----------------------|
| Screw | White | 12–30 Vac/Vdc | M22-LED-W |
| | Red | | M22-LED-R |
| | Green | | M22-LED-G |
| | Blue | | M22-LED-B |
| Screw | White | 85–264 Vac | M22-LED230-W |
| | Red | | M22-LED230-R |
| | Green | | M22-LED230-G |
| | Blue | | M22-LED230-B |
| Spring-cage | White | 12–30 Vac/Vdc | M22-FLED-W |
| | Red | | M22-FLED-R |
| | Green | | M22-FLED-G |
| | Blue | | M22-FLED-B |
| | Red/Green/ Yellow | 24 Vdc | M22-FLED-RG ③ |
| | Red, Green, Blue, Yellow, White, Violet, Turquoise | | M22-FLED-RGB ③ |

Accessories

| | Description | Catalog Number |
|-----------------|------------------------|-----------------|
| M22-XW | Plunger bridge ⑥ | M22-XW |
| M22-XWS | Key cover | M22-XWS |
| M22-XC-R | Key withdraw adapter ⑦ | M22-XC-R |
| M22-XC-Y | Coding adapter | M22-XC-Y |
| M22-XGWK | Guard ring | M22-XGWK |

M22-K10



M22-FK01



Contact Blocks ①

| Terminal Type | Contact Configuration ④ | Catalog Number |
|---------------|-------------------------|-------------------|
| Screw | NO | M22-K10 |
| | NO, early-make | M22-K10P |
| | NC | M22-K01 |
| | NC, late-break | M22-K01D |
| Spring-cage | NO | M22-CK10 |
| | NC | M22-CK01 |
| | NC, late-break | M22-CK01D |
| | 2NO | M22-CK20 |
| | 2NC | M22-CK02 |
| | NO-NC | M22-CK11 |
| | NC | M22-FK01 ⑤ |
| | NO | M22-FK10 ⑤ |

Notes

- ① For complete listing of available light units and contact blocks, see Accessories, Pages V7-T1-105 to V7-T1-110.
- ② Select the same color LED element as lens color; for yellow lens, choose a white LED. Select a white lens if utilizing multi-color LED, M22-FLED-RG or M22-FLED-RGB.
- ③ Please see color input key on Page V7-T1-108.
- ④ All NC contact blocks are positively driven contact. ⊖
- ⑤ Additional contacts may not be stacked behind M22-F type contact blocks, M22-F can be stacked behind standard M22 contacts only.
- ⑥ Plunger needed to actuate center-mounted contact blocks. Used for non-illuminated three-position selector switches only.
- ⑦ Enables a keyed selector switch to be set to user-selected key withdraw position.

1

Catalog Number Selection

Catalog Number Selection is for illustrative purposes only and not to be used to create new catalog numbers.

Key-Operated Selector Switches

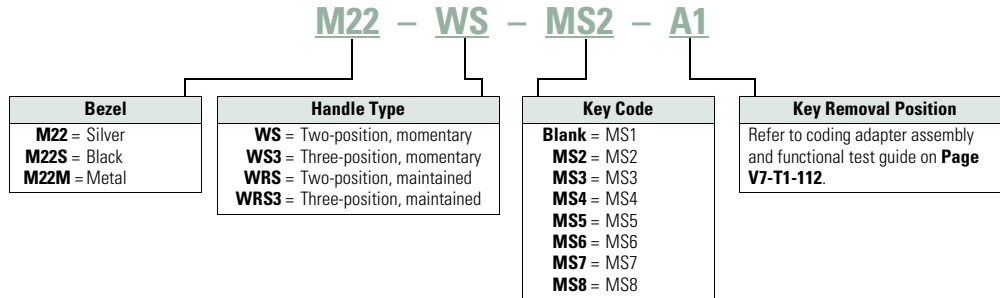

Product Selection

Key-Operated Selector Switches ^{①②}

Components

M22-WS

Operators Only ^③



M22S-WRS



| Type | Switching Position | Key Removal Position | Key Code | Silver Bezel Catalog Number | Black Bezel Catalog Number | Metal Bezel Catalog Number |
|--------------------------|----------------------------|---------------------------------------|--------------|-----------------------------|----------------------------|----------------------------|
| Two-position | Momentary ^④ | Return from right, key removable left | MS1 | M22-WS | M22S-WS | M22M-WS |
| | | | MS2 | M22-WS-MS2 | M22S-WS-MS2 | M22M-WS-MS2 |
| | | | MS3 | M22-WS-MS3 | M22S-WS-MS3 | M22M-WS-MS3 |
| | | | MS4 | M22-WS-MS4 | M22S-WS-MS4 | M22M-WS-MS4 |
| | | | MS5 | M22-WS-MS5 | M22S-WS-MS5 | M22M-WS-MS5 |
| | | | MS6 | M22-WS-MS6 | M22S-WS-MS6 | M22M-WS-MS6 |
| | | | MS7 | M22-WS-MS7 | M22S-WS-MS7 | M22M-WS-MS7 |
| | | | MS8 | M22-WS-MS8 | M22S-WS-MS8 | M22M-WS-MS8 |
| | | | Two-position | Maintained | Key removable left | MS1 |
| MS2 | M22-WRS-MS2-A1 | M22S-WRS-MS2-A1 | | | | M22M-WRS-MS2-A1 |
| MS3 | M22-WRS-MS3-A1 | M22S-WRS-MS3-A1 | | | | M22M-WRS-MS3-A1 |
| MS4 | M22-WRS-MS4-A1 | M22S-WRS-MS4-A1 | | | | M22M-WRS-MS4-A1 |
| MS5 | M22-WRS-MS5-A1 | M22S-WRS-MS5-A1 | | | | M22M-WRS-MS5-A1 |
| MS6 | M22-WRS-MS6-A1 | M22S-WRS-MS6-A1 | | | | M22M-WRS-MS6-A1 |
| MS7 | M22-WRS-MS7-A1 | M22S-WRS-MS7-A1 | | | | M22M-WRS-MS7-A1 |
| MS8 | M22-WRS-MS8-A1 | M22S-WRS-MS8-A1 | | | | M22M-WRS-MS8-A1 |
| Key removable left/right | MS1 | M22-WRS | | | M22S-WRS | M22M-WRS |
| | MS2 | M22-WRS-MS2 | | | M22S-WRS-MS2 | M22M-WRS-MS2 |
| | MS3 | M22-WRS-MS3 | | | M22S-WRS-MS3 | M22M-WRS-MS3 |
| | MS4 | M22-WRS-MS4 | | | M22S-WRS-MS4 | M22M-WRS-MS4 |
| | MS5 | M22-WRS-MS5 | | | M22S-WRS-MS5 | M22M-WRS-MS5 |
| | MS6 | M22-WRS-MS6 | | | M22S-WRS-MS6 | M22M-WRS-MS6 |
| | MS7 | M22-WRS-MS7 | | | M22S-WRS-MS7 | M22M-WRS-MS7 |
| | MS8 | M22-WRS-MS8 | | | M22S-WRS-MS8 | M22M-WRS-MS8 |

Notes

- ① Includes one key.
- ② Key removal positions can be modified in the field using coding adapters; see chart on **Page V7-T1-112**.
- ③ Includes contact block mounting adapter.
- ④ Momentary selector switches can be converted in the field to maintained operation with the removal of a color coded adapter. See **Page V7-T1-112**.

Key-Operated Selector Switches ①②

Components

M22-WS3-X93

Operators Only, continued ③



M22M-WS3-X93

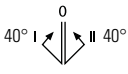
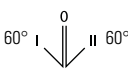

| Type | Switching Position | Key Removal Position | Key Code | Silver Bezel Catalog Number | Black Bezel Catalog Number | Metal Bezel Catalog Number |
|----------------------------|--|--|----------------|---|---------------------------------|----------------------------|
| Three-position | Momentary ④  | Return from left/right, key removable center | MS1 | M22-WS3 | M22S-WS3 | M22M-WS3 |
| | | | MS2 | M22-WS3-MS2 | M22S-WS3-MS2 | M22M-WS3-MS2 |
| | | | MS3 | M22-WS3-MS3 | M22S-WS3-MS3 | M22M-WS3-MS3 |
| | | | MS4 | M22-WS3-MS4 | M22S-WS3-MS4 | M22M-WS3-MS4 |
| | | | MS5 | M22-WS3-MS5 | M22S-WS3-MS5 | M22M-WS3-MS5 |
| | | | MS6 | M22-WS3-MS6 | M22S-WS3-MS6 | M22M-WS3-MS6 |
| | | | MS7 | M22-WS3-MS7 | M22S-WS3-MS7 | M22M-WS3-MS7 |
| | | | MS8 | M22-WS3-MS8 | M22S-WS3-MS8 | M22M-WS3-MS8 |
| | | | Three-position | Maintained  | Key removable left/center/right | MS1 |
| MS2 | M22-WRS3-MS2-A1 | M22S-WRS3-MS2-A1 | | | | M22M-WRS3-MS2-A1 |
| MS3 | M22-WRS3-MS3-A1 | M22S-WRS3-MS3-A1 | | | | M22M-WRS3-MS3-A1 |
| MS4 | M22-WRS3-MS4-A1 | M22S-WRS3-MS4-A1 | | | | M22M-WRS3-MS4-A1 |
| MS5 | M22-WRS3-MS5-A1 | M22S-WRS3-MS5-A1 | | | | M22M-WRS3-MS5-A1 |
| MS6 | M22-WRS3-MS6-A1 | M22S-WRS3-MS6-A1 | | | | M22M-WRS3-MS6-A1 |
| MS7 | M22-WRS3-MS7-A1 | M22S-WRS3-MS7-A1 | | | | M22M-WRS3-MS7-A1 |
| MS8 | M22-WRS3-MS8-A1 | M22S-WRS3-MS8-A1 | | | | M22M-WRS3-MS8-A1 |
| Key removable center/left | MS1 | M22-WRS3-A2 | | | M22S-WRS3-A2 | M22M-WRS3-A2 |
| | MS2 | M22-WRS3-MS2-A2 | | | M22S-WRS3-MS2-A2 | M22M-WRS3-MS2-A2 |
| | MS3 | M22-WRS3-MS3-A2 | | | M22S-WRS3-MS3-A2 | M22M-WRS3-MS3-A2 |
| | MS4 | M22-WRS3-MS4-A2 | | | M22S-WRS3-MS4-A2 | M22M-WRS3-MS4-A2 |
| | MS5 | M22-WRS3-MS5-A2 | | | M22S-WRS3-MS5-A2 | M22M-WRS3-MS5-A2 |
| | MS6 | M22-WRS3-MS6-A2 | | | M22S-WRS3-MS6-A2 | M22M-WRS3-MS6-A2 |
| | MS7 | M22-WRS3-MS7-A2 | | | M22S-WRS3-MS7-A2 | M22M-WRS3-MS7-A2 |
| | MS8 | M22-WRS3-MS8-A2 | | | M22S-WRS3-MS8-A2 | M22M-WRS3-MS8-A2 |
| Key removable center/right | MS1 | M22-WRS3-A3 | | | M22S-WRS3-A3 | M22M-WRS3-A3 |
| | MS2 | M22-WRS3-MS2-A3 | | | M22S-WRS3-MS2-A3 | M22M-WRS3-MS2-A3 |
| | MS3 | M22-WRS3-MS3-A3 | | | M22S-WRS3-MS3-A3 | M22M-WRS3-MS3-A3 |
| | MS4 | M22-WRS3-MS4-A3 | | | M22S-WRS3-MS4-A3 | M22M-WRS3-MS4-A3 |
| | MS5 | M22-WRS3-MS5-A3 | | | M22S-WRS3-MS5-A3 | M22M-WRS3-MS5-A3 |
| | MS6 | M22-WRS3-MS6-A3 | | | M22S-WRS3-MS6-A3 | M22M-WRS3-MS6-A3 |
| | MS7 | M22-WRS3-MS7-A3 | | | M22S-WRS3-MS7-A3 | M22M-WRS3-MS7-A3 |
| | MS8 | M22-WRS3-MS8-A3 | | | M22S-WRS3-MS8-A3 | M22M-WRS3-MS8-A3 |
| Key removable left/right | MS1 | M22-WRS3 | | | M22S-WRS3 | M22M-WRS3 |
| | MS2 | M22-WRS3-MS2 | | | M22S-WRS3-MS2 | M22M-WRS3-MS2 |
| | MS3 | M22-WRS3-MS3 | | | M22S-WRS3-MS3 | M22M-WRS3-MS3 |
| | MS4 | M22-WRS3-MS4 | | | M22S-WRS3-MS4 | M22M-WRS3-MS4 |
| | MS5 | M22-WRS3-MS5 | | | M22S-WRS3-MS5 | M22M-WRS3-MS5 |
| | MS6 | M22-WRS3-MS6 | | | M22S-WRS3-MS6 | M22M-WRS3-MS6 |
| | MS7 | M22-WRS3-MS7 | | | M22S-WRS3-MS7 | M22M-WRS3-MS7 |
| | MS8 | M22-WRS3-MS8 | | | M22S-WRS3-MS8 | M22M-WRS3-MS8 |

Notes

- ① Includes one key.
- ② Key removal positions can be modified in the field using coding adapters; see chart on **Page V7-T1-112**.
- ③ Includes contact block mounting adapter.
- ④ Momentary selector switches can be converted in the field to maintained operation with the removal of a color coded adapter. See **Page V7-T1-112**.

Key-Operated Selector Switches ^{①②}

Components

M22-WS3-X93



M22M-WS3-X93

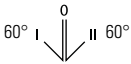
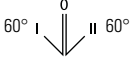

Operators Only, continued ^③

| Type | Switching Position | Key Removal Position | Key Code | Silver Bezel Catalog Number | Black Bezel Catalog Number | Metal Bezel Catalog Number | |
|----------------|--|--|----------|-----------------------------|----------------------------|----------------------------|-------------------------|
| Three-position | Maintained  | Return from left, key removable center | MS1 | M22-WRS3-A7 | M22S-WRS3-A7 | M22M-WRS3-A7 | |
| | | | MS2 | M22-WRS3-MS2-A7 | M22S-WRS3-MS2-A7 | M22M-WRS3-MS2-A7 | |
| | | | MS3 | M22-WRS3-MS3-A7 | M22S-WRS3-MS3-A7 | M22M-WRS3-MS3-A7 | |
| | | | MS4 | M22-WRS3-MS4-A7 | M22S-WRS3-MS4-A7 | M22M-WRS3-MS4-A7 | |
| | | | MS5 | M22-WRS3-MS5-A7 | M22S-WRS3-MS5-A7 | M22M-WRS3-MS5-A7 | |
| | | | MS6 | M22-WRS3-MS6-A7 | M22S-WRS3-MS6-A7 | M22M-WRS3-MS6-A7 | |
| | | | MS7 | M22-WRS3-MS7-A7 | M22S-WRS3-MS7-A7 | M22M-WRS3-MS7-A7 | |
| | | | MS8 | M22-WRS3-MS8-A7 | M22S-WRS3-MS8-A7 | M22M-WRS3-MS8-A7 | |
| | Return from left, key removable center/right | | MS1 | M22-WRS3-A6 | M22S-WRS3-A6 | M22M-WRS3-A6 | |
| | | | MS2 | M22-WRS3-MS2-A6 | M22S-WRS3-MS2-A6 | M22M-WRS3-MS2-A6 | |
| | | | MS3 | M22-WRS3-MS3-A6 | M22S-WRS3-MS3-A6 | M22M-WRS3-MS3-A6 | |
| | | | MS4 | M22-WRS3-MS4-A6 | M22S-WRS3-MS4-A6 | M22M-WRS3-MS4-A6 | |
| | | | MS5 | M22-WRS3-MS5-A6 | M22S-WRS3-MS5-A6 | M22M-WRS3-MS5-A6 | |
| | | | MS6 | M22-WRS3-MS6-A6 | M22S-WRS3-MS6-A6 | M22M-WRS3-MS6-A6 | |
| | | | MS7 | M22-WRS3-MS7-A6 | M22S-WRS3-MS7-A6 | M22M-WRS3-MS7-A6 | |
| | | | MS8 | M22-WRS3-MS8-A6 | M22S-WRS3-MS8-A6 | M22M-WRS3-MS8-A6 | |
| Three-position | Maintained  | Return from right, key removable left/center | MS1 | M22-WRS3-A4 | M22S-WRS3-A4 | M22M-WRS3-A4 | |
| | | | MS2 | M22-WRS3-MS2-A4 | M22S-WRS3-MS2-A4 | M22M-WRS3-MS2-A4 | |
| | | | MS3 | M22-WRS3-MS3-A4 | M22S-WRS3-MS3-A4 | M22M-WRS3-MS3-A4 | |
| | | | MS4 | M22-WRS3-MS4-A4 | M22S-WRS3-MS4-A4 | M22M-WRS3-MS4-A4 | |
| | | | MS5 | M22-WRS3-MS5-A4 | M22S-WRS3-MS5-A4 | M22M-WRS3-MS5-A4 | |
| | | | MS6 | M22-WRS3-MS6-A4 | M22S-WRS3-MS6-A4 | M22M-WRS3-MS6-A4 | |
| | | | MS7 | M22-WRS3-MS7-A4 | M22S-WRS3-MS7-A4 | M22M-WRS3-MS7-A4 | |
| | | | MS8 | M22-WRS3-MS8-A4 | M22S-WRS3-MS8-A4 | M22M-WRS3-MS8-A4 | |
| | | Return from right, key removable center | | MS1 | M22-WRS3-A5 | M22S-WRS3-A5 | M22M-WRS3-A5 |
| | | | | MS2 | M22-WRS3-MS2-A5 | M22S-WRS3-MS2-A5 | M22M-WRS3-MS2-A5 |
| | | | | MS3 | M22-WRS3-MS3-A5 | M22S-WRS3-MS3-A5 | M22M-WRS3-MS3-A5 |
| | | | | MS4 | M22-WRS3-MS4-A5 | M22S-WRS3-MS4-A5 | M22M-WRS3-MS4-A5 |
| | | | MS5 | M22-WRS3-MS5-A5 | M22S-WRS3-MS5-A5 | M22M-WRS3-MS5-A5 | |
| | | | MS6 | M22-WRS3-MS6-A5 | M22S-WRS3-MS6-A5 | M22M-WRS3-MS6-A5 | |
| | | | MS7 | M22-WRS3-MS7-A5 | M22S-WRS3-MS7-A5 | M22M-WRS3-MS7-A5 | |
| | | | MS8 | M22-WRS3-MS8-A5 | M22S-WRS3-MS8-A5 | M22M-WRS3-MS8-A5 | |

Notes

- ① Includes one key.
- ② Key removal positions can be modified in the field using coding adapters; see chart on [Page V7-T1-112](#).
- ③ Includes contact block mounting adapter.

Key-Operated Selector Switches

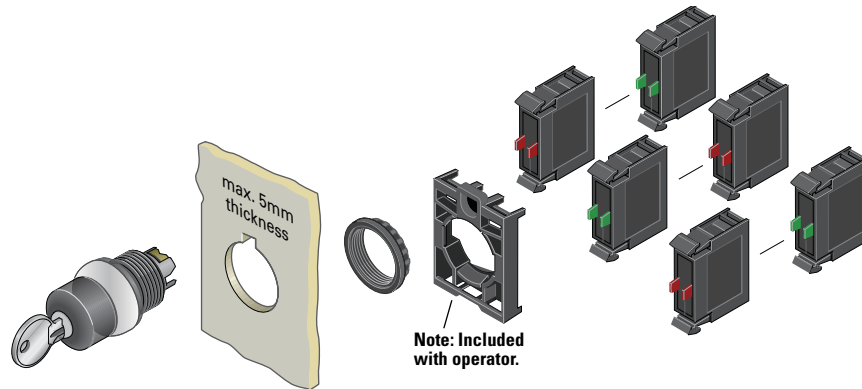

Components

M22-K10



M22-FK01



M22-ES-MS1



Contact Blocks ^①

| Terminal Type | Contact Configuration ^② | Catalog Number |
|---------------|------------------------------------|------------------------------|
| Screw | NO | M22-K10 |
| | NO, early-make | M22-K10P |
| | NC | M22-K01 |
| | NC, late-break | M22-K01D |
| Spring-cage | NO | M22-CK10 |
| | NC | M22-CK01 |
| | NC, late-break | M22-CK01D |
| | 2NO | M22-CK20 |
| | 2NC | M22-CK02 |
| | NO-NC | M22-CK11 |
| | NC | M22-FK01 ^③ |
| | NO | M22-FK10 ^③ |

Extra Keys

| Key Code | Catalog Number |
|----------|-------------------|
| MS1 | M22-ES-MS1 |
| MS2 | M22-ES-MS2 |
| MS3 | M22-ES-MS3 |
| MS4 | M22-ES-MS4 |
| MS5 | M22-ES-MS5 |
| MS6 | M22-ES-MS6 |
| MS7 | M22-ES-MS7 |
| MS8 | M22-ES-MS8 |

Accessories

| | Description | Catalog Number |
|-----------------|-----------------------------------|-----------------|
| M22-XW | Plunger bridge ^④ | M22-XW |
| M22-XWS | Key cover | M22-XWS |
| M22-XC-R | Key withdraw adapter ^⑤ | M22-XC-R |
| M22-XC-Y | Coding adapter | M22-XC-Y |
| M22-XGWK | Guard ring | M22-XGWK |

Notes

- ① For complete listing of available contact blocks, see Accessories, **Pages V7-T1-105 to V7-T1-110.**
- ② All NC contact blocks are positively driven contact. ⊖
- ③ Additional contacts may not be stacked behind M22-F type contact blocks, M22-F can be stacked behind standard M22 contacts only.
- ④ Plunger needed to actuate center-mounted contact blocks. Used for non-illuminated three-position selector switches only.
- ⑤ Enables a keyed selector switch to be set to user-selected key withdraw position.

Mushroom Head Pushbuttons

Product Description

Eaton's M22 mushroom head operators are a durable and unique way to include standard pushbutton functionality. Like the standard pushbutton line, the maintained pushbuttons are field convertible to momentary. They also offer laser engraving and a robust five million mechanical operations on the standard momentary operator. As with all operators, they can be ordered as a ready to install complete device or as modular components.

Features

- Field convertible from maintained to momentary (available on maintained pushbuttons only)
- Customizable laser engraving on all buttons
- More than five million mechanical operations on momentary and one million on maintained pushbuttons
- Modular construction makes assembly fast and simplifies stocking of components and complete devices
- Capable of communicating via ASi protocol with ASi adapter modules

Protection Type

- IP67, IP69K
- NEMA 4X, 13

Catalog Number Selection

Catalog Number Selection is for illustrative purposes only and not to be used to create new catalog numbers.

Mushroom Head Pushbuttons

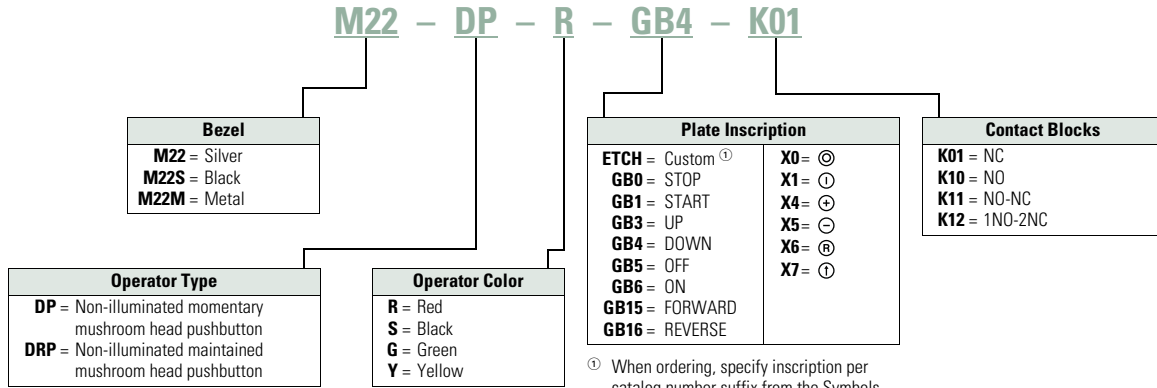

^① When ordering, specify inscription per catalog number suffix from the Symbols Library (see **Pages V7-T1-123 to V7-T1-130**) into the Order Notes. For example, M22-DP-R-ETCH; Order Notes: Mark with symbol X91, Line item #_.

1

Product Selection

Mushroom Head Pushbuttons, Momentary ^①

M22-DP-R-K01



M22S-DP-R-K01



M22M-DP-R-K01



Complete Devices

| Button Color | Contact Block Configuration ^② | Silver Bezel Catalog Number | Black Bezel Catalog Number | Metal Bezel Catalog Number |
|--------------|--|-----------------------------|----------------------------|----------------------------|
| Red | NC | M22-DP-R-K01 | M22S-DP-R-K01 | M22M-DP-R-K01 |
| | 2NC | M22-DP-R-K02 | M22S-DP-R-K02 | M22M-DP-R-K02 |
| | 1NO-2NC | M22-DP-R-K12 | M22S-DP-R-K12 | M22M-DP-R-K12 |
| | 1NO-1NC | M22-DP-R-K11 | M22S-DP-R-K11 | M22M-DP-R-K11 |

M22-DP-G



M22S-DP-G



M22M-DP-G



Operators Only ^②

| Button Color | Silver Bezel Catalog Number | Black Bezel Catalog Number | Metal Bezel Catalog Number |
|--------------|-----------------------------|----------------------------|----------------------------|
| Black | M22-DP-S | M22S-DP-S | M22M-DP-S |
| Red | M22-DP-R | M22S-DP-R | M22M-DP-R |
| Green | M22-DP-G | M22S-DP-G | M22M-DP-G |
| Yellow | M22-DP-Y | M22S-DP-Y | M22M-DP-Y |

Notes

- ① 35 mm diameter mushroom head button.
- ② Includes contact block mounting adapter.

Non-Illuminated Mushroom Head Pushbuttons, Momentary ①

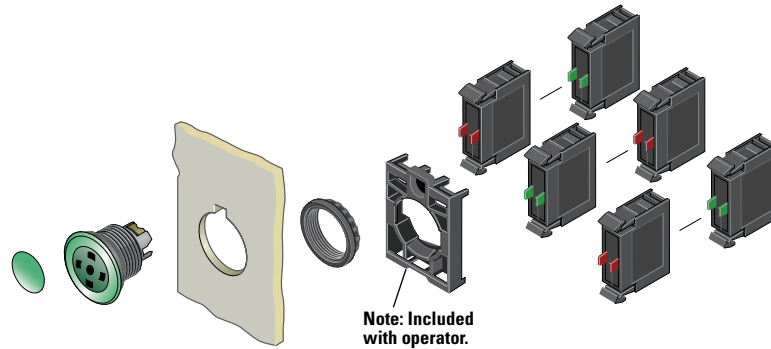

Components

M22-XDP-G



Mushroom Head Plates

| Color | Inscription | Catalog Number |
|--------|--------------|------------------|
| Black | — | M22-XDP-S ② |
| | Custom | M22-XDP-S-ETCH ③ |
| | STOP | M22-XDP-S-GB0 |
| | START | M22-XDP-S-GB1 |
| | FORWARD | M22-XDP-S-GB15 |
| | REVERSE | M22-XDP-S-GB16 |
| | UP | M22-XDP-S-GB3 |
| | DOWN | M22-XDP-S-GB4 |
| | OFF | M22-XDP-S-GB5 |
| | ON | M22-XDP-S-GB6 |
| | ⊙ | M22-XDP-S-X0 |
| | ① | M22-XDP-S-X1 |
| | + | M22-XDP-S-X4 |
| | − | M22-XDP-S-X5 |
| ① | M22-XDP-S-X7 | |
| Red | — | M22-XDP-R ② |
| | Custom | M22-XDP-R-ETCH ③ |
| | STOP | M22-XDP-R-GB0 |
| | OFF | M22-XDP-R-GB5 |
| Green | — | M22-XDP-G ② |
| | Custom | M22-XDP-G-ETCH ③ |
| | START | M22-XDP-G-GB1 |
| | ON | M22-XDP-G-GB6 |
| | ⊙ | M22-XDP-G-X0 |
| White | — | M22-XDP-W ② |
| | Custom | M22-XDP-W-ETCH ③ |
| Yellow | — | M22-XDP-Y ② |
| | Custom | M22-XDP-Y-ETCH ③ |

M22-DP-G-X



Insertless Mushroom Head Operators

| Bezel | Color | Catalog Number |
|--------|--------|----------------|
| Silver | Black | M22-DP-S-X |
| | Red | M22-DP-R-X |
| | Green | M22-DP-G-X |
| | Yellow | M22-DP-Y-X |
| Black | Black | M22S-DP-S-X |
| | Red | M22S-DP-R-X |
| | Green | M22S-DP-G-X |
| | Yellow | M22S-DP-Y-X |
| Metal | Black | M22M-DP-S-X |
| | Red | M22M-DP-R-X |
| | Green | M22M-DP-G-X |
| | Yellow | M22M-DP-Y-X |

M22-K10



Contact Blocks ④

| Terminal Type | Contact Configuration ⑤ | Catalog Number |
|---------------|-------------------------|----------------|
| Screw | NO | M22-K10 |
| | NO, early-make | M22-K10P |
| | NC | M22-K01 |
| | NC, late-break | M22-K01D |
| Spring-cage | NO | M22-CK10 |
| | NC | M22-CK01 |
| | NC, late-break | M22-CK01D |
| | 2NO | M22-CK20 |
| | 2NC | M22-CK02 |
| | NO-NC | M22-CK11 |
| | NC | M22-FK01 ⑥ |
| | NO | M22-FK10 ⑥ |

M22-FK01



Notes

- ① 35 mm diameter mushroom head button.
- ② Minimum order quantity of (10).
- ③ When ordering, specify inscription per catalog number suffix from the Symbols Library (see Pages V7-T1-123 to V7-T1-130) into the Order Notes. For example, M22-XDP-S-ETCH; Order Notes: Mark with symbol X91, Line item #_.
- ④ For complete listing of available contact blocks, see Accessories, Pages V7-T1-105 to V7-T1-110.
- ⑤ All NC contact blocks are positively driven contact. ⊖
- ⑥ Additional contacts may not be stacked behind M22-F type contact blocks, M22-F can be stacked behind standard M22 contacts only.

1

Product Selection

Non-Illuminated Mushroom Head Pushbuttons, Maintained ^{①②}

M22-DRP-R-K01



M22S-DRP-R-K01



M22M-DRP-R-K01



Complete Devices

| Button Color | Contact Block Configuration ^③ | Silver Bezel Catalog Number | Black Bezel Catalog Number | Metal Bezel Catalog Number |
|--------------|--|-----------------------------|----------------------------|----------------------------|
| Red | NC | M22-DRP-R-K01 | M22S-DRP-R-K01 | M22M-DRP-R-K01 |
| | 2NC | M22-DRP-R-K02 | M22S-DRP-R-K02 | M22M-DRP-R-K02 |
| | 1NO-2NC | M22-DRP-R-K12 | M22S-DRP-R-K12 | M22M-DRP-R-K12 |
| | 1NO-1NC | M22-DRP-R-K11 | M22S-DRP-R-K11 | M22M-DRP-R-K11 |

M22-DRP-G



M22S-DRP-G



M22M-DRP-G



Operators Only

| Button Color | Silver Bezel Catalog Number | Black Bezel Catalog Number | Metal Bezel Catalog Number |
|--------------|-----------------------------|----------------------------|----------------------------|
| Black | M22-DRP-S | M22S-DRP-S | M22M-DRP-S |
| Red | M22-DRP-R | M22S-DRP-R | M22M-DRP-R |
| Green | M22-DRP-G | M22S-DRP-G | M22M-DRP-G |
| Yellow | M22-DRP-Y | M22S-DRP-Y | M22M-DRP-Y |

Notes

- ① 35 mm diameter mushroom head button.
- ② Maintained pushbuttons can be converted in the field to momentary operation by switching the locking ring, which is accessible through the side of the operator body.
- ③ All NC contact blocks are positively driven contact. ⊖

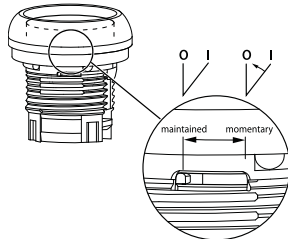

Note: This pilot device features a selectable function switch that enables the device to be set to either maintained or momentary operation.

Non-Illuminated Mushroom Head Pushbuttons, Maintained ^{①②}

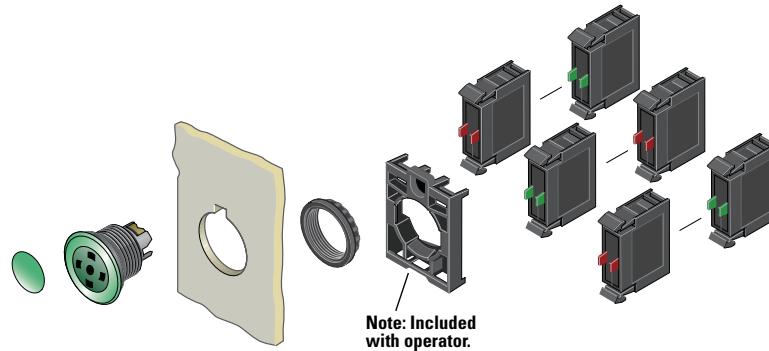

Components

M22-XDP-G



Mushroom Head Plates ^③

| Color | Inscription | Catalog Number |
|--------|-------------|-----------------------------|
| Black | — | M22-XDP-S ^④ |
| | Custom | M22-XDP-S-ETCH ^⑤ |
| | STOP | M22-XDP-S-GB0 |
| | START | M22-XDP-S-GB1 |
| | FORWARD | M22-XDP-S-GB15 |
| | REVERSE | M22-XDP-S-GB16 |
| | UP | M22-XDP-S-GB3 |
| | DOWN | M22-XDP-S-GB4 |
| | OFF | M22-XDP-S-GB5 |
| | ON | M22-XDP-S-GB6 |
| | ⊙ | M22-XDP-S-X0 |
| | Ⓛ | M22-XDP-S-X1 |
| | + | M22-XDP-S-X4 |
| | − | M22-XDP-S-X5 |
| | Ⓛ | M22-XDP-S-X7 |
| Red | — | M22-XDP-R ^④ |
| | Custom | M22-XDP-R-ETCH ^⑤ |
| | STOP | M22-XDP-R-GB0 |
| | OFF | M22-XDP-R-GB5 |
| | ⊙ | M22-XDP-R-X0 |
| Green | — | M22-XDP-G ^④ |
| | Custom | M22-XDP-G-ETCH ^⑤ |
| | START | M22-XDP-G-GB1 |
| | ON | M22-XDP-G-GB6 |
| | ⊙ | M22-XDP-G-X0 |
| White | — | M22-XDP-W ^④ |
| | Custom | M22-XDP-W-ETCH ^⑤ |
| | — | M22-XDP-Y ^④ |
| Yellow | — | M22-XDP-Y ^④ |
| | Custom | M22-XDP-Y-ETCH ^⑤ |

M22-DRP-G-X



Insertless Mushroom Head Operators

| Bezel | Color | Catalog Number |
|--------|--------|----------------|
| Silver | Black | M22-DRP-S-X |
| | Red | M22-DRP-R-X |
| | Green | M22-DRP-G-X |
| | Yellow | M22-DRP-Y-X |
| Black | Black | M22S-DRP-S-X |
| | Red | M22S-DRP-R-X |
| | Green | M22S-DRP-G-X |
| | Yellow | M22S-DRP-Y-X |
| Metal | Black | M22M-DRP-S-X |
| | Red | M22M-DRP-R-X |
| | Green | M22M-DRP-G-X |
| | Yellow | M22M-DRP-Y-X |

M22-K10



Contact Blocks ^③

| Terminal Type | Contact Configuration ^⑥ | Catalog Number |
|---------------|------------------------------------|-----------------------|
| Screw | NO | M22-K10 |
| | NO, early-make | M22-K10P |
| | NC | M22-K01 |
| | NC, late-break | M22-K01D |
| Spring-cage | NO | M22-CK10 |
| | NC | M22-CK01 |
| | NC, late-break | M22-CK01D |
| | 2NO | M22-CK20 |
| | 2NC | M22-CK02 |
| | NO-NC | M22-CK11 |
| | NC | M22-FK01 ^⑦ |
| | NO | M22-FK10 ^⑦ |

M22-FK01



Notes

- ① 35 mm diameter mushroom head button.
- ② Maintained pushbuttons can be converted in the field to momentary operation by switching the locking ring, which is accessible through the side of the operator body.
- ③ For complete listing of available button plates and contact blocks, see Accessories, Pages V7-T1-105 to V7-T1-110.
- ④ Minimum order quantity of (10).
- ⑤ When ordering, specify inscription per catalog number suffix from the Symbols Library (see Pages V7-T1-123 to V7-T1-130) into the Order Notes. For example, M22-XDP-S-ETCH; Order Notes: Mark with symbol X91, Line item #_.
- ⑥ All NC contact blocks are positively driven contact. ⊖
- ⑦ Additional contacts may not be stacked behind M22-F type contact blocks, M22-F can be stacked behind standard M22 contacts only.

1.4

Pushbuttons and Indicating Lights

22.5 mm RMQ-Titan Modular Pushbuttons—M22

1

Double Pushbuttons

Product Description

Eaton's M22 double pushbutton line is perfect for applications such as motor and pump starting, as well as anytime space is limited. In addition to the two buttons that fit in one 22 mm hole is the integrated white indicating light between them. These three operators allow for multiple functions to occur in a single space. Green/red, black/white and black/black color options along with laser engraving allow for further custom applications.

Features

- Flush and extended, as well as color options allow for the perfect combination button
- Integrated indicating light adds even more functionality in one standard 22 mm hole
- Customizable laser engraving on all buttons
- LED offering only for improved brightness quality and up to 100,000 hours of operation
- More than 200,000 mechanical operations
- Capable of communicating via ASi protocol with ASi adapter modules

Protection Type

- IP66
- NEMA 4X, 13

Catalog Number Selection

Catalog Number Selection is for illustrative purposes only and not to be used to create new catalog numbers.

Double Pushbuttons

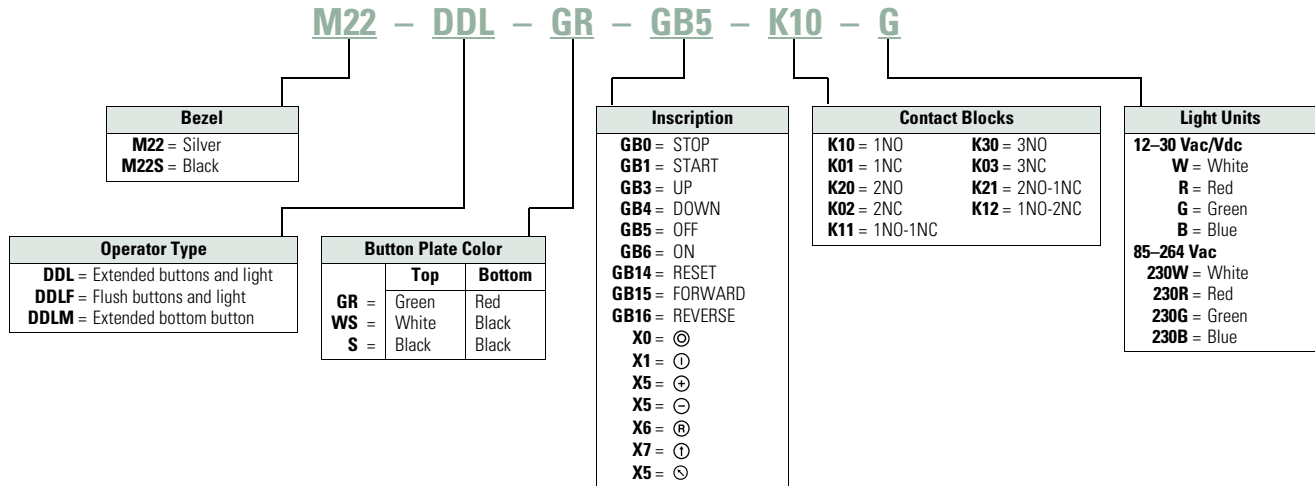



Product Selection

Components

Double Pushbuttons, Extended Pushbuttons and Center Light, Momentary

Operators Only ^①

| | Bezel | Color Top | Bottom | Inscription Top | Bottom | Catalog Number |
|---|--------|-----------|--------|-------------------------|--------|--------------------------------------|
|  | Silver | Green | Red | — | — | M22-DDL-GR |
| | | | | Custom | Custom | M22-DDL-GR-ETCH ^② |
| | | | | ⓪ | Ⓢ | M22-DDL-GR-X1-X0 |
| | | | | START | STOP | M22-DDL-GR-GB1-GB0 |
| | | | | — | — | M22-DDL-WS |
| | | | | Custom | Custom | M22-DDL-WS-ETCH ^② |
| | | White | Black | — | — | M22-DDL-WS-X1-X0 |
| | | | | ⓪ | Ⓢ | M22-DDL-WS-GB1-GB0 |
| | | | | START | STOP | M22-DDL-WS-GB1-GB0 |
| | | | | — | — | M22-DDL-S |
| | | | | Custom | Custom | M22-DDL-S-ETCH ^② |
| | | | | — | — | M22-DDL-S-X4-X5 |
|  | Black | Green | Red | ⓪ | Ⓢ | M22-DDL-S-X7-X7 |
| | | | | — | — | M22S-DDL-GR |
| | | | | Custom | Custom | M22S-DDL-GR-ETCH ^② |
| | | | | ⓪ | Ⓢ | M22S-DDL-GR-X1-X0 |
| | | | | START | STOP | M22S-DDL-GR-GB1-GB0 |
| | | | | — | — | M22S-DDL-WS |
| | | White | Black | — | — | M22S-DDL-WS |
| | | | | Custom | Custom | M22S-DDL-WS-ETCH ^② |
| | | | | ⓪ | Ⓢ | M22S-DDL-WS-X1-X0 |
| | | | | START | STOP | M22S-DDL-WS-GB1-GB0 |
| | | | | — | — | M22S-DDL-S |
| | | | | Custom | Custom | M22S-DDL-S-ETCH ^② |
| Black | Black | — | — | M22S-DDL-S-X4-X5 | | |
| | | + | — | M22S-DDL-S-X4-X5 | | |
| | | ⓪ | Ⓢ | M22S-DDL-S-X7-X7 | | |



Notes

- ① Includes contact block mounting adapter.
- ② When ordering, specify inscription per catalog number suffix from the Symbols Library (see **Pages V7-T1-123 to V7-T1-130**) into the Order Notes. For example, M22-DDL-S-ETCH; Order Notes: Mark with symbol X91, Line item #_.

1



Double Pushbuttons, Flush Top Pushbuttons and Center Light, Momentary

Operators Only ^①

| | Bezel | Color Top | Bottom | Inscription Top | Bottom | Catalog Number |
|--|--------|-----------|--------|-----------------|--------|---------------------------------------|
| M22-DDLF-GR  | Silver | Green | Red | — | — | M22-DDLF-GR |
| | | White | Black | — | — | M22-DDLF-GR-ETCH ^② |
| | Black | White | Black | — | — | M22-DDLF-WS |
| | | Green | Red | ① | ⊙ | M22-DDLF-GR-X1-X0 |
| | | White | Black | ① | ⊙ | M22-DDLF-WS-X1-X0 |
| M22S-DDLF-GR-X1-X0  | Black | Green | Red | — | — | M22S-DDLF-GR |
| | | White | Black | — | — | M22S-DDLF-GR-ETCH ^② |
| | Black | White | Black | — | — | M22S-DDLF-WS |
| | | Green | Red | ① | ⊙ | M22S-DDLF-GR-X1-X0 |
| | | White | Black | ① | ⊙ | M22S-DDLF-WS-X1-X0 |

Double Pushbuttons, Flush Top Pushbutton and Center Light, Extended Bottom Pushbutton, Momentary

Operators Only ^①

| | Bezel | Color Top | Bottom | Inscription Top | Bottom | Catalog Number |
|--|--------|-----------|--------|-----------------|--------|---------------------------------------|
| M22-DDLM-GR  | Silver | Green | Red | — | — | M22-DDLM-GR |
| | | White | Black | — | — | M22-DDLM-GR-ETCH ^② |
| | Black | White | Black | — | — | M22-DDLM-WS |
| | | Green | Red | ① | ⊙ | M22-DDLM-GR-X1-X0 |
| | | White | Black | ① | ⊙ | M22-DDLM-WS-X1-X0 |
| M22S-DDLM-GR-X1-X0  | Black | Green | Red | — | — | M22S-DDLM-GR |
| | | White | Black | — | — | M22S-DDLM-GR-ETCH ^② |
| | Black | White | Black | — | — | M22S-DDLM-WS |
| | | Green | Red | ① | ⊙ | M22S-DDLM-GR-X1-X0 |
| | | White | Black | ① | ⊙ | M22S-DDLM-WS-X1-X0 |

Notes

- ① Includes contact block mounting adapter.
- ② When ordering, specify inscription per catalog number suffix from the Symbols Library (see **Pages V7-T1-123 to V7-T1-130**) into the Order Notes. For example, M22-DDLM-GR-ETCH; Order Notes: Mark with symbol X91, Line item #_.

Double Pushbuttons

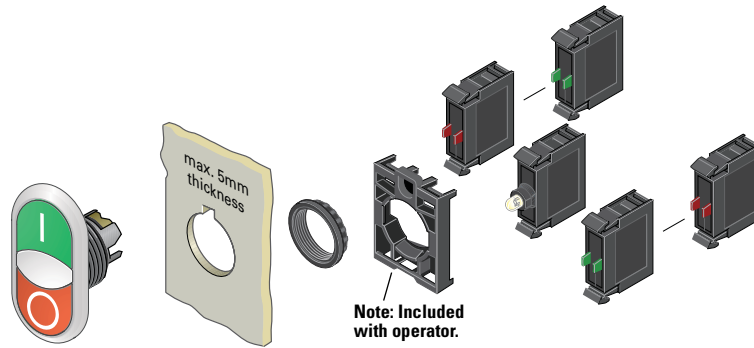

M22-LED-W



Light Units ①

| Terminal Type | LED Color | Light Unit Voltage | Catalog Number |
|---------------|---|--------------------|-----------------------|
| Screw | White | 12–30 | M22-LED-W |
| | Red | Vac/Vdc | M22-LED-R |
| | Green | | M22-LED-G |
| | Blue | | M22-LED-B |
| Screw | White | 85–264 | M22-LED230-W |
| | Red | Vac | M22-LED230-R |
| | Green | | M22-LED230-G |
| | Blue | | M22-LED230-B |
| Spring-cage | White | 12–30 | M22-FLED-W |
| | Red | Vac/Vdc | M22-FLED-R |
| | Green | | M22-FLED-G |
| | Blue | | M22-FLED-B |
| | Red/Green/ Yellow | 24 Vdc | M22-FLED-RG ② |
| | Red, Green, Blue, Yellow, White, Violet, Turquoise | | M22-FLED-RGB ② |

M22-FLED-



M22-K10



Contact Blocks ①

| Terminal Type | Contact Configuration ③ | Catalog Number |
|---------------|-------------------------|-------------------|
| Screw | NO | M22-K10 |
| | NO, early-make | M22-K10P |
| | NC | M22-K01 |
| | NC, late-break | M22-K01D |
| Spring-cage | NO | M22-CK10 |
| | NC | M22-CK01 |
| | NC, late-break | M22-CK01D |
| | 2NO | M22-CK20 |
| | 2NC | M22-CK02 |
| | NO-NC | M22-CK11 |
| | NC | M22-FK01 ④ |
| | NO | M22-FK10 ④ |

M22-FK01



Notes

- ① For complete listing of available light units and contact blocks, see Accessories, **Pages V7-T1-105 to V7-T1-110.**
- ② Please see color input key on **Page V7-T1-108.**
- ③ All NC contact blocks are positively driven contact. ⊖
- ④ Additional contacts may not be stacked behind M22-F type contact blocks, M22-F can be stacked behind standard M22 contacts only.

1

Four-Way Pushbuttons

Product Description

Eaton's M22 four-way pushbutton is a truly unique offering. A four-way pushbutton offers four different buttons mounted in a single 22 mm hole. This is ideal not only for an application with limited space, but also directional applications (when ordered with the four arrow engraving option). Another unique option is the interlocked version, which prevents two opposite buttons from being actuated at the same time.

Features

- Four buttons in one operator allows for increased functionality in limited space
- Optional interlocking option, which prevents two buttons from being actuated at the same time
- Customizable laser engraving on all buttons for directional or other applications
- Capable of communicating via ASi protocol with ASi adapter modules

Protection Type

- IP66

Catalog Number Selection

Catalog Number Selection is for illustrative purposes only and not to be used to create new catalog numbers.

Four-Way Pushbuttons

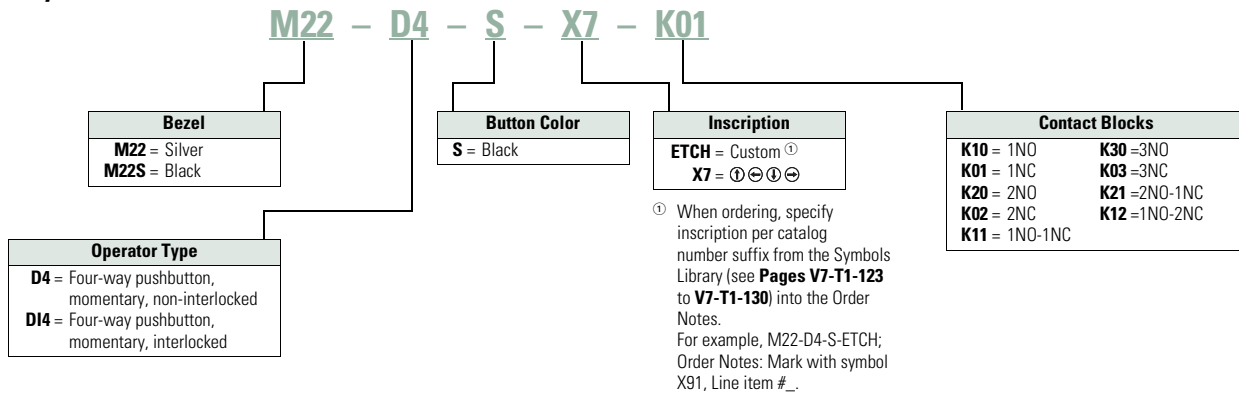

Product Selection

Four-Way Pushbuttons, Momentary

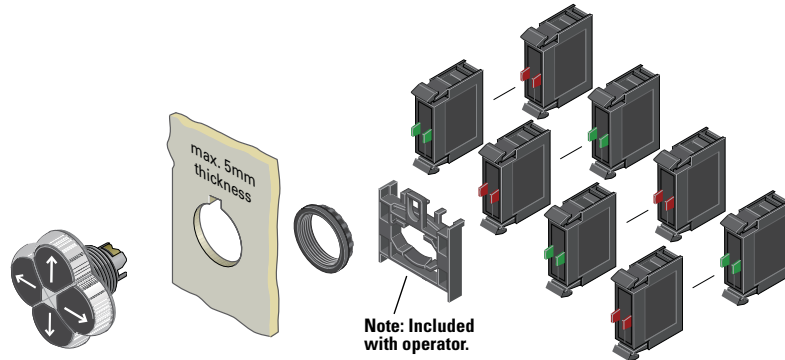

Components

M22-D4-S-X7



Operators Only ^①

| Type | Bezel | Color | Inscription | Catalog Number |
|-----------------|--------|-------|--------------------|-------------------------------------|
| Non-interlocked | Silver | Black | — | M22-D4-S |
| | | | Custom | M22-D4-S-ETCH ^③ |
| | | | Directional arrows | M22-D4-S-X7 |
| | Black | Black | — | M22S-D4-S |
| | | | Custom | M22S-D4-S-ETCH ^③ |
| | | | Directional arrows | M22S-D4-S-X7 |
| Interlocked | Silver | Black | — | M22-DI4-S |
| | | | Custom | M22-DI4-S-ETCH ^③ |
| | | | Directional arrows | M22-DI4-S-X7 |
| | Black | Black | — | M22S-DI4-S |
| | | | Custom | M22S-DI4-S-ETCH ^③ |
| | | | Directional arrows | M22S-DI4-S-X7 |

M22-K10



Contact Blocks ^{①②}

| Terminal Type | Contact Configuration ^④ | Catalog Number |
|---------------|------------------------------------|------------------------------|
| Screw | NO | M22-K10 |
| | NO, early-make | M22-K10P |
| | NC | M22-K01 |
| | NC, late-break | M22-K01D |
| Spring-cage | NO | M22-CK10 |
| | NC | M22-CK01 |
| | NC, late-break | M22-CK01D |
| | 2NO | M22-CK20 |
| | 2NC | M22-CK02 |
| | NO-NC | M22-CK11 |
| | NC | M22-FK01 ^⑤ |
| NO | M22-FK10 ^⑤ | |

M22-FK01



Notes

- ① Includes contact block mounting adapter.
- ② For complete listing of available contact blocks, see Accessories, **Pages V7-T1-105 to V7-T1-110**.
- ③ When ordering, specify inscription per catalog number suffix from the Symbols Library (see **Pages V7-T1-123 to V7-T1-130**) into the Order Notes.
For example, M22-D4-S-ETCH; Order Notes: Mark with symbol X91, Line item #_.
- ④ All NC contact blocks are positively driven contact.
- ⑤ Additional contacts may not be stacked behind M22-F type contact blocks, M22-F can be stacked behind standard M22 contacts only.

1

Joysticks

Product Description

Eaton's M22 joystick line comes in a wide variety of options. From vertical and horizontal two-position switches to the maintained four-position, these operators fit a variety of applications. An additional option, two switch points, allows for eight isolated circuits to be actuated individually on a single operator.

Features

- Available in four-position and two-position
- Two switch point option allows for two contacts in each direction (up to eight total contacts in one operator)
- Capable of communicating via ASi protocol with ASi adapter modules

Protection Type

- IP66

Product Selection

Joysticks

Components

M22-WJ2H



M22M-WJ2H



Operators ^①

| Number of Directions | Switching Position | Silver Bezel Catalog Number | Black Bezel Catalog Number | Metal Bezel Catalog Number |
|-------------------------|--------------------|-----------------------------|----------------------------|----------------------------|
| Two-position horizontal | Momentary | M22-WJ2H | M22S-WJ2H | M22M-WJ2H |
| Two switch points | | M22-WJ2H-2P | M22S-WJ2H-2P | M22M-WJ2H-2P |
| Two-position horizontal | Maintained | M22-WRJ2H | M22S-WRJ2H | M22M-WRJ2H |
| Two-position vertical | Momentary | M22-WJ2V | M22S-WJ2V | M22M-WJ2V |
| Two switch points | | M22-WJ2V-2P | M22S-WJ2V-2P | M22M-WJ2V-2P |
| Two-position vertical | Maintained | M22-WRJ2V | M22S-WRJ2V | M22M-WRJ2V |
| Four-position | Momentary | M22-WJ4 | M22S-WJ4 | M22M-WJ4 |
| Two switch points | | M22-WJ4-2P | M22S-WJ4-2P | M22M-WJ4-2P |
| Four-position | Maintained | M22-WRJ4 | M22S-WRJ4 | M22M-WRJ4 |

Note

^① Includes contact block mounting adapter.

Joysticks

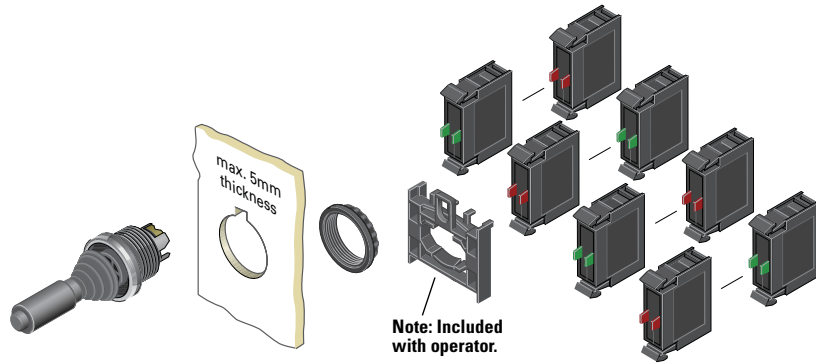

M22-K10



M22-FK01



Contact Blocks ^{①②}

| Terminal Type | Contact Configuration ^③ | Catalog Number |
|---------------|------------------------------------|------------------------------|
| Screw | NO | M22-K10 |
| | NO, early-make | M22-K10P |
| | NC | M22-K01 |
| | NC, late-break | M22-K01D |
| Spring-cage | NO | M22-CK10 |
| | NC | M22-CK01 |
| | NC, late-break | M22-CK01D |
| | 2NO | M22-CK20 |
| | 2NC | M22-CK02 |
| | NO-NC | M22-CK11 |
| | NC | M22-FK01 ^④ |
| | NO | M22-FK10 ^④ |

Joystick with Double Contact

The joystick allows the control of up to four directions of movement on machines. Different variants of the joystick have two/four-positions and other variants have two settings for each position. This allows, for example, two-speed settings for each direction. For this application, a standard normally open contact and an early-make contact are fitted in series. Momentary contact and latching contact versions are available.

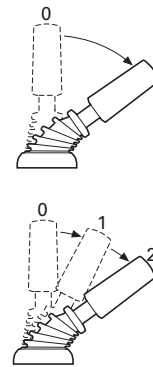

Notes

- ① Includes contact block mounting adapter.
- ② For complete listing of available contact blocks, see Accessories, Pages V7-T1-105 to V7-T1-110.
- ③ All NC contact blocks are positively driven contact. ⊖
- ④ Additional contacts may not be stacked behind M22-F type contact blocks, M22-F can be stacked behind standard M22 contacts only.

Potentiometers

Product Description

Eaton's M22 potentiometers allow for a ready to use operator in a conveniently sized package. M22 potentiometers include the resistive element, instead of just a knob, and a built in legend surrounding the knob. The slim design, with integrated contacts and the range of resistances available, allows for a quick install.

Features

- Scale markings on the knob allows the operator to be used without an additional legend plate
- Oversized knob option available
- Slim design allows for space saving and simple wiring and installation

Protection Type

- IP66
- NEMA 4X, 13

Product Selection

Potentiometers

M22-R10K



M22M-R10K



Complete Devices

| Bezel | Resistance Rk | Catalog Number |
|--------|---------------|----------------|
| Silver | 1 | M22-R1K |
| | 4.7 | M22-R4K7 |
| | 10 | M22-R10K |
| | 47 | M22-R47K |
| | 100 | M22-R100K |
| Black | 470 | M22-R470K |
| | 1 | M22S-R1K |
| | 4.7 | M22S-R4K7 |
| | 10 | M22S-R10K |
| | 47 | M22S-R47K |
| Metal | 100 | M22S-R100K |
| | 470 | M22S-R470K |
| | 1 | M22M-R1K |
| | 4.7 | M22M-R4K7 |
| | 10 | M22M-R10K |
| | 47 | M22M-R47K |
| | 100 | M22M-R100K |
| | 470 | M22M-R470K |

Oversized Knob

| | | |
|--------|-----|---------------|
| Silver | 1 | M22-R1K-RH |
| | 4.7 | M22-R4K7-RH |
| | 10 | M22-R10K-RH |
| | 47 | M22-R47K-RH |
| | 100 | M22-R100K-RH |
| Black | 470 | M22-R470K-RH |
| | 1 | M22S-R1K-RH |
| | 4.7 | M22S-R4K7-RH |
| | 10 | M22S-R10K-RH |
| | 47 | M22S-R47K-RH |
| Metal | 100 | M22S-R100K-RH |
| | 470 | M22S-R470K-RH |
| | 1 | M22M-R1K-RH |
| | 4.7 | M22M-R4K7-RH |
| | 10 | M22M-R10K-RH |
| | 47 | M22M-R47K-RH |
| | 100 | M22M-R100K-RH |
| | 470 | M22M-R470K-RH |

Acoustic Devices

Product Description

Eaton's M22 acoustic devices are a simple and aesthetic way to add a buzzer or indicator to any application. Fitting in the same 22 mm hole, these devices can be ordered in continuous or pulsed tone and with or without the IP40 enclosure.

Features

- Continuous or pulsed tone available
- 83 dB / 10 cm decibel rating
- Slim design allows for space saving and simple wiring and installation

Protection Type

- IP40
- NEMA 12

Product Selection

Acoustic Devices

M22-AMC-XAM



Complete Devices

| Description | Decibel Rating | Catalog Number |
|---|----------------|----------------|
| Indicator with buzzer, black continuous tone, 18–30 Vac/Vdc | 83 dB/10 cm | M22-AMC-XAM |
| Indicator with buzzer, black pulsed tone, 18–30 Vac/Vdc | 83 dB/10 cm | M22-AMC-XAMP |

M22-XAM



Buzzers

| Description | Decibel Rating | Catalog Number |
|---|----------------|----------------|
| Indicator without buzzer, black | 83 dB/10 cm | M22-AMC |
| Buzzer only, continuous tone, 18–30 Vac/Vdc | 83 dB/10 cm | M22-XAM |
| Buzzer only, pulsed tone, 18–30 Vac/Vdc | 83 dB/10 cm | M22-XAMP |

Through-the-Door Operators

Product Description

Eaton’s M22 through-the-door operators use the same familiar flush pushbutton look with the addition of a cut-to-length rod that allows for a simple reset operator.

Features

- Customizable laser engraving on all buttons
- More than five million mechanical operations
- Pushrod can be cut to length

Protection Type

- IP67, IP69K
- NEMA 4X, 13

Product Selection

Through-the-Door Operators ^①

M22-DZ-B-X6



Complete Devices

| Color | Inscription | Catalog Number |
|-------|-------------|----------------|
| Blue | — | M22-DZ-B |
| | RESET | M22-DZ-B-GB14 |
| | Ⓡ | M22-DZ-B-X6 |
| Red | — | M22-DZ-R |
| | Ⓢ | M22-DZ-R-X0 |
| | STOP | M22-DZ-R-GB0 |

M22-DZ-X



Buttonless Operator

| Bezel | Catalog Number |
|--------|----------------|
| Silver | M22-DZ-X |
| Metal | M22M-DZ-X |

M22-XD-B



Button Plates ^②

| Color | Inscription | Catalog Number |
|-------|-------------|-----------------------|
| Blue | — | M22-XD-B ^③ |
| | RESET | M22-XD-B-GB14 |
| | Ⓡ | M22-XD-B-X6 |
| Red | — | M22-XD-R ^③ |
| | Ⓢ | M22-XD-R-X0 |
| | STOP | M22-XD-R-GB0 |

Bulkhead Interfaces

Product Description

Eaton’s M22 bulkhead interfaces are another unique offering in the M22 line. This device allows for a secure connection to any USB or RJ45 connected device within an enclosure or panel. With an IP65 rating when closed, these devices are not only convenient, but robust and reliable.

Features

- Convenient and safe way to make a data connection to inside of the panel without opening the panel door

Protection Type

- IP65 when closed, IP20 when connected

Product Selection

Bulkhead Interfaces

M22-USB-SA



USB Socket ^{④⑤}

Used for USB connection plug IP65 when closed, IP20 when connected.

| Bezel | Catalog Number |
|--------|----------------|
| Silver | M22-USB-SA |

M22-RJ45-SA



RJ45 Socket ^⑥

Used for RJ45 Ethernet connection IP65 when closed, IP20 when connected.

| Bezel | Catalog Number |
|--------|----------------|
| Silver | M22-RJ45-SA |

Notes

- ① The pushrod is 3.24 in long and can be cut to length.
- ② Any combination of plate color and inscription is available.
- ③ Minimum order quantity of (10).
- ④ USB interface is complete with 2-ft-long USB cable.
- ⑤ USB interface is UL Listed, CSA approved and USB 3.0.
- ⑥ RJ45 interface is an eight-wire connector.

ASi Adapter Modules

Product Description

Eaton's M22 ASi adapter modules add functionality to every operator in the M22 line. These devices can be connected to any operator that uses contact blocks or LED units. The simple snap-on design allows for a quick integration of an entire application of operators to a communicating network.

Features

- Allows compatible operators to communicate on an ASi network
- Not only can the status of a contact block be read, but LEDs can be illuminated by an ASi adapter
- ASi adapters simply clip on to the back of the contact blocks and LEDs
- Insulation displacement connectors allow for installation of adapters without any tools
- Two integrated LEDs indicate status of communications

Protection Type

- IP20

Product Selection

ASi Adapter Modules

M22-ASi



Complete Devices

| Description | Catalog Number |
|---|-------------------|
| ASi adapter module | M22-ASi |
| ASi adapter module for base mounting | M22-ASi-C |
| ASi adapter module for E-stop | M22-ASi-S |
| ASi adapter module for E-stop base mounting | M22-ASi-CS |

Palm Switches

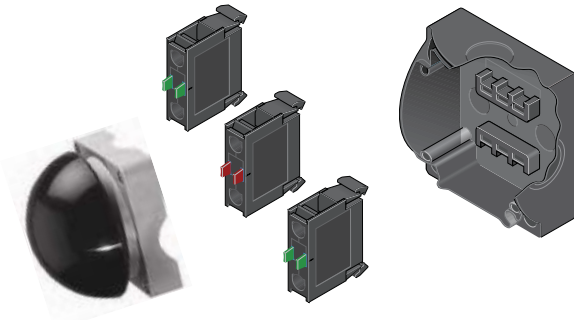

Product Description

Eaton’s M22 palm switches are an oversized button that mount directly to an enclosure base. This allows for a standalone button that can be mounted anywhere. The enclosure uses base-mounted contact blocks, which allows for quick wiring and mounting. The palm switches come in momentary or maintained versions. As with other M22 operators, the palm switches are available as complete devices, including the enclosure and contact blocks or as modular components.

Features

- Oversized operator in black, red and yellow color options
- Button integrated directly into an enclosure
- Base mounting contact blocks allow for simple wiring and installation
- More than one million mechanical operations on momentary and 100,000 on maintained operators

Protection Type

- IP67, IP69K
- NEMA 4X, 13

Catalog Number Selection

Catalog Number Selection is for illustrative purposes only and not to be used to create new catalog numbers.

Palm Switches, Type 4X/13 Enclosure

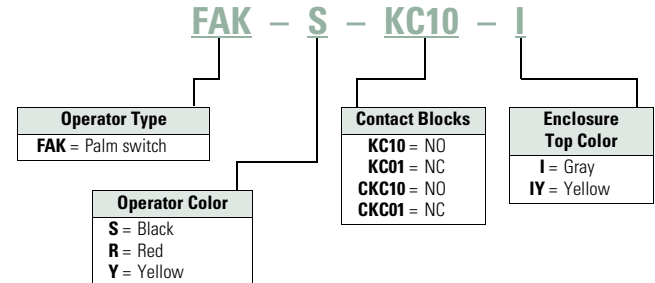

Product Selection

Complete Devices

Operator, Base and Contact Blocks ①

| Button Color | Contact Block Configuration ② | Catalog Number |
|------------------------|-------------------------------|------------------------|
| FAK-S-KC11-I | | |
| Momentary | | |
| Black | 1NO-1NC | FAK-S-KC11-I |
| Red | 1NO-1NC | FAK-R-KC11-I |
| Yellow | 1NO-1NC | FAK-Y-KC11-I |
| FAK-R-V-KC01-IY | | |
| Maintained | | |
| Red | NC | FAK-R-V-KC01-IY |
| | 2NC | FAK-R-V-KC02-IY |
| | 1NO-2NC | FAK-R-V-KC12-IY |
| | 1NO-1NC | FAK-R-V-KC11-IY |

Notes

① For complete listing of available contact blocks, see Accessories, Pages V7-T1-105 to V7-T1-110.

② All NC contact blocks are positively driven contact. ⊖

Components

FAK-S



Operators Only

| Type | Button Color | Catalog Number |
|------------|--------------|------------------|
| Momentary | Black | FAK-S |
| | Red | FAK-R |
| | Yellow | FAK-Y |
| Maintained | Red | FAK-R-V-Y |

FAK-IU



Palm Switch Enclosure Base

Catalog Number

FAK-IU

M22-K10

Contact Blocks ^①

| Terminal Type | Contact Configuration ^② | Catalog Number |
|---------------|------------------------------------|------------------------------|
| Screw | NO | M22-KC10 |
| | NC | M22-KC01 |
| Spring-cage | NO | M22-CKC10 |
| | NC | M22-CKC01 |
| | NC | M22-FK01 ^③ |
| | NO | M22-FK10 ^③ |

M22-FK01



Notes

^① For complete listing of available contact blocks, see Accessories, **Pages V7-T1-105 to V7-T1-110**.

^② All NC contact blocks are positively driven contact. 

^③ Additional contacts may not be stacked behind M22-F type contact blocks, M22-F can be stacked behind standard M22 contacts only.

Accessories

M22-XD-S



M22-XDH-R



M22-XDP-G



Button Plates

| Color | Inscription | Catalog Number Flush Pushbutton | Catalog Number Extended Pushbutton | Catalog Number Mushroom Head Button |
|--|-------------|------------------------------------|---------------------------------------|--|
| Black | — | M22-XD-S | M22-XDH-S | M22-XDP-S |
| White | — | M22-XD-W | M22-XDH-W | M22-XDP-W |
| Red | — | M22-XD-R | M22-XDH-R | M22-XDP-R |
| Green | — | M22-XD-G | M22-XDH-G | M22-XDP-G |
| Yellow | — | M22-XD-Y | M22-XDH-Y | M22-XDP-Y |
| Blue | — | M22-XD-B | M22-XDH-B | — |
| Black, white, red, green, yellow, blue | — | M22-XD-SWRGYB | M22-XDH-SWRGYB | — |
| Black, red, green | — | M22-XD-SRG | M22-XDH-SRG | — |
| Black | Custom | M22-XD-S-ETCH | M22-XDH-S-ETCH | M22-XDP-S-ETCH |
| White | Custom | M22-XD-W-ETCH | M22-XDH-W-ETCH | M22-XDP-W-ETCH |
| Red | Custom | M22-XD-R-ETCH | M22-XDH-R-ETCH | M22-XDP-R-ETCH |
| Green | Custom | M22-XD-G-ETCH | M22-XDH-G-ETCH | M22-XDP-G-ETCH |
| Yellow | Custom | M22-XD-Y-ETCH | M22-XDH-Y-ETCH | M22-XDP-Y-ETCH |
| Blue | Custom | M22-XD-B-ETCH | M22-XDH-B-ETCH | — |
| Black | STOP | M22-XD-S-GB0 | M22-XDH-S-GB0 | M22-XDP-S-GB0 |
| Red | STOP | M22-XD-R-GB0 | M22-XDH-R-GB0 | M22-XDP-R-GB0 |
| Black | START | M22-XD-S-GB1 | M22-XDH-S-GB1 | M22-XDP-S-GB1 |
| White | START | M22-XD-W-GB1 | M22-XDH-W-GB1 | — |
| Green | START | M22-XD-G-GB1 | M22-XDH-G-GB1 | M22-XDP-G-GB1 |
| Black | CLOSE | M22-XD-S-GB2 | M22-XDH-S-GB2 | — |
| Black | UP | M22-XD-S-GB3 | M22-XDH-S-GB3 | M22-XDP-S-GB3 |
| Black | DOWN | M22-XD-S-GB4 | M22-XDH-S-GB4 | M22-XDP-S-GB4 |
| Black | OFF | M22-XD-S-GB5 | M22-XDH-S-GB5 | M22-XDP-S-GB5 |
| Red | OFF | M22-XD-R-GB5 | M22-XDH-R-GB5 | M22-XDP-R-GB5 |
| Black | ON | M22-XD-S-GB6 | M22-XDH-S-GB6 | M22-XDP-S-GB6 |
| Green | ON | M22-XD-G-GB6 | M22-XDH-G-GB6 | M22-XDP-G-GB6 |
| Black | TEST | M22-XD-S-GB9 | M22-XDH-S-GB9 | — |
| Blue | RESET | M22-XD-B-GB14 | M22-XDH-B-GB14 | — |
| Black | FORWARD | M22-XD-S-GB15 | M22-XDH-S-GB15 | M22-XDP-S-GB15 |
| Black | REVERSE | M22-XD-S-GB16 | M22-XDH-S-GB16 | M22-XDP-S-GB16 |
| Black | RAISE | M22-XD-S-GB17 | M22-XDH-S-GB17 | — |
| Black | LOWER | M22-XD-S-GB18 | M22-XDH-S-GB18 | — |
| Black | ⊙ | M22-XD-S-X0 | M22-XDH-S-X0 | M22-XDP-S-X0 |
| Red | ⊙ | M22-XD-R-X0 | M22-XDH-R-X0 | M22-XDP-R-X0 |
| Green | ⊙ | — | — | M22-XDP-G-X0 |
| Black | ① | M22-XD-S-X1 | M22-XDH-S-X1 | M22-XDP-S-X1 |
| White | ① | M22-XD-W-X1 | M22-XDH-W-X1 | — |
| Green | ① | M22-XD-G-X1 | M22-XDH-G-X1 | M22-XDP-G-X1 |
| Black | ② | M22-XD-S-X2 | M22-XDH-S-X2 | — |
| Green | ② | M22-XD-G-X2 | M22-XDH-G-X2 | — |
| Black | + | M22-XD-S-X4 | M22-XDH-S-X4 | M22-XDP-S-X4 |
| Black | − | M22-XD-S-X5 | M22-XDH-S-X5 | M22-XDP-S-X5 |
| Blue | Ⓜ | M22-XD-B-X6 | M22-XDH-B-X6 | — |
| Black | ① | M22-XD-S-X7 | M22-XDH-S-X7 | M22-XDP-S-X7 |
| Black | ① | M22-XD-S-X8 | M22-XDH-S-X8 | — |
| Black | See ① below | M22-XD-S-X9 | M22-XDH-S-X9 | — |
| Black | See ① below | M22-XD-S-X10 | M22-XDH-S-X10 | — |
| Black | See ① below | M22-XD-S-X11 | M22-XDH-S-X11 | — |
| Black | See ① below | M22-XD-S-X12 | M22-XDH-S-X12 | — |
| Black | See ① below | M22-XD-S-X13 | M22-XDH-S-X13 | — |
| Black | See ① below | M22-XD-S-X14 | M22-XDH-S-X14 | — |
| Black | See ① below | M22-XD-S-X15 | M22-XDH-S-X15 | — |
| Black | See ① below | M22-XD-S-X16 | M22-XDH-S-X16 | — |
| Black | See ① below | M22-XD-S-X17 | M22-XDH-S-X17 | — |

Note

① Refer to the Symbols Library, (see Pages V7-T1-123 to V7-T1-130), for symbol image.

1

M22-XDLH-W





M22-XDL-G



Button Lenses

| Color | Inscription | Catalog Number Flush | Catalog Number Extended | Color | Inscription | Catalog Number Flush | Catalog Number Extended |
|--------|-------------|-----------------------|-------------------------|-------|-------------|-----------------------|-------------------------|
| White | — | M22-XDL-W | M22-XDLH-W | Blue | Custom | M22-XDL-B-ETCH | M22-XDLH-B-ETCH |
| Red | — | M22-XDL-R | M22-XDLH-R | Red | STOP | M22-XDL-R-GB0 | M22-XDLH-R-GB0 |
| Green | — | M22-XDL-G | M22-XDLH-G | Green | START | M22-XDL-G-GB1 | M22-XDLH-G-GB1 |
| Yellow | — | M22-XDL-Y | M22-XDLH-Y | Red | OFF | M22-XDL-R-GB5 | M22-XDLH-R-GB5 |
| Blue | — | M22-XDL-B | M22-XDLH-B | Green | ON | M22-XDL-G-GB6 | M22-XDLH-G-GB6 |
| White | Custom | M22-XDL-W-ETCH | M22-XDLH-W-ETCH | Blue | RESET | M22-XDL-B-GB14 | M22-XDLH-B-GB14 |
| Red | Custom | M22-XDL-R-ETCH | M22-XDLH-R-ETCH | Red | Ⓢ | M22-XDL-R-X0 | M22-XDLH-R-X0 |
| Green | Custom | M22-XDL-G-ETCH | M22-XDLH-G-ETCH | Green | Ⓛ | M22-XDL-G-X1 | M22-XDLH-G-X1 |
| Yellow | Custom | M22-XDL-Y-ETCH | M22-XDLH-Y-ETCH | Blue | Ⓜ | M22-XDL-B-X6 | M22-XDLH-B-X6 |

Mounting Adapters

| Description | Catalog Number |
|--|----------------|
| M22-A  Contact block mounting adapter | M22-A |
| M22-A4  Contact block mounting adapter, four-position (for use with four-way pushbuttons, joysticks and four-position selector switches only). | M22-A4 |
| M22-LS  Allows mounting of M22 pushbuttons to LS-Titan limit switch bodies (for the full LS-Titan catalog section, see PG08301004E). | M22-LS |

Contact Blocks

M22-K10



M22-FK01



| Mounting Location | Terminal Type | Contact Configuration ① | Package Qty. | Catalog Number | | |
|-------------------|---------------|-------------------------|--------------|----------------------|-----|----------------------|
| Front | Screw | NO | 1 | M22-K10 | | |
| | | NO | 25 | M22-K10-B25 | | |
| | | NO | 100 | M22-K10-B100 | | |
| | | NO, early-make | 1 | M22-K10P | | |
| | | NC | 1 | M22-K01 | | |
| | | NC | 25 | M22-K01-B25 | | |
| | | NC | 100 | M22-K01-B100 | | |
| | | NC, late-break | 1 | M22-K01D | | |
| | | SMCB, NC | 1 | M22-K01SMC10 | | |
| | | SMCB, 2NC | 1 | M22-K02SMC10 | | |
| | | Base | | NO | 1 | M22-KC10 |
| | | | | NO | 25 | M22-KC10-B25 |
| | | | | NO | 100 | M22-KC10-B100 |
| | | | | NC | 1 | M22-KC01 |
| | | | | NC | 25 | M22-KC01-B25 |
| | | | | NC | 100 | M22-KC01-B100 |
| SMCB, NC | 1 | | | M22-KC01SMC10 | | |
| SMCB, 2NC | 1 | | | M22-KC02SMC10 | | |
| Front | Spring-cage | | | NO | 1 | M22-CK10 |
| | | | | NC | 1 | M22-CK01 |
| | | NC, late-break | 1 | M22-CK01D | | |
| | | 2NO ② | 1 | M22-CK20 | | |
| | | 2NC ② | 1 | M22-CK02 | | |
| | | NO-NC ② | 1 | M22-CK11 | | |
| | | NC | 20 | M22-FK01 ③ | | |
| | | NO | 20 | M22-FK10 ③ | | |
| | | Base | | NO | 1 | M22-CKC10 |
| | | | | NC | 1 | M22-CKC01 |

Notes

① All NC contact blocks are positively driven contact. Ⓢ

② Not stackable.

③ Additional contacts may not be stacked behind M22-F type contact blocks, M22-F can be stacked behind standard M22 contacts only.

M22-LED-W



M22-FLED- _



Light Units

| Terminal Type | Mounting Location | LED Color | Light Unit Voltage | Catalog Number | | |
|---------------|-------------------|--|--------------------|---------------------------|----------------|-------------|
| Screw | Front | White | 12–30 Vac/Vdc | M22-LED-W | | |
| | | Red | | M22-LED-R | | |
| | | Green | | M22-LED-G | | |
| | | Blue | | M22-LED-B | | |
| | | White | 85–264 Vac | M22-LED230-W | | |
| | | Red | | M22-LED230-R | | |
| | | Green | | M22-LED230-G | | |
| | | Blue | | M22-LED230-B | | |
| | | White | 207–264 Vac | M22-LED230H-W | | |
| | | Red | | M22-LED230H-R | | |
| | | Green | | M22-LED230H-G | | |
| | | Blue | | M22-LED230H-B | | |
| | | Base | White | 12–30 Vac/Vdc | M22-LEDC-W | |
| | | | | | Red | M22-LEDC-R |
| | | | | | Green | M22-LEDC-G |
| | | | | | Blue | M22-LEDC-B |
| | White | | 85–264 Vac | M22-LEDC230-W | | |
| | | | | Red | M22-LEDC230-R | |
| | | | | Green | M22-LEDC230-G | |
| | | | | Blue | M22-LEDC230-B | |
| White | 207–264 Vac | | M22-LEDC230H-W | | | |
| | | | Red | M22-LEDC230H-R | | |
| | | | Green | M22-LEDC230H-G | | |
| | | | Blue | M22-LEDC230H-B | | |
| Spring-cage | Front | | White | 12–30 Vac/Vdc | M22-CLED-W | |
| | | | Red | | M22-CLED-R | |
| | | Green | M22-CLED-G | | | |
| | | Blue | M22-CLED-B | | | |
| | | White | 85–264 Vac | M22-CLED230-W | | |
| | | Red | | M22-CLED230-R | | |
| | | Green | | M22-CLED230-G | | |
| | | Blue | | M22-CLED230-B | | |
| | | Base | White | 12–30 Vac/Vdc | M22-CLEDC-W | |
| | | | | | Red | M22-CLEDC-R |
| | | | | | Green | M22-CLEDC-G |
| | | | | | Blue | M22-CLEDC-B |
| | White | | 85–264 Vac | M22-CLEDC230-W | | |
| | | | | Red | M22-CLEDC230-R | |
| | Front | White | 12–30 Vac/Vdc | M22-FLED-W | | |
| | | | | Red | M22-FLED-R | |
| | | | | Green | M22-FLED-G | |
| | | | | Blue | M22-FLED-B | |
| | | Red/Green/Yellow | 24 Vdc | M22-FLED-RG ^① | | |
| | | Red, Green, Blue, Yellow, White, Violet, Turquoise | | M22-FLED-RGB ^① | | |

M22-XLED60



LED Resistor and Test Elements

| Terminal Type | Mounting Location | Element Type | Voltage | Catalog Number |
|---------------|-------------------|------------------------|----------------|----------------|
| Screw | Front | Resistor ^{②③} | 42–60 Vac/Vdc | M22-XLED60 |
| | | | 220 Vdc | M22-XLED220 |
| | | Test | 12–240 Vac/Vdc | M22-XLED-T |
| | | | 85–264 Vac | M22-XLED230-T |



Notes

- ① Please see color input key on **Page V7-T1-108**.
- ② Resistor units to be used with 12–30V light units.
- ③ Refer to **IL04716002E** for use of resistor elements in series for higher DC voltage.

Multi-Color LED Input Guide

| Catalog Number | | Terminal Color | | | |
|---------------------|-----------|----------------|----------|----------|-----------|
| | | X1 +R | X2 +G | X3 +B | X4 GND |
| M22-FLED-RG | Red | ■ | — | — | ■ |
| | Green | — | ■ | — | ■ |
| | Yellow | ■ | ■ | — | ■ |
| M22-FLED-RGB | Red | ■ | — | — | ■ |
| | Green | — | ■ | — | ■ |
| | Yellow | ■ | ■ | — | ■ |
| | White | ■ | ■ | ■ | ■ |
| | Blue | — | — | ■ | ■ |
| | Violet | ■ | — | ■ | ■ |
| | Turquoise | — | ■ | ■ | ■ |

Legend Plate Holders and Inserts, Pushbuttons and Double Pushbuttons ^①

| | Description | Inscription | Catalog Number |
|---|--|--------------------|----------------------------------|
| M22S-ST-X  | Legend plate holder, without legend plate insert, for pushbuttons | — | M22S-ST-X |
| | Legend plate holder, without legend plate insert, for double pushbuttons | — | M22S-STDD-X |
| M22-XST-GB0  | Legend plate insert | — | M22-XST |
| | | Custom | M22-XST-ETCH ^② |
| | | STOP | M22-XST-GB0 |
| | | START | M22-XST-GB1 |
| | | OFF | M22-XST-GB5 |
| | | ON | M22-XST-GB6 |
| | | RUN | M22-XST-GB7 |
| | | FAULT | M22-XST-GB8 |
| | | OFF ON | M22-XST-GB10 |
| | | MAN. AUTO | M22-XST-GB11 |
| | | MAN. O AUTO | M22-XST-GB12 |
| | | HAND AUTO | M22-XST-D11 |
| | | HAND O AUTO | M22-XST-D12 |
| | | 1 | M22-XST-X52 |
| | | 2 | M22-XST-X53 |
| | O I | M22-XST-X88 | |
| | O - I | M22-XST-X89 | |
| | I O II | M22-XST-X93 | |

Notes

^① Legend plates are IP66 and NEMA 4X/13.

^② When ordering, specify inscription per catalog number suffix from the Symbols Library (see **Pages V7-T1-123 to V7-T1-130**) into the Order Notes.







For example, M22-XD-S-ETCH; Order Notes: Mark with symbol X91, Line item # __.

Example

To order a legend plate for a pushbutton with non-standard markings (FORWARD):

1. Select legend plate holder—M22S-ST-X.
2. Select legend plate insert—M22-XST-ETCH.
3. Select FORWARD from the Symbols Library, **Pages V7-T1-123 to V7-T1-130**, identified by GB15 suffix.
4. Indicate on the order form in the order notes—suffix GB15, line item # __.



Legend Plates, Complete ①

| | Description | Inscription | Catalog Number | | |
|---|--|--|---|----------------------------|-----------------------|
| M22S-ST-GB0  | For use with pushbuttons and indicating lights | Legend plate holder with insert | M22S-ST-GB0 | | |
| | | | STOP | M22S-ST-GB1 | |
| | | | START | M22S-ST-GB5 | |
| | | | OFF | M22S-ST-GB6 | |
| | | | ON | M22S-ST-GB7 | |
| | | | RUN | M22S-ST-GB8 | |
| | | | FAULT | M22S-ST-GB8 | |
| | | | 1 | M22S-ST-X52 | |
| | | | 2 | M22S-ST-X53 | |
| | | Selector switches | | OFF ON | M22S-ST-GB10 |
| | | | | MAN. AUTO | M22S-ST-GB11 |
| | | | | MAN. 0 AUTO | M22S-ST-GB12 |
| | | | | HAND AUTO | M22S-ST-D11 |
| | | | | HAND 0 AUTO | M22S-ST-D12 |
| | O I | | M22S-ST-X88 | | |
| | O - I | | M22S-ST-X89 | | |
| | I O II | | M22S-ST-X93 | | |
| M22-XZK  | Emergency-stop operators | | Rectangular yellow legend plate | M22-XZK | |
| | | | | Custom | M22-XZK-ETCH ② |
| | | | EMERGENCY-STOP | M22-XZK-GB99 | |
| M22-XYK  | Square yellow legend plate | — | M22-XYK | | |
| | | | — | M22-XYK-ETCH ② | |
| | | | EMERGENCY-STOP four-language | M22-XYK1 | |
| | | | EMERGENCY-STOP (top and bottom) | M22-XYK5 | |
| | | M22-XAK  | Round yellow legend plate, 90 mm | — | M22-XAK |
| | Custom | | | M22-XAK-ETCH ② | |
| | EMERGENCY-STOP four-language | | | M22-XAK1 | |
| | EMERGENCY-STOP (top and bottom) | | | M22-XAK5 | |
| M22-XBK1  | Round yellow legend plate, 60 mm | | | — | M22-XBK |
| | | | Custom | M22-XBK-ETCH ② | |
| | | | EMERGENCY-STOP four-language | M22-XBK1 | |
| | | | EMERGENCY-STOP (top and bottom) | M22-XBK5 | |
| | | M22-XCK1  | Four-way pushbutton, joystick and four-position selector switches | Silver square legend plate | M22-XCK |
| | Custom | | | M22-XCK-ETCH ② | |
| | Four directional arrows | | | M22-XCK1 | |
| | 0-1-0-2-0-3-0-4 | | | M22-XCK2 | |
| | Two directional arrows | | | M22-XCK3 | |

Notes

- ① Legend plates are IP66 and NEMA 4X/13.
- ② When ordering, specify inscription per catalog number suffix from the Symbols Library (see **Pages V7-T1-123 to V7-T1-130**) into the Order Notes. For example, M22-XD-S-ETCH; Order Notes: Mark with symbol X91, Line item #_.

Surface Mounting Enclosures ^①

| Description | Catalog Number |
|---|-------------------|
| M22-IY1-PG Yellow top, black base for emergency-stop operators | M22-IY1-PG |
|  | |
| M22-IY-PG | |
| One-element enclosure | M22-I1-PG |
| Two-element enclosure | M22-I2-PG |
| Three-element enclosure | M22-I3-PG |
| Four-element enclosure | M22-I4-PG |
| Six-element enclosure | M22-I6-PG |
| M20 connecting screw | M22-XI |
| M20 cord grip | V-M20 |
|  | |





Flush Mounting Plates, Aluminum

| Finish | Rating | Catalog Number |
|---|--------|----------------|
| One Hole | | |
| Yellow paint for emergency-stop operators | — | M22-EY1 |
|  | | |
| Gray anodized | IP65 | M22-E1 |
| Two Holes | | |
| Gray anodized | IP65 | M22-E2 |
| Three Holes | | |
| Gray anodized | IP65 | M22-E3 |
| Four Holes | | |
| Gray anodized | IP65 | M22-E4 |
| Five Holes | | |
| Gray anodized | IP65 | M22-E5 |
| Six Holes | | |
| Anodized | IP40 | M22-E6 |

Shrouds, Plastic

| Description | Rating | Catalog Number |
|---|--------|----------------|
| M22-H1 | | |
|  | | |
| One-element | IP55 | M22-H1 |
| Two-element | IP55 | M22-H2 |
| Three-element | IP55 | M22-H3 |
| Four-element | IP40 | M22-H4 |
| Five-element | IP40 | M22-H5 |
| Six-element | IP40 | M22-H6 |
| Mounting plate | — | M22-XE5 |
| Plaster keys for flush mounting | — | M22-UPE |





Selector Switch Accessories

| Description | Catalog Number |
|---|-----------------|
| M22-XW Plunger bridge ^② | M22-XW |
|  | |
| M22-XWS Key cover | M22-XWS |
|  | |
| M22-XC-R Key withdraw adapter ^③ | M22-XC-R |
|  | |
| M22-XC-Y Coding adapter | M22-XC-Y |
|  | |
| M22-XGWK Guard ring | M22-XGWK |
|  | |

Notes

- ① Requires use of base mounted contact blocks.
- ② Plunger needed to actuate center-mounted contact blocks. Used for non-illuminated three-position selector switches only.
- ③ Enables a keyed selector switch to be set to user-selected key withdraw position.

Emergency Stop Operator Accessories

| | Description | Voltage | Catalog Number |
|--|-------------------|------------|------------------------|
|  | Yellow guard ring | — | M22-XGPV |
|  | Gray guard ring | — | M22G-XGPV |
|  | Rectangular guard | — | M22-MGTA |
|  | Sealing shroud | — | M22-PL-PV |
|  | Illuminated ring | 24 Vac/Vdc | M22-XPV60-Y-24 |
| | | 120 Vac | M22-XPV60-Y-120 |
| | | 230 Vac | M22-XPV60-Y-230 |

Blanking Plugs

| | Color | Catalog Number |
|---|-------|----------------|
|  | Gray | M22-B |
| | Black | M22S-B |

Notching Tool

Punching tool used to produce the cutout for the anti-rotation tab as defined in IEC/EN 60947-5-1.

| Description | Unit | Article Number | Catalog Number |
|---|------|----------------|----------------|
| St 37 sheet steel: Max. 3 mm thickness | 1 | 028144 | M22-NT |
| Stainless steel: Max. 1.5 mm thickness | | | |

Mounting Accessories

| | Description | Catalog Number |
|--|-----------------------------------|-----------------|
|  | Telescopic clip with top-hat rail | M22-TC |
| | Telescopic clip | M22-TA |
| | Telescopic clip extension | M22-TCV |
|  | DIN rail mounting adapter | M22-IVS |
|  | Mounting ring | M22-GR |
|  | Mounting ring tool | M22-MS |
|  | Adapter ring set for 30 mm holes | M22S-R30 |

Protective Diaphragm

| For Use with ... | Catalog Number |
|---|-----------------|
| Flush pushbuttons and indicating lights | M22-T-D |
| Double pushbuttons | M22-T-DD |

Dust Covers

| Description | Catalog Number |
|---|-----------------|
| Contact block dust cover | M22-XKDP |
| Operator dust cover, max three contact blocks | M22-ADC |
| Operator dust cover, max four contact blocks | M22-ADC4 |

Kits

| Description | Catalog Number |
|---|----------------|
| Includes one each: M22-XW, M22-XC-R, M22-XC-Y, M22S-B, M22-A, M22-XD-SWRGYB | M22-KT1 |

Coding Adapter Guide Selector Switches

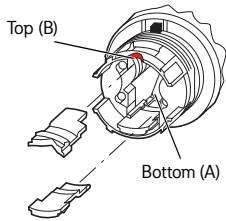

Two-Position Selector Switch

| Top (B) | Bottom (A) | Catalog Number | Function |
|---------|------------|-----------------|------------|
| | | M22(S)-W(L)(K) | Momentary |
| | | M22(S)-WR(L)(K) | Maintained |

Three-Position Selector Switch

| Top (B) | Bottom (A) | Catalog Number | Function Left | Right |
|---------|------------|--------------------|---------------|------------|
| | | M22(S)-W(L)(K)3 | Momentary | Momentary |
| | | M22(S)-WR(L)(K)3 | Maintained | Maintained |
| | | M22(S)-WR(L)(K)3-1 | Maintained | Momentary |
| | | M22(S)-WR(L)(K)3-2 | Momentary | Maintained |

Two-Position Key-Operated Selector Switch

| Top (B) | Bottom (A) | Catalog Number | Center Key Withdraw | Right Function | Key Withdraw |
|---------|------------|----------------|---------------------|----------------|--------------|
| | | M22(S)-WS | Yes | Momentary | No |
| | | M22(S)-WRS | Yes | Maintained | Yes |
| | | M22(S)-WRS-A1 | Yes | Maintained | No |

Three-Position Key-Operated Selector Switch

| Top (B) | Bottom (A) | Catalog Number | Left Function | Key Withdraw | Center Key Withdraw | Right Function | Key Withdraw |
|---------|------------|----------------|---------------|--------------|---------------------|----------------|--------------|
| | | M22(S)-WS3 | Momentary | No | Yes | Momentary | No |
| | | M22(S)-WRS3 | Maintained | Yes | Yes | Maintained | Yes |
| | | M22(S)-WRS3-A1 | Maintained | No | Yes | Maintained | No |
| | | M22(S)-WRS3-A2 | Maintained | Yes | Yes | Maintained | No |
| | | M22(S)-WRS3-A3 | Maintained | No | Yes | Maintained | Yes |
| | | M22(S)-WRS3-A4 | Maintained | Yes | Yes | Momentary | No |
| | | M22(S)-WRS3-A5 | Maintained | No | Yes | Momentary | No |
| | | M22(S)-WRS3-A6 | Momentary | No | Yes | Maintained | Yes |
| | | M22(S)-WRS3-A7 | Momentary | No | Yes | Maintained | No |

Technical Data and Specifications

Pushbuttons, Indicating Lights, Selector Switches and Emergency-Stop Operators

| Description | | Momentary Pushbuttons | Maintained Pushbuttons | Indicating Lights, Buzzers and Potentiometers | Emergency-Stop Operators | Selector Switches | Key-Operated Operators | Double Pushbuttons |
|---|--------------|---|----------------------------------|---|----------------------------------|----------------------------------|----------------------------------|----------------------------------|
| General | | | | | | | | |
| Standards | | IEC/EN 60947 VDE 0660 UL #E29184 | IEC/EN 60947 VDE 0660 UL #E29184 | IEC/EN 60947 VDE 0660 UL #E29184 | IEC/EN 60947 VDE 0660 UL #340491 | IEC/EN 60947 VDE 0660 UL #E29184 | IEC/EN 60947 VDE 0660 UL #E29184 | IEC/EN 60947 VDE 0660 UL #E29184 |
| Lifespan, mechanical | Operations | x 10 ⁶ >5 | >1 | — | >0.1 | >0.1 | >0.1 | >0.2 |
| Operating frequency | Operations/h | ≥3600 | ≥1800 | — | ≥600 | ≥2000 | ≥100 | ≥3600 |
| Actuating force | n | ≥5 | ≥5 | — | ≥50 | — | — | ≥5 |
| Operating torque (screw terminals) | Nm | — | — | — | — | ≥0.3 | ≥0.5 | — |
| Protection Type | | | | | | | | |
| IP | | IP67, IP69K | IP67, IP69K | Indicating lights: IP67, 69K Buzzers: IP40 Potentiometers: IP66 | IP67, IP69K | IP66 | IP66 | IP66 |
| UL type | | 4X, 13 | 4X, 13 | Indicating lights: 4X/13 Buzzers: 12 Potentiometers: 4X/13 | 4X, 13 | 4X, 13 | 4X, 13 | 4X, 13 |
| Climatic proofing | | Damp heat, constant, according to IEC 60068-2-78 Damp heat, cyclical to IEC 60068-2-30 | | | | | | |
| Ambient temperature, operating | | °F (°C) | –13 to 158 (–25 to 70) | –13 to 158 (–25 to 70) | –13 to 158 (–25 to 70) | –13 to 158 (–25 to 70) | –13 to 158 (–25 to 70) | –13 to 158 (–25 to 70) |
| Mounting position | | As required | | | | | | |
| Mechanical shock resistance to IEC 60068-2-27 shock duration 11 ms, half-sinusoidal | | g | >30 | >30 | >30 | >50 | >30 | >30 |
| Terminal Capacities | | | | | | | | |
| Solid | | AWG | — | — | 20-16 | — | — | — |
| | | mm ² | — | — | 0.5–1.5 | — | — | — |
| Stranded | | AWG | — | — | 20-16 | — | — | — |
| | | mm ² | — | — | 0.5–1.5 | — | — | — |
| Contacts | | | | | | | | |
| Rated impulse withstand voltage | | U _{imp} | Vac | — | 4000 | — | — | — |
| Rated insulation voltage | | U _i | V | — | 2500 | — | — | — |
| Overvoltage category/pollution degree | | — | | — | III/3 | — | — | — |

Contact Blocks and Light Units

| Description | | | Contact Blocks | LED Light Units |
|---|--------------|-------------------|---|--|
| General | | | | |
| Standards | | | IEC/EN 60947 VDE 0660 UL #E29184 | IEC/EN 60947 VDE 0660 UL #E29184 |
| Lifespan, mechanical | Operations | $\times 10^6$ | >5 | — |
| Operating frequency | Operations/h | | ≥ 3600 | — |
| Actuating force | n | | ≥ 5 | — |
| Operating torque (screw terminals) | Nm | | ≤ 0.8 | — |
| Protection Type | | | | |
| IP | | | IP20 | IP20 |
| UL type | | | — | — |
| Climatic proofing | | | Damp heat, constant, according to IEC 60068-2-78 Damp heat, cyclical to IEC 60068-2-30 | |
| Ambient temperature, operating | | °F (°C) | –13 to 158 (–25 to 70) | –13 to 158 (–25 to 70) |
| Mounting position | | | As required | As required |
| Mechanical shock resistance to IEC 60068-2-27 shock duration 11 ms, half-sinusoidal | | g | >30 | >30 |
| Terminal Capacities | | | | |
| Solid | | AWG | 18–14 | 18–14 |
| | | mm ² | 0.75–2.5 | 0.75–2.5 |
| Stranded | | AWG | 20–14 | 20–14 |
| | | mm ² | 0.5–2.5 | 0.5–2.5 |
| Contacts | | | | |
| Rated impulse withstand voltage | U_{imp} | Vac | 6000 | 6000 |
| Rated insulation voltage | U_i | V | 500 | 500 |
| Overvoltage category/ pollution degree | | | III/3 | III/3 |
| NEMA contact ratings | | | A600, Q300 | — |
| Current draw | | | — | 5–15 mA |
| Control Circuit Reliability | | | | |
| at 24 Vdc/5 mA | H_f | Fault probability | $<10^{-7}$, <1 fault in 10^7 operations | — |
| at 5 Vdc/1 mA | H_f | Fault probability | $<5 \times 10^{-6}$, <1 fault in 5×10^6 operations | — |
| Max. Short-Circuit Protective Device | | | | |
| Fuse | gG/gL | A | 10 | — |
| Switching Capacity | | | | |
| Rated Operational Current | | | | |
| AC-15 | | | | |
| 115V | I_e | A | 6 | — |
| 230V | I_e | A | 6 | — |
| 400V | I_e | A | 4 | — |
| 500V | I_e | A | 2 | — |
| DC-13 | | | | |
| 24V | I_e | A | 3 | — |
| 42V | I_e | A | 1.7 | — |
| 60V | I_e | A | 1.2 | — |
| 110V | I_e | A | 0.6 | — |
| 220V | I_e | A | 0.3 | — |
| Lifespan, Electrical | | | | |
| AC-15 | | | | |
| 230V/0.5A | Operations | $\times 10^6$ | 1.6 | — |
| 230V/1.0A | Operations | $\times 10^6$ | 1 | — |
| 230V/3.0A | Operations | $\times 10^6$ | 0.7 | — |
| DV-13 | | | | |
| 12V/2.8A | Operations | $\times 10^6$ | 1.2 | — |

Contact Element Note: >200 Vac/60 Hz: –25/55°C

Palm Switches

| Description | | Momentary | Maintained | FAK-R-V-KC11-I |
|--|------------------------------|--|--------------------------|--------------------------|
| General | | | | |
| Standards | | IEC/EN 60947 VDE 0660 | IEC/EN 60947 VDE 0660 | IEC/EN 60947 VDE 0660 |
| Lifespan, mechanical | Operations x 10 ⁶ | >1 | >0.1 | >0.1 |
| Operating frequency | Operations/h | ≥3600 | ≥600 | ≥600 |
| Actuating force | n | 20–40 | 40–60 | 15–25 |
| Operating torque | Nm | — | — | — |
| Degree of protection, IEC/EN 60529 | IP | IP67, IP69K | IP67, IP69K | IP65 |
| | UL Type | 4X, 13 | 4X, 13 | 4X, 13 |
| Climatic proofing | | Damp heat, constant, to IEC 60068-2-78 Damp heat, cyclic, to IEC 60068-2-30 | | |
| Ambient temperature, operating | °F (°C) | –73 to 104 (–25 to 40) | –73 to 104 (–25 to 40) | –73 to 104 (–25 to 40) |
| Mounting position | | As required | | |
| Mechanical shock resistance to IEC 60068-2-27 shock duration 11 ms, half-sinusoidal | g | >15 | >15 | >15 |

ASi Adapter Modules

| Description | | M22-ASI | M22-ASI-C |
|---|---------|--|--|
| General | | | |
| Standards | | IEC/EN 60947, DIN EN 50295 | IEC/EN 60947, DIN EN 50295 |
| Radio interference suppression | | EN 55011, EN 55022 | EN 55011, EN 55022 |
| Limit value class | | — | — |
| Protection type | | IP20 | IP00 |
| Climatic proofing | | Damp heat, constant, to IEC 60068-2-78, cyclical, to IEC 60068-2-30 | |
| Ambient temperature, operating | °F (°C) | –13 to 131 (–25 to 55) | –13 to 131 (–25 to 55) |
| Shock resistance shock duration 11 ms | g | >30 | >30 |
| Vibration to IEC 60068-2-27 (amplitude 1 mm) | Hz | — | — |
| Dimensions | | mm | — |
| Weight | | kg | — |
| Mounting | | Front mounting | Front mounting |
| Mounting position | | As required | As required |
| Power Supply | | | |
| Rated voltage to AS-interface specification | Vdc | 26.5–31.6 | 26.5–31.6 |
| Connection technique | | Yellow plug-in terminal as insulation piercing terminal | Two cables onboard |
| Power supply | | Completely from the AS-interface cable | |
| Addressing | | Via connection to AS-interface cable | |
| Total power consumption of the AS-interface | mA | ≥40 | ≥40 |
| AS-interface | | — | — |
| Rated operational current at full load | mA | — | — |
| Rated operational current when idle (no I, O set) | mA | — | — |
| Status LEDs | | POWER AS-interface cable: green LED on the rear side of the element ERROR AS-interface, AS-interface master failure: red LED on the rear side of the element | POWER AS-interface cable: green LED on the board ERROR AS-interface, AS-interface master failure: red LED on the board |

ASI-S Adapter Modules

| Description | | M22-ASI-S | M22-ASI-CS |
|---|---------|--|--|
| Inputs | | | |
| Inputs, protected against short-circuit | Number | Two (normally 22V/5 mA) | Two (normally 22V/5 mA) |
| Voltage range | Vdc | — | — |
| Rated current per input | mA | — | — |
| High signal level | V | — | — |
| Low signal | mA | — | — |
| Length of connecting cables | cm | — | — |
| Outputs | | | |
| Outputs, protected against short-circuit | Number | One (normally 19V/8 mA) | One (normally 19V/8 mA) |
| Voltage range | Vdc | — | — |
| Max. Current Carrying Capacity | | | |
| All outputs | | — | — |
| Σ three external outputs | | — | — |
| Length of connecting cables | cm | — | — |
| Profile | | S-3.A.E | S-3.A.E |
| Specification | | 2.1 | 2.1 |
| Addresses | Number | 62 | 62 |
| Emergency-Stop Circuits | | | |
| Connection of the AS-interface line | | Yellow plug terminal with insulation piercing | Two cables on the circuit board |
| Power supply | | Complete from AS-interface, cable 26.5–31.6 Vdc | Complete from AS-interface, cable 26.5–31.6 Vdc |
| Fixing | | Front mounted | Base mounted |
| Addressing | | Via AS-interface cable | Via AS-interface cable |
| Max. total current | A | 45 mA | 45 mA |
| Ambient temperature, operating | °F (°C) | –13 to 131 (–25 to 55) | –13 to 131 (–25 to 55) |
| Shock resistance | | 30g/11 ms as per IEC 60068-2-27 | 30g/11 ms as per IEC 60068-2-27 |
| Protection type | | IP20 | IP00 |
| Climatic proofing | | Damp heat, constant, to IEC 60068-2-78, cyclical, to IEC 60068-2-30 | Damp heat, constant, to IEC 60068-2-78, cyclical, to IEC 60068-2-30 |
| Mounting position | | As required | As required |
| Standards | | EN 50178 EN 50 295 | EN 50178 EN 50 295 |
| Inputs | | Two-channel input (22V/5 mA) (moduled by code sequence) (two break contact sets M22-K01) | Two-channel input (22V/5 mA) (moduled by code sequence) (two break contact sets M22-K01) |
| Outputs | | One output, typically 19V/8 mA, short-circuit proof | One output, typically 19V/8 mA, short-circuit proof |
| Status Displays | | | |
| Power, AS-interface cable | | Green LED on the back | Green LED on the back |
| AS-interface error, AS-interface master failure | | Red LED on the back | Red LED on the back |
| Profile | | S-7.B.E | S-7.B.E |

Dimensions

Approximate Dimensions in Inches (mm)

Operators and Indicating Lights

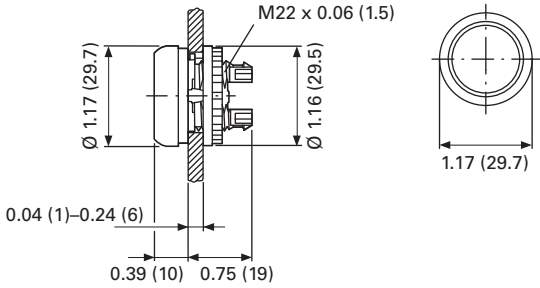

Pushbuttons

M22...-D-

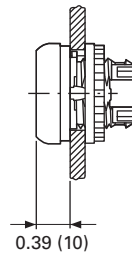

M22...-DH-

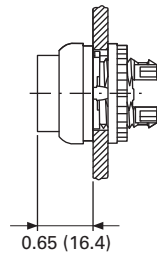

M22-DG(L)-

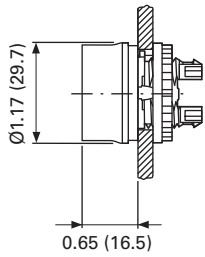

M22...-DD-

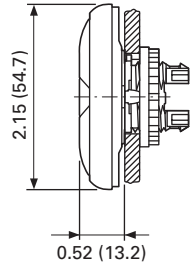

M22-D, Base Mounted

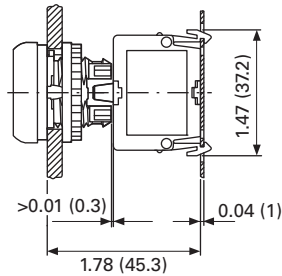

Selector Switches Operators

M22...-W-

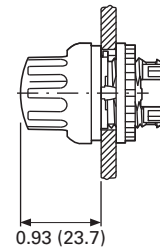

M22...-WL-

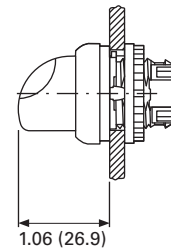

Key-Operated Selector Switches

M22...-W(R)S-

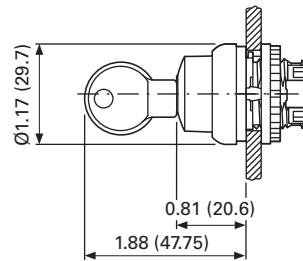

Indicating Light

M22-L

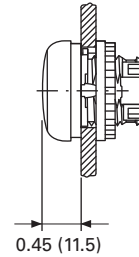

1.4

Pushbuttons and Indicating Lights

22.5 mm RMQ-Titan Modular Pushbuttons—M22

1

Approximate Dimensions in Inches (mm)

Illuminated Pushbuttons

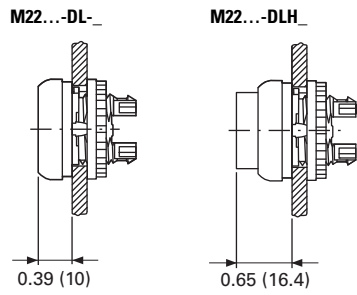

Mushroom Head Pushbutton

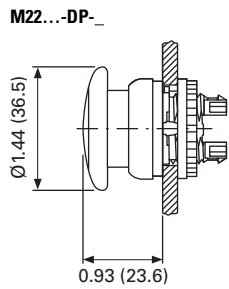

Emergency-Stop Operators

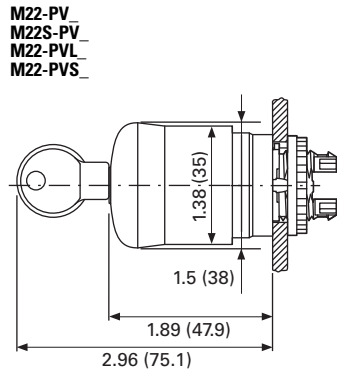

Potentiometer

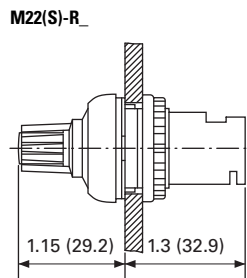

Contact Block Mounting Adapter

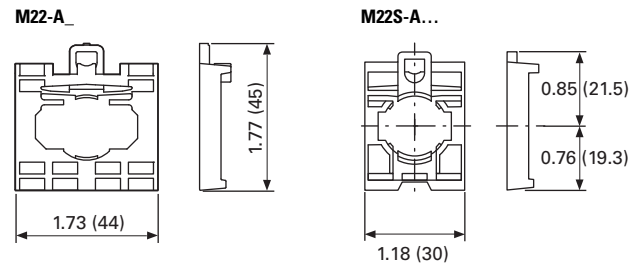

Front Mounted Centering Adapter

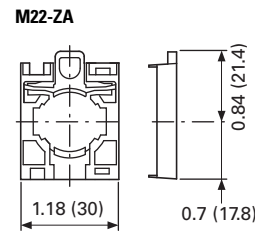

Front Mounted Indicating Light

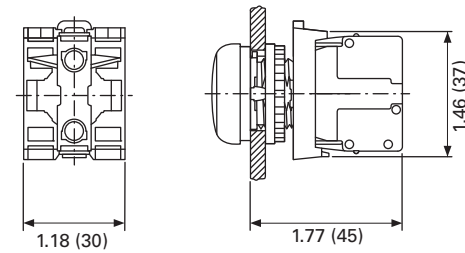

Pushbutton, Complete Devices

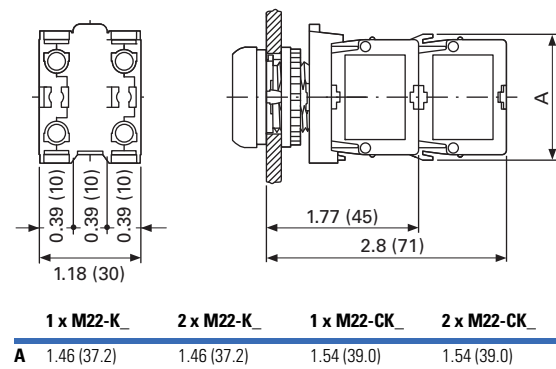

Approximate Dimensions in Inches (mm)

DIN-Rail Mounting Adapter

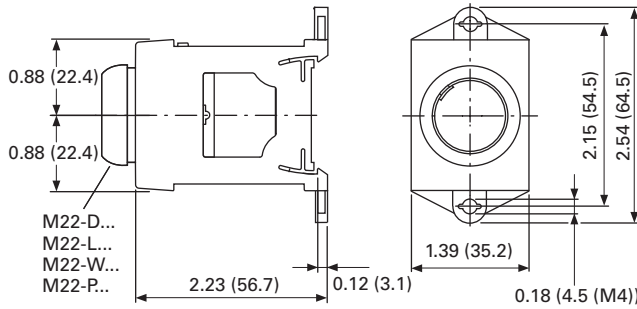

Pushbuttons and Indicating Lights with M22-TC Telescopic Clip and M22-TVC Extension

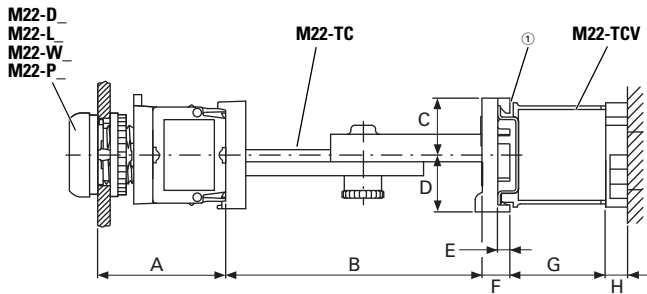

| A | B | C | D | E | F | G | H |
|--------------|-----------------------|--------------|--------------|---------------|--------------|-------------|--------------|
| 1.77 (45) | 2.36–3.94 (60–100) | 0.79 (20) | 0.79 (20) | 0.18 (4.5) | 0.39 (10) | 154 (39) | 0.39 (10) |

① Top-hat rail to IEC/EN 60715.

Palm Switches

FAK_

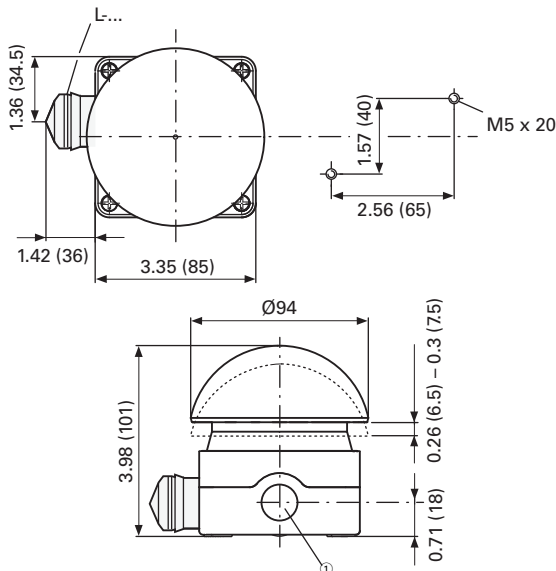

① 3 x M20 lateral, 1 x M16 in bottom.

Front Mounted Mounting Plate

M22-E_

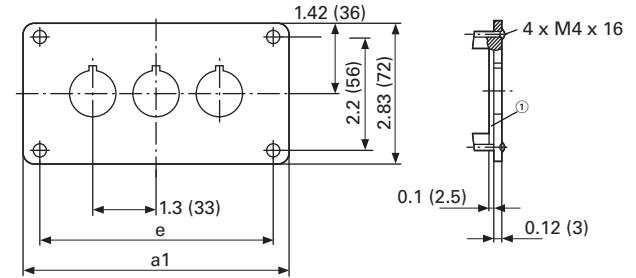

| Catalog Number | a1 | e |
|----------------|------------|------------|
| M22-E(Y) ① | 2.83 (72) | 2.21 (56) |
| M22-E2 | 4.13 (105) | 3.50 (89) |
| M22-E3 | 5.43 (138) | 4.80 (122) |

| Catalog Number | a1 | e |
|----------------|------------|------------|
| M22-E4 | 6.73 (171) | 6.10 (155) |
| M22-E5 | 8.03 (204) | 7.40 (188) |
| M22-E6 | 9.33 (237) | 8.70 (221) |

Base Mounted Surface Mounting Enclosure

M22-I_

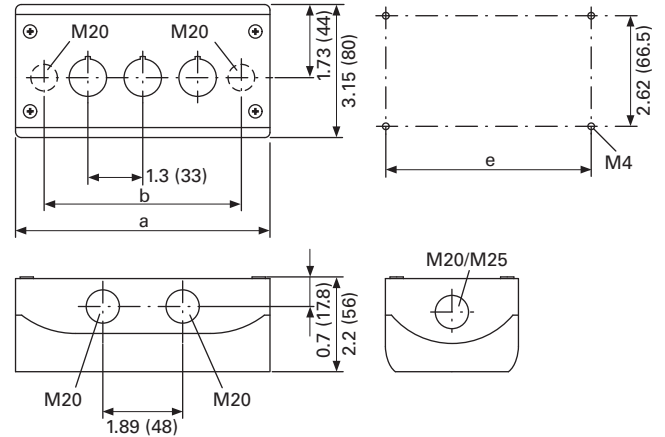

| Catalog Number | Mounting Locations | a | b | e | Cable Entries |
|----------------|--------------------|-----------------|-----------------|-----------------|-------------------------|
| M22-I(Y)1 | 1 | 2.83 (72.0) | 1.68 (42.6) | 2.30 (58.5) | 2 x M16 3 x M20 2 x M25 |
| M22-I2 | 2 | 4.72 (120.0) | 3.37 (85.6) | 4.19 (106.5) | 2 x M20 3 x M20 2 x M25 |
| M22-I3 | 3 | 6.02 (153.0) | 4.67 (118.6) | 5.49 (139.5) | 2 x M20 2 x M25 4 x M20 |
| M22-I4 | 4 | 7.32 (186.0) | 5.97 (151.6) | 6.79 (172.5) | 2 x M20 2 x M25 4 x M20 |
| M22-I6 | 6 | 9.92 (252.0) | 8.57 (217.6) | 9.39 (238.5) | 2 x M20 2 x M25 4 x M20 |

1.4

Pushbuttons and Indicating Lights

22.5 mm RMQ-Titan Modular Pushbuttons—M22

1

Approximate Dimensions in Inches (mm)

Covers

M22-H_

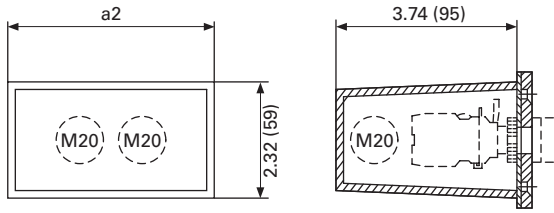

| Catalog Number | a2 | Cable Entry | Style |
|----------------|------------|-------------|-----------|
| M22-H1 | 1.65 (42) | 3 x M20 | One-piece |
| M22-H2 | 2.95 (75) | 4 x M20 | |
| M22-H3 | 4.25 (108) | 4 x M20 | |
| M22-H4 | 5.55 (141) | 4 x M20 | Split |
| M22-H5 | 6.85 (174) | 5 x M20 | |
| M22-HE6 | 8.15 (207) | 6 x M20 | |

Connecting Screw

M22-XI

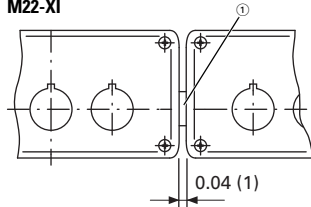

① Gasket.

Shroud with Plaster Keys

M22-UPE

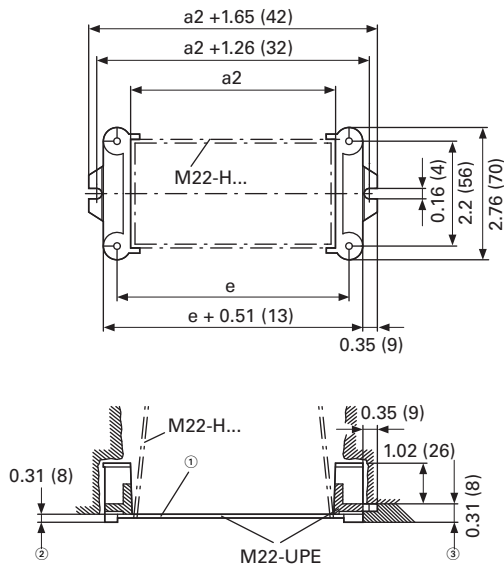

- ② Box for closing off when plastering.
- ③ Plaster thickness less than 8 mm.
- ④ Plaster thickness more than 8 mm.

Legend Plates

M22S-ST_

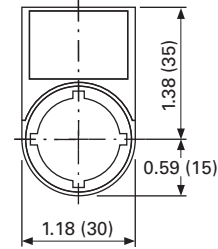

M22S-STDD-X

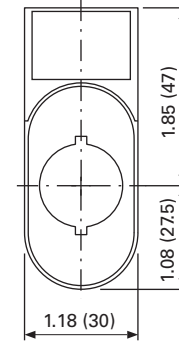

Mounting Hole with Lug Slot

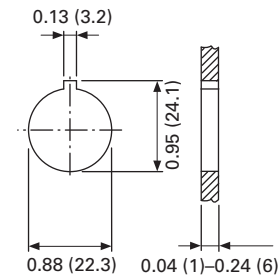

Approximate Dimensions in Inches (mm)

Grid Dimension to IEC/EN 60947

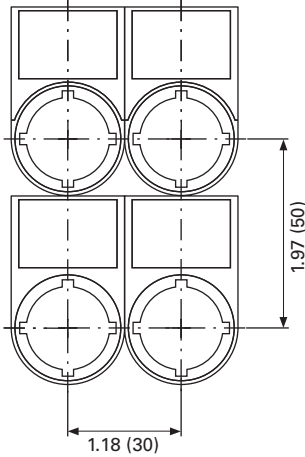

Grid Dimension for Various Combinations

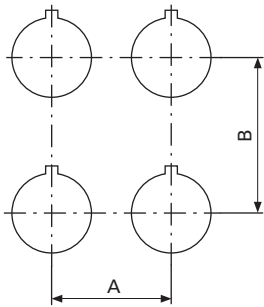

Pushbutton Diaphragm

Pushbutton diaphragm cannot be combined with label mount.

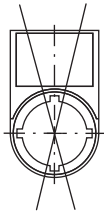

| Catalog Number | A ≥ | B ≥ |
|--------------------------------|-------------|-------------|
| M22(S)-_ (IEC/EN 60947) | 1.18 (30.0) | 1.97 (50.0) |
| RMQ-Titan min. | 1.18 (30.0) | 1.58 (40.0) |
| M22-D_ + M22-T-D | 1.30 (33.0) | 1.58 (40.0) |
| M22-D(R)P_ | 1.50 (38.0) | 1.58 (40.0) |
| M22-PV_ | 1.50 (38.0) | 1.58 (40.0) |
| M22-PV(L) + M22-PL-PV | 1.89 (48.0) | 2.20 (56.0) |
| M22-PV(L)(S_) + M22-D_ | 1.30 (33.0) | 1.58 (40.0) |
| M22-DDL_ | 1.18 (30.0) | 2.17 (55.0) |
| M22-DDL_ + M22-T-DD | 1.30 (33.0) | 2.28 (58.0) |
| M22-ST_ | 1.18 (30.0) | 1.97 (50.0) |
| M22-STDD_ | 1.18 (30.0) | 2.95 (75.0) |
| M22-CK_ | 1.18 (30.0) | 1.77 (45.0) |
| M22-CLED_ | 1.18 (30.0) | 1.77 (45.0) |
| M22-XAK_ | 3.54 (90.0) | 3.54 (90.0) |
| M22-XZK_ | 1.30 (33.0) | 2.04 (52.0) |
| M22-XBK_ | 2.36 (60.0) | 2.36 (60.0) |
| M22-XYK_ | 1.97 (50.0) | 1.97 (50.0) |
| M22-D4 | 2.17 (55.0) | 2.17 (55.0) |
| M22-WR...4 | 1.97 (50.0) | 1.97 (50.0) |
| M22-W...J4 | 1.97 (50.0) | 1.97 (50.0) |

Grid Dimension for M22-DD_

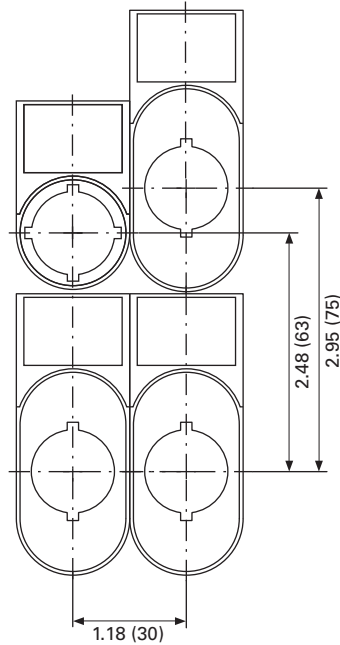

Grid Dimension for M22-DDL_

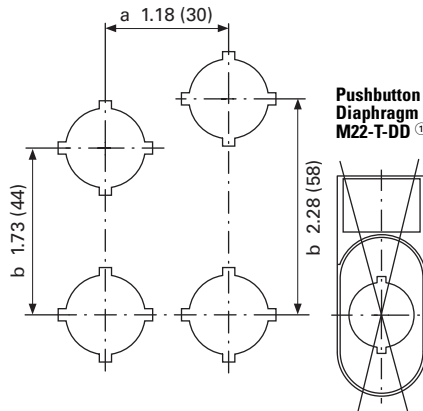

① Pushbutton diaphragm cannot be combined with label mount.

Emergency Stop Sealing Cover

M22-PL-PV

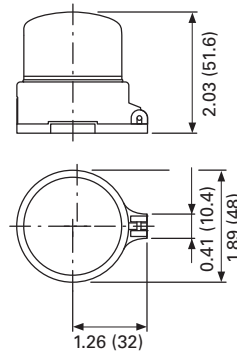

1.4

Pushbuttons and Indicating Lights

22.5 mm RMQ-Titan Modular Pushbuttons—M22

1

Approximate Dimensions in Inches (mm)

Blanking Plugs

M22...B-₋

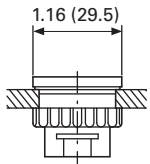

Pushbutton Diaphragm

M22-T-D

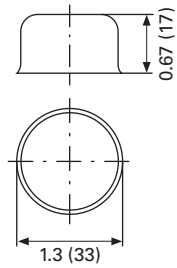

M22-T-D

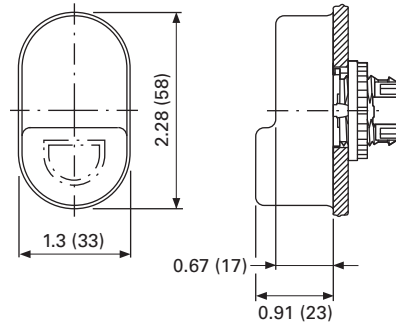

Guard Ring

M22-XGWK

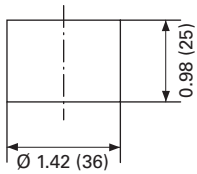

M22-XGPV

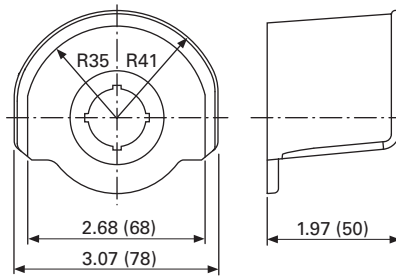

Key Cover

M22-XWS

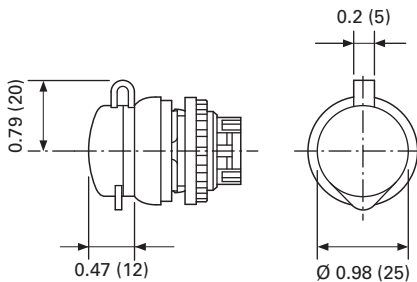

Emergency Stop Legend Plate

M22-XAK-₋

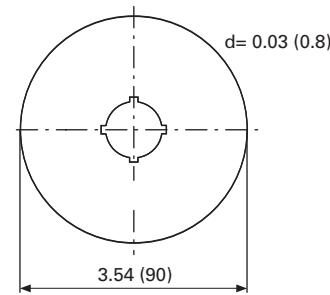

M22-X(Y)ZK-₋

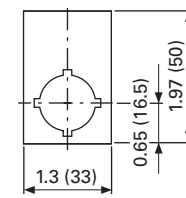

M22-XBK-₋

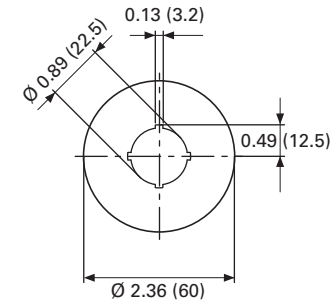

M22-XYK-₋

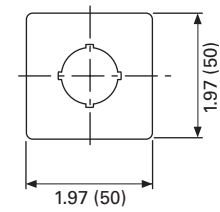

Joystick

M22...W...J-₋

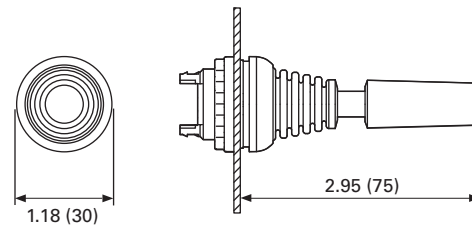

Four-Way Pushbutton

M22...D...4-₋

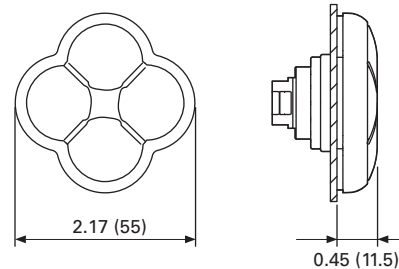

Symbols Library

Instructions for Ordering Laser Inscriptions

1. Identify part number to be inscribed.
2. Pick symbol from library and identify suffix code associated with the symbol.
3. Order part number already listed in the catalog with -ETCH suffix.
4. When placing an order by fax or Vistaline on the Web, reference order item number and indicate appropriate suffix code.

Example

To order a green flush button plate with the inscription AUTO HAND:

Order Catalog Number: M22-XD-G-ETCH (see **Page V7-T1-49**).

AUTO HAND inscription is found on **Page V7-T1-127** in the Symbols Library, suffix code is X91.

In the order notes, reference item number and suffix X91.

Letter height 3 mm: max. three lines, max. 12 characters per line.

Letter height 5 mm: max. two lines, max. eight characters per line.

Note: For symbols or text not found in the Symbols Library, please contact the Eaton Technical Resource Center at 1-877-ETN CARE (386-2273) or TRC@eaton.com.

Letter Height Specifications: ≤ five characters; letter height = 0.197 in (5 mm). > five characters; letter height = 0.118 in (3 mm).

Text—English

| Inscription | Catalog Number Suffix |
|-------------|-----------------------|
| STOP | GB0 |
| START | GB1 |
| CLOSE | GB2 |
| UP | GB3 |
| DOWN | GB4 |
| OFF | GB5 |
| ON | GB6 |
| RUN | GB7 |
| FAULT | GB8 |
| TEST | GB9 |
| OFF ON | GB10 |
| MAN. AUTO | GB11 |
| MAN. 0 AUTO | GB12 |
| RESET | GB14 |
| FORWARD | GB15 |
| REVERSE | GB16 |
| RAISE | GB17 |

Text—German

| Inscription | Catalog Number Suffix |
|----------------|-----------------------|
| LOWER | GB18 |
| LEFT | GB19 |
| RIGHT | GB20 |
| BRAKE | GB21 |
| HIGH | GB22 |
| LOW | GB23 |
| FAST | GB24 |
| SLOW | GB25 |
| FASTER | GB26 |
| SLOWER | GB27 |
| OPEN | GB32 |
| PROG | GB62 |
| CALL | GB63 |
| OCCUPIED | GB64 |
| BYPASS 0 1 | GB65 |
| BYPASS UP | GB66 |
| EMERGENCY-STOP | GB99 |

| Inscription | Catalog Number Suffix |
|-------------|-----------------------|
| Halt | D0 |
| Start | D1 |
| Zu | D2 |
| Auf | D3 |
| Ab | D4 |
| Aus | D5 |
| En | D6 |
| Betrieb | D7 |
| Störung | D8 |
| Prüfung | D9 |
| Aus Ein | D10 |
| HAND AUTO | D11 |
| HAND 0 AUTO | D12 |
| Antrieb | D13 |
| Entsperren | D14 |
| Vorwärts | D15 |
| Rückwärts | D16 |
| Heben | D17 |
| Senken | D18 |
| Links | D19 |
| Rechts | D20 |
| Bremsen | D21 |
| Hoch | D22 |
| Niedrig | D23 |
| Schnell | D24 |

| Inscription | Catalog Number Suffix |
|-------------------------|-----------------------|
| Langsam | D25 |
| HAND | D28 |
| AUTO | D29 |
| Einrichten | D30 |
| Tippen | D31 |
| Öffnen | D32 |
| Steuerspannung | D33 |
| Start Automatik | D34 |
| Lampentest | D35 |
| Phasenkontrolle | D36 |
| Alarm | D37 |
| Alarm - Reset | D38 |
| Sammelstörung | D39 |
| Quittieren | D40 |
| Quittierung | D41 |
| Steuerung Ein | D42 |
| Steuerung Aus | D43 |
| Störung quittieren | D44 |
| FÜHLER int. ext. | D72 |
| HEIZUNG 1 2 | D73 |
| AUS- BLASEN | D74 |
| SOLLWERT int. ext. | D75 |
| Not-Aus | D99 |
| Not - Aus quittieren | D100 |

Text Size: 3 mm—Max. eight characters in first line; 10 characters in second line; eight characters in third line.



Text Size: 5 mm—Max. five characters per line.



Letter Height Specifications: ≤ five characters; letter height = 0.197 in (5 mm). > five characters; letter height = 0.118 in (3 mm).

Text—French

| Inscription | Catalog Number Suffix |
|-----------------|-----------------------|
| ARRÊT | F0 |
| MARCHE | F1 |
| FERMÉ | F2 |
| MONTÉE | F3 |
| DESCENTE | F4 |
| ARRÊT | F5 |
| MARCHE | F6 |
| EN SERVICE | F7 |
| PANNE | F8 |
| ESSAI | F9 |
| ARRÊT MARCHÉ | F10 |
| MAN. AUTO | F11 |
| MAN. 0 AUTO | F12 |
| REARM. | F14 |
| AVANT | F15 |
| ARRIÈRE | F16 |
| MONTER | F17 |
| DESCENDRE | F18 |
| GAUCHE | F19 |
| DROITE | F20 |
| DEFAULT | F67 |
| SOUS TENSION | F68 |
| ARRÊT D'URGENCE | F99 |

Text—Swedish

| Inscription | Catalog Number Suffix |
|---------------|-----------------------|
| STOPP | S0 |
| START | S1 |
| STÄNG | S2 |
| UPP | S3 |
| NED | S4 |
| FRÅN | S5 |
| TILL | S6 |
| KÖR | S7 |
| FEL | S8 |
| PROV | S9 |
| FRÅN TILL | S10 |
| MAN. AUTO | S11 |
| MAN. 0 AUTO | S12 |
| ÅTERSTÄLLNING | S14 |
| FRAM | S15 |
| BACK | S16 |
| ÖKA | S17 |
| MINSKA | S18 |
| VÄNSTER | S19 |
| HÖGER | S20 |
| BROMS | S21 |
| HÖG | S22 |
| LÅG | S23 |
| ÖPPNA | S32 |
| IN | S45 |
| UT | S46 |
| NÖDSTOPP | S99 |

Symbols

| Inscription | Catalog Number Suffix | Inscription | Catalog Number Suffix |
|-------------|-----------------------|-------------|-----------------------|
| | X0 | | X13 |
| | X1 | | X14 |
| | X2 | | X15 |
| | X3 | | X16 |
| | X4 | | X17 |
| | X5 | | X18 |
| | X6 | | X19 |
| | X7 | | X20 |
| | X8 | | X21 |
| | X9 | | X22 |
| | X10 | | X23 |
| | X11 | | X24 |
| | X12 | | X25 |

Text Size: 3 mm—Max. eight characters in first line; 10 characters in second line; eight characters in third line.



Text Size: 5 mm—Max. five characters per line.



| Inscription | Catalog Number Suffix | Inscription | Catalog Number Suffix | Inscription | Catalog Number Suffix | Inscription | Catalog Number Suffix |
|--------------------|-----------------------|-------------|-----------------------|-------------|-----------------------|-------------|-----------------------|
| | X82 | | X104 | | X118 | | X132 |
| | X83 | | X105 | | X119 | | X133 |
| | X88 | | X106 | | X120 | | X134 |
| | X89 | | X107 | | X121 | | X135 |
| | X90 | | X108 | | X122 | | X136 |
| AUTO HAND | X91 | | X109 | | X123 | | X137 |
| | X92 | | X110 | | X124 | | X138 |
| | X93 | | X111 | | X125 | | X139 |
| Auto 0 Man. | X94 | | X112 | | X126 | | X140 |
| | X95 | | X113 | | X127 | | X141 |
| | X100 | | X114 | | X128 | | X142 |
| | X101 | | X115 | | X129 | | X143 |
| | X102 | | X116 | | X130 | | X144 |
| | X103 | | X117 | | X131 | | X145 |

Text Size: 3 mm—Max. eight characters in first line; 10 characters in second line; eight characters in third line.



Text Size: 5 mm—Max. five characters per line.













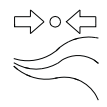



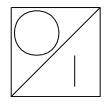
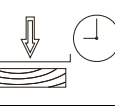

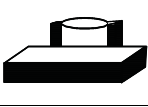
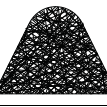
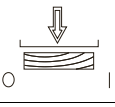

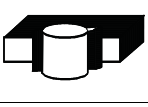
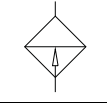

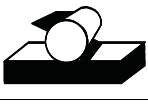
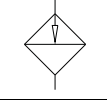
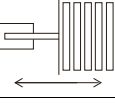

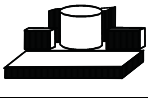
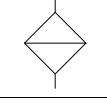
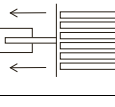

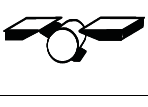
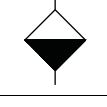
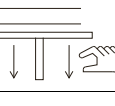
1.4

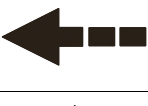
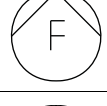
Pushbuttons and Indicating Lights

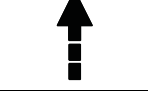
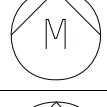
22.5 mm RMQ-Titan Modular Pushbuttons—M22

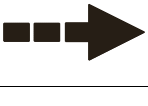
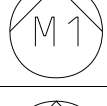
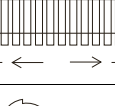
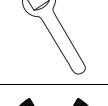
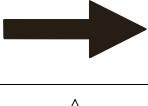
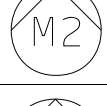
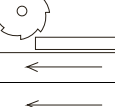
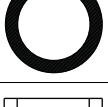
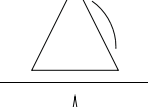
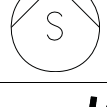
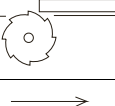
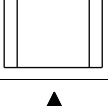
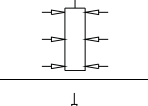
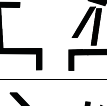
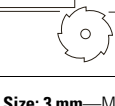
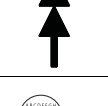
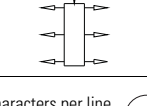
1

| Inscription | Catalog Number Suffix | Inscription | Catalog Number Suffix | Inscription | Catalog Number Suffix | Inscription | Catalog Number Suffix |
|---|-----------------------|---|-----------------------|---|-----------------------|---|-----------------------|
|  | X146 |  | X160 |  | X174 |  | X188 |
|  | X147 |  | X161 |  | X175 |  | X189 |
|  | X148 |  | X162 |  | X176 |  | X190 |
|  | X149 |  | X163 |  | X177 |  | X191 |
|  | X150 |  | X164 |  | X178 |  | X192 |
|  | X151 |  | X165 |  | X179 |  | X193 |
|  | X152 |  | X166 |  | X180 |  | X194 |
|  | X153 |  | X167 |  | X181 |  | X195 |
|  | X154 |  | X168 |  | X182 |  | X196 |
|  | X155 |  | X169 |  | X183 |  | X197 |
|  | X156 |  | X170 |  | X184 |  | X198 |
|  | X157 |  | X171 |  | X185 |  | X199 |
|  | X158 |  | X172 |  | X186 |  | X200 |
|  | X159 |  | X173 |  | X187 |  | X201 |

Text Size: 3 mm—Max. eight characters in first line; 10 characters in second line; eight characters in third line.



Text Size: 5 mm—Max. five characters per line.



| Inscription | Catalog Number Suffix | Inscription | Catalog Number Suffix | Inscription | Catalog Number Suffix | Inscription | Catalog Number Suffix |
|-------------|-----------------------|-------------|-----------------------|-------------|-----------------------|-------------|-----------------------|
| | X202 | | X216 | | X230 | | X244 |
| | X203 | | X217 | | X231 | | X245 |
| L 1 | X204 | | X218 | | X232 | | X246 |
| L 2 | X205 | | X219 | | X233 | | X247 |
| L 3 | X206 | | X220 | | X234 | | X248 |
| ↑ A | X207 | | X221 | | X235 | | X249 |
| ↓ A | X208 | | X222 | | X236 | | X250 |
| ↓ B | X209 | | X223 | | X237 | | X251 |
| ↑ B | X210 | | X224 | | X238 | | X252 |
| I | X211 | | X225 | | X239 | | X253 |
| II | X212 | | X226 | | X240 | | X254 |
| III | X213 | | X227 | | X241 | | X255 |
| | X214 | | X228 | | X242 | | X256 |
| | X215 | | X229 | | X243 | | X257 |

Text Size: 3 mm—Max. eight characters in first line; 10 characters in second line; eight characters in third line.



Text Size: 5 mm—Max. five characters per line.















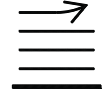



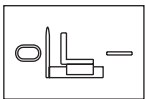





1.4

Pushbuttons and Indicating Lights

22.5 mm RMQ-Titan Modular Pushbuttons—M22

1

| Inscription | Catalog Number Suffix | Inscription | Catalog Number Suffix | Inscription | Catalog Number Suffix | Inscription | Catalog Number Suffix |
|--|-----------------------|---|-----------------------|--|-----------------------|---|-----------------------|
|  | X258 |  | X265 | CHEM II | X272 |  | X279 |
|  | X259 |  | X266 | CHEM III | X273 |  | X280 |
|  | X260 |  | X267 |  | X274 | OUT OF SERVICE | X281 |
|  | X261 |  | X268 |  | X275 |  | X282 |
|  | X262 |  | X269 | CONTI → CUT | X276 |  | X283 |
|  | X263 |  | X270 |  | X277 |  | X284 |
|  | X264 | CHEM I | X271 |  | X278 |  | X285 |

Text Size: 3 mm—Max. eight characters in first line; 10 characters in second line; eight characters in third line.



Text Size: 5 mm—Max. five characters per line.



22.5 mm RMQ Compact Pushbuttons—C22



Contents

| <i>Description</i> | <i>Page</i> |
|---|-------------|
| 22.5 mm RMQ Compact Pushbuttons—C22 | |
| Product Selection Guide | V7-T1-133 |
| Pushbuttons—Non-Illuminated and Illuminated | V7-T1-134 |
| Indicating Lights | V7-T1-147 |
| Emergency Stops | V7-T1-150 |
| Selector Switches | V7-T1-153 |
| Technical Data and Specifications | V7-T1-160 |
| Dimensions | V7-T1-162 |

Product Overview

Product Description

Eaton's C22 compact pushbutton line offers an industry leading array of functional, attractive, and ergonomically designed "all-in-one" illuminated and non-illuminated pushbuttons, selector switches, emergency stops and indicating lights. The complete illuminated line is only offered in LED light units to ensure high-quality brightness and up to 100,000 hours of LED illumination. C22 operators are available with either a silver or black bezel and share the exact same front of the panel look and feel as Eaton's M22 line. The C22's compact, "all-in-one" design with the contact block(s) and operators integral provides the user with a simple solution.

The 2017 product extension C22 with pigtail has more than doubled the portfolio. The C22 with pigtail now allows customers the ability to directly mount the product without the need for pushbutton enclosures. With three different connection methods and multiple lengths, the C22 with pigtail can be used for a wide range of applications.

Wide Product Breadth

- In addition to the standard compact offering of indicating lights and pushbuttons, Eaton's C22 offers keyed and non-keyed operators and emergency stops
- Hundreds of styles with standard laser etch markings with the ability to use custom M22 laser etched buttons in conjunction with C22 buttonless operators
- Pigtail lengths vary from 0.2 to 3.5 m and allow three connection options—M8, M12 and flying lead

LED Indicators

- 100,000 hours of life in high-vibration environments
- Lenses specifically designed for LED illumination

Rugged Design

- Pushbuttons (momentary) rated for 5 million mechanical operations and selector switches (non-keyed) rated for 1 million mechanical operations
- All components have IP65 rating, and some carry IP67 and IP69K for wash-down environment, which also means oil tight
- C22 with pigtail has an IP65 rear rating, eliminating the need for an enclosure in dust and water jet applications

Standards and Certifications

All operators are IEC/EN 60947 VDE 0660, UL Listed, and CSA Certified.

All operators carry an IP65, IP66, IP67 or IP69K rating.

All products carry ratings of NEMA 1, 3R, 4X, 12 and 13



1

Features

- Field convertible maintained pushbuttons from maintained to momentary
- LED offering only for all illuminated operators
- Laser engraved pushbuttons and lenses
- Heavy-duty construction with a minimum of IP65 and UL NEMA® Type 4X/13 on front of panel operators. Many operators even carry IP67 and IP69K, for the toughest applications
- Silver or black colored nylon bezels
- Notched hole mounting with anti-rotation tab and central nut mounting on each operator
- Pushbuttons (momentary) rated for 5 million mechanical operations and selector switches (non-keyed) rated for 1 million mechanical operations
- Unique compact offerings, including keyed and non-keyed operators and emergency stops

Benefits

- Compact, “all-in-one” operator and contact block design simplifies product selection, inventory, and installation
- Field convertibility of pushbuttons and selector switches helps distributors and customers reduce inventory and increase functionality
- LED offering only for improved brightness quality and up to 100,000 hours of operation
- Plastic construction is corrosion resistant
- Eliminate enclosure, on machine installations
- Operators are designed for rugged environments, ideal for wash-down applications (reference each operator’s IP ratings for ingress protection definition)
- Anti-rotation tab saves installation time and prevents operator rotation
- High mechanical and electrical life allows for use in tough and challenging applications
- Laser inscription capabilities allow for high quality, wear-resistant markings
- By having a compact design emergency stop, the C22 design eliminates the need for self-monitoring contact blocks
- M12/M8 connections allow connection directly into communications systems such as SmartWire-DT or AS6

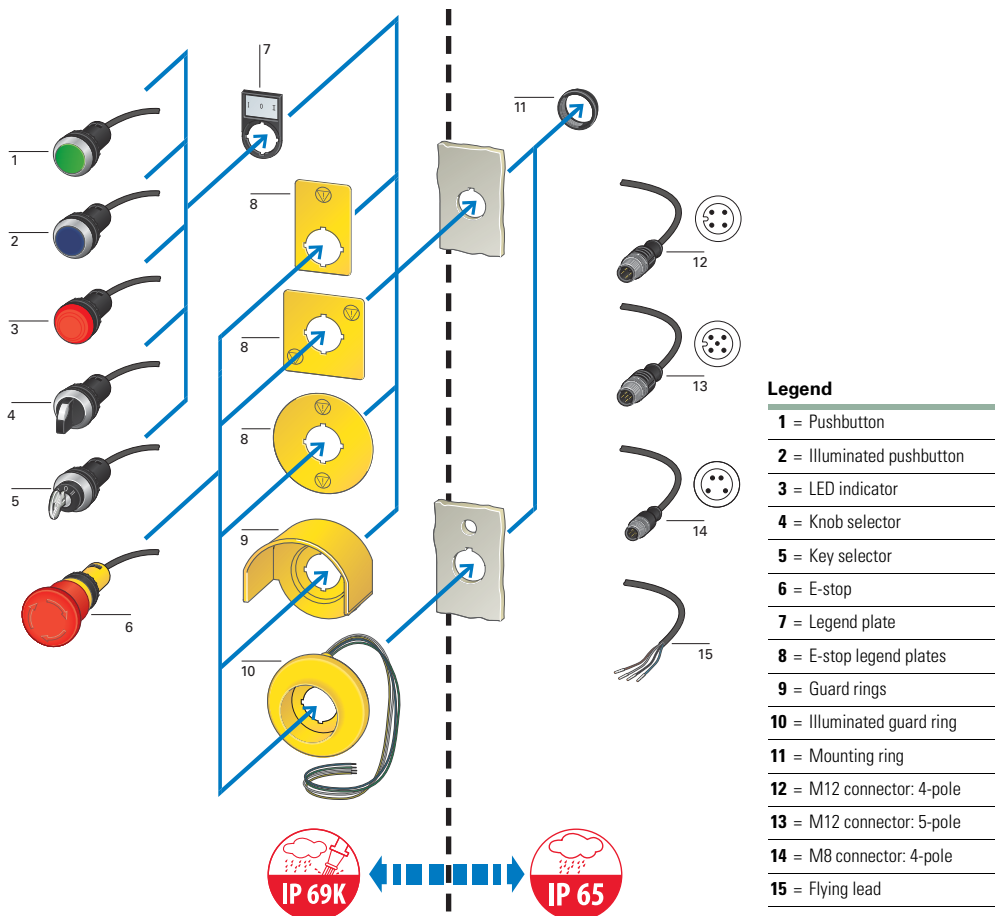

Product Selection Guide

Pushbuttons



| | | | | | | | | |
|--------------------------|--------------------------------|--------------------------------|--|--------------------------------|--------------------------------|--------------------------------|--|--------------------------------|
| Description | Non-illuminated, flush | | Non-illuminated, flush, pigtail (M8/M12/flying lead) | | Illuminated, flush | | Illuminated, flush, pigtail (M8/M12/flying lead) | |
| Operator | Momentary | Maintained | Momentary | Maintained | Momentary | Maintained | Momentary | Maintained |
| Product Selection | Page V7-T1-135 | Page V7-T1-137 | Page V7-T1-136 | Page V7-T1-138 | Page V7-T1-141 | Page V7-T1-143 | Page V7-T1-142 | Page V7-T1-144 |

Extended Pushbuttons



| | | | | |
|--------------------------|--------------------------------|--------------------------------|--------------------------------|--------------------------------|
| Description | Non-illuminated, extended | | Illuminated, extended | |
| Operator | Momentary | Maintained | Momentary | Maintained |
| Product Selection | Page V7-T1-139 | Page V7-T1-140 | Page V7-T1-145 | Page V7-T1-146 |

Indicating Lights



| | | |
|--------------------------|--------------------------------|---|
| Description | Indicating lights | Indicating lights with pigtail (M8/M12/flying lead) |
| Product Selection | Page V7-T1-148 | Page V7-T1-149 |

Emergency Stops



| | | | | |
|--------------------------|--------------------------------|--------------------------------|---|--|
| Description | Twist release | Keyed-release | Twist release with or without indicator and flying lead/M12 | Push-Pull with Pigtail (flying lead/M12) |
| Product Selection | Page V7-T1-151 | Page V7-T1-151 | Page V7-T1-152 | Page V7-T1-152 |

Selector Switches



| | | | | |
|--------------------------|--------------------------------|--------------------------------|--|--------------------------------|
| Description | Non-illuminated, knob type | Key-operated | Non-illuminated, knob type, with pigtail | Key-operated with pigtail |
| Product Selection | Page V7-T1-154 | Page V7-T1-156 | Page V7-T1-155 | Page V7-T1-158 |

Pushbuttons—Non-Illuminated and Illuminated



Contents

| <i>Description</i> | <i>Page</i> |
|--|------------------|
| Pushbuttons—Non-Illuminated and Illuminated | |
| Non-Illuminated Pushbuttons, Flush, Momentary | V7-T1-135 |
| Non-Illuminated Pushbuttons, Flush, Momentary, with Pigtail | V7-T1-136 |
| Non-Illuminated Pushbuttons, Flush, Maintained | V7-T1-137 |
| Non-Illuminated Pushbuttons, Flush, Maintained, with Pigtail | V7-T1-138 |
| Non-Illuminated Pushbuttons, Extended, Momentary | V7-T1-139 |
| Non-Illuminated Pushbuttons, Extended, Maintained | V7-T1-140 |
| Illuminated, Flush, Momentary | V7-T1-141 |
| Illuminated Pushbuttons, Flush, Momentary, with Pigtail | V7-T1-142 |
| Illuminated Pushbuttons, Flush, Maintained | V7-T1-143 |
| Illuminated Pushbuttons, Flush, Maintained, with Pigtail | V7-T1-144 |
| Illuminated Pushbuttons, Extended, Momentary | V7-T1-145 |
| Illuminated Pushbuttons, Extended, Maintained | V7-T1-146 |
| Indicating Lights | V7-T1-147 |
| Emergency Stops | V7-T1-150 |
| Selector Switches | V7-T1-153 |
| Technical Data and Specifications | V7-T1-160 |
| Dimensions | V7-T1-162 |

Pushbuttons—Non-Illuminated and Illuminated

Product Description

Eaton’s C22 Compact Pushbuttons are a complete line of monoblock type pushbuttons with the contact blocks, mounting adapter, and operator all-in-one. The C22 pushbuttons offer the same look and feel as their modular counterpart, the M22. They also carry many of the same rugged ratings and options, such as laser etching, field convertibility, and LED technology. They also feature IP65 rear ratings when purchased with pigtail, M8/M12/flying lead.

Note: For additional accessories, please see **Pages V7-T1-105 to V7-T1-111**, 22.5 mm Modular Pushbuttons—M22 Accessories.

Features

- Field convertible maintained pushbuttons from maintained to momentary
- LED offering only for improved brightness quality and up to 100,000 hours of operation
- Laser engraved pushbuttons and lenses
- Pushbuttons (momentary) rated for 5 million mechanical operations
- Pigtail option allows direct machine mounting

Protection Type

- IP67/IP69K
- NEMA 4X, 13
- IP65 rear (pigtail devices)

Catalog Number Selection

Catalog Number Selection is for illustrative purposes only and not to be used to create new catalog numbers.

Non-Illuminated Pushbuttons

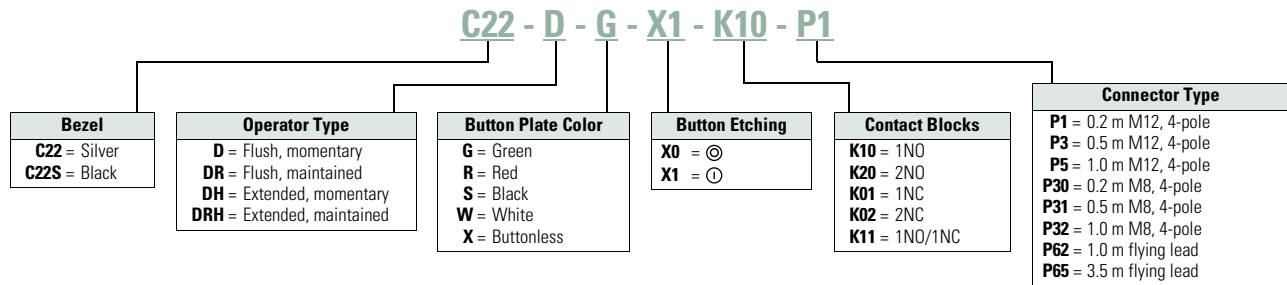

Product Selection

Non-Illuminated Pushbuttons, Flush, Momentary

C22(S)-D- Non-Illuminated Pushbuttons, Flush, Momentary

| Button Color | Button Etching | Contact Block Configuration | Silver Bezel Catalog Number | Black Bezel Catalog Number | |
|--------------|----------------|-----------------------------|-----------------------------|----------------------------|--------------|
| Green | — | 1NO | C22-D-G-K10 | C22S-D-G-K10 | |
| | — | 2NO | C22-D-G-K20 | C22S-D-G-K20 | |
| | — | 1NO/1NC | C22-D-G-K11 | C22S-D-G-K11 | |
| | X1 | 1NO | C22-D-G-X1-K10 | C22S-D-G-X1-K10 | |
| | X1 | 2NO | C22-D-G-X1-K20 | C22S-D-G-X1-K20 | |
| | X1 | 1NO/1NC | C22-D-G-X1-K11 | C22S-D-G-X1-K11 | |
| | Red | — | 1NC | C22-D-R-K01 | C22S-D-R-K01 |
| | | — | 2NC | C22-D-R-K02 | C22S-D-R-K02 |
| | | — | 1NO/1NC | C22-D-R-K11 | C22S-D-R-K11 |
| X0 | | 1NC | C22-D-R-X0-K01 | C22S-D-R-X0-K01 | |
| X0 | | 2NC | C22-D-R-X0-K02 | C22S-D-R-X0-K02 | |
| X0 | | 1NO/1NC | C22-D-R-X0-K11 | C22S-D-R-X0-K11 | |
| Black | — | 1NC | C22-D-S-K01 | C22S-D-S-K01 | |
| | — | 2NC | C22-D-S-K02 | C22S-D-S-K02 | |
| | — | 1NO/1NC | C22-D-S-K11 | C22S-D-S-K11 | |
| | X0 | 1NC | C22-D-S-X0-K01 | C22S-D-S-X0-K01 | |
| | X0 | 2NC | C22-D-S-X0-K02 | C22S-D-S-X0-K02 | |
| | X0 | 1NO/1NC | C22-D-S-X0-K11 | C22S-D-S-X0-K11 | |
| White | — | 1NO | C22-D-W-K10 | C22S-D-W-K10 | |
| | — | 2NO | C22-D-W-K20 | C22S-D-W-K20 | |
| | — | 1NO/1NC | C22-D-W-K11 | C22S-D-W-K11 | |
| | X1 | 1NO | C22-D-W-X1-K10 | C22S-D-W-X1-K10 | |
| | X1 | 2NO | C22-D-W-X1-K20 | C22S-D-W-X1-K20 | |
| | X1 | 1NO/1NC | C22-D-W-X1-K11 | C22S-D-W-X1-K11 | |
| Buttonless | — | 1NO | C22-D-X-K10 | C22S-D-X-K10 | |
| | — | 2NO | C22-D-X-K20 | C22S-D-X-K20 | |
| | — | 1NC | C22-D-X-K01 | C22S-D-X-K01 | |
| | — | 2NC | C22-D-X-K02 | C22S-D-X-K02 | |
| | — | 1NO/1NC | C22-D-X-K11 | C22S-D-X-K11 | |

1 Non-Illuminated Pushbuttons, Flush, Momentary, with Pigtail

C22-D- 

Non-Illuminated Pushbuttons, Flush, Momentary, with Pigtail

| Button Color | Contacts | Connector Length | Connector Type | Silver Bezel Catalog Number |
|--------------|----------|------------------|-----------------|-----------------------------|
| Green | 1NO | 0.2 | M8 | C22-D-G-K10-P30 |
| | 1NO | 0.2 | M12 | C22-D-G-K10-P1 |
| | 1NO | 0.5 | M8 | C22-D-G-K10-P31 |
| | 1NO | 0.5 | M12 | C22-D-G-K10-P3 |
| | 1NO | 1 | M8 | C22-D-G-K10-P32 |
| | 1NO | 1 | M12 | C22-D-G-K10-P5 |
| | 1NO | 1 | Flying lead | C22-D-G-K10-P62 |
| | 1NO | 3.5 | Flying lead | C22-D-G-K10-P65 |
| Red | 1NC | 0.2 | M8 | C22-D-R-K01-P30 |
| | 1NC | 0.2 | M12 | C22-D-R-K01-P1 |
| | 1NC | 0.5 | M8 | C22-D-R-K01-P31 |
| | 1NC | 0.5 | M12 | C22-D-R-K01-P3 |
| | 1NC | 1 | M8 | C22-D-R-K01-P32 |
| | 1NC | 1 | M12 | C22-D-R-K01-P5 |
| | 1NC | 1 | Flying lead | C22-D-R-K01-P62 |
| | 1NC | 3.5 | Flying lead | C22-D-R-K01-P65 |
| Black | 1NC | 0.2 | M8 | C22-D-S-K01-P30 |
| | 1NC | 0.2 | M12 | C22-D-S-K01-P1 |
| | 1NC | 0.5 | M8 | C22-D-S-K01-P31 |
| | 1NC | 0.5 | M12 | C22-D-S-K01-P3 |
| | 1NC | 1 | M8 | C22-D-S-K01-P32 |
| | 1NC | 1 | M12 | C22-D-S-K01-P5 |
| | 1NC | 1 | Flying lead | C22-D-S-K01-P62 |
| | 1NC | 3.5 | Flying lead | C22-D-S-K01-P65 |
| White | 1NO | 0.2 | M8 | C22-D-W-K10-P30 |
| | 1NO | 0.2 | M12 | C22-D-W-K10-P1 |
| | 1NO | 0.5 | M8 | C22-D-W-K10-P31 |
| | 1NO | 0.5 | M12 | C22-D-W-K10-P3 |
| | 1NO | 1 | M8 | C22-D-W-K10-P32 |
| | 1NO | 1 | M12 | C22-D-W-K10-P5 |
| | 1NO | 1 | Flying lead | C22-D-W-K10-P62 |
| | 1NO | 3.5 | Flying lead | C22-D-W-K10-P65 |
| Buttonless | 1NO | 0.2 | M8 | C22-D-X-K10-P30 |
| | 1NO | 0.2 | M12 | C22-D-X-K10-P1 |
| | 1NO | 0.5 | M8 | C22-D-X-K10-P31 |
| | 1NO | 0.5 | M12 | C22-D-X-K10-P3 |
| | 1NO | 1 | M8 | C22-D-X-K10-P32 |
| | 1NO | 1 | M12 | C22-D-X-K10-P5 |
| | 1NO | 1 | Flying lead | C22-D-X-K10-P62 |
| | 1NO | 3.5 | Flying lead | C22-D-X-K10-P65 |
| | 2NO | 1 | Flying lead | C22-D-X-K20-P62 |
| | 2NO | 3.5 | Flying lead | C22-D-X-K20-P65 |
| | 1NC/1NO | 1 | Flying lead | C22-D-X-K11-P62 |
| | 1NC/1NO | 3.5 | Flying lead | C22-D-X-K11-P65 |
| | 1NC | 0.2 | M8 | C22-D-X-K01-P30 |
| | 1NC | 0.2 | M12 | C22-D-X-K01-P1 |
| | 1NC | 0.5 | M8 | C22-D-X-K01-P31 |
| | 1NC | 0.5 | M12 | C22-D-X-K01-P3 |
| | 1NC | 1 | M8 | C22-D-X-K01-P32 |
| | 1NC | 1 | M12 | C22-D-X-K01-P5 |
| | 1NC | 1 | Flying lead | C22-D-X-K01-P62 |
| | 1NC | 3.5 | Flying lead | C22-D-X-K01-P65 |
| 2NC | 1 | Flying lead | C22-D-X-K02-P62 | |
| 2NC | 3.5 | Flying lead | C22-D-X-K02-P65 | |

Non-Illuminated Pushbuttons, Flush, Maintained

C22(S)-DR-

Non-Illuminated Pushbuttons, Flush, Maintained



| Button Color | Button Etching | Contact Block Configuration | Silver Bezel Catalog Number | Black Bezel Catalog Number |
|--------------|----------------|-----------------------------|-----------------------------|----------------------------|
| Green | — | 1NO | C22-DR-G-K10 | C22S-DR-G-K10 |
| | — | 2NO | C22-DR-G-K20 | C22S-DR-G-K20 |
| | — | 1NO/1NC | C22-DR-G-K11 | C22S-DR-G-K11 |
| | X1 | 1NO | C22-DR-G-X1-K10 | C22S-DR-G-X1-K10 |
| | X1 | 2NO | C22-DR-G-X1-K20 | C22S-DR-G-X1-K20 |
| | X1 | 1NO/1NC | C22-DR-G-X1-K11 | C22S-DR-G-X1-K11 |
| Red | — | 1NC | C22-DR-R-K01 | C22S-DR-R-K01 |
| | — | 2NC | C22-DR-R-K02 | C22S-DR-R-K02 |
| | — | 1NO/1NC | C22-DR-R-K11 | C22S-DR-R-K11 |
| | X0 | 1NC | C22-DR-R-X0-K01 | C22S-DR-R-X0-K01 |
| | X0 | 2NC | C22-DR-R-X0-K02 | C22S-DR-R-X0-K02 |
| | X0 | 1NO/1NC | C22-DR-R-X0-K11 | C22S-DR-R-X0-K11 |
| Black | — | 1NC | C22-DR-S-K01 | C22S-DR-S-K01 |
| | — | 2NC | C22-DR-S-K02 | C22S-DR-S-K02 |
| | — | 1NO/1NC | C22-DR-S-K11 | C22S-DR-S-K11 |
| | X0 | 1NC | C22-DR-S-X0-K01 | C22S-DR-S-X0-K01 |
| | X0 | 2NC | C22-DR-S-X0-K02 | C22S-DR-S-X0-K02 |
| | X0 | 1NO/1NC | C22-DR-S-X0-K11 | C22S-DR-S-X0-K11 |
| White | — | 1NO | C22-DR-W-K10 | C22S-DR-W-K10 |
| | — | 2NO | C22-DR-W-K20 | C22S-DR-W-K20 |
| | — | 1NO/1NC | C22-DR-W-K11 | C22S-DR-W-K11 |
| | X1 | 1NO | C22-DR-W-X1-K10 | C22S-DR-W-X1-K10 |
| | X1 | 2NO | C22-DR-W-X1-K20 | C22S-DR-W-X1-K20 |
| | X1 | 1NO/1NC | C22-DR-W-X1-K11 | C22S-DR-W-X1-K11 |
| Buttonless | — | 1NO | C22-DR-X-K10 | C22S-DR-X-K10 |
| | — | 2NO | C22-DR-X-K20 | C22S-DR-X-K20 |
| | — | 1NC | C22-DR-X-K01 | C22S-DR-X-K01 |
| | — | 2NC | C22-DR-X-K02 | C22S-DR-X-K02 |
| | — | 1NO/1NC | C22-DR-X-K11 | C22S-DR-X-K11 |

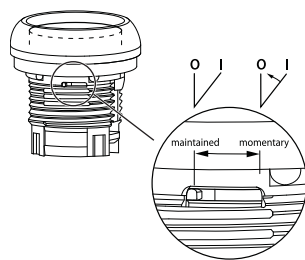

Note: Maintained pushbuttons can be converted in the field to momentary operation by switching the locking ring, which is accessible through the side of the operator body.

1 Non-Illuminated Pushbuttons, Flush, Maintained, with Pigtail

C22-DR- 

Non-Illuminated Pushbuttons, Flush, Maintained, with Pigtail

| Button Color | Contacts | Connector Length | Connector Type | Silver Bezel Catalog Number |
|--------------|----------|------------------|----------------|-----------------------------|
| Green | 1NO | 0.2 | M8 | C22-DR-G-K10-P30 |
| | 1NO | 0.2 | M12 | C22-DR-G-K10-P1 |
| | 1NO | 0.5 | M8 | C22-DR-G-K10-P31 |
| | 1NO | 0.5 | M12 | C22-DR-G-K10-P3 |
| | 1NO | 1 | M8 | C22-DR-G-K10-P32 |
| | 1NO | 1 | M12 | C22-DR-G-K10-P5 |
| | 1NO | 1 | Flying lead | C22-DR-G-K10-P62 |
| | 1NO | 3.5 | Flying lead | C22-DR-G-K10-P65 |
| Red | 1NC | 0.2 | M8 | C22-DR-R-K01-P30 |
| | 1NC | 0.2 | M12 | C22-DR-R-K01-P1 |
| | 1NC | 0.5 | M8 | C22-DR-R-K01-P31 |
| | 1NC | 0.5 | M12 | C22-DR-R-K01-P3 |
| | 1NC | 1 | M8 | C22-DR-R-K01-P32 |
| | 1NC | 1 | M12 | C22-DR-R-K01-P5 |
| | 1NC | 1 | Flying lead | C22-DR-R-K01-P62 |
| | 1NC | 3.5 | Flying lead | C22-DR-R-K01-P65 |
| Black | 1NC | 0.2 | M8 | C22-DR-S-K01-P30 |
| | 1NC | 0.2 | M12 | C22-DR-S-K01-P1 |
| | 1NC | 0.5 | M8 | C22-DR-S-K01-P31 |
| | 1NC | 0.5 | M12 | C22-DR-S-K01-P3 |
| | 1NC | 1 | M8 | C22-DR-S-K01-P32 |
| | 1NC | 1 | M12 | C22-DR-S-K01-P5 |
| | 1NC | 1 | Flying lead | C22-DR-S-K01-P62 |
| | 1NC | 3.5 | Flying lead | C22-DR-S-K01-P65 |
| White | 1NO | 0.2 | M8 | C22-DR-W-K10-P30 |
| | 1NO | 0.2 | M12 | C22-DR-W-K10-P1 |
| | 1NO | 0.5 | M8 | C22-DR-W-K10-P31 |
| | 1NO | 0.5 | M12 | C22-DR-W-K10-P3 |
| | 1NO | 1 | M8 | C22-DR-W-K10-P32 |
| | 1NO | 1 | M12 | C22-DR-W-K10-P5 |
| | 1NO | 1 | Flying lead | C22-DR-W-K10-P62 |
| | 1NO | 3.5 | Flying lead | C22-DR-W-K10-P65 |
| Buttonless | 1NO | 0.2 | M8 | C22-DR-X-K10-P30 |
| | 1NO | 0.2 | M12 | C22-DR-X-K10-P1 |
| | 1NO | 0.5 | M8 | C22-DR-X-K10-P31 |
| | 1NO | 0.5 | M12 | C22-DR-X-K10-P3 |
| | 1NO | 1 | M8 | C22-DR-X-K10-P32 |
| | 1NO | 1 | M12 | C22-DR-X-K10-P5 |
| | 1NO | 1 | Flying lead | C22-DR-X-K10-P62 |
| | 1NO | 3.5 | Flying lead | C22-DR-X-K10-P65 |
| | 2NO | 1 | Flying lead | C22-DR-X-K20-P62 |
| | 2NO | 3.5 | Flying lead | C22-DR-X-K20-P65 |
| | 1NC/1NO | 1 | Flying lead | C22-DR-X-K11-P62 |
| | 1NC/1NO | 3.5 | Flying lead | C22-DR-X-K11-P65 |
| | 1NC | 0.2 | M8 | C22-DR-X-K01-P30 |
| | 1NC | 0.2 | M12 | C22-DR-X-K01-P1 |
| | 1NC | 0.5 | M8 | C22-DR-X-K01-P31 |
| | 1NC | 0.5 | M12 | C22-DR-X-K01-P3 |
| | 1NC | 1 | M8 | C22-DR-X-K01-P32 |
| | 1NC | 1 | M12 | C22-DR-X-K01-P5 |
| | 1NC | 1 | Flying lead | C22-DR-X-K01-P62 |
| | 1NC | 3.5 | Flying lead | C22-DR-X-K01-P65 |
| | 2NC | 1 | Flying lead | C22-DR-X-K02-P62 |
| | 2NC | 3.5 | Flying lead | C22-DR-X-K02-P65 |

Non-Illuminated Pushbuttons, Extended, Momentary

C22(S)-DH-



Non-Illuminated Pushbuttons, Extended, Momentary

| Button Color | Button Etching | Contact Block Configuration | Silver Bezel Catalog Number | Black Bezel Catalog Number |
|--------------|----------------|-----------------------------|-----------------------------|----------------------------|
| Green | — | 1NO | C22-DH-G-K10 | C22S-DH-G-K10 |
| | — | 2NO | C22-DH-G-K20 | C22S-DH-G-K20 |
| | — | 1NO/1NC | C22-DH-G-K11 | C22S-DH-G-K11 |
| | X1 | 1NO | C22-DH-G-X1-K10 | C22S-DH-G-X1-K10 |
| | X1 | 2NO | C22-DH-G-X1-K20 | C22S-DH-G-X1-K20 |
| | X1 | 1NO/1NC | C22-DH-G-X1-K11 | C22S-DH-G-X1-K11 |
| Red | — | 1NC | C22-DH-R-K01 | C22S-DH-R-K01 |
| | — | 2NC | C22-DH-R-K02 | C22S-DH-R-K02 |
| | — | 1NO/1NC | C22-DH-R-K11 | C22S-DH-R-K11 |
| | X0 | 1NC | C22-DH-R-X0-K01 | C22S-DH-R-X0-K01 |
| | X0 | 2NC | C22-DH-R-X0-K02 | C22S-DH-R-X0-K02 |
| | X0 | 1NO/1NC | C22-DH-R-X0-K11 | C22S-DH-R-X0-K11 |
| Black | — | 1NC | C22-DH-S-K01 | C22S-DH-S-K01 |
| | — | 2NC | C22-DH-S-K02 | C22S-DH-S-K02 |
| | — | 1NO/1NC | C22-DH-S-K11 | C22S-DH-S-K11 |
| | X0 | 1NC | C22-DH-S-X0-K01 | C22S-DH-S-X0-K01 |
| | X0 | 2NC | C22-DH-S-X0-K02 | C22S-DH-S-X0-K02 |
| | X0 | 1NO/1NC | C22-DH-S-X0-K11 | C22S-DH-S-X0-K11 |
| White | — | 1NO | C22-DH-W-K10 | C22S-DH-W-K10 |
| | — | 2NO | C22-DH-W-K20 | C22S-DH-W-K20 |
| | — | 1NO/1NC | C22-DH-W-K11 | C22S-DH-W-K11 |
| | X1 | 1NO | C22-DH-W-X1-K10 | C22S-DH-W-X1-K10 |
| | X1 | 2NO | C22-DH-W-X1-K20 | C22S-DH-W-X1-K20 |
| | X1 | 1NO/1NC | C22-DH-W-X1-K11 | C22S-DH-W-X1-K11 |

1 Non-Illuminated Pushbuttons, Extended, Maintained

C22(S)-DRH_



Non-Illuminated Pushbuttons, Extended, Maintained

| Button Color | Button Etching | Contact Block Configuration | Silver Bezel Catalog Number | Black Bezel Catalog Number |
|--------------|----------------|-----------------------------|-----------------------------|----------------------------|
| Green | — | 1NO | C22-DRH-G-K10 | C22S-DRH-G-K10 |
| | — | 2NO | C22-DRH-G-K20 | C22S-DRH-G-K20 |
| | — | 1NO/1NC | C22-DRH-G-K11 | C22S-DRH-G-K11 |
| | X1 | 1NO | C22-DRH-G-X1-K10 | C22S-DRH-G-X1-K10 |
| | X1 | 2NO | C22-DRH-G-X1-K20 | C22S-DRH-G-X1-K20 |
| | X1 | 1NO/1NC | C22-DRH-G-X1-K11 | C22S-DRH-G-X1-K11 |
| Red | — | 1NC | C22-DRH-R-K01 | C22S-DRH-R-K01 |
| | — | 2NC | C22-DRH-R-K02 | C22S-DRH-R-K02 |
| | — | 1NO/1NC | C22-DRH-R-K11 | C22S-DRH-R-K11 |
| | X0 | 1NC | C22-DRH-R-X0-K01 | C22S-DRH-R-X0-K01 |
| | X0 | 2NC | C22-DRH-R-X0-K02 | C22S-DRH-R-X0-K02 |
| | X0 | 1NO/1NC | C22-DRH-R-X0-K11 | C22S-DRH-R-X0-K11 |
| Black | — | 1NC | C22-DRH-S-K01 | C22S-DRH-S-K01 |
| | — | 2NC | C22-DRH-S-K02 | C22S-DRH-S-K02 |
| | — | 1NO/1NC | C22-DRH-S-K11 | C22S-DRH-S-K11 |
| | X0 | 1NC | C22-DRH-S-X0-K01 | C22S-DRH-S-X0-K01 |
| | X0 | 2NC | C22-DRH-S-X0-K02 | C22S-DRH-S-X0-K02 |
| | X0 | 1NO/1NC | C22-DRH-S-X0-K11 | C22S-DRH-S-X0-K11 |
| White | — | 1NO | C22-DRH-W-K10 | C22S-DRH-W-K10 |
| | — | 2NO | C22-DRH-W-K20 | C22S-DRH-W-K20 |
| | — | 1NO/1NC | C22-DRH-W-K11 | C22S-DRH-W-K11 |
| | X1 | 1NO | C22-DRH-W-X1-K10 | C22S-DRH-W-X1-K10 |
| | X1 | 2NO | C22-DRH-W-X1-K20 | C22S-DRH-W-X1-K20 |
| | X1 | 1NO/1NC | C22-DRH-W-X1-K11 | C22S-DRH-W-X1-K11 |

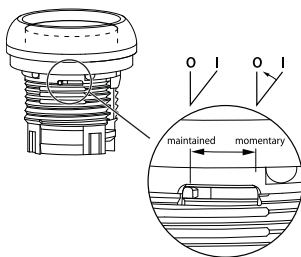

Note: Maintained pushbuttons can be converted in the field to momentary operation by switching the locking ring, which is accessible through the side of the operator body.

Catalog Number Selection

Catalog Number Selection is for illustrative purposes only and not to be used to create new catalog numbers.

Illuminated Pushbuttons

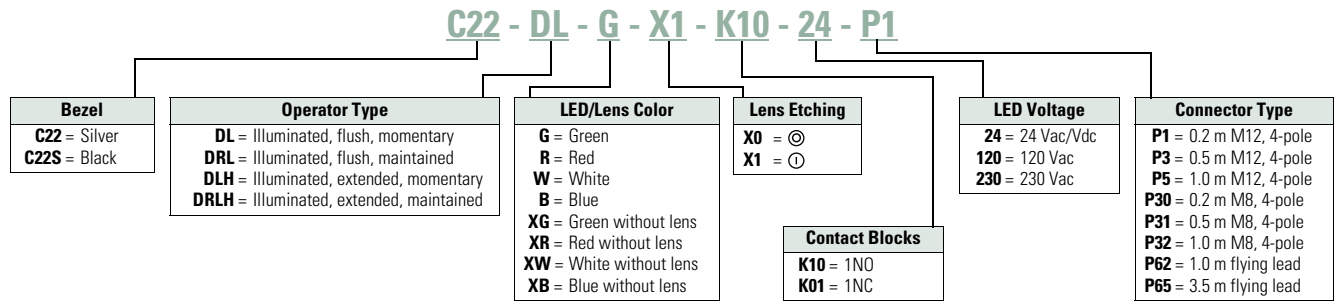

Product Selection

Illuminated, Flush, Momentary

C22(S)-DL- Illuminated Pushbuttons, Flush, Momentary



| LED Color | Button Color | Voltage | Button Etching | Contact Block Configuration | Silver Bezel Catalog Number | Black Bezel Catalog Number |
|-----------|--------------|------------|----------------|-----------------------------|-----------------------------|----------------------------|
| Green | Green | 24 Vac/Vdc | — | 1NO | C22-DL-G-K10-24 | C22S-DL-G-K10-24 |
| | | 120 Vac | — | 1NO | C22-DL-G-K10-120 | C22S-DL-G-K10-120 |
| | | 230 Vac | — | 1NO | C22-DL-G-K10-230 | C22S-DL-G-K10-230 |
| | | 24 Vac/Vdc | X1 | 1NO | C22-DL-G-X1-K10-24 | C22S-DL-G-X1-K10-24 |
| | | 120 Vac | X1 | 1NO | C22-DL-G-X1-K10-120 | C22S-DL-G-X1-K10-120 |
| | | 230 Vac | X1 | 1NO | C22-DL-G-X1-K10-230 | C22S-DL-G-X1-K10-230 |
| | Buttonless | 24 Vac/Vdc | — | 1NO | C22-DL-XG-K10-24 | C22S-DL-XG-K10-24 |
| | | 120 Vac | — | 1NO | C22-DL-XG-K10-120 | C22S-DL-XG-K10-120 |
| | | 230 Vac | — | 1NO | C22-DL-XG-K10-230 | C22S-DL-XG-K10-230 |
| | | 24 Vac/Vdc | X0 | 1NC | C22-DL-R-X0-K01-24 | C22S-DL-R-K01-24 |
| | | 120 Vac | X0 | 1NC | C22-DL-R-X0-K01-120 | C22S-DL-R-K01-120 |
| | | 230 Vac | X0 | 1NC | C22-DL-R-X0-K01-230 | C22S-DL-R-K01-230 |
| Red | Red | 24 Vac/Vdc | — | 1NC | C22-DL-R-K01-24 | C22S-DL-R-K01-24 |
| | | 120 Vac | — | 1NC | C22-DL-R-K01-120 | C22S-DL-R-K01-120 |
| | | 230 Vac | — | 1NC | C22-DL-R-K01-230 | C22S-DL-R-K01-230 |
| | | 24 Vac/Vdc | X0 | 1NC | C22-DL-R-X0-K01-24 | C22S-DL-R-X0-K01-24 |
| | | 120 Vac | X0 | 1NC | C22-DL-R-X0-K01-120 | C22S-DL-R-X0-K01-120 |
| | | 230 Vac | X0 | 1NC | C22-DL-R-X0-K01-230 | C22S-DL-R-X0-K01-230 |
| | Buttonless | 24 Vac/Vdc | — | 1NC | C22-DL-XR-K01-24 | C22S-DL-XR-K01-24 |
| | | 120 Vac | — | 1NC | C22-DL-XR-K01-120 | C22S-DL-XR-K01-120 |
| | | 230 Vac | — | 1NC | C22-DL-XR-K01-230 | C22S-DL-XR-K01-230 |
| | | 24 Vac/Vdc | X1 | 1NO | C22-DL-W-X1-K10-24 | C22S-DL-W-X1-K10-24 |
| | | 120 Vac | X1 | 1NO | C22-DL-W-X1-K10-120 | C22S-DL-W-X1-K10-120 |
| | | 230 Vac | X1 | 1NO | C22-DL-W-X1-K10-230 | C22S-DL-W-X1-K10-230 |
| White | White | 24 Vac/Vdc | — | 1NO | C22-DL-W-K10-24 | C22S-DL-W-K10-24 |
| | | 120 Vac | — | 1NO | C22-DL-W-K10-120 | C22S-DL-W-K10-120 |
| | | 230 Vac | — | 1NO | C22-DL-W-K10-230 | C22S-DL-W-K10-230 |
| | | 24 Vac/Vdc | X1 | 1NO | C22-DL-W-X1-K10-24 | C22S-DL-W-X1-K10-24 |
| | | 120 Vac | X1 | 1NO | C22-DL-W-X1-K10-120 | C22S-DL-W-X1-K10-120 |
| | | 230 Vac | X1 | 1NO | C22-DL-W-X1-K10-230 | C22S-DL-W-X1-K10-230 |
| | Buttonless | 24 Vac/Vdc | — | 1NO | C22-DL-XW-K10-24 | C22S-DL-XW-K10-24 |
| | | 120 Vac | — | 1NO | C22-DL-XW-K10-120 | C22S-DL-XW-K10-120 |
| | | 230 Vac | — | 1NO | C22-DL-XW-K10-230 | C22S-DL-XW-K10-230 |
| | | 24 Vac/Vdc | — | 1NO | C22-DL-B-K10-24 | C22S-DL-B-K10-24 |
| | | 120 Vac | — | 1NO | C22-DL-B-K10-120 | C22S-DL-B-K10-120 |
| | | 230 Vac | — | 1NO | C22-DL-B-K10-230 | C22S-DL-B-K10-230 |
| Blue | Blue | 24 Vac/Vdc | — | 1NO | C22-DL-B-K10-24 | C22S-DL-B-K10-24 |
| | | 120 Vac | — | 1NO | C22-DL-B-K10-120 | C22S-DL-B-K10-120 |
| | | 230 Vac | — | 1NO | C22-DL-B-K10-230 | C22S-DL-B-K10-230 |
| | Buttonless | 24 Vac/Vdc | — | 1NO | C22-DL-XB-K10-24 | C22S-DL-XB-K10-24 |
| | | 120 Vac | — | 1NO | C22-DL-XB-K10-120 | C22S-DL-XB-K10-120 |
| | | 230 Vac | — | 1NO | C22-DL-XB-K10-230 | C22S-DL-XB-K10-230 |

1 Illuminated Pushbuttons, Flush, Momentary, with Pigtail

C22-DL-__



Illuminated Pushbuttons, Flush, Momentary, with Pigtail

| Button Color | Contacts | Connector Length | Connector Type | Silver Bezel Catalog Number |
|--------------|----------|------------------|----------------|-----------------------------|
| Green | 1NO | 0.2 | M8 | C22-DL-G-K10-24-P30 |
| | 1NO | 0.2 | M12 | C22-DL-G-K10-24-P1 |
| | 1NO | 0.5 | M8 | C22-DL-G-K10-24-P31 |
| | 1NO | 0.5 | M12 | C22-DL-G-K10-24-P3 |
| | 1NO | 1 | M8 | C22-DL-G-K10-24-P32 |
| | 1NO | 1 | M12 | C22-DL-G-K10-24-P5 |
| | 1NO | 1 | Flying lead | C22-DL-G-K10-24-P62 |
| | 1NO | 3.5 | Flying lead | C22-DL-G-K10-24-P65 |
| Red | 1NC | 0.2 | M8 | C22-DL-R-K01-24-P30 |
| | 1NC | 0.2 | M12 | C22-DL-R-K01-24-P1 |
| | 1NC | 0.5 | M8 | C22-DL-R-K01-24-P31 |
| | 1NC | 0.5 | M12 | C22-DL-R-K01-24-P3 |
| | 1NC | 1 | M8 | C22-DL-R-K01-24-P32 |
| | 1NC | 1 | M12 | C22-DL-R-K01-24-P5 |
| | 1NC | 1 | Flying lead | C22-DL-R-K01-24-P62 |
| | 1NC | 3.5 | Flying lead | C22-DL-R-K01-24-P65 |
| Blue | 1NO | 0.2 | M8 | C22-DL-B-K10-24-P30 |
| | 1NO | 0.2 | M12 | C22-DL-B-K10-24-P1 |
| | 1NO | 0.5 | M8 | C22-DL-B-K10-24-P31 |
| | 1NO | 0.5 | M12 | C22-DL-B-K10-24-P3 |
| | 1NO | 1 | M8 | C22-DL-B-K10-24-P32 |
| | 1NO | 1 | M12 | C22-DL-B-K10-24-P5 |
| | 1NO | 1 | Flying lead | C22-DL-B-K10-24-P62 |
| | 1NO | 3.5 | Flying lead | C22-DL-B-K10-24-P65 |
| White | 1NO | 0.2 | M8 | C22-DL-W-K10-24-P30 |
| | 1NO | 0.2 | M12 | C22-DL-W-K10-24-P1 |
| | 1NO | 0.5 | M8 | C22-DL-W-K10-24-P31 |
| | 1NO | 0.5 | M12 | C22-DL-W-K10-24-P3 |
| | 1NO | 1 | M8 | C22-DL-W-K10-24-P32 |
| | 1NO | 1 | M12 | C22-DL-W-K10-24-P5 |
| | 1NO | 1 | Flying lead | C22-DL-W-K10-24-P62 |
| | 1NO | 3.5 | Flying lead | C22-DL-W-K10-24-P65 |

Illuminated Pushbuttons, Flush, Maintained

C22(S)-DRL_

Illuminated Pushbuttons, Flush, Maintained



| LED Color | Button Color | Voltage | Contact Block Configuration | Silver Bezel Catalog Number | Black Bezel Catalog Number | | |
|------------|--------------|------------|-----------------------------|-----------------------------|----------------------------|---------------------|--------------------|
| Green | Green | 24 Vac/Vdc | 1NO | C22-DRL-G-K10-24 | C22S-DRL-G-K10-24 | | |
| | | 120 Vac | 1NO | C22-DRL-G-K10-120 | C22S-DRL-G-K10-120 | | |
| | | 230 Vac | 1NO | C22-DRL-G-K10-230 | C22S-DRL-G-K10-230 | | |
| | Buttonless | 24 Vac/Vdc | 1NO | C22-DRL-XG-K10-24 | C22S-DRL-XG-K10-24 | | |
| | | | 120 Vac | 1NO | C22-DRL-XG-K10-120 | C22S-DRL-XG-K10-120 | |
| | | | 230 Vac | 1NO | C22-DRL-XG-K10-230 | C22S-DRL-XG-K10-230 | |
| | | Red | 24 Vac/Vdc | 1NC | C22-DRL-R-K01-24 | C22S-DRL-R-K01-24 | |
| | | | | 120 Vac | 1NC | C22-DRL-R-K01-120 | C22S-DRL-R-K01-120 |
| | | | | 230 Vac | 1NC | C22-DRL-R-K01-230 | C22S-DRL-R-K01-230 |
| Buttonless | 24 Vac/Vdc | 1NC | C22-DRL-XR-K01-24 | C22S-DRL-XR-K01-24 | | | |
| | | 120 Vac | 1NC | C22-DRL-XR-K01-120 | C22S-DRL-XR-K01-120 | | |
| | | 230 Vac | 1NC | C22-DRL-XR-K01-230 | C22S-DRL-XR-K01-230 | | |
| | White | White | 24 Vac/Vdc | 1NO | C22-DRL-W-K10-24 | C22S-DRL-W-K10-24 | |
| | | | 120 Vac | 1NO | C22-DRL-W-K10-120 | C22S-DRL-W-K10-120 | |
| | | | 230 Vac | 1NO | C22-DRL-W-K10-230 | C22S-DRL-W-K10-230 | |
| Buttonless | | 24 Vac/Vdc | 1NO | C22-DRL-XW-K10-24 | C22S-DRL-XW-K10-24 | | |
| | | | 120 Vac | 1NO | C22-DRL-XW-K10-120 | C22S-DRL-XW-K10-120 | |
| | | | 230 Vac | 1NO | C22-DRL-XW-K10-230 | C22S-DRL-XW-K10-230 | |
| | | Blue | Blue | 24 Vac/Vdc | 1NO | C22-DRL-B-K10-24 | C22S-DRL-B-K10-24 |
| | | | | 120 Vac | 1NO | C22-DRL-B-K10-120 | C22S-DRL-B-K10-120 |
| | | | | 230 Vac | 1NO | C22-DRL-B-K10-230 | C22S-DRL-B-K10-230 |
| Buttonless | 24 Vac/Vdc | | 1NO | C22-DRL-XB-K10-24 | C22S-DRL-XB-K10-24 | | |
| | | | 120 Vac | 1NO | C22-DRL-XB-K10-120 | C22S-DRL-XB-K10-120 | |
| | | | 230 Vac | 1NO | C22-DRL-XB-K10-230 | C22S-DRL-XB-K10-230 | |

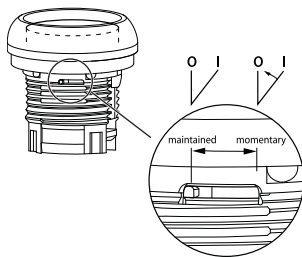

Note: Maintained pushbuttons can be converted in the field to momentary operation by switching the locking ring, which is accessible through the side of the operator body.

1 Illuminated Pushbuttons, Flush, Maintained, with Pigtail

C22_DRL-G_



Illuminated Pushbuttons, Flush, Maintained, with Pigtail

| Button Color | Contacts | Connector Length | Connector Type | Silver Bezel Catalog Number |
|--------------|----------|------------------|----------------|-----------------------------|
| Green | 1NO | 0.2 | M8 | C22-DRL-G-K10-24-P30 |
| | 1NO | 0.2 | M12 | C22-DRL-G-K10-24-P1 |
| | 1NO | 0.5 | M8 | C22-DRL-G-K10-24-P31 |
| | 1NO | 0.5 | M12 | C22-DRL-G-K10-24-P3 |
| | 1NO | 1 | M8 | C22-DRL-G-K10-24-P32 |
| | 1NO | 1 | M12 | C22-DRL-G-K10-24-P5 |
| | 1NO | 1 | Flying lead | C22-DRL-G-K10-24-P62 |
| | 1NO | 3.5 | Flying lead | C22-DRL-G-K10-24-P65 |
| Red | 1NC | 0.2 | M8 | C22-DRL-R-K01-24-P30 |
| | 1NC | 0.2 | M12 | C22-DRL-R-K01-24-P1 |
| | 1NC | 0.5 | M8 | C22-DRL-R-K01-24-P31 |
| | 1NC | 0.5 | M12 | C22-DRL-R-K01-24-P3 |
| | 1NC | 1 | M8 | C22-DRL-R-K01-24-P32 |
| | 1NC | 1 | M12 | C22-DRL-R-K01-24-P5 |
| | 1NC | 1 | Flying lead | C22-DRL-R-K01-24-P62 |
| | 1NC | 3.5 | Flying lead | C22-DRL-R-K01-24-P65 |
| Blue | 1NO | 0.2 | M8 | C22-DRL-B-K10-24-P30 |
| | 1NO | 0.2 | M12 | C22-DRL-B-K10-24-P1 |
| | 1NO | 0.5 | M8 | C22-DRL-B-K10-24-P31 |
| | 1NO | 0.5 | M12 | C22-DRL-B-K10-24-P3 |
| | 1NO | 1 | M8 | C22-DRL-B-K10-24-P32 |
| | 1NO | 1 | M12 | C22-DRL-B-K10-24-P5 |
| | 1NO | 1 | Flying lead | C22-DRL-B-K10-24-P62 |
| | 1NO | 3.5 | Flying lead | C22-DRL-B-K10-24-P65 |
| White | 1NO | 0.2 | M8 | C22-DRL-W-K10-24-P30 |
| | 1NO | 0.2 | M12 | C22-DRL-W-K10-24-P1 |
| | 1NO | 0.5 | M8 | C22-DRL-W-K10-24-P31 |
| | 1NO | 0.5 | M12 | C22-DRL-W-K10-24-P3 |
| | 1NO | 1 | M8 | C22-DRL-W-K10-24-P32 |
| | 1NO | 1 | M12 | C22-DRL-W-K10-24-P5 |
| | 1NO | 1 | Flying lead | C22-DRL-W-K10-24-P62 |
| | 1NO | 3.5 | Flying lead | C22-DRL-W-K10-24-P65 |

Illuminated Pushbuttons, Extended, Momentary

C22(S)-DLH_

Illuminated Pushbuttons, Extended, Momentary



| LED Color | Button Color | Voltage | Button Etching | Contact Block Configuration | Silver Bezel Catalog Number | Black Bezel Catalog Number |
|-----------|--------------|------------|----------------|-----------------------------|-----------------------------|----------------------------|
| Green | Green | 24 Vac/Vdc | — | 1NO | C22-DLH-G-K10-24 | C22S-DLH-G-K10-24 |
| | | 120 Vac | — | 1NO | C22-DLH-G-K10-120 | C22S-DLH-G-K10-120 |
| | | 230 Vac | — | 1NO | C22-DLH-G-K10-230 | C22S-DLH-G-K10-230 |
| | | 24 Vac/Vdc | X1 | 1NO | C22-DLH-G-X1-K10-24 | C22S-DLH-G-X1-K10-24 |
| | | 120 Vac | X1 | 1NO | C22-DLH-G-X1-K10-120 | C22S-DLH-G-X1-K10-12 |
| | | 230 Vac | X1 | 1NO | C22-DLH-G-X1-K10-230 | C22S-DLH-G-X1-K10-23 |
| | | 24 Vac/Vdc | — | 1NC | C22-DLH-R-K01-24 | C22S-DLH-R-K01-24 |
| | | 120 Vac | — | 1NC | C22-DLH-R-K01-120 | C22S-DLH-R-K01-120 |
| | | 230 Vac | — | 1NC | C22-DLH-R-K01-230 | C22S-DLH-R-K01-230 |
| Red | Red | 24 Vac/Vdc | X0 | 1NC | C22-DLH-R-X0-K01-24 | C22S-DLH-R-X0-K01-24 |
| | | 120 Vac | X0 | 1NC | C22-DLH-R-X0-K01-120 | C22S-DLH-R-X0-K01-12 |
| | | 230 Vac | X0 | 1NC | C22-DLH-R-X0-K01-230 | C22S-DLH-R-X0-K01-23 |
| | | 24 Vac/Vdc | — | 1NO | C22-DLH-W-K10-24 | C22S-DLH-W-K10-24 |
| | | 120 Vac | — | 1NO | C22-DLH-W-K10-120 | C22S-DLH-W-K10-120 |
| | | 230 Vac | — | 1NO | C22-DLH-W-K10-230 | C22S-DLH-W-K10-230 |
| | | 24 Vac/Vdc | X1 | 1NO | C22-DLH-W-X1-K10-24 | C22S-DLH-W-X1-K10-24 |
| | | 120 Vac | X1 | 1NO | C22-DLH-W-X1-K10-120 | C22S-DLH-W-X1-K10-12 |
| | | 230 Vac | X1 | 1NO | C22-DLH-W-X1-K10-230 | C22S-DLH-W-X1-K10-23 |
| White | White | 24 Vac/Vdc | — | 1NO | C22-DLH-B-K10-24 | C22S-DLH-B-K10-24 |
| | | 120 Vac | — | 1NO | C22-DLH-B-K10-120 | C22S-DLH-B-K10-120 |
| | | 230 Vac | — | 1NO | C22-DLH-B-K10-230 | C22S-DLH-B-K10-230 |
| | | 24 Vac/Vdc | — | 1NO | C22-DLH-B-K10-24 | C22S-DLH-B-K10-24 |
| | | 120 Vac | — | 1NO | C22-DLH-B-K10-120 | C22S-DLH-B-K10-120 |
| | | 230 Vac | — | 1NO | C22-DLH-B-K10-230 | C22S-DLH-B-K10-230 |
| Blue | Blue | 24 Vac/Vdc | — | 1NO | C22-DLH-B-K10-24 | C22S-DLH-B-K10-24 |
| | | 120 Vac | — | 1NO | C22-DLH-B-K10-120 | C22S-DLH-B-K10-120 |
| | | 230 Vac | — | 1NO | C22-DLH-B-K10-230 | C22S-DLH-B-K10-230 |

Illuminated Pushbuttons, Extended, Maintained

C22(S)-DRLH-

Illuminated Pushbuttons, Flush Extended, Maintained



| LED Color | Button Color | Voltage | Button Etching | Contact Block Configuration | Silver Bezel Catalog Number | Black Bezel Catalog Number |
|-----------|--------------|------------|----------------|-----------------------------|-----------------------------|----------------------------|
| Green | Green | 24 Vac/Vdc | — | 1NO | C22-DRLH-G-K10-24 | C22S-DRLH-G-K10-24 |
| | | 120 Vac | — | 1NO | C22-DRLH-G-K10-120 | C22S-DRLH-G-K10-120 |
| | | 230 Vac | — | 1NO | C22-DRLH-G-K10-230 | C22S-DRLH-G-K10-230 |
| | | 24 Vac/Vdc | X1 | 1NO | C22-DRLH-G-X1-K10-24 | C22S-DRLH-G-X1-K10-24 |
| | | 120 Vac | X1 | 1NO | C22-DRLH-G-X1-K10-120 | C22S-DRLH-G-X1-K10-120 |
| | | 230 Vac | X1 | 1NO | C22-DRLH-G-X1-K10-230 | C22S-DRLH-G-X1-K10-230 |
| Red | Red | 24 Vac/Vdc | — | 1NC | C22-DRLH-R-K01-24 | C22S-DRLH-R-K01-24 |
| | | 120 Vac | — | 1NC | C22-DRLH-R-K01-120 | C22S-DRLH-R-K01-120 |
| | | 230 Vac | — | 1NC | C22-DRLH-R-K01-230 | C22S-DRLH-R-K01-230 |
| | | 24 Vac/Vdc | X0 | 1NC | C22-DRLH-R-X0-K01-24 | C22S-DRLH-R-X0-K01-24 |
| | | 120 Vac | X0 | 1NC | C22-DRLH-R-X0-K01-120 | C22S-DRLH-R-X0-K01-120 |
| | | 230 Vac | X0 | 1NC | C22-DRLH-R-X0-K01-230 | C22S-DRLH-R-X0-K01-230 |
| White | White | 24 Vac/Vdc | — | 1NO | C22-DRLH-W-K10-24 | C22S-DRLH-W-K10-24 |
| | | 120 Vac | — | 1NO | C22-DRLH-W-K10-120 | C22S-DRLH-W-K10-120 |
| | | 230 Vac | — | 1NO | C22-DRLH-W-K10-230 | C22S-DRLH-W-K10-230 |
| | | 24 Vac/Vdc | X1 | 1NO | C22-DRLH-W-X1-K10-24 | C22S-DRLH-W-X1-K10-24 |
| | | 120 Vac | X1 | 1NO | C22-DRLH-W-X1-K10-120 | C22S-DRLH-W-X1-K10-120 |
| | | 230 Vac | X1 | 1NO | C22-DRLH-W-X1-K10-230 | C22S-DRLH-W-X1-K10-230 |
| Blue | Blue | 24 Vac/Vdc | — | 1NO | C22-DRLH-B-K10-24 | C22S-DRLH-B-K10-24 |
| | | 120 Vac | — | 1NO | C22-DRLH-B-K10-120 | C22S-DRLH-B-K10-120 |
| | | 230 Vac | — | 1NO | C22-DRLH-B-K10-230 | C22S-DRLH-B-K10-230 |

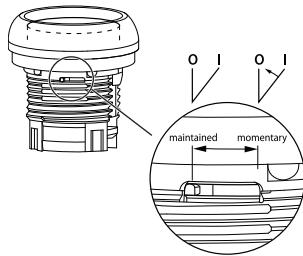

Note: Maintained pushbuttons can be converted in the field to momentary operation by switching the locking ring, which is accessible through the side of the operator body.

Indicating Lights



Contents

| Description | Page |
|---|------------------|
| Pushbuttons—Non-Illuminated and Illuminated | V7-T1-134 |
| Indicating Lights | |
| Catalog Number Selection | V7-T1-148 |
| Product Selection | V7-T1-148 |
| Emergency Stops | V7-T1-150 |
| Selector Switches | V7-T1-153 |
| Technical Data and Specifications | V7-T1-160 |
| Dimensions | V7-T1-162 |

Indicating Lights

Product Description

C22 indicating lights use a combination of a durable, bright LED unit and modern lenses designed specifically for this type of LED to create a bright and visible indicating light. As with the pushbuttons, the indicating light lenses can be laser etched, simply order without lens and order M22/C22 custom etched lenses to attach.

Indicating lights with pigtail have options for M12, M8, or flying lead connectors, providing high degree of protection options.

Note: For additional accessories, please see **Pages V7-T1-105 to V7-T1-111**, 22.5 mm Modular Pushbuttons—M22 Accessories.

Features

- LED offering only for improved brightness quality and up to 100,000 hours of operation
- Lenses specifically designed for LED illumination
- Lenses capable of being laser etched for custom solutions that last
- Units with pigtail allow for direct machine mounting with high degree of protection backside

Protection Type

- IP67/IP69K
- NEMA 4X, 13
- IP65 rear rating with pigtail

1

Catalog Number Selection

Catalog Number Selection is for illustrative purposes only and not to be used to create new catalog numbers.

Indicating Lights

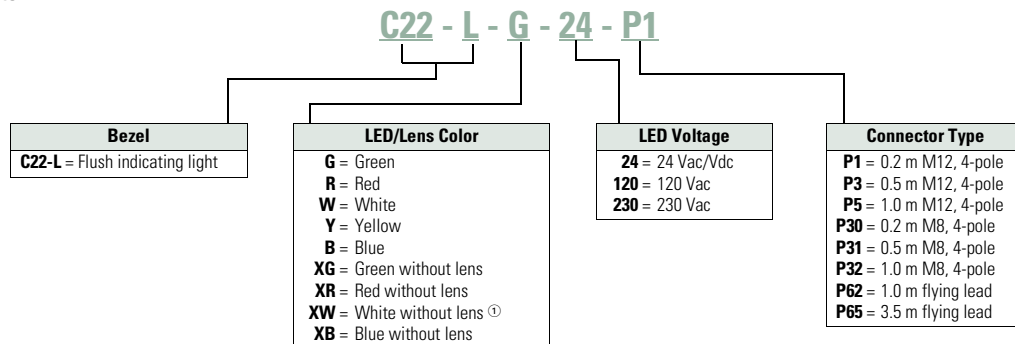

Product Selection

Indicating Lights

C22-L-

Indicating Lights



| Lens Color | LED Color | Voltage | Catalog Number |
|--------------|-----------|------------|---------------------|
| Green | Green | 24 Vac/Vdc | C22-L-G-24 |
| | | 120 Vac | C22-L-G-120 |
| | | 230 Vac | C22-L-G-230 |
| Red | Red | 24 Vac/Vdc | C22-L-R-24 |
| | | 120 Vac | C22-L-R-120 |
| | | 230 Vac | C22-L-R-230 |
| White | White | 24 Vac/Vdc | C22-L-W-24 |
| | | 120 Vac | C22-L-W-120 |
| | | 230 Vac | C22-L-W-230 |
| Yellow | White | 24 Vac/Vdc | C22-L-Y-24 |
| | | 120 Vac | C22-L-Y-120 |
| | | 230 Vac | C22-L-Y-230 |
| Blue | Blue | 24 Vac/Vdc | C22-L-B-24 |
| | | 120 Vac | C22-L-B-120 |
| | | 230 Vac | C22-L-B-230 |
| Without Lens | Green | 24 Vac/Vdc | C22-L-XG-24 |
| | | 120 Vac | C22-L-XG-120 |
| | | 230 Vac | C22-L-XG-230 |
| | Red | 24 Vac/Vdc | C22-L-XR-24 |
| | | 120 Vac | C22-L-XR-120 |
| | | 230 Vac | C22-L-XR-230 |
| | White | 24 Vac/Vdc | C22-L-XW-24 |
| | | 120 Vac | C22-L-XW-120 |
| | | 230 Vac | C22-L-XW-230 |
| | Blue | 24 Vac/Vdc | C22-L-XB-24 |
| | | 120 Vac | C22-L-XB-120 |
| | | 230 Vac | C22-L-XB-230 |

Note

Ⓢ Use white LED for both white and yellow lenses.

C22 with Pigtail LED Options

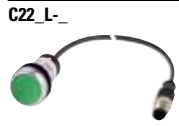

C22 with Pigtail LED Options

24 Vac/Vdc only indicating lights.

| Color | Connector Type | 0.2 m Catalog Number | 0.5 m Catalog Number | 1.0 m Catalog Number | 3.5 m Catalog Number |
|--------|----------------|----------------------|----------------------|----------------------|----------------------|
| Green | M8 | C22-L-G-24-P30 | C22-L-G-24-P31 | C22-L-G-24-P32 | — |
| | M12 | C22-L-G-24-P1 | C22-L-G-24-P3 | C22-L-G-24-P5 | — |
| | Flying lead | — | — | C22-L-G-24-P62 | C22-L-G-24-P65 |
| Red | M8 | C22-L-R-24-P30 | C22-L-R-24-P31 | C22-L-R-24-P32 | — |
| | M12 | C22-L-R-24-P1 | C22-L-R-24-P3 | C22-L-R-24-P5 | — |
| | Flying lead | — | — | C22-L-R-24-P62 | C22-L-R-24-P65 |
| White | M8 | C22-L-W-24-P30 | C22-L-W-24-P31 | C22-L-W-24-P32 | — |
| | M12 | C22-L-W-24-P1 | C22-L-W-24-P3 | C22-L-W-24-P5 | — |
| | Flying lead | — | — | C22-L-W-24-P62 | C22-L-W-24-P65 |
| Yellow | M8 | C22-L-Y-24-P30 | C22-L-Y-24-P31 | C22-L-Y-24-P32 | — |
| | M12 | C22-L-Y-24-P1 | C22-L-Y-24-P3 | C22-L-Y-24-P5 | — |
| | Flying lead | — | — | C22-L-Y-24-P62 | C22-L-Y-24-P65 |
| Blue | M8 | C22-L-B-24-P30 | C22-L-B-24-P31 | C22-L-B-24-P32 | — |
| | M12 | C22-L-B-24-P1 | C22-L-B-24-P3 | C22-L-B-24-P5 | — |
| | Flying lead | — | — | C22-L-B-24-P62 | C22-L-B-24-P65 |

Emergency Stops



Emergency Stops

Product Description

C22 emergency stops are a durable and reliable solution to a variety of e-stop applications. This compact e-stop, available as twist-to-release and keyed-release, is a simple product that eliminates the need for self-monitoring contact blocks, all while still meeting almost all of the industry safety standards.

E-stops with pigtails allow for direct machine mounting, eliminating the need for an enclosure with high degree of rear protection. Flying leads also allow for quick termination to nearby controls or functional safety devices.

Note: For additional accessories, please see **Pages V7-T1-105 to V7-T1-111**, 22.5 mm Modular Pushbuttons—M22 Accessories.

Features

- Available in push-pull, twist-release, twist-release with indicator, and key release 38 mm through 60 mm operators
- Available with M12 or flying lead pigtails, allowing direct machine mounting and easy reliable connections
- Meet functional safety requirements for E-stops

Contents

Description**Page**

| | |
|---|------------------|
| Pushbuttons—Non-Illuminated and Illuminated | V7-T1-134 |
| Indicating Lights | V7-T1-147 |
| Emergency Stops | |
| Non-Illuminated, Twist-Release | V7-T1-151 |
| Non-Illuminated, Keyed-Release | V7-T1-151 |
| Selector Switches | V7-T1-153 |
| Technical Data and Specifications | V7-T1-160 |
| Dimensions | V7-T1-162 |

Protection Type

- Twist-Release
 - IP67/IP69K
- Keyed-Release
 - IP66
- NEMA 4X, 13
- With pigtail
 - IP65 rear rating

Catalog Number Selection

Catalog Number Selection is for illustrative purposes only and not to be used to create new catalog numbers.

Emergency Stops

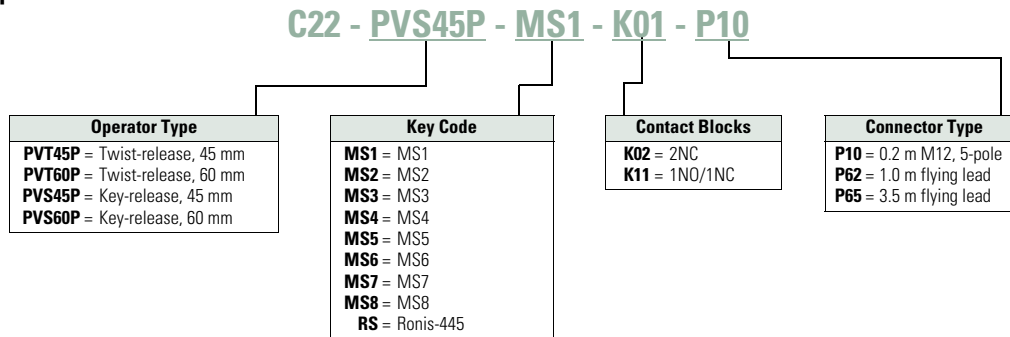

Product Selection

Non-Illuminated, Twist-Release

C22-PVT_ Non-Illuminated Emergency Stops, Twist-Release



| Release Method | Operator Size | Contact Block Configuration | Catalog Number |
|----------------|---------------|-----------------------------|-----------------------|
| Twist-release | 45 mm | 2NC | C22-PVT45P-K02 |
| | | 1NO/1NC | C22-PVT45P-K11 |
| | 60 mm | 2NC | C22-PVT60P-K02 |
| | | 1NO/1NC | C22-PVT60P-K11 |

Non-Illuminated, Keyed-Release

C22-PVS_ Non-Illuminated Emergency Stops, Keyed-Release



| Release Method | Operator Size | Key Code | Contact Block Configuration | Catalog Number |
|----------------|---------------|--------------------------|-----------------------------|---------------------------|
| Keyed-release | 45 mm | MS1 | 2NC | C22-PVS45P-MS1-K02 |
| | | | 1NO/1NC | C22-PVS45P-MS1-K11 |
| | | MS2 | 2NC | C22-PVS45P-MS2-K02 |
| | | | 1NO/1NC | C22-PVS45P-MS2-K11 |
| | | MS3 | 2NC | C22-PVS45P-MS3-K02 |
| | | | 1NO/1NC | C22-PVS45P-MS3-K11 |
| | | MS4 | 2NC | C22-PVS45P-MS4-K02 |
| | | | 1NO/1NC | C22-PVS45P-MS4-K11 |
| | | MS5 | 2NC | C22-PVS45P-MS5-K02 |
| | | | 1NO/1NC | C22-PVS45P-MS5-K11 |
| | | MS6 | 2NC | C22-PVS45P-MS6-K02 |
| | | | 1NO/1NC | C22-PVS45P-MS6-K11 |
| | | MS7 | 2NC | C22-PVS45P-MS7-K02 |
| | | | 1NO/1NC | C22-PVS45P-MS7-K11 |
| | | MS8 | 2NC | C22-PVS45P-MS8-K02 |
| | | | 1NO/1NC | C22-PVS45P-MS8-K11 |
| Ronis | 2NC | C22-PVS45P-RS-K02 | | |
| | 1NO/1NC | C22-PVS45P-RS-K11 | | |

Note: ⊕ = Safety function implemented with positive opening as defined in IEC/EN 60947-5-1.

C22-PVS_





Non-Illuminated Emergency Stops, Keyed-Release, continued

| Release Method | Operator Size | Key Code | Contact Block Configuration | Catalog Number |
|----------------|---------------|--------------------------|-----------------------------|---------------------------|
| Keyed-release | 60 mm | MS1 | 2NC | C22-PVS60P-MS1-K02 |
| | | | 1NO/1NC | C22-PVS60P-MS1-K11 |
| | | MS2 | 2NC | C22-PVS60P-MS2-K02 |
| | | | 1NO/1NC | C22-PVS60P-MS2-K11 |
| | | MS3 | 2NC | C22-PVS60P-MS3-K02 |
| | | | 1NO/1NC | C22-PVS60P-MS3-K11 |
| | | MS4 | 2NC | C22-PVS60P-MS4-K02 |
| | | | 1NO/1NC | C22-PVS60P-MS4-K11 |
| | | MS5 | 2NC | C22-PVS60P-MS5-K02 |
| | | | 1NO/1NC | C22-PVS60P-MS5-K11 |
| | | MS6 | 2NC | C22-PVS60P-MS6-K02 |
| | | | 1NO/1NC | C22-PVS60P-MS6-K11 |
| | | MS7 | 2NC | C22-PVS60P-MS7-K02 |
| | | | 1NO/1NC | C22-PVS60P-MS7-K11 |
| | | MS8 | 2NC | C22-PVS60P-MS8-K02 |
| | | | 1NO/1NC | C22-PVS60P-MS8-K11 |
| Ronis | 2NC | C22-PVS60P-RS-K02 | | |
| | 1NO/1NC | C22-PVS60P-RS-K11 | | |

E-stop

E-stop

| Release Method | Operator Size | Contacts | Connector Length | Connector Type | Catalog Number | |
|---|--|----------|------------------|----------------|----------------|----------------------------|
| C22-PV-K11-P62  | Push-pull | 38 mm | 2NC | 1 | Flying lead | C22-PV-K02-P62 |
| | | | 2NC | 3.5 | Flying lead | C22-PV-K02-P65 |
| | | | 1NO/1NC | 1 | Flying lead | C22-PV-K11-P62 |
| | | | 1NO/1NC | 3.5 | Flying lead | C22-PV-K11-P65 |
| | | | 2NC | 0.2 | M12, 5-pole | C22-PV-K02-P10 |
| C22-PVT-K02-P65  | Twist release | 38 mm | 2NC | 1 | Flying lead | C22-PVT-K02-P62 |
| | | | 2NC | 3.5 | Flying lead | C22-PVT-K02-P65 |
| | | | 1NO/1NC | 1 | Flying lead | C22-PVT-K11-P62 |
| | | | 1NO/1NC | 3.5 | Flying lead | C22-PVT-K11-P65 |
| | | | 2NC | 1 | Flying lead | C22-PVT45P-K02-P62 |
| | | | 2NC | 3.5 | Flying lead | C22-PVT45P-K02-P65 |
| | | | 1NO/1NC | 1 | Flying lead | C22-PVT45P-K11-P62 |
| | | | 1NO/1NC | 3.5 | Flying lead | C22-PVT45P-K11-P65 |
| | | | 2NC | 0.2 | M12, 5-pole | C22-PVT45P-K02-P10 |
| C22-PVT45PMPK02-P65  | Twist release mechanical indication | 45 mm | 2NC | 1 | Flying lead | C22-PVT45PMPK02-P62 |
| | | | 2NC | 3.5 | Flying lead | C22-PVT45PMPK02-P65 |
| | | | 1NO/1NC | 1 | Flying lead | C22-PVT45PMPK11-P62 |
| | | | 1NO/1NC | 3.5 | Flying lead | C22-PVT45PMPK11-P65 |

Note: \ominus = Safety function implemented with positive opening as defined in IEC/EN 60947-5-1.

Selector Switches



Contents

| <i>Description</i> | <i>Page</i> |
|---|------------------|
| Pushbuttons—Non-Illuminated and Illuminated | V7-T1-134 |
| Indicating Lights | V7-T1-147 |
| Emergency Stops | V7-T1-150 |
| Selector Switches | |
| Non-Illuminated, Knob Type | V7-T1-154 |
| Non-Illuminated, Key Operated | V7-T1-156 |
| Technical Data and Specifications | V7-T1-160 |
| Dimensions | V7-T1-162 |

Selector Switches

Product Description

With over 20 variations of operation and 8 varieties of key codes, the C22 line offers a very complete line of selector switches.

Pigtail units come in M12, M8 or flying lead options.

Note: For additional accessories, please see **Pages V7-T1-105 to V7-T1-111**, 22.5 mm Modular Pushbuttons—M22 Accessories.

Features

- Selector switch (non-keyed) rated for 1 million mechanical operations
- Rear pigtails provide IP65 front and rear ratings, eliminating enclosure requirements and reducing installation times

Protection Type

- IP65
- NEMA 4X, 13

1

Catalog Number Selection

Catalog Number Selection is for illustrative purposes only and not to be used to create new catalog numbers.

Selector Switches—Non-Keyed

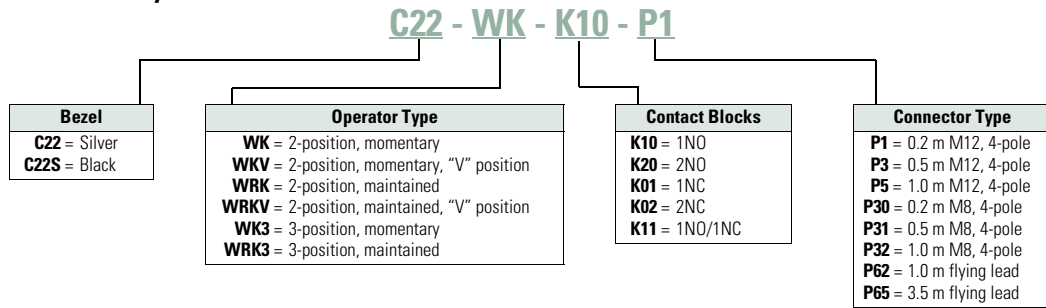

Product Selection

Non-Illuminated, Knob Type

C22(S)-WK- /
C22(S)-WRK_



Non-Illuminated Selector Switches, Knob Type

| Type | Switching Position | Contact Block Configuration | Silver Bezel Catalog Number | Black Bezel Catalog Number |
|-----------------------|-----------------------|-----------------------------|-----------------------------|----------------------------|
| Two-position | Momentary 40° | 1NO | C22-WK-K10 | C22S-WK-K10 |
| | | 2NO | C22-WK-K20 | C22S-WK-K20 |
| | | 1NC | C22-WK-K01 | C22S-WK-K01 |
| | | 2NC | C22-WK-K02 | C22S-WK-K02 |
| | | 1NO/1NC | C22-WK-K11 | C22S-WK-K11 |
| | | 1NO | C22-WKV-K10 | C22S-WKV-K10 |
| | Momentary 60° | 2NO | C22-WKV-K20 | C22S-WKV-K20 |
| | | 1NC | C22-WKV-K01 | C22S-WKV-K01 |
| | | 2NC | C22-WKV-K02 | C22S-WKV-K02 |
| | | 1NO/1NC | C22-WKV-K11 | C22S-WKV-K11 |
| | | 1NO | C22-WRK-K10 | C22S-WRK-K10 |
| | | 2NO | C22-WRK-K20 | C22S-WRK-K20 |
| | Maintained 40° | 1NC | C22-WRK-K01 | C22S-WRK-K01 |
| | | 2NC | C22-WRK-K02 | C22S-WRK-K02 |
| | | 1NO/1NC | C22-WRK-K11 | C22S-WRK-K11 |
| | | 1NO | C22-WRKV-K10 | C22S-WRKV-K10 |
| | | 2NO | C22-WRKV-K20 | C22S-WRKV-K20 |
| | | 1NC | C22-WRKV-K01 | C22S-WRKV-K01 |
| Maintained 60° | 2NC | C22-WRKV-K02 | C22S-WRKV-K02 | |
| | 1NO/1NC | C22-WRKV-K11 | C22S-WRKV-K11 | |
| | 2NO | C22-WK3-K20 | C22S-WK3-K20 | |
| | Three-position 40° | 2NC | C22-WK3-K02 | C22S-WK3-K02 |
| | | 1NO/1NC | C22-WK3-K11 | C22S-WK3-K11 |
| | | 2NO | C22-WRK3-K20 | C22S-WRK3-K20 |
| Three-position 60° | 2NC | C22-WRK3-K02 | C22S-WRK3-K02 | |
| | 1NO/1NC | C22-WRK3-K11 | C22S-WRK3-K11 | |

Note: Momentary selector switches can be field converted to maintained.

Non-Illuminated Selector Switches, Knob Type, with Pigtail

C22-W_



Non-Illuminated Selector Switches, Knob Type, with Pigtail

| Type | Switching Position | Contacts | Connector Length | Connector Type | Silver Bezel Catalog Number | | |
|--------------|--------------------|------------|------------------|----------------|-----------------------------|------------------|-----------------|
| Two-position | Momentary | 1NC | 1 | Flying lead | C22-WK-K01-P62 | | |
| | | 1NC | 3.5 | Flying lead | C22-WK-K01-P65 | | |
| | | 1NO | 0.5 | M8 | C22-WK-K10-P30 | | |
| | | 1NO | 0.5 | M12 | C22-WK-K10-P1 | | |
| | | 1NO | 1 | M8 | C22-WK-K10-P32 | | |
| | | 1NO | 1 | M12 | C22-WK-K10-P5 | | |
| | | 1NO | 1 | Flying lead | C22-WK-K10-P62 | | |
| | | 1NO | 3.5 | Flying lead | C22-WK-K10-P65 | | |
| | | 1NO/1NC | 1 | Flying lead | C22-WK-K11-P62 | | |
| | | 1NO/1NC | 3.5 | Flying lead | C22-WK-K11-P65 | | |
| | | 2NC | 1 | Flying lead | C22-WK-K02-P62 | | |
| | | 2NC | 3.5 | Flying lead | C22-WK-K02-P65 | | |
| | | 2NO | 1 | Flying lead | C22-WK-K20-P62 | | |
| | | 2NO | 3.5 | Flying lead | C22-WK-K20-P65 | | |
| | | Maintained | 1NC | 1 | Flying lead | C22-WRK-K01-P62 | |
| | | | 1NC | 3.5 | Flying lead | C22-WRK-K01-P65 | |
| | 1NO | | 0.5 | M8 | C22-WRK-K10-P30 | | |
| | 1NO | | 0.5 | M12 | C22-WRK-K10-P1 | | |
| | 1NO | | 1 | M8 | C22-WRK-K10-P32 | | |
| | 1NO | | 1 | M12 | C22-WRK-K10-P5 | | |
| | 1NO | | 1 | Flying lead | C22-WRK-K10-P62 | | |
| | 1NO | | 3.5 | Flying lead | C22-WRK-K10-P65 | | |
| | 1NO/1NC | | 1 | Flying lead | C22-WRK-K11-P62 | | |
| | 1NO/1NC | | 3.5 | Flying lead | C22-WRK-K11-P65 | | |
| | 2NC | | 1 | Flying lead | C22-WRK-K02-P62 | | |
| | 2NC | | 3.5 | Flying lead | C22-WRK-K02-P65 | | |
| | 2NO | | 1 | Flying lead | C22-WRK-K20-P62 | | |
| | 2NO | | 3.5 | Flying lead | C22-WRK-K20-P65 | | |
| | Three-position | | Momentary | 1NO/1NC | 1 | Flying lead | C22-WK3-K11-P62 |
| | | | | 1NO/1NC | 3.5 | Flying lead | C22-WK3-K11-P65 |
| | | 2NC | | 1 | Flying lead | C22-WK3-K02-P62 | |
| | | 2NC | | 3.5 | Flying lead | C22-WK3-K02-P65 | |
| 2NO | | 1 | | Flying lead | C22-WK3-K20-P62 | | |
| 2NO | | 3.5 | | Flying lead | C22-WK3-K20-P65 | | |
| Maintained | | 1NO/1NC | | 1 | Flying lead | C22-WRK3-K11-P62 | |
| | | 1NO/1NC | | 3.5 | Flying lead | C22-WRK3-K11-P65 | |
| | | 2NC | 1 | Flying lead | C22-WRK3-K02-P62 | | |
| | | 2NC | 3.5 | Flying lead | C22-WRK3-K02-P65 | | |
| | | 2NO | 1 | Flying lead | C22-WRK3-K20-P62 | | |
| | | 2NO | 3.5 | Flying lead | C22-WRK3-K20-P65 | | |

1

Catalog Number Selection

Catalog Number Selection is for illustrative purposes only and not to be used to create new catalog numbers.

Selector Switches—Keyed

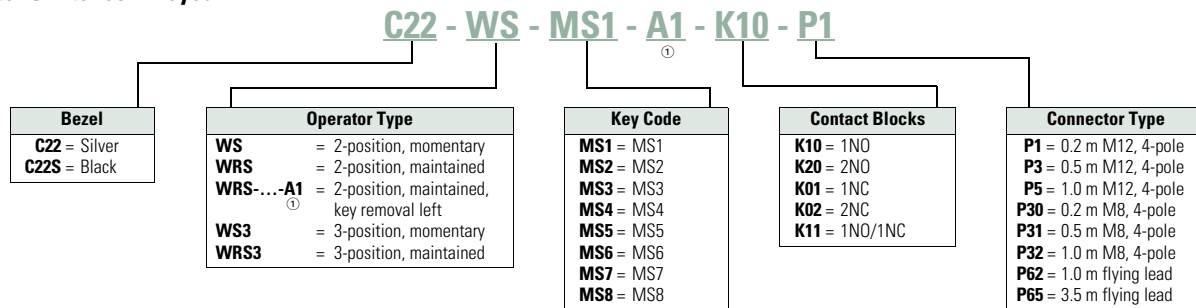

Non-Illuminated, Key Operated

C22(S)-WS-MS_ Non-Illuminated Selector Switches, Key Operated



| Position | Type | Key Code | Contact Block Configuration | Silver Bezel Catalog Number | Black Bezel Catalog Number |
|--------------|--|----------------|-----------------------------|-----------------------------|----------------------------|
| Two-position | Momentary key removal left 40° | MS1 | 1NO | C22-WS-MS1-K10 | C22S-WS-MS1-K10 |
| | | | 2NO | C22-WS-MS1-K20 | C22S-WS-MS1-K20 |
| | | | 1NC | C22-WS-MS1-K01 | C22S-WS-MS1-K01 |
| | | | 2NC | C22-WS-MS1-K02 | C22S-WS-MS1-K02 |
| | | | 1NO/1NC | C22-WS-MS1-K11 | C22S-WS-MS1-K11 |
| | | MS2 | 1NO | C22-WS-MS2-K10 | C22S-WS-MS2-K10 |
| | | | 2NO | C22-WS-MS2-K20 | C22S-WS-MS2-K20 |
| | | | 1NC | C22-WS-MS2-K01 | C22S-WS-MS2-K01 |
| | | | 2NC | C22-WS-MS2-K02 | C22S-WS-MS2-K02 |
| | | | 1NO/1NC | C22-WS-MS2-K11 | C22S-WS-MS2-K11 |
| | | MS3 | 1NO | C22-WS-MS3-K10 | C22S-WS-MS3-K10 |
| | | | 2NO | C22-WS-MS3-K20 | C22S-WS-MS3-K20 |
| | | | 1NC | C22-WS-MS3-K01 | C22S-WS-MS3-K01 |
| | | | 2NC | C22-WS-MS3-K02 | C22S-WS-MS3-K02 |
| | | | 1NO/1NC | C22-WS-MS3-K11 | C22S-WS-MS3-K11 |
| | | MS4 | 1NO | C22-WS-MS4-K10 | C22S-WS-MS4-K10 |
| | | | 2NO | C22-WS-MS4-K20 | C22S-WS-MS4-K20 |
| | | | 1NC | C22-WS-MS4-K01 | C22S-WS-MS4-K01 |
| | | | 2NC | C22-WS-MS4-K02 | C22S-WS-MS4-K02 |
| | | | 1NO/1NC | C22-WS-MS4-K11 | C22S-WS-MS4-K11 |
| MS5 | 1NO | C22-WS-MS5-K10 | C22S-WS-MS5-K10 | | |
| | 2NO | C22-WS-MS5-K20 | C22S-WS-MS5-K20 | | |
| | 1NC | C22-WS-MS5-K01 | C22S-WS-MS5-K01 | | |
| | 2NC | C22-WS-MS5-K02 | C22S-WS-MS5-K02 | | |
| | 1NO/1NC | C22-WS-MS5-K11 | C22S-WS-MS5-K11 | | |

Note: Momentary selector switches can be field converted to maintained.

C22(S)-WRS-MS_

Non-Illuminated Selector Switches, Key Operated, continued



| Position | Type | Key Code | Contact Block Configuration | Silver Bezel Catalog Number | Black Bezel Catalog Number |
|-------------------------|---|----------|-----------------------------|-----------------------------|----------------------------|
| Two-position, continued | Momentary key removal left 40° | MS6 | 1NO | C22-WS-MS6-K10 | C22S-WS-MS6-K10 |
| | | | 2NO | C22-WS-MS6-K20 | C22S-WS-MS6-K20 |
| | | | 1NC | C22-WS-MS6-K01 | C22S-WS-MS6-K01 |
| | | | 2NC | C22-WS-MS6-K02 | C22S-WS-MS6-K02 |
| | | | 1NO/1NC | C22-WS-MS6-K11 | C22S-WS-MS6-K11 |
| | | MS7 | 1NO | C22-WS-MS7-K10 | C22S-WS-MS7-K10 |
| | | | 2NO | C22-WS-MS7-K20 | C22S-WS-MS7-K20 |
| | | | 1NC | C22-WS-MS7-K01 | C22S-WS-MS7-K01 |
| | | | 2NC | C22-WS-MS7-K02 | C22S-WS-MS7-K02 |
| | | | 1NO/1NC | C22-WS-MS7-K11 | C22S-WS-MS7-K11 |
| | | MS8 | 1NO | C22-WS-MS8-K10 | C22S-WS-MS8-K10 |
| | | | 2NO | C22-WS-MS8-K20 | C22S-WS-MS8-K20 |
| | | | 1NC | C22-WS-MS8-K01 | C22S-WS-MS8-K01 |
| | | | 2NC | C22-WS-MS8-K02 | C22S-WS-MS8-K02 |
| | | | 1NO/1NC | C22-WS-MS8-K11 | C22S-WS-MS8-K11 |
| Two-position | Maintained key removal left/right 40° | MS1 | 1NO | C22-WRS-MS1-K10 | C22S-WRS-MS1-K10 |
| | | | 2NO | C22-WRS-MS1-K20 | C22S-WRS-MS1-K20 |
| | | | 1NC | C22-WRS-MS1-K01 | C22S-WRS-MS1-K01 |
| | | | 2NC | C22-WRS-MS1-K02 | C22S-WRS-MS1-K02 |
| | | | 1NO/1NC | C22-WRS-MS1-K11 | C22S-WRS-MS1-K11 |
| | | MS2 | 1NO | C22-WRS-MS2-K10 | C22S-WRS-MS2-K10 |
| | | | 2NO | C22-WRS-MS2-K20 | C22S-WRS-MS2-K20 |
| | | | 1NC | C22-WRS-MS2-K01 | C22S-WRS-MS2-K01 |
| | | | 2NC | C22-WRS-MS2-K02 | C22S-WRS-MS2-K02 |
| | | | 1NO/1NC | C22-WRS-MS2-K11 | C22S-WRS-MS2-K11 |
| | | MS3 | 1NO | C22-WRS-MS3-K10 | C22S-WRS-MS3-K10 |
| | | | 2NO | C22-WRS-MS3-K20 | C22S-WRS-MS3-K20 |
| | | | 1NC | C22-WRS-MS3-K01 | C22S-WRS-MS3-K01 |
| | | | 2NC | C22-WRS-MS3-K02 | C22S-WRS-MS3-K02 |
| | | | 1NO/1NC | C22-WRS-MS3-K11 | C22S-WRS-MS3-K11 |





Note: Momentary selector switches can be field converted to maintained.

1

C22(S)-WRS...-MS1



Non-Illuminated Selector Switches, Key Operated, continued

| Position | Type | Key Code | Contact Block Configuration | Silver Bezel Catalog Number | Black Bezel Catalog Number |
|-------------------------|--|-----------------|-----------------------------|-----------------------------|----------------------------|
| Two-position, continued | Maintained key removal left/right 40°  | MS4 | 1NO | C22-WRS-MS4-K10 | C22S-WRS-MS4-K10 |
| | | | 2NO | C22-WRS-MS4-K20 | C22S-WRS-MS4-K20 |
| | | | 1NC | C22-WRS-MS4-K01 | C22S-WRS-MS4-K01 |
| | | | 2NC | C22-WRS-MS4-K02 | C22S-WRS-MS4-K02 |
| | | | 1NO/1NC | C22-WRS-MS4-K11 | C22S-WRS-MS4-K11 |
| | | MS5 | 1NO | C22-WRS-MS5-K10 | C22S-WRS-MS5-K10 |
| | | | 2NO | C22-WRS-MS5-K20 | C22S-WRS-MS5-K20 |
| | | | 1NC | C22-WRS-MS5-K01 | C22S-WRS-MS5-K01 |
| | | | 2NC | C22-WRS-MS5-K02 | C22S-WRS-MS5-K02 |
| | | | 1NO/1NC | C22-WRS-MS5-K11 | C22S-WRS-MS5-K11 |
| | MS6 | 1NO | C22-WRS-MS6-K10 | C22S-WRS-MS6-K10 | |
| | | 2NO | C22-WRS-MS6-K20 | C22S-WRS-MS6-K20 | |
| | | 1NC | C22-WRS-MS6-K01 | C22S-WRS-MS6-K01 | |
| | | 2NC | C22-WRS-MS6-K02 | C22S-WRS-MS6-K02 | |
| | | 1NO/1NC | C22-WRS-MS6-K11 | C22S-WRS-MS6-K11 | |
| | MS7 | 1NO | C22-WRS-MS7-K10 | C22S-WRS-MS7-K10 | |
| | | 2NO | C22-WRS-MS7-K20 | C22S-WRS-MS7-K20 | |
| | | 1NC | C22-WRS-MS7-K01 | C22S-WRS-MS7-K01 | |
| | | 2NC | C22-WRS-MS7-K02 | C22S-WRS-MS7-K02 | |
| | | 1NO/1NC | C22-WRS-MS7-K11 | C22S-WRS-MS7-K11 | |
| MS8 | 1NO | C22-WRS-MS7-K10 | C22S-WRS-MS7-K10 | | |
| | 2NO | C22-WRS-MS7-K20 | C22S-WRS-MS7-K20 | | |
| | 1NC | C22-WRS-MS7-K01 | C22S-WRS-MS7-K01 | | |
| | 2NC | C22-WRS-MS7-K02 | C22S-WRS-MS7-K02 | | |
| | 1NO/1NC | C22-WRS-MS7-K11 | C22S-WRS-MS7-K11 | | |
| Two-position | Maintained key removal left 40°  | MS1 | 1NO | C22-WRS-MS1-A1-K10 | C22S-WRS-MS1-A1-K10 |
| | | | 2NO | C22-WRS-MS1-A1-K20 | C22S-WRS-MS1-A1-K20 |
| | | | 1NC | C22-WRS-MS1-A1-K01 | C22S-WRS-MS1-A1-K01 |
| | | | 2NC | C22-WRS-MS1-A1-K02 | C22S-WRS-MS1-A1-K02 |
| | | | 1NO/1NC | C22-WRS-MS1-A1-K11 | C22S-WRS-MS1-A1-K11 |
| Three Position | Momentary Key Removal Center 40°  | MS1 | 2NO | C22-WRS3-MS1-K20 | C22S-WRS3-MS1-K20 |
| | | | 2NC | C22-WRS3-MS1-K02 | C22S-WRS3-MS1-K02 |
| | | | 1NO/1NC | C22-WRS3-MS1-K11 | C22S-WRS3-MS1-K11 |
| | Maintained Key Removal Left/Right 60°  | MS1 | 2NO | C22-WRS3-MS1-K20 | C22S-WRS3-MS1-K20 |
| | | | 2NC | C22-WRS3-MS1-K02 | C22S-WRS3-MS1-K02 |
| | | | 1NO/1NC | C22-WRS3-MS1-K11 | C22S-WRS3-MS1-K11 |

Note: Momentary selector switches can be field converted to maintained.

Non-Illuminated Selector Switches, Key Operated, with Pigtail

C22-W_



Non-Illuminated Selector Switches, Key Operated, with Pigtail

| Position | Switching Position | Contacts | Connector Length | Connector Type | Silver Bezel Catalog Number |
|----------------|-----------------------|----------|------------------|----------------------------|-----------------------------|
| Two-position | Momentary 40° | 1NC | 1 m | Flying lead | C22-WS-MS1-K01-P62 |
| | | 1NC | 3.5 m | Flying lead | C22-WS-MS1-K01-P65 |
| | | 1NO | 0.2 m | M12 | C22-WS-MS1-K10-P1 |
| | | 1NO | 0.2 m | M8 | C22-WS-MS1-K10-P30 |
| | | 1NO | 1 m | M12 | C22-WS-MS1-K10-P5 |
| | | 1NO | 1 m | M8 | C22-WS-MS1-K10-P32 |
| | | 1NO | 1 m | Flying lead | C22-WS-MS1-K10-P62 |
| | | 1NO | 3.5 m | Flying lead | C22-WS-MS1-K10-P65 |
| | | 1NO/1NC | 1 m | Flying lead | C22-WS-MS1-K11-P62 |
| | | 1NO/1NC | 3.5 m | Flying lead | C22-WS-MS1-K11-P65 |
| | | 2NC | 1 m | Flying lead | C22-WS-MS1-K02-P62 |
| | | 2NC | 3.5 m | Flying lead | C22-WS-MS1-K02-P65 |
| | 2NO | 1 m | Flying lead | C22-WS-MS1-K20-P62 | |
| | 2NO | 3.5 m | Flying lead | C22-WS-MS1-K20-P65 | |
| | Maintained 60° | 1NC | 1 m | Flying lead | C22-WRS-MS1-K01-P62 |
| | | 1NC | 3.5 m | Flying lead | C22-WRS-MS1-K01-P65 |
| | | 1NO | 0.2 m | M12 | C22-WRS-MS1-K10-P1 |
| | | 1NO | 0.2 m | M8 | C22-WRS-MS1-K10-P30 |
| | | 1NO | 1 m | M12 | C22-WRS-MS1-K10-P5 |
| | | 1NO | 1 m | M8 | C22-WRS-MS1-K10-P32 |
| | | 1NO | 1 m | Flying lead | C22-WRS-MS1-K10-P62 |
| | | 1NO | 3.5 m | Flying lead | C22-WRS-MS1-K10-P65 |
| | | 1NO/1NC | 1 m | Flying lead | C22-WRS-MS1-K11-P62 |
| | | 1NO/1NC | 3.5 m | Flying lead | C22-WRS-MS1-K11-P65 |
| 2NC | | 1 m | Flying lead | C22-WRS-MS1-K02-P62 | |
| 2NC | | 3.5 m | Flying lead | C22-WRS-MS1-K02-P65 | |
| Three-position | Momentary 40° | 1NO/1NC | 1 m | Flying lead | C22-WS3-MS1-K11-P62 |
| | | 1NO/1NC | 3.5 m | Flying lead | C22-WS3-MS1-K11-P65 |
| | | 2NC | 1 m | Flying lead | C22-WS3-MS1-K02-P62 |
| | | 2NC | 3.5 m | Flying lead | C22-WS3-MS1-K02-P65 |
| | | 2NO | 1 m | Flying lead | C22-WS3-MS1-K20-P62 |
| | | 2NO | 3.5 m | Flying lead | C22-WS3-MS1-K20-P65 |
| | Maintained 60° | 1NO/1NC | 1 m | Flying lead | C22-WRS3-MS1-K11-P62 |
| | | 1NO/1NC | 3.5 m | Flying lead | C22-WRS3-MS1-K11-P65 |
| | | 2NC | 1 m | Flying lead | C22-WRS3-MS1-K02-P62 |
| | | 2NC | 3.5 m | Flying lead | C22-WRS3-MS1-K02-P65 |
| | | 2NO | 1 m | Flying lead | C22-WRS3-MS1-K20-P62 |
| | | 2NO | 3.5 m | Flying lead | C22-WRS3-MS1-K20-P65 |

Technical Data and Specifications

22.5 mm RMQ Compact Pushbuttons—C22

| Description | Unit | Pushbutton Actuators | | Indicator Lights C22 | Selector Switch Actuators C22 | Key-Operated Buttons C22 | Emergency Stop/ Emergency Switching OFF Pushbuttons C22 | |
|---|--|-----------------------------|---|----------------------|-------------------------------|---|---|---------------|
| | | Illuminated Pushbuttons C22 | Momentary | | | | | Maintained |
| General | | | | | | | | |
| Standards | IEC/EN 60947 VDE 0660 | | | | | | | |
| Lifespan, mechanical | Operations | x 10 ⁶ | 5 | 1 | — | 1 | 0.1 | 0.05 |
| Operating frequency | Operations/h | | ≥3600 | ≥3600 | — | ≥2000 | ≥100 | ≥300 |
| Actuating force | N | | ≥5 | ≥5 | — | — | — | ≥50 |
| Operating torque | Nm | | — | — | — | ≥0.3 | ≥0.5 | — |
| Terminal screw tightening torque | Nm | | 0.8 | 0.8 | 0.8 | 0.8 | 0.8 | 0.8 |
| Threaded ring tightening torque | Nm | | 2 | 2 | 2 | 2 | 2 | 2 |
| Protection type | | | IP67, IP69K | IP67, IP69K | IP67, IP69K | IP65 | IP66 | IP67, IP69K |
| Climatic proofing | Damp heat, constant, to IEC 60068-2-78 Damp heat, cyclic, to IEC 60068-2-30 | | | | | | | |
| Ambient temperature | | | | | | | | |
| Open | °C | | –25° to 70° | –25° to 70° | –25° to 70° | –25° to 70° | –25° to 70° | –25° to 70° |
| Storage | °C | | –30° to 80° | –30° to 80° | –30° to 80° | –30° to 80° | –30° to 80° | –30° to 80° |
| Mounting position | | | As required | As required | As required | As required | As required | As required |
| Mechanical shock resistance to IEC 60068-2-27 Shock duration 11 ms, half-sinusoidal | g | | 30 | 30 | 30 | 30 | 30 | 30 |
| Terminal capacities | | | | | | | | |
| Solid | mm ² | | 2 x 0.5–1.5 | 2 x 0.5–1.5 | 2 x 0.5–1.5 | 2 x 0.5–1.5 | 2 x 0.5–1.5 | 2 x 0.5–1.5 |
| Flexible with ferrule | mm ² | | 2 x 0.5–1.5 | 2 x 0.5–1.5 | 2 x 0.5–1.5 | 2 x 0.5–1.5 | 2 x 0.5–1.5 | 2 x 0.5–1.5 |
| Contacts | | | | | | | | |
| Rated impulse withstand voltage | U _{imp} | Vac | 4000 | 4000 | 4000 | 4000 | 4000 | 4000 |
| Rated insulation voltage | U _i | V | 250 | 250 | 250 | 250 | 250 | 250 |
| Overtoltage category/pollution degree | | | III/3 | III/3 | III/3 | III/3 | III/3 | III/3 |
| Control circuit reliability | | | | | | | | |
| at 5 Vdc/1 mA | H _F | Fault probability | Values follow | Values follow | — | Values follow | Values follow | Values follow |
| at 17 Vdc/7 mA | H _F | Fault probability | N/O contact: statistically determined 1 failure per 17 x 10 ⁶ operations N/C contact: statistically determined 1 failure per 0.9 x 10 ⁶ operations | — | — | N/O contact: statistically determined 1 failure per 17 x 10 ⁶ operations N/C contact: statistically determined 1 failure per 0.9 x 10 ⁶ operations | — | — |
| at 24 Vdc/5 mA | H _F | Fault probability | Values follow | Values follow | — | Values follow | Values follow | Values follow |
| Max. short-circuit protective device | | | | | | | | |
| Fuse | gG/gL | A | 10 | 10 | — | 10 | 10 | 10 |

22.5 mm RMQ Compact Pushbuttons—C22, continued

| Description | Unit | Push-button Actuators | | Indicator Lights C22 | Selector Switch Actuators C22 | Key-Operated Buttons C22 | Emergency Stop/ Emergency Switching OFF Pushbuttons C22 |
|---------------------------|------------|-----------------------------|-----------|----------------------|-------------------------------|--------------------------|---|
| | | Illuminated Pushbuttons C22 | Momentary | | | | |
| Switching Capacity | | | | | | | |
| Rated operational current | | | | | | | |
| AC-15 | | | | | | | |
| 24V | I_e | A | 4 | 4 | — | 4 | 4 |
| 110V | I_e | A | 2 | 2 | — | 2 | 2 |
| 230V | I_e | A | 1.5 | 1.5 | — | 1.5 | 1.5 |
| DC-13 | | | | | | | |
| 24V | I_e | A | 3 | 3 | — | 3 | 3 |
| 60V | I_e | A | 1 | 1 | — | 1 | 1 |
| 110V | I_e | A | 0.6 | 0.6 | — | 0.6 | 0.6 |
| 220V | I_e | A | 0.3 | 0.3 | — | 0.3 | 0.3 |
| Lifespan, electrical | | | | | | | |
| AC-15 | | | | | | | |
| 230V/0.5A | Operations | $\times 10^6$ | 0.4 | 0.4 | — | 0.4 | 0.4 |
| 230V/1.0A | | $\times 10^6$ | 0.6 | 0.6 | — | 0.6 | 0.6 |

Contact Travel

Contact Travel Diagram

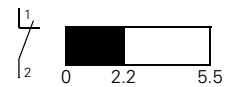
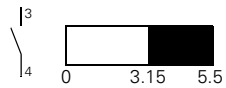

- Contact closed
- Contact open

1.5

Pushbuttons and Indicating Lights

22.5 mm RMQ Compact Pushbuttons—C22

1

Dimensions

Approximate Dimensions in mm [in]

Illuminated Pushbuttons

Flat

C22(S)-DRL_/C22(S)-DL_

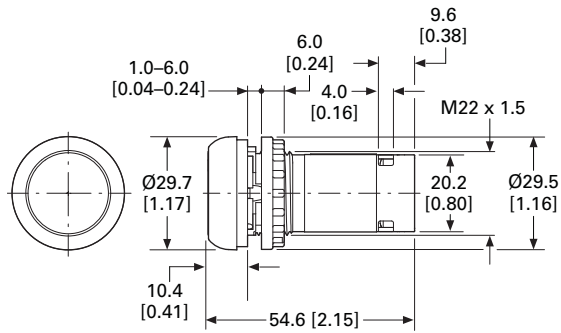

Extended

C22(S)-DRLH_/C22(S)-DLH_

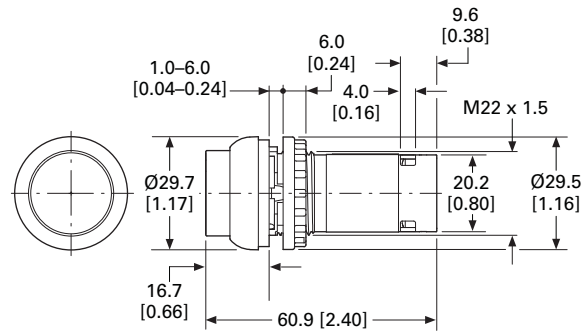

Pushbutton Actuators

Flat

C22(S)-DR_/C22(S)-D_

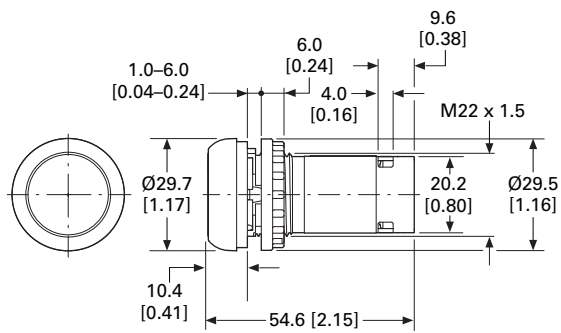

Extended

C22(S)-DRH_/C22(S)-DH_

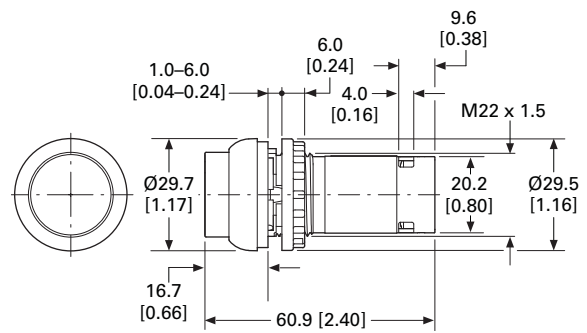

Indicating Lights

Flat

C22-L_

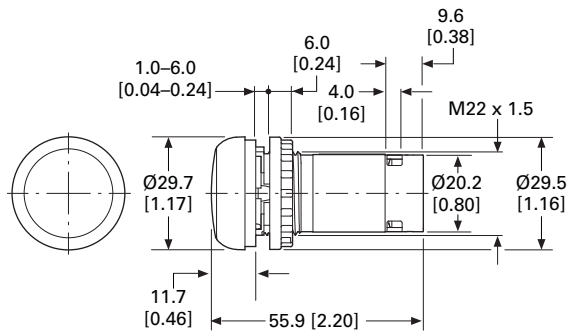

Approximate Dimensions in mm [in]

Emergency Stop/Emergency Switching OFF Pushbuttons

C22-PVT45P_

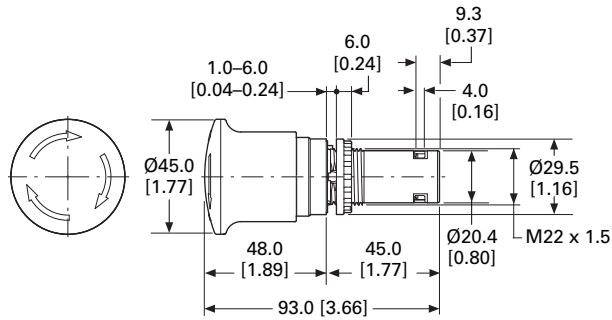

C22-PVT60P_

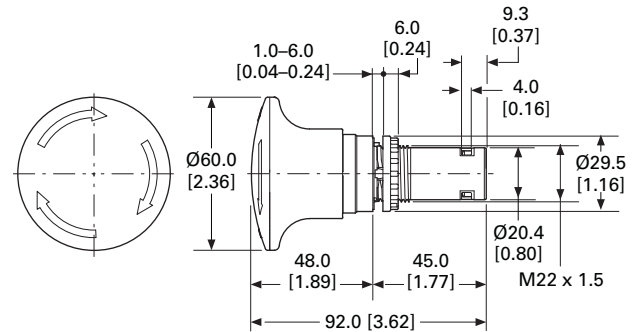

C22-PVT45P-MS_

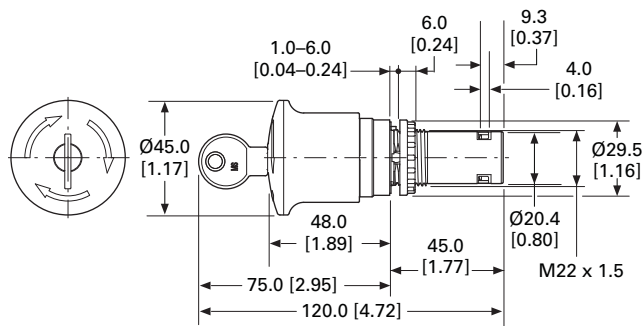

C22-PVT45P-RS_

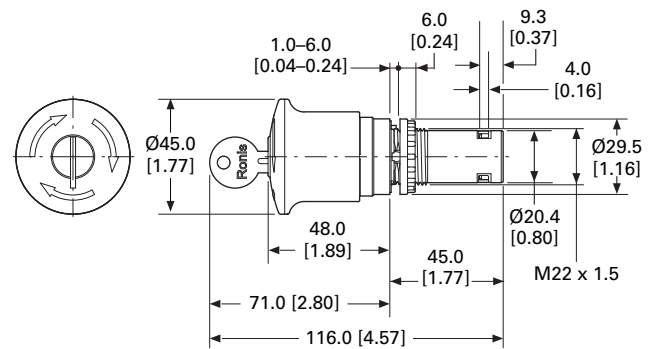

C22-PVT60P-MS_

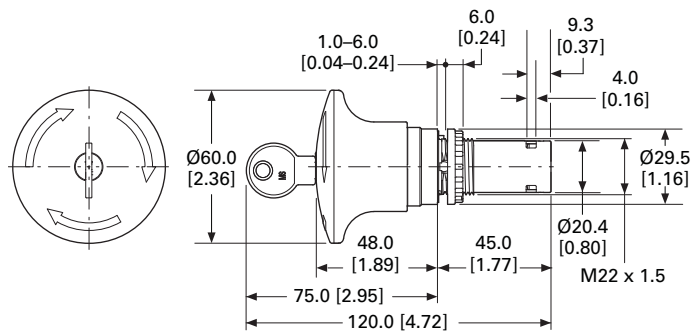

C22-PVT60P-RS_

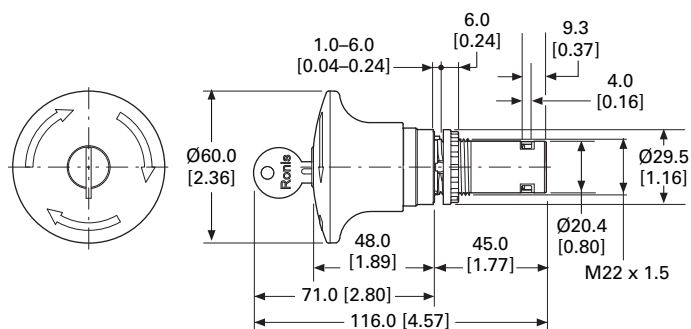

1.5

Pushbuttons and Indicating Lights

22.5 mm RMQ Compact Pushbuttons—C22

1

Approximate Dimensions in mm [in]

Selector Switch Actuators

C22(S)-W(R)K_

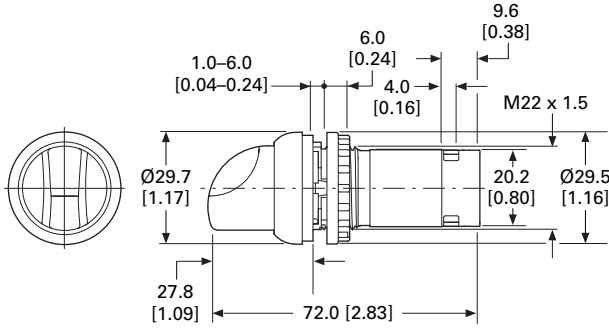

Selector Switch Actuators/V Position

C22(S)-W(R)KV_

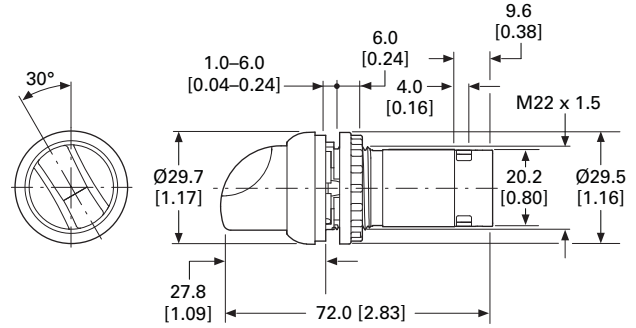

Key Operated Actuators

C22(S)-WS(3)-MS_/C22(S)-WRS(3)-MS_

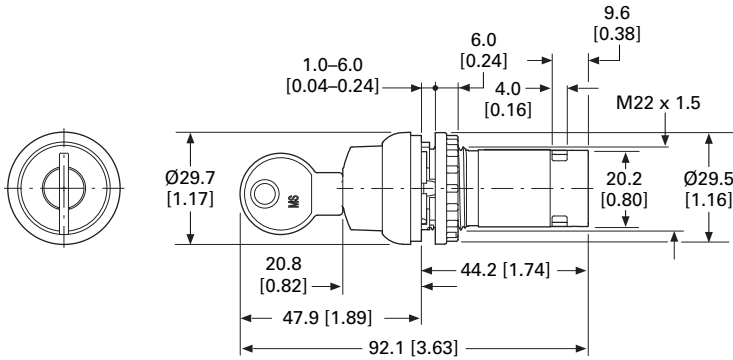

C22(S)-WS(3)-RS_/C22(S)-WRS(3)-RS_

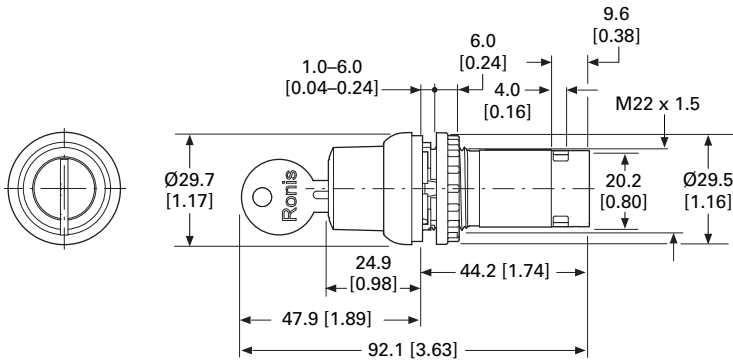

Approximate Dimensions in mm [in]

Pushbuttons, M12A
C22-D...-P1/-P3/-P5

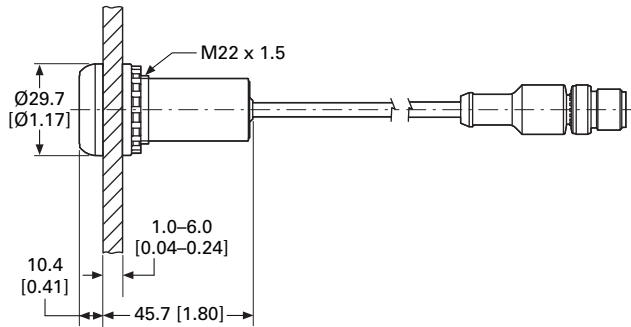

Pushbuttons, M8
C22-D...-P30/-P31/-P32

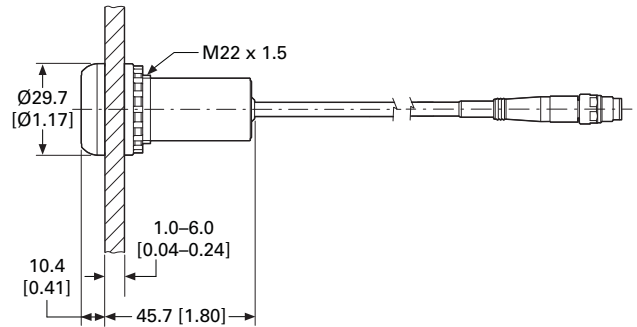

Pushbuttons, Underterminated Cable End, Flying Lead
C22-D...-P/-P62/-P65

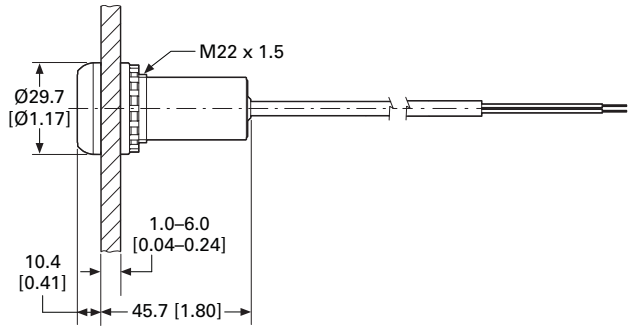

Indicator Lights, M12A
C22-L...-P1/-P3/-P5

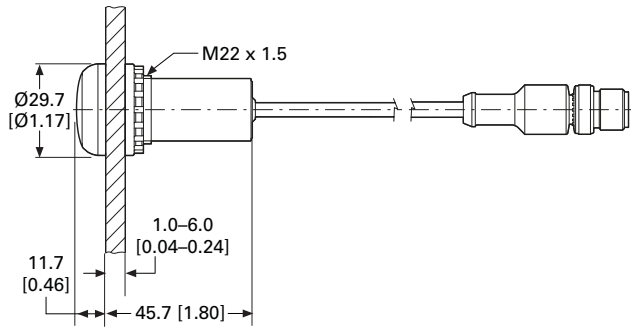

Indicator Lights, M8
C22-L...-P30/-P31/-P32

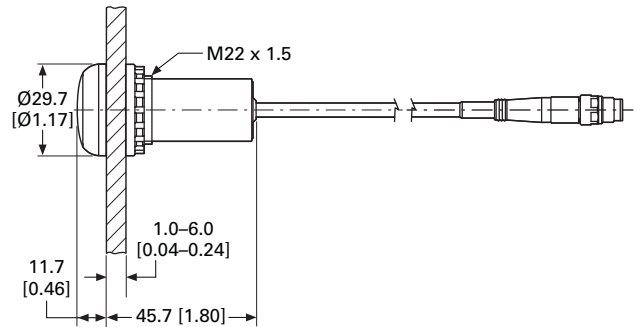

Indicator Lights, Underterminated Cable End, Flying Lead
C22-L...-P62/-P65

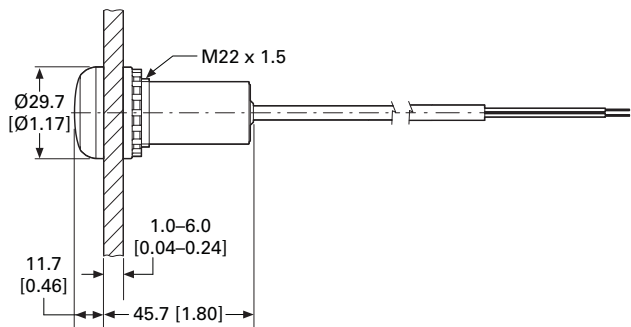

1.5

Pushbuttons and Indicating Lights

22.5 mm RMQ Compact Pushbuttons—C22

1

Approximate Dimensions in mm [in]

Emergency Switching Off, M12A

C22-PVT...-P10

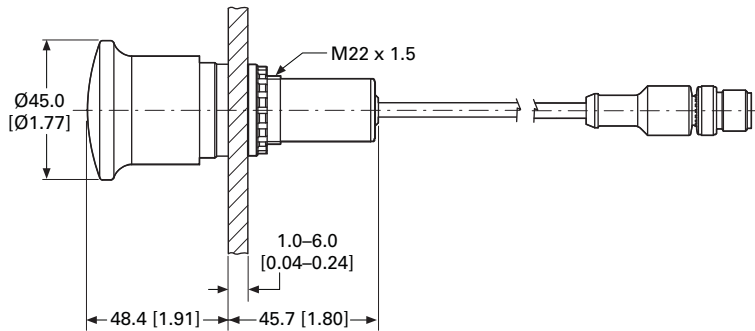

Emergency Switching Off, Underterminated Cable End, Flying Lead

C22-PVT...-P62/-P65

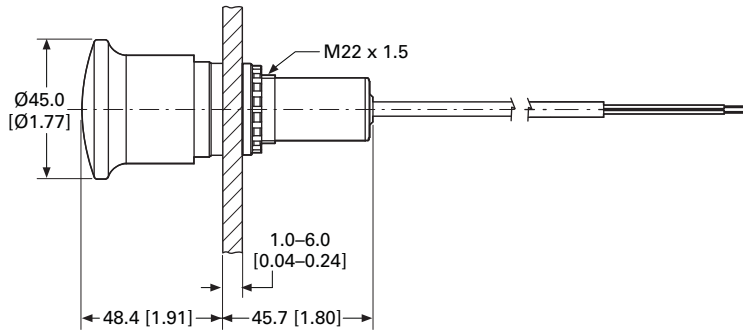

Emergency Switching Off, M12

C22-PV...-P10

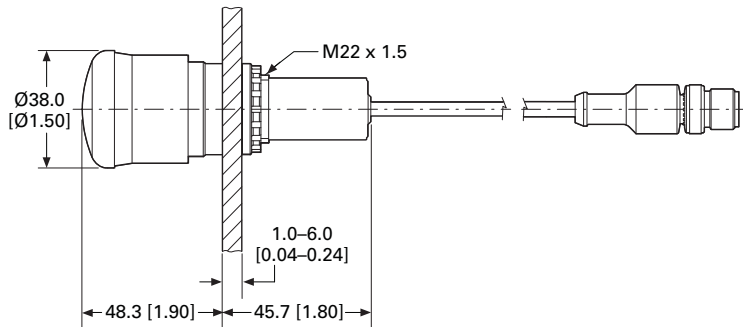

Emergency Switching Off, Underterminated Cable End, Flying Lead

C22-PV...-P62/-P65

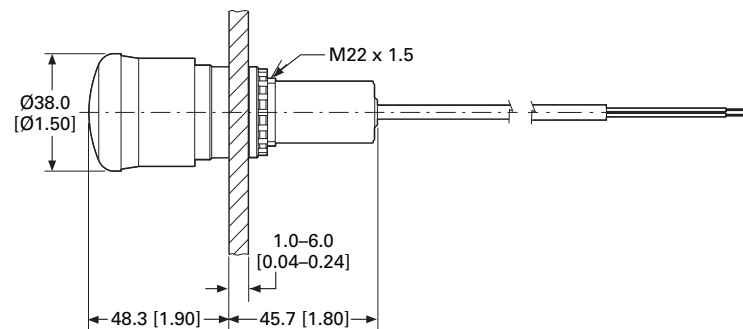

Approximate Dimensions in mm [in]

Key-Operated Buttons, M12A

C22-W(R)S(3)-MS1-...-P1/-P5

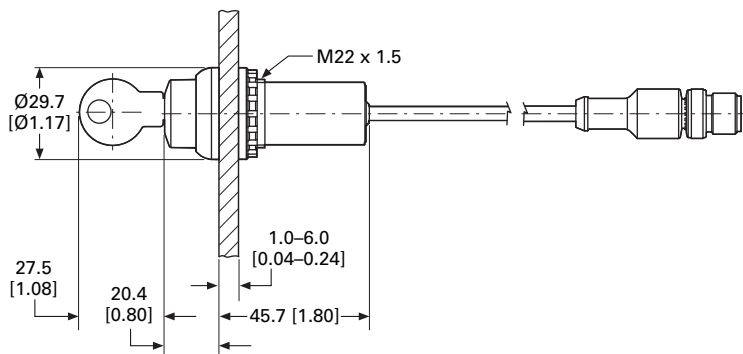

Key-Operated Buttons, M8

C22-W(R)S(3)-MS1-...-P30/-P32

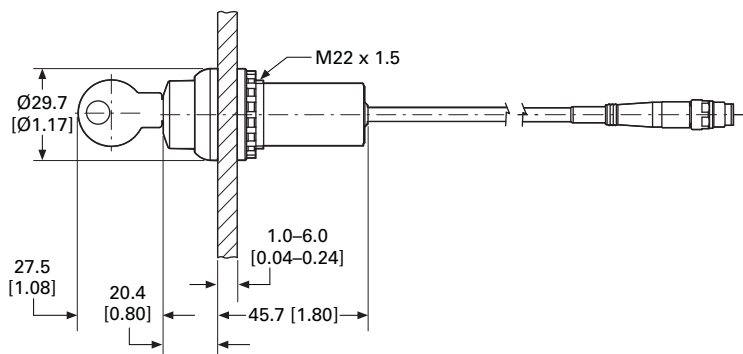

Key-Operated Buttons, Unterminated Cable End, Flying Lead

C22-W(R)S(3)-MS1-...-P62/-P65

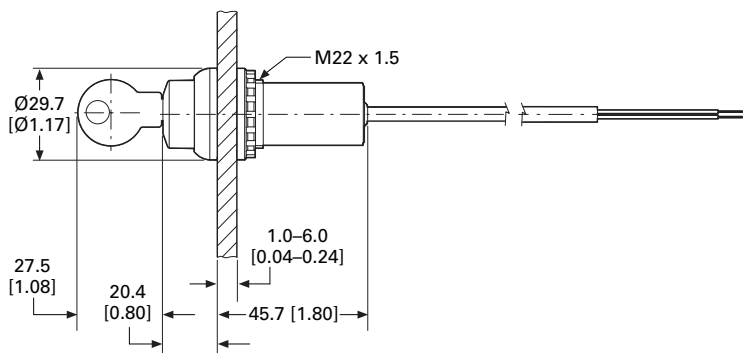



Contents

Description

Page

| | |
|---|------------------|
| Global Modular 30 mm Pilot Devices— M30 Flat Operators | |
| System Overview | V7-T1-170 |
| Product Selection | V7-T1-172 |
| Technical Data | V7-T1-180 |
| Dimensions | V7-T1-183 |

Product Description

The new and modern M30 30 mm operators of the Global pilot devices offer a flat design and functionality while withstanding exposure to oil, dirt and water. Ability to be combined with existing traditional and flat designed M22 contact blocks and indicating lights, M30 operators provide modularity, simplicity and elegance for more demanding commercial and industrial applications.

Our new offering includes stainless steel bezel (M30I) options for extended corrosion protection along with the metal bezel (M30C) options for everyday operations.

Features

- Flat design for modern look and smooth transition between the machine and the operator
- Compatible with existing M22 contact blocks (M22-K...) and indicating lights for enhanced modularity (M22-LED...) and sustainable inventory management
- Compatible with the new M22 flat contact blocks (M22-FK...) and indicating lights for optimized footprint (M22-FLED-...)
- Stainless steel bezel (M30I) options for extended corrosion protection along with the metal bezel (M30C) options for everyday operations
- AFX mounting system for easy and secure installation
- Robust against vandalism
- Up to IP69K for increased protection
- For M30 CAD drawings, please visit the 3D drawings section under the documentation tab at www.eaton.com/m30
- Refer to Instruction Leaflet IL047019ZU for further details

Standards and Certifications

- All operators and components are IEC/EN 60947 VDE 0660
- All M30 flat operators (for enclosed type devices or flat-front surface mounted devices only) are environmentally rated as Type 1, 3R, 4X, 12 or 13 UL File #: E29184
- All operators carry an IP66 rating with some rated for washdown environments with IP67 and IP69K
- Marine classification societies: Bureau Veritas (BV), Germanischer Lloyd (GL) and Lloyd's Register of Shipping (LR) approved



M30 Flat Operators Use M22 Contact Blocks and Indicating Lights

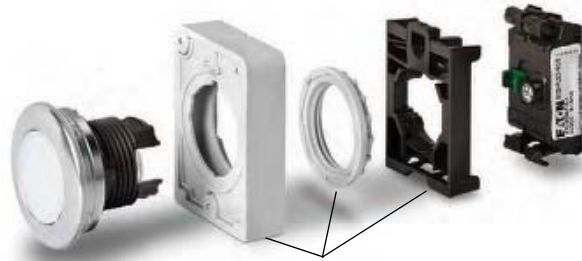

Note: When an M30 part number is ordered, the operator comes standard with the AFX mounting system, ring and adapter.

M22-LED-W



Light Units ①

| Terminal Type | LED Color | Light Unit Voltage | Catalog Number |
|---------------|---|--------------------|-----------------------|
| Screw | White | 12–30 Vac/Vdc | M22-LED-W |
| | Red | | M22-LED-R |
| | Green | | M22-LED-G |
| | Blue | | M22-LED-B |
| Screw | White | 85–264 Vac | M22-LED230-W |
| | Red | | M22-LED230-R |
| | Green | | M22-LED230-G |
| | Blue | | M22-LED230-B |
| Spring-cage | White | 12–30 Vac/Vdc | M22-FLED-W |
| | Red | | M22-FLED-R |
| | Green | | M22-FLED-G |
| | Blue | | M22-FLED-B |
| | Red/Green/ Yellow | 24 Vdc | M22-FLED-RG ② |
| | Red, Green, Blue, Yellow, White, Violet, Turquoise | | M22-FLED-RGB ② |

M22-FLED-



M22-K10



Contact Blocks ①

| Terminal Type | Contact Configuration ③ | Catalog Number |
|---------------|-------------------------|-------------------|
| Screw | NO | M22-K10 |
| | NO, early-make | M22-K10P |
| | NC | M22-K01 |
| | NC, late-break | M22-K01D |
| Spring-cage | NO | M22-CK10 |
| | NC | M22-CK01 |
| | NC, late-break | M22-CK01D |
| | 2NO | M22-CK20 |
| | 2NC | M22-CK02 |
| | NO-NC | M22-CK11 |
| | NC | M22-FK01 ④ |
| NO | M22-FK10 ④ | |

M22-FK01



Notes

- ① For complete listing of available light units and contact blocks, see Accessories, **Pages V7-T1-105 to V7-T1-112.**
- ② Please see color input key on **Page V7-T1-108.**
- ③ All NC contact blocks are positively driven contact. ⊖
- ④ Additional contacts may not be stacked behind M22-F type contact blocks, M22-F can be stacked behind standard M22 contacts only.

1.6

Pushbuttons and Indicating Lights

Global Modular 30 mm Pilot Devices—M30 Flat Operators

1

System Overview

Global Modular 30 mm Pilot Devices—M30 Flat Operators

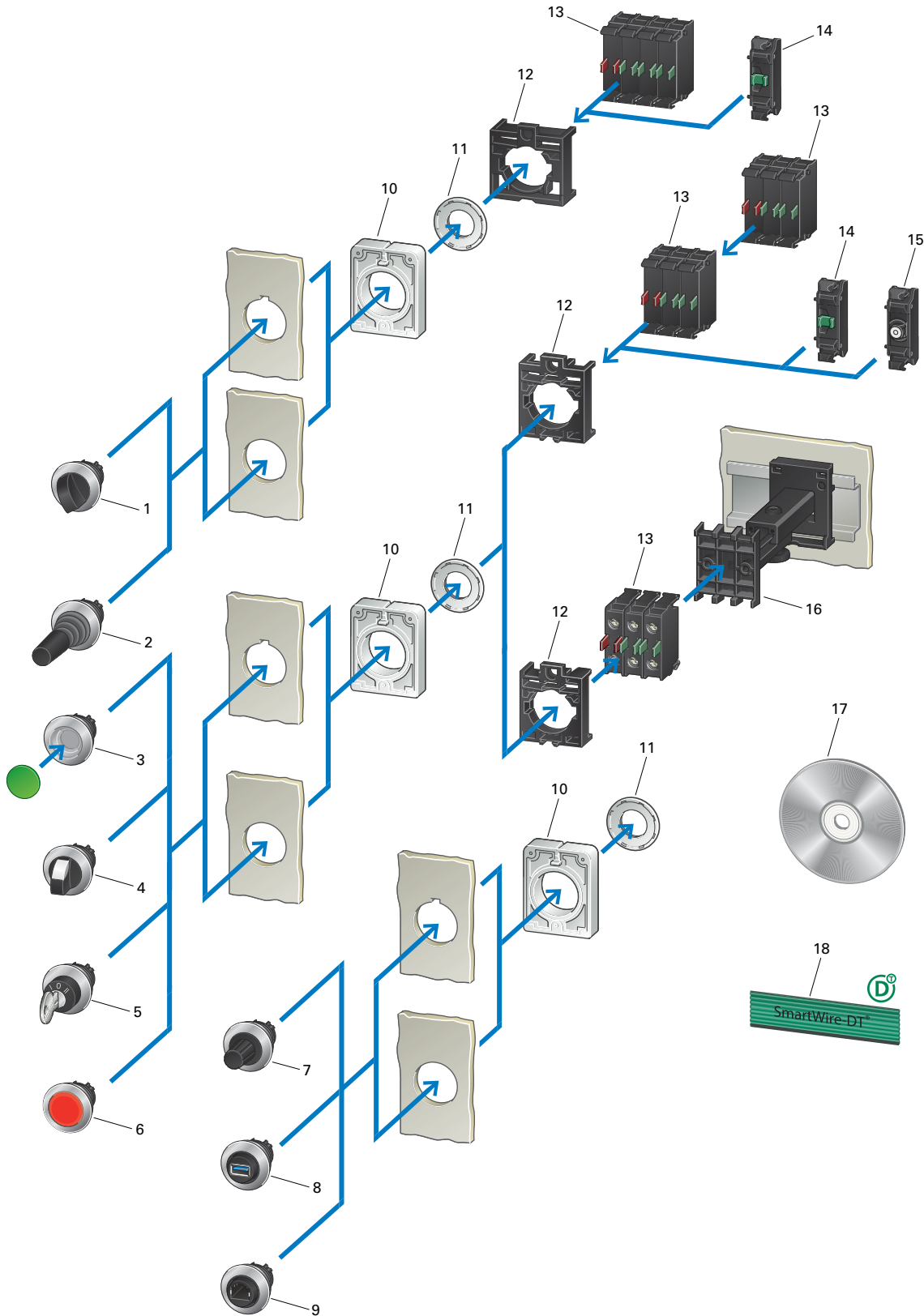

Global Modular 30 mm Pilot Devices—M30 Flat Operators (Legend)

| Item | Description |
|------|--|
| 1 | M30 4-Way Selector Switches 4-positions With rotary head or thumb-grip 0-1-0-2-0-3-0-4 maintained action See Page V7-T1-173 |
| 2 | M30 Joysticks 2- or 4-positions See Page V7-T1-177 |
| 3 | M30 Pushbuttons Momentary and maintained Flush Colors: White, green, red, yellow, blue, black Illuminated pushbutton actuators Colors: White, green, red, yellow, blue, orange See Page V7-T1-172 |
| 4 | M30 Selector Switches 2- and 3-positions With rotary head, thumb-grip Programmable maintained/momentary action Illuminated selector switches with transparent thumb-grip Colors: White, green, red, yellow, blue See Page V7-T1-173 |
| 5 | M30 Key-Operated Buttons For individual lock mechanisms 2- or 3-positions Programmable momentary/maintained action and key withdraw Suitable for master key systems See Page V7-T1-174 |
| 6 | M30 Indicator Lights Colors: White, green, red, yellow, blue, orange See Page V7-T1-177 |
| 7 | SmartWire-DT Encoders, M30 Potentiometers Resistances of 1 kΩ–1 MΩ Three individual connections See Page V7-T1-179 |
| 8 | M30 Panel Mount Connectors USB 3.0 |
| 9 | M30 Panel Mount Connectors RJ45 |

| Item | Description |
|------|--|
| 10 | Blanking Plugs See Page V7-T1-180 |
| 11 | RMQ-AFX Anti-rotation tab Included with the equipment supplied with M30 front elements |
| 12 | Threaded Rings See Pages V7-T1-116 and V7-T1-117 |
| 13 | Mounting Adapters For flush mounting For contact and LED elements See Page V7-T1-181 |
| 14 | Traditional and flat contact blocks M30 flat operators are compatible with M22 traditional and flat contact blocks N/C and N/O Universal contacts suitable for use with electronic devices Safety function implemented with positive opening as defined in IEC/EN 60947-5-1 Traditional contact blocks: 2 levels See Page V7-T1-112 |
| 15 | Traditional and flat LED indicating lights Cage clamp with push-in terminals M30 flat operators are compatible with M22 traditional and flat indicating lights See Page V7-T1-113 and V7-T1-114 |
| 16 | Telescopic Clip For adjusting the depth of rear mounting devices in CI and CI-K enclosures and cabinets See Pages V7-T1-117 and V7-T1-125 |
| 17 | Convenient Labeling A laser inscription with any text and/or symbol can be added to illuminated and non-illuminated pushbuttons. When ordering, specify inscription per catalog number suffix from the Symbols Library. See Pages V7-T1-129 through V7-T1-136 |
| 18 | SmartWire-DT Product Characteristics <ul style="list-style-type: none"> • Clip-fit assembly modular system • Metal bezel, flush • Mounting hole diameter: 30.5 mm • Minimum grid dimension: 40 x 50 mm • Min. degree of protection: IP66 • Up to 6 contacts per mounting location • For switching differing potential • Approved throughout the world |

1.6

Pushbuttons and Indicating Lights

Global Modular 30 mm Pilot Devices—M30 Flat Operators

1

















Product Selection













M30—Pushbuttons

IP67, IP69K—Metal Bezel—Flush

Front Dimensions: 36 mm Diameter

NEMA Type 1, 3R, 4X, 12 or 13

| | Button Plate | Std. Pack | Catalog Number |
|--|---|-----------|-----------------------|
| M30C-FD-  | Momentary ①② | 1 unit | |
| |  | | M30C-FD-S |
| |  | | M30C-FD-W |
| |  | | M30C-FD-R |
| |  | | M30C-FD-G |
| |  | | M30C-FD-Y |
| |  | | M30C-FD-B |
| |  | | M30C-FD-GR |
| |  | | M30C-FD-S-X0 |
| |  | | M30C-FD-W-X1 |
| |  | | M30C-FD-W-X11 |
| |  | | M30C-FD-R-X0 |
| |  | | M30C-FD-G-X1 |
| |  | | M30C-FD-B-X217 |
| |  | | M30C-FD-GR-X66 |
| Custom | M30C-FD-ETCH ③ | | |
| M30C-FD-X | Without button plate | 1 unit | M30C-FD-X |
|  | | | |

| | Button Plate | Std. Pack | Catalog Number | | |
|--|---|-----------|------------------------|--------|-------------------|
| M30C-FDR-S  | Maintained ①② | 1 unit | | | |
| |  | | M30C-FDR-S | | |
| |  | | M30C-FDR-W | | |
| |  | | M30C-FDR-R | | |
| |  | | M30C-FDR-G | | |
| |  | | M30C-FDR-Y | | |
| |  | | M30C-FDR-B | | |
| |  | | M30C-FDR-S-X0 | | |
| |  | | M30C-FDR-W-X1 | | |
| |  | | M30C-FDR-R-X0 | | |
| |  | | M30C-FDR-G-X1 | | |
| | Custom | | M30C-FDR-ETCH ③ | | |
| | M30C-FDR-X | | Without button plate | 1 unit | M30C-FDR-X |
| |  | | | | |

Notes

- ① Maintained/momentary action can be changed on device.
- ② Includes contact block mounting adapter.
- ③ When ordering, specify inscription per catalog number suffix from the Symbols Library (see Pages V7-T1-123 to V7-T1-130).

M30—Selector Switches

IP64, Metal Bezel

Front dimensions: 36 mm diameter



















NEMA Type 1, 3R, 4X, 12 or 13

Maintained/momentary action can be changed with M22-XC-Y configuration adapters

Action

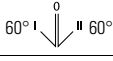
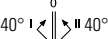
▷ = Momentary (MO)

∟ = Maintained (MA)

| | | Button Plate | Std. Pack | Catalog Number |
|--|---|--|-----------|----------------------|
| With Rotary Head  | Two-Position | | | |
| | ▷ 40° |  | 1 unit | M30C-FW |
| | ∟ 60° |  | | M30C-FWR |
| | | AUTO HAND  | | M30C-FWR-X91 |
| | |  | | M30C-FWR-X92 |
| | | | | |
| With Thumb-Grip  | ▷ 40° | | 1 unit | M30C-FWK |
| | ∟ 60° | | | M30C-FWRK |
| With Thumb-Grip  | ∨ 60° | | 1 unit | M30C-FWKV |
| With Rotary Head  | Three-Position ① | | | |
| | 40° ∟∟ 40° |  | 1 unit | M30C-FW |
| | 60° ∟∟ 60° |  | | M30C-FWR3 |
| | |  | | M30C-FWR3-X7 |
| | |  | | M30C-FWR3-X94 |
| | | | | |
| With Thumb-Grip  | 40° ∟∟ 40° | | 1 unit | M30C-FWK3 |
| | 60° ∟∟ 60° | | | M30C-FWRK3 |
| | Selectable | Maintained, return from left 40° ∟∟ 40° 60° ∟∟ 60° | | M30C-FWRK3-1 |
| | | Maintained, return from right 40° ∟∟ 40° 60° ∟∟ 60° | | M30C-FWRK3-2 |
| | | | | |
| With Rotary Head  | Four-Position ②③ | | | |
| |  |  | 1 unit | M30C-FWR4 |
| With Thumb-Grip  |  |  | | M30C-FWRK4 |

Notes

- ① With plunger bridge for middle contact.
- ② Not compatible with configuration adapters.
- ③ Use M22-A4 mounting adapter, see [Page V7-T1-180](#).

1.6

Pushbuttons and Indicating Lights

Global Modular 30 mm Pilot Devices—M30 Flat Operators

1

M30—Key-Operated Buttons

Key-Operated Buttons for Individual Lock Mechanisms

IP64, Metal Bezel

Front dimensions: 36 mm diameter

NEMA Type 1, 3R, 4X, 12 or 13

Maintained/momentary action can be changed with M22-XC-Y configuration adapters

Key withdraw can be changed with M22-XC-... configuration adapters

Action

▷ = Momentary (M0)

∨ = Maintained (MA)

Two-Position



Two-Position

| | Lock Mechanism | Key Withdrawable at Position | | Equipment Supplied | Key Code | Std. Pack | Catalog Number |
|-------|----------------|------------------------------|------|--------------------------|----------|-----------|------------------------|
| ▷ 40° | — | 0 | — | With one key | MS1 | 1 unit | M30C-FWS |
| | | | | | MS2 | | M30C-FWS-MS2 |
| | | | | | MS3 | | M30C-FWS-MS3 |
| | | | | | MS4 | | M30C-FWS-MS4 |
| | | | | | MS5 | | M30C-FWS-MS5 |
| | | | | | MS6 | | M30C-FWS-MS6 |
| | | | | | MS7 | | M30C-FWS-MS7 |
| | | | | | MS8 | | M30C-FWS-MS8 |
| | | | | | MS10 | | M30C-FWS-MS10 |
| | | | | | MS1 | | M30C-FWS-A1 |
| ∨ 60° | — | 0 | I | With one key | MS1 | 1 unit | M30C-FWRS |
| | | | | | MS2 | | M30C-FWRS-MS2 |
| | | | | | MS3 | | M30C-FWRS-MS3 |
| | | | | | MS4 | | M30C-FWRS-MS4 |
| | | | | | MS5 | | M30C-FWRS-MS5 |
| | | | | | MS6 | | M30C-FWRS-MS6 |
| | | | | | MS7 | | M30C-FWRS-MS7 |
| | | | | | MS8 | | M30C-FWRS-MS8 |
| | | | | | MS10 | | M30C-FWRS-MS10 |
| | | | | | MS1 | | M30C-FWRS-A1 |
| | | | MS2 | M30C-FWRS-MS2-A1 | | | |
| | | | MS3 | M30C-FWRS-MS3-A1 | | | |
| | | | MS4 | M30C-FWRS-MS4-A1 | | | |
| | | | MS5 | M30C-FWRS-MS5-A1 | | | |
| | | | MS6 | M30C-FWRS-MS6-A1 | | | |
| | | | MS7 | M30C-FWRS-MS7-A1 | | | |
| | | | MS8 | M30C-FWRS-MS8-A1 | | | |
| | | | MS10 | M30C-FWRS-MS10-A1 | | | |
| | | | MS1 | M30C-FWRS-X95 | | | |
| ∨ 60° | Ronis 455 | 0 | — | With two keys | MS1 | 1 unit | M30C-FWRS-RS |
| | Ronis 455 | 0 | — | | MS1 | | M30C-FWRS-RS-A1 |

Two-Position (Ronis 455)



IP64, Metal Bezel, continued

Front dimensions: 36 mm diameter

NEMA Type 1, 3R, 4X, 12 or 13

Maintained/momentary action can be changed with M22-XC-Y configuration adapters

Key withdraw can be changed with M22-XC-... configuration adapters

Action

▷ = Momentary (MO)

∟ = Maintained (MA)

Three-Position



Three-Position

| | Lock Mechanism | Key Withdrawable at Position | Equipment Supplied | Key Code | Std. Pack | Catalog Number |
|-------------|----------------|------------------------------|--------------------|----------|-----------|--------------------------|
| 40° ∟ ∟ 40° | — | 0 | With one key | MS1 | 1 unit | M30C-FWS3 |
| | | | | MS2 | | M30C-FWS3-MS2 |
| | | | | MS3 | | M30C-FWS3-MS3 |
| | | | | MS4 | | M30C-FWS3-MS4 |
| | | | | MS5 | | M30C-FWS3-MS5 |
| | | | | MS6 | | M30C-FWS3-MS6 |
| | | | | MS7 | | M30C-FWS3-MS7 |
| | | | | MS8 | | M30C-FWS3-MS8 |
| 60° ∟ ∟ 60° | Selectable | — | — | MS1 | | M30C-FWRS3-MS1-A1 |
| | | | | MS2 | | M30C-FWRS3-MS2-A1 |
| | | | | MS3 | | M30C-FWRS3-MS3-A1 |
| | | | | MS4 | | M30C-FWRS3-MS4-A1 |
| | | | | MS5 | | M30C-FWRS3-MS5-A1 |
| | | | | MS6 | | M30C-FWRS3-MS6-A1 |
| | | | | MS7 | | M30C-FWRS3-MS7-A1 |
| | | | | MS8 | | M30C-FWRS3-MS8-A1 |
| — | — | Selectable | — | MS1 | | M30C-FWRS3-MS1-A2 |
| | | | | MS2 | | M30C-FWRS3-MS2-A2 |
| | | | | MS3 | | M30C-FWRS3-MS3-A2 |
| | | | | MS4 | | M30C-FWRS3-MS4-A2 |
| | | | | MS5 | | M30C-FWRS3-MS5-A2 |
| | | | | MS6 | | M30C-FWRS3-MS6-A2 |
| | | | | MS7 | | M30C-FWRS3-MS7-A2 |
| | | | | MS8 | | M30C-FWRS3-MS8-A2 |
| — | — | Selectable | — | MS1 | | M30C-FWRS3-MS1-A3 |
| | | | | MS2 | | M30C-FWRS3-MS2-A3 |
| | | | | MS3 | | M30C-FWRS3-MS3-A3 |
| | | | | MS4 | | M30C-FWRS3-MS4-A3 |
| | | | | MS5 | | M30C-FWRS3-MS5-A3 |
| | | | | MS6 | | M30C-FWRS3-MS6-A3 |
| | | | | MS7 | | M30C-FWRS3-MS7-A3 |
| | | | | MS8 | | M30C-FWRS3-MS8-A3 |
| — | — | Selectable | — | MS1 | | M30C-FWRS3-MS1-A4 |
| | | | | MS2 | | M30C-FWRS3-MS2-A4 |
| | | | | MS3 | | M30C-FWRS3-MS3-A4 |
| | | | | MS4 | | M30C-FWRS3-MS4-A4 |
| | | | | MS5 | | M30C-FWRS3-MS5-A4 |
| | | | | MS6 | | M30C-FWRS3-MS6-A4 |
| | | | | MS7 | | M30C-FWRS3-MS7-A4 |
| | | | | MS8 | | M30C-FWRS3-MS8-A4 |

1.6

Pushbuttons and Indicating Lights

Global Modular 30 mm Pilot Devices—M30 Flat Operators

1

IP64, Metal Bezel, continued

Front dimensions: 36 mm diameter

NEMA Type 1, 3R, 4X, 12 or 13

Maintained/momentary action can be changed with M22-XC-Y configuration adapters

Key withdraw can be changed with M22-XC-... configuration adapters

Action

▷ = Momentary (MO)

◁ = Maintained (MA)

Three-Position



Three-Position, continued

| | Lock Mechanism | Key Withdrawable at Position | Equipment Supplied | Key Code | Std. Pack | Catalog Number | | | |
|-----------|----------------|------------------------------|--------------------|----------|--------------|----------------|--------|-------------------|-------------------|
| 60° ↓ 60° | Selectable | — | Selectable | — | With one key | MS1 | 1 unit | M30C-FWRS3-MS1-A5 | |
| | | | | | | MS2 | | M30C-FWRS3-MS2-A5 | |
| | | | | | | MS3 | | M30C-FWRS3-MS3-A5 | |
| | | | | | | MS4 | | M30C-FWRS3-MS4-A5 | |
| | | | | | | MS5 | | M30C-FWRS3-MS5-A5 | |
| | | | | | | MS6 | | M30C-FWRS3-MS6-A5 | |
| | | | | | | MS7 | | M30C-FWRS3-MS7-A5 | |
| | | | | | | MS8 | | M30C-FWRS3-MS8-A5 | |
| | — | — | Selectable | — | | | MS1 | | M30C-FWRS3-MS1-A6 |
| | | | | | | | MS2 | | M30C-FWRS3-MS2-A6 |
| | | | | | | | MS3 | | M30C-FWRS3-MS3-A6 |
| | | | | | | | MS4 | | M30C-FWRS3-MS4-A6 |
| | | | | | | | MS5 | | M30C-FWRS3-MS5-A6 |
| | | | | | | | MS6 | | M30C-FWRS3-MS6-A6 |
| | | | | | | | MS7 | | M30C-FWRS3-MS7-A6 |
| | | | | | | | MS8 | | M30C-FWRS3-MS8-A6 |

Three-Position (Ronis 455)



| | | | | | | | | |
|-----------|-----------|---|---|---|---------------|---|--------|------------------|
| 60° ↓ 60° | Ronis 455 | 0 | — | — | With two keys | — | 1 unit | M30C-FWRS3-RS |
| | | | | | | — | | M30C-FWRS3-RS-A1 |

Two- or Three-Position



Two- or Three-Position

| | | | | | | | | |
|-----------|---|---|------------|---|---------------|------|--------|----------------|
| 60° ↓ 60° | — | — | Selectable | — | With two keys | MS1 | 1 unit | M30C-FWRS3-A1 |
| | | | | | | MS2 | | M30C-FWRS3-A2 |
| | | | | | | MS3 | | M30C-FWRS3-A3 |
| | | | | | | MS4 | | M30C-FWRS3-A4 |
| | | | | | | MS5 | | M30C-FWRS3-A5 |
| | | | | | | MS6 | | M30C-FWRS3-A6 |
| | | | | | | MS7 | | M30C-FWRS3-A7 |
| | | | | | | MS10 | | M30C-FWRS3-A10 |

M30—Joysticks, Indicator Lights and Illuminated Operators

Joystick



Joysticks—IP66, Metal Bezel

With one operating point per operating direction
 NEMA Type 1, 3R, 4X, 12 or 13
 With metal shaft
 Front dimensions: 36 mm diameter

| Description | Action | | Std. Pack | Catalog Number |
|----------------|--------|---|-----------|----------------|
| | — | ⏏ | | |
| Two-position | — | ⏏ | 1 unit | M30C-FWRJS2H |
| Three-position | — | ⏏ | | M30C-FWRJS2V |
| Four-position | ⏏ | ⏏ | | M30C-FWJS4 |

Indicator Lights



Indicator Lights—IP67, Metal Bezel

Front dimensions: 36 mm diameter
 NEMA Type 1, 3R, 4X, 12 or 13

| Lens | Std. Pack | Catalog Number |
|------|-----------|----------------|
| ○ | 1 unit | M30C-FL-W |
| ● | | M30C-FL-R |
| ● | | M30C-FL-G |
| ● | | M30C-FL-Y |
| ● | | M30C-FL-B |
| ● | | M30C-FL-A |

Illuminated Pushbuttons

IP67, IP69K, Metal Bezel, Flush

Front dimensions: 36 mm diameter
 NEMA Type 1, 3R, 4X, 12 or 13

| Button Plate | Std. Pack | Catalog Number |
|--------------|-----------|----------------------------|
| ○ | 1 unit | M30C-FDL-W |
| ● | | M30C-FDL-R |
| ● | | M30C-FDL-G |
| ● | | M30C-FDL-Y |
| ● | | M30C-FDL-B |
| ● | | M30C-FDL-A |
| ⊙ | | M30C-FDL-W-X0 |
| ⊙ | | M30C-FDL-W-X1 |
| ⊙ | | M30C-FDL-W-X100 |
| ⊙ | | M30C-FDL-R-X0 |
| ⊙ | | M30C-FDL-G-X1 |
| ⊙ | | M30C-FDL-G-X32 |
| ⊙ | | M30C-FDL-Y-X162 |
| Custom | | M30C-FDL-ETCH ^① |



Momentary



| | | |
|----------------------|--------|------------|
| Without button plate | 1 unit | M30C-FDL-X |
|----------------------|--------|------------|

IP67, IP69K, Metal Bezel, Flush

Front dimensions: 36 mm diameter
 NEMA Type 1, 3R, 4X, 12 or 13

| Button Plate | Std. Pack | Catalog Number |
|----------------------|-----------|-----------------------------|
| ○ | 1 unit | M30C-FDRL-W |
| ● | | M30C-FDRL-R |
| ● | | M30C-FDRL-G |
| ● | | M30C-FDRL-Y |
| ● | | M30C-FDRL-B |
| ● | | M30C-FDRL-A |
| ⊙ | | M30C-FDRL-W-X0 |
| ⊙ | | M30C-FDRL-W-X1 |
| ⊙ | | M30C-FDRL-R-X0 |
| ⊙ | | M30C-FDRL-G-X1 |
| Custom | | M30C-FDRL-ETCH ^① |
| Without button plate | 1 unit | M30C-FDRL-X |



Note

^① When ordering, specify inscription per catalog number suffix from the Symbols Library (see Pages V7-T1-123 to V7-T1-130).

1.6

Pushbuttons and Indicating Lights

Global Modular 30 mm Pilot Devices—M30 Flat Operators

1

Illuminated Selector Switches

















IP64, Metal Bezel, with Thumb-Grip

Front dimensions: 36 mm diameter
NEMA Type 1, 3R, 4X, 12 or 13
Maintained/momentary action can be changed with M22-XC-Y configuration adapters

Action

▷ = Momentary (MO)

∨ = Maintained (MA)

| | | Button Plate | Std. Pack | Catalog Number |
|---|---------------------------------------|---|---------------------|---------------------|
| Momentary  | Two-Position | | | |
| | ▷ 40° |  | 1 unit | M30C-FWLK-W |
| | |  | | M30C-FWLK-R |
| | |  | | M30C-FWLK-G |
| | |  | | M30C-FWLK-Y |
| | |  | | M30C-FWLK-B |
| | ∨ 60° |  | 1 unit | M30C-FWRLK-W |
| | |  | | M30C-FWRLK-R |
| | |  | | M30C-FWRLK-G |
| | |  | | M30C-FWRLK-Y |
|  | | | M30C-FWRLK-B | |
| Momentary  | Two-Position (V-Configuration) | | | |
| | ∨ 60° |  | 1 unit | M30C-FWLKV-W |
| | |  | | M30C-FWLKV-R |
| | |  | | M30C-FWLKV-G |
| | |  | | M30C-FWLKV-Y |
| | |  | | M30C-FWLKV-B |





















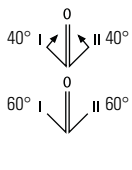

IP64, Metal Bezel, with Thumb-Grip

Front dimensions: 36 mm diameter
NEMA Type 1, 3R, 4X, 12 or 13
Maintained/momentary action can be changed with M22-XC-Y configuration adapters

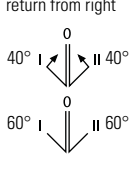
Action

▷ = Momentary (MO)

∨ = Maintained (MA)

| | | Button Plate | Std. Pack | Catalog Number |
|---|--|---|---|------------------------|
| Momentary  | Three-Position | | | |
| | 40° ∠ 40° |  | 1 unit | M30C-FWLK3-W |
| | |  | | M30C-FWLK3-R |
| | |  | | M30C-FWLK3-G |
| | |  | | M30C-FWLK3-Y |
| | |  | | M30C-FWLK3-B |
| | 60° ∨ 60° |  | 1 unit | M30C-FWRLK3-W |
| | |  | | M30C-FWRLK3-R |
| | |  | | M30C-FWRLK3-G |
| | |  | | M30C-FWRLK3-Y |
| | |  | | M30C-FWRLK3-B |
| | Maintained, return from left  |  | 1 unit | M30C-FWRLK3-1-W |
| | |  | | M30C-FWRLK3-1-R |
| | |  | | M30C-FWRLK3-1-G |
| | |  | | M30C-FWRLK3-1-Y |
| | |  | | M30C-FWRLK3-1-B |
| | | Maintained, return from right  |  | 1 unit |
| |  | | | M30C-FWRLK3-2-R |
|  | | | M30C-FWRLK3-2-G | |
|  | | | M30C-FWRLK3-2-Y | |
|  | | | M30C-FWRLK3-2-B | |

Potentiometers

IP66, Metal Bezel Potentiometer

Three individual screw connections

NEMA Type 1, 3R, 4X, 12 or 13

Resistance accuracy: $\pm 10\%$ (linear) / Rated power $P = 0.5\text{ W}$

Potentiometer



| Resistance (R) kOhm | Scale/Inscription | Contact Sequence | Std. Pack | Catalog Number |
|---------------------|----------------------------|---|-----------|---------------------------|
| 1 | Standard scale/inscription |  | 1 unit | M30C-FR1K |
| 4.7 | | | | M30C-FR4K7 |
| 10 | | | | M30C-FR10K |
| 47 | | | | M30C-FR47K |
| 100 | | | | M30C-FR100K |
| 470 | | | | M30C-FR470K |
| 2.2 | | | | M30C-FR2K2 |
| 22 | | | | M30C-FR22K |
| 1000 | | | | M30C-FR1M |
| 1 | | | | Without scale/inscription |
| 2.2 | M30C-FR2K2-BLANK | | | |
| 4.7 | M30C-FR4K7-BLANK | | | |
| 10 | M30C-FR10K-BLANK | | | |
| 22 | M30C-FR22K-BLANK | | | |
| 47 | M30C-FR47K-BLANK | | | |
| 100 | M30C-FR100K-BLANK | | | |
| 470 | M30C-FR470K-BLANK | | | |
| 1000 | M30C-FR1M-BLANK | | | |

IP65, SmartWire-DT Potentiometer

Only in conjunction with M22-SWD-R function element

NEMA Type 1, 3R, 4X, 12 or 13

M22-R-SWD



| Bezel | Contact Sequence | Std. Pack | Catalog Number |
|--------------------------|---|-----------|--------------------|
| Silver bezel (M22) |  | 1 unit | M22-R-SWD |
| Metal bezel (flat front) | | 1 unit | M30C-FR-SWD |

IP65, SmartWire-DT Encoders

With actuation function

NEMA Type 1, 3R, 4X, 12 or 13

Only in conjunction with M22-SWD-INC function element

M30C-FINC-SWD



| Bezel | Contact Sequence | Std. Pack | Catalog Number |
|--------------------------|------------------|-----------|----------------------|
| Silver bezel (M22) | — | 1 unit | M22-INC-SWD |
| Metal bezel (flat front) | — | 1 unit | M30C-FINC-SWD |

1.6

Pushbuttons and Indicating Lights







Global Modular 30 mm Pilot Devices—M30 Flat Operators

1

Blanking Plugs

Round design, IP67, IP69K

For sealing spare mounting locations

| | For use with ... | Color | Std. Pack | Catalog Number |
|---|------------------|---|-----------|-------------------------|
|  | M22 |  | 50 units | M22-B216388 |
| | |  | 250 units | M22-B-GVP216389 |
| | |  | 50 units | M22S-B216390 |
| | |  | 250 units | M22S-B-GVP216391 |
| | M30 |  | 1 unit | M30C-FB187028 |

Technical Data

Global Modular 30 mm Pilot Devices

| Description | Unit | Contact Elements | | Double Contact Elements | LED Elements | M22-FLED... | (Illuminated) Pushbuttons, Mushroom Pushbuttons | |
|---|-------------------|------------------|--|-------------------------|------------------|--|---|--------------------|
| | | M22-(C)K... | M22-FK... | M22-CK20/02/11 | M22(C)-LED... | | Momentary | Maintained |
| General | | | | | | | | |
| Standards | | IEC/EN 60947-5-1 | — | IEC/EN 60947-5-1 | IEC/EN 60947-5-1 | — | EC/EN 60947-5-1 | — |
| Lifespan, mechanical (operations) | x 10 ⁶ | 5 | 1 | — | — | — | 5 | 1 |
| Operating frequency (operations) | h | ≤ 3600 | ≤ 3600 | ≤ 3600 | — | — | ≤ 3600 | ≤ 1800 |
| Operating force | N | 5 | 4.5 | 10 | — | — | 5 | 5 |
| Operating torque (screw terminals) | Nm | 0.8 | — | — | 0.8 | — | — | — |
| Degree of protection (IEC/EN 60529) | | IP20 | IP20 | IP20 | IP20 | IP20 | IP67, IP69K | IP67, IP69K |
| Climatic proofing Damp heat, constant as defined in IEC 60068-2-7; Damp heat, cyclic as defined in IEC 60068-2-3 | | | | | | | | |
| Ambient air temperature, open | °C | -25 to +70 | -25 to +70 | -25 to +70 | -25 to +70 | -25 to +70 | -25 to +70 | -25 to +70 |
| Mounting position | | Any | Any | Any | Any | Any | Any | Any |
| Mechanical shock resistance as defined in IEC 60068-2-27 Shock duration: 11 ms, half sine shock | g | 30 | 50 | 30 | 30 | 50 | M22: 30 M30: 15 | M22: 30 M30: 15 |
| Terminal capacities | | | | | | | | |
| Solid | mm ² | 0.75–2.5 | 2 x 1 (0.2–1.5) 2 x 1 (0.75–1.5) ^① | 0.5–1.5 | 0.75–2.5 | 1 x 1 (0.2–1.5) 1 x 1 (0.75–1.5) ^① | — | — |
| Stranded | mm ² | 0.5–2.5 | — | 0.5–1.5 | 0.5–2.5 | 1 x 1 (0.2–1.5) | — | — |
| Flexible with ferrule | mm ² | 0.5–1.5 | 2 x 1 (0.25–1) ^② | 0.5–1.5 | — | 1 x 1 (0.25–1) ^② | — | — |

Notes

^① Can be plugged without tools.

^② Use WAGO Variocrimp 4 crimping tool; please enquire for others.

Global Modular 30 mm Pilot Devices, continued

| Description | Unit | Contact Elements | | Double Contact | LED Elements | (Illuminated) Pushbuttons, Mushroom Pushbuttons | | |
|---|-------------------|--------------------------|-----------|----------------|---------------|--|-----------|------------|
| | | M22-(C)K... | M22-FK... | M22-CK20/02/11 | M22(C)-LED... | M22-FLED... | Momentary | Maintained |
| Contacts | | | | | | | | |
| Rated impulse withstand voltage (U_{imp}) | Vac | 6000 | 4000 | — | 6000 | 4000 | — | — |
| Rated insulation voltage (U_i) | V | 500 | 250 | — | 500 | 250 | — | — |
| Overtoltage category/ degree of pollution | | III/3 | III/3 | — | III/3 | III/3 | — | — |
| Control circuit reliability | | | | | | | | |
| At 24 Vdc/5 mA (failure rate) | H _F | < 10 ⁻⁷ ① | — | — | — | — | — | — |
| At 5 Vdc/1 mA (failure rate) | H _F | < 5 x 10 ⁻⁶ ② | — | — | — | — | — | — |
| Max. short-circuit protective device | | | | | | | | |
| Fuseless (part no.) | A | PKZM0-10/FAZ-B6/1 | FAZ-B4 | — | — | — | — | — |
| Fuse (gG/gL) | | 10 | 4 | — | — | — | — | — |
| Switching Capacity | | | | | | | | |
| Rated operational current | | | | | | | | |
| AC-15: 24 V I _e | A | — | 4 | — | — | — | — | — |
| 60 V I _e | A | — | 4 | — | — | — | — | — |
| 100 V I _e | A | — | 2 | — | — | — | — | — |
| 115 V I _e | A | 6 | — | — | — | — | — | — |
| 230 V I _e | A | 6 | 1.5 | — | — | — | — | — |
| 400 V I _e | A | 4 | — | — | — | — | — | — |
| 500 V I _e | A | 2 | — | — | — | — | — | — |
| DC-13: 24 V I _e | A | 3 | 1.5 | — | — | — | — | — |
| 42 V I _e | A | 1.7 | — | — | — | — | — | — |
| 60 V I _e | A | 1.2 | 0.8 | — | — | — | — | — |
| 110 V I _e | A | 0.6 (M22-CK...: 0.8) | 0.4 | — | — | — | — | — |
| 220 V I _e | A | 0.3 | 0.2 | — | — | — | — | — |
| Lifespan, electrical | | | | | | | | |
| AC-15: 230 V/0.5 A (operations) | x 10 ⁶ | 1.6 | — | — | — | — | — | — |
| 230 V/1.0 A (operations) | x 10 ⁶ | 1 | — | — | — | — | — | — |
| 230 V/3.0 A (operations) | x 10 ⁶ | 0.7 | — | — | — | — | — | — |
| DC-15: 12 V/2.8 A (operations) | x 10 ⁶ | 1.2 | — | — | — | — | — | — |

Notes

① < 10⁻⁷ (i.e., one failure every 107 operations).

② < 5 x 10⁻⁶ (i.e., one failure every 5 x 106 operations).

1.6

Pushbuttons and Indicating Lights

Global Modular 30 mm Pilot Devices—M30 Flat Operators

1

Global Modular 30 mm Pilot Devices, continued

| Description | Unit | Double Actuator Pushbuttons | (Illuminated) Selector Switches | Joysticks | Key-Operated Buttons | Indicator Lights Acoustic Devices Potentiometers | Controlled Stop/ Emergency Stop |
|---|-------------------|--|---------------------------------|--------------------|------------------------|--|---------------------------------|
| General | | | | | | | |
| Standards | | IEC/EN 60947-5-1 | IEC/EN 60947-5-1 | IEC/EN 60947-5-1 | IEC/EN 60947-5-1 | IEC/EN 60947-5-1 | IEC/EN 60947-5-5 |
| Lifespan, mechanical (operations) | x 10 ⁶ | 0.2 | 0.1 | 0.1 | 0.1 | — | 0.1 |
| Operating frequency (operations) | h | ≤ 3600 | ≤ 2000 | ≤ 2000 | ≤ 100 | — | ≤ 600 |
| Operating force | N | 5 | — | 5 | — | — | 50 |
| Operating torque (screw terminals) | Nm | — | 0.3 | — | 0.5 | — | — |
| Degree of protection (IEC/EN 60529) | | IP66 | M22: IP66 M30: IP64 | IP66 | M22: IP66 M30: IP64 | Indicator lights: IP67 Acoustic devices: IP40 Potentiometers: IP66 | IP67, IP69K |
| Climatic proofing | | Damp heat, constant as defined in IEC 60068-2-7; Damp heat, cyclic as defined in IEC 60068-2-3 | | | | | |
| Ambient air temperature, open | °C | –25 to +70 | –25 to +70 | –25 to +70 | –25 to +70 | –25 to +70 | –25 to +70 |
| Mounting position | | Any | Any | Any | Any | Any | Any |
| Mechanical shock resistance as defined in IEC 60068-2-27 Shock duration: 11 ms, half sine shock | g | 30 | M22: 30 M30: 15 | M22: 30 M30: 15 | M22: 30 M30: 15 | M22: 30 M30: — | 50 |
| Terminal capacities | | | | | | | |
| Solid | mm ² | — | — | — | — | 0.5–1.5 | — |
| Stranded | mm ² | — | — | — | — | 0.5–1.5 | — |
| Flexible with ferrule | mm ² | — | — | — | — | — | — |
| Contacts | | | | | | | |
| Rated impulse withstand voltage (U _{imp}) | Vac | — | — | — | — | 4000 | — |
| Rated insulation voltage (U _i) | V | — | — | — | — | 250 | — |
| Overvoltage category/ degree of pollution | | — | — | — | — | III/3 | — |
| Control circuit reliability | | | | | | | |
| At 24 Vdc/5 mA (failure rate) | H _f | — | — | — | — | — | — |
| At 5 Vdc/1 mA (failure rate) | H _f | — | — | — | — | — | — |
| Max. short-circuit protective device | | | | | | | |
| Fuseless (part no.) | A | — | — | — | — | — | — |
| Fuse (gG/gL) | | — | — | — | — | — | — |
| Switching Capacity | | | | | | | |
| | A | N/A | N/A | N/A | N/A | N/A | N/A |

Dimensions

Approximate Dimensions in mm [inches]

M30... with 2 M22-K... Standard Contact Elements

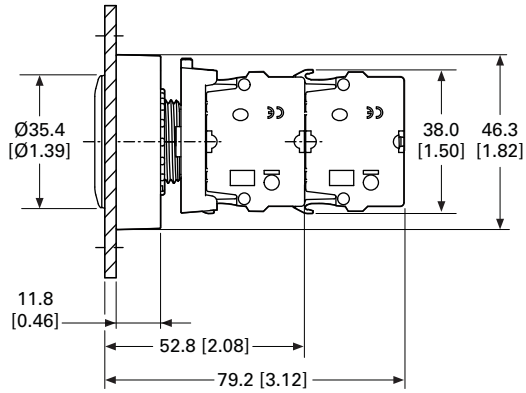

M30... with M22-FK... Flat Rear Contact Elements

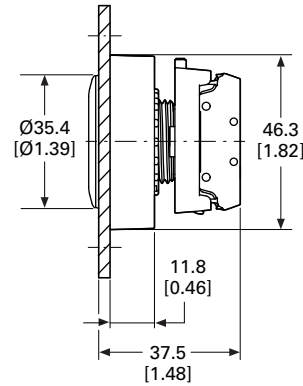

Pushbuttons, Blanking Plug

M30C-FD..., M30C-FB

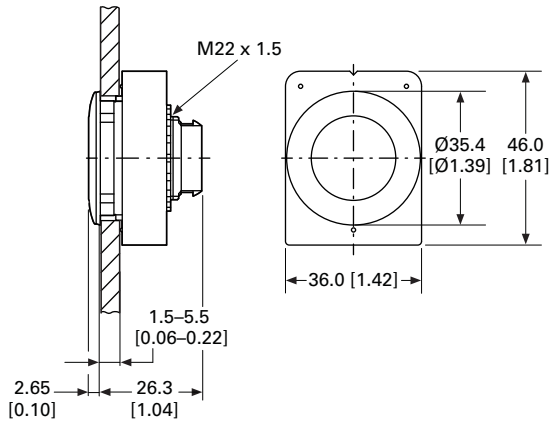

Indicator Lights

M30C-FL...

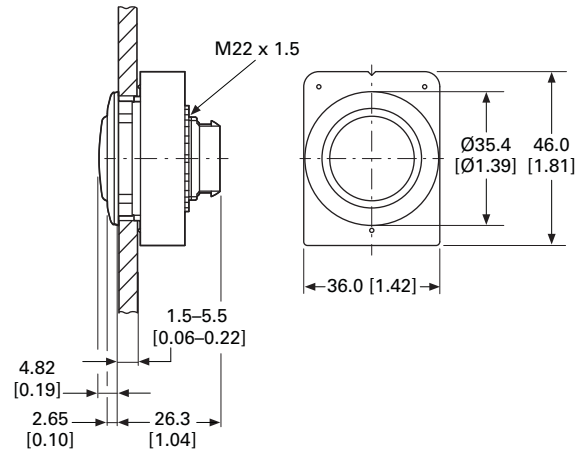

Selector Switches

With Rotary Head M30C-FW...

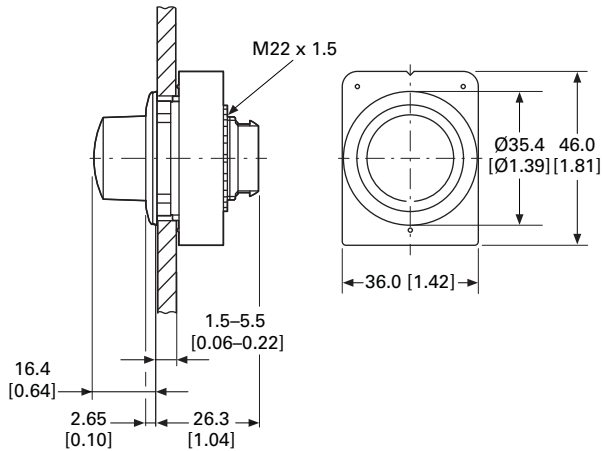

Illuminated Selector Switches

With Thumb-Grip, Four-Way M30C-FW(L)K(V)-...

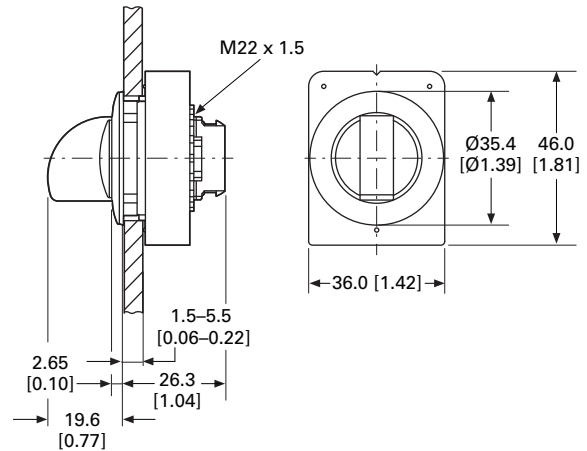

1.6

Pushbuttons and Indicating Lights

Global Modular 30 mm Pilot Devices—M30 Flat Operators

1

Approximate Dimensions in mm [inches]

Key-Operated Buttons

M30C-FW(R)S(3)-MS...

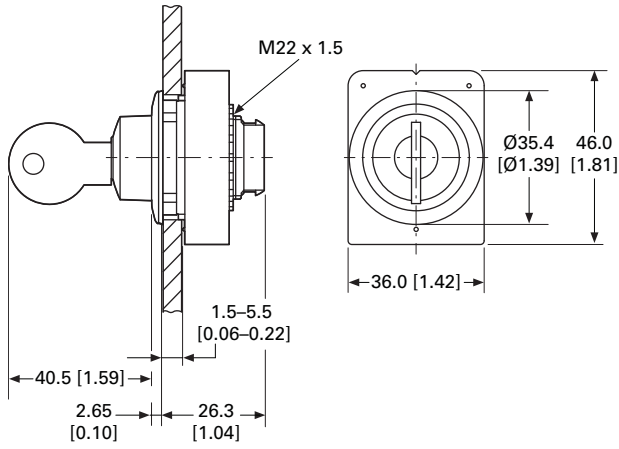

Key-Operated Buttons

M30C-FW(R)S(3)-RS...

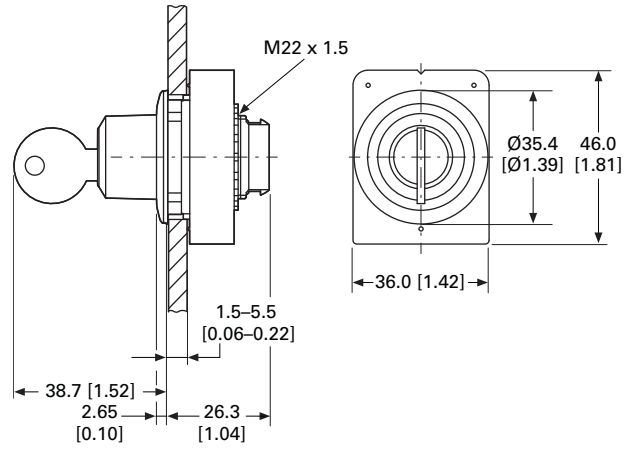

Key-Operated Buttons

M30C-FW(R)S(3)-SA...

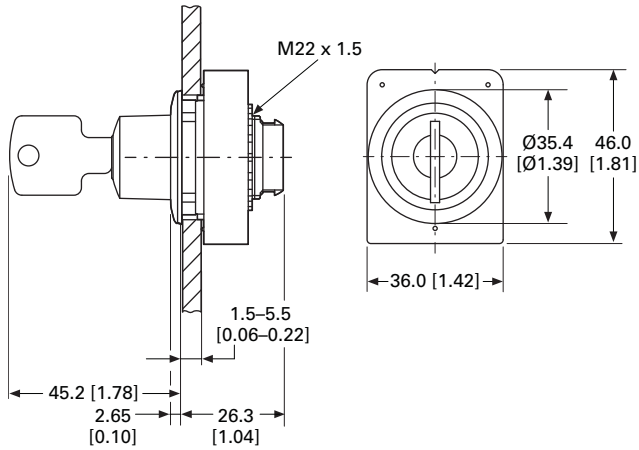

Potentiometers

M30C-FR...

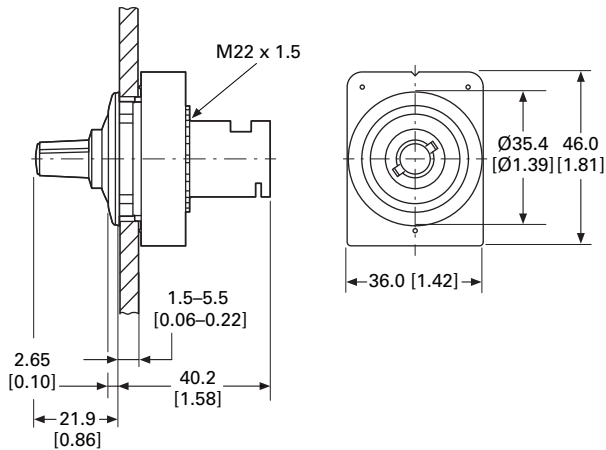

Potentiometers, SmartWire-DT

M30C-FR-SWD

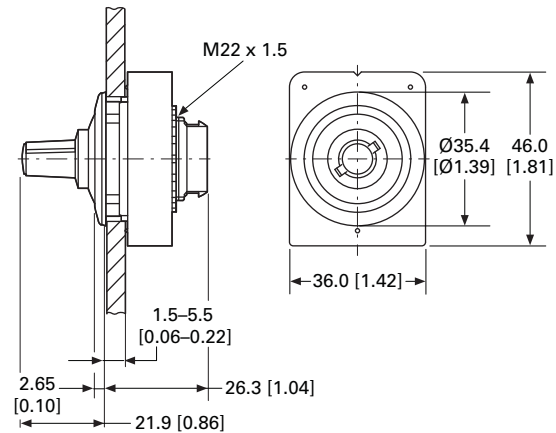

Approximate Dimensions in mm [inches]

Encoders, SmartWire-DT

M30C-FINC-SWD

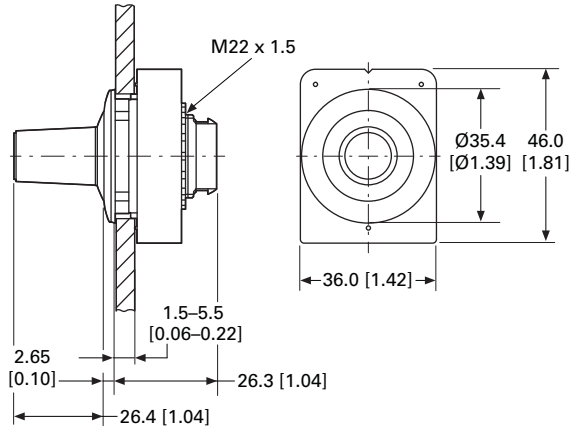

Joysticks

M30C-FW(R)JS...

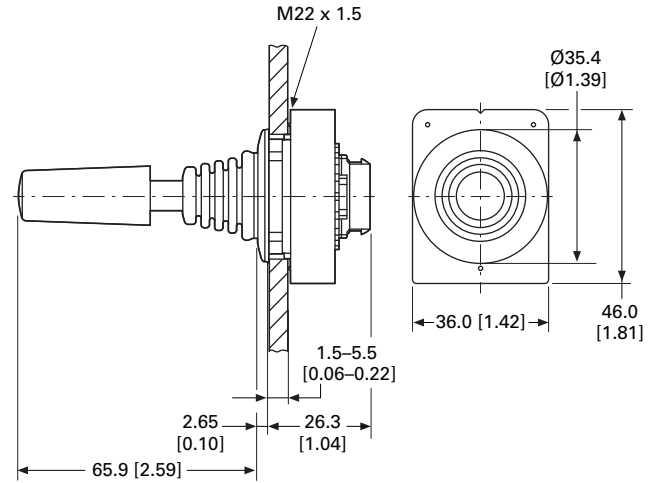

Mounting hole without key slot

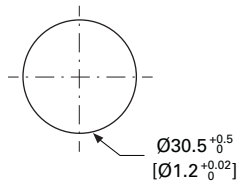

Mounting hole with key slot

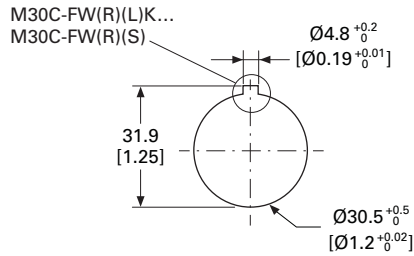

Grid dimensions for various combinations

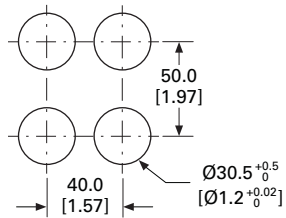

Global Compact 30 mm Pilot Devices —C30 Flat with Pigtail



Contents

Description

Page

| | |
|--|------------------|
| Global Compact 30 mm Pilot Devices— C30 Flat with Pigtail | |
| System Overview | V7-T1-187 |
| Product Selection | V7-T1-188 |
| Technical Data | V7-T1-192 |
| Dimensions | V7-T1-193 |

Product Description

The new and modern all-in-one C30 compact and flat 30 mm pilot devices with pigtail integrate the required cable, connector and housing in one single device.

Ability to provide protection up to IP69K at the front and IP65 at the back make these devices the perfect choice for applications where oil-tight protection from dirt and liquid is a must.

Features

Our product offering includes momentary and maintained operators; illuminated and non-illuminated pushbuttons; illuminated and non-illuminated selector switches and indicating lights. C30 pilot devices come with the following pigtail options:

- P5 for 1 m cable with M12
- P32 for 1 m cable with M8
- P62 for 1 m cable with open wire
- P65 for 3.5 m

C30 compact and flat with pigtail 30 mm pilot devices offer modern look and smooth transition between the machine and the operator.

The cable, plug connector and housing are already integrated and permanently installed for plug and play.

C30 pilot devices are also fully assembled for easy stocking and sustainable inventory management.

Standards and Certifications

- All operators and components are IEC/EN 60947 VDE 0660
- All C30 flat operators (for enclosed type devices or flat-front surface mounted devices only) are environmentally rated as Type 1, 3R, 4X, 12 or 13 UL File #: E29184
- All operators carry an IP66 rating with some rated for washdown environments with IP67 and IP69K
- Marine classification societies: Bureau Veritas (BV), Germanischer Lloyd (GL) and Lloyd's Register of Shipping (LR) approved



System Overview

Global Compact 30 mm Pilot Devices—C30 Flat with Pigtail

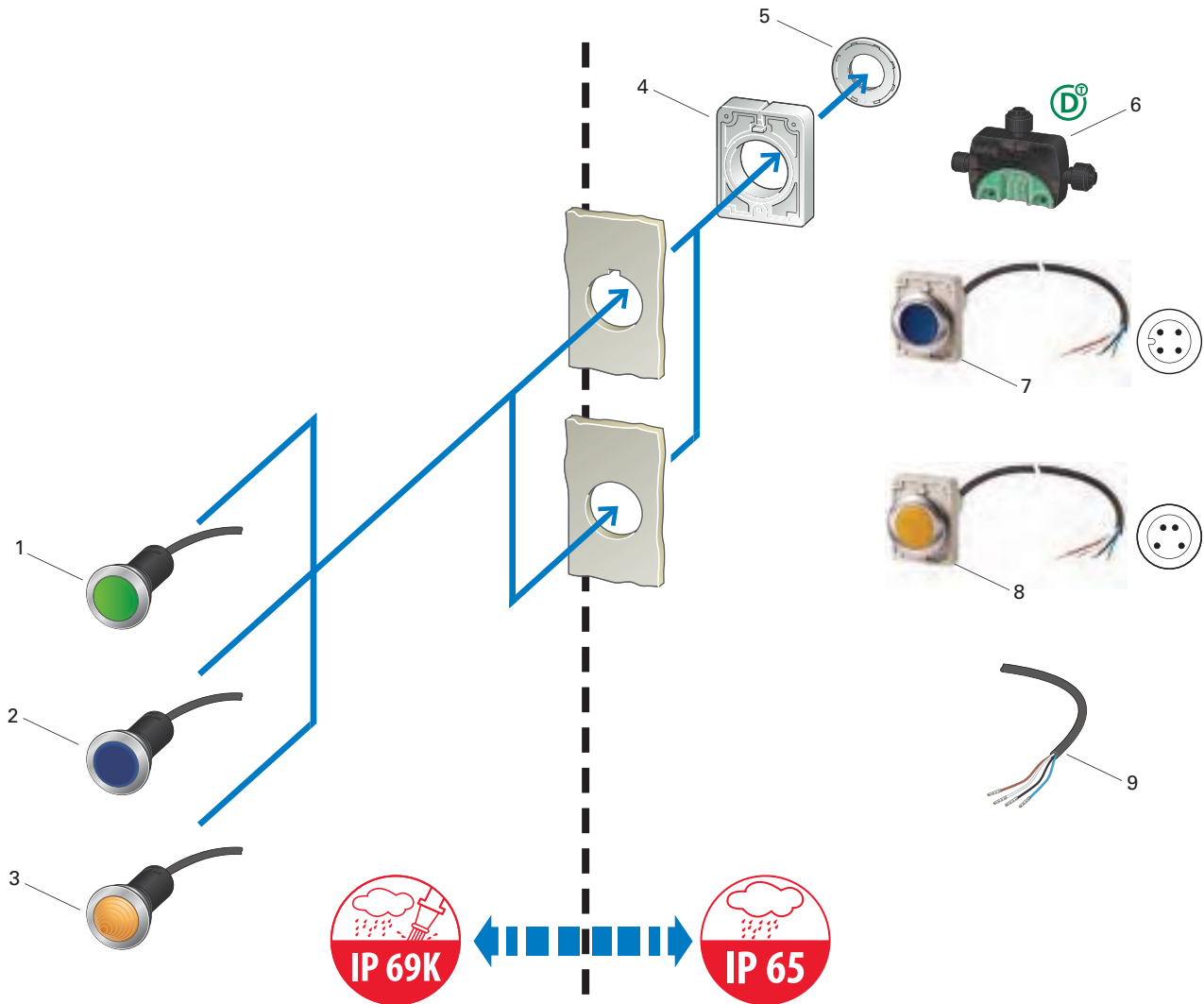

Global Compact 30 mm Pilot Devices—C30 Flat with Pigtail (Legend)

| Item | Description |
|------|---|
| 1 | C30 Pushbuttons Momentary and maintained Flush Colors: white, green, red, black With cable (1.5 or 3 m) and plug (M12A or M8, 4-pole) or unterminated cable end (4-pole) See Page V7-T1-188 |
| 2 | C30 Illuminated Pushbutton Actuators Momentary and maintained Flush Colors: white, green, red, blue With cable (1.5 or 3 m) and plug (M12A or M8, 4-pole) or unterminated cable end (4-pole) 24 Vac/Vdc See Page V7-T1-191 |

| Item | Description |
|------|---|
| 3 | C30 Indicator Lights Flush Colors: white, green, red, blue, yellow With cable (1.5 or 3 m) and plug (M12A or M8, 4-pole) or unterminated cable end (4-pole) 24 Vac/Vdc See Page V7-T1-190 |
| 4 | RMQ-AFX Anti-Rotation Tab Included with C30 compact devices |
| 5 | Threaded Rings See Page V7-T1-110 |

| Item | Description |
|------|---|
| 6 | SmartWire-DT I/O Module For connecting digital input/output signals to SmartWire-DT IP67 |
| 7 | Cable with M12A Plug, 4-Pole |
| 8 | Cable with M8A Plug, 4-Pole |
| 9 | Cable End Open, 4-Pole |

1













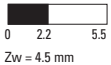



Product Selection

Pushbuttons

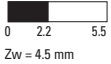
30 mm Flat Front—Metal Bezel

IP66, IP67, IP69K (at front), IP65 (at rear)

Flush

| Cable Length (m) | Button Plate | Contact Configuration ① | | Contact Sequence ② | Contact Diagram | Std. Pack | Momentary Catalog Number | Maintained Catalog Number |
|------------------|---|----------------------------|------------------------------|---|---|-----------|--------------------------|---------------------------|
| | | NO = Normally Open Contact | NC = Normally Closed Contact | | | | | |
| 1 |  | — | 1NC ⊖ |  |  | 1 Unit | C30C-FD-R-K01-P5 | C30C-FDR-R-K01-P5 |
| |  | — | 1NC ⊖ | | | | C30C-FD-S-K01-P5 | C30C-FDR-S-K01-P5 |
| | Without button plate | — | 1NC ⊖ | | | | C30C-FD-X-K01-P5 | C30C-FDR-X-K01-P5 |
| 1 |  | 1NO | — |  |  | 1 Unit | C30C-FD-G-K10-P5 | C30C-FDR-G-K10-P5 |
| |  | 1NO | — | | | | C30C-FD-W-K10-P5 | C30C-FDR-W-K10-P5 |
| | Without button plate | 1NO | — | | | | C30C-FD-X-K10-P5 | C30C-FDR-X-K10-P5 |
| 1 |  | — | 1NC ⊖ |  |  | 1 Unit | C30C-FD-R-K01-P32 | C30C-FDR-R-K01-P32 |
| |  | — | 1NC ⊖ | | | | C30C-FD-S-K01-P32 | C30C-FDR-S-K01-P32 |
| | Without button plate | — | 1NC ⊖ | | | | C30C-FD-X-K01-P32 | C30C-FDR-X-K01-P32 |
| 1 |  | 1NO | — |  |  | 1 Unit | C30C-FD-G-K10-P32 | C30C-FDR-G-K10-P32 |
| |  | 1NO | — | | | | C30C-FD-W-K10-P32 | C30C-FDR-W-K10-P32 |
| | Without button plate | 1NO | — | | | | C30C-FD-X-K10-P32 | C30C-FDR-X-K10-P32 |

Notes

① ⊖ = Safety function implemented with positive opening as defined in IEC/EN 60947-5-1.

② Contact sequence: ■ = contact closed; □ = contact open.

30 mm Flat Front—Metal Bezel, continued

IP66, IP67, IP69K (at front), IP65 (at rear)
Flush



| Cable Length (m) | Button Plate | Contact Configuration ① | | Contact Sequence ② | Contact Diagram | Std. Pack | Momentary Catalog Number | Maintained Catalog Number | |
|------------------|------------------------------|------------------------------|------------------------------|--------------------|------------------------------|------------------------------|--------------------------|---------------------------|--------------------|
| | | NO = Normally Open Contact | NC = Normally Closed Contact | | | | | | |
| 1 | Without button plate | — | 1NC | ⇒ | 0 2.2 5.5 Zw = 4.5 mm | 1 Unit | C30C-FD-R-K01-P62 | C30C-FDR-R-K01-P62 | |
| | | | 2NC | ⇒ | 0 2.2 5.5 Zw = 4.5 mm | | C30C-FD-S-K01-P62 | C30C-FDR-S-K01-P62 | |
| | | | 1NO | 1NC | ⇒ | | 0 2.2 3.15 5.5 | C30C-FD-X-K01-P62 | C30C-FDR-X-K01-P62 |
| | | Without button plate | 1NO | — | 0 3.15 5.5 | | C30C-FD-G-K10-P62 | C30C-FDR-G-K10-P62 | |
| | | | 2NO | — | 0 3.15 5.5 | | C30C-FD-W-K10-P62 | C30C-FDR-W-K10-P62 | |
| | | | 2NO | — | 0 3.15 5.5 | | C30C-FD-X-K10-P62 | C30C-FDR-X-K10-P62 | |
| | 3.5 | Without button plate | — | 1NC | ⇒ | 0 2.2 5.5 Zw = 4.5 mm | 1 Unit | C30C-FD-R-K01-P65 | C30C-FDR-R-K01-P65 |
| | | | | 2NC | ⇒ | 0 2.2 5.5 Zw = 4.5 mm | | C30C-FD-S-K01-P65 | C30C-FDR-S-K01-P65 |
| | | | | 1NO | 1NC | ⇒ | | 0 2.2 3.15 5.5 | C30C-FD-X-K01-P65 |
| | | | Without button plate | 1NO | — | 0 3.15 5.5 | | C30C-FD-G-K10-P65 | C30C-FDR-G-K10-P65 |
| | | | | 2NO | — | 0 3.15 5.5 | | C30C-FD-W-K10-P65 | C30C-FDR-W-K10-P65 |
| | | | | 2NO | — | 0 3.15 5.5 | | C30C-FD-X-K10-P65 | C30C-FDR-X-K10-P65 |

Notes















































- ① ⇒ = Safety function implemented with positive opening as defined in IEC/EN 60947-5-1.
- ② Contact sequence: ■ = contact closed; □ = contact open.

1

Indicating Lights

30 mm Flat Front—Metal Bezel

LED Rated Operating Voltage: 24 Vac/Vdc
IP66, IP67, IP69K (at Front), IP65 (at Rear)

| | Connection Type | Cable Length (m) | Lens | LED | Contact Sequence | Std. Pack | Catalog Number | |
|--|--|------------------|---|---|---|-----------|-------------------------|-------------------------|
|  | Cable (Black) with M12A Plug 4-Pole | 1 |  |  |  | 1 Unit | C30C-FL-B-24-P5 | |
| | | |  |  | | | C30C-FL-G-24-P5 | |
| | | |  |  | | | C30C-FL-R-24-P5 | |
| | | |  |  | | | C30C-FL-W-24-P5 | |
| | | |  |  | | | C30C-FL-Y-24-P5 | |
| | | | | | | | | |
|  | Cable (Black) with M8 Plug 4-Pole | 1 |  |  |  | 1 Unit | C30C-FL-B-24-P32 | |
| | | |  |  | | | C30C-FL-G-24-P32 | |
| | | |  |  | | | C30C-FL-R-24-P32 | |
| | | |  |  | | | C30C-FL-W-24-P32 | |
| | | |  |  | | | C30C-FL-Y-24-P32 | |
| | | | | | | | | |
|  | Cable (Black) with Untermated End 4-Pole | 1 |  |  |  | 1 Unit | C30C-FL-B-24-P62 | |
| | | |  |  | | | C30C-FL-G-24-P62 | |
| | | |  |  | | | C30C-FL-R-24-P62 | |
| | | |  |  | | | C30C-FL-W-24-P62 | |
| | | |  |  | | | C30C-FL-Y-24-P62 | |
| | | | | | | | | |
| | | | 3.5 |  |  | | 1 Unit | C30C-FL-B-24-P65 |
| | | | |  |  | | | C30C-FL-G-24-P65 |
| | | | |  |  | | | C30C-FL-R-24-P65 |
| | | | |  |  | | | C30C-FL-W-24-P65 |
| | | | |  |  | | | C30C-FL-Y-24-P65 |
| | | | | | | | | |

Illuminated Pushbutton Actuators

30 mm Flat Front—Metal Bezel

LED Rated Operating Voltage: 24 Vac/Vdc
 IP66, IP67, IP69K (at Front), IP65 (at Rear)
 Flush

| Cable Length (m) | Button Plate | LED | Contact Configuration ① | | Contact Sequence ② | Contact Diagram | Std. Pack | Momentary Catalog Number | Maintained Catalog Number | | | | |
|------------------|--------------|-----|----------------------------|------------------------------|--------------------|-----------------|-----------|--------------------------|---------------------------|--|--|---------------------|----------------------|
| | | | NO = Normally Open Contact | NC = Normally Closed Contact | | | | | | | | | |
| 1 | | | — | 1NC ⊕ | | | 1 | C30C-FDL-RK01-24P5 | C30C-FDRL-RK01-24P5 | | | | |
| | | | 1NO | — | | | | | | | | C30C-FDL-BK10-24P5 | C30C-FDRL-BK10-24P5 |
| | | | 1NO | — | | | | | | | | C30C-FDL-GK10-24P5 | C30C-FDRL-GK10-24P5 |
| | | | — | — | | | | | | | | C30C-FDL-WK10-24P5 | C30C-FDRL-WK10-24P5 |
| 1 | | | — | 1NC ⊕ | | | 1 | C30C-FDL-RK01-24P32 | C30C-FDRL-RK01-24P32 | | | | |
| | | | 1NO | — | | | | | | | | C30C-FDL-BK10-24P32 | C30C-FDRL-BK10-24P32 |
| | | | 1NO | — | | | | | | | | C30C-FDL-GK10-24P32 | C30C-FDRL-GK10-24P32 |
| | | | — | — | | | | | | | | C30C-FDL-WK10-24P32 | C30C-FDRL-WK10-24P32 |
| 1 | | | — | 1NC ⊕ | | | 1 | C30C-FDL-RK01-24P62 | C30C-FDRL-RK01-24P62 | | | | |
| | | | 1NO | — | | | | | | | | C30C-FDL-BK10-24P62 | C30C-FDRL-BK10-24P62 |
| | | | 1NO | — | | | | | | | | C30C-FDL-GK10-24P62 | C30C-FDRL-GK10-24P62 |
| | | | — | — | | | | | | | | C30C-FDL-WK10-24P62 | C30C-FDRL-WK10-24P62 |
| 1 | | | — | 1NC ⊕ | | | 1 | C30C-FDL-RK01-24P65 | C30C-FDRL-RK01-24P65 | | | | |
| | | | 1NO | — | | | | | | | | C30C-FDL-BK10-24P65 | C30C-FDRL-BK10-24P65 |
| | | | 1NO | — | | | | | | | | C30C-FDL-GK10-24P65 | C30C-FDRL-GK10-24P65 |
| | | | — | — | | | | | | | | C30C-FDL-WK10-24P65 | C30C-FDRL-WK10-24P65 |

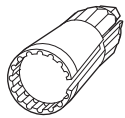

Mounting Ring Tool

| Description | Std. Pack | Catalog Number |
|---|-----------|----------------|
| For threaded ring; can be used with cordless screwdriver. | 1 Unit | C22-MS |

Notes

- ① ⊕ = Safety function implemented with positive opening as defined in IEC/EN 60947-5-1.
- ② Contact sequence: ■ = contact closed; □ = contact open.

Technical Data

Global Compact 30 mm Pilot Devices—C30 Flat with Pigtail

| Description | Unit | Controlled stop/ emergency switching off buttons | (Illuminated) pushbuttons Momentary/ maintained | Selector switches | Key-operated buttons | Indicator lights |
|---|------------------------------|--|--|---|---|--|
| General | | | | | | |
| Standards | | IEC/EN 60947-5-5 VDE 0660 | IEC/EN 60947-5-1 VDE 0660 | IEC/EN 60947-5-1 VDE 0660 | IEC/EN 60947-5-1 VDE 0660 | IEC/EN 60947-5-1 VDE 0660 |
| Lifespan, mechanical | Operations x 10 ⁶ | 0.05 | 5/1 | 1 | 0.1 | — |
| Operating frequency | Operations/h | 300 | 3600 | 2000 | 100 | — |
| Operating force | N | 50 | 5 | — | — | — |
| Operating torque | Nm | — | — | 0.3 | 0.5 | — |
| Plug tightening torque | Nm | M12 = 1, M8 = 0.6 | M12 = 1, M8 = 0.6 | M12 = 1, M8 = 0.6 | M12 = 1, M8 = 0.6 | M12 = 1, M8 = 0.6 |
| Threaded ring tightening torque | Nm | 2 | 2 | 2 | 2 | 2 |
| Climatic proofing | | | | | | |
| Damp heat, constant | | As defined in IEC 60068-2-78 | As defined in IEC 60068-2-78 | As defined in IEC 60068-2-78 | As defined in IEC 60068-2-78 | As defined in IEC 60068-2-78 |
| Damp heat, cyclic | | As defined in IEC 60068-2-30 | As defined in IEC 60068-2-30 | As defined in IEC 60068-2-30 | As defined in IEC 60068-2-30 | As defined in IEC 60068-2-30 |
| Degree of protection | | IP66, IP67, IP69K (at front) IP65 (at rear) | IP66, IP67, IP69K (at front) IP65 (at rear) | IP66, IP67, IP69K (at front) IP65 (at rear) | IP66, IP67, IP69K (at front) IP65 (at rear) | IP66, IP67, IP69K (at front) IP65 (at rear) |
| Ambient air temperature ^① | | | | | | |
| Open | °C | -30 – +70 | -30 – +70 | -30 – +70 | -30 – +70 | -25 – +70 |
| Storage | °C | -30 – +80 | -30 – +80 | -30 – +80 | -30 – +80 | -30 – +80 |
| Mounting position | | Any | Any | Any | Any | Any |
| Mechanical shock resistance for a shock duration of 11 ms | g | >30 | >30 | >30 | >30 | >30 |
| Contacts | | | | | | |
| Rated impulse withstand voltage | U _{imp} | Vac | M12A/unterminated: 4000 M8: 800 | M12A/unterminated: 4000 M8: 800 | M12A/unterminated: 4000 M8: 800 | M12A/unterminated: 4000 M8: 800 |
| Rated insulation voltage | U _i | V | M12A/unterminated: 250 M8: 30 | M12A/unterminated: 250 M8: 30 | M12A/unterminated: 250 M8: 30 | M12A/unterminated: 250 M8: 30 |
| Overvoltage category/degree of pollution | | III/3 | III/3 | III/3 | III/3 | III/3 |
| Control circuit reliability at 17 Vdc/7 mA | HF | | | | | |
| NO (statistically determined) | | 1 failure per 17 x 10 ⁶ operations | 1 failure per 17 x 10 ⁶ operations | 1 failure per 17 x 10 ⁶ operations | 1 failure per 17 x 10 ⁶ operations | — |
| NC (statistically determined) | | 1 failure per 0.9 x 10 ⁶ operations | 1 failure per 0.9 x 10 ⁶ operations | 1 failure per 0.9 x 10 ⁶ operations | 1 failure per 0.9 x 10 ⁶ operations | — |
| Fuse | gG/gL | A | 4 | 4 | 4 | 4 |
| Conditional short-circuit current | I _q | kA | 1 | 1 | 1 | 1 |
| Switching capacity | | | | | | |
| Rated operational current | I _e | A | | | | |
| AC-15: 24 V | I _e | A | 4 | 4 | 4 | — |
| DC-13: 24 V | I _e | A | 3 | 3 | 3 | — |
| Cable characteristics | | | | | | |
| Versions | | | M12A/ unterminated | M12A/M8/ unterminated | M12A/M8/ unterminated | M12A/M8/ unterminated |
| Material | | | PUR | PUR | PUR | PUR |
| Diameter | ∅ | mm | 4.7 | 4.7 | 4.7 | 4.7 |
| Actuator travel and actuation force as per DIN EN 60947-5-1, K.5.4.1 | | | | | | |
| Positive opening sequence | | mm | 4.65 | 4.65 | 4.65 | — |
| Maximum travel | | mm | 5.11 | 5.7 | 5.7 | — |
| Minimum force for positive opening | | N | K01 = 15/ K11 = 20/K02 = 34 | K01 = 15/ K11 = 20/K02 = 30 | K01 = 15/ K11 = 20/K02 = 35 | K01 = 15/ K11 = 20/K02 = 36 |

Note

^① Applicable for C22 with pigtail options.

Dimensions

Approximate Dimensions in mm [inches]

Pushbuttons, M12A

C30C-FD(R/L)-...-P5

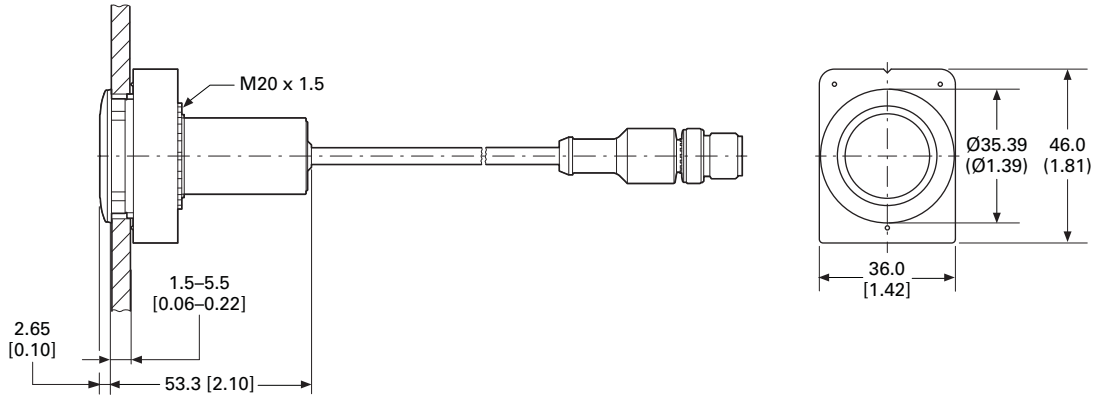

Pushbuttons, M8

C30C-FD(R/L)-...-P32

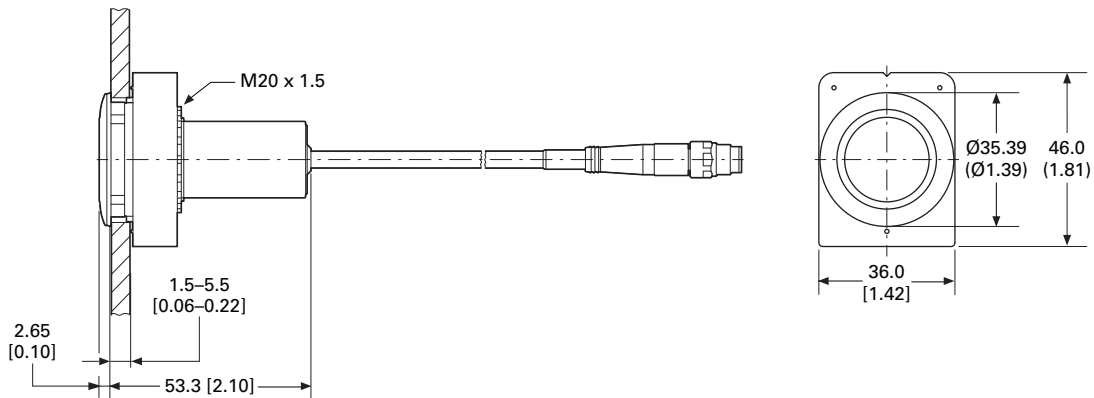

Pushbuttons, Unterminated Cable End

C30C-FD(R/L)-...-P62/-65

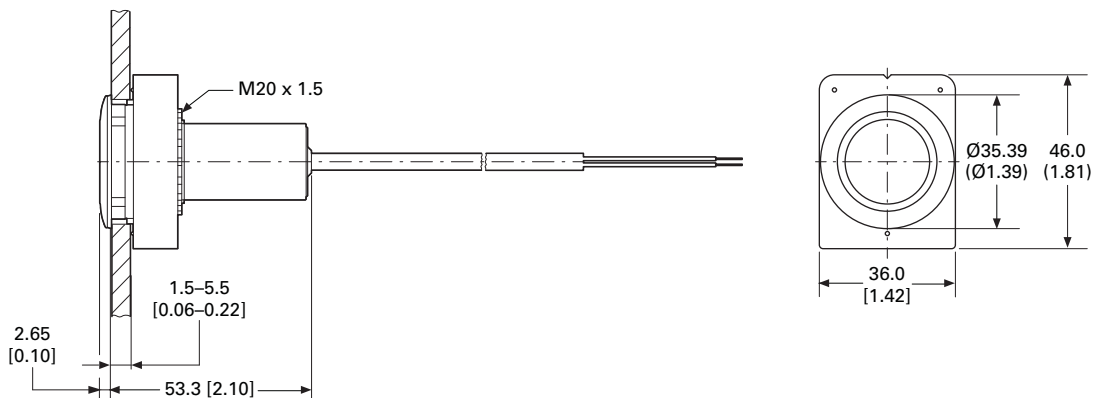

1.7

Pushbuttons and Indicating Lights

Global Compact 30 mm Pilot Devices—C30 Flat with Pigtail

1

Approximate Dimensions in mm [inches]

Indicator Lights, M12A

C30C-FL-...-P5

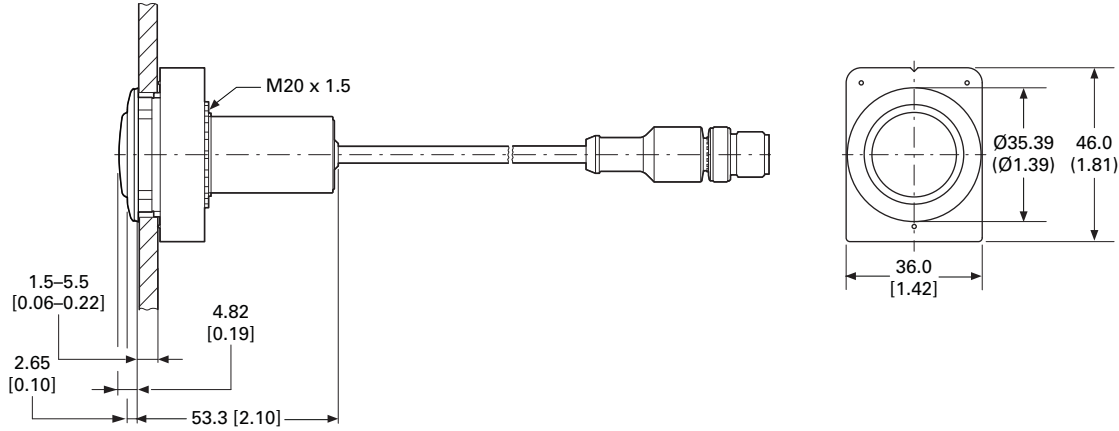

Indicator Lights, M8

C30C-FL-...-P32

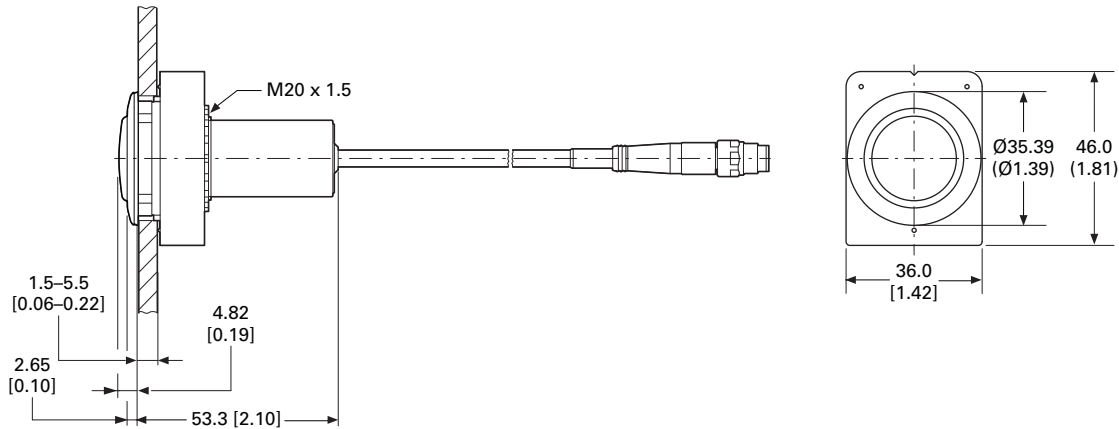

Indicator Lights, Underminated Cable End

C30C-FL-...-24-P62/-P65

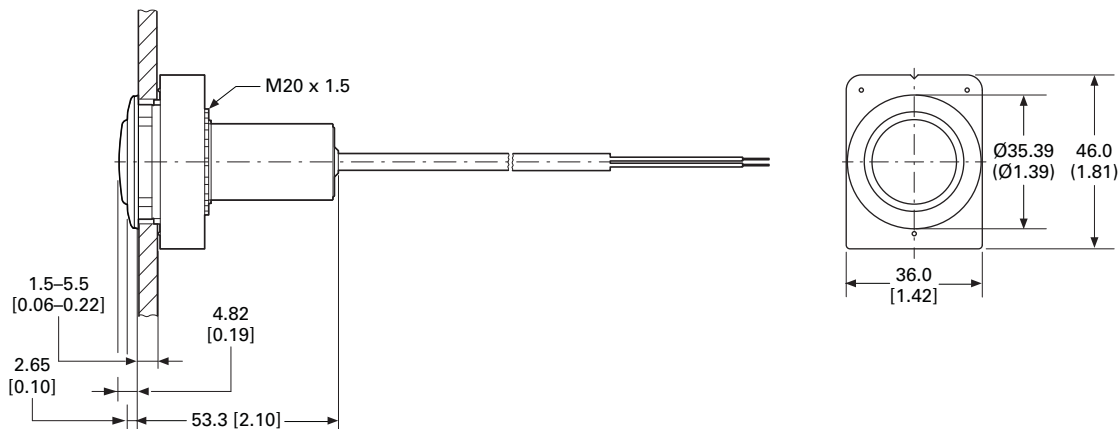

30.5 mm Square Multifunction Watertight/Oiltight—E30



Contents

| <i>Description</i> | <i>Page</i> |
|--|------------------|
| 30.5 mm Square Multifunction Watertight/Oiltight—E30 | |
| Product Identification | V7-T1-196 |
| Product Selection | |
| Operators | V7-T1-197 |
| Operator Components | V7-T1-200 |
| Accessories | V7-T1-206 |
| Options | V7-T1-207 |
| Replacement Parts | V7-T1-210 |
| Technical Data and Specifications | V7-T1-211 |
| Dimensions | V7-T1-212 |

Product Description

The E30 industrial pushbutton and indicating light line from Eaton's Electrical Sector features a wide selection of square, multifunction operators which conveniently mount in a standard 30.5 mm (1-13/64 in) diameter panel hole. Up to six input and indicating functions can be grouped into a single operating head, saving valuable panel space. Attractive square operator styling, coupled with custom legending of colored buttons and lenses and many special function accessories, makes E30 components ideally suited for use on control consoles and for a variety of industrial OEM applications.

Features

Type E30 control units consist of a basic operator with one or more buttons and lenses and contact block selection dependent on the specific operator configuration.

- **Pushbutton operators** will accommodate up to four single depth stackable contact blocks behind each operating button, up to eight circuits maximum.
- **Indicating lights** are supplied complete with either a transformer light unit up to 600 Vac supply line voltage or full voltage light unit up to 120 Vac/Vdc supply line voltage.
- **Combination pushbutton with indicating light** operators are supplied complete with a transformer or full voltage unit. Contact blocks must be ordered separately, up to four circuits maximum.

Die Cast Construction

Each operator has high pressure type seals to prevent the passage of oil and other contaminants through the operator into the contact structure or panel interior. Each operator uses a Buna N cork gasket between the mounting flange on the operator and the panel to maintain oiltightness.

Standards and Certifications

- UL Listed—File No. E131568
- CSA Certified—File No. LR68551



Ingress Protection

- Single and dual indicating lights
 - UL (NEMA) Type 1, 2, 3, 3R, 3S, 4, 4X, 12, 13
- All other operators
 - UL (NEMA) Type 3, 3R, 4, 4X, 12, 13

1

Product Identification

30.5 mm Square Multifunction Watertight/Oiltight

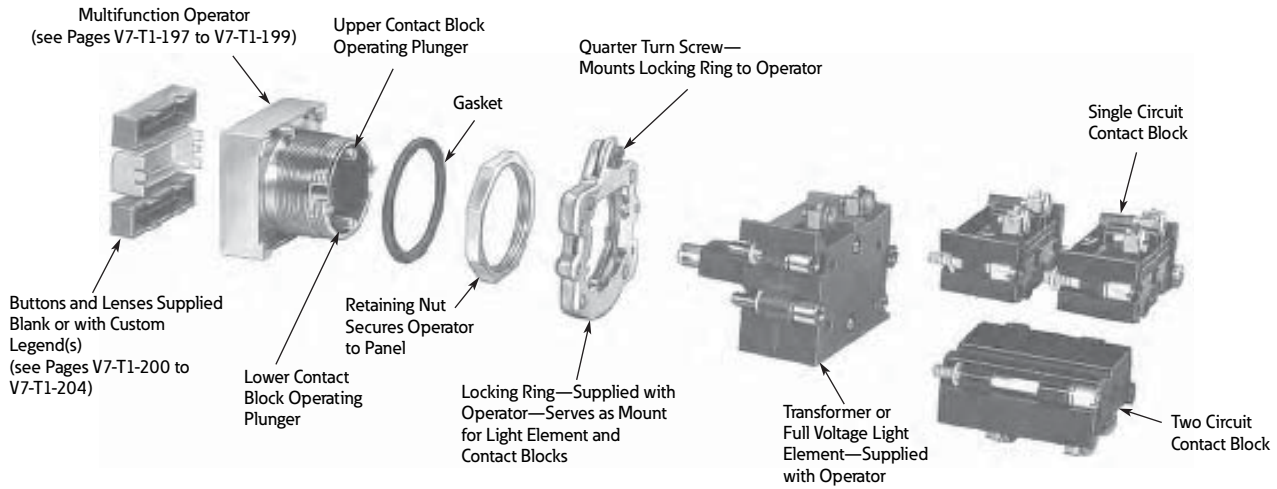

Product Selection

Operators

When Ordering a Complete E30 Control Unit Specify

| Catalog Number of ... | Ordering Example (E30AB) | |
|---------------------------|--------------------------|---------|
| Operator | E30KB130 | “START” |
| Button(s) | E30KB231 | “STOP” |
| Contact block(s) | E30KLA1 | 1NO |
| Accessories (if required) | E30KLA2 | 1NC |

Square Multifunction Operators

UL (NEMA) Type 3, 3R, 4, 4X, 12, 13

Single Button Operator

Single Button Operator/without Button (Order Button Separately)



Shown with Extended Button

| Button Type Required ① | Operation | Special Features | Catalog Number |
|---|-----------|------------------|----------------|
|  | Momentary | — | E30AA |

Two Button Operator

Two Button Operator/without Buttons (Order Buttons Separately)

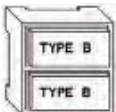

Shown with Extended Buttons

| Button Types Required ① | Operation | | Special Features | Catalog Number |
|---|---------------------------|------------------------|---------------------------|-----------------|
| | Top Button | Bottom Button | | |
|  | Momentary | Momentary | — | E30AB |
| | Momentary | Momentary | With mechanical interlock | E30AC |
| | Maintained (all contacts) | Release (all contacts) | — | E30AD ② |
| | Maintained (all contacts) | Release (all contacts) | With mechanical interlock | E30AP ②③ |

Two Button Operator

Two Button Operator with Long (OFF) Release Bar—Includes OFF Bar/Button (Order Other Buttons Separately)

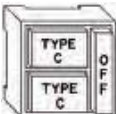

Shown with Long Release Bar

| Button Types Required ④⑤ | Operation | | Special Features | Catalog Number |
|---|---------------------------|-----------------------------------|--|----------------|
| | Top Button | Bottom Button | | |
|  | Maintained | Maintained | — | E30AF |
| | Maintained | Maintained | With mechanical interlock | E30AG |
| | Maintained | Momentary | With mechanical interlock | E30AH |
| | Maintained (all contacts) | Maintained (bottom contacts only) | Top button operates both top and bottom contacts | E30AK ⑥ |



Notes

- ① Order from table on **Page V7-T1-200**.
- ② Limited to two single circuit, one double circuit 600V or two 120V (E30KLA9) contact blocks behind each button.
- ③ Buttons are interlocked so that one of the two is maintained at all times. Depressing the other button releases the maintained button and maintains the depressed button.
- ④ Operators are supplied as standard with red extended bar(s) marked “OFF” as shown in sketch. For other colors or markings, contact your nearest Eaton Distributor or call our Customer Service Center 1-800-356-1243. For replacement of standard red release bar, order **E30KR100**.
- ⑤ Order from table on **Page V7-T1-201**.
- ⑥ Limited to two single circuit, one double circuit 600V or two 120V (E30KLA9) contact blocks behind each button.

Square Multifunction Operators and Indicating Lights

UL (NEMA) Type 3, 3R, 4, 4X, 12, 13

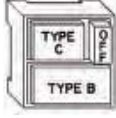
Two Button Operator with (OFF) Release—Includes OFF Bar/Button(s) (Order Other Buttons Separately)

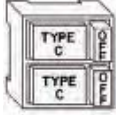
| Two Button Operator | Button Types Required ^{①②} | Operation | | Special Features | Catalog Number |
|--|---|---------------------------|---------------------------|---|----------------|
| | | Top Button | Bottom Button | | |
|  <p>Shown with Release Bar for Top Button</p> |  | Maintained | Momentary | Release bar for top button | E30AL |
|  <p>Shown with Release Bars for Each Button</p> |  | Maintained | Maintained | Individual release bars for each button | E30AN |
| | | Maintained with interlock | Maintained with interlock | Individual release bars for each button | E30AM |

Single Indicating Light Unit



Shown with Lens

Single Indicating Light Unit/without Lens (Order Lens Separately)

| Lens Type Required ^③ | Type of Light Element | | | Full Voltage (60/50 Hertz AC or DC) | | |
|---|------------------------------|--------------------------|----------------|-------------------------------------|--------------------------|----------------|
| | Transformer (60/50 Hertz AC) | | | | | |
| | Voltage | Lamp Number ^④ | Catalog Number | Voltage | Lamp Number ^④ | Catalog Number |
|  | 120 | #259 | E30BA | 24 | 24PSB | E30BJ |
| | | | | 120 | 120PSB | E30BM |

Dual Indicating Light Unit



Shown with Lens

Dual Indicating Light Unit/without Lenses (Order Lenses Separately)

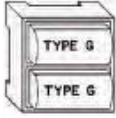
| Lens Types Required ^⑤ | Type of Light Element | | | Full Voltage (60/50 Hertz AC or DC) | | |
|---|------------------------------|--------------------------|----------------|-------------------------------------|--------------------------|----------------|
| | Transformer (60/50 Hertz AC) | | | | | |
| | Voltage | Lamp Number ^④ | Catalog Number | Voltage | Lamp Number ^④ | Catalog Number |
|  | 120 | 6PSB | E30CA | 24 | 24PSB | E30CJ |
| | | | | 120 | 120PSB | E30CM |

Notes

- ① Order from table on **Page V7-T1-201**.
- ② Operators are supplied as standard with red extended release bar(s) marked "OFF" as shown in sketch. For other colors or markings, contact your nearest Eaton Distributor or call our Customer Service Center 1-800-356-1243. For replacement of standard red release bar, order **E30KR101**.
- ③ Order from table on **Page V7-T1-202**.
- ④ Light units will also accept LED lamps. For LED part numbers, see table on **Page V7-T1-210**.
- ⑤ Order from table on **Page V7-T1-203**.

UL (NEMA) Type 3, 3R, 4, 4X, 12, 13

Single Button Operator and Indicating Light



Shown with Button and Lens

Single Button Operator with Indicating Light/without Button or Lens (Order Button and Lens Separately)

| Button and Lens Types Required ^① | Operation (Bottom Button) | Type of Light Element Transformer (60/50 Hertz AC) | | | Full Voltage (60/50 Hertz AC or DC) | | |
|---|---------------------------|--|--------------------------|----------------|-------------------------------------|--------------------------|----------------|
| | | Voltage | Lamp Number ^② | Catalog Number | Voltage | Lamp Number ^② | Catalog Number |
| TYPE G TYPE B | Momentary | 120 | 6PSB | E30DA | 24 | 24PSB | E30DX3 |
| | | 120 | 120PSB | E30DF | | | |

Single Button Operator with Release Bar and Indicating Light



Shown with Button and Lens

Single Button Operator with (OFF) Release Bar and Indicating Light—Includes OFF Bar/Button (Order Other Button and Lens Separately)

| Button and Lens Types Required ^① | Operation (Bottom Button) | Type of Light Element Transformer (60/50 Hertz AC) | | | Full Voltage (60/50 Hertz AC or DC) | | |
|---|---------------------------|--|--------------------------|----------------|-------------------------------------|--------------------------|----------------|
| | | Voltage | Lamp Number ^② | Catalog Number | Voltage | Lamp Number ^② | Catalog Number |
| TYPE G TYPE C | Maintained | 120 | 6PSB | E30DG | 24 | 24PSB | E30DX13 |
| | | 120 | 120PSB | E30DM | | | |

Two Button Operator with Indicating Light



Shown with Button and Lens

Two Button Operator with Indicating Light/without Buttons or Lens (Order Buttons and Lens Separately)

| Button and Lens Types Required ^④ | Button Operation | Type of Light Element Transformer (60/50 Hertz AC) | | | Full Voltage (60/50 Hertz AC or DC) | | |
|---|--------------------------|--|--------------------------|----------------|-------------------------------------|--------------------------|----------------|
| | | Voltage | Lamp Number ^② | Catalog Number | Voltage | Lamp Number ^② | Catalog Number |
| TYPE E TYPE J TYPE E | Momentary | 120 | 6PSB | E30EA | 24 | 24PSB | E30EX3 |
| | | 120 | 120PSB | E30EF | | | |
| TYPE E | Momentary with interlock | 120 | 6PSB | E30EG | 24 | 24PSB | E30EX13 |
| | | 120 | 120PSB | E30EM | | | |

Two Button Operator with Dual Indicating Lights



Shown with Button and Lens

Two Button Operator with Dual Indicating Lights/without Buttons and Lens

| Button and Lens Types Required ^① | Button Operation | Type of Light Element Transformer (60/50 Hertz AC) | | | Full Voltage (60/50 Hertz AC or DC) | | |
|---|------------------|--|--------------------------|----------------|-------------------------------------|--------------------------|----------------|
| | | Voltage | Lamp Number ^② | Catalog Number | Voltage | Lamp Number ^② | Catalog Number |
| TYPE E TYPE K TYPE E | Momentary | 120 | 6PSB | E30JA | 24 | 24PSB | E30JX3 |
| | | 120 | 120PSB | E30JF | | | |

Notes

- ① Order from tables on **Pages V7-T1-200 to V7-T1-204.**
- ② Light units will also accept LED lamps. For LED part numbers, see table on **Page V7-T1-210.**
- ③ Operators are supplied as standard with red extended release bar(s) marked "OFF" as shown in sketch. For other colors or markings, contact your nearest Eaton Distributor or call our Customer Service Center 1-800-356-1243. For replacement of standard red release bar, order **E30KR101.**
- ④ Order from tables on **Pages V7-T1-202 and V7-T1-203.**

Operator Components

Operating Buttons Only

Type A Extended Button



Type A Buttons with Standard Markings ^①

| Button Application | Color | Marking | Extended Button Catalog Number | Short Button Catalog Number | Color | Marking | Extended Button Catalog Number | Short Button Catalog Number |
|---|-------|-------------|--------------------------------|-----------------------------|--------|----------|--------------------------------|-----------------------------|
|  | Black | Blank | E30KA100 | E30KA150 | Green | START | E30KA330 | E30KA380 |
| | | START | — | E30KA180 | Yellow | Blank | E30KA400 | E30KA450 |
| Red | Red | Blank | E30KA200 | E30KA250 | White | Blank | E30KA500 | E30KA550 |
| | | EMERG. STOP | E30KA204 | — | Gray | Blank | E30KA600 | E30KA650 |
| | | OFF | E30KA218 | E30KA268 | Brown | Blank | E30KA700 | E30KA750 |
| | | STOP | E30KA231 | E30KA281 | Orange | Blank | E30KA800 | E30KA950 |
| Green | Blank | E30KA300 | E30KA350 | Blue | Blank | E30KA900 | E30KA950 | |

Type B Extended Button

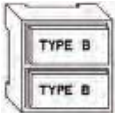

Type B Buttons with Standard Markings ^②

| Button Application | Color | Marking | Extended Button Catalog Number | Short Button Catalog Number | Color | Marking | Extended Button Catalog Number | Short Button Catalog Number | |
|---|----------|----------|--------------------------------|-----------------------------|--------|---------|--------------------------------|-----------------------------|----------|
|  | Black | Blank | E30KB100 | E30KB150 | Black | REVERSE | E30KB125 | E30KB175 | |
| | | AUTO | E30KB101 | E30KB151 | | RUN | E30KB126 | E30KB176 | |
| | | CLOSE | E30KB102 | E30KB152 | | SLOW | E30KB128 | E30KB178 | |
| | | DOWN | E30KB103 | E30KB153 | | START | E30KB130 | E30KB180 | |
| | | FAST | E30KB105 | E30KB155 | | TEST | E30KB132 | E30KB182 | |
| | | FORWARD | E30KB107 | E30KB157 | | UP | E30KB134 | E30KB184 | |
| | | HIGH | E30KB109 | E30KB159 | | Red | Blank | E30KB200 | E30KB250 |
| | | IN | E30KB110 | E30KB160 | | | EMERG. STOP | E30KB204 | — |
| | | INCH | E30KB111 | E30KB161 | | | OFF | E30KB218 | E30KB268 |
| | | JOG | E30KB112 | E30KB162 | STOP | | E30KB231 | E30KB281 | |
| | | JOG FOR. | E30KB113 | E30KB163 | Green | | Blank | E30KB300 | E30KB350 |
| | | JOG REV. | E30KB114 | E30KB164 | | | START | E30KB330 | E30KB380 |
| | | LOW | E30KB115 | E30KB165 | Yellow | Blank | E30KB400 | E30KB450 | |
| | | LOWER | E30KB116 | E30KB166 | | White | Blank | E30KB500 | E30KB550 |
| | | MAN | E30KB117 | E30KB167 | | | AUTO | E30KB501 | — |
| | | ON | E30KB119 | E30KB169 | Gray | Blank | E30KB600 | E30KB650 | |
| | | OPEN | E30KB120 | E30KB170 | | Brown | Blank | E30KB700 | E30KB750 |
| | | OUT | E30KB121 | E30KB171 | Orange | | Blank | E30KB800 | E30KB850 |
| | | RAISE | E30KB122 | E30KB172 | | | Blue | Blank | E30KB900 |
| RESET | E30KB124 | E30KB174 | | | | | | | |

Notes

- ① Use with operator E30AA, legend characters 3/16 in (4.8 mm) high.
- ② Use with operators E30AB thru AE, AL and DA thru DF, legend characters 3/16 in (4.8 mm) high.

Type C Extended Button



Type C Buttons with Standard Markings ①

| Button Application | Color | Marking | Extended Button Catalog Number | Short Button Catalog Number | Color | Marking | Extended Button Catalog Number | Short Button Catalog Number | |
|--------------------|----------|----------|--------------------------------|-----------------------------|----------|---------|--------------------------------|-----------------------------|----------|
| | Black | Blank | E30KC100 | E30KC150 | Black | RESET | E30KC124 | E30KC174 | |
| | | AUTO | E30KC101 | E30KC151 | | REVERSE | E30KC125 | E30KC175 | |
| | | CLOSE | E30KC102 | E30KC152 | | RUN | E30KC126 | E30KC176 | |
| | | DOWN | E30KC103 | E30KC153 | | SLOW | E30KC128 | E30KC178 | |
| | | FAST | E30KC105 | E30KC155 | | START | E30KC130 | E30KC180 | |
| | | FORWARD | E30KC107 | E30KC157 | | TEST | E30KC132 | E30KC182 | |
| | | HAND | E30KC108 | E30KC158 | | UP | E30KC134 | E30KC184 | |
| | | HIGH | E30KC109 | E30KC159 | | Red | Blank | E30KC200 | E30KC250 |
| | | IN | E30KC110 | E30KC160 | | | OFF | E30KC218 | — |
| | | INCH | E30KC111 | E30KC161 | | | STOP | E30KC231 | E30KC281 |
| | | JOG | E30KC112 | E30KC162 | | Green | Blank | E30KC300 | E30KC350 |
| | | JOG FOR. | E30KC113 | E30KC163 | | | START | E30KC330 | E30KC380 |
| | | JOG REV. | E30KC114 | E30KC164 | | Yellow | Blank | E30KC400 | E30KC450 |
| | | LOW | E30KC115 | E30KC165 | | | White | Blank | E30KC500 |
| | | LOWER | E30KC116 | E30KC166 | | Gray | Blank | E30KC600 | E30KC650 |
| | | MAN | E30KC117 | E30KC167 | | | Brown | Blank | E30KC700 |
| | | ON | E30KC119 | E30KC169 | | Orange | Blank | E30KC800 | E30KC850 |
| OPEN | E30KC120 | E30KC170 | Blue | Blank | E30KC900 | | E30KC950 | | |
| OUT | E30KC121 | E30KC171 | | | | | | | |
| RAISE | E30KC122 | E30KC172 | | | | | | | |

Note

① Use with operators E30AF thru AK, AL thru AM and DG thru DM, legend characters 1/8 in (3.2 mm) high.

Operating Buttons and Lens Only

Standard Color Buttons and Lens Marking ①

Black lettering on — White, Amber, Yellow and Clear.

White lettering on — Green, Red, Blue, Brown, Black, Orange and Gray.

Type E Button

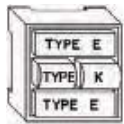

Type E Buttons with Standard Markings ②

| Button Application | Color | Marking | Extended Button Catalog Number | Color | Marking | Extended Button Catalog Number |
|---|-----------------|----------|--------------------------------|-----------------|-----------------|--------------------------------|
|  | Black | Blank | E30KE100 | Black | RESET | E30KE124 |
| | | CLOSE | E30KE102 | REVERSE | E30KE125 | |
| | | DOWN | E30KE103 | RUN | E30KE126 | |
| | | FAST | E30KE105 | SLOW | E30KE128 | |
| | | FORWARD | E30KE107 | START | E30KE130 | |
| | | HIGH | E30KE109 | TEST | E30KE132 | |
| | | IN | E30KE110 | UP | E30KE134 | |
| | | INCH | E30KE111 | Red | Blank | E30KE200 |
| | | JOG | E30KE112 | | OFF | E30KE218 |
| | | JOG FOR. | E30KE113 | | STOP | E30KE231 |
| | | JOG REV. | E30KE114 | Green | Blank | E30KE300 |
| | | LOW | E30KE115 | | START | E30KE330 |
| | | LOWER | E30KE116 | Yellow | Blank | E30KE400 |
| | | ON | E30KE119 | White | Blank | E30KE500 |
| | | OPEN | E30KE120 | Gray | Blank | E30KE600 |
| OUT | E30KE121 | Brown | Blank | E30KE700 | | |
| PHASE | E30KE122 | Orange | Blank | E30KE800 | | |
| | | Blue | Blank | E30KE900 | | |

Type F Lens



Type F Lenses with Standard Markings ③

| Button Application | Color | Marking | Catalog Number | Color | Marking | Catalog Number |
|---|-------|------------|----------------|-------|---------|----------------|
|  | Red | Blank | E30KF10 | Green | OFF | E30KF22 |
| | | MOTOR RUN | E30KF11 | Amber | Blank | E30KF30 |
| | | ON | E30KF12 | Blue | Blank | E30KF40 |
| | | POWER ON | E30KF13 | Clear | Blank | E30KF50 |
| Green | Blank | | E30KF20 | White | Blank | E30KF60 |
| | | MOTOR STOP | E30KF21 | | | |
| | | MOTOR RUN | E30KF23 | | | |

Notes

① For lenses with special markings or with standard markings but in a different color, refer to instructions on **Pages V7-T1-207 to V7-T1-209**.

② Use with operators E30EA thru EM, FA thru FM and JA thru JM, legend characters 1/8 in (3.2 mm) high.

③ Use with operators E30BA thru BY, legend characters 3/16 in (4.8 mm) high.

Operating Lens Only

Standard Color Buttons and Lens Marking ①

Black lettering on — White, Amber, Yellow and Clear.

White lettering on — Green, Red, Blue, Brown, Black, Orange and Gray.

Type G Lens



Type G Lenses with Standard Markings ②

| Lens Application | Color | Marking | Catalog Number | Color | Marking | Catalog Number |
|------------------|------------|----------------|----------------|-------|----------------|----------------|
| | | | | | | |
| | Red | Blank | E30KG10 | Green | OFF | E30KG22 |
| | | MOTOR RUN | E30KG11 | | READY | E30KG23 |
| | | ON | E30KG12 | Amber | Blank | E30KG30 |
| | | POWER ON | E30KG13 | | Blue | Blank |
| Green | Blank | E30KG20 | Clear | Blank | E30KG50 | |
| | MOTOR RUN | E30KG24 | White | Blank | E30KG60 | |
| | MOTOR STOP | E30KG21 | | | | |

Type J Lens



Type J Lenses with Standard Markings ③

| Lens Application | Color | Marking | Catalog Number | Color | Marking | Catalog Number |
|------------------|------------|----------------|----------------|-------|----------------|----------------|
| | | | | | | |
| | Red | Blank | E30KJ10 | Green | OFF | E30KJ22 |
| | | MOTOR RUN | E30KJ11 | | ON | E30KJ24 |
| | | ON | E30KJ12 | Amber | Blank | E30KJ30 |
| | | POWER ON | E30KJ13 | | | |
| | | MOTOR STOP | E30KJ14 | Clear | Blank | E30KJ50 |
| Green | Blank | E30KJ20 | White | Blank | E30KJ60 | |
| | MOTOR STOP | E30KJ21 | | | | |
| | MOTOR RUN | E30KJ23 | | | | |

Type K Lenses



Type K Lenses with Standard Markings (Sold in Pairs Only) ④

| Lens Application | Color | | Marking | | Catalog Number |
|------------------|----------------|-----------------|----------------|-----------------|----------------|
| | Left Hand Lens | Right Hand Lens | Left Hand Lens | Right Hand Lens | |
| | Red | Red | ON | ON | E30KK12 |
| | | Green | ON | OFF | E30KK13 |
| | Green | | OFF | OFF | E30KK22 |
| | | Red | OFF | ON | E30KK23 |

Notes

- ① For lenses with special markings or with standard markings but in a different color, refer to instructions on **Pages V7-T1-207 to V7-T1-209**.
- ② Use with operators E30CA thru CM and DA thru DM, legend characters 3/16 in (4.8 mm) high except MOTOR RUN, POWER ON and MOTOR STOP are 1/8 in (3.2 mm) high.
- ③ Use with operators E30EA thru EM, FA thru FM and GA thru GM, legend characters 1/8 in (3.2 mm) high.
- ④ Use with operators E30JA thru JW, legend characters 1/8 in (3.2 mm) high

1

Type K Lenses



Type K Lenses—Blank (Sold in Pairs Only)

| Color | | | Color | | |
|----------------|-----------------|----------------|----------------|-----------------|----------------|
| Left Hand Lens | Right Hand Lens | Catalog Number | Left Hand Lens | Right Hand Lens | Catalog Number |
| Red | Red | E30KK10 | Blue | Red | E30KK41 |
| | Green | E30KK11 | | Green | E30KK42 |
| | Amber | E30KK17 | | Amber | E30KK43 |
| | Blue | E30KK14 | | Blue | E30KK40 |
| | Clear | E30KK15 | | Clear | E30KK45 |
| | White | E30KK16 | | White | E30KK46 |
| Green | Red | E30KK21 | Clear | Red | E30KK51 |
| | Green | E30KK20 | | Green | E30KK52 |
| | Amber | E30KK27 | | Amber | E30KK53 |
| | Blue | E30KK24 | | Blue | E30KK54 |
| | Clear | E30KK25 | | Clear | E30KK50 |
| | White | E30KK26 | | White | E30KK56 |
| Amber | Red | E30KK31 | White | Red | E30KK61 |
| | Green | E30KK32 | | Green | E30KK62 |
| | Amber | E30KK30 | | Amber | E30KK63 |
| | Blue | E30KK34 | | Blue | E30KK64 |
| | Clear | E30KK35 | | Clear | E30KK65 |
| | White | E30KK36 | | White | E30KK60 |

Contact Blocks

Standard Contact Blocks—Molded, phenolic construction. Enclosed silver contacts with reliability “nibs” that improve the reliability of switching performance under dry circuit, corrosive atmosphere and fine dust conditions. For more extreme conditions, the logic level contact blocks described below are recommended.

Logic Level Contact Blocks—Feature palladium contacts. Palladium, which is more inert than gold, is well suited for voltages and currents approaching zero. When mounted in an enclosure rated for highly corrosive environments, logic level contact blocks can be used where exposure to chemicals may cause failure to other types of materials.

Mounting Limitations

See the contact block mounting limitations for Type E30 pushbutton and combination pushbutton and light operators on this page. Mounting positions 1 thru 8 indicate single depth contact blocks. Each of these positions can represent either a single circuit 600 volt block or a two-circuit 120 volt block. The two-circuit 600 volt block requires two of the numbered positions shown.

Mounting Positions

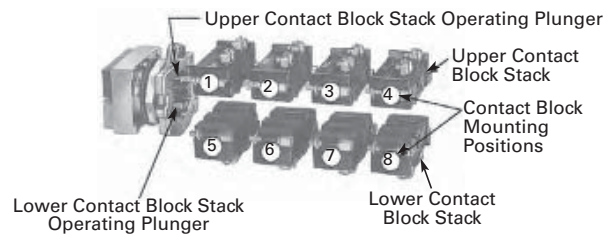

| Catalog Number of Operator | Contact Blocks Can Be Mounted in Positions Listed Below | |
|-------------------------------|---|-------------|
| | Upper Stack | Lower Stack |
| E30AA thru E30AM ^① | 1-2-3-4 | 5-6-7-8 |
| E30BA thru E30CM | None | None |
| E30DA thru E30DM | None | 5-6-7-8 |
| E30EA thru E30GM | 2-3-4 | 6-7-8 |
| E30JA thru E30JM | 3-4 | 7-8 |

Contact Block Selection

Single Circuit, Screw Terminals



Two Circuit, Screw Terminals



Two Circuit, Quick Connect Terminals



120 Vac Only—Two Circuit













| Circuit | Pressure Terminals Standard Catalog Number | Logic Level Catalog Number | Quick Connect Terminals ^③ Standard Catalog Number |
|----------------------------------|--|-------------------------------|--|
| | | | |
| 1NO | E30KLA1 | E30KLAE1 | E30KLB1 |
| 1NC | E30KLA2 | E30KLAE2 | E30KLB2 |
| 1NO-1NC | 600 Vac, 250 Vdc—Two Circuit | | |
| 2NO | E30KLA3 | E30KLAE3 | E30KLB3 |
| 2NC | E30KLA4 | E30KLAE4 | E30KLB4 |
| 2NO-2NC | E30KLA5 | E30KLAE5 | E30KLB5 |
| Special Contact Operation | | | |
| 1NO-1NC Overlapping | E30KLA6 ^④ | — | E30KLB6 ^④ |
| 2NO (One early closing) | E30KLA7 ^④ | — | E30KLB7 ^④ |
| 2NC (One late opening) | E30KLA8 | — | E30KLB8 |
| 1NO-1NC | 120 Vac Only—Two Circuit | | |
| 1NO-1NC | E30KLA9 ^⑤ | — | E30KLB9 ^⑤ |

Notes

- ① Except operator E30AD, AJ or AK which will accommodate contact blocks 1, 2, 5 and 6 only. (See Mounting Positions above.)
- ② Individually boxed contact blocks master packed 10 per carton.
- ③ Supplied with non-stacking screws. Limited to 2 contact blocks mounted in positions 1 and 5.
- ④ Do not use with maintained operators.
- ⑤ Contacts must be same polarity.

Accessories

Accessories

| | Description | Color/Type | Catalog Number |
|---|--|--|--|
|  <p>E30KR_</p> | <p>Collar—Snap on mounting for assembly in the field. Permits color coding of operator heads. Size: 1-19/32 x 1-19/32 x 9/16 in.</p> | Black | E30KR1 |
| | | Red | E30KR2 |
| | | Green | E30KR3 |
| | | Yellow | E30KR4 |
| | | White | E30KR5 |
| | | Gray | E30KR6 |
| | | Orange | E30KR8 |
| | | Blue | E30KR9 |
| | | Brown | E30KR10 |
| | |  <p>E30KT_</p> <p>Full Shroud</p> <p>Half Shroud</p> | <p>Shroud—Similar to collar above except for extension above the face of button to prevent accidental actuation of button. Half shroud with an extension on only half the collar may be positioned to protect top or bottom button.</p> |
| Half shroud (gray) | E30KT7 | | |
|  <p>E30KR3_</p> | <p>Guard—Two collars deep, removable slide prevents accidental operation. White slide can be marked with grease pencil.</p> | Red with white slide | E30KR31 |
| | | Red with clear slide | E30KR32 |
|  <p>E30KR30</p> | <p>Terminal Block—2 terminals, each will accommodate 2-wire terminations.</p> | | E30KR30 |
|  <p>E30KT_</p> | <p>Padlock Attachment for locking single button and bottom button of multi-function operators in the depressed position. Locks NC contacts open or early closing NO contacts closed. Cannot be used in conjunction with collar, shroud or boot.</p> | Short button | E30KT1 |
| | | Extended button | E30KT2 |
|  <p>E30KT3</p> | <p>Transparent Boot—Guards against ingress of foreign material and freezing rain. Note: If this boot is used in conjunction with operator types AD or AE, an extended type button must be used in the top position and a short button in the lower position.</p> | | E30KT3 ① |
|  <p>E30KT_</p> | <p>Square Hole Plug—</p> | Gray enameled | E30KT4 |
| | | Stainless steel | E30KT5 |
|  <p>E30KV1</p> | <p>Lamp and Lens Removal Tool—Will not fit Cat. No. E30B light units listed on Page V7-T1-198.</p> | | E30KV1 |
|  <p>E22CW</p> | <p>Octagonal Wrench for mounting operators to panel.</p> | | E22CW |
|  <p>E30KV2</p> | <p>Button and Lens Removal Tool</p> | | E30KV2 |

Note

① Color coordinating collars, padlock attachments or legend plates cannot be used with operators equipped with a transparent boot.

Options

Markings and Legend Plates

Buttons or Lenses with Non-Standard Horizontal Markings

Markings not listed as Standard Markings below are considered non-standard. If more than one marking is required on a button or lens, order non-standard markings.

Ordering Instructions

- Specify catalog number of blank button or lens of desired color, plus suffix "STAMP" for non-standard or "STD" for standard markings in order notes. See **Pages V7-T1-200 to V7-T1-204**.
- Specify size, legend desired and location in order notes by alphas as shown in example.
- Do not exceed maximum number of legend characters per line.

Ordering Example

Green Type B button to be marked with non-standard legend "ALL ELEVATORS DOWN."

Catalog No.: **E30KB300STAMP**
 Letter Size: 1/8 in
 Pos. A—ALL
 Pos. C—ELEVATORS
 Pos. F—DOWN

How to Use the Legend Location Figure

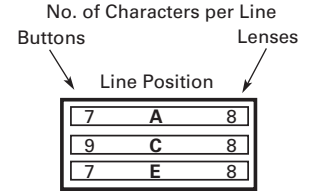

Legend Locations

Type A buttons and Type F lenses

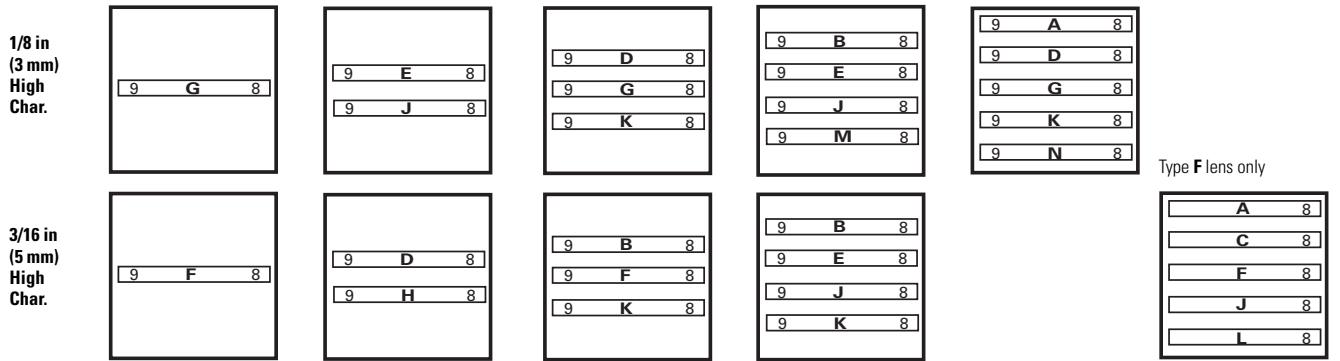

Type B buttons and Type G lenses

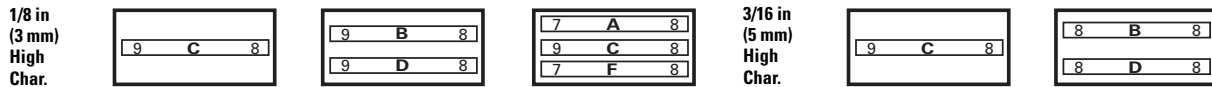

Type C buttons



Type D buttons

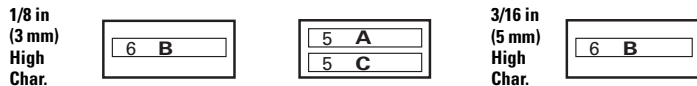

Type K buttons

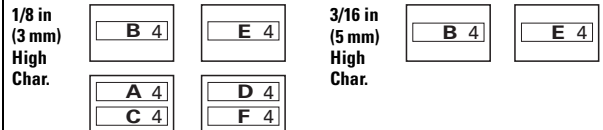

Type E buttons and Type J lenses

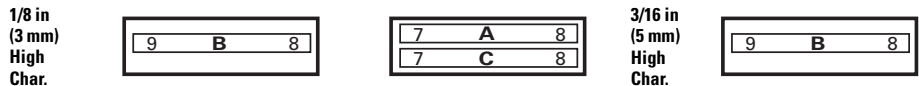

Standard Markings

| | | | | | | | | | | |
|-------|-------------|------|----------|----------|------|-------|---------|-------|-----------|------------|
| AUTO | EMERG. STOP | HAND | INCH | JOG REV. | MAN. | OPEN | RESET | SLOW | TEST | MOTOR STOP |
| CLOSE | FAST | HIGH | JOG | LOW | OFF | OUT | REVERSE | START | UP | POWER ON |
| DOWN | FORWARD | IN | JOG FOR. | LOWER | ON | RAISE | RUN | STOP | MOTOR RUN | READY |

1

Legend Arrangements and Legend Locations

Legend plates
E30KM1 or KM11

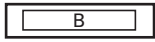

Legend plates
E30KM4 or KM14

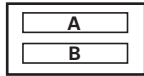

Legend plates
E30KM3 or KM13

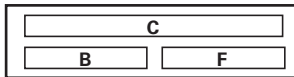
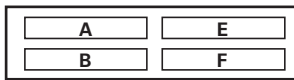
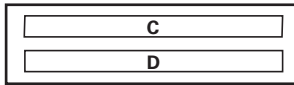

Legend plates
E30KM5 or KM15

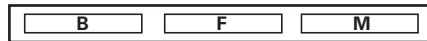
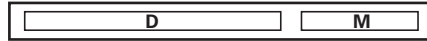
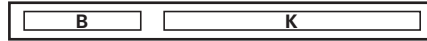
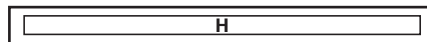

Legend plates
E30KM2 or KM12

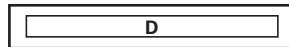

Legend plates
E30KM6 or KM16

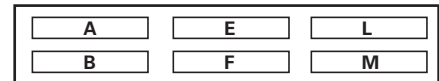
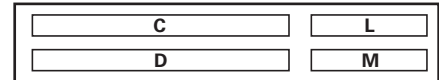
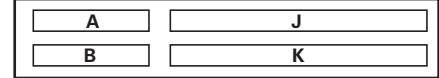
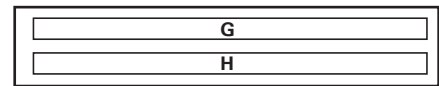

Legend Plates E30KN76 or KN76B

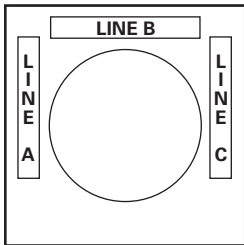

Legend plates
E30KN76 or KN76B
1/8 in character
size only with a maximum
of six characters.

Maximum Number and Size of Permissible Legend Characters of Custom Stamped Legend Plates

| Type | No. of Lines | Size and Maximum Number of Characters Per Line | | | | | | | | |
|----------|--------------|--|---------------|----------------|------------------|---------------|----------------|------------------|---------------|----------------|
| | | One Span | | | Two Span | | | Three Span | | |
| | | 3/32 in (2.5 mm) | 1/8 in (3 mm) | 3/16 in (5 mm) | 3/32 in (2.5 mm) | 1/8 in (3 mm) | 3/16 in (5 mm) | 3/32 in (2.5 mm) | 1/8 in (3 mm) | 3/16 in (5 mm) |
| Standard | 1 | 13 | 10 | 10 | 30 | 22 | 22 | 47 | 34 | 34 |
| Large | 1 | 13 | 10 | 10 | 30 | 23 | 23 | 47 | 36 | 36 |
| | 2 | 13 | 10 | 10 | 30 | 23 | 23 | 47 | 36 | 36 |

Characters available for non-standard markings
3/32 in (2.5 mm)—1/8 in (3 mm)—3/16 in (5 mm)

A B C D E F G H I J K L M N O P Q R S T U V W X Y Z

. / — ,

1 2 3 4 5 6 7 8 9 0

Buttons or Lenses with Non-Standard Vertical Markings

Ordering Instructions

- Specify catalog number of blank button or lens of desired color, selected from listings on **Pages V7-T1-200 to V7-T1-204**.
- Specify size, legend desired, location and state “vertically marked” in order notes.

Note: Specify either 1/8 or 3/16 in (3.2 or 4.8 mm) character height. Do not exceed maximum number of characters as outlined in table below.

Ordering Example:

Green Type K button to be marked with “RUN” “ON.”

Catalog No.: **E30KK20STAMP**
 Letter Size: 3/16 in (4.8 mm)
 Vertically Marked
 Pos. B—RUN
 Pos. E—ON

Legend Plates

Legend plates for Type E30 compact pushbutton and indicating light operators hook directly onto the operator and are clamped in place when the operator locking nut behind the panel is secured.

Two and three span plates are designed for use where two or more operators are mounted adjacent to each other **on minimum horizontal mounting centers**. These legend plates mount in the same manner as single span units.

When Ordering Legend Plates with Markings

- Catalog number of blank legend plate
- Insert the following in order notes:
 - Legends required
 - Size of characters—3/32, 1/8, 3/16 in (2.4, 3.2, 4.8 mm)
 - Positions of legends on one line standard and two line large legend plates by alphas as shown in sketches on following page.

Ordering Example:



Three span legend plate to be marked “MASTER CONTROL”, “STATION A” and “STATION B.”

Catalog No.: **E30KM3STAMP**
 Letter Size: 1/8 in (3.2 mm)
 Pos. C—MASTER CONTROL
 Pos. B—STATION A
 Pos. F—STATION B

Maximum Number of Characters

| Description | Type | Maximum Number of Characters | |
|-------------|------|------------------------------|------------------|
| | | 1/8 in (3.2 mm) | 3/16 in (4.8 mm) |
| Buttons | A | 7 | 5 |
| | B | 7 | 5 |
| | C | 4 | 3 |
| | D | 5 | 3 |
| | E | 7 | 5 |
| Lenses | F | 7 | 5 |
| | G | 7 | 5 |
| | J | 7 | 5 |
| | K | 3 | 2 |

Blank Legend Plates and Legend Plates with Markings

| Type | | One Span Catalog Number |
|---|----------|-------------------------|
| Black | | |
| Standard—One Span | Standard | E30KM1 |
|  | | |
| Large—One Span | Large | E30KM4 |
|  | | |

Replacement Parts

Replacement Light Units for E30 Components

| Voltage AC and DC | Part Numbers—Receptacles without Lamps | | | | |
|---|--|--------------------------|-----------------------------------|---------------------------------|-------------------------------|
| | Single Indicating Light | Dual Indicating Light | Single Light Single Pushbutton | Single Light Dual Pushbutton | Dual Light Dual Pushbutton |
| Full Voltage Type | | | | | |
| 6V | 57-2579-3A | 57-2568A | 57-2568A | 57-2579-3A | 57-2567 |
| 12V | 57-2579-3A | 57-2568A | 57-2568A | 57-2579-3A | 57-2567 |
| 18/24V | 57-2579-3A | 57-2568A | 57-2568A | 57-2579-3A | 57-2567 |
| 28V | 57-2579-3A | 57-2568A | 57-2568A | 57-2579-3A | 57-2567 |
| 32V | 57-2579-3A | 57-2568-2A | 57-2568-2A | — | 57-2567 |
| 48V | 57-2579-3A | 57-2568A | 57-2568A | 57-2579-3A | 57-2567 |
| 120V | 57-2579-3A | 57-2568A | 57-2568A | 57-2579-3A | 57-2567 |
| Transformer Type | | | | | |
| 120V | 42-2672A | 42-2663A | 42-2663A | 42-2671A | 42-2664A |
| 208V | 42-2672-2A | 42-2663-2A | 42-2663-2A | 42-2671-2A | 42-2664-2A |
| 240V | 42-2672-3A | 42-2663-3A | 42-2663-3A | 42-2671-3A | 42-2664-3A |
| 380V | 42-2672-4A | 42-2663-4A | 42-2663-4A | 42-2671-4A | 42-2664-4A |
| 480V | 42-2672-5A | 42-2663-5A | 42-2663-5A | 42-2671-5A | 42-2664-5A |
| 600V | 42-2672-6A | 42-2663-6A | 42-2663-6A | 42-2671-6A | 42-2664-6A |
| Description and Part Numbers—Related Parts | | | | | |
| Inner lens | 28-1008 | 28-1010 | 28-1010 | 28-1010 | 28-1010 |
| Retaining nut | 15-1885 | 15-1885 | 15-1885 | 15-1885 | 15-1885 |
| Gasket | 16-2092 | 16-2092 | 16-2092 | 16-2092 | 16-2092 |
| Locking ring | 52-1116 | 52-1116 | 52-1116 | 52-1116 | 52-1116 |

Replacement Lamps for E30 Illuminated Operators

| Mfg. Lamp Type | Voltage | Base Style | Application | Part Number |
|----------------|---------|--------------|----------------------------------|-------------|
| 6PSB | 6V | T2 slide | E30 transformer and full voltage | 28-1022 |
| 12PSB | 12V | T2 slide | E30 full voltage | 28-1025 |
| 24PSB | 24V | T2 slide | E30 full voltage | 28-1026 |
| 28PSB | 28V | T2 slide | E30 full voltage | 28-1027 |
| 48PSB | 48V | T2 slide | E30 full voltage | 28-1028 |
| 60PSB | 60V | T2 slide | E30 full voltage | 28-1598 |
| 120PSB | 120V | T2 slide | E30 full voltage | 28-1029 |
| #259 | 6.3V | T3-1/4 wedge | E30 single transformer | 28-949 |

Replacement Lamps—Incandescent and LED

| Lamp Voltage | Incandescent Lamps | | | LED Lamps | | | |
|-----------------|-------------------------------|---------------|------------------------|---------------------|------------|------------|------------|
| | Manufacturer's Part Number | Base Style | Eaton's Part Number | Eaton's Part Number | | | |
| | | | | Red | Green | Yellow | Blue ① |
| 6 | 6PSB | T2 slide | 28-1022 | 35-1523 | 35-1523-2 | 35-1523-3 | 35-1523-17 |
| 12 | 12PSB | T2 slide | 28-1025 | 35-1523-11 | 35-1523-12 | 35-1523-13 | 35-1523-18 |
| 24 | 24PSB | T2 slide | 28-1026 | 35-1523-4 | 35-1523-5 | 35-1523-6 | 35-1523-19 |
| 28 | 28PSB | T2 slide | 28-1027 | 35-1523-4 | 35-1523-5 | 35-1523-6 | 35-1523-19 |
| 48 | 48PSB | T2 slide | 28-1028 | 35-1523-14 | 35-1523-15 | 35-1523-16 | 35-1523-20 |
| 120 | 120PSB | T2 slide | 28-1029 | 35-1523-7 | 35-1523-8 | 35-1523-9 | 35-1523-21 |

Note

① E30 blue LED bulbs may not provide sufficient intensity for some applications.

Technical Data and Specifications

Operator Specifications

| Description | Specification |
|---------------------------|--|
| Climate Conditions | |
| Operating | −20° to 150°F (−29° to 65°C) |
| Terminals | |
| Light units | Terminals are saddle clamp type for 2 stranded or solid wires up to 12 AWG (4.0 mm ²) Torque—7 lb-in (0.8 Nm) |
| Contact block | Terminals are saddle clamp type for 2 stranded or solid wires up to 12 AWG (4.0 mm ²) Torque—7 lb-in (0.8 Nm) |
| Materials | |
| Operator | Zinc base die casting with a copper-nickel-chrome plated finish Withstands the 200 hr. salt spray test in accordance with MIL Spec. QQ-M-151A and NEMA 4X testing. |
| Internal parts | Including shafts, washers and springs, are made of stainless steel |
| Buttons and lenses | Colorfast, wear resistant, molded acetal resin |
| Contact blocks | Made of molded, heat resistant, mineral filled phenolic Contact block plungers are molded of nylon filled phenolic Contacts are silver |
| Reliability nibs | These nibs combine a scrubbing action with high pressure density when the contacts are closed They push through particles and films found on contact surfaces in industrial environments Reliability nibs self-adjust to the application—dry circuit, normal or heavy-duty |

Reliability Nibs



Electrical Ratings

Contact Blocks

Meet or Exceed NEMA Contact Rating Designation A600 and P300

| Description | Vac A600 | | | | Vdc P300 | | |
|---|----------|------|------|------|----------|------|------|
| | 120V | 240V | 480V | 600V | 24/28V | 125V | 250V |
| Make and emergency interrupting capacity (Amps) | 60 | 30 | 15 | 12 | 5.73 | 1.1 | 0.55 |
| Normal load break (Amps) | 6 | 3 | 1.5 | 1.2 | 5.73 | 1.1 | 0.55 |
| Continuous current (Amps) | 10 | 10 | 10 | 10 | 5 | 5 | 5 |

- UL A600/P300 nominal connect 10A
- 1NO, 1NC, 2NO, 2NC, 1NO-1NC, early make, late break and overlapping configurations
- Mechanical positive drive operation on NC contacts
- Palladium alloy contact for logic level or highly corrosive environments

Maximum Ratings for Logic Level and Hostile Atmosphere Application

| Description | Specification |
|-----------------|---------------|
| Maximum amperes | 0.5A ① |
| Maximum volts | 120 Vac/Vdc |

Note

① Logic level contact blocks are UL A600/P500 rated per table above.

Light Unit

| Description | Specification |
|------------------------------|----------------------------------|
| Bulbs—Average Life | |
| Transformer type | 20,000 hrs. |
| Resistor/direct voltage type | 2,500 hrs. min. at rated voltage |
| LED | 60,000 to 100,000 hrs. |

30.5 mm Heavy-Duty Watertight/Oiltight—10250T



Contents

| <i>Description</i> | <i>Page</i> |
|---|-------------|
| 30.5 mm Heavy-Duty Watertight/Oiltight—10250T | |
| Product Overview | V7-T1-214 |
| Product Identification | V7-T1-214 |
| Catalog Number Selection | V7-T1-215 |
| Product Selection | |
| Point-of-Purchase Packaging | V7-T1-217 |
| Non-Illuminated Momentary Pushbutton Units | V7-T1-218 |
| Pushbuttons | V7-T1-219 |
| Illuminated Momentary Pushbutton Units | V7-T1-222 |
| Indicating Light Units | V7-T1-223 |
| Illuminated Pushbuttons and Indicating Lights | V7-T1-224 |
| Push-Pull Emergency Stop | V7-T1-226 |
| Illuminated Push-Pull Units | V7-T1-229 |
| Potentiometers | V7-T1-232 |
| Push-Pull Operators | V7-T1-233 |
| Selector Switch Units | V7-T1-237 |
| Selector Switch Selection | V7-T1-238 |
| Selector Switch Operators | V7-T1-241 |
| Illuminated Selector Switch Operators | V7-T1-244 |
| Joystick Units | V7-T1-245 |
| Joysticks | V7-T1-246 |
| Roto-Push Units | V7-T1-249 |
| Roto-Push Operators | V7-T1-250 |
| Accessories | V7-T1-255 |
| Options | V7-T1-260 |
| Replacement Parts | V7-T1-269 |
| Technical Data and Specifications | V7-T1-271 |
| Dimensions | V7-T1-274 |



Application Description

Contact Operation

Slow make and break. All normally closed contacts have positive opening operation, i.e., normally closed contacts are forced open in the event of contact weld or spring breakage.

Standards and Certifications

- CE EN 60947-5-1 and 60947-5-5
- UL 508—File No. 131568
- CSA C22.2 No. 14—File No. LR68551



Ingress Protection

When mounted in similarly rated enclosure—

- Standard indicating lights
 - UL (NEMA) Type 1, 2, 3, 3R, 3S, 4, 4X, 12, 13
 - IEC IP65
- Most other operators
 - UL (NEMA) Type 1, 2, 3, 3R, 4, 4X, 12, 13
 - IEC IP65

Product Description

The 30.5 mm pushbutton line features a zinc die cast construction with chrome-plated housing and mounting nut. The same durable construction is also available with the corrosive resistant E34 line of pushbuttons. See E34 section on **Pages V7-T1-284 to V7-T1-325**.

Features

- Heavy-duty zinc die cast construction
- Enclosed silver contacts with reliability nibs
- Diaphragm seals with drainage holes
- Grounding nibs on the operator casing

Benefits

- Reliability nibs improve contact reliability even under dry circuit and fine dust conditions
- Drainage holes prevent buildup of liquid inside the operator which can prevent operation in freezing environments
- Grounding nibs bit through paint and other coatings to provide secure ground

1

Product Overview

Reliability Nibs

Eaton's contact blocks feature enclosed silver contacts with pointed "reliability nibs" for reliable performance from logic level up to 600V. To ensure reliable switching, nibs bite through oxide which can form on silver contacts, eliminating the need for expensive logic level blocks for most applications.

Reliability Nibs



Dry Circuit

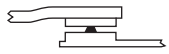

Medium Duty

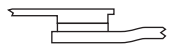

Heavy-Duty

Reliability nibs improve performance in dry circuit, corrosive, fine dust and other contaminated atmospheres. Under normal environmental conditions, the minimum operational voltage is 5V and the minimum operational current is 1 mA, AC/DC. For operation under a wider range of environmental conditions, logic level contact blocks with inert palladium tipped contacts are recommended.

Grounding Nibs

10250T line operators have "grounding nibs"—four metal points on the operator casting designed to bite through most paints and other coatings on metal panels to enhance the ground connection when the operator is securely tightened.

Grounding Nibs

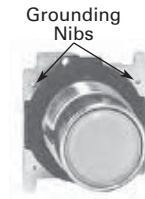

Diaphragm Seal with Drainage Holes

Liquid Drainage

Eaton's pushbutton operators offer front of panel drainage via holes in the operator bushing. Hidden from view by the mounting nut, these holes prevent buildup of liquid inside the operator, which can prevent operation in freezing environments. The holes also provide a route for escaping liquid in high pressure washdowns, effectively relieving pressure from the internal diaphragm seal, ensuring reliable sealing in applications even beyond NEMA 4.

Diaphragm Seal

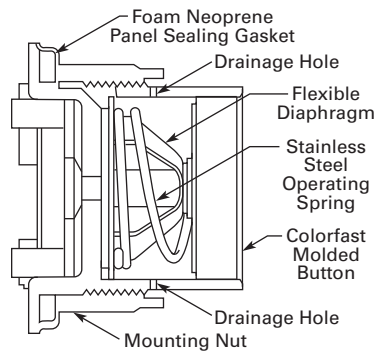

Product Identification

30.5 mm Heavy-Duty Watertight/Oiltight—10250T Series

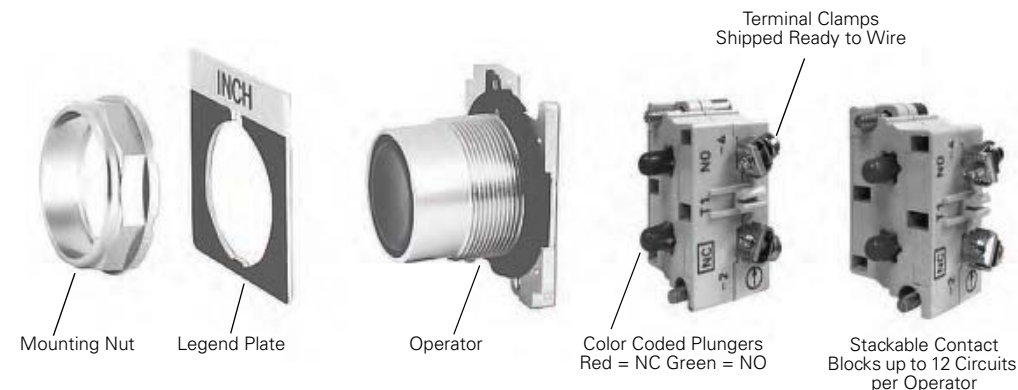

Catalog Number Selection

Catalog Number Selection is for illustrative purposes only and not to be used to create new catalog numbers.

Non-Illuminated Pushbuttons

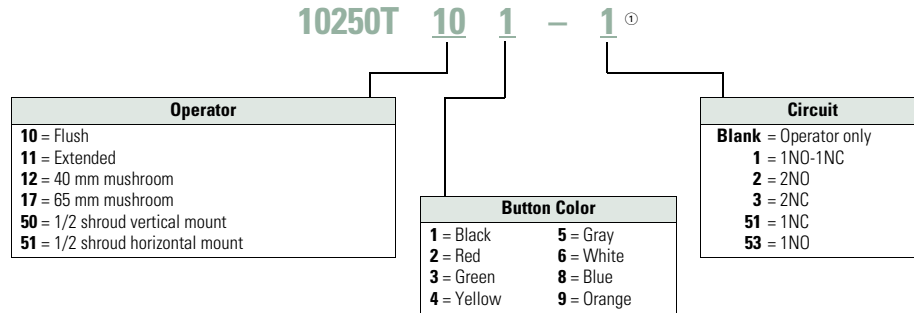

Illuminated and Non-Illuminated Push-Pulls

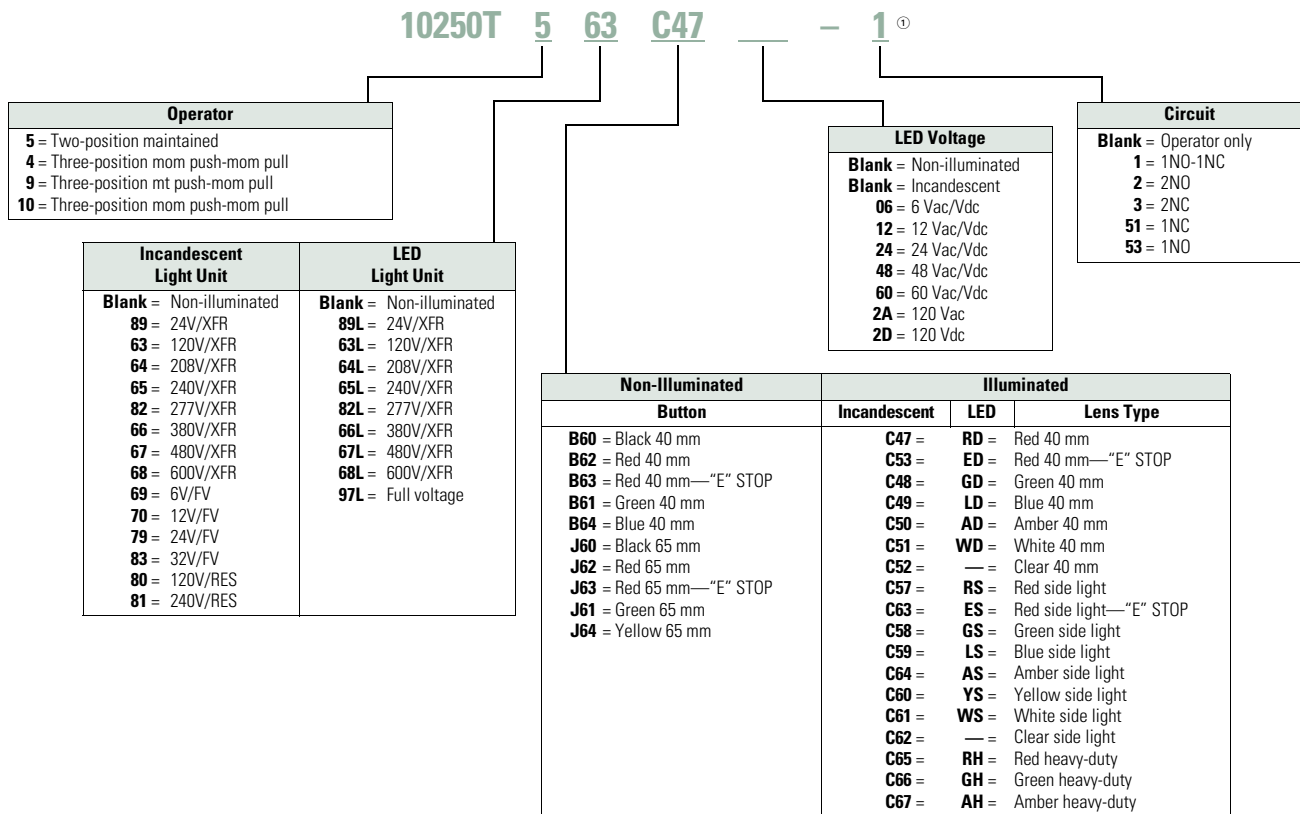

Note

① Add **X** at end of catalog number to receive parts assembled from factory.

Product Selection

Point-of-Purchase Packaging

**Point-of-Purchase
Packaged Pilot Device**



10250T Point-of-Purchase Packaged Pilot Devices

| Product | Description | Catalog Number |
|---|---|---------------------------|
| Emergency Stop Operators | | |
| Red non-illuminated push-pull | 1NO-1NC contact block. Also includes two square engraved legend plates: EMERG. STOP and STOP. | 10250T5B62-1-POP |
| Red mushroom pushbutton | 1NO-1NC contact block. Also includes two square engraved legend plates: EMERG. STOP and STOP. | 10250T32R-POP |
| Red jumbo mushroom pushbutton | Engraved EMERG. STOP with 1NO-1NC contact block. | 10250T33-POP |
| Momentary Pushbuttons | | |
| Black flush pushbutton | 1NO-1NC contact block. Also includes two square engraved legend plates: START and JOG. | 10250T30B-POP |
| Green flush pushbutton | | 10250T30G-POP |
| Red extended pushbutton | 1NO-1NC contact block. Also includes one square engraved legend plate: STOP. | 10250T31R-POP |
| Indicating Lights | | |
| Red indicating light | Full voltage 24 Vac/Vdc with two extra lenses: Green and amber. Also includes two square engraved legend plates: RUN and JOG. | 10250T206NC1N-POP |
| Red indicating light | Resistor 120 Vac/Vdc with two extra lenses: Green and Amber. Also includes one square engraved legend plate: RUN and JOG. | 10250T34R-POP |
| Illuminated Pushbuttons | | |
| Red illuminating pushbutton | Full voltage 24 Vac/Vdc with 1NO-1NC contact block and two extra lenses: Green and amber. Also includes one square engraved legend plate: POWER ON. | 10250T476C21-1-POP |
| Red illuminating pushbutton | Resistor 120 Vac/Vdc with 1NO-1NC contact block and two extra lenses: Green and amber. Also includes one square engraved legend plate: POWER ON. | 10250T411C21-1-POP |
| Selector Switches | | |
| Black knob two-position selector switch | 1NO-1NC contact block. Also includes three square engraved legend plates: OFF/ON, HAND/AUTO and RUN/JOG. | 10250T20KB-POP |
| Black knob three-position selector switch | 2NO-2NC contact blocks. Also includes 1 square engraved legend plate: HAND/OFF/AUTO. | 10250T22KB-POP |
| Black knob three-position selector switch | 1NO-1NC contact block. Also includes legend plate: HAND/OFF/AUTO | 10250T21KB-POP |

1

Non-Illuminated Momentary Pushbutton Units

UL (NEMA) Type 3, 3R, 4, 4X, 12, 13

Flush Button



Extended Button



Mushroom Button



Jumbo Mushroom



Pushbutton Units—Flush, Extended, Mushroom Head or Jumbo Mushroom Head Operators

| Contact Type | Button Color | Flush Button Catalog Number | Extended Button Catalog Number | Mushroom Button Catalog Number | Jumbo Mushroom ^① Catalog Number |
|--------------|--------------------------|-----------------------------|--------------------------------|--------------------------------|--|
| 1NO | Black | 10250T23B | 10250T25B | 10250T26B | 10250T27B |
| | Red | 10250T23R | 10250T112-53 | 10250T122-53 | 10250T172-53 |
| | Green | 10250T23G | 10250T25G | 10250T26G | 10250T27G |
| | Yellow | 10250T23Y | 10250T25Y | 10250T26Y | 10250T27Y |
| | Red—Engraved EMERG. STOP | — | — | — | 10250T17213-53 |
| 1NC | Black | 10250T101-51 | 10250T111-51 | 10250T121-51 | 10250T171-51 |
| | Red | 10250T102-51 | 10250T25R | 10250T26R | 10250T27R |
| | Green | 10250T103-51 | 10250T113-51 | 10250T123-51 | 10250T173-51 |
| | Yellow | 10250T104-51 | 10250T120-51 | 10250T124-51 | 10250T174-51 |
| | Red—Engraved EMERG. STOP | — | — | — | 10250T29 |
| 1NO-1NC | Black | 10250T30B | 10250T31B | 10250T32B | 10250T33B |
| | Red | 10250T30R | 10250T31R | 10250T32R | 10250T33R |
| | Green | 10250T30G | 10250T31G | 10250T32G | 10250T33G |
| | Yellow | 10250T30Y | 10250T31Y | 10250T32Y | 10250T33Y |
| | Red—Engraved EMERG. STOP | — | — | — | 10250T33 |
| 2NO | Black | 10250T101-2 | 10250T111-2 | 10250T121-2 | 10250T171-2 |
| | Red | 10250T102-2 | 10250T112-2 | 10250T122-2 | 10250T172-2 |
| | Green | 10250T103-2 | 10250T113-2 | 10250T123-2 | 10250T173-2 |
| | Yellow | 10250T104-2 | 10250T120-2 | 10250T124-2 | 10250T174-2 |
| | Red—Engraved EMERG. STOP | — | — | — | 10250T17213-2 |
| 2NC | Black | 10250T101-3 | 10250T111-3 | 10250T121-3 | 10250T171-3 |
| | Red | 10250T102-3 | 10250T112-3 | 10250T122-3 | 10250T172-3 |
| | Green | 10250T103-3 | 10250T113-3 | 10250T123-3 | 10250T173-3 |
| | Yellow | 10250T104-3 | 10250T120-3 | 10250T124-3 | 10250T174-3 |
| | Red—Engraved EMERG. STOP | — | — | — | 10250T17213-3 |







Note

① Anodized aluminum head is not suitable for use in ultraviolet light applications.

Pushbuttons

UL (NEMA) Type 3, 3R, 4, 4X, 12, 13

Momentary Pushbutton Operators, Non-illuminated

| Button | Color | Catalog Number | | |
|--|---|----------------------|----------------------|------------------|
| | | Vertical | Horizontal | |
| 10250T10_  | Flush button ① | Black | 10250T101 | |
| | Red | 10250T102 | | |
| | Green | 10250T103 | | |
| | Yellow | 10250T104 | | |
| | Gray | 10250T105 | | |
| | White | 10250T106 | | |
| | Blue | 10250T108 | | |
| | Orange | 10250T109 | | |
| | 10250T11_  | Extended button | Black | 10250T111 |
| Red | | 10250T112 | | |
| Green | | 10250T113 | | |
| Yellow | | 10250T120 | | |
| White | | 10250T116 | | |
| Blue | | 10250T118 | | |
| Orange | | 10250T119 | | |
| 10250T5_  | | Half shrouded button | Black | 10250T501 |
| | | Red | 10250T502 | 10250T511 |
| | Green | 10250T503 | 10250T512 | |
| | Yellow | 10250T504 | 10250T513 | |
| | Gray | 10250T505 | 10250T514 | |
| | White | 10250T506 | 10250T515 | |
| | Blue | 10250T508 | 10250T516 | |
| | Orange | 10250T509 | 10250T518 | |
| | 10250T12_  | Mushroom button | Black | 10250T121 |
| Red | | 10250T122 | | |
| Green | | 10250T123 | | |
| Yellow | | 10250T124 | | |
| Blue | | 10250T129 | | |
| 10250T17_  | Jumbo mushroom button ② | Black | 10250T171 | |
| | Red | 10250T172 | | |
| | Red (EMERG. STOP) | 10250T17213 | | |
| | Green | 10250T173 | | |
| | Yellow | 10250T174 | | |
| 10250ED1164_  | Low operating force—jumbo mushroom ②③ | Black | 10250ED1164-2 | |
| | Red | 10250ED1164-3 | | |
| | Green | 10250ED1164-4 | | |
| | Yellow | 10250ED1164-5 | | |
| | Clear | 10250ED1164 | | |

Note: To order complete assembled unit using one composite catalog number, add contact block and legend plate suffix to the end of operator catalog number. Example: 10250T101-1TS33



Operator
10250T101

+



Contact Block
10250T1

+

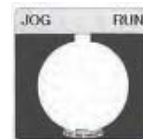

Legend Plate
10250TS33

Notes

- ① To order operator with factory assembled extended retaining nut, **10250TA12**, for thick panel applications, add suffix letter **E** to listed catalog number. Example: 10250T101**E**.
- ② Anodized aluminum head is not suitable for use in ultraviolet light applications.
- ③ Operating force—Standard = 2.4 lb; low force = 1.6 lb.

UL (NEMA) Type 3, 3R, 4, 4X, 12, 13

10250TA_**Mechanically Interlocked Pushbutton Operators**

| Description | Catalog Number |
|---|--------------------|
| Black flush and green flush | 10250TA66 |
| Black flush and long red | 10250TA67 |
| Black flush and red mushroom head | 10250TA68 |
| Black flush and lock-down red mushroom head | 10250TA69 ① |
| Black flush and red jumbo mushroom head | 10250TA76 |
| Green flush and long red | 10250TA72 |
| Black long and long red | 10250TA73 |
| Green flush and red mushroom head | 10250TA77 |
| Green flush and black flush | 10250TA75 |

Lockout Pushbutton Operators with Padlock Attachments

UL (NEMA) Type 3, 3R, 4, 4X, 12, 13

The following pushbutton and mushroom operators include an integral padlock attachment for applications requiring lockout/tagout of specific machine functions. They are available in styles which allow locking of a button in the down position

(stopped position) or locking a button in the up position (to prevent starting). Select the “**Hand**” latch type which functions as a momentary pushbutton until the operator presses the button and moves the padlock attachment into position for

locking, or choose the “**Spring Loaded**” latch type where the padlock attachment springs into place when the button is pressed. Units accept a customer supplied 1/4 in padlock.

10250TA16**Padlockable in the Down Position** ②

| Operator Type | Color | Latch Type | Catalog Number |
|---------------|-------------------|---------------|-------------------|
| Flush head | Red | Hand | 10250TA16 |
| Mushroom head | Red | Hand | 10250TA42 |
| | Red | Spring loaded | 10250TA45 |
| Jumbo head | Red | Hand | 10250TA52 |
| | Red | Spring loaded | 10250TA55 |
| | Red (EMERG. STOP) | Spring loaded | 10250ED952 |

Padlockable in the Up Position ②**10250TA4_**

| Operator Type | Color | Latch Type | Catalog Number |
|---------------|-------|------------|------------------|
| Mushroom head | Black | Hand | 10250TA41 |
| | Green | Hand | 10250TA43 |

10250TA5_

| | | | |
|---------------------|--------|------|------------------|
| Jumbo mushroom head | Black | Hand | 10250TA51 |
| | Green | Hand | 10250TA53 |
| | Yellow | Hand | 10250TA54 |

Notes

Hand attachment must be manually moved into place for locking. Spring loaded: when operator is pressed—attachment springs into place. Must be moved manually to release button.

① NC contacts must be mounted behind lock-down mushroom head operator to ensure lockout.

② Operators can be latched down without a padlock. Padlock not included.

③ Jumbo mushroom heads are not recommended for use in applications where exposure to ultraviolet light exists.

Key Pushbutton Operator

UL (NEMA) Type 3, 3R, 4, 4X, 12, 13

These devices incorporate an integral locking mechanism which enables locking units in various positions (**Locked Down**), locking units to

prevent operation (**Locked Up**) or setting unit to lock when the button is pressed (**Push to Lock**), requiring the key to be inserted to return to

normal operation. With the key in the center position, these operators function as a normal momentary pushbutton (**Free**).

Replacement Keys or Dissimilar Locks for Key Operators Below

Listed operators have identical locks and keys (Key Code H661) Catalog Number 10250ED824. For dissimilar lock and key combinations, see listing on **Page V7-T1-242**.

Replacement Keys

| Description | Catalog Number |
|------------------------------|-------------------|
| Replacement keys (code H661) | 10250ED824 |

10250T43



Key Pushbutton Operator

Key Position and Pushbutton Operations



Key Removal Positions

Vertical Mounting^① Catalog Number

Three-Position

| | | | | |
|---------|------|-----------|---------|------------------|
| Lock up | Free | Lock down | All | 10250T430 |
| Lock up | Free | Lock down | L and R | 10250T431 |
| Lock up | Free | Lock down | C and R | 10250T432 |

Two-Position

| | | | | |
|---------|------|--------------|---------|------------------|
| Lock up | Free | — | L and C | 10250T433 |
| Lock up | Free | — | L | 10250T434 |
| — | Free | Lock down | C and R | 10250T435 |
| — | Free | Lock down | R | 10250T436 |
| — | Free | Push to lock | C and R | 10250T437 |
| — | Free | Push to lock | R | 10250T438 |

Latch-In, Twist-to-Release Operator

UL (NEMA) Type 3, 3R, 4, 4X, 12, 13

10250ED1043-4



Operator Only with Button

| Description | Catalog Number |
|---|----------------------|
| Latch-in, twist-to-release operator with red mushroom head button | 10250ED1043-4 |

Note

① Horizontal mounting available on request.

1

Illuminated Momentary Pushbutton Units

UL (NEMA) Type 3, 3R, 4, 4X, 12, 13

- LED or incandescent
- Full voltage, resistor or transformer type
- Plastic lenses

24V Full Voltage Illuminated Pushbutton



Illuminated Pushbutton Units

| Type | Voltage | Color | LED/Lamp Number | Illuminated Pushbutton | | | | |
|--------------------------|-------------|-------------|-------------------|------------------------|------------------------|--------------------|-------------------|-----------------|
| | | | | 1NO Catalog Number | 1NO-1NC Catalog Number | 1NC Catalog Number | | |
| LED Lamp | | | | | | | | |
| Full voltage | 24 Vac/Vdc | Red | Bayonet base | 10250T397LRD24-53 | 10250T397LRD24-1 | 10250T397LRD24-51 | | |
| | | Green | | 10250T397LGD24-53 | 10250T397LGD24-1 | 10250T397LGD24-51 | | |
| | | Amber | | 10250T397LAD24-53 | 10250T397LAD24-1 | 10250T397LAD24-51 | | |
| | | Yellow | | 10250T397LYD24-53 | 10250T397LYD24-1 | 10250T397LYD24-51 | | |
| | | Blue | | 10250T397LLD24-53 | 10250T397LLD24-1 | 10250T397LLD24-51 | | |
| | | White | | 10250T397LWD24-53 | 10250T397LWD24-1 | 10250T397LWD24-51 | | |
| | | 120 Vac/Vdc | | Red | 10250T397LRD2A-53 | 10250T397LRD2A-1 | 10250T397LRD2A-51 | |
| | | | | Green | 10250T397LGD2A-53 | 10250T397LGD2A-1 | 10250T397LGD2A-51 | |
| | | | | Amber | 10250T397LAD2A-53 | 10250T397LAD2A-1 | 10250T397LAD2A-51 | |
| | Yellow | | 10250T397LYD2A-53 | 10250T397LYD2A-2 | 10250T397LYD2A-51 | | | |
| | Blue | | 10250T397LLD2A-53 | 10250T397LLD2A-1 | 10250T397LLD2A-51 | | | |
| | White | | 10250T397LWD2A-53 | 10250T397LWD2A-1 | 10250T397LWD2A-51 | | | |
| | Transformer | | 120 Vac | Red | 10250T411LRD06-53 | 10250T411LRD06-1 | 10250T411LRD06-51 | |
| | | | | Green | 10250T411LGD06-53 | 10250T411LGD06-1 | 10250T411LGD06-51 | |
| | | | | Amber | 10250T411LAD06-53 | 10250T411LAD06-1 | 10250T411LAD06-51 | |
| | | Yellow | | 10250T411LYD06-53 | 10250T411LYD06-1 | 10250T411LYD06-51 | | |
| | | Blue | | 10250T411LLD06-53 | 10250T411LLD06-1 | 10250T411LLD06-51 | | |
| | | White | | 10250T411LWD06-53 | 10250T411LWD06-1 | 10250T411LWD06-51 | | |
| Incandescent Lamp | | | | | | | | |
| Full voltage | | 24 Vac/Vdc | | Red | #757 | 10250T476C21-53 | 10250T476C21-1 | 10250T476C21-51 |
| | | | | Green | | 10250T476C22-53 | 10250T476C22-1 | 10250T476C22-51 |
| | Amber | | 10250T476C43-53 | 10250T476C43-1 | | 10250T476C43-51 | | |
| | Yellow | | 10250T476C23-53 | 10250T476C23-1 | | 10250T476C23-51 | | |
| | Blue | | 10250T476C24-53 | 10250T476C24-1 | | 10250T476C24-51 | | |
| | Clear | | 10250T476C25-53 | 10250T476C25-1 | | 10250T476C25-51 | | |
| | White | | 10250T476C26-53 | 10250T476C26-1 | | 10250T476C26-51 | | |
| | Resistor | 120 Vac/Vdc | Red | 120MB | 10250T471C21-53 | 10250T471C21-1 | 10250T471C21-51 | |
| | | | Green | | 10250T471C22-53 | 10250T471C22-1 | 10250T471C22-51 | |
| | | | Amber | | 10250T471C43-53 | 10250T471C43-1 | 10250T471C43-51 | |
| | | | Yellow | | 10250T471C23-53 | 10250T471C23-1 | 10250T471C23-51 | |
| | | | Blue | | 10250T471C24-53 | 10250T471C24-1 | 10250T471C24-51 | |
| | | | Clear | | 10250T471C25-53 | 10250T471C25-1 | 10250T471C25-51 | |
| | | | White | | 10250T471C26-53 | 10250T471C26-1 | 10250T471C26-51 | |
| | | | Transformer | | 120 Vac | Red | #755 | 10250T75R ① |
| Green | 10250T75G ① | 10250T76G ① | | 10250T77G ① | | | | |
| Amber | 10250T75A ① | 10250T76A ① | | 10250T77A ① | | | | |
| Yellow | 10250T75Y ① | 10250T76Y ① | | 10250T77Y ① | | | | |
| Blue | 10250T75B ① | 10250T76B ① | | 10250T77B ① | | | | |
| Clear | 10250T75C ① | 10250T76C ① | | 10250T77C ① | | | | |
| White | 10250T75W ① | 10250T76W ① | | 10250T77W ① | | | | |

Note

① For flashing module catalog number 10250TFL1, add suffix code **FM** to listed catalog number. Example: 10250T75R**FM**.

Indicating Light Units ①

UL (NEMA) Type 3, 3R, 4, 4X, 12, 13

- LED or incandescent
- Full voltage, resistor or transformer type
- Standard and PresTest types
- Plastic lenses

PresTest—This device incorporates a press-to-test feature whereby depressing the lens disconnects the light from the source being

monitored and connects the lamp to a continuously energized circuit for immediate detection of faulty lamps.

24V Full Voltage Illuminated Light



120 Vac Transformer PresTest



Indicating Light Units

| Type | Voltage | Color | LED/Lamp Number | Indicating Light Catalog Number | PresTest Catalog Number | | |
|--------------------------|-------------|----------------|-----------------|---------------------------------|-------------------------|----------------|---------------|
| LED Lamp | | | | | | | |
| Full voltage | 24 Vac/Vdc | Red | Bayonet base | 10250T197LRP24 | 10250T297LRP24 | | |
| | | Green | | 10250T197LGP24 | 10250T297LGP24 | | |
| | | Amber | | 10250T197LAP24 | 10250T297LAP24 | | |
| | | Yellow | | 10250T197LYP24 | 10250T297LYP24 | | |
| | | Blue | | 10250T197LLP24 | 10250T297LLP24 | | |
| | | White | | 10250T197LWP24 | 10250T297LWP24 | | |
| | | 120 Vac | | Red | 10250T197LRP2A | 10250T297LRP2A | |
| | | | | Green | 10250T197LGP2A | 10250T297LGP2A | |
| | Amber | | 10250T197LAP2A | 10250T297LAP2A | | | |
| | Yellow | | 10250T197LYP2A | 10250T297LYP2A | | | |
| | Blue | | 10250T197LLP2A | 10250T297LLP2A | | | |
| | White | | 10250T197LWP2A | 10250T297LWP2A | | | |
| | Transformer | | 120 Vac | Red | 10250T181LRP06 | 10250T221LRP06 | |
| | | | | Green | 10250T181LGP06 | 10250T221LGP06 | |
| | | Amber | | 10250T181LAP06 | 10250T221LAP06 | | |
| | | Yellow | | 10250T181LYP06 | 10250T221LYP06 | | |
| Blue | | 10250T181LLP06 | | 10250T221LLP06 | | | |
| White | | 10250T181LWP06 | | 10250T221LWP06 | | | |
| Incandescent Lamp | | | | | | | |
| Full voltage | | 24 Vac/Vdc | | Red | #757 | 10250T206NC1N | 10250T235NC21 |
| | Green | | 10250T206NC2N | 10250T235NC22 | | | |
| | Amber | | 10250T206NC19N | 10250T235NC43 | | | |
| | Yellow | | 10250T206NC3N | 10250T235NC23 | | | |
| | Blue | | 10250T206NC4N | 10250T235NC24 | | | |
| | Clear | | 10250T206NC5N | 10250T235NC25 | | | |
| | White | | 10250T206NC6N | 10250T235NC26 | | | |
| | Resistor | 120 Vac/Vdc | Red | 120MB | 10250T201NC1N | 10250T231NC21 | |
| | | | Green | | 10250T201NC2N | 10250T231NC22 | |
| | | | Amber | | 10250T201NC19N | 10250T231NC43 | |
| | | | Yellow | | 10250T201NC3N | 10250T231NC23 | |
| | | | Blue | | 10250T201NC4N | 10250T231NC24 | |
| | | | Clear | | 10250T201NC5N | 10250T231NC25 | |
| | | | White | | 10250T201NC6N | 10250T231NC26 | |
| Transformer ② | 120 Vac | Red | #755 | 10250T34R | 10250T74NR | | |
| | | Green | | 10250T34G | 10250T74NG | | |
| | | Amber | | 10250T34A | 10250T74NA | | |
| | | Yellow | | 10250T34Y | 10250T74NY | | |
| | | Blue | | 10250T34B | 10250T74NB | | |
| | | Clear | | 10250T34C | 10250T74NC | | |
| | | White | | 10250T34W | 10250T74NW | | |

Notes

- ① Standard indicating lights are rated UL (NEMA) 3S as well.
- ② For flashing lamp add letter **F** to listed catalog number. Example: 10250T34RF.

1

Illuminated Pushbuttons and Indicating Lights

- LED or incandescent
- Full voltage, resistor or transformer type

Illuminated Pushbutton



Operators without Lens

Indicating Light



PresTest



Master Test



| Type | Voltage | LED/Lamp Number | Illuminated Pushbutton Catalog Number | Indicating Light Catalog Number | PresTest Catalog Number | Master Test Catalog Number |
|---|---------|-----------------|---------------------------------------|---------------------------------|-------------------------|----------------------------|
| Incandescent Unit | | | | | | |
| Full voltage AC/DC | 6 | #755 | 10250T473 | 10250T203N | 10250T232N | — |
| | 12 | #756 | 10250T474 | 10250T204N | 10250T233N | — |
| | 24 | #757 | 10250T476 | 10250T206N | 10250T235N | — |
| | 32 | #1828 | 10250T477 | 10250T207N | 10250T238N | — |
| | 48 | #1835 | 10250T478 | 10250T208N | 10250T239N | — |
| Resistor AC/DC ^② | 120 | 120MB | 10250T471 | 10250T201N | 10250T231N | — |
| | 240 | 120MB | 10250T472 | 10250T202N | 10250T240N | — |
| Transformer AC only ^③ | 24 | #755 | 10250T416 | — | — | — |
| | 120 | | 10250T411 | 10250T181N | 10250T221N | — |
| | 240 | | 10250T422 | 10250T182N | 10250T222N | — |
| | 277 | | 10250T419 | 10250T198N | — | — |
| | 380 | | 10250T413 | 10250T183N | 10250T223N | — |
| | 480 | | 10250T414 | 10250T184N | 10250T224N | — |
| Neon AC/DC ^④ | 120 | NE51H-R22 | — | 10250T226N | — | — |
| | 240 | NE51H-R68 | — | 10250T227N | — | — |
| Solid-state 50/60 Hz only | 120 | 120MB | — | — | — | 10250T189N |
| LED (LEDs not included) ^① | | | | | | |
| Full voltage | — | Bayonet base | 10250T397L | 10250T197L | 10250T297L | — |
| Transformer AC only | 24 | | 10250T416L | — | — | — |
| | 120 | | 10250T411L | 10250T181L | 10250T221L | — |
| | 240 | | 10250T412L | 10250T182L | 10250T222L | — |
| | 277 | | 10250T419L | 10250T198L | — | — |
| | 380 | | 10250T413L | 10250T183L | 10250T223L | — |
| | 480 | | 10250T414L | 10250T184L | 10250T224L | — |
| | 600 | | 10250T415L | 10250T185L | 10250T225L | — |

Notes

- ① These units do not include lamps. Order LED separately to match lens color. See **Page V7-T1-269** for LED Selection and **Page V7-T1-216** for Catalog Numbering System.
- ② Resistor units are not available for use with LEDs, choose either transformer or full voltage LED style.
- ③ For flashing lamp, add letter **F** to listed catalog number. Example: 10250T181NF.
- ④ Resistant to shock and vibration. For best illumination use amber, yellow or clear lens.

Plastic



Indicating and Master Test Lenses

| Color | Plastic Catalog Number | Glass Catalog Number |
|--------|------------------------|----------------------|
| Red | 10250TC1N | 10250TC7N |
| Green | 10250TC2N | 10250TC8N |
| Amber | 10250TC19N | 10250TC9N |
| Yellow | 10250TC3N | — |
| Blue | 10250TC4N | 10250TC10N |
| Clear | 10250TC5N | 10250TC11N |
| White | 10250TC6N | 10250TC12N |

Glass



10250TC2



Illuminated Pushbutton Lenses

| Color | Catalog Number |
|--------|----------------|
| Red | 10250TC21 |
| Green | 10250TC22 |
| Yellow | 10250TC23 |
| Amber | 10250TC43 |
| Blue | 10250TC24 |
| Clear | 10250TC25 |
| White | 10250TC26 |

Plastic



PresTest Lenses

| Color | Plastic Catalog Number | Glass Catalog Number |
|--------|------------------------|----------------------|
| Red | 10250TC21 | 10250TC13N |
| Green | 10250TC22 | 10250TC14N |
| Amber | 10250TC43 | 10250TC15N |
| Yellow | 10250TC23 | — |
| Blue | 10250TC24 | 10250TC16N |
| Clear | 10250TC25 | 10250TC17N |
| White | 10250TC26 | 10250TC18N |

Glass



1 Push-Pull Emergency Stops (Compliant with IEC 60947-5-5)

UL (NEMA) Type 3, 3R, 4, 4X, 12, 13

- Two- and three-position
- Non-illuminated
- LONC contact block

10250T579C47-71X**Two-Position Push-Pull Units****Operator Position** ^①

| Pull | Push | Button Type/Color | Lamp | Type | Voltage | Catalog Number |
|------|------|-----------------------------------|--------------|--------------|-------------|---------------------------|
| X | 0 | 40 mm red—illuminated | Incandescent | Transformer | 120 Vac/Vdc | 10250T563C47-71X |
| X | 0 | 40 mm red—illuminated EMERG. STOP | Incandescent | Transformer | 120 Vac/Vdc | 10250T563C53-71X |
| X | 0 | 40 mm red—illuminated EMERG. STOP | LED | Transformer | 120 Vac/Vdc | 10250T563LED06-71X |
| X | 0 | 40 mm red—illuminated | Incandescent | Full voltage | 24 Vdc | 10250T579C47-71X |
| X | 0 | 40 mm red—illuminated EMERG. STOP | Incandescent | Full voltage | 24 Vdc | 10250T579C53-71X |
| X | 0 | 40 mm red—illuminated | Incandescent | Resistor | 120 Vac/Vdc | 10250T580C47-71X |
| X | 0 | 40 mm red—illuminated EMERG. STOP | Incandescent | Resistor | 120 Vac/Vdc | 10250T580C53-71X |
| X | 0 | 40 mm red—illuminated | Incandescent | Transformer | 24 Vac | 10250T589C47-71X |
| X | 0 | 40 mm red—illuminated EMERG. STOP | Incandescent | Transformer | 24 Vac | 10250T589C53-71X |
| X | 0 | 40 mm red—illuminated EMERG. STOP | LED | Transformer | 24 Vac | 10250T589LED06-71X |
| X | 0 | 40 mm red—illuminated | LED | Transformer | 24 Vac | 10250T589LRD06-71X |
| X | 0 | 40 mm red—illuminated EMERG. STOP | LED | Full voltage | 24 Vdc | 10250T597LED24-71X |
| X | 0 | 40 mm red—illuminated EMERG. STOP | LED | Full voltage | 120 Vac/Vdc | 10250T597LED2A-71X |
| X | 0 | 40 mm red—illuminated | LED | Full voltage | 24 Vdc | 10250T597LRD24-71X |
| X | 0 | 40 mm red—illuminated | LED | Full voltage | 120 Vac/Vdc | 10250T597LRD2A-71X |
| X | 0 | 40 mm red | — | — | — | 10250T5B62-71X |
| X | 0 | 40 mm red—EMERG. STOP | — | — | — | 10250T5B63-71X |
| X | 0 | 65 mm red | — | — | — | 10250T5J62-71X |
| X | 0 | 65 mm red—EMERG. STOP | — | — | — | 10250T5J63-71X |

Note

① X = closed circuit, 0 = open circuit.

UL (NEMA) Type 3, 3R, 4, 4X, 12, 13

Two-Position Push-Pull Units

Operator Position ^①

Pull



Push



Button Type/Color ^②

Contact Type













Mounting Location

A



B

Catalog Number ^②

Two-Position Maintained Push, Maintained Pull

| | | | | | | | |
|--|---|---|--|-----|---|--|----------------------|
| 10250T5B62-1X  | 0 | X | 40 mm/red | 1NO |  |  | 10250T5B62-1X |
| | X | 0 | | | | | |
| 10250T5B63-1X  | 0 | X | 40 mm engraved EMERG. STOP/red | 1NO |  |  | 10250T5B63-1X |
| | X | 0 | | | | | |
| 10250T5J63-1X  | 0 | X | 65 mm aluminum engraved EMERG. STOP/red | 1NO |  |  | 10250T5J63-1X |
| | X | 0 | | | | | |
| 10250ED1080-2  | 0 | X | 65 mm aluminum engraved EMERG. STOP/red | 1NO |  |  | 10250ED1080-2 |
| | X | 0 | | | | | |

Button and Color Selection

| | Color | Suffix Code | Catalog Number |
|---|---|--------------------|-----------------------|
| Standard  | Standard—40 mm | | |
| | Red | B62 | 10250TB62 |
| | Red (EMERG. STOP) | B63 | 10250TB63 |
| | Green | B61 | 10250TB61 |
| | Black | B60 | 10250TB60 |
| | Blue | B64 | 10250TB64 |
| Jumbo Mushroom Head  | Jumbo Mushroom Head ^③ (Anodized) Aluminum—65 mm | | |
| | Red | J62 | 10250TJ62 |
| | Red (EMERG. STOP) | J63 | 10250TJ63 |
| | Green | J61 | 10250TJ61 |
| | Black | J60 | 10250TJ60 |
| | Yellow | J64 | 10250TJ64 |

Notes

^① X = closed circuit, 0 = open circuit.

^② To order different type or color buttons, substitute the underlined characters with appropriate suffix code from the table.
Example: 10250TB64-1X.

^③ Anodized aluminum head is not suitable for use in ultraviolet light applications.

UL (NEMA) Type 3, 3R, 4, 4X, 12, 13

10250T_

Three-Position Push-Pull Units

Operator Position ^①



| Pull | Intermediate | Push | Button Type/Color ^② | Contact Type | Mounting Location | | Catalog Number ^② |
|--|--------------|------|--------------------------------|--------------|-------------------|---|-----------------------------|
| | | | | | A | B | |
| Maintained Push, Momentary Pull | | | | | | | |
| X | 0 | 0 | 40 mm/black | 1NC | | | 10250T9B60-3X |
| X | X | 0 | 40 mm/red | 1NC | | | 10250T9B62-3X |
| | | | 40 mm engraved EMERG. STOP/red | | | | 10250T9B63-3X |
| Momentary Push, Momentary Pull | | | | | | | |
| X | 0 | 0 | 40 mm/black | 1NC | | | 10250T4B60-3X |
| X | X | 0 | 40 mm/red | 1NC | | | 10250T4B62-3X |
| 0 | 0 | X | 40 mm/black | 1NO | | | 10250T10B60-1X |
| X | 0 | 0 | 40 mm/red | 1NC | | | 10250T10B62-1X |

Button and Color Selection

| Color | Suffix Code | Catalog Number |
|---|-------------|------------------|
| Standard—40 mm | | |
| Red | B62 | 10250TB62 |
| Red (EMERG. STOP) | B63 | 10250TB63 |
| Green | B61 | 10250TB61 |
| Black | B60 | 10250TB60 |
| Blue | B64 | 10250TB64 |
| Jumbo Mushroom Head ^③ (Anodized) Aluminum—65 mm | | |
| Red | J62 | 10250TJ62 |
| Red (EMERG. STOP) | J63 | 10250TJ63 |
| Green | J61 | 10250TJ61 |
| Black | J60 | 10250TJ60 |
| Yellow | J64 | 10250TJ64 |

Notes

- ① X = closed circuit, 0 = open circuit.
- ② To order different type or color buttons, substitute the underlined characters with appropriate suffix code from the table. Example: 10250T5B64-1X.
- ③ Anodized aluminum head is not suitable for use in ultraviolet light applications.

Standard



Jumbo Mushroom Head



Illuminated Push-Pull Units

UL (NEMA) Type 3, 3R, 4, 4X, 12, 13

- LED or incandescent
- Full voltage, resistor or transformer type
- Two-position maintained

Two-Position Push-Pull Operator



Two-Position Illuminated Maintained Push, Maintained Pull

Operator Position ①

| Maintained—Pull | Maintained—Push | Lamp | Type | Voltage | Contact Type | Mounting Location A | Mounting Location B | LED/Lamp Number | Red Standard Push-Pull Catalog Number ② |
|-----------------|-----------------|--------------|--------------|-------------|--------------|--------------------------|------------------------|-----------------|---|
| 0 | X | LED | Full Voltage | 24 Vac/Vdc | 1NO | | | Bayonet base | 10250T597LRD24-1X |
| X | 0 | | | 120 Vac/Vdc | 1NC | | | | 10250T597LRD24A-1X |
| | | | Transformer | 24 Vac | | 10250T589LRD06-1X | | | |
| | | | | 120 Vac | | 10250T563LRD06-1X | | | |
| 0 | X | Incandescent | Full voltage | 24 Vac/Vdc | 1NO | | | #757 | 10250T579C47-1X |
| X | 0 | | | 120 Vac/Vdc | 1NC | | | 120MB | 10250T580C47-1X |
| | | | Transformer | 24 Vac | | #755 | 10250T589C47-1X | | |
| | | | | 120 Vac | | 10250T563C47-1X | | | |

10250ED137_

Jumbo Lens Illuminated E-Stops







| Lamp | Button Type/Color | Type | Voltage | Contact Type | Catalog Number |
|------|--|--------------|------------|--------------|--------------------|
| LED | Two-position illuminated maintained push/pull— 50 mm jumbo lens/red | Full voltage | 24 Vac/Vdc | 1NO 1NC | 10250ED1375 |
| LED | Three-position illuminated momentary push/pull— 50 mm jumbo lens/red | Full voltage | 24 Vac/Vdc | 1NC 1NC | 10250ED1376 |
| LED | Three-position illuminated momentary push/pull— 50 mm jumbo lens/red | Full voltage | 24 Vac/Vdc | 1NO 1NC | 10250ED1377 |
| LED | Three-position illuminated maintained push/momentary pull— 50 mm lens/red | Full voltage | | 1NO 1NC | 10250ED1378 |

Notes

- ① X = closed circuit, 0 = open circuit.
- ② To order different type or color lens, substitute the underlined characters with appropriate suffix code from table on next page. Example: 10250T579C63-1X. For LEDs with different voltages see ordering example on **Page V7-T1-235**.

UL (NEMA) Type 3, 3R, 4, 4X, 12, 13

Lens and Color Selection

| | Color | Incandescent Suffix Code | LED Suffix Code | Catalog Number |
|--|--|-----------------------------|--------------------|----------------|
| Standard  | Standard—40 mm | | | |
| | Red | C47 | RD | 10250TC47 |
| | Red (EMERG. STOP) | C53 | ED | 10250TC53 |
| | Green | C48 | GD | 10250TC48 |
| | Blue | C49 | LD | 10250TC49 |
| | Amber | C50 | AD | 10250TC50 |
| | White | C51 | WD | 10250TC51 |
| | Clear | C52 | CD | 10250TC52 |
| Side-Lighted Aluminum  | Side-Lighted Aluminum—40 mm ① | | | |
| | Red | C57 | RS | 10250TC57 |
| | Red (EMERG. STOP) | C63 | ES | 10250TC63 |
| | Green | C58 | GS | 10250TC58 |
| | Blue | C59 | LS | 10250TC59 |
| | Amber | C64 | AS | 10250TC64 |
| | Yellow | C60 | YS | 10250TC60 |
| | White | C61 | WS | 10250TC61 |
| Clear | C62 | CS | 10250TC62 | |
| Aluminum Transparent Center  | Aluminum Transparent Center—40 mm ① | | | |
| | Red | C65 | RH | 10250TC65 |
| | Green | C66 | GH | 10250TC66 |
| Jumbo Lens  | Jumbo Lens—50 mm | | | |
| | Red | — | — | 10250TC77 |

Note

① Clear anodized aluminum and colored lens.

UL (NEMA) Type 3, 3R, 4, 4X, 12, 13

Three-Position Push-Pull Operator



Three-Position Illuminated Momentary Push, Momentary Pull

Operator Position ①

| Momentary— Pull | Maintained— Intermediate | Momentary— Push | Lamp | Type | Voltage | Contact Type | Mounting Location | | LED/ Lamp Number | Red Standard Push-Pull Catalog Number ③ | |
|--------------------|-----------------------------|--------------------|-------------------|--------------|-------------|-----------------|-------------------|---|------------------------|---|---------------------------|
| | | | | | | | A | B | | | |
| 0 | 0 | X | LED | Full voltage | 24 Vac/Vdc | 1NO | | | Bayonet base | 10250T1097LRD24-1X | |
| X | 0 | 0 | | | 120 Vac | 1NC | | | | 10250T1097LRD2A-1X | |
| | | | | | Transformer | 24 Vac | | | | | 10250T1089LRD06-1X |
| | | | | | 120 Vac | | | | | 10250T1063LRD06-1X | |
| X | 0 | 0 | Incan- descent | Full voltage | 24 Vac/Vdc | 1NC | | | Bayonet base | 10250T497LRD24-3X | |
| X | X | 0 | | | 120 Vac | 1NC | | | | 10250T497LRD2A-3X | |
| | | | | | Transformer | 24 Vac | | | | | 10250T489LRD06-3X |
| | | | | | 120 Vac | | | | | 10250T463LRD06-3X | |
| 0 | 0 | X | Incan- descent | Full voltage | 24 Vac/Vdc | 1NO | | | #757 | 10250T1079C47-1X | |
| X | 0 | 0 | | | Resistor | 120 Vac | | | | 1NC | 10250T1080C47-1X |
| | | | | | Transformer | 24 Vac | | | | | 10250T1089C47-1X |
| | | | | | 120 Vac | | | | | 10250T1063C47-1X | |
| X | 0 | 0 | Incan- descent | Full voltage | 24 Vac/Vdc | 1NC | | | #757 | 10250T479C47-3X | |
| X | X | 0 | | | Resistor | 120 Vac | | | | 1NC | 10250T480C47-3X |
| | | | | | Transformer | 24 Vac | | | | | 10250T489C47-3X |
| | | | | | 120 Vac | | | | | 10250T463C47-3X | |

Three-Position Push-Pull Operator



Three-Position Illuminated Maintained Push, Momentary Pull

Operator Position ①

| Momentary— Pull | Maintained— Intermediate | Momentary— Push | Lamp | Type | Voltage | Contact Type | Mounting Location | | LED/ Lamp Number | Red Standard Push-Pull Catalog Number ② | |
|--------------------|-----------------------------|--------------------|-------------------|--------------|-------------|-----------------|-------------------|---|------------------------|---|--------------------------|
| | | | | | | | A | B | | | |
| X | 0 | 0 | LED | Full voltage | 24 Vac/Vdc | 1NC | | | Bayonet base | 10250T997LRD24-3X | |
| X | X | 0 | | | 120 Vac | 1NC | | | | 10250T997LRD2A-3X | |
| | | | | | Transformer | 24 Vac | | | | | 10250T989LRD06-3X |
| | | | | | 120 Vac | | | | | 10250T963LRD06-3X | |
| X | 0 | 0 | Incan- descent | Full voltage | 24 Vac/Vdc | 1NC | | | #757 | 10250T979C47-3X | |
| X | X | 0 | | | Resistor | 120 Vac | | | | 1NC | 10250T980C47-3X |
| | | | | | Transformer | 24 Vac | | | | | 10250T989C47-3X |
| | | | | | 120 Vac | | | | | 10250T963C47-3X | |

Notes

- ① X = closed circuit, 0 = open circuit.
- ② To order different type or color lens, substitute the underlined characters with appropriate suffix code from table on **Page V7-T1-230**. Example: 10250T1079C53-1X. For LEDs with different voltages see ordering example on **Page V7-T1-235**.
- ③ To order different type or color lens, substitute the underlined characters with appropriate suffix code from table on **Page V7-T1-230**. Example: 10250T979C53X. For LEDs with different voltages see ordering example on **Page V7-T1-235**.

Potentiometers

UL (NEMA) Type 3, 3R, 4, 4X, 12, 13

**Vertical or Horizontal
One-Hole Mounting** ①**Potentiometer with Knob and Standard Dial Plate—Linear Type $\pm 10\%$**

| Potentiometer Ohms | Catalog Number |
|--|------------------|
| 2 Watt (60V Max.) Single Potentiometer with Standard Aluminum Dial Plate ②③ | |
| 1000 | 10250T331 |
| 2500 | 10250T332 |
| 5000 | 10250T338 |
| 10000 | 10250T333 |
| 25000 | 10250T334 |
| 50000 | 10250T335 |
| Operator only ④ | 10250T330 |
| Alternative—black plastic large legend with standard markings | E34LP99 |

Notes

- ① Shown with standard aluminum dial plate.
- ② Large dial plate with space for legend is available at no charge. To order, add suffix **36** to catalog number. Example: 10250T331**36**. To order separately, see footnote ③ below.
- ③ Large dial plate has space at top for 15 letters. 3/32 in high. For custom stamped legend plates, order legend plate as separate item **10250TR30** and specify stamping.
- ④ For use with commercially purchased potentiometers having shaft dimensions per dimension drawing on **Page V7-T1-279**.

Push-Pull Operators

An illuminated push-pull pushbutton unit, arranged for one-hole mounting, can replace two pushbuttons and a pilot light or the non-illuminated form can replace two pushbuttons. These units are available in three basic types:

- **Maintained**—(Two-position). Maintains in the pulled or pushed position until manually actuated to the opposite mode.
- **Momentary**—(Three-position). Spring returns to an intermediate position when pulled or pushed and released.
- **Momentary Pull, Maintained Push**—(Three-position). Spring returns to intermediate position when pulled. Maintains in pushed position until manually returned to intermediate (ready to reset) position. Maintained stop holds circuit open and will prevent other series connected operators from starting the system.

The operators, buttons, contact blocks, etc., are offered as building block components that can be intermixed to satisfy many requirements. This minimizes the need for a varied and costly inventory.

Two-Position Maintained Push-Pull ①



Typical Applications

| Control | Line—Diagram | Operator | Circuits | Operator Mode | | | | | | |
|---|--------------------------|--|-------------------------------|--|----------------|--------------------------|---------------|--|--|--|
| Three-wire three-position momentary | | Momentary push and pull 10250T4 | 2NC contact block 10250T3 | <table border="0"> <tr> <td>START (mom.)</td> <td>Normal pos. (maint.)</td> <td>STOP (mom.)</td> </tr> <tr> <td></td> <td></td> <td></td> </tr> </table> | START (mom.) | Normal pos. (maint.) | STOP (mom.) | | | |
| START (mom.) | Normal pos. (maint.) | STOP (mom.) | | | | | | | | |
| | | | | | | | | | | |
| Two-wire two-position maintained | | Maintained push and pull 10250T5 | 1NO-1NC contact block 10250T1 | <table border="0"> <tr> <td>START (maint.)</td> <td>No intermediate position</td> <td>STOP (maint.)</td> </tr> <tr> <td></td> <td></td> <td></td> </tr> </table> | START (maint.) | No intermediate position | STOP (maint.) | | | |
| START (maint.) | No intermediate position | STOP (maint.) | | | | | | | | |
| | | | | | | | | | | |
| Three-wire momentary pull maintained push | | Maintained push and momentary pull 10250T9 | 2NC contact block 10250T3 | <table border="0"> <tr> <td>START (mom.)</td> <td>Normal pos. (maint.)</td> <td>STOP (maint.)</td> </tr> <tr> <td></td> <td></td> <td></td> </tr> </table> | START (mom.) | Normal pos. (maint.) | STOP (maint.) | | | |
| START (mom.) | Normal pos. (maint.) | STOP (maint.) | | | | | | | | |
| | | | | | | | | | | |

Notes

A and B circuits shown in the application illustrations are defined in the "Application Guide" on the following page.
 ① Shown without button on lens.

1.9

Pushbuttons and Indicating Lights

30.5 mm Heavy-Duty Watertight/Oiltight—10250T

1

Application Guide

To assist in the selection of contact blocks, the sketch to the right shows pictorially by symbols **A** and **B** locations of contact circuits after assembly of contact blocks

and adapter to the operator. The table below shows the effect of the push and pull operations on either NO or NC contacts. (X = contact closed, O = contact open).

Contact Circuit Locations

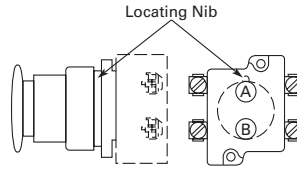

10250T579C47-71X

Push-Pull Operator Components



Operator Position and Circuit Arrangement

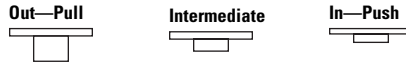

Contact Block Mounting Location

| Type of Operator | Out—Pull | | Intermediate | | In—Push | | Contact Block ① | Catalog Number |
|---|----------|---|--------------------------|---|---------|---|-----------------|--------------------|
| | A | B | A | B | A | B | | |
| Two-Position Operator without Lens | | | | | | | | |
| Maintained push-pull | O | O | No intermediate position | | X | X | 1NO | 10250T5 |
| | X or | X | | | O or | O | 1NC | |
| Maintained push-pull with anti-theft jumbo mushroom | O | O | No intermediate position | | X | X | 1NO | 10250ED1080 |
| | X or | X | | | O or | O | 1NC | |
| | O | O | | | X | X | 2NO | |
| | X | X | | | O | O | 2NC | |
| Three-Position Operator without Lens | | | | | | | | |
| Momentary push-pull | O | O | O | O | X | O | 1NO | 10250T4 ① |
| | X or | X | O or | X | O or | O | 1NC | |
| | O | O | O | O | X | O | 2NO | |
| | X | X | O | X | O | O | 2NC | |
| Maintained push-momentary pull | O | O | O | O | X | O | 1NO | 10250T9 ① |
| | X or | X | O or | X | O or | O | 1NC | |
| | O | O | O | O | X | O | 2NO | |
| | X | X | O | X | O | O | 2NC | |
| Momentary push-pull | O | O | O | O | X | X | 1NO | 10250T10 ① |
| | X or | X | O or | O | O or | O | 1NC | |
| | O | O | O | O | X | X | 2NO | |
| | X | X | O | O | O | O | 2ND | |

Note

① Maximum of two blocks, four circuits. Special function contact blocks shown on Page V7-T1-265 CANNOT be used with three-position push-pull operators 10250T4, 10250T9 or 10250T10.

Push-Pull Light Units, Lenses and Buttons

Ordering Example with One Composite Number

Non-illuminated:

10250T5 + 10250TB62 + 10250T1 = **10250T5B62-1X**

Incandescent:

10250T5 + 10250T79 + 10250TC47 + 10250T1 = **10250T579C47-1X**

LED:

10250T5 + 10250T97L + 10250TC47 + Voltage code + 10250T1 = **10250T597LRD24-1X**

06—6 Vac/Vdc
 12—12 Vac/Vdc
 24—24 Vac/Vdc
 48—48 Vac/Vdc

60—60 Vac/Vdc
 2A—120 Vac
 2D—120 Vdc





Light Units for Illuminated Push-Pull Devices

| Light Unit Type | Type | Voltage | LED/Lamp Number | Catalog Number |
|---|------------------------------------|--------------|-----------------|--------------------------|
| LED (LEDs not included) ^① | Full voltage | — | Bayonet base | 10250T97L |
| | Transformer AC only 50/60 Hz | 24 | | 10250T89L |
| | | 120 | | 10250T63L |
| | | 208 | | 10250T64L |
| | | 240 | | 10250T65L |
| | | 277 | | 10250T82L |
| | | 380 | | 10250T66L |
| | | 480 | | 10250T67L |
| | | 600 | | 10250T68L |
| | | Incandescent | | Full voltage AC or DC |
| 12 | 10250T70 | | | |
| 24/28 | 10250T79 | | | |
| 32 | 10250T83 | | | |
| Resistor AC or DC | 120 | | 120MB | 10250T80 |
| | 240 | | | 10250T81 |
| Transformer AC only 50/60 Hz | 24 | | #755 | 10250T89 |
| | 120 | | | 10250T63 |
| | 208 | | | 10250T64 |
| | 240 | | | 10250T65 |
| | 277 | | | 10250T82 |
| | 380 | | | 10250T66 |
| | 480 | | | 10250T67 |
| | 600 | | | 10250T68 |



Note

^① These units do not include lamps. Order LED separately to match lens color, see **Page V7-T1-269**.

Alternate Lenses for Illuminated Push-Pull Devices

| | Lens Color | Incandescent Suffix Code | LED Suffix Code ^① | Catalog Number |
|---|--|--------------------------|------------------------------|----------------|
| Standard  | Standard | | | |
| | Red | C47 | RD | 10250TC47 |
| | Red (EMERG. STOP) | C53 | ED | 10250TC53 |
| | Green | C48 | GD | 10250TC48 |
| | Blue | C49 | LD | 10250TC49 |
| | Amber | C50 | AD | 10250TC50 |
| | White | C51 | WD | 10250TC51 |
| | Clear | C52 | CD | 10250TC52 |
| Side-Lighted Anodized Aluminum Ring  | Side-Lighted Anodized Aluminum Ring | | | |
| | Red | C57 | RS | 10250TC57 |
| | Red (EMERG. STOP) | C63 | ES | 10250TC63 |
| | Green | C58 | GS | 10250TC58 |
| | Blue | C59 | LS | 10250TC59 |
| | Amber | C64 | AS | 10250TC64 |
| | Yellow | C60 | YS | 10250TC60 |
| | White | C61 | WS | 10250TC61 |
| | Clear | C62 | CS | 10250TC62 |
| Heavy-Duty Aluminum  | Heavy-Duty Aluminum with Transparent Center | | | |
| | Red | C65 | RH | 10250TC65 |
| | Green | C66 | GH | 10250TC66 |
| | Amber | C67 | AH | 10250TC67 |
| | White | C68 | — | 10250TC68 |
| Jumbo Lens  | Jumbo Lens — 50 mm | | | |
| Red | — | — | 10250TC77 | |

Buttons for Non-Illuminated Push-Pull Devices

| | Color | Suffix Code | Catalog Number |
|---|---|-------------|----------------|
| Standard  | Standard | | |
| | Red | B62 | 10250TB62 |
| | Red (EMERG. STOP) | B63 | 10250TB63 |
| | Green | B61 | 10250TB61 |
| | Black | B60 | 10250TB60 |
| | Blue | B64 | 10250TB64 |
| Jumbo Mushroom Head (Anodized) Aluminum  | Jumbo Mushroom Head ^② (Anodized) Aluminum | | |
| | Red | J62 | 10250TJ62 |
| | Red (EMERG. STOP) | J63 | 10250TJ63 |
| | Green | J61 | 10250TJ61 |
| | Black | J60 | 10250TJ60 |
| | Yellow | J64 | 10250TJ64 |

Notes

- ① Suffix codes should only be used for assembling composite catalog numbers. To order lens above, order by catalog number.
- ② Anodized aluminum head is not suitable for use in ultraviolet light applications.

Legend Plates

For a complete listing of available legend plates see **Pages V7-T1-260 to V7-T1-262.**

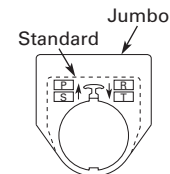

Selector Switch Units

UL (NEMA) Type 3, 3R, 4, 4X, 12, 13

- Two-, three- and four-position maintained
- Non-illuminated and illuminated

Two-Position Maintained Switch



Two-Position Selector Switch

| Operator Position ^① | | Operator Action ^② | Contact Type | Mounting Location | | Non-Illuminated | | Illuminated—120V Transformer | |
|--------------------------------|---|------------------------------|--------------|-------------------|---|--|---|--------------------------------------|---------------------------------------|
| X | O | | | A | B | Black Knob Catalog Number ^③ | Black Lever Catalog Number ^③ | Red Knob Catalog Number ^③ | Red Lever Catalog Number ^③ |
| X | O | | 1NC | | | <u>10250T20KB</u> | <u>10250T20LB</u> | <u>10250ED1117-KR</u> | <u>10250ED1117-LR</u> |
| O | X | | 1NO | | | <u>10250T21KB</u> | <u>10250T21LB</u> | <u>10250ED1117-2KR</u> | <u>10250ED1117-2LR</u> |

Three-Position Maintained Switch



Three-Position Selector Switch

| Operator Position ^① | | | Operator Action ^② | Contact Type | Mounting Location | | Non-Illuminated | | Illuminated—120V Transformer | |
|--------------------------------|---|---|------------------------------|--------------|-------------------|---|--|---|--------------------------------------|---------------------------------------|
| X | O | O | | | A | B | Black Knob Catalog Number ^③ | Black Lever Catalog Number ^③ | Red Knob Catalog Number ^③ | Red Lever Catalog Number ^③ |
| X | O | O | | 1NO | | | <u>10250T21KB</u> | <u>10250T21LB</u> | <u>10250ED1117-2KR</u> | <u>10250ED1117-2LR</u> |
| O | O | X | | 1NO | | | <u>10250T22KB</u> | <u>10250T22LB</u> | <u>10250ED1117-3KR</u> | <u>10250ED1117-3LR</u> |

Three-Position Maintained Switch



| | | | | | | | | | |
|---|---|---|--------------|--|--|-------------------|-------------------|------------------------|------------------------|
| X | O | O | 1NO | | | <u>10250T22KB</u> | <u>10250T22LB</u> | <u>10250ED1117-3KR</u> | <u>10250ED1117-3LR</u> |
| O | X | O | 2NC (Series) | | | <u>10250T46KB</u> | <u>10250T46LB</u> | <u>10250ED1117-4KR</u> | <u>10250ED1117-4LR</u> |
| O | O | X | 1NO | | | | | | |

Three-Position Maintained Switch



Four-Position Selector Switch

| Operator Position ^① | | | | Operator Action ^② | Contact Type | Mounting Location | | Non-Illuminated | | Illuminated—120V Transformer | |
|--------------------------------|---|---|---|------------------------------|--------------|-------------------|---|--|---|--------------------------------------|---------------------------------------|
| X | O | O | O | | | A | B | Black Knob Catalog Number ^③ | Black Lever Catalog Number ^③ | Red Knob Catalog Number ^③ | Red Lever Catalog Number ^③ |
| X | O | O | O | | 1NC | | | <u>10250T46KB</u> | <u>10250T46LB</u> | <u>10250ED1117-4KR</u> | <u>10250ED1117-4LR</u> |
| O | X | O | O | | 1NO | | | <u>10250T46KB</u> | <u>10250T46LB</u> | <u>10250ED1117-4KR</u> | <u>10250ED1117-4LR</u> |
| O | O | X | O | 1NO | | | | | | | |
| O | O | O | X | 1NC | | | | | | | |

Color Selection

| Illuminated | | | | | | Non-Illuminated | | | | | |
|-------------|-------------|-------|-------------|-------|-------------|-----------------|-------------|-------|-------------|--------|-------------|
| Color | Code Letter | Color | Code Letter | Color | Code Letter | Color | Code Letter | Color | Code Letter | Color | Code Letter |
| Red | R | White | W | Amber | A | Black | B | Green | G | Blue | L |
| Green | G | Blue | B | Clear | C | Red | R | White | W | Orange | O |

Notes

- ① X = closed circuit, O = open circuit.
- ② M = Maintained.
- ③ To order different type or color selector switch, substitute the underlined character with appropriate suffix code from the Color Selection table. Example: 10250T20KG.

1

Selector Switch Selection



Cam and Contact Block Selection

Selector switches in their varied forms (two-position, three-position and four-position) are a big factor contributing to the great flexibility of control that a well rounded line of “pushbuttons” can achieve. Because of their flexibility, they tend to cause difficulty with product selection and application. The following systematic approach should simplify that task.

Cam and contact block selection is better understood if you:

- Work with each incoming and outgoing wire/circuit separately.
- Recognize the terms NO and NC only identify the type of contact by its mode before mounting to the operator. The “X-O” table (Page V7-T1-240) shows how that contact will act after assembly to the operator with the selected cam shape. X = closed circuit, O = open circuit.

- Up to six NO or NC contacts may be mounted behind each plunger location for a total of twelve contacts. Single circuit contact blocks have only one plunger with the other side of the block “open.” Therefore, single circuit contact blocks transmit motion to blocks behind them only for the position containing the circuit.
- Each cam has two separate lobes, each of which operates one of the two contact block plungers independently of each other. Those are identified as position A (locating nib side) and position B (opposite of locating nib). The position designations give direction in selecting and mounting of the contact blocks.

Contact Circuit Locations

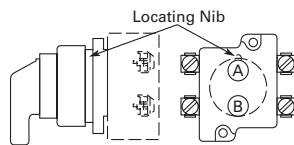

Systematic Approach

Application: **HAND-OFF-AUTO** selector switch. In this circuit, one incoming line is distributed to two other outgoing circuits by the switch. The two circuits can be looked at individually.

Step 1: Elementary Diagram.

Construct on paper, or in your mind, a simple elementary diagram of the switching scheme as follows:

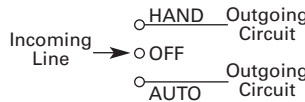

Step 2: “X-O” Pattern.

From the elementary diagram, you can construct an “X-O” diagram which describes when the contacts are to be closed (X) or open (O) in the various positions of the switch. The “X-O” for the **HAND** circuit looks like this:

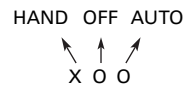

In this circuit, you want a contact closed on the left (HAND) but open in the center and right.

For the **AUTO** circuit, the “X-O” diagram would look like this:

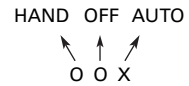

Putting them together, the complete “X-O” diagram is:



Once the “X-O” diagram has been generated the next step is to select the cam and contact block, or blocks, needed to perform the desired “X-O” functions. The selection tables on the following pages list the various types (shapes) of cams by number to choose from and the type of contact and position to achieve the function outlined in your “X-O” diagram.

Step 3: Cam Selection.

The cam you select determines the operation of all contact blocks mounted to the operator. It is selected on the basis that it provides the simplest circuitry for the desired "X-O" diagram. The selection tables show all the "X-O" combinations. For the purpose of this example, the applicable portion of those tables is shown on this page.

Now to make the cam selection, make a simple worksheet such as:

| | Cam 2 | Cam 3 |
|-------|-------------|-------|
| X O O | (A)NO-(B)NC | (A)NO |
| O O X | (B)NO | (B)NO |

It becomes immediately obvious that cam 3 is the better choice for two reasons, (1) the series combination can be avoided making it simpler to wire, (2) only two contacts are required, which is less expensive than the three contacts required by cam 2.

Step 4: Contact Block Selection.

Having selected the cam, contact block selection is simply a matter of gathering the A position and B position circuits into pairs which make up the most convenient contact block arrangement. If there is an imbalance in the number of circuits under A or B, then single circuit blocks must be selected for these leftover circuits.

Back to the worksheet, having selected cam 3 do this:



Step 5: Selector Switch Operator.

Lastly, you have to choose from the many types of operators—knob and lever in various colors or keyed. Also what combinations of maintained and spring return functions are required. Selection of these operators can be found on **Page V7-T1-242**. For the example in step 4 you may want a three-position maintained black knob, cam 3—Catalog Number 10250T1323.

The Complete Switch: 10250T1323 with one 10250T2 or, for one composite catalog number, 10250T21KB found on **Page V7-T1-237**.

Diagrams

Circuits shown illustrate connections to obtain a selector switch circuit combination and are shown with their appropriate line diagrams. Field wiring of jumper connections required as shown.

X = Closed circuit
O = Open circuit

Wiring of Jumper Connections

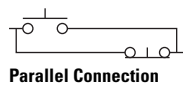
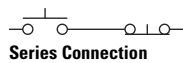

Four-position selector switches are limited to four contact blocks.

Contact Blocks

For selection and number of available contact blocks per operator, see **Pages V7-T1-265 to V7-T1-268**.

Example Selection Table

| No. | "X-O" Pattern | Cam Code #2 | | Cam Code #3 | |
|-----|---------------|-------------|----------|-------------|----------|
| | | Top A | Bottom B | Top A | Bottom B |
| 1 | X 0 0 | | | | — |
| 4 | 0 0 X | — | | — | |

Two-Position Selector Switch Contact Block Selection

| No. | Desired Circuit and Operator Position | | Contact Blocks Required to Accomplish Circuit Function | |
|-----|---------------------------------------|---|--|------------------|
| | | | Top Plunger A | Bottom Plunger B |
| 1 | X | 0 | or | |
| 2 | 0 | X | | or |

Note
① Wired in series.

1 Three-Position Switch—Cam and Contact Block Selection

| No. | Desired Circuit and Operator Position | | | Operator with Cam Code #2 | | Operator with Cam Code #3 | |
|-----|---------------------------------------|---|---|---------------------------|------------------|---------------------------|------------------|
| | | | | Mounting Location | | Mounting Location | |
| | | | | Top Plunger A | Bottom Plunger B | Top Plunger A | Bottom Plunger B |
| 1 | X | 0 | 0 | | | | |
| 2 | X | X | 0 | | | | |
| 3 | X | 0 | X | | | | |
| 4 | 0 | 0 | X | | | | |
| 5 | 0 | X | X | | | | |
| 6 | 0 | X | 0 | | | | |

Four-Position Switch—Contact Block Selection

| No. | Desired Circuit and Operator Position | | | | Contact Blocks Required to Accomplish Circuit Function | | No. | Desired Circuit and Operator Position | | | | Contact Blocks Required to Accomplish Circuit Function | |
|-----|---------------------------------------|---|---|---|--|------------------|-----|---------------------------------------|------------------|-------------------|------------------|--|--|
| | | | | | Mounting Location | | | Mounting Location | | Mounting Location | | | |
| | | | | | Top Plunger A | Bottom Plunger B | | Top Plunger A | Bottom Plunger B | Top Plunger A | Bottom Plunger B | | |
| 1 | X | 0 | 0 | 0 | | | 10 | X | 0 | X | 0 | | |
| 2 | 0 | X | 0 | 0 | | | | | | | | | |
| 3 | 0 | 0 | X | 0 | | | 11 | X | X | X | 0 | | |
| 4 | 0 | 0 | 0 | X | | | | | | | | | |
| 5 | X | 0 | 0 | X | | | 12 | 0 | X | X | X | | |
| 6 | 0 | X | X | 0 | | | | | | | | | |
| 7 | 0 | 0 | X | X | | | 13 | X | 0 | X | X | | |
| 8 | X | X | 0 | 0 | | | | | | | | | |
| 9 | 0 | X | 0 | X | | | 14 | X | X | 0 | X | | |

Selector Switch Operators

Key Operators

UL (NEMA) Type 3, 3R, 4, 4X, 12, 13



Key Operators with Cam

| Positions | Operator Action ^② | Cam Code ^③ | Optional Key Removal Positions ^④ | Vertical Mounting Catalog Number | Horizontal Mounting Catalog Number |
|--------------------------|------------------------------|-----------------------|---|----------------------------------|------------------------------------|
| Two-position—60° throw | | 1 | 1, 2, 3 | 10250T1511_ | 10250T1611_ |
| | | 1 | 2 | 10250T1571_ | 10250T1581_ |
| Three-position—60° throw | | 2 | 1-7 | 10250T1522_ | 10250T1622_ |
| | | 3 | | 10250T1523_ | 10250T1623_ |
| | | 2 | 1, 4, 5 | 10250T1532_ | 10250T1632_ |
| | | 3 | | 10250T1533_ | 10250T1633_ |
| | | 2 | 4 | 10250T1542_ | 10250T1642_ |
| | | 3 | | 10250T1543_ | 10250T1643_ |
| Four-position—40° throw | | 2 | 2, 4, 6 | 10250T1652_ | 10250T1662_ |
| | | 3 | | 10250T1653_ | 10250T1663_ |
| | | 7 | 7 | 10250T1677_ | 10250T1687_ |

Notes

- ① Horizontal mount, key removal #1 keyed selector switch, cam 1 shown.
- ② M = Maintained. S = Spring return in direction of arrow (R).
- ③ For selection of the proper cam and contact block to obtain the proper circuit sequence, see selection instructions and tables on **Pages V7-T1-238, V7-T1-239 and V7-T1-240.**
- ④ Choose key removal position required for application from table on **Page V7-T1-242.** Add key removal code no. to listed catalog number. Example: 10250T15112.

Key Removal Positions

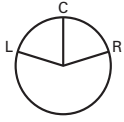

| Code Suffix | Key Removal Position |
|-------------|----------------------|
| 1 | Right only |
| 2 | Left only |
| 3 | Right and left |
| 4 | Center only |
| 5 | Right and center |
| 6 | Left and center |
| 7 | All positions |

Note: Key removal in “spring return from” positions not recommended.

Replacement Keys or Dissimilar Locks for Key Operators

Operators listed on **Page V7-T1-242** have identical locks and keys (Key Code H661) Catalog Number 10250ED824. For dissimilar lock and key combinations, see listing on this page.

Replacement Key

| Description | Catalog Number |
|------------------------------|----------------|
| Replacement keys (code H661) | 10250ED824 |

Selector Switch Operators with Dissimilar Locks and Keys (UL [NEMA] 4, 4X and 13)

The locks in all key operators listed on **Pages V7-T1-221, V7-T1-242** and **V7-T1-379** are identical and use key code number H661. Two keys are supplied with every lock. For additional code number H661 keys, order **Catalog Number 10250ED824**. For others, order 10250ED1130 and designate lock number. When dissimilar locks for each operator or each group of operators are required, select from the lock and key combination listed below. **When Ordering Operator Only** or a complete control unit with a substitute lock, order from table below and add “except Lock and Key Code No. ...”

“H” Series Locks without Master Key—with Key Slot Cover

| Lock and Key Code Numbers | | |
|---------------------------|------|------|
| H501 | H635 | H663 |
| H620 | H639 | H675 |
| H621 | H643 | H683 |
| H634 | H654 | H688 |

“M” Series Locks with Master Key—with Key Slot Cover

| Lock and Key Code Numbers | | | |
|---------------------------|------|------|------|
| MD1 | MD14 | ME8 | MJ6 |
| MD2 | MD15 | ME11 | MJ10 |
| MD3 | MD16 | ME16 | MJ11 |
| MD4 | MD19 | ME17 | MJ13 |
| MD5 | MD20 | ME18 | MJ15 |
| MD7 | ME2 | ME19 | MJ16 |
| MD9 | ME3 | MJ1 | MD17 |
| MD10 | ME5 | MJ3 | |
| MD11 | ME6 | MJ4 | |
| MD13 | ME7 | MJ5 | |

Master Keys for Above Locks

| Application | Catalog Number |
|-------------|----------------|
| For code: | |
| MD1–MD20 | 10250ED825-3 |
| ME2–ME18 | 10250ED825-4 |
| MJ1–MJ16 | 10250ED825-5 |

Selector Switch Operators with Caps

UL (NEMA) Type 3, 3R, 4, 4X, 12, 13

Selector Switch Operators with Caps

| Positions | Operator Action ^② | Black Knob Selector Switch—Vertical Mounting ^③ | | Black Lever Selector Switch—Vertical Mounting ^③ | | |
|--|------------------------------|---|----------------|--|----------------|------------|
| | | Cam Code ^④ | Catalog Number | Cam Code ^④ | Catalog Number | |
| Two-Position Maintained ^① | Two-position—60° throw | | 1 | 10250T1311 | 1 | 10250T3011 |
| | | | 1 | 10250T1371 | 1 | 10250T3071 |
| Three-Position Maintained ^⑤ | Three-position—60° throw | | 2 | 10250T1322 | 2 | 10250T3022 |
| | | | 3 | 10250T1323 | 3 | 10250T3023 |
| | | | 2 | 10250T1332 | 2 | 10250T3032 |
| | | | 3 | 10250T1333 | 3 | 10250T3033 |
| | | | 2 | 10250T1342 | 2 | 10250T3042 |
| | | | 3 | 10250T1343 | 3 | 10250T3043 |
| | | | 2 | 10250T1352 | 2 | 10250T3052 |
| | | | 3 | 10250T1353 | 3 | 10250T3053 |
| Four-position—40° throw | | 7 | 10250T1367 | 7 | 10250T3067 | |

Notes

- ① Black knob selector switch, cam 1 shown.
- ② M = Maintained. S = Spring return in direction of arrow.
- ③ Field convertible to horizontal mounting or order operator only and separate operator cap.
- ④ For selection of the proper cam and contact block to obtain the proper circuit sequence, see selection instructions and tables on **Pages V7-T1-238, V7-T1-239** and **V7-T1-240**.
- ⑤ Black lever selector switch, cam 3 shown.

Selector Switch Operators without Caps

Operators can be ordered with caps assembled to them by adding the code number from the table on this page to the end of catalog number below.
Example: 10250T4011**KB**

Two-Position Selector Switch Maintained



Selector Switch Operators without Caps

| Positions | Operator Action ① | Cam Code ② | Catalog Number |
|--------------------------|-------------------|------------|-------------------|
| Two-position—60° throw | M ↘ M | 1 | 10250T4011 |
| | M ↘ S | 1 | 10250T4081 |
| Three-position—60° throw | M ↘ M | 2 | 10250T4022 |
| | M ↘ M | 3 | 10250T4023 |
| | S ↘ M | 2 | 10250T4032 |
| | S ↘ M | 3 | 10250T4033 |
| | S ↘ S | 2 | 10250T4042 |
| | S ↘ S | 3 | 10250T4043 |
| Four-position—40° throw | M ↘ S | 2 | 10250T4052 |
| | M ↘ S | 3 | 10250T4053 |
| | M ↘ M | 7 | 10250T4067 |
| | M ↘ M | | |

Knob



Lever



Lever for Use with Maintained Operators



Coin Slot



Operating Caps

| Color | Knob Catalog and Code Number | Lever Catalog and Code Number | Color | Lever ③ Catalog and Code Number | Coin Slot Catalog and Code Number |
|--------|------------------------------|-------------------------------|--------|---------------------------------|-----------------------------------|
| Black | 10250TKB | 10250TLB | Black | 10250TSB | 10250TCB |
| Red | 10250TKR | 10250TLR | Red | 10250TSR | 10250TCR |
| Green | 10250TKG | 10250TLG | Green | 10250TSG | 10250TCG |
| Yellow | 10250TKY | 10250TLY | Yellow | 10250TSY | 10250TCY |
| White | 10250TKW | 10250TLW | White | 10250TSW | 10250TCW |
| Gray | 10250TKA | 10250TLA | Gray | 10250TSA | 10250TCA |
| Blue | 10250TKL | 10250TLL | Blue | 10250TSL | 10250TCL |
| Orange | 10250TKD | 10250TLO | Orange | 10250TSO | 10250TCO |

Notes

- ① M = Maintained. S = Spring return in direction of arrow (R).
- ② For selection of the proper cam and contact block to obtain the proper circuit sequence, see selection instructions and tables on **Pages V7-T1-238, V7-T1-239 and V7-T1-240.**
- ③ Designed for added ingress protection. For use in maintained operators only.

Illuminated Selector Switch Operators

Illuminated Selector Switches without Caps

Two-Position Selector Switch Maintained



Operator without Knob or Lever

| Positions | Operator Action ① | Transformer Type—50/60 Hz 6 Volt #755 Lamp | | | Full Voltage Type—AC or DC ④ Lamps: 6V—#755, 12V—#756, 24V—#757, 48V—#1835, 120/240V—120MB | | |
|--------------------------|-------------------|---|------------|----------------------------------|--|------------|----------------------------------|
| | | Cam Code ② | Voltage | Code Number and Catalog Number ③ | Cam Code ② | Voltage | Code Number and Catalog Number ③ |
| Two-position—60° throw | | 1 | 24 | 10250T5961 | 1 | 6 | 10250T6201 |
| | | | 120 | 10250T5971 | | 12 | 10250T6211 |
| | | | 208 | 10250T6511 | | 24 | 10250T6221 |
| | | | 240 | 10250T5981 | | 48 | 10250T6231 |
| | | | 380 | 10250T5991 | | 120 | 10250T6361 |
| | | | 480 | 10250T6001 | | 240 ⑤ | 10250T6371 |
| Three-position—60° throw | | + 2 or 3 | 24 | 10250T602_ | + 2 or 3 | 6 | 10250T624_ |
| | | | 120 | 10250T603_ | | 12 | 10250T625_ |
| | | | 208 | 10250T652_ | | 24 | 10250T626_ |
| | | | 240 | 10250T604_ | | 48 | 10250T627_ |
| | | | 380 | 10250T605_ | | 120 | 10250T638_ |
| | | | 480 | 10250T606_ | | 240 ⑤ | 10250T639_ |
| | | + 2 or 3 | 24 | 10250T654_ | + 2 or 3 | 6 | 10250T612_ |
| | | | 120 | 10250T620_ | | 12 | 10250T632_ |
| | | | 208 | 10250T655_ | | 24 | 10250T642_ |
| | | | 240 | 10250T656_ | | 48 | 10250T672_ |
| | | | 380 | 10250T657_ | | 120 | 10250T622_ |
| | | | 480 | 10250T658_ | | 240 | 10250T682_ |
| | + 2 or 3 | 24 | 10250T660_ | + 2 or 3 | 6 | 10250T613_ | |
| | | 120 | 10250T621_ | | 12 | 10250T633_ | |
| | | 208 | 10250T661_ | | 24 | 10250T643_ | |
| | | 240 | 10250T662_ | | 48 | 10250T673_ | |
| | | 380 | 10250T663_ | | 120 | 10250T623_ | |
| | | 480 | 10250T664_ | | 240 | 10250T683_ | |
| | + 2 or 3 | 24 | 10250T614_ | + 2 or 3 | 6 | 10250T628_ | |
| | | 120 | 10250T615_ | | 12 | 10250T629_ | |
| | | 208 | 10250T653_ | | 24 | 10250T630_ | |
| | | 240 | 10250T616_ | | 48 | 10250T631_ | |
| | | 380 | 10250T617_ | | 120 | 10250T640_ | |
| | | 480 | 10250T618_ | | 240 ⑤ | 10250T641_ | |
| Four-position—40° throw | | 7 | 24 | 10250T6087 | 7 | 6 | 10250T6327 |
| | | | 120 | 10250T6097 | | 12 | 10250T6337 |
| | | | 208 | 10250T6547 | | 24 | 10250T6347 |
| | | | 240 | 10250T6107 | | 48 | 10250T6357 |
| | | | 380 | 10250T6117 | | 120 | 10250T6427 |
| | | | 480 | 10250T6127 | | 240 ⑤ | 10250T6437 |
| | 600 | 10250T6137 | | | | | |

Notes

- ① M = Maintained. S = Spring return in direction of arrow (R).
- ② For selection of the proper cam and contact block, to obtain the proper circuit sequence, see selection tables on **Pages V7-T1-238, V7-T1-239 and V7-T1-240.**
- ③ Operator includes lens gasket and lens attachment screws.
- ④ Full voltage light units can be used at other than listed voltages by changing lamp. Replacement lamps are listed on **Page V7-T1-269.**
- ⑤ Resistor type. May generate excess heat if used in high density.

Knob



Lever



Illuminated Knobs and Levers

| Color ^① | Knob Code Number and Catalog Number | Lever Code Number and Catalog Number |
|--------------------|-------------------------------------|--------------------------------------|
| Red | 10250TER | 10250FR |
| Green | 10250TEG | 10250TFG |
| Yellow | 10250TEA | 10250TFA |
| Blue | 10250TEL | 10250TFL |
| Clear | 10250TEC | 10250TFC |
| White | 10250TEW | 10250TFW |
| Amber | 10250TEM | 10250TFM |

Joystick Units

Two-Position Joystick



Joystick Units—UL (NEMA) Type 3, 3R, 4, 4X, 12, 13

Operator Position ^②

| | Up | Center | Down | Operator Action ^③ | Contact Type | Mounting Location | | Two-Position Assembled Unit Catalog Number ^④ |
|---|----|--------|------|------------------------------|--------------|-------------------|---|---|
| | | | | | | A | B | |
| X | | | | | 1NC | | | 10250T452-3X |
| 0 | | | | | 1NC | | | |

Notes

- ① Amber, clear and white lenses have a black arrow (pointer), red, green and blue lenses have a white arrow (pointer).
- ② X = closed circuit, 0 = open circuit.
- ③ M = Maintained. S = Spring return in direction of arrow (R).
- ④ Field convertible momentary to maintained or vice versa.

1

Joysticks

Two-Position Joystick Operators

The device mounts in the standard 30.5 mm mounting hole. Allow sufficient panel space for lever movement.

The maximum travel of the knob operator (full up to full down) is 2.2 in (24°) momentary, 2.5 in (30°) maintained, but ample space for lever operation must be allowed. These operators are field convertible from momentary to maintained operation or vice versa.

The use of NC contacts is preferred because they provide positive drive contact opening and a direct relationship between lever movement and affected terminal, i.e., up movement affects the top terminals.

Application Caution

Joystick operators are not recommended on certain DC applications above 24 Vdc which may involve lightly engaging the contacts (teasing) to achieve speed control, positioning, jogging, etc. Excessive arcing and deterioration of the contacts will occur.

Two-Position Joystick Operator



Two-Position Joystick Operators—UL (NEMA) Type 3, 3R, 4, 4X, 12, 13

| Contact Block Limitations | Two-Position Operator Only—AC Applications Only Description ^① | Catalog Number |
|---|---|-------------------|
| Momentary Mode 4NC contact blocks max. 3NO contact blocks max. | Momentary up and down | 10250T452 |
| | Maintained up—momentary down | 10250T4521 |
| | Maintained down—momentary up | 10250T4522 |
| Maintained Mode 2 contact blocks max. | Maintained up and down | 10250T4525 |

Contact Block Operation and Selection

Handle Position ^②

| Up | Center | Down | Contact Block Type ^④ | Mounting Location ^{②③} | | Catalog Number |
|----|--------|------|---------------------------------|---------------------------------|----------|------------------------------|
| | | | | Top A | Bottom B | |
| | | | 1NC | | | 10250T51 |
| | | | 1NC | | | 10250T51 |
| | | | 2LONC (Series) | | | 10250T45 |
| | | | 1NC | | | 10250T3 |
| | | | 1NC | | | 10250T3 |
| | | | 1LONC | | | 10250T45 |
| | | | 1LONC | | | 10250T45 |
| | | | 1NC | | | 10250T44 ^⑤ |
| | | | 1NO | | | 10250T44 ^⑤ |
| | | | 1NC | | | 10250T44 ^⑤ |
| | | | 1NO | | | 10250T44 ^⑤ |

A and B Mounting Location

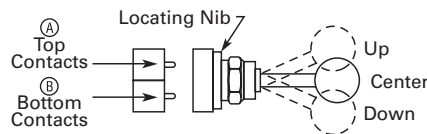

| | | |
|---|--|---|
| <u>Up</u> | <u>Center</u> | <u>Down</u> |
| NC Contact at Top Is Closed, NO at Bottom Is Closed | All NC and NO Contacts Are Open (1/2 Way), Late Opening NC Is Closed | NC Contact at Bottom Is Closed, NO at Top Is Closed |

Notes

- ① Field convertible momentary to maintained or vice versa. To expedite shipment of maintained types, order momentary operator 10250T452 which is a stocked device.
- ② Bolded circuit corresponds to "X-O" circuit selection. X = closed circuit, O = open circuit.
- ③ See above for "A" and "B" mounting location.
- ④ NO = normally open, NC = normally closed, LONC = late opening normally closed.
- ⑤ Four circuits in single block depth—rated 300V max.

Four-Position Joystick Operators

The joystick operated control unit is intended for AC application only. For other use, see **Application** **Caution** on preceding page.

The panel area required for the four-position operator is equivalent to two standard pushbutton operators.

The latch holds the lever in the center position. The trigger latch must be released before lever can move into any position.

Four-Position Joystick Operator



Four-Position Joystick Operator with Latch



Four-Position Joystick Operators—UL (NEMA) Type 3, 3R, 4, 4X, 12, 13

| Contact Block Limitations | Description ① | Catalog Number |
|---|-----------------------------|-------------------|
| Operator Only—AC Application Only | | |
| Four contact blocks max.—two in each position | Four-position—without latch | 10250T451_ |
| | Four-position—with latch | 10250T461_ |
| Hole Plug | | |
| Four contact blocks max.—two in each position | To plug unused hole | 10250TA7 |

Field Conversion—Gate

The factory assembled four-position operator is assembled with a gate arranged for four handle positions.

Handle Positions



Four-Position Gate

Three additional gates, supplied with every operator, allow on the job conversion to three- or eight-position operation as illustrated.

Two-, Three- or Eight-Position Operation

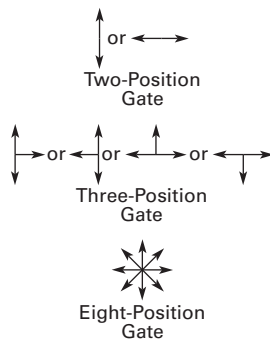

The eight-position gate controls the four functions shown as “Up,” “Down,” “Left” and “Right.” The remaining four diagonal positions each actuate two adjacent functions; for example, “Left Down” actuates both “Left” and “Down.” The operator may be arranged for spring return of handle to center position, or maintained in up to eight positions (see description of maintained position operator).

Adjacent Functions

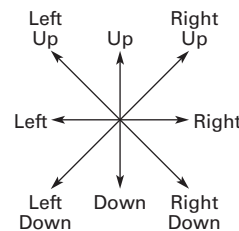

Maintained Position

For maintained position (non-spring return), locate required maintained position or positions of operating lever and add appropriate suffix number to the catalog number selected from the table above.

Maintained Positions

| Maintained Positions | | | | Suffix Number |
|----------------------|------|------|-------|---------------|
| Up | Down | Left | Right | |
| X | — | — | — | 1 |
| — | — | — | — | 2 |
| — | X | — | — | 3 |
| — | — | X | — | 4 |
| — | — | — | — | 5 |
| X | — | X | — | 6 |
| X | — | — | X | 7 |
| — | X | X | — | 8 |
| — | X | — | X | 9 |
| — | — | X | X | 10 |
| X | X | X | — | 11 |
| X | X | — | X | 12 |
| X | — | X | X | 13 |
| — | X | X | X | 14 |
| X | X | X | X | 15 |

On an eight-position gate, when an adjacent vertical and horizontal position are both maintained, the included diagonal position is also maintained.

Note

① Momentary operators—spring return to center. For maintained operators add suffix code from table on this page. Example: 10250T451**10**. Operator without latch, maintained in left and right positions.

1

Contact Block Operation

Contact blocks mount directly to the back of the operator. For reliable operation, the maximum number of contact blocks that should be installed behind each operator lever is two (four total).

The figure below identifies the circuits activated by each of the eight possible lever positions. Contact block plungers 1, 2, 3, 4 are depressed (change state) when handle is in the position indicated by arrows below.

Circuit Activation

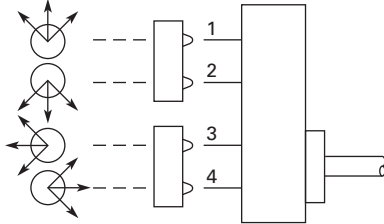

Note: Joystick in its resting state, center position, does not activate contact block plungers.

Ordering Example:

Suppose you are looking for a four-position momentary joystick without a latch and the following circuit arrangements. X = Closed Circuit, O = Open Circuit.

Example Circuit Arrangements

| Circuit | Up | Down | Left | Right |
|---------|----|------|------|-------|
| 1st | X | X | X | X |
| 2nd | X | O | O | X |

The contact blocks and their mounting locations would be as follows:

Example Contact Blocks and Locations

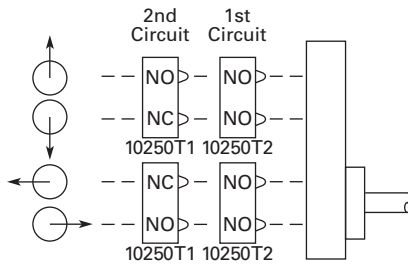

A complete bill of material for this example would include:

Example Order

| Qty. | Catalog Number |
|------|----------------|
| 1 | 10250T451 |
| 2 | 10250T2 |
| 2 | 10250T1 |

Blank Legend Plates for Joystick Operators

When ordering engraved legend plates, order by catalog number and insert the following into order notes:

- Legend required
- Size of characters: 3/16, 1/8, 3/32 in (4.8, 3.2, 2.4 mm)
- Location by letter (A–N)

Locations K and M can accommodate up to two lines horizontally; L and N up to two lines vertically.

Maximum number of characters:

- Horizontal
3/16 in—13, 1/8 in—14, 3/32 in—19
- Vertical
3/16 in—10, 1/8 in—13, 3/32 in—14

Ordering Example:

Two-position legend plate to be marked “UP” “DOWN.”

Catalog No. **10250TJ2S4STAMP**

Letter Size: 3/16 in (4.8 mm)

Pos. K—UP

Pos. M—DOWN

Two-Position

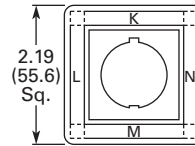

Catalog Number

Blank Plate

10250TJS3

Engraved Plate

10250TJS3STAMP

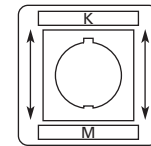

Catalog Number

| Blank Plate | Catalog Number |
|----------------|----------------|
| 10250TJS3 | 10250TJS4 |
| Engraved Plate | Catalog Number |
| 10250TJS3STAMP | 10250TJS4STAMP |

Four-Position

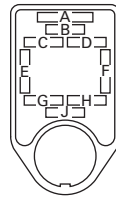

Catalog Number

Blank Plate

10250TJS1

Engraved Plate

10250TJS1STAMP

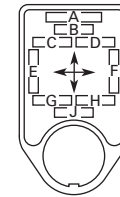

Catalog Number

| Blank Plate | Catalog Number |
|----------------|----------------|
| 10250TJS1 | 10250TJS2 |
| Engraved Plate | Catalog Number |
| 10250TJS1STAMP | 10250TJS2STAMP |

Roto-Push Units

Two-Position Momentary

Complete assembled two-position Roto-Push® Units are listed below. These operators have black flush buttons and are arranged for vertical mounting. Order legend plates separately.

Mounting Location

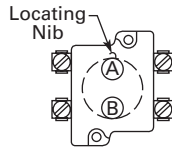

Roto-Push—Black Flush Button



Roto-Push Units—UL (NEMA) Type 3, 3R, 4, 4X, 12, 13

| Typical Applications (Most Common Examples) | Operator Position ① | | Collar Right | | Contact Type | Mounting Location | | Catalog Number ② |
|--|---------------------|-----------|--------------|-----------|--------------|-------------------|---|------------------|
| | Collar Left | Depressed | Normal | Depressed | | A | B | |
| Two-Position FORWARD/REVERSE; HIGH/LOW; OPEN/CLOSE; UP/DOWN; etc. | Normal | Depressed | Normal | Depressed | 1NO | ⎓ | | 10250T2411-2 |
| | 0 | 0 | 0 | X | 1NO | | ⎓ | |
| JOG/RUN; MAN./AUTO; etc. | Normal | Depressed | Normal | Depressed | 1NO | ⎓ | | 10250T24111-2 |
| | 0 | X | 0 | X | 1NO | | ⎓ | |
| RUN/JOG; START/JOG; etc. | Normal | Depressed | Normal | Depressed | 1NO | ⎓ | | 10250T24111-1 |
| | X | X | 0 | 0 | 1NC | | ⎓ | |
| SAFE/RUN; etc. | Normal | Depressed | Normal | Depressed | 1NO | ⎓ | | 10250T2415-2 |
| | 0 | 0 | 0 | X | 1NO | | ⎓ | |
| | | | | | | | | |
| | | | | | | | | |

Two-Position Latched

The two-position Roto-Push Latch Unit is fully assembled and only requires a legend plate for a great variety of applications. When the selector collar is in the extreme left position, the button is in the free or normal position and can be operated as a standard pushbutton. Rotating the collar to the

extreme right position automatically depresses and latches the button in the depressed position. The white filled groove in the button indicates the selector collar position. The selector collar has spring return to the left position except when in the extreme right latched position.

Red Long



Rotates to a Latch-Out Mode

| Color and Type of Button | Contact Block | Vertical Mounting Catalog Number |
|--------------------------|---------------|----------------------------------|
| Red long | 1NC | 10250T72 |
| | 2NC | 10250T73 |

Notes

- ① X = closed circuit, 0 = open circuit.
- ② Roto-Push assembled with contact blocks.

Roto-Push Operators

Roto-Push Components

A Roto-Push control unit combines the function of a pushbutton and a selector switch. The contacts are operated by the combined action of rotating the outer collar and pushing a button contained in the collar.

In selecting the cam and contact blocks for the listed function, the analysis involves considering the function with the collar rotated to the given position with the button free (designated as “N”) and then in that same position with the button depressed (designated “D”). This is done for each rotational position of the collar.

When Ordering Specify

- Catalog number of operator with cam code suffix from tables below and on following pages, Example: 10250T2411.
- Catalog number(s) for contact blocks and legend plates if required.
- To select the cam and contact blocks needed for two-position and three-position switches, use the tables on following pages.

Operator and Cam



Operator and Cam

| Color and Type of Button | Cam Code No. Select from Tables | Vertical Mounting Catalog and Code Number | Horizontal Mounting Catalog and Code Number |
|--------------------------|---------------------------------|---|---|
| Black flush | + 1 to 18 | 10250T241_ | 10250T251_ |
| Red flush ^① | | 10250T242_ | 10250T252_ |
| Green flush | | 10250T243_ | 10250T253_ |
| Black long | | 10250T261_ | 10250T271_ |
| Red long ^① | | 10250T262_ | 10250T272_ |
| Green long | | 10250T263_ | 10250T273_ |

Two-Position Roto-Push Operator—Rotates to a Latch-Out Mode Special Rotor Latch

This differs from the other Roto-Push operators in that as the collar is rotated to the right it depresses the button and releases the button when rotated left. But the button in the released position can be momentarily pushed independent of the collar or

its position. As the button is depressed by rotating the collar, the button also rotates and indicates its mode by a white line on the button face. This button can be used as an emergency stop or latched stop.

Special Roto Latch— Red Long Button











































Special Rotor Latch— UL (NEMA) Type 3, 3R, 4, 4X, 12, 13

| Color and Type of Button | Vertical Mounting Catalog Number |
|--------------------------|----------------------------------|
| Red long | 10250T3213 |
| Black long | 10250T3214 |

Note

^① Not to be used for emergency stop application.

Cam and Contact Block Selection for Two-Position Roto-Push

| Combination Number | Collar Position | | Circuit Sequence ^① | | Cam Code 1 | Cam Code 2 | Cam Code 3 | Cam Code 4 | Cam Code 5 | Cam Code 6 |
|--------------------|-----------------|---|-------------------------------|---|--|--|------------|--|--|--|
| | N | D | N | D | | | | | | |
| 1 | 0 | 0 | 0 | X | A  NO | A  NO | — | — | A  NO | — |
| 2 | 0 | 0 | X | 0 | — | — | — | A  NO B  NO | A  NO B  NO | — |
| 3 | 0 | 0 | X | X | — | — | — | — | B  NO | A  NO |
| 4 | 0 | X | 0 | 0 | B  NO | A  NO B  NO | — | — | — | A  NO B  NO |
| 5 | 0 | X | 0 | X | A  NO B  NO | B  NO | — | A  NO | — | — |
| 6 | 0 | X | X | 0 | — | — | — | — | — | — |
| 7 | 0 | X | X | X | — | — | A or B NO | B  NO | — | B  NO |
| 8 | X | 0 | 0 | 0 | — | — | A or B NC | B  NC | — | B  NC |
| 9 | X | 0 | 0 | X | — | — | — | — | — | — |
| 10 | X | 0 | X | 0 | A  NO B  NO | B  NO | — | A  NO | — | — |
| 11 | X | 0 | X | X | B  NO | A  NO B  NO | — | — | — | A  NO B  NO |
| 12 | X | X | 0 | 0 | — | — | — | — | B  NO | A  NO |
| 13 | X | X | 0 | 0 | — | — | — | A  NO B  NO | A  NO B  NO | — |
| 14 | X | X | X | 0 | A  NO | A  NO | — | — | A  NO | — |

Series and Parallel Connections

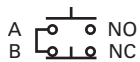

Series Connection



Parallel Connection

The connections are not made at the factory. They are illustrated in the selection table as requirements, but must be made on the job.

Circuit Location

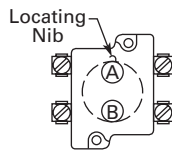

Letters "A" and "B" represent the locations which the two circuits of a contact block will occupy in relation to the locating nib of the operator.

Note

① N = Button in free or normal position. D = Button depressed.

Cam and Contact Block Selection for Two-Position Roto-Push, continued

| Combination Number | Collar Position | | Circuit Sequence ① | | Cam Code 10 | Cam Code 11 | Cam Code 12 | Cam Code 13 | Cam Code 14 |
|--------------------|-----------------|---|--------------------|---|-------------|-------------|-------------|-------------|-------------|
| | N | D | N | D | | | | | |
| 15 | 0 | 0 | 0 | X | — | | — | — | — |
| 16 | 0 | 0 | X | 0 | — | | A | A or B NC | A |
| 17 | 0 | 0 | X | X | B | B | — | — | — |
| 18 | 0 | X | 0 | 0 | A | | — | — | B |
| 19 | 0 | X | 0 | X | — | A | B | — | — |
| 20 | 0 | X | X | 0 | — | — | — | — | A |
| 21 | 0 | X | X | X | A | A | A | — | — |
| 22 | X | 0 | 0 | 0 | A | A | A | — | — |
| 23 | X | 0 | 0 | X | — | — | — | — | A |
| 24 | X | 0 | X | 0 | — | A | B | — | — |
| 25 | X | 0 | X | X | A | | — | — | B |
| 26 | X | X | 0 | 0 | B | B | — | — | — |
| 27 | X | X | 0 | 0 | — | | A | A or B NO | A |
| 28 | X | X | X | 0 | — | | — | — | — |

Series and Parallel Connections



Series Connection



Parallel Connection

The connections are not made at the factory. They are illustrated in the selection table as requirements, but must be made on the job.

Note

① N = Button in free or normal position. D = Button depressed.

Circuit Location

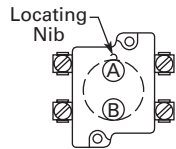

Letters “A” and “B” represent the locations which the two circuits of a contact block will occupy in relation to the locating nib of the operator.

Cam and Contact Block Selection for Three-Position Roto-Push

| Combination Number | Collar Position | | | | | | Cam Code 7 | Cam Code 8 | Cam Code 9 | Cam Code 15 ^② | Cam Code 16 | Cam Code 17 | Cam Code 18 |
|--------------------|-----------------|---|---|---|---|---|------------|------------|------------|--------------------------|-------------|-------------|-------------|
| | N | D | N | D | N | D | | | | | | | |
| 1 | 0 | 0 | 0 | 0 | 0 | X | | | — | | | — | |
| 2 | 0 | 0 | 0 | 0 | X | X | — | — | | — | — | | — |
| 3 | 0 | 0 | 0 | X | 0 | 0 | — | — | | — | — | — | |
| 4 | 0 | 0 | 0 | X | 0 | X | — | — | — | — | — | — | |
| 5 | 0 | 0 | 0 | X | X | X | — | — | | — | — | — | — |
| 6 | 0 | 0 | X | X | 0 | 0 | — | | — | — | — | — | — |
| 7 | 0 | 0 | X | X | 0 | X | — | | — | — | — | — | — |
| 8 | 0 | 0 | X | X | X | 0 | | — | — | — | — | — | — |
| 9 | 0 | 0 | X | X | X | X | | — | — | — | — | — | — |
| 10 | 0 | X | 0 | 0 | 0 | 0 | | | — | | | | |
| 11 | 0 | X | 0 | 0 | 0 | X | | — | — | | | — | — |
| 12 | 0 | X | 0 | 0 | X | X | — | — | — | — | — | | — |
| 13 | 0 | X | 0 | X | 0 | 0 | — | — | — | — | — | — | |
| 14 | 0 | X | 0 | X | 0 | X | — | — | — | — | — | — | |
| 15 | 0 | X | X | X | 0 | 0 | — | | — | — | — | — | — |
| 16 | 0 | X | X | X | 0 | X | — | | — | — | — | — | — |
| 17 | 0 | X | X | X | X | X | | — | — | — | — | — | — |

Series and Parallel Connections



Series Connection



Parallel Connection

The connections are not made at the factory. They are illustrated in the selection table as requirements, but must be made on the job.

Circuit Location

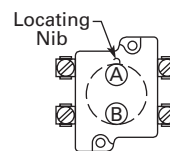

Letters "A" and "B" represent the locations which the two circuits of a contact block will occupy in relation to the locating nib of the operator.

Notes

① N = Button in free or normal position. D = Button depressed.

② Limited to 4 contact blocks. See Note on **Page V7-T1-266**.

Cam and Contact Block Selection for Three-Position Roto-Push, continued

| Combination Number | Circuit Sequence ^① | | | | | | Cam Code 7 | Cam Code 8 ^② | Cam Code 9 | Cam Code 15 | Cam Code 16 | Cam Code 17 | Cam Code 18 |
|--------------------|-------------------------------|---|---|---|---|---|------------|-------------------------|------------|-------------|-------------|-------------|-------------|
| | N | D | N | D | N | D | | | | | | | |
| 18 | X | 0 | 0 | 0 | 0 | 0 | | — | — | — | — | — | — |
| 19 | X | 0 | 0 | 0 | X | X | — | A | — | — | — | — | — |
| 20 | X | 0 | 0 | 0 | X | 0 | — | A | — | — | — | — | — |
| 21 | X | 0 | X | X | 0 | 0 | — | — | — | — | — | A | — |
| 22 | X | 0 | X | X | X | X | | A | — | — | A | B | A |
| 23 | X | 0 | X | X | X | 0 | A | — | — | — | A | — | — |
| 24 | X | 0 | X | 0 | X | 0 | — | — | — | A | — | — | A |
| 25 | X | 0 | X | 0 | X | X | — | — | — | A | — | — | A |
| 26 | X | X | 0 | 0 | 0 | 0 | B | — | A | — | — | — | — |
| 27 | X | X | 0 | 0 | 0 | X | | — | — | — | — | — | — |
| 28 | X | X | 0 | 0 | X | 0 | — | B | — | — | — | — | — |
| 29 | X | X | 0 | 0 | X | X | — | A | B | — | — | — | — |
| 30 | X | X | X | X | 0 | 0 | — | — | B | — | — | A | — |
| 31 | X | X | X | X | X | 0 | A | B | — | — | B | — | A |
| 32 | X | X | X | 0 | X | 0 | — | — | — | B | — | — | B |
| 33 | X | X | X | 0 | X | X | — | — | — | A | — | — | A |

Series and Parallel Connections

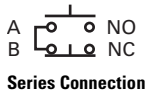

The connections are not made at the factory. They are illustrated in the selection table as requirements, but must be made on the job.

Circuit Location

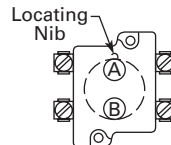

Letters "A" and "B" represent the locations which the two circuits of a contact block will occupy in relation to the locating nib of the operator.







Notes

- ① N = Button in free or normal position. D = Button depressed.
- ② Limited to 4 contact blocks. See Note on **Page V7-T1-266**.

Accessories

Padlocks not included with padlocking attachments. For operators with built-in padlock attachment, see **Page V7-T1-220**.

Accessories

| | Description | Catalog Number |
|---|---|----------------|
| Padlock Attachments | | |
|  | 10250TA2 Padlocking Attachment for Flush Pushbutton Operators Permits locking NC contacts in open position with 1/4 in padlock. Will not lock NO contact. | 10250TA2 |
|  | 10250TA26 Padlocking Attachment for Use with Extended Pushbutton Permits locking NC contacts in open position with 1/4 in padlock. | 10250TA26 |
|  | 10250TA36 Padlocking Cover Guard Cover locked over flush button makes it inaccessible or on extended button locks NC contacts open. Takes 1/4 in shank size padlock. | 10250TA36 |
|  | 10250TA38 Padlock Hasp or Flip-Up Guard When used with a 1/4 in padlock, makes flush and long button and knob selector switch inaccessible, but not locked down. Without the padlock, it is a flip-up guard. Padlock hasp can be removed before assembly. | 10250TA38 |
|  | 10250TA63 Padlocking Attachment for Use with Flexible Weather Resistant Boot Used on long button operators. Stainless steel. Use only for locking NC contacts open. | 10250TA63 |
|  | 10250TA64 Padlock Attachment For use with illuminated pushbuttons and maintained push-pull operators having standard button or lens only. Use 1/4 in padlock. Locks in down position only. | 10250TA64 |
|  | 10250TA11 Padlocking Attachment for Non-Illuminated Knob Selector Switches Provision for up to 5, 1/4 in padlocks. | 10250TA11 |







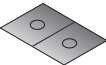

Accessories, continued

| | Description | Catalog Number |
|--|---|--------------------|
| Shrouds and Guards | | |
| 10250TA6  | Shroud for Mushroom Head Operator Prevents accidental operation. (Not for push-pull operators.) | 10250TA6 |
| 10250TA12  | Extended Retaining Nut Replaces standard nut and provides guard for flush head pushbutton operators. | 10250TA12 |
| 10250TA15  | Guard for Illuminated Pushbutton | 10250TA15 |
| 10250TA56_  | Shroud For jumbo mushroom head operator. Gray | 10250TA56 |
| | Yellow | 10250TA56Y |
| 10250ED1241  | Half Shroud —Yellow For jumbo mushroom head operator. | 10250ED1241 |
| 10250TA101  | Fingerproof Shroud —10 per package Fits new style contact blocks and light units. | 10250TA101 |
| Boots | | |
| 10250TA_  | Flexible Weather Resistant Boot For use with button operators (extended buttons preferred). Temperature to –25°F (–32°C). (See Page V7-T1-259 for 10250TA96 Tightening Tool.) Black | 10250TA3 |
| | Red | 10250TA4 ① |
| | Green | 10250TA10 |
| 10250TA25  | Transparent Boot For regular illuminated pushbutton operators and PresTest— Temperature to –38°F (–39°C). ② | 10250TA25 |
| 10250TA4_  | Boot for Flush Pushbutton Clear | 10250TA46 |
| | Black | 10250TA47 |
| | Red | 10250TA48 |
| | Green | 10250TA49 |

Notes

- ① Should not be used on flush button for STOP function.
- ② Not suitable for single contact block depth cast enclosure. Cover is too thick.

Accessories, continued

| | Description | Catalog Number |
|---|---|--------------------|
| Hardware and Kits | | |
| 10250TK3  | Thrust Washers — To meet Ford Motor Co. mounting specifications. | 10250TK3 |
| 10250TK5  | Contact Block Tape Seal — Seals plunger openings on last contact block. Order in multiples of 10 pieces. | 10250TK5 |
| 56-9337  | Selector Switch Operator Gasket — Seals out dust from getting in-between the cam and contact block plungers. Supplied as standard with all selector switches. | 56-9337 |
| 10250TA3  | Special Retaining Nut — To accommodate thick panel: Indicating lights | 10250TA30 |
| | PresTest, pushbuttons and selector switches | 10250TA31 |
| 10250TA62  | Terminal Block — Two terminals, each will accommodate two wire terminations. | 10250TA62 |
| 10250TA8  | Spacer Ring — Used when legend plate is not required. | 10250TA8 |
| 10250TA79  | Stacking Screw — Replaces transformer mounting screws on indicating light so terminal block 10250TA62 can be mounted to light to support and connect a series resistor. This screw also fits all contact blocks. Order in multiples of 10. | 10250TA79 |
| 10250TA2  | Base Mounting Spacers ①— Equivalent to contact block in depth (one block deep). | 10250TA22 |
| | Complete with screws, washers, etc. (two block deep). | 10250TA23 |
| 10250TKG  | Grounding Kits — Kits consist of a ring connector and a #6 screw for mounting connector to rear of contact block mounting screw. All components except standard indicating lights and PresTest indicating lights. | 10250TKG1 |
| | Standard indicating lights | 10250TKG2 ② |
| | PresTest indicating lights | 10250TKG3 ② |
| 10250TA7  | Contact Block Terminal Jumpers — Available in multiples of 100 only. Terminal to terminal—within block (short) | |
| | 100 per pkg. | 10250TA70 |
| | 1000 per pkg. | 10250TA70-2 |
| | Terminal to terminal—block to block (long) | |
| | 100 per pkg. | 10250TA71 |
| | 1000 per pkg. | 10250TA71-2 |

Notes

- ① Component only. Not to be used for custom built (factory assembled) stations.
- ② Not suitable for single contact block depth cast enclosure. Cover is too thick.







Accessories, continued

| | Description | Catalog Number |
|---|--|---------------------|
| Special Operators and Attachments | | |
|  | 10250TA5 Wobble Stick Complete with retaining nut—fits standard button. | 10250TA5 |
|  | 10250TA14 Lever Operator For use with two vertically mounted flush pushbuttons. | 10250TA14 |
|  | 10250TA Maintained Contact Attachment Release Button Assembly ^① Mechanically interlocks with another pushbutton and contact block (not included). Provides mode indication. Minimum hole centers 1.62 in (41.1 mm), maximum 2.313 in (58.8 mm). | |
| | Black | 10250TA17 |
| | Red | 10250TA18 |
| | Green | 10250TA19 |
| | Yellow | 10250TA20 |
| | Same with Long Button—Black | 10250TA39 |
|  | 10250TA1 Maintained Contact Attachment ^① Mechanically interlocks two buttons and provides position indication for one. Use with two pushbutton operators and one or more contact blocks. | 10250TA1 |
|  | 10250TA13 Roto-Push Lever Operator — Used to provide lever operation for Roto-Push operators. | 10250TA13 |
| Special Light Modules | | |
|  | 10250TA79 Master Test (Dual Input) Module — Internal Form C relay suitable for either AC or DC applications. Total electrical isolation between monitored and test circuit. Fits all illuminated 10250T, E22, E30 and E34 devices. | |
| | 48 Vdc | 10250TMT8 |
|  | 10250TFL Flasher Module — Changes any AC illuminated device to a controlled flashing light. Fits 10250T, E30 and E34 devices. | |
| | 24V | 10250TFL2 |
| | 120V | 10250TFL1 |
|  | 10250ED986-4 Flashing Incandescent Lamp — For use with 120V transformer type or 6V full voltage type indicating lights including PresTest and most E29 devices. | 10250ED986-4 |

Note

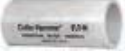
^① Not suitable for single contact block depth cast enclosure. Cover is too thick.

Accessories, continued

| | Description | Catalog Number |
|---|---|-------------------|
| Hole Plugs | | |
|  | 10250TA7 Plug — For unused holes—steel, painted gray (stainless steel, use E30KT5 , see Page V7-T1-206) | 10250TA7 |
| Tools | | |
|  | 10250TA95 Octagonal 10250T (notched to fit over selector switch lever), E29 and E30 | 10250TA95 |
|  | E22CW E22, E30, E34 and octagonal 10250T (will not fit over selector switch levers) | E22CW |
|  | 10250TA96 Tool for Tightening Boots — Used to install boot Catalog Numbers 10250TA3, A4, A10 and A25. | 10250TA96 |
|  | 10250TA102 10250T, E34 Allen Wrench — Used for removal of jumbo mushroom head. | 10250TA102 |
|  | 10250TA74 Lamp Removal Tools — For transformer type illuminated pushbuttons, push-pull and selector switches. Fits #12 lamp. | 10250TA74 |
|  | E30KV1 For full voltage and resistor type illuminated pushbuttons, push-pull and selector switches and E30. | E30KV1 |
|  | E29KLT Standard indicating lights. Fits #44, #755, #6S6 and #10S6. | E29KLT |

1

Options

Legend Plates

Legend Plates with Standard Markings

The legend plates listed below are sized for all standard commercial enclosures and Eaton’s cast enclosures. For vertical

spacing less than 1.75 in, replace the **S** in the catalog number with **MS**, or the **M** with **P** (except push-pull). No change in price. The smaller

size legend plates, “MS” or “P” size, have limited space for legend.

Square Legend Plate



1/2 Round Legend Plate



For Pushbutton Operators and Indicating Lights—Standard

| Legend | Color of Field | Square ① Catalog Number | 1/2 Round Catalog Number | Legend | Color of Field | Square ① Catalog Number | 1/2 Round Catalog Number |
|--|----------------|----------------------------|-----------------------------|----------|----------------|----------------------------|-----------------------------|
| Blank—see table on Page V7-T1-262. | | | | | | | |
| Letters on Legend Plates Below are 3/16 in High | | | | | | | |
| CLAMP | Black | 10250TS90 | 10250TM90 | OFF | Red | 10250TS24 | 10250TM24 |
| CLOSE | | 10250TS73 | 10250TM11 | ON | Black | 10250TS25 | 10250TM25 |
| DOWN | | 10250TS74 | 10250TM12 | OPEN | | 10250TS26 | 10250TM26 |
| EMERG. STOP | Red | 10250TS13 | 10250TM13 | OUT | | 10250TS27 | 10250TM27 |
| FAST | Black | 10250TS75 | 10250TM14 | POWER ON | | 10250TS80 | 10250TM80 |
| FASTER | | 10250TS87 | 10250TM87 | RAISE | | 10250TS28 | 10250TM28 |
| FEEDER ON | | 10250TS94 | 10250TM94 | READY | | 10250TS86 | 10250TM86 |
| FEEDER OFF | | 10250TS95 | 10250TM95 | RESET | | 10250TS29 | 10250TM29 |
| FORWARD | | 10250TS15 | 10250TM15 | REVERSE | | 10250TS30 | 10250TM30 |
| HIGH | | 10250TS16 | 10250TM16 | RUN | | 10250TS31 | 10250TM31 |
| IN | | 10250TS17 | 10250TM17 | SAFE | | 10250TS85 | 10250TM85 |
| INCH | | 10250TS18 | 10250TM18 | SLOW | | 10250TS32 | 10250TM32 |
| JOG | | 10250TS19 | 10250TM19 | SLOWER | | 10250TS88 | 10250TM88 |
| JOG FOR. | | 10250TS20 | 10250TM20 | START | | 10250TS33 | 10250TM33 |
| JOG REV. | | 10250TS21 | 10250TM21 | STOP | Red | 10250TS34 | 10250TM34 |
| LOW | | 10250TS22 | 10250TM22 | TEST | Black | 10250TS83 | 10250TM83 |
| LOWER | | 10250TS23 | 10250TM23 | TRANSFER | | 10250TS93 | 10250TM93 |
| LUBE-FAIL | | 10250TS92 | 10250TM92 | TRIP | | 10250TS84 | 10250TM84 |
| MOTOR RUN | | 10250TS81 | 10250TM81 | UNCLAMP | | 10250TS91 | 10250TM91 |
| MOTOR STOP | | 10250TS82 | 10250TM82 | UP | | 10250TS35 | 10250TM35 |

Blank Plastic Legend Plates—Square

| Color Lettering | Field | Standard Catalog Number | Jumbo ② Catalog Number | Extra Large Catalog Number |
|-----------------|-------------------|-------------------------|---------------------------|----------------------------|
| Black | White or silver ③ | 10250TSP76 | 10250TLP76 | 10250TEP76 |
| White | Red or black ③ | 10250TSP77 | 10250TLP77 | 10250TEP77 |

Notes

- ① Square legend plates have a satin aluminum field. Color is on lower portion.
- ② Cannot be used on cast enclosures except for top row. Suitable for most sheet metal enclosures.
- ③ If legend plate is to be engraved, specify field color required.

Square Legend Plate



1/2 Round Legend Plate



For Selector Switch and Roto-Push Operators—Standard Size

| Legend | Color of Field | Square ^① Catalog Number | 1/2 Round Catalog Number | Legend | Color of Field | Square ^① Catalog Number | 1/2 Round Catalog Number |
|---|----------------|------------------------------------|--------------------------|---|----------------|------------------------------------|--------------------------|
| Blank—see table on Page V7-T1-262. | | | | | | | |
| 2-Position—5/32 in High Lettering | | | | 3-Position—1/8 in High Lettering | | | |
| FOR. REV. | Black | 10250TS38 | 10250TM38 | AUTO OFF HAND | Black | 10250TS49 | 10250TM49 |
| HAND AUTO | | 10250TS39 | 10250TM39 | FOR. OFF REV. | | 10250TS50 | 10250TM50 |
| HIGH LOW | | 10250TS40 | 10250TM40 | FOR. SAFE REV. | | 10250TS69 | 10250TM69 |
| JOG RUN | | 10250TS41 | 10250TM41 | HAND OFF AUTO | | 10250TS51 | 10250TM51 |
| MAN. AUTO | | 10250TS67 | 10250TM67 | MAN. OFF AUTO | | 10250TS68 | 10250TM68 |
| OFF ON | | 10250TS42 | 10250TM42 | OPEN OFF CLOSE | | 10250TS53 | 10250TM53 |
| OPEN CLOSE | | 10250TS43 | 10250TM43 | RUN SAFE JOG | | 10250TS70 | 10250TM70 |
| RUN JOG | | 10250TS44 | 10250TM44 | UP OFF DOWN | | 10250TS54 | 10250TM54 |
| SAFE RUN | | 10250TS45 | 10250TM45 | ON STOP SAFE | Red | 10250TS71 | 10250TM71 |
| START JOG | | 10250TS46 | 10250TM46 | | | | |
| START STOP | | 10250TS47 | 10250TM47 | | | | |
| UP DOWN | | 10250TS48 | 10250TM48 | | | | |

70 mm Round—Plastic Legend Plate



45 mm and 70 mm Plastic—Round

| Color | Lettering | Field | Catalog Number |
|--------------|-------------|----------------------------|----------------|
| 45 mm | | | |
| Blank | | Yellow or red ^② | 10250TRP78 |
| 70 mm | | | |
| Blank | | Yellow or red ^② | 10250TRP76 |
| Red | EMERG. STOP | Yellow | 10250TRP79 |

For Push-Pull Units ^③

| Legend | Color of Field | Square ^① Catalog Number | 1/2 Round Catalog Number |
|--|----------------|------------------------------------|--------------------------|
| Standard Size—Letters on Legend Plates Below are 3/32 in High | | | |
| PULL START/PUSH STOP | Green/red | 10250TPP2 | 10250TR2 |
| PUSH ON/PULL OFF | Black | 10250TPP5 | 10250TR5 |
| PULL OPEN/PUSH CLOSE | Black | 10250TPP8 | 10250TR8 |
| PULL UP/PUSH DOWN | Black | 10250TPP11 | 10250TR11 |
| Jumbo Size—Letters on Legend Plates Below are 1/8 in High | | | |
| PULL START/PUSH STOP | Green/red | 10250TPP3 | 10250TR3 |
| PULL ON/PUSH OFF | Black | 10250TPP6 | 10250TR6 |
| PULL OPEN/PUSH CLOSE | Black | 10250TPP9 | 10250TR9 |
| PULL UP/PUSH DOWN | Black | 10250TPP12 | 10250TR12 |

Notes

- ① Square legend plates have a satin aluminum field. Color is on lower portion.
- ② If legend plate is to be engraved, specify field color required.
- ③ All push-pull legend plates include the symbols ≠ ∅ in the center of the plate.

1

Legend Plates with Non-Standard Markings

When Ordering Specify

- Catalog number of blank plate phase plus Suffix “STAMP”
- Insert the following into Order Notes: legend, letter size and locations (letters A–W)—combine letters for definitive locations as shown.

Ordering Example:

Catalog No.: **10250TS36STAMP**
 Letter Size: 3/32 in (2.4 mm)
 Pos. A—POWER HOUSE
 Pos. B—START PUMP 1

Legend Characters Available

A B C D E F G H I J K L M N O
 P Q R S T U V W X Y Z / - . , 1
 2 3 4 5 6 7 8 9 0

Legend characters on black and red plates are white—on satin aluminum plates, characters are black.

Blackening Kit

Solution blackens aluminum exposed by engraving process. Must be applied immediately after engraving. 0.3 oz. bottle—sufficient for approximately 1100 legend plates.

Catalog Number: **10250TBK**

Legend Positions

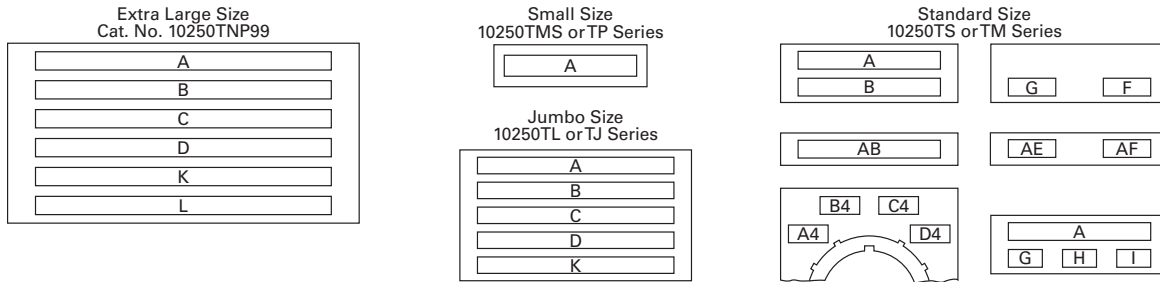

Blank and Custom Engraved Legend Plates

| Style | Color | Small Catalog Number | Standard Catalog Number | Jumbo ^② Catalog Number | Extra Large ^③ Catalog Number | Four-Position Selector Switch | | Push-Pull with Symbols ^① | |
|---------------------|-------------|----------------------|-------------------------|-----------------------------------|---|------------------------------------|-------------------------|-------------------------------------|-----------------------------------|
| | | | | | | Custom ^④ Catalog Number | Standard Catalog Number | Standard Catalog Number | Jumbo ^② Catalog Number |
| Square ^⑤ | Black | 10250TMS36 | 10250TS36 | 10250TL36 | — | 10250TS76 | 10250TS72 | 10250PPP17 | 10250PPP18 |
| | Red | 10250TMS37 | 10250TS37 | 10250TL37 | — | — | — | — | — |
| | Green/red | — | — | — | — | — | — | 10250PPP20 | 10250PPP21 |
| | Satin alum. | — | — | — | 10250TNP99 | — | — | — | — |
| 1/2 Round | Black | 10250TP36 | 10250TM36 | 10250TJ36 | — | — | 10250TM72 | 10250TR17 | 10250TR18 |
| | Red | 10250TP37 | 10250TM37 | 10250TJ37 | — | — | — | — | — |
| | Green/red | — | — | — | — | — | — | 10250TR20 | 10250TR21 |
| | Satin alum. | — | 10250TM89 | 10250TJ89 | — | — | — | — | — |

Maximum Characters per Legend Plate and Approximate Dimensions

| Top (Aluminum and Plastic) | Approximate Dimensions in Inches (mm) | | Style | Character Size 3/32 in High | | 1/8 in High | | 3/16 in High | |
|----------------------------|---------------------------------------|-------------|-----------|-----------------------------|----------------------|-----------------|----------------------|-----------------|----------------------|
| | Width | Height | | Number of Lines | Number of Characters | Number of Lines | Number of Characters | Number of Lines | Number of Characters |
| Small ^⑥ | 1.59 (40.4) | 1.59 (40.4) | Square | 1 | 17 | — | — | — | — |
| | | | 1/2 Round | 1 | 15 | 1 | 12 | 1 | 9 |
| Standard and custom | 1.75 (44.5) | 1.75 (44.5) | Square | 2 | 18 | 2 | 13 | 1 | 9 |
| | | | 1/2 Round | 2 | 15 | 2 | 12 | 1 | 9 |
| Jumbo ^⑦ | 2.19 (55.6) | 2.19 (55.6) | Square | 5 | 23 | 3 | 18 | 2 | 12 |
| | | | 1/2 Round | 5 | 19 | 4 | 15 | 2 | 11 |
| Extra large ^⑧ | 2.44 (62.0) | 2.44 (62.0) | Square | 6 | 25 | 3 | 18 | 3 | 12 |



Notes

- ^① All push-pull legend plates include the symbols ≠ ∅ in the center of the plate.
- ^② Cannot be used on cast enclosures except for top row. Suitable for most sheet metal enclosures.
- ^③ When used to meet Ford Motor Co. specifications, specify engraved legend. Cannot be used on standard cast or sheet metal enclosures.
- ^④ Slightly larger than standard size for legends requiring more space—fits cast enclosures.
- ^⑤ Square legend plates have a satin aluminum field. Color is on lower portion.
- ^⑥ Recommended only when mounting on minimum centers (less than 1-3/4 in [44.5 mm] vertical centers).
- ^⑦ Can be used on top row only of any enclosure.

Enclosures

Die Cast, Polyester and Stainless Steel Enclosures

Enclosures (Case and Cover)—Surface Mounting ^①

| | Number of Elements | One Contact Block Depth Catalog Number | Two Contact Block Depth Catalog Number |
|--|---|--|--|
| Die Cast Enclosure | Die Cast Enclosure—In-Line ^{②③④} NEMA 4, 4X, 12, 13 | | |
|  | 1 | 10250TN1 | 10250TN11 |
| | 2 | 10250TN2 | 10250TN12 |
| | 3 | 10250TN3 | 10250TN13 |
| | 4 | — | 10250TN14 |
| Polyester Enclosure | Polyester ^④—In-Line NEMA 3, 4X, 12 | | |
|  | 1 | — | E34N51 |
| | 2 | — | E34N52 |
| | 3 | — | E34N53 |
| | 4 | — | E34N54 |
| Stainless Steel Enclosure | Stainless Steel ^{④⑤}—In-Line NEMA 4, 4X, 12 | | |
|  | 1 | — | 10250TN33 |
| | 2 | — | 10250TN34 |
| | 3 | — | 10250TN35 |
| | 4 | — | 10250TN36 |

Dimensions, see Page V7-T1-276.

Mounting Instructions

Two-position joystick must be used with two contact block deep enclosures (maximum number of contact blocks = 1). Four-position joysticks cannot be used within these enclosures.

One and Two Contact Block Depth Enclosures



Enclosure Layouts

Top – For Vertical Mounting

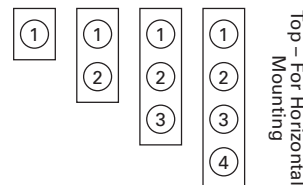

Notes

- ① For spacing increments, see Page V7-T1-264.
- ② All die cast enclosures can be converted to base mounting of contact blocks, with spacers 10250TA22 or 10250TA23. See listing on Page V7-T1-257.
- ③ When used with E30 pushbuttons, only the one element enclosure can be used.
- ④ When used with resistor light units, only the 2 contact block depth enclosure can be used.
- ⑤ 14 gauge, type 304.

Die Cast and Stainless Steel—Flush Mount, Covers Only

Flush Mounting Covers



Covers Only—Flush Mounting

| Number of Elements | Catalog Number | Catalog Number |
|---|---------------------------|---------------------------|
| Flush Die Cast Covers | | |
| | In-Line Deep Cover | In-Line Flat Cover |
| 1 | 10250TF11 | 10250TF1 |
| 2 | 10250TF12 | 10250TF2 |
| 3 | 10250TF13 | 10250TF3 |
| 4 | 10250TF14 | 10250TF4 |
| In-Line Stainless Steel Flush Plates ① | | |
| | With Pullbox | Without Pullbox |
| 1 | 10250TS10 | 10250TS1 |
| 2 | 10250TS11 | 10250TS2 |
| 3 | 10250TS12 | 10250TS3 |
| 4 | 10250TS14 | 10250TS4 |

Dimensions, see Page V7-T1-277.

Spacing Increments

Approximate Dimensions in Inches (mm)

| Type | F | G | H |
|-----------------|-------------|------------------|-------------|
| Die cast | 2.44 (62.0) | 2.5 (63.5) | 1.88 (47.8) |
| Polyester | 1.88 (47.8) | Min. 2.13 (54.1) | 2.25 (57.2) |
| Stainless steel | 1.69 (42.9) | Min. 1.73 (43.9) | 2.25 (57.2) |

Spacing Increments for Enclosures

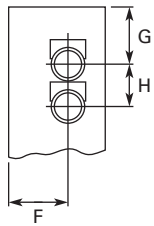

Enclosure Layouts

Top – For Vertical Mounting

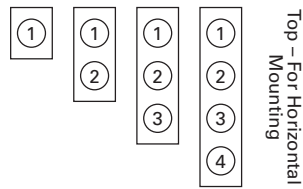

Note

① Not oiltight. NEMA 1 applications only.

Contact Blocks

Standard Contact Blocks

- UL A600/P600 rated
- Color-coded plungers—red/green for NC/NO circuits
- Silver contact tips with “reliability nibs”
- Gray (opaque) or amber (translucent) housings
- Pressure plate or spade terminals
- Fingerproof shrouds (for pressure terminals only)

Logic Level Contact Blocks

- UL A600/P600 rated
- Color-coded plungers
- Inert palladium knife-blade contacts
- Gray (opaque) housings
- Pressure plate or spade terminals

Special Function Contact Blocks

- UL A600/P600 rated
- Color-coded plungers
- Silver contact tips with “reliability nibs”
- Gray (opaque) housings
- Pressure plate terminals only

Special Purpose Contact Block

- Maximum 300V rated
- Black plungers
- Silver contact tips with “reliability nibs”
- Black (opaque) housings
- Pressure plate terminals only
- Fingerproof shrouds not available

Reliability Nibs

Reliability nibs are the hallmark of Eaton’s contact blocks. A pointed silver nib on the contact tip ensures reliable switching from logic level (5V) up to 600V applications. Therefore standard contact blocks can be used for most logic level applications where the contacts are not exposed to any harsh environmental conditions.

Palladium Contacts

Palladium, which is more inert than gold, is well suited for voltages and currents approaching zero and is recommended for applications where environmental conditions are a factor.

Maximum Contact Block Mounting per Operator Type

| Operator | Max. Stack |
|--|------------|
| Pushbuttons | 6 |
| Push-pull operators | 2 |
| Roto-push operators | 4 |
| Two- or three-position selector switches | 6 |
| Four-position selector switches | 4 |
| Joysticks | 4 |

10250T1



Contact Blocks

| Symbol | Circuit | Description ^① | Standard | Spade Terminal ^② | Logic Level | Spade Terminal ^② |
|---|-----------|--|----------------------------------|-----------------------------|----------------------------------|-----------------------------|
| | | | Pressure Terminal Catalog Number | Catalog Number | Pressure Terminal Catalog Number | Catalog Number |
| | 1NC | Stack up to six blocks (six circuits) unless otherwise noted. | 10250T51 | 10250T59 | 10250T51E | 10250T59E |
| | 1NO | Stack up to six blocks (six circuits) unless otherwise noted. | 10250T53 | 10250T60 | 10250T53E | 10250T60E |
| | NO-NC | Stack up to six blocks (12 circuits) unless otherwise noted. | 10250T1 | 10250T40 | 10250T1E | 10250T40E |
| | 2NC | Stack up to six blocks (12 circuits) unless otherwise noted. | 10250T3 | 10250T42 | 10250T3E | 10250T42E |
| | 2NO | Stack up to six blocks (12 circuits) unless otherwise noted. | 10250T2 | 10250T41 | 10250T2E | 10250T41E |
| Special Function Blocks ^③ | | | | | | |
| | LONC | Late opening NC. Stack up to six blocks (six circuits) unless otherwise noted. | 10250T71 ^③ | — | 10250T71E ^③ | — |
| | ECNO-NC | Early closing NO and standard NC. Stack up to six blocks unless otherwise noted. | 10250T47 ^{③④} | — | 10250T47E ^③ | — |
| | ECNO-NO | Early closing NO and standard NO. Stack up to four blocks unless otherwise noted. | 10250T57 ^{③④} | — | 10250T57E ^③ | — |
| | 2LONC | Two late opening NC contacts. Stack up to six blocks unless otherwise noted. | 10250T45 ^③ | — | 10250T45E ^③ | — |
| | LONC-ECNO | Overlapping contacts. Stack up to four blocks unless otherwise noted. | 10250T55 ^{③④} | — | 10250T55E ^③ | — |
| Special Purpose Blocks ^⑤ | | | | | | |
| | 2NO-2NC | Four circuits in single block depth. Rated 300V max. Stack up to four blocks unless otherwise noted. | 10250T44 ^⑤ | — | | |

Notes

- ① All 10250T contact blocks shown are suitable for use on standard 10250T and E34 operators. These contact blocks are not suitable for Class I Division 2 type 10250T or E34 devices.
- ② Contact blocks with spade terminals are limited to a maximum of one contact block per operator and minimum spacing between devices is 2.5 in (63.5 mm). Not suitable for use in 10250T or E34 enclosures. Also available in amber housing. Not available with fingerproof shrouds.
- ③ Special function contact blocks are not suitable for use with roto-push operators, three-position push-pull operators, or four-position selector switches.
- ④ ECNO contact blocks are not suitable for use with two-position joysticks or when operators are used with padlock attachments.
- ⑤ Special purpose 10250T44 contact blocks are not suitable on selector switches or roto-push operators. Okay to use with three-position push-pull operators only on low voltage (30V or less) circuits. Fingerproof shrouds not available.

10250T1CP



Contact Blocks with Fingerproof Shrouds

| Symbol | Circuit | Description ^① | Standard Pressure Terminal ^② Catalog Number | Logic Level Pressure Terminal ^② Catalog Number |
|---|-----------|---|--|---|
| Blank No Plunger | 1NC | Stack up to six blocks (six circuits) unless otherwise noted. | 10250T51P | 10250T51EP |
| Blank No Plunger | 1NO | Stack up to six blocks (six circuits) unless otherwise noted. | 10250T53P | 10250T53EP |
| Blank No Plunger | NO-NC | Stack up to six blocks (12 circuits) unless otherwise noted. | 10250T1P | 10250T1EP |
| Blank No Plunger | 2NC | Stack up to six blocks (12 circuits) unless otherwise noted. | 10250T3P | 10250T3EP |
| Blank No Plunger | 2NO | Stack up to six blocks (12 circuits) unless otherwise noted. | 10250T2P | 10250T2EP |
| Special Function Blocks ^③ | | | | |
| Blank No Plunger | LONC | Late opening NC. Stack up to six blocks (six circuits) unless otherwise noted. | 10250T71P ^④ | 10250T71EP ^④ |
| Blank No Plunger | ECNO-NC | Early closing NO and standard NC. Stack up to six blocks unless otherwise noted. | 10250T47P ^{③④} | 10250T47EP ^④ |
| Blank No Plunger | ECNO-NO | Early closing NO and standard NO. Stack up to four blocks unless otherwise noted. | 10250T57P ^{③④} | 10250T57EP ^④ |
| Blank No Plunger | 2LONC | Two late opening NC contacts. Stack up to six blocks unless otherwise noted. | 10250T45P ^④ | 10250T45EP ^④ |
| Blank No Plunger | LONC-ECNO | Overlapping contacts. Stack up to four blocks unless otherwise noted. | 10250T55P ^{③④} | 10250T55EP ^④ |

Notes

- ① All 10250T contact blocks shown are suitable for use on standard 10250T and E34 operators. These contact blocks are not suitable for Class I Division 2 type 10250T or E34 devices.
- ② To order contact blocks with translucent amber housing, change suffix P to **CP** in catalog number e.g. 10250T51**CP**.
- ③ ECNO contact blocks are not suitable for use with two-position joysticks or when operators are used with padlock attachments.
- ④ Special function contact blocks are not suitable for use with roto-push operators, three-position push-pull operators, or four-position selector switches.

10250T1C



Amber Contact Blocks

| Symbol | Circuit | Description ^① | Standard | Spade Terminal | Logic Level | Spade Terminal |
|---|--------------------------|---|--|-----------------------------|--|-----------------------------|
| | | | Pressure Terminal ^② Catalog Number | Catalog Number ^③ | Pressure Terminal ^② Catalog Number | Catalog Number ^③ |
| | Blank No Plunger 1NC | Stack up to six blocks (six circuits) unless otherwise noted. | 10250T51C | 10250T59C | 10250T51EC | 10250T59EC |
| | Blank No Plunger 1NO | Stack up to six blocks (six circuits) unless otherwise noted. | 10250T53C | 10250T60C | 10250T53EC | 10250T60EC |
| | NO-NC | Stack up to six blocks (12 circuits) unless otherwise noted. | 10250T1C | 10250T40C | 10250T1EC | 10250T40EC |
| | 2NC | Stack up to six blocks (12 circuits) unless otherwise noted. | 10250T3C | 10250T42C | 10250T3EC | 10250T42EC |
| | 2NO | Stack up to six blocks (12 circuits) unless otherwise noted. | 10250T2C | 10250T41C | 10250T2EC | 10250T41EC |
| Special Function Blocks ^③ | | | | | | |
| | Blank No Plunger LONC | Late opening NC. Stack up to six blocks (six circuits) unless otherwise noted. | 10250T71C ^④ | — | 10250T71EC ^④ | — |
| | ECNO-NC | Early closing NO and standard NC. Stack up to six blocks unless otherwise noted. | 10250T47C ^{④⑤} | — | 10250T47EC ^④ | — |
| | ECNO-NO | Early closing NO and standard NO. Stack up to four blocks unless otherwise noted. | 10250T57C ^{④⑤} | — | 10250T57EC ^④ | — |
| | 2LONC | Two late opening NC contacts. Stack up to six blocks unless otherwise noted. | 10250T45C ^④ | — | 10250T45EC ^④ | — |
| | LONC-ECNO | Overlapping contacts. Stack up to four blocks unless otherwise noted. | 10250T55C ^{④⑤} | — | 10250T55EC ^④ | — |

Notes

- ① All 10250T contact blocks shown are suitable for use on standard 10250T and E34 operators. These contact blocks are not suitable for Class I Division 2 type 10250T or E34 devices.
- ② To order amber contact blocks with fingerproof shrouds, change suffix to **CP** in the catalog number e.g. 10250T51**CP**. Not available with spade terminals.
- ③ Contact blocks with spade terminals are limited to a maximum of one contact block per operator and minimum spacing between devices is 2.5 in (63.5 mm). Not suitable for use in 10250T or E34 enclosures. Also available in amber housing. Not available with fingerproof shrouds.
- ④ Special function contact blocks are not suitable for use with roto-push operators, three-position push-pull operators, or four-position selector switches.
- ⑤ ECNO contact blocks are not suitable for use with two-position joysticks or when operators are used with padlock attachments.

Replacement Parts

Replacement Lamps—For 10250T Illuminated Operators

| Mfg. Lamp Type | Voltage | Base Style | Application | Part Number |
|----------------|---------|-----------------|---|---------------------|
| 120MB | 120V | T 3-1/4 bayonet | 10250T resistor indicating light | 28-3044 |
| #267 | 6.3V | T 3-1/4 bayonet | 10250T flasher | 10250ED986-4 |
| #755 | 6.3V | T 3-1/4 bayonet | 10250T transformer, PresTest and full voltage | 28-2202 |
| #756 | 12V | T 3-1/4 bayonet | 10250T full voltage | 28-5184 |
| #757 | 24V | T 3-1/4 bayonet | 10250T full voltage | 28-5185 |
| #1828 | 32V | T 3-1/4 bayonet | 10250T full voltage | 28-5186 |
| #1835 | 55V | T 3-1/4 bayonet | 10250T resistor | 28-5187 |
| NE48 | 120V | T 4-1/2 bayonet | 10250T neon | 28-494 |
| NE51H-R22 | 120V | T 3-1/4 bayonet | 10250T neon | 28-3754 |
| NE51H-R68 | 240V | T 3-1/4 bayonet | 10250T neon | 28-3755 |

Standard LED Lamp



Replacement LED Lamps—For 10250T, E34 and E22 Units

| Voltage | Color | Continuous AC/DC Catalog Number | Flashing AC Catalog Number | DC Catalog Number |
|---------|--------|---------------------------------|----------------------------|---------------------|
| 6–12V | Red | E22LED612RN | E22LED006RAF | E22LED006RDF |
| | Orange | E22LED612ON | E22LED006OAF | E22LED006ODF |
| | Yellow | E22LED612YN | E22LED006YAF | E22LED006YDF |
| | Green | E22LED612GN | E22LED006GAF | E22LED006GDF |
| | Blue | E22LED612BN | E22LED006BAF | E22LED006BDF |
| | White | E22LED612WN | E22LED006WAF | E22LED006WDF |
| 24V | Red | E22LED024RN | E22LED024RAF | E22LED024RDF |
| | Orange | E22LED024ON | E22LED024OAF | E22LED024ODF |
| | Yellow | E22LED024YN | E22LED024YAF | E22LED024YDF |
| | Green | E22LED024GN | E22LED024GAF | E22LED024GDF |
| | Blue | E22LED024BN | E22LED024BAF | E22LED024BDF |
| | White | E22LED024WN | E22LED024WAF | E22LED024WDF |
| 48V | Red | E22LED048RN | E22LED048RAF | E22LED048RDF |
| | Orange | E22LED048ON | E22LED048OAF | E22LED048ODF |
| | Yellow | E22LED048YN | E22LED048YAF | E22LED048YDF |
| | Green | E22LED048GN | E22LED048GAF | E22LED048GDF |
| | Blue | E22LED048BN | E22LED048BAF | E22LED048BDF |
| | White | E22LED048WN | E22LED048WAF | E22LED048WDF |
| 60V | Red | E22LED060RN | E22LED060RAF | E22LED060RDF |
| | Orange | E22LED060ON | E22LED060OAF | E22LED060ODF |
| | Yellow | E22LED060YN | E22LED060YAF | E22LED060YDF |
| | Green | E22LED060GN | E22LED060GAF | E22LED060GDF |
| | Blue | E22LED060BN | E22LED060BAF | E22LED060BDF |
| | White | E22LED060WN | E22LED060WAF | E22LED060WDF |
| 120V | Red | E22LED120RN | E22LED120RAF | E22LED120RDF |
| | Orange | E22LED120ON | E22LED120OAF | E22LED120ODF |
| | Yellow | E22LED120YN | E22LED120YAF | E22LED120YDF |
| | Green | E22LED120GN | E22LED120GAF | E22LED120GDF |
| | Blue | E22LED120BN | E22LED120BAF | E22LED120BDF |
| | White | E22LED120WN | E22LED120WAF | E22LED120WDF |

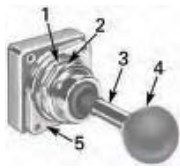

Two-Position Joystick Operator



Flush Head Pushbutton Operator



Mushroom Head Pushbutton Operator



Mushroom Head Operator with Padlock Attachment

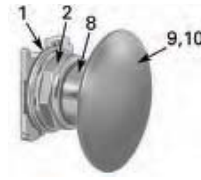

Jumbo Mushroom Head Operator



Knob-Operated Selector Switch Operator

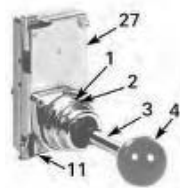

Four-Position Joystick Operator (without Latch)



Illuminated Pushbutton Operator



Full Voltage, Resistor and Transformer Type Illuminated Selector Switch

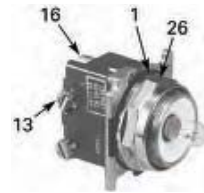

Transformer Type Indicating Light

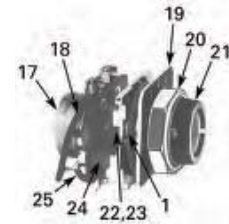

Potentiometers

10250T Style Operator Replacement Parts

| Item No. | Description | No. Req. | Part Number |
|----------|---|----------|----------------------|
| 1 | Gasket | 1 | 16-1548 |
| 2 | Mounting nut | 1 | 15-1530 |
| 3 | Handle | 1 | 24-5045 |
| 4 | Knob | 1 | 53-3157 |
| | Knob (not shown) for joystick operator with latch | 1 | 53-3159 |
| 5 | Common gate (supplied with operator) | 2 | 16-3400 |
| 6 | Set screw (#6-32 x 0.250 in long hollow hex) | 2 | 11-2014 |
| 7 | Mushroom head button (includes [2] Item 6) | 1 | As Req. Below |
| | Black | — | 53-1317 |
| | Red | — | 53-1317-2 |
| | Yellow | — | 53-1317-3 |
| | Green | — | 53-1317-4 |
| | Blue | — | 53-1317-22 |
| 8 | Set screw (#10-32 x 0.250 in long hollow hex) | 2 | 11-544 |
| 9 | Jumbo mushroom head button (aluminum—includes [2] Item 8) | 1 | As Req. Below |
| | Red | — | 53-1317-9 |
| | Black | — | 53-1317-10 |
| | Yellow | — | 53-1317-11 |
| | Green | — | 53-1317-12 |
| 10 | Jumbo mushroom head button (aluminum—red EMERG. STOP) does not include Item 8 | 1 | 53-1349-18 |
| 11 | Position gate: | | |
| | Two-position | 1 | 54-7278 |
| | Three-position | 1 | 54-7173 |
| | Four-position | 1 | 54-12278 |
| | Eight-position | 1 | 54-12279 |
| 12 | Mounting screw (#6-32 x 0.710 in long) | 2 | 10250TA79 |
| | Washer | 2 | 16-2038 |
| 13 | Terminal screw and lug (captive) | Req. | 80-5502KIT |

| Item No. | Description | No. Req. | Part Number |
|----------|--|----------|----------------------|
| 14 | Gasket (supplied with basic unit) | 1 | 32-803 |
| 15 | Round head screw (#4-40 x 0.344 in long) (supplied with basic unit) | 2 | 11-4553 |
| 16 | Mounting screw | 2 | 11-1632 |
| 17 | Simple potentiometer (does not include items 18, 28 or 29) | 1 | As Req. Below |
| | 1,000 ohms | — | 41-782-2 |
| | 2,500 ohms | — | 41-782-3 |
| | 5,000 ohms | — | 41-782-10 |
| | 10,000 ohms | — | 41-782-4 |
| | 25,000 ohms | — | 41-782-5 |
| | 50,000 ohms | — | 41-782-6 |
| 18 | Connector (includes screw and lug) | 2 | 25-1851 |
| 19 | Indicating plate | 1 | As Req. Above |
| | Standard size (without legend) | — | 30-4460 |
| | Large size (specify legend) | — | 10250TR30 |
| 20 | Retaining nut | 1 | 15-1547 |
| 21 | Knob | 1 | 53-1314 |
| | Socket set screw (#6-32 x 0.250 in long) | 2 | 11-2014 |
| 22 | Coupling | 1 | 29-3749-2 |
| 23 | Set screw (#6-32 x 0.188 in long) | 1 | 11-1199 |
| 24 | Spacer | 2 | 56-1066-18 |
| 25 | Connector (includes screw and lug) | 1 | 25-1851-2 |
| 26 | Mounting nut | 1 | 15-1938 |
| 27 | Four-position joystick operating mechanism (complete) | 1 | 24-6565 |
| 28 | Four-position joystick operating mechanism (not shown) (with latch) complete | 1 | 24-6565-2 |
| 29 | Spring loaded latch | 1 | 52-1214-2 |
| 30 | Hand operated latch | 1 | 52-913-3 |

Technical Data and Specifications

Mechanical Ratings

| Description | Specification |
|----------------------------------|-----------------------------------|
| Frequency of Operation | |
| All pushbuttons | 6000 operations/hr. |
| Key and lever selection switches | 3000 operations/hr. |
| Auto-latch devices | 1200 operations/hr. |
| Life | |
| Pushbuttons | 10 x 10 ⁶ operations |
| Contact blocks | 10 x 10 ⁶ operations |
| PresTest units | 10 x 10 ⁶ operations |
| Lever and key selector switches | 0.25 x 10 ⁶ operations |
| Twist to release pushbuttons | 0.3 x 10 ⁶ operations |
| Shock Resistance | |
| Duration | 20 ms ≥5g |

General Specifications

| Description | Specification |
|--|---|
| Climate Conditions | |
| Operating temperature | 1° to 150°F (–17° to 66°C) |
| Storage temperature | –40° to 176°F (–40° to 80°C) |
| Altitude | 6,562 ft (2,000m) |
| Humidity | Max. 95% RH at 60°C |
| Terminals | |
| Marking | NC-NO on the contact block to meet the NEMA requirements. Dual marking system 1–2 for normally closed, 3–4 for normally open to meet BS5472 (Cenelec EN50 005). |
| Clamps | Terminals are saddle clamp type for 1 x 22 AWG (0.34 mm ²) to 2 x 14 AWG (2.5 mm ²) conductors |
| Torque | 7 lb-in (0.8 Nm) |
| Degree of protection against direct electrical contact | IP2X with fingerproof shroud |
| Light Units | |
| Transformers | Will withstand short-circuit for 1 hour per IEC 60997-5-1 |
| Bulbs—average life: | |
| Transformer type | 20,000 hrs. |
| Resistor/direct voltage type | 2500 hrs. minimum at rated voltage |
| LED | 60,000 to 100,000 hrs. |

Electrical Ratings

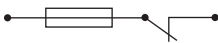
| Description | Specification |
|---|--|
| Insulation | $U_i = 660 \text{ Vac or Vdc}$ |
| Thermal | $I_{th} = 10\text{A}$ |
| Short Circuit Coordination to IEC/EN 60947-5-1 | |
| Rated conditional short circuit current | 1 kA |
| Fuse type | GE power controls TIA 10, red spot type gG, 10A, 660 Vac, 460 Vdc, BS88-2, IEC 60269-2-1 |
|  | |
| UL rating | A600, P600 |
| AC load life duty cycle 1200 operations/hour | |
| 10A | 110V pf 0.4— 1×10^6 operations |
| 5A | 250V pf 0.4— 1×10^6 operations |
| 2A | 600V pf 0.4— 1×10^6 operations |
| Switching capacity | |
| AC 15 rated make/break ($11 \times I_a$ at $1.1 \times U_e$) | |
| 6A | 120V pf 0.3 |
| 4A | 240V pf 0.3 |
| 2A | 660V pf 0.3 |
| DC13 rated make/break ($1.1 \times I_a$ at $1.1 \times U_e$) | |
| 1.0A | 125V L/R ≥ 0.95 at 300 ms |
| 0.55A | 250V L/R ≥ 0.95 at 300 ms |
| 0.1A | 660V L/R ≥ 0.95 at 300 ms |
| 10A | 110V pure resistive |
| Maximum ratings for logic level and hostile atmosphere application | |
| Maximum amperes | 0.5A |
| Maximum volts | 120 Vac/Vdc |

Electrical Ratings—Contact Block

| Description | 50 Vac or 60 Hz | | | | Vdc | | |
|---|-----------------|------|------|------|-------|-----|------|
| | 120 | 240 | 480 | 600 | 24/28 | 125 | 250 |
| Meet or Exceed NEMA Rating Designations A600, A300 and B300 for AC and P600 for DC | | | | | | | |
| Make and emerg. interrupting capacity (amp) | 60 | 30 | 15 | 12 | 5.7 | 1.1 | 0.55 |
| Normal load break (amp) | 6 | 3 | 1.5 | 1.2 | 5.7 | 1.1 | 0.55 |
| Thermal current (amp) | 10 | 10 | 10 | 10 | 5.0 | 5.0 | 5.0 |
| Voltamperes: | | | | | | | |
| Make and emerg. interrupting capacity | 7200 | 7200 | 7200 | 7200 | 138 | 138 | 138 |
| Normal load break | 720 | 720 | 720 | 720 | 138 | 138 | 138 |

Mounting Options

Panel Thickness

- Minimum: 0.06 in (1.6 mm)
- Maximum: 0.25 in (8 mm) including legend plate
- Maximum can be increased to 0.375 in (15.9 mm) using optional retaining nut
 - Indicating light: 10250TA30
 - Pushbutton/selector switch: 10250TA31

Mounting Matrix

| Legend Plate | Dimensions in Inches (mm) | | | |
|--------------|---------------------------|-------------|-------------|-------------|
| | A | B | C | D |
| Small | 1.63 (41.3) | 2.25 (57.2) | 2.25 (57.2) | 1.63 (41.3) |
| Medium | 1.75 (44.5) | 2.25 (57.2) | 2.25 (57.2) | 1.75 (44.5) |
| Large | 2.25 (57.2) | 2.25 (57.2) | 2.25 (57.2) | 2.25 (57.2) |

Mounting Options in Inches (mm)

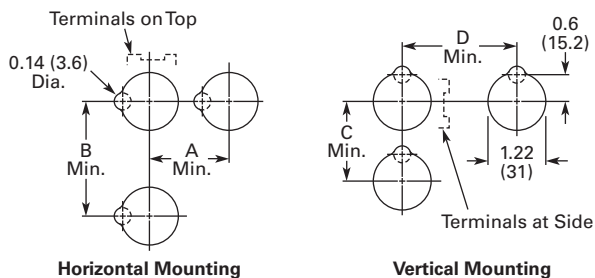

Horizontal mounting means terminals are located top and bottom of contact block. Vertical mounting means terminals are left and right of contact block. This allows close spacing of adjacent operators with easy access to terminals.

Locating nib hole or notch is 0.14 in (3.6 mm) #29 drill.

Drilling Dimensions in Inches (mm)

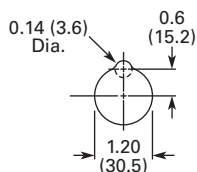

1.9

Pushbuttons and Indicating Lights

30.5 mm Heavy-Duty Watertight/Oiltight—10250T

1

Dimensions

Approximate Dimensions in Inches (mm)

Mechanically Interlocked Pushbutton Operators

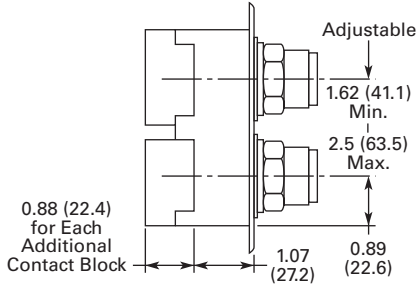

Lockout Pushbutton Operator Padlockable in the Down Position

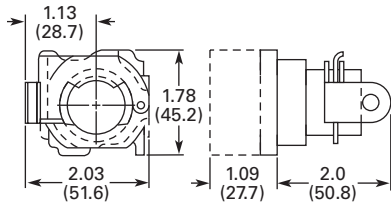

Lockout Pushbutton Operator Padlockable in the Up Position—Mushroom Head

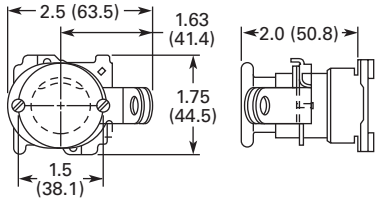

Lockout Pushbutton Operator Padlockable in the Up Position—Jumbo Mushroom Head

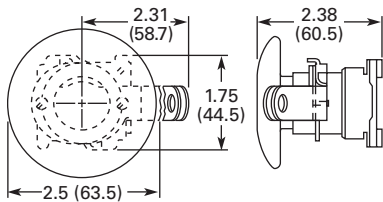

Potentiometer

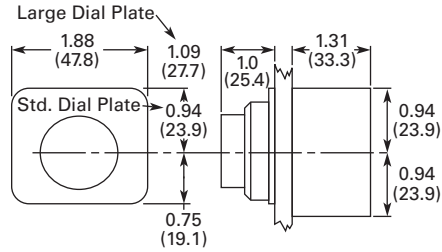

| Potentiometer | A | B | C |
|------------------------|-------------|-------------|-------------|
| 2 watt single | 1.31 (33.3) | 0.94 (23.9) | 0.94 (23.9) |
| 25 watt—up to 25 mohms | 2.38 (60.5) | 1.19 (30.2) | 0.81 (20.6) |
| 50 mohms | 2.56 (65.0) | 1.69 (42.9) | 1.25 (31.8) |

Two-Position Joystick Operator

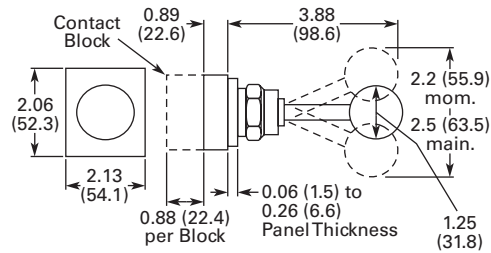

Four-Position Joystick Operator

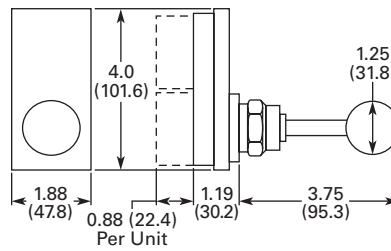

Approximate Dimensions in Inches (mm)

Key Operated Pushbutton Operator

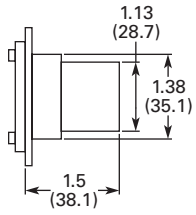

Operator and Cam

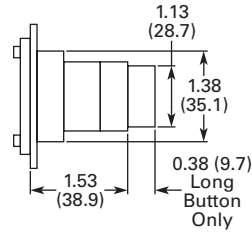

Latch-In, Twist-to-Release Operator Only with Button

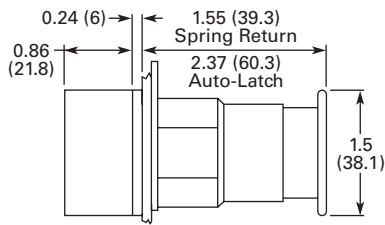

Special Rotor Latch

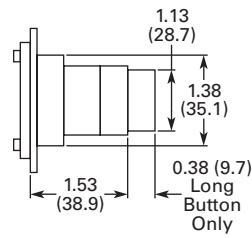

1

Approximate Dimensions in Inches (mm)

Surface Mounting

Die Cast, Polyester and Stainless Steel Enclosures

4 Mtg. Holes — 10-32 Screw Size for
1 – 4 Element Die Cast/
Stainless Steel Enclosure
7/32 Screw Size for
Polyester

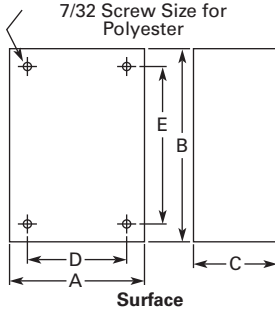

| Number of Elements | Element Arrangement | Wide A | High B | Deep C | Mounting D | E | Conduit Entrance |
|------------------------|---------------------|-------------|---------------|--------------------------|-------------|---------------|------------------|
| Die Cast | | | | | | | |
| 1 | In-line | 3.88 (98.6) | 4.00 (101.6) | 3.00 (76.3) ^① | 2.69 (68.3) | 3.25 (82.6) | 3/4 |
| 2 | | 3.88 (98.6) | 5.88 (149.4) | 3.00 (76.3) ^① | 2.69 (68.3) | 5.13 (130.3) | |
| 3 | | 3.88 (98.6) | 7.75 (196.9) | 3.00 (76.3) ^① | 2.69 (68.3) | 7.00 (177.8) | 1 |
| 4 | | 3.88 (98.6) | 9.63 (244.6) | 3.00 (76.3) ^① | 2.69 (68.3) | 8.88 (225.6) | |
| Polyester | | | | | | | |
| 1 | In-line | 3.81 (96.8) | 6.63 (168.4) | 3.38 (85.9) | 2.94 (74.7) | 4.88 (124.0) | ^② |
| 2 | | 3.81 (96.8) | 6.63 (168.4) | 3.38 (85.9) | 2.94 (74.7) | 4.88 (124.0) | |
| 3 | | 3.81 (96.8) | 8.88 (225.6) | 3.38 (85.9) | 2.94 (74.7) | 7.13 (181.1) | |
| 4 | | 3.81 (96.8) | 11.13 (282.7) | 3.38 (85.9) | 2.94 (74.7) | 9.38 (238.3) | |
| Stainless Steel | | | | | | | |
| 1 | In-line | 3.00 (76.2) | 3.50 (88.9) | 3.00 (76.2) | 1.50 (38.1) | 4.25 (108.0) | ^② |
| 2 | | 3.50 (88.9) | 6.75 (171.5) | 3.00 (76.2) | 1.50 (38.1) | 7.50 (190.5) | |
| 3 | | 3.50 (88.9) | 9.00 (228.6) | 3.00 (76.2) | 1.50 (38.1) | 9.00 (228.6) | |
| 4 | | 3.50 (88.9) | 11.25 (285.8) | 3.00 (76.2) | 1.50 (38.1) | 12.00 (304.8) | |

Notes

- ① Depth given is for two contact block deep stations. One contact block deep stations subtract 3/4 in (19.1 mm).
- ② No conduit entrance holes provided. Drill as required.

Approximate Dimensions in Inches (mm)

Flush Mounting

Die Cast and Stainless Steel Covers Only

4 Mtg. Holes - 10-32 Screw Size
for 1-11 Element Encl, 1/4-20
Screw Size for 12 Element
and Larger

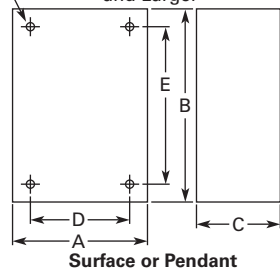

| Number of Elements | Wide A | High B | Deep C | Mounting D | E |
|------------------------|--------------|---------------|---------------|-------------|--------------|
| Die Cast | | | | | |
| 1 | 3.88 (98.6) | 4.00 (101.6) | 0.25 (6.4) ① | 3.50 (88.9) | 3.63 (92.2) |
| 2 | 3.88 (98.6) | 5.88 (149.4) | 0.25 (6.4) ① | 3.50 (88.9) | 5.50 (139.7) |
| 3 | 3.88 (98.6) | 7.75 (196.9) | 0.25 (6.4) ① | 3.50 (88.9) | 6.00 (152.4) |
| 4 | 3.88 (98.6) | 9.63 (244.6) | 0.25 (6.4) ① | 3.50 (88.9) | 9.25 (235.0) |
| Stainless Steel | | | | | |
| 1 | 5.00 (127.0) | 5.00 (127.0) | 2.50 (63.5) ② | 3.25 (82.6) | 1.88 (47.8) |
| 2 | 5.00 (127.0) | 6.88 (174.8) | 2.50 (63.5) ② | 3.25 (82.6) | 3.63 (92.2) |
| 3 | 5.00 (127.0) | 8.63 (219.2) | 2.50 (63.5) ② | 3.25 (82.6) | 5.50 (139.7) |
| 4 | 5.00 (127.0) | 10.50 (266.7) | 2.50 (63.5) ② | 3.25 (82.6) | 7.25 (184.2) |

Notes

- ① Depth given is for flat cover. Deep cover is 3/4 in (19.1 mm) deeper.
- ② Depth given includes pull box.

1.9

Pushbuttons and Indicating Lights

30.5 mm Heavy-Duty Watertight/Oiltight—10250T

1

Approximate Dimensions in Inches (mm)

Flush and Long Pushbutton Half Shroud

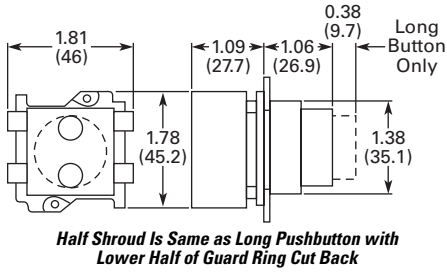

Push-Pull Switch

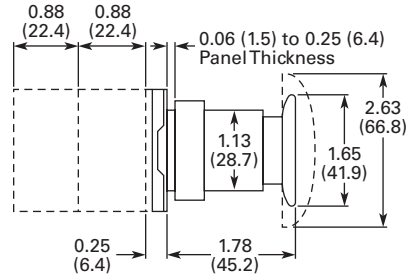

Mushroom and Jumbo Head Pushbutton

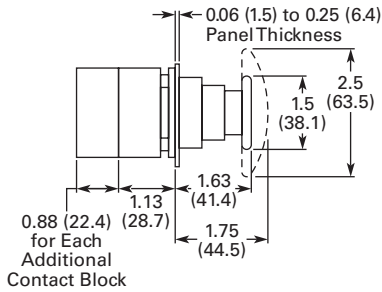

Flush Pushbutton Operator with Padlock Attachment

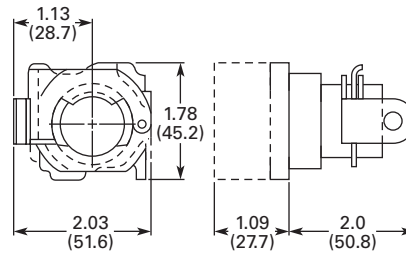

Pushbutton with Cylinder Lock

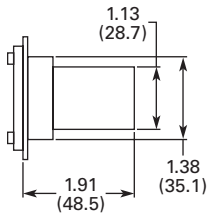

Mushroom Head Pushbutton Operator with Padlock Attachment

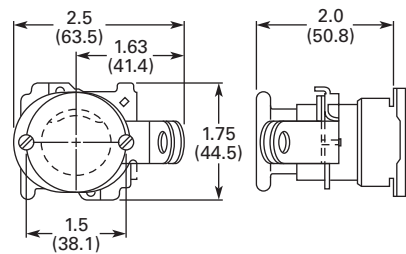

Illuminated Pushbutton

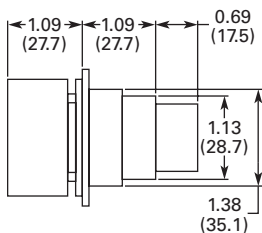

Indicating Light—Transformer Type

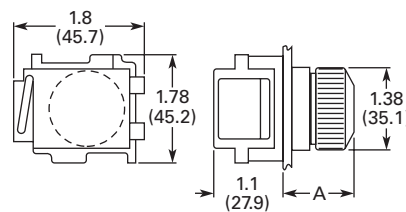

Approximate Dimensions in Inches (mm)

PresTest Indicating Light—Transformer Type

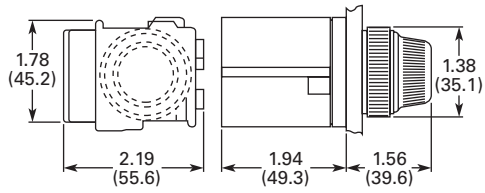

PresTest Indicating Light—Resistor Type

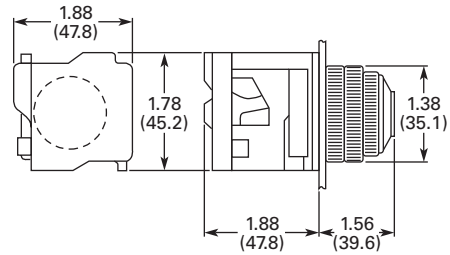

Jumbo Mushroom Head Pushbutton Operator with Padlock Attachment

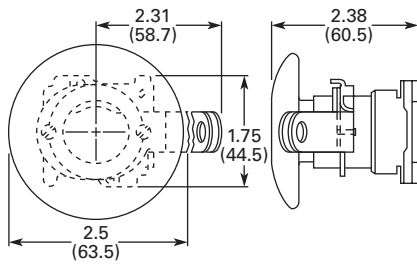

Master Test Indicating Light

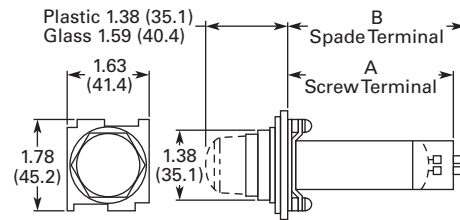

| Description | B | C |
|------------------|--------------|--------------|
| Relay type | 4.38 (111.2) | 4.28 (108.7) |
| Solid-state type | 2.94 (74.7) | 2.88 (73.2) |

Indicating Light—Resistor and Neon Type

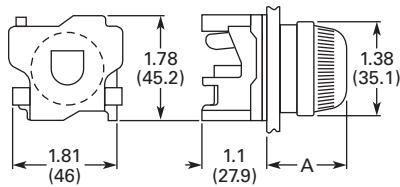

| Lens | A |
|---------|-------------|
| Plastic | 1.38 (35.1) |
| Glass | 1.56 (39.6) |

Potentiometer Shaft

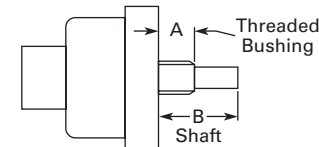

Shaft Dimensions of Potentiometer That C-H Operator Will Accept

| Operator Catalog Number | A | B |
|-------------------------|--------------------------------------|-------------------------------------|
| 10250T330 | 0.38 (9.7) dia. x 0.38 (9.7) long | 0.25 (6.4) dia. x 0.63 (16) long |

1.9

Pushbuttons and Indicating Lights

30.5 mm Heavy-Duty Watertight/Oiltight—10250T

1

Approximate Dimensions in Inches (mm)

Coin Operated Selector Switch

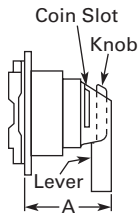

| Operator | Dim. A |
|-----------|-------------|
| Knob | 1.38 (35.1) |
| Lever | 1.50 (38.1) |
| Coin slot | 1.38 (35.1) |

Key Operated Selector Switch

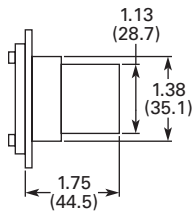

Illuminated Selector Switch

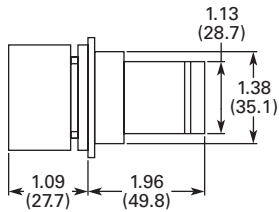

Roto-Push

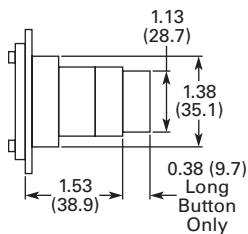

Wobble Stick Catalog No. 10250TA5

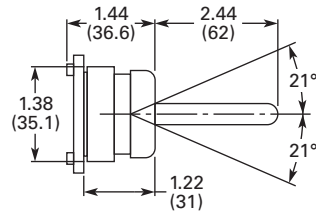

Lever Operator—For Use with Two Vertically Mounted Flush Pushbuttons Catalog No. 10250TA14

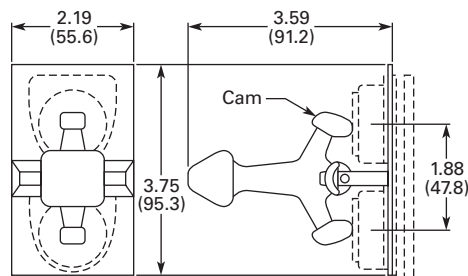

Flexible Boot—For Protecting Flush or Long Pushbutton Catalog No. 10250TA3 Typical

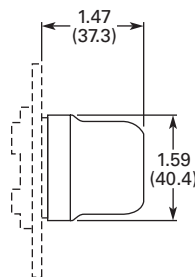

Transparent Flexible Boot—For Illuminated Pushbutton Catalog No. 10250TA25

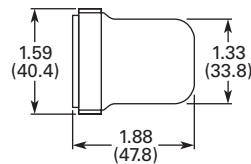

Approximate Dimensions in Inches (mm)

**Padlock Attachment—For Knob Selector Switch
Catalog No. 10250TA11**

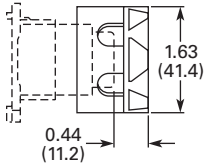

**Padlock Attachment—For Flush Pushbutton
Catalog No. 10250TA2**

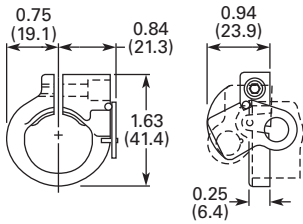

**Padlock Attachment—For Extended Pushbutton
Catalog No. 10250TA26**

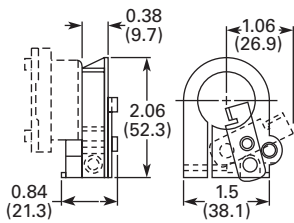

**Maintained Pushbutton
Catalog No. 10250TA66 Typical**

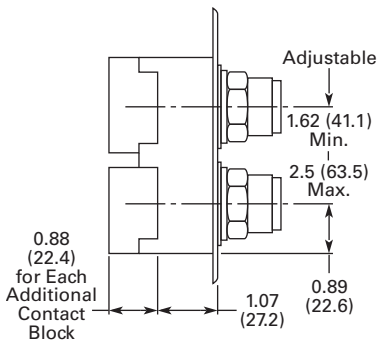

**Maintained Contact Attachment
Catalog No. 10250TA17 Typical**

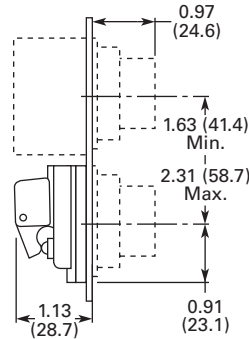

**Padlock Cover Guard for Flush Pushbutton
Catalog No. 10250TA36**

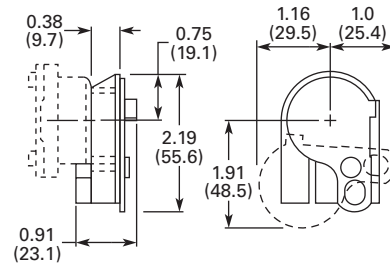

**Padlock Attachment for Maintained Push-Pull Operator
Catalog No. 10250TA64**

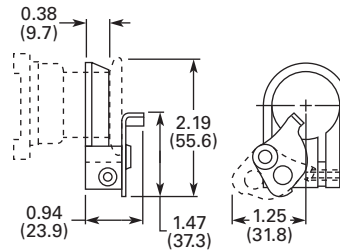

**Protecting Shroud for Jumbo Mushroom Head Button
Catalog No. 10250TA56**

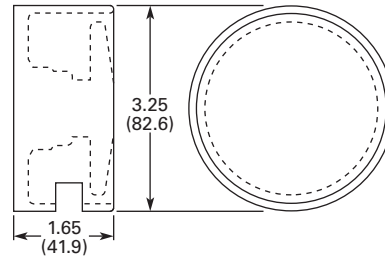

1.9

Pushbuttons and Indicating Lights

30.5 mm Heavy-Duty Watertight/Oiltight—10250T

1

Approximate Dimensions in Inches (mm)

Protecting Shroud for Mushroom Head Button Catalog No. 10250TA6

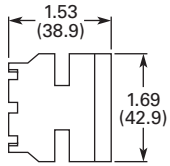

Extended Retaining Nut Catalog No. 10250TA12

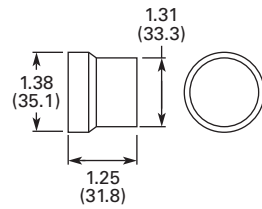

Panel Drilling and Minimum Spacing

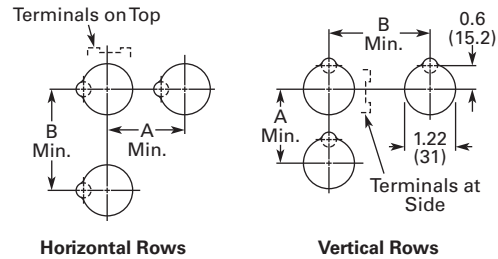

Protecting Shroud for Illuminated Pushbutton Catalog No. 10250TA15

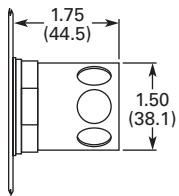

Lever for Roto-Push Operator Catalog No. 10250TA13

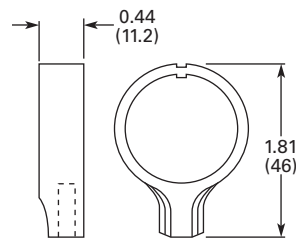

Padlock Hasp or Flip-Up Guard Catalog No. 10250TA38

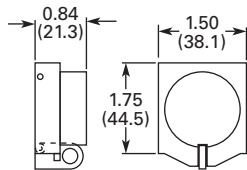

| Legend Plate | A Min. | B Min. |
|---|-------------|-------------|
| 1 or 2 Circuit Contact Blocks | | |
| Small or none | 1.63 (41.4) | 2.25 (57.2) |
| Standard | 1.75 (44.5) | 2.25 (57.2) |
| Jumbo ^① | 2.25 (57.2) | 2.25 (57.2) |
| Extra large | 2.50 (63.5) | 2.60 (66.0) |
| 4 Circuit Contact Block 10250T44 | | |
| Small or none | 1.88 (47.8) | 2.25 (57.2) |
| Standard | 1.88 (47.8) | 2.25 (57.2) |
| Jumbo ^① | 2.25 (57.2) | 2.25 (57.2) |
| Extra large | 2.50 (63.5) | 2.60 (66.0) |

Notes

Locating nib hole or notch is 1.36–1.4 in (34.5–35.6 mm) #29 drill.

^① If jumbo plates are to be placed one above the other vertically, add 0.13 (3.3) to minimum dimensions listed.

Approximate Dimensions in Inches (mm)

Multiple Button Guard

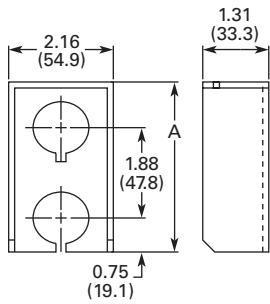

| Number of Elements | A |
|--------------------|---------------|
| 2 | 4.0 (101.6) |
| 3 | 5.88 (149.4) |
| 4 | 7.88 (200.2) |
| 7 | 13.38 (339.9) |

Chain Hook Bracket

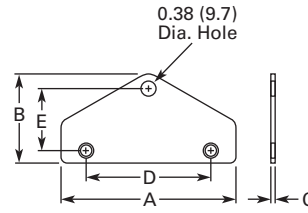

| Enclosure Size (No. of Elements) | Wide A | High B | Deep C | Mounting | |
|-------------------------------------|----------------|----------------|---------------|----------------|----------------|
| | | | | D | E |
| 2, 3 and 4 | 3.75 (95.3) | 1.94 (49.3) | 0.13 (3.3) | 2.69 (68.3) | 1.38 (35.1) |
| 6 and 7 | 4.0 (101.6) | 2.19 (55.6) | 0.13 (3.3) | 2.88 (73.2) | 1.63 (41.4) |

Master Test Module, Flasher Module and Legend Plate

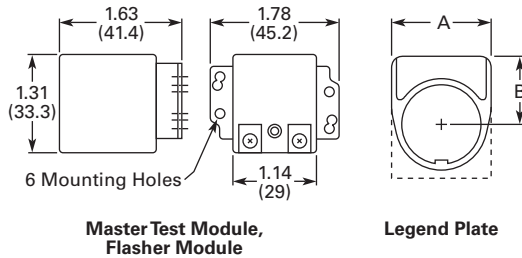

| Legend Plate | A | B |
|--------------------------------|-----------------|---------------|
| 1/2 Round Legend Plates | | |
| Small | 1.56 (39.6) | 0.91 (23.1) |
| Standard | 1.59 (40.4) | 1.07 (27.2) |
| Jumbo | 2.06 (52.3) | 1.53 (38.9) |
| Square Legend Plates | | |
| Small | 1.59 (40.4) sq. | 0.90 (22.9) |
| Standard | 1.75 (44.5) sq. | 1.06 (26.9) ① |
| Jumbo | 2.19 (55.6) sq. | 1.50 (38.1) |
| Extra large | 2.44 (62.0) sq. | 1.63 (41.4) |

Notes

Locating nib hole or notch is 1.36–1.4 in (34.5–35.6 mm) #29 drill.

① For plastic legend plate, Dimension B is 1.12 (28.4).

30.5 mm Corrosion Resistant Watertight/Oiltight—E34



Product Description

Eaton's E34 Series 30.5 mm pushbutton line features the same rugged die cast construction of our 10250T line with an additional two-layer 100% solid thermosetting cathodic epoxy coating. This coating provides a flat black smooth, consistent, corrosion resistant surface that has passed a demanding 600 hour salt spray test. (The industry standard for this 4X test requires only 200 hours.)

Features

- Epoxy-coated metal operators
- Corrosion resistant
- Integral ground screw terminal on operators
- FDA approved for sanitary chemical resistance requirements

Contents

| <i>Description</i> | <i>Page</i> |
|---|-------------|
| 30.5 mm Corrosion Resistant Watertight/Oiltight—E34 | |
| Product Overview | V7-T1-285 |
| Product Identification | V7-T1-286 |
| Catalog Number Selection | V7-T1-287 |
| Ordering Complete Devices | V7-T1-289 |
| Product Selection | |
| Non-Illuminated Momentary | |
| Pushbutton Units | V7-T1-290 |
| Plastic Lens Indicating Light Units | V7-T1-290 |
| Pushbuttons | V7-T1-291 |
| Illuminated Pushbuttons and | |
| Indicating Lights | V7-T1-292 |
| Push-Pull Units | V7-T1-294 |
| Illuminated Push-Pull Units | V7-T1-295 |
| Potentiometers | V7-T1-297 |
| Push-Pull Operators | V7-T1-298 |
| Selector Switch Units | V7-T1-302 |
| Selector Switch Selection | V7-T1-303 |
| Selector Switch Operators | V7-T1-306 |
| Key Operators | V7-T1-306 |
| Illuminated Selector Switch Operators | V7-T1-308 |
| Accessories | V7-T1-309 |
| Options | V7-T1-311 |
| Replacement Parts | V7-T1-317 |
| Technical Data and Specifications | V7-T1-319 |
| Dimensions | V7-T1-322 |

Standards and Certifications

- CE EN60947-5-1 and 60947-5-5
- UL 508—File No. E131568
- CSA C22.2 No. 14—File No. LR68551
- FDA 3-A Sanitary Standards



Ingress Protection

When mounted in similarly rated enclosure—

- Standard indicating lights
 - UL (NEMA) Type 1, 2, 3, 3R, 3S, 4, 4X, 12, 13
 - IEC IP65
- All other operators
 - UL (NEMA) Type 1, 2, 3, 3R, 4, 4X, 12, 13
 - IEC IP65

Product Overview

Ultraviolet Light

E34 cathodic coating is not recommended for use in applications where exposure to ultraviolet light exists—use NEMA 4X 10250T operators.

Reliability Nibs

Eaton’s contact blocks feature enclosed silver contacts with pointed “reliability nibs” for reliable performance from logic level up to 600V. To ensure reliable switching, nibs bite through oxide which can form on silver contacts, eliminating the need for expensive logic level blocks for most applications.

Reliability Nibs

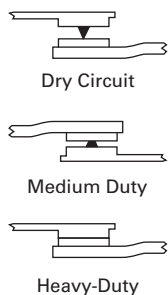

Diaphragm Seal with Drainage Holes

Liquid Drainage

Eaton’s pushbutton operators offer front of panel drainage via holes in the operator bushing. Hidden from view by the mounting nut, these holes prevent buildup of liquid inside the operator, which can prevent operation in freezing environments. The holes also provide a route for escaping liquid in high pressure washdowns, effectively relieving pressure from the internal diaphragm seal, ensuring reliable sealing in applications even beyond NEMA 4.

Diaphragm Seal

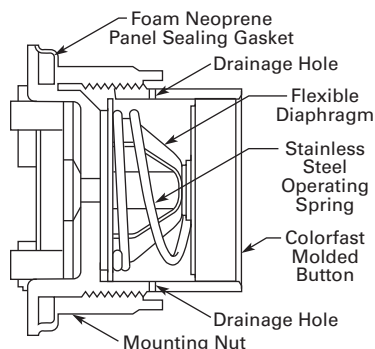

1

Product Identification

30.5 mm Corrosion Resistant Watertight/Oiltight—E34 Series

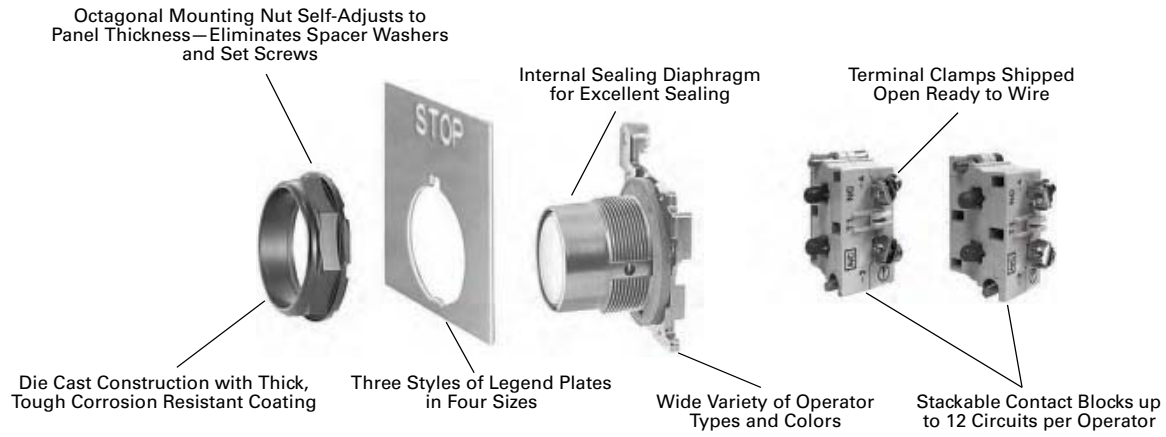

Catalog Number Selection

Catalog Number Selection is for illustrative purposes only and not to be used to create new catalog numbers.

Non-Illuminated Pushbuttons

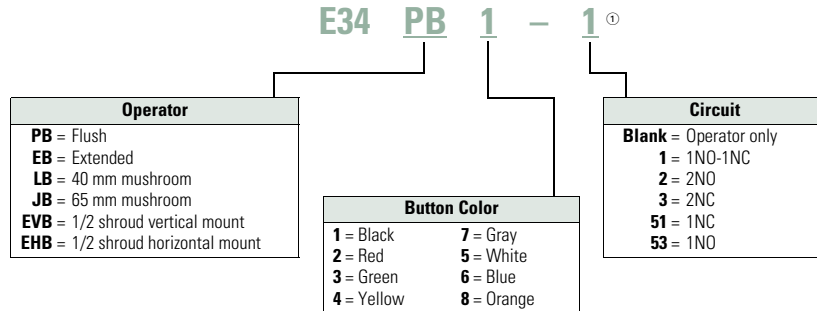

Illuminated and Non-Illuminated Push-Pulls

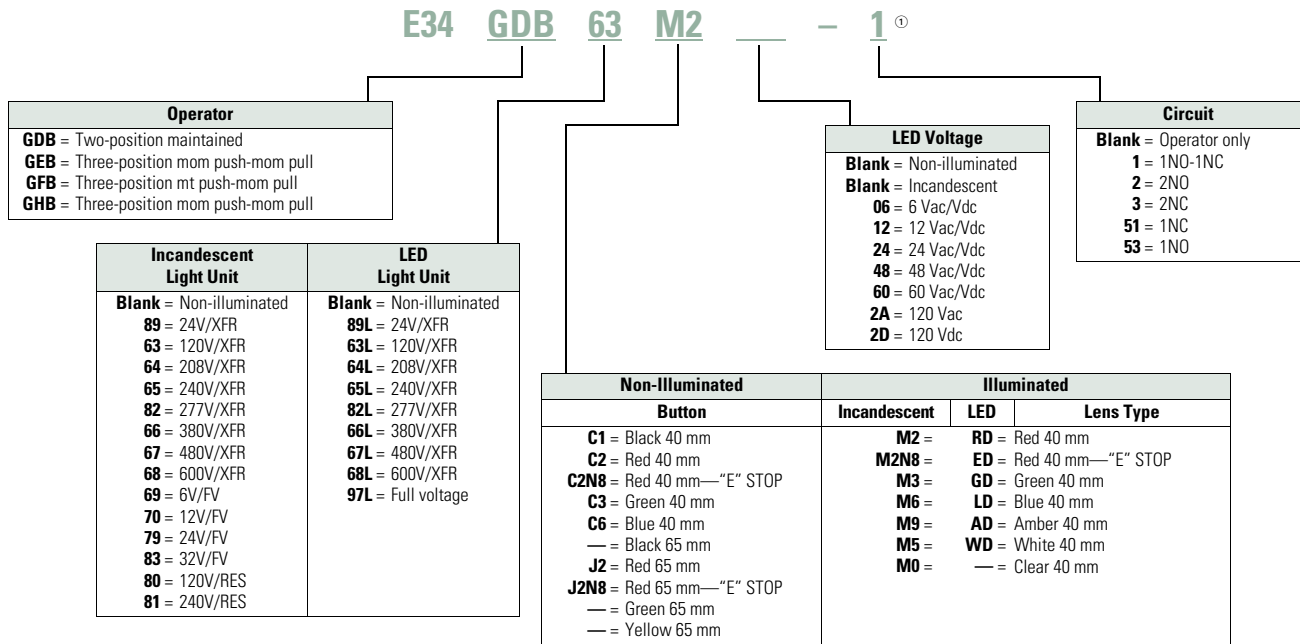

Note

① Add **X** at end of catalog number to receive parts assembled from factory.

1.10

Pushbuttons and Indicating Lights

30.5 mm Corrosion Resistant Watertight/Oiltight—E34

1

Catalog Number Selection is for illustrative purposes only and not to be used to create new catalog numbers.

Illuminated Pushbuttons

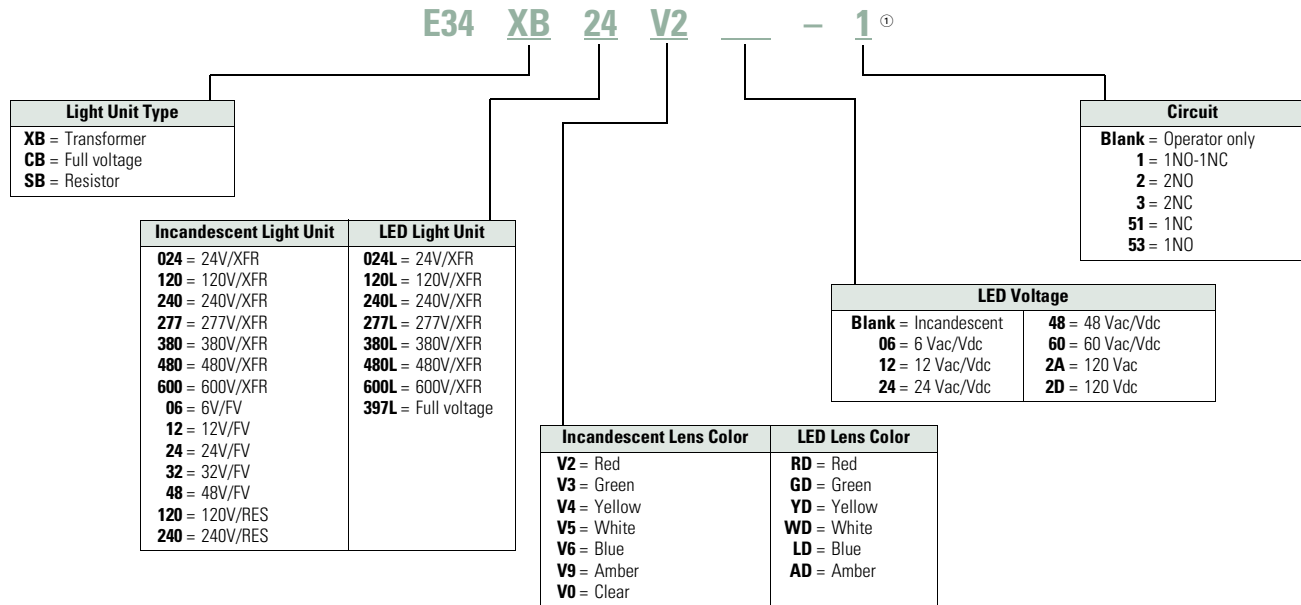

Standard Indicating Lights, PresTest and Master Test

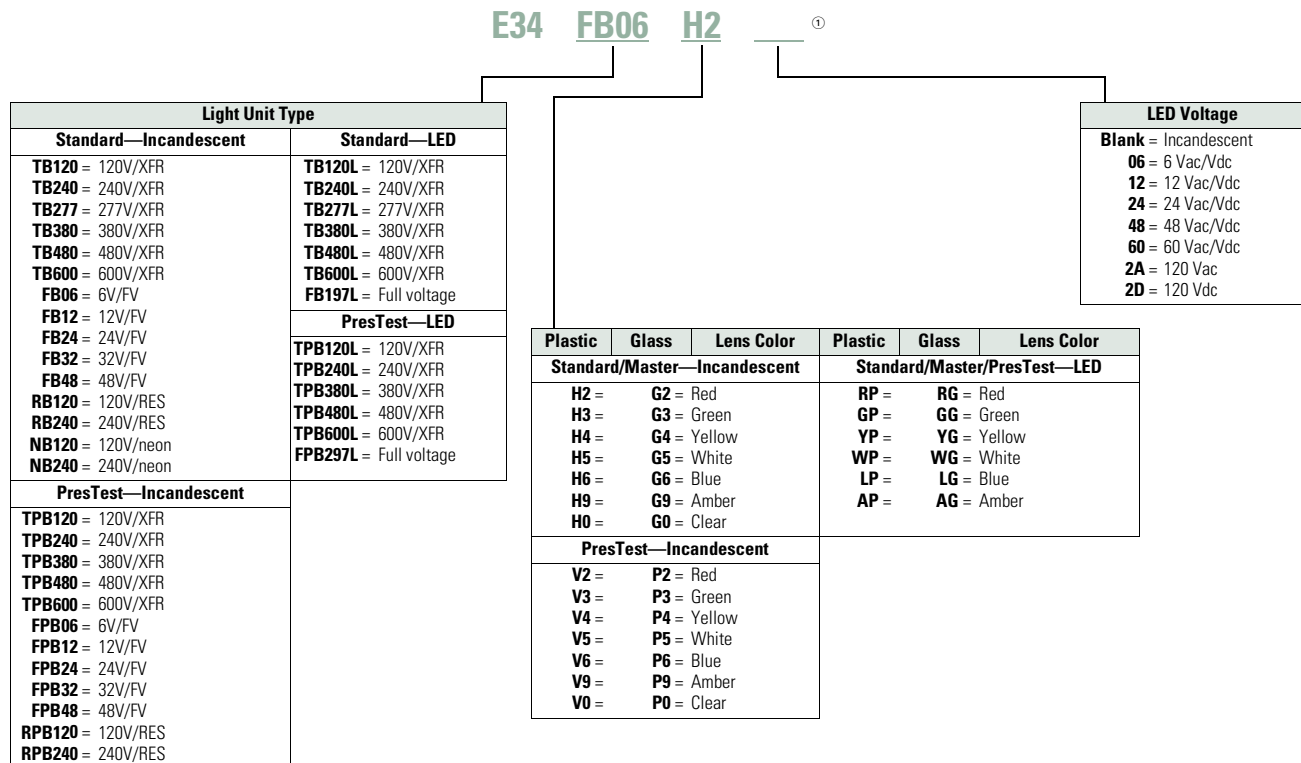

Note

① Add **X** at end of catalog number to receive parts assembled from factory.

Catalog Number Selection is for illustrative purposes only and not to be used to create new catalog numbers.

Ordering Complete Devices

Complete E34 pushbuttons, indicating lights and/or selector switch operators including contact block(s) and legend plate can be ordered using a single composite catalog number. The

individually packaged components will be shipped unassembled in a single overpack carton marked with the composite catalog number.

Ordering Example

Illuminated Pushbutton Device—Catalog Number E34XB120V2-153SP90

For a complete Catalog Number breakdown, see **Pages V7-T1-287 to V7-T1-288.**

For Complete E34 Device Ordering

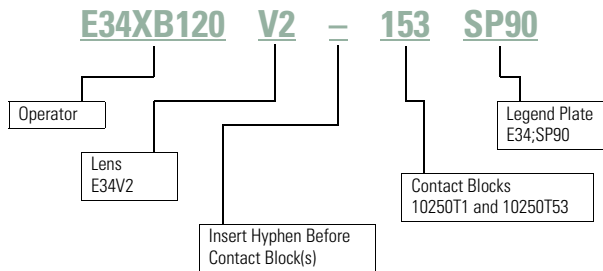

Product Selection

Non-Illuminated Momentary Pushbutton Units

UL (NEMA) Type 3, 3R, 4, 4X, 12, 13

Flush Button



Extended Button



Mushroom Button



Jumbo Mushroom



Pushbutton Units

| Contact Type | Button Color | Flush Button Catalog Number | Extended Button Catalog Number | Mushroom Button Catalog Number | Jumbo Mushroom ^① Catalog Number |
|--------------|--------------------------|-----------------------------|--------------------------------|--------------------------------|--|
| 1NO | Black | E34PB1-53X | E34EB1-53X | E34LB1-53X | E34JB1-53X |
| | Red | E34PB2-53X | E34EB2-53X | E34LB2-53X | E34JB2-53X |
| | Green | E34PB3-53X | E34EB3-53X | E34LB3-53X | E34JB3-53X |
| | Red—Engraved EMERG. STOP | — | — | — | E34JB2N8-53X |
| 1NC | Black | E34PB1-51X | E34EB1-51X | E34LB1-51X | E34JB1-51X |
| | Red | E34PB2-51X | E34EB2-51X | E34LB2-51X | E34JB2-51X |
| | Green | E34PB3-51X | E34EB3-51X | E34LB3-51X | E34JB3-51X |
| | Red—Engraved EMERG. STOP | — | — | — | E34JB2N8-51X |
| 1NO-1NC | Black | E34PB1-1X | E34EB1-1X | E34LB1-1X | E34JB1-1X |
| | Red | E34PB2-1X | E34EB2-1X | E34LB2-1X | E34JB2-1X |
| | Green | E34PB3-1X | E34EB3-1X | E34LB3-1X | E34JB3-1X |
| | Red—Engraved EMERG. STOP | — | — | — | E34JB2N8-1X |

Plastic Lens Indicating Light Units

UL (NEMA) Type 3, 3R, 4, 4X, 12, 13

24V Full Voltage Indicating Light



Indicating Light Units

| Type | Voltage | Color | LED/Lamp Number | Indicating Light ^① Catalog Number |
|--------------------------|---------------------|-------|-----------------|--|
| LED Lamp | | | | |
| Full voltage | 24 Vac/Vdc | Red | Bayonet base | E34FB197LRP24 |
| | | Green | | E34FB197LGP24 |
| | | Amber | | E34FB197LAP24 |
| | 120 Vac | Red | | E34FB197LRP2A |
| | | Green | | E34FB197LGP2A |
| | | Amber | | E34FB197LAP2A |
| Incandescent Lamp | | | | |
| Full voltage | 24 Vac/Vdc | Red | #757 | E34FB24H2X |
| | | Green | | E34FB24H3X |
| | | Amber | | E34FB24H9X |
| Resistor | 120 Vac/Vdc | Red | 120MB | E34RB120H2X |
| | | Green | | E34RB120H3X |
| | | Amber | | E34RB120H9X |
| Transformer | 120 Vac 50/60 Hz | Red | #755 | E34TB120H2X |
| | | Green | | E34TB120H3X |
| | | Amber | | E34TB120H9X |

Notes





Use NEMA 4X 10250T operators where exposed to ultraviolet light, see **Pages V7-T1-213 to V7-T1-283**.

① Anodized aluminum head—may not be suitable for some corrosive environments.

Pushbuttons

UL (NEMA) Type 3, 3R, 4, 4X, 12, 13

Momentary Pushbutton Operators, Non-Illuminated

| Button | Color | Catalog Number | | |
|--|--|----------------------------|-----------------|-------------------|
| E34PB_  | Flush button | Black | E34PB1 | |
| | Red | E34PB2 | | |
| | Green | E34PB3 | | |
| | Yellow | E34PB4 | | |
| | White | E34PB5 | | |
| | Blue | E34PB6 | | |
| | Gray | E34PB7 | | |
| | Orange | E34PB8 | | |
| E34EB_  | Extended button | Black | E34EB1 | |
| | Red | E34EB2 | | |
| | Green | E34EB3 | | |
| | Yellow | E34EB4 | | |
| | White | E34EB5 | | |
| | Blue | E34EB6 | | |
| | Gray | E34EB7 | | |
| | Orange | E34EB8 | | |
| E34EHB_  | Half shrouded button | | Vertical | Horizontal |
| | | Black | E34EVB1 | E34EHB1 |
| | Red | E34EVB2 | E34EHB2 | |
| | Green | E34EVB3 | E34EHB3 | |
| | Yellow | E34EVB4 | E34EHB4 | |
| | White | E34EVB5 | E34EHB5 | |
| | Blue | E34EVB6 | E34EHB6 | |
| | Gray | E34EVB7 | E34EHB7 | |
| | Orange | E34EVB8 | E34EHB8 | |
| | E34LB_  | Mushroom button | Black | E34LB1 |
| Red | | | E34LB2 | |
| Green | | | E34LB3 | |
| Yellow | | | E34LB4 | |
| Blue | | | E34LB6 | |
| E34JB_  | Anodized aluminum jumbo mushroom button ^① | Black | E34JB1 | |
| | | Red | E34JB2 | |
| | | Red (Engraved EMERG. STOP) | E34JB2N8 | |
| | | Green | E34JB3 | |
| | | Yellow | E34JB4 | |

Notes

Use NEMA 4X 10250T operators where exposed to ultraviolet light, see **Pages V7-T1-213 to V7-T1-283**.

① Anodized aluminum head—may not be suitable for some corrosive environments.

Illuminated Pushbuttons and Indicating Lights

Illuminated Pushbutton

Operators without Lens



Indicating Light



PresTest



| Type | Voltage | Lamp Number | Illuminated Pushbutton Catalog Number | Indicating Light Catalog Number | PresTest Catalog Number |
|---------------------------------------|---------|--------------|---------------------------------------|---------------------------------|-------------------------|
| LED Lamp (LEDs not included) ① | | | | | |
| Full voltage | — | Bayonet base | E34CB497L | E34FB197L | E34FPB297L |
| Transformer AC only | 24 | | E34XB024L | — | — |
| | 120 | | E34XB120L | E34TB120L | E34TPB120L |
| | 240 | | E34XB240L | E34TB240L | E34TPB240L |
| | 277 | | E34XB277L | E34TB277L | — |
| | 380 | | E34XB380L | E34TB380L | E34TPB380L |
| | 480 | | E34XB480L | E34TB480L | E34TPB480L |
| | 600 | | E34XB600L | E34TB600L | E34TPB600L |
| Incandescent Lamp | | | | | |
| Full voltage AC/DC | 6 | #755 | E34CB06 | E34FB06 | E34FPB06 |
| | 12 | #756 | E34CB12 | E34FB12 | E34FPB12 |
| | 24 | #757 | E34CB24 | E34FB24 | E34FPB24 |
| | 32 | #1828 | E34CB32 | E34FB32 | E34FPB32 |
| | 48 | #1835 | E34CB48 | E34FB48 | E34FPB48 |
| Resistor AC/DC ② | 120 | 120MB | E34SB120 | E34RB120 | E34RPB120 |
| | 240 | | E34SB240 | E34RB240 | E34RPB240 |
| Transformer AC only | 24 | #755 | E34XB024 | — | — |
| | 120 | | E34XB120 | E34TB120 | E34TPB120 |
| | 240 | | E34XB240 | E34TB240 | E34TPB240 |
| | 277 | | E34XB277 | E34TB277 | — |
| | 380 | | E34XB380 | E34TB380 | E34TPB380 |
| | 480 | | E34XB480 | E34TB480 | E34TPB480 |
| | 600 | | E34XB600 | E34TB600 | E34TPB600 |
| Neon AC/DC | 120 | NE51H-R-22 | — | E34NB120 | — |
| | 240 | NE51H-4-68 | — | E34NB240 | — |

Notes

Use NEMA 4X 10250T operators where exposed to ultraviolet light, see **Pages V7-T1-213 to V7-T1-283**.

① These units do not include lamps. Order LED separately to match lens color, see **Page V7-T1-269** for LED Selection and **Pages V7-T1-287 to V7-T1-288** for Catalog Numbering Selection.

② Resistor units are not available for use with LEDs, choose either transformer or full voltage LED style.

Plastic

Indicating Light Lens



| Color | Plastic Catalog Number | Glass ① Catalog Number |
|--------|------------------------|------------------------|
| Red | E34H2 | E34G2 |
| Green | E34H3 | E34G3 |
| Yellow | E34H4 | E34G4 |
| White | E34H5 | E34G5 |
| Blue | E34H6 | E34G6 |
| Ambler | E34H9 | E34G9 |
| Clear | E34H0 | E34G0 |

Glass



E34V_

Illuminated Pushbutton Lens



| Color | Catalog Number |
|--------|----------------|
| Red | E34V2 |
| Green | E34V3 |
| Yellow | E34V4 |
| White | E34V5 |
| Blue | E34V6 |
| Ambler | E34V9 |
| Clear | E34V0 |

Plastic

PresTest Lens



| Color | Plastic Catalog Number | Glass ① Catalog Number |
|--------|------------------------|------------------------|
| Red | E34V2 | E34P2 |
| Green | E34V3 | E34P3 |
| Yellow | E34V4 | E34P4 |
| White | E34V5 | E34P5 |
| Blue | E34V6 | E34P6 |
| Ambler | E34V9 | E34P9 |
| Clear | E34V0 | E34P0 |

Glass



Note

① Glass lens has black anodized aluminum bezel.

1

Push-Pull Units

UL (NEMA) Type 3, 3R, 4, 4X, 12, 13

- Two- and three-position
- Non-illuminated

Two-Position Push-Pull Unit



Two-Position Push-Pull Units, Non-Illuminated

Operator Position ①

| Pull | Push | Button Type/Color ② | Contact Type | Mounting Location | | Catalog Number |
|---|------|---|--------------|-------------------|---|-----------------------|
| | | | | A | B | |
| Maintained Push, Maintained Pull | | | | | | |
| 0 | X | 40 mm/red | 1NO | | | <u>E34GDBC2</u> -1X |
| X | 0 | 40 mm engraved EMERG. STOP/red | 1NC | | | <u>E34GDBC2N8</u> -1X |
| | | 65 mm aluminum engraved EMERG. STOP/red | | | | <u>E34GDBJ2N8</u> -1X |

Three-Position Push-Pull Unit



Three-Position Push-Pull Units, Non-Illuminated

Operator Position ①

| Pull | Intermediate | Push | Button Type/Color ② | Contact Type | Mounting Location | | Catalog Number |
|--|--------------|------|--------------------------------|--------------|-------------------|---|-----------------------|
| | | | | | A | B | |
| Maintained Push, Momentary Pull | | | | | | | |
| X | 0 | 0 | 40 mm/black | 1NC | | | <u>E34GFBC1</u> -3X |
| X | X | 0 | 40 mm/red | 1NC | | | <u>E34GFBC2</u> -3X |
| | | | 40 mm engraved EMERG. STOP/red | | | | <u>E34GFBC2N8</u> -3X |
| Momentary Push, Momentary Pull | | | | | | | |
| X | 0 | 0 | 40 mm/black | 1NC | | | <u>E34GEBc1</u> -3X |
| X | X | 0 | 40 mm/red | 1NC | | | <u>E34GEBc2</u> -3X |
| 0 | 0 | X | 40 mm/black | 1NO | | | <u>E34GHBC1</u> -1X |
| X | 0 | 0 | 40 mm/red | 1NC | | | <u>E34GHBC2</u> -1X |

Button and Color Selection

| Color | Suffix Code | Catalog Number |
|--|-------------|----------------|
| Standard—40 mm | | |
| Black | C1 | E34C1 |
| Red | C2 | E34C2 |
| Red (EMERG. STOP) | C2N8 | E34C2N8 |
| Green | C3 | E34C3 |
| Blue | C6 | E34C6 |
| Jumbo Mushroom Head ③ (Anodized) Aluminum—65 mm | | |
| Red | J2 | E34J2 |
| Red (EMERG. STOP) | J2N8 | E34J2N8 |

Notes

Use NEMA 4X 10250T operators where exposed to ultraviolet light, see **Pages V7-T1-213 to V7-T1-283**.

① X = closed circuit, 0 = open circuit.

② To order different type or color buttons, substitute the underlined characters with appropriate suffix code from the table. Example: E34GDBCC6-1X.

③ Anodized aluminum may not be suitable for use on some corrosive applications.

Illuminated Push-Pull Units

UL (NEMA) Type 3, 3R, 4, 4X, 12, 13

- Two-position maintained
- Illuminated

Illuminated Push-Pull Unit



Two-Position Illuminated Maintained Push, Maintained Pull

Operator Position ①

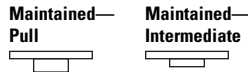

| Maintained—Pull | Maintained—Intermediate | Lamp | Type | Voltage | Contact Type | Mounting Location A | Mounting Location B | LED/Lamp Number | Red Standard Push-Pull Catalog Number ② |
|-----------------|-------------------------|--------------|--------------|-------------|-------------------------|---------------------|---------------------|-----------------|---|
| 0 | X | LED | Full voltage | 24 Vac/Vdc | 1NO | | | Bayonet base | E34GDB97LRD24-1X |
| X | 0 | | | 120 Vac/Vdc | 1NC | | | | E34GDB97LRD24A-1X |
| | | | | Transformer | 24 Vac | | | | E34GDB89LRD06-1X |
| | | | | 120 Vac | E34GDB63LRD06-1X | | | | |
| 0 | X | Incandescent | Full voltage | 24 Vac/Vdc | 1NO | | | #757 | E34GDB79M2-1X |
| X | 0 | | | 120 Vac/Vdc | 1NC | | | 120MB | E34GDB80M2-1X |
| | | | | Transformer | 24 Vac | | | #755 | E34GDB89M2-1X |
| | | | | 120 Vac | E34GDB63M2-1X | | | | |

Standard



Lens and Color Selection

| Color | Incandescent Suffix Code | LED Suffix Code | Catalog Number |
|------------------|--------------------------|-----------------|----------------|
| Standard | | | |
| Red | M2 | RD | E34M2 |
| Red (EMER. STOP) | M2N8 | ED | E34M2N8 |
| Green | M3 | GD | E34M3 |
| Blue | M6 | LD | E34M6 |
| Amber | M9 | AD | E34M9 |
| White | M5 | WD | E34M5 |
| Clear | M0 | CD | E34M0 |

Notes

Use NEMA 4X 10250T operators where exposed to ultraviolet light, see **Pages V7-T1-213 to V7-T1-283**.

① X = closed circuit, 0 = open circuit.

② To order different type or color lens, substitute the underlined characters with appropriate suffix code from Lens and Color Selection table above. Example: E34GDB79M3-1X. For LEDs with different voltages see ordering example on **Page V7-T1-301**.

1.10

Pushbuttons and Indicating Lights

30.5 mm Corrosion Resistant Watertight/Oiltight—E34

1

UL (NEMA) Type 3, 3R, 4, 4X, 12, 13

- Three-position maintained
- Illuminated

Illuminated Push-Pull Unit



Three-Position Illuminated Momentary Push, Momentary Pull

Operator Position ①

| Momentary— Pull | Maintained— Intermediate | Momentary— Push |
|--------------------|-----------------------------|--------------------|
| | | |

| | | | Lamp | Type | Voltage | Contact Type | Mounting Location | | LED/Lamp Number | Red Standard Push-Pull Catalog Number ② | | |
|---|---|---|--------------|--------------|--------------|--------------|-------------------|-------------------------|-------------------------|---|-------------------------|----------------------|
| | | | | | | | A | B | | | | |
| 0 | 0 | X | LED | Full voltage | 24 Vac/Vdc | 1NO | | Bayonet base | E34GHB97LRD24-1X | | | |
| X | 0 | 0 | | | 120 Vac | 1NC | | | | | E34GHB97LRD2A-1X | |
| | | | | | Trans-former | 24 Vac | | | | | E34GHB89LRD06-1X | |
| | | | | | 120 Vac | | | | E34GHB63LRD06-1X | | | |
| X | 0 | 0 | Full voltage | 24 Vac/Vdc | 1NC | | Bayonet base | E34GEB97LRD24-3X | | | | |
| X | X | 0 | | | 120 Vac | | | | 1NC | | E34GEB97LRD2A-3X | |
| | | | | | Trans-former | | | | 24 Vac | | E34GEB89LRD06-3X | |
| | | | | | 120 Vac | | | E34GEB63LRD06-3X | | | | |
| 0 | 0 | X | Incandescent | Full voltage | 24 Vac/Vdc | 1NO | | #757 | E34GHB79M2-1X | | | |
| X | 0 | 0 | | | Resistor | 120 Vac | | 1NC | | 120MB | E34GHB80M2-1X | |
| | | | | | Trans-former | 24 Vac | | | | #755 | E34GHB89M2-1X | |
| | | | | | 120 Vac | | | E34GHB63M2-1X | | | | |
| X | 0 | 0 | Full voltage | 24 Vac/Vdc | 1NC | | | #757 | E34GEB79M2-3X | | | |
| X | X | 0 | | | Resistor | | | 120 Vac | 1NC | | 120MB | E34GEB80M2-3X |
| | | | | | Trans-former | | | 24 Vac | | | #755 | E34GEB89M2-3X |
| | | | | | 120 Vac | | | E34GEB63M2-3X | | | | |

Notes

Use NEMA 4X 10250T operators where exposed to ultraviolet light, see **Pages V7-T1-213 to V7-T1-283**.

① X = closed circuit, 0 = open circuit.

② To order different type or color lens, substitute the underlined characters with appropriate suffix code from Lens and Color Selection table on the bottom of **Page V7-T1-295**. Example: E34GEB79M3-3X. For LEDs with different voltages see ordering example on **Page V7-T1-301**.

UL (NEMA) Type 3, 3R, 4, 4X, 12, 13

- Three-position—maintained push, momentary pull
- Illuminated

Illuminated Push-Pull Unit



Three-Position Illuminated Maintained Push, Momentary Pull

Operator Position ①



| Momentary Pull | Maintained Intermediate | Maintained Push | Lamp | Type | Voltage | Contact Type | Mounting Location | | LED/Lamp Number | Red Standard Push-Pull Catalog Number ② | |
|----------------|-------------------------|-----------------|--------------|--------------|------------|--------------|-------------------|--------------|-----------------|---|-------------------------|
| | | | | | | | A | B | | | |
| X | 0 | 0 | LED | Full voltage | 24 Vac/Vdc | 1NC | o o | Bayonet base | | E34GFB97LRD24-3X | |
| X | X | 0 | | | 120 Vac | 1NC | | | | | o o |
| | | | | | 24 Vac | | | | | | E34GFB89LRD06-3X |
| | | | | Trans-former | 120 Vac | | | | | E34GFB63LRD06-3X | |
| X | 0 | 0 | Incandescent | Full voltage | 24 Vac/Vdc | 1NC | o o | #757 | | | |
| X | X | 0 | | | 120 Vac | 1NC | | | | | o o |
| | | | | | 24 Vac | | | #755 | | | E34GFB89M2-3X |
| | | | | | 120 Vac | | | | | | E34GFB63M2-3X |

Vertical or Horizontal One-Hole Mounting ③



Potentiometers

UL (NEMA) Type 3, 3R, 4, 4X, 12, 13

Potentiometer with Knob and Standard Dial Plate—Linear Type ±10%

| Potentiometer Ohms | Catalog Number |
|--|-------------------|
| 2 Watt (60V Max.) Single Potentiometer with Standard Aluminum Dial Plate ④⑤ | |
| 1000 | E34PDB1F1 |
| 2500 | E34PDB1F2 |
| 5000 | E34PDB1F5 |
| 10000 | E34PDB1F10 |
| 25000 | E34PDB1F25 |
| 50000 | E34PDB1F50 |
| Operator only ⑥ | E34PDB1A0 |
| Alternative—black plastic large legend with standard markings | E34LP99 |

Dimensions, see **Page V7-T1-322**.

Notes

Use NEMA 4X 10250T operators where exposed to ultraviolet light, see **Pages V7-T1-213 to V7-T1-283**.

① X = closed circuit, 0 = open circuit.

② To order different type or color lens, substitute the underlined characters with appropriate suffix code from table on the bottom of **Page V7-T1-295**.

Example: E34GFB79M3-3X. For LEDs with different voltages see ordering example on **Page V7-T1-301**.

③ Shown with standard aluminum dial plate.

④ Large dial plate with space for legend is available at no charge. To order, add suffix **36** to catalog number.

Example: E34PDB1F136. To order separately, see footnote ⑤ below.

⑤ Large dial plate has space at top for 15 letters. 3/32 in high. For custom stamped legend plates, order legend plate as separate item **10250TR30** and specify stamping.

⑥ For use with commercially purchased potentiometers having shaft dimensions per dimension drawing on **Page V7-T1-274**.

1

Push-Pull Operators

An illuminated push-pull pushbutton unit, arranged for one-hole mounting, can replace two pushbuttons and a pilot light or the non-illuminated form can replace two pushbuttons. These units are available in three basic types:

- **Maintained**—(Two-position). Maintains in the pulled or pushed position until manually actuated to the opposite mode.
- **Momentary**—(Three-position). Spring returns to an intermediate position when pulled or pushed and released.

- **Momentary Pull, Maintained Push**—(Three-position). Spring returns to intermediate position when pulled. Maintains in pushed position until manually returned to intermediate (ready to reset) position. Maintained stop holds circuit open and will prevent other series connected operators from starting the system.

The operators, buttons, contact blocks, etc., are offered as building block components that can be intermixed to satisfy many requirements. This minimizes the need for a varied and costly inventory.

Application Guide

To assist in the selection of contact blocks, the sketch below shows pictorially by symbols **A** and **B** locations of contact circuits after assembly of contact blocks and adapter to the operator. The table below shows the effect of the push and pull operations on either NO or NC contacts. (X = contact closed, O = contact open).

Contact Circuit Locations

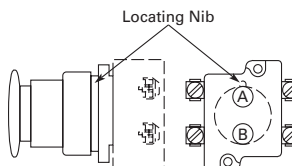

Two-Position Maint. Push-Pull ①



Push-Pull Operator Components

Operator Position and Circuit Arrangement

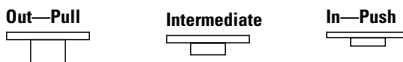

Contact Block Mounting Location

| Type of Operator | Out—Pull | | Intermediate | | In—Push | | Contact Block ② | Catalog Number |
|---|----------|---|--------------------------|---|---------|---|-----------------|-----------------|
| | A | B | A | B | A | B | | |
| Two-Position Operator without Lens | | | | | | | | |
| Maintained push-pull | O | O | No intermediate position | | X | X | 1NO | E34GDB |
| | X or | X | | | O or | O | 1NC | |
| | O | O | | | X | X | 2NO | |
| | X | X | | | O | O | 2NC | |
| Three-Position Operator without Lens | | | | | | | | |
| Momentary push-pull | O | O | O | O | X | O | 1NO | E34GEB ② |
| | X or | X | O | X | O or | O | 1NC | |
| | O | O | O | O | X | O | 2NO | |
| | X | X | O | X | O | O | 2NC | |
| Maintained push-momentary pull | O | O | O | O | X | O | 1NO | E34GFB ② |
| | X or | X | O | X | O or | O | 1NC | |
| | O | O | O | O | X | O | 2NO | |
| | X | X | O | X | O | O | 2NC | |
| Momentary push-pull | O | O | O | O | X | X | 1NO | E34GHB ② |
| | X or | X | O | O | O or | O | 1NC | |
| | O | O | O | O | X | X | 2NO | |
| | X | X | O | O | O | O | 2NC | |

Notes

Use NEMA 4X 10250T operators where exposed to ultraviolet light, see **Pages V7-T1-213 to V7-T1-283**.

See Typical Applications on **Page V7-T1-233**.

① Shown without button on lens.

② Maximum of two blocks, four circuits. Special function contact blocks shown on **Page V7-T1-316** CANNOT be used with three-position push-pull operators E34GEB, E34GFB or E34GHB.

Push-Pull Light Units, Lenses and Buttons

Ordering Example with One Composite Number

Non-illuminated:

E34GDB + E34C2 + 10250T1 = **E34GDBC2-1X**

Incandescent:

E34GDB + 10250T79 + E34M2 + 10250T1 = **E34GDB79M2-1X**

LED:

E34GDB + 10250T97L + E34M2 + Voltage Code + 10250T1 = **E34GDB97LRD24-1X**

| | |
|---------------|---------------|
| 06—6 Vac/Vdc | 60—60 Vac/Vdc |
| 12—12 Vac/Vdc | 2A—120 Vac |
| 24—24 Vac/Vdc | 2D—120 Vdc |
| 48—48 Vac/Vdc | |

Light Units for Illuminated Push-Pull Devices

| Light Unit Type | Type | Voltage | LED/Lamp Number | Catalog Number |
|------------------------------------|--|--------------|-----------------|--------------------------|
| LED (LEDs not included) ① | Full voltage Transformer AC only 50/60 Hz | — | Bayonet base | 10250T97L |
| | | 24 | | 10250T89L |
| | | 120 | | 10250T63L |
| | | 208 | | 10250T64L |
| | | 240 | | 10250T65L |
| | | 277 | | 10250T82L |
| | | 380 | | 10250T66L |
| | | 480 | | 10250T67L |
| | | 600 | | 10250T68L |
| | | Incandescent | | Full voltage AC or DC |
| 12 | #756 | | 10250T70 | |
| 24/28 | #757 | | 10250T79 | |
| | #1828 | | 10250T79 | |
| 32 | | | 10250T83 | |
| Resistor AC or DC | 120 | | 120MB | 10250T80 |
| | 240 | | | 10250T81 |
| Transformer AC only 50/60 Hz | 24 | | #755 | 10250T89 |
| | 120 | | | 10250T63 |
| | 208 | | | 10250T64 |
| | 240 | | | 10250T65 |
| | 277 | | | 10250T82 |
| | 380 | | | 10250T66 |
| | 480 | | | 10250T67 |
| | 600 | | | 10250T68 |

Notes

Use NEMA 4X 10250T operators where exposed to ultraviolet light, see **Pages V7-T1-213 to V7-T1-283**.

① These units do not include lamps. Order LED separately to match lens color from chart on **Page V7-T1-301**

Buttons for Non-Illuminated Push-Pull Devices

| Color | Incandescent Suffix Code | Catalog Number |
|----------------------------|-----------------------------|----------------|
| Standard Button | | |
| Black | C1 | E34C1 |
| Red | C2 | E34C2 |
| Red (EMERG. STOP) | C2N8 | E34C2N8 |
| Green | C3 | E34C3 |
| Blue | C6 | E34C6 |
| Jumbo Mushroom Head | | |
| Red ① | J2 | E34J2 |
| Red (EMERG. STOP) | J2N8 | E34J2N8 |

E34M_

Alternate Lenses for Illuminated Push-Pull Devices



| Color | Incandescent Suffix Code | LED Suffix Code ② | Catalog Number |
|-------------------|-----------------------------|----------------------|----------------|
| Red | M2 | RD | E34M2 |
| Red (EMERG. STOP) | M2N8 | ED | E34M2N8 |
| Green | M3 | GD | E34M3 |
| Blue | M6 | LD | E34M6 |
| Amber | M9 | AD | E34M9 |
| White | M5 | WD | E34M5 |
| Clear | M0 | — | E34M0 |

Notes

Use NEMA 4X 10250T operators where exposed to ultraviolet light, see **Pages V7-T1-213 to V7-T1-283**.

① Anodized aluminum may not be suitable for use on some corrosive applications.

② Suffix codes should only be used for assembling composite catalog numbers. To order lens, order by catalog number.

Standard LED Lamp



LED Selection

| Voltage | Color | Catalog Number |
|---|--------------|-----------------------|
| 6 Vac/Vdc suitable for use with transformers | Red | E22LED006RN |
| | Orange | E22LED006ON |
| | Yellow | E22LED006YN |
| | Green | E22LED006GN |
| | Blue | E22LED006BN |
| 12 Vac/Vdc | White | E22LED006WN |
| | Red | E22LED012RN |
| | Orange | E22LED012ON |
| | Yellow | E22LED012YN |
| | Green | E22LED012GN |
| 24 Vac/Vdc | Blue | E22LED012BN |
| | White | E22LED012WN |
| | Red | E22LED024RN |
| | Orange | E22LED024ON |
| | Yellow | E22LED024YN |
| 48 Vac/Vdc | Green | E22LED024GN |
| | Blue | E22LED024BN |
| | White | E22LED024WN |
| | Red | E22LED048RN |
| | Orange | E22LED048ON |
| | Yellow | E22LED048YN |
| | Green | E22LED048GN |
| | Blue | E22LED048BN |
| | White | E22LED048WN |

| Voltage | Color | Catalog Number |
|----------------|--------------|-----------------------|
| 60 Vac/Vdc | Red | E22LED060RN |
| | Orange | E22LED060ON |
| | Yellow | E22LED060YN |
| | Green | E22LED060GN |
| | Blue | E22LED060BN |
| 120 Vac | White | E22LED060WN |
| | Red | E22LED120RA |
| | Orange | E22LED120OA |
| | Yellow | E22LED120YA |
| | Green | E22LED120GA |
| 120 Vdc | Blue | E22LED120BA |
| | White | E22LED120WA |
| | Red | E22LED120RD |
| | Orange | E22LED120OD |
| | Yellow | E22LED120YD |
| | Green | E22LED120GD |
| | Blue | E22LED120BD |
| | White | E22LED120WD |

1

Selector Switch Units

UL (NEMA) Type 3, 3R, 4, 4X, 12, 13

- Two-, three- and four-position—maintained
- Non-illuminated and illuminated

Two-Position Maint. Switch Knob



Two-Position Selector Switch

| Operator Position ^① | | Operator Action ^② | Contact Type | Mounting Location | | Cam Code | Non-Illuminated | | Illuminated—120V Transformer | |
|--------------------------------|---|------------------------------|--------------|-------------------|---|----------|--|---|--------------------------------------|---------------------------------------|
| X | O | | | A | B | | Black Knob Catalog Number ^③ | Black Lever Catalog Number ^③ | Red Knob Catalog Number ^③ | Red Lever Catalog Number ^③ |
| X | O | M M | 1NC | A | B | 1 | E34VFBK1-1X | E34VFB1-1X | E34VFB120ER-1X | E34VFB120FR-1X |
| O | X | | 1NO | | | | | | | |

Three-Position Maint. Switch Knob



Three-Position Selector Switch

| Operator Position ^① | | | Operator Action ^② | Contact Type | Mounting Location | | Cam Code | Non-Illuminated | | Illuminated—120V Transformer | |
|--------------------------------|---|---|------------------------------|--------------|-------------------|---|----------|--|---|--------------------------------------|---------------------------------------|
| X | O | O | | | A | B | | Black Knob Catalog Number ^③ | Black Lever Catalog Number ^③ | Red Knob Catalog Number ^③ | Red Lever Catalog Number ^③ |
| X | O | O | M M M | 1NO | A | B | 3 | E34VHBK1-2X | E34VHBL1-2X | E34VHB120TER-2X | E34VHB120TFR-2X |
| O | O | X | | 1NO | | | | | | | |
| X | O | O | M M M | 1NO | A | B | 3 | E34VHBK1-23X | E34VHBL1-23X | E34VHB120TER-23X | E34VHB120TFR-23X |
| O | X | O | | 2NC (Series) | | | | | | | |
| O | O | X | | 1NO | | | | | | | |

Four-Position Maint. Switch Lever



Four-Position Selector Switch

| Operator Position ^① | | | | Operator Action ^② | Contact Type | Mounting Location | | Cam Code | Non-Illuminated | | Illuminated—120V Transformer | |
|--------------------------------|---|---|---|------------------------------|--------------|-------------------|---|----------|--|---|--------------------------------------|---------------------------------------|
| X | O | O | O | | | A | B | | Black Knob Catalog Number ^③ | Black Lever Catalog Number ^③ | Red Knob Catalog Number ^③ | Red Lever Catalog Number ^③ |
| X | O | O | O | M M M M | 1NC | A | B | 7 | E34VTBK1-23X | E34VTBL1-23X | E34VRB120TER-23X | E34VRB120TFR-23X |
| O | X | O | O | | 1NO | | | | | | | |
| O | O | X | O | | 1NO | | | | | | | |
| O | O | O | X | | 1NC | | | | | | | |

Color Selection, Non-Illuminated

| Color | Code Letter | Color | Code Letter |
|--------|-------------|--------|-------------|
| Black | 1 | White | 5 |
| Red | 2 | Blue | 6 |
| Green | 3 | Gray | 7 |
| Yellow | 4 | Orange | 8 |

Notes

For Light Unit Voltage Suffix and Knobs, Levers tables, see **Page V7-T1-308**.

Use NEMA 4X 10250T operators where exposed to ultraviolet light, see **Pages V7-T1-213 to V7-T1-283**.

^① X = closed circuit, O = open circuit.

^② M = Maintained.

^③ To order different type or color selector switch, substitute the underlined character with appropriate suffix code from the Color Selection table. Example: E34VFBK2-X1.

Selector Switch Selection



Cam and Contact Block Selection

Selector switches in their varied forms (two-position, three-position and four-position) are a big factor contributing to the great flexibility of control that a well rounded line of “pushbuttons” can achieve. Because of their flexibility, they tend to cause difficulty with product selection and application. The following systematic approach should simplify that task.

Cam and contact block selection is better understood if you:

- Work with each incoming and outgoing wire/circuit separately.
- Recognize the terms NO and NC only identify the type of contact by its mode before mounting to the operator. The “X-O” chart (Page V7-T1-305) shows how that contact will act after assembly to the operator with the selected cam shape. X = closed circuit, O = open circuit.

- Up to six NO or NC contacts may be mounted behind each plunger location for a total of twelve contacts. Single circuit contact blocks have only one plunger with the other side of the block “open.” Therefore, single circuit contact blocks transmit motion to blocks behind them only for the position containing the circuit.
- Each cam has two separate lobes, each of which operates one of the two contact block plungers independently of each other. Those are identified as position A (locating nib side) and position B (opposite of locating nib). The position designations give direction in selecting and mounting of the contact blocks.

Contact Circuit Locations

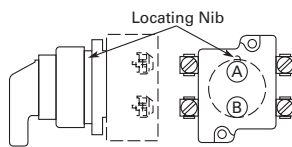

Systematic Approach

Application: **HAND-OFF-AUTO** selector switch. In this circuit, one incoming line is distributed to two other outgoing circuits by the switch. The two circuits can be looked at individually.

Step 1: Elementary Diagram.

Construct on paper, or in your mind, a simple elementary diagram of the switching scheme as follows:

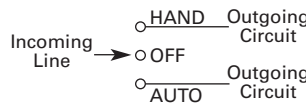

Step 2: “X-O” Pattern.

From the elementary diagram, you can construct an “X-O” diagram which describes when the contacts are to be closed (X) or open (O) in the various positions of the switch. The “X-O” for the **HAND** circuit looks like this:



In this circuit, you want a contact closed on the left (HAND) but open in the center and right.

For the **AUTO** circuit, the “X-O” diagram would look like this:

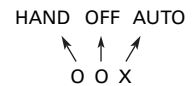

Putting them together, the complete “X-O” diagram is:



Once the “X-O” diagram has been generated, the next step is to select the cam and contact block, or blocks, needed to perform the desired “X-O” functions. The selection tables on the following pages list the various types (shapes) of cams by number to choose from and the type of contact and position to achieve the function outlined in your “X-O” diagram.

1

Step 3: Cam Selection.

The cam you select determines the operation of all contact blocks mounted to the operator. It is selected on the basis that it provides the simplest circuitry for the desired "X-O" diagram. The selection tables show all the "X-O" combinations. For the purpose of this example, the applicable portion of those tables is shown on this page.

Now to make the cam selection, make a simple worksheet such as:

| | Cam 2 | Cam 3 |
|-------|-------------|-------|
| X O O | (A)NO-(B)NC | (A)NO |
| O O X | (B)NO | (B)NO |

It becomes immediately obvious that cam 3 is the better choice for two reasons, (1) the series combination can be avoided making it simpler to wire, (2) only two contacts are required, which is less expensive than the three contacts required by cam 2.

Step 4: Contact Block Selection.

Having selected the cam, contact block selection is simply a matter of gathering the A position and B position circuits into pairs which make up the most convenient contact block arrangement. If there is an imbalance in the number of circuits under A or B, then single circuit blocks must be selected for these leftover circuits.

Back to the worksheet, having selected cam 3 do this:

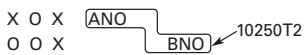

Step 5: Selector Switch Operator.

Lastly, you have to choose from the many types of operators—knob and lever in various colors or keyed. Also what combinations of maintained and spring return functions are required. Selection of these operators can be found on **Page V7-T1-306**. For the example in step 4, you may want a three-position maintained black knob, cam 3—Catalog Number E34VHBK1.

The Complete Switch:

E34VHBK1 with one 10250T2 or, for one composite catalog number, E34VHBK1-Y1 found on **Page V7-T1-303**.

Diagrams

Circuits shown illustrate connections to obtain a selector switch circuit combination and are shown with their appropriate line diagrams. Field wiring of jumper connections required as shown.

X = Closed circuit
O = Open circuit

Wiring of Jumper Connections



Series Connection

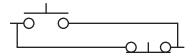

Parallel Connection

Four-position selector switches are limited to four contact blocks.

Contact Blocks

For selection and number of available contact blocks per operator, see **Page V7-T1-315**.

Example Selection Table

| No. | "X-O" Pattern | Cam Code #2 | | Cam Code #3 | |
|-----|---------------|-------------|----------|-------------|----------|
| | | Top A | Bottom B | Top A | Bottom B |
| 1 | X 0 0 | | | | — |
| 4 | 0 0 X | — | | — | |

Two-Position Selector Switch Contact Block Selection

| No. | Desired Circuit and Operator Position | | Contact Blocks Required to Accomplish Circuit Function | |
|-----|---------------------------------------|---|--|------------------|
| | | | Top Plunger A | Bottom Plunger B |
| 1 | X | 0 | | or |
| 2 | 0 | X | | or |

Note

① Wired in series.

Three-Position Switch—Cam and Contact Block Selection

| No. | Desired Circuit and Operator Position | | | Contact Blocks Required to Accomplish Circuit Function (Jumpers must be installed where indicated) | | | |
|-----|---------------------------------------|---|---------------|---|---------------|---------------------------|--|
| | | | | Operator with Cam Code #2 | | Operator with Cam Code #3 | |
| | | | | Mounting Location | | Mounting Location | |
| | | | Top Plunger A | Bottom Plunger B | Top Plunger A | Bottom Plunger B | |
| 1 | X | 0 | 0 | | | | |
| 2 | X | X | 0 | | | | |
| 3 | X | 0 | X | | | | |
| 4 | 0 | 0 | X | | | | |
| 5 | 0 | X | X | | | | |
| 6 | 0 | X | 0 | | | | |

Four-Position Switch—Contact Block Selection

| No. | Desired Circuit and Operator Position | | | | Contact Blocks Required to Accomplish Circuit Function | | No. | Desired Circuit and Operator Position | | | | Contact Blocks Required to Accomplish Circuit Function | |
|-----|---------------------------------------|---|---|---|--|------------------|-----|---------------------------------------|---|---|---|--|------------------|
| | | | | | Top Plunger A | Bottom Plunger B | | | | | | Top Plunger A | Bottom Plunger B |
| | | | | | | | | | | | | | |
| 1 | X | 0 | 0 | 0 | | | 10 | X | 0 | X | 0 | | |
| 2 | 0 | X | 0 | 0 | | | | | | | | | |
| 3 | 0 | 0 | X | 0 | | | 11 | X | X | X | 0 | | |
| 4 | 0 | 0 | 0 | X | | | | | | | | | |
| 5 | X | 0 | 0 | X | | | 12 | 0 | X | X | X | | |
| 6 | 0 | X | X | 0 | | | | | | | | | |
| 7 | 0 | 0 | X | X | | | 13 | X | 0 | X | X | | |
| 8 | X | X | 0 | 0 | | | | | | | | | |
| 9 | 0 | X | 0 | X | | | 14 | X | X | 0 | X | | |

1

Selector Switch Operators

UL (NEMA) Type 3, 3R, 4, 4X, 12, 13

Two-Position Knob Selector Switch



Operators with Knob Assembled

| Positions | Operator Action ^① | Black Knob Selector Switch— Vertical Mounting ^② | Cam Code ^③ | Catalog Number ^④ |
|--------------------------|------------------------------|---|-----------------------|-----------------------------|
| Two-position—60° throw | | | 1 | <u>E34VFBK1</u> |
| | | | 1 | <u>E34VEBK1</u> |
| Three-position—60° throw | | | 2 | <u>E34VGBK1</u> |
| | | | 3 | <u>E34VHBK1</u> |
| | | | 2 | <u>E34VJBK1</u> |
| | | | 3 | <u>E34VKBK1</u> |
| | | | 2 | <u>E34VLBK1</u> |
| | | | 3 | <u>E34VMBK1</u> |
| Four-position—40° throw | | | 2 | <u>E34VNBK1</u> |
| | | | 3 | <u>E34VPBK1</u> |
| Four-position—40° throw | | | 7 | <u>E34VTBK1</u> |

Key Operators

Three-Position Keyed Selector Switch



Key Operators with Cam and Cap

| Positions | Operator Action ^① | Cam Code ^③ | Key Removal Positions ^⑤ | Vertical Mounting Catalog Number | Horiz. Mounting Catalog Number |
|--------------------------|------------------------------|-----------------------|------------------------------------|----------------------------------|--------------------------------|
| Two-position—60° throw | | 1 | 1, 2, 3 | <u>E34KFB_</u> | <u>E34KFHB_</u> |
| | | 1 | 2 | <u>E34KEB_</u> | <u>E34KEHB_</u> |
| Three-position—60° throw | | 2 | 1–7 | <u>E34KGB_</u> | <u>E34KGHB_</u> |
| | | 3 | | <u>E34KHB_</u> | <u>E34KHGB_</u> |
| | | 2 | 1, 4, 5 | <u>E34KJB_</u> | <u>E34KJHB_</u> |
| | | 3 | | <u>E34KKB_</u> | <u>E34KKHB_</u> |
| | | 2 | 4 | <u>E34KLB_</u> | <u>E34KLHB_</u> |
| | | 3 | | <u>E34KMB_</u> | <u>E34KMHB_</u> |
| Four-position—40° throw | | 2 | 2, 4, 6 | <u>E34KNB_</u> | <u>E34KNHB_</u> |
| | | 3 | | <u>E34KPB_</u> | <u>E34KPHB_</u> |
| Four-position—40° throw | | 7 | 7 | <u>E34KTB_</u> | <u>E34KTHB_</u> |

Notes

Use NEMA 4X 10250T operators where exposed to ultraviolet light, see **Pages V7-T1-213 to V7-T1-283**.

① M = Maintained. S = Spring return in direction of arrow (R).

② Field convertible to horizontal mounting.

③ For selection of the proper cam and contact block to obtain the proper circuit sequence, see selection instructions and tables on **Pages V7-T1-303 to V7-T1-305**.

④ For other colors of either the knob or lever, replace the underlined characters of the catalog number with the appropriate suffix code from Alternate Knob and Lever table on **Page V7-T1-307**. Example: E34VFBL2.

⑤ Choose key removal position required for application from table on **Page V7-T1-307**. Add key removal code number to listed catalog number. Example: E34KFB2.

Key Removal Positions ①

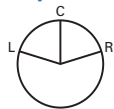

| Code Suffix | Key Removal Position |
|-------------|----------------------|
| 1 | Right only |
| 2 | Left only |
| 3 | Right and left |
| 4 | Center only |
| 6 | Left and center |
| 7 | All positions |

Dissimilar Locks and Keys

Listed operators have identical locks and keys (Key Code H661), Catalog Number **10250ED824**. For dissimilar lock and key combinations, see **Page V7-T1-242**.

Alternate Knobs and Levers for Operators ②

E34K_



E34L_



E34A_



| Color | Knob | | Lever | | Lever Designed for Added Ingress Protection ③ | |
|--------|-------------|----------------|-------------|----------------|---|----------------|
| | Suffix Code | Catalog Number | Suffix Code | Catalog Number | Suffix Code | Catalog Number |
| Black | K1 | E34K1 | L1 | E34L1 | A1 | E34A1 |
| Red | K2 | E34K2 | L2 | E34L2 | A2 | E34A2 |
| Green | K3 | E34K3 | L3 | E34L3 | A3 | E34A3 |
| Yellow | K4 | E34K4 | L4 | E34L4 | A4 | E34A4 |
| White | K5 | E34K5 | L5 | E34L5 | A5 | E34A5 |
| Blue | K6 | E34K6 | L6 | E34L6 | A6 | E34A6 |
| Gray | K7 | E34K7 | L7 | E34L7 | A7 | E34A7 |
| Orange | K8 | E34K8 | L8 | E34L8 | A8 | E34A8 |

Notes

- ① Key removal in “spring return from” positions not recommended.
- ② See operators on **Page V7-T1-306**.
- ③ For use on maintained operators only.

1

Illuminated Selector Switch Operators

120 Vac Transformer Selector Switch, Cam 1



Operator without Knob or Lever

| Positions | Operator Action | Transformer Type—50/60 Hz 6V #755 Lamp Catalog Number ^{③④} | | Full Voltage Type—AC or DC ^① Lamps—#755, #757, #1835, 120MB ^② Catalog Number ^④ | | |
|--------------------------|-----------------|---|-------------------------|---|-------------------------|-------------------------|
| | | Cam Code 1 ^⑤ | Cam Code 2 ^⑤ | Cam Code 3 ^⑤ | Cam Code 1 ^⑤ | Cam Code 2 ^⑤ |
| Two-position—60° throw | | E34VFB_ | | E34SFB_ | | |
| Three-position—60° throw | | E34VGB_ | E34VHB_ | E34SGB_ | E34SHB_ | |
| | | E34VNB_ ^⑥ | E34VPB_ ^⑥ | E34SNB_ ^⑦ | E34SPB_ ^⑦ | |
| | | E34VJB_ ^⑥ | E34VKB_ ^⑥ | E34SJB_ ^⑦ | E34SKB_ ^⑦ | |
| | | E34VLB_ | E34VMB_ | E34SLB_ | E34SMB_ | |
| Four-position—40° throw | | E34VRB_ | — | E34SRB_ | — | |

Knob



Lever



Knobs and Levers

| Color ^② | Knob Catalog Number and Code Number | Lever Catalog Number and Code Number |
|--------------------|-------------------------------------|--------------------------------------|
| Red | 10250TER | 10250TFR |
| Green | 10250TEG | 10250TFG |
| Yellow | 10250TEA | 10250TFA |
| Blue | 10250TEL | 10250TFL |
| Clear | 10250TEC | 10250TFC |
| White | 10250TEW | 10250TFW |
| Amber | 10250TEM | 10250TFM |

Light Unit Voltage Suffix

Add to operator Catalog Number listed in table above.

Type of Light Unit

| Transformer Type 50/60 Hz | | Full Voltage Type AC or DC ^① | |
|------------------------------|-------------|--|-------------|
| Voltage | Suffix Code | Voltage | Suffix Code |
| 24 | 024 | 6 | 06 |
| 120 | 120 | 12 | 12 |
| 208 | 208 | 24 | 24 |
| 240 | 240 | 48 | 48 |
| 380 | 380 | 120 | 120 |
| 480 | 480 | 240 ^⑥ | 240 |
| 600 | 600 | | |

Notes

Use NEMA 4X 10250T operators where exposed to ultraviolet light, see **Pages V7-T1-213 to V7-T1-283**.

^① Full voltage light units can be used at other than listed voltages by changing lamp. Replacement lamps are listed on **Page V7-T1-269**.

^② 120MB lamps are used on both 120V and 240V operators.

^③ Operator includes lens gasket and lens attachment screws.

^④ Add suffix code for light unit voltage to listed catalog number from Light Unit Voltage Suffix table above.
Example: For 24V transformer type light unit, order E34VFB024.

^⑤ For selection of the proper cam and contact block required to obtain a specific circuit sequence, see selection tables on **Pages V7-T1-303 to V7-T1-305**.

^⑥ 120 and 240V transformer only.

^⑦ 120 full voltage only.

^⑧ Resistor type. May generate excess heat if used in high density.

^⑨ Amber, clear and white lenses have a black arrow (R). Red, green and blue lenses have a white arrow (R).

Accessories





Accessories

| | Description | Catalog Number |
|---|--|--------------------|
|  | Padlocking Attachment for Flush Pushbutton Operators. Permits locking NC contacts in open position with 1/4 in padlock. Will not lock NO contact. | E34TA2 |
|  | Flexible Weather Resistant Boot for use with flush pushbutton operators. | |
| | Clear | 10250TA46 |
| | Black | 10250TA47 |
| | Red | 10250TA48 |
| | Green | 10250TA49 |
| | Flexible Weather Resistant Boot for use with button operators (extended buttons preferred). | |
| | Black | 10250TA3 |
| | Red | 10250TA4 ① |
| | Green | 10250TA10 |
| | Clear | 10250TA85 |
| | Transparent Boot for regular, illuminated pushbutton operators and PresTest. | 10250TA25 ② |
|  | Special Retaining Nut —to accommodate thick panel. | |
| | Indicating light | E34TA30 |
| | PresTest, pushbuttons and selector switches | E34TA31 |
|  | Shroud for Mushroom Head Operator —prevents accidental operation. (Not for push-pull operators.) | E34TA6 |
|  | Extended Retaining Nut —replaces standard nut and provides guard for flush type pushbutton operators. | E34TA12 |
|  | Guard for illuminated pushbutton | E34TA15 |
|  | Padlocking Attachment for non-illuminated knob selector switches— accommodates up to five, 1/4 in padlocks. | E34TA11 |

Notes

- ① Should not be used on flush button for STOP function.
- ② Not suitable for single contact block depth cast enclosure. Cover is too thick.

Accessories, continued

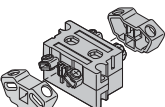
| | Description | Catalog Number |
|--|---|--------------------------|
| <p>E34TK3</p>  | <p>Thrust Washer—To meet Ford Motor Company mounting specifications.</p> | <p>E34TK3</p> |
| <p>10250TA7_</p>  | <p>Contact Block Terminal Jumps—Available in multiples of 100 only.</p> <p>Terminal to terminal—within block (short):</p> <p>100 per package 10250TA70</p> <p>1000 per package 10250TA70-2</p> <p>Terminal to terminal—block to block (long):</p> <p>100 per package 10250TA71</p> <p>1000 per package 10250TA71-2</p> | |
| <p>10250TMT8</p>  | <p>Master Test (Dual Input) Module—Internal Form C relay suitable for either AC or DC applications. Total electrical isolation between monitored and test circuit. Fits all illuminated 10250T, E22, E30 and E34 devices.</p> <p>48 Vdc 10250TMT8</p> | |
| <p>10250TFL_</p>  | <p>Flasher Module—Internal Form C relay suitable for AC applications. One unit required for each operator in master test circuit.</p> <p>24 Vac 10250TFL2</p> <p>120 Vac 10250TFL1</p> | |
| <p>E22CW</p>  | <p>Panel Mounting Nut Wrench—E22, E30, E34 and octagonal 10250T.</p> | <p>E22CW</p> |
| <p>10250TA101</p>  | <p>Fingerproof Shroud—10 per package. Fits new style contact blocks and light units.</p> | <p>10250TA101</p> |

Options

Legend Plates ①

Field Color

Legend plates can be supplied printed on black, red, silver or white field. To order legend printed on a color other than indicated—add

suffix code to the end of the catalog number as follows:

“R” for Red field;
“W” for White field; or
“S” for Silver field.

Example: E34SP26**R**—
Standard plate with red field marked OPEN.

Standard



Jumbo



For Pushbutton Operators and Indicating Lights

| Legend | Color of Field | Standard ② Catalog Number | Jumbo Catalog Number | Legend | Color of Field | Standard ② Catalog Number | Jumbo Catalog Number |
|--|----------------|---------------------------|----------------------|----------|----------------|---------------------------|----------------------|
| Letters on Legend Plates Below are 3/16 in High | | | | | | | |
| CLAMP | Black | E34SP90 | E34LP90 | OFF | Red | E34SP24 | E34LP24 |
| CLOSE | | E34SP73 | E34LP73 | ON | Black | E34SP25 | E34LP25 |
| DOWN | | E34SP74 | E34LP74 | OPEN | | E34SP26 | E34LP26 |
| EMERG. STOP | Red | E34SP13 | E34LP13 | OUT | | E34SP27 | E34LP27 |
| FAST | Black | E34SP75 | E34LP75 | POWER ON | | E34SP80 | E34LP80 |
| FASTER | | E34SP87 | E34LP87 | RAISE | | E34SP28 | E34LP28 |
| FEEDER ON | | E34SP94 | E34LP94 | READY | | E34SP86 | E34LP86 |
| FEEDER OFF | | E34SP95 | E34LP95 | RESET | | E34SP29 | E34LP29 |
| FORWARD | | E34SP15 | E34LP15 | REVERSE | | E34SP30 | E34LP30 |
| HIGH | | E34SP16 | E34LP16 | RUN | | E34SP31 | E34LP31 |
| IN | | E34SP17 | E34LP17 | SAFE | | E34SP85 | E34LP85 |
| INCH | | E34SP18 | E34LP18 | SLOW | | E34SP32 | E34LP32 |
| JOG | | E34SP19 | E34LP19 | SLOWER | | E34SP88 | E34LP88 |
| JOG FOR. | | E34SP20 | E34LP20 | START | | E34SP33 | E34LP33 |
| JOG REV. | | E34SP21 | E34LP21 | STOP | Red | E34SP34 | E34LP34 |
| LOW | | E34SP22 | E34LP22 | TEST | Black | E34SP83 | E34LP83 |
| LOWER | | E34SP23 | E34LP23 | TRANSFER | | E34SP93 | E34LP93 |
| LUBE-FAIL | | E34SP92 | E34LP92 | TRIP | | E34SP84 | E34LP84 |
| MOTOR RUN | | E34SP81 | E34LP81 | UNCLAMP | | E34SP91 | E34LP91 |
| MOTOR STOP | | E34SP82 | E34LP82 | UP | | E34SP35 | E34LP35 |

Blank Plastic Legend Plates—Square ③

| Color Lettering | Field Side 1 | Side 2 | Standard Catalog Number | Jumbo Catalog Number | Extra Large Catalog Number |
|-----------------|--------------|--------|-------------------------|----------------------|----------------------------|
| Black | White | Silver | 10250TSP76 | 10250TLP76 | 10250TEP76 |
| White | Red | Black | 10250TSP77 | 10250TLP77 | 10250TEP77 |

Notes

- ① For dimensions, see **Page V7-T1-288**.
- ② 3/32 in high lettering.
- ③ Legend plates with non-standard markings or aluminum legend plates see 10250T listing on **Page V7-T1-262**.

1

Standard



Jumbo



For Selector Switch Operators

| Legend | Color of Field | Standard Catalog Number | Jumbo Catalog Number | Legend | Color of Field | Standard Catalog Number | Jumbo Catalog Number |
|--|----------------|-------------------------|----------------------|--|----------------|-------------------------|----------------------|
| Two-Position—3/16 in High Lettering | | | | Three-Position—3/16 in High Lettering | | | |
| FOR. REV. | Black | E34SP38 | E34LP38 | AUTO OFF HAND | Black | E34SP49 | E34LP49 |
| HAND AUTO | | E34SP39 | E34LP39 | FOR. OFF REV. | | E34SP50 | E34LP50 |
| HIGH LOW | | E34SP40 | E34LP40 | FOR. SAFE REV. | | E34SP69 | E34LP69 |
| JOG RUN | | E34SP41 | E34LP41 | HAND OFF AUTO | | E34SP51 | E34LP51 |
| MAN. AUTO | | E34SP67 | E34LP67 | MAN. OFF AUTO | | E34SP68 | E34LP68 |
| OFF ON | | E34SP42 | E34LP42 | OPEN OFF CLOSE | | E34SP53 | E34LP53 |
| OPEN CLOSE | | E34SP43 | E34LP43 | RUN SAFE JOG | | E34SP70 | E34LP70 |
| RUN JOG | | E34SP44 | E34LP44 | UP OFF DOWN | | E34SP54 | E34LP54 |
| SAFE RUN | | E34SP45 | E34LP45 | ON STOP SAFE | | E34SP71 | E34LP71 |
| START JOG | | E34SP46 | E34LP46 | | | | |
| START STOP | | E34SP47 | E34LP47 | | | | |
| UP DOWN | | E34SP48 | E34LP48 | | | | |

For Push-Pull Units

| Legend | Color of Field | Standard ^① Catalog Number | Jumbo ^② Catalog Number |
|----------------------|----------------|--------------------------------------|-----------------------------------|
| PULL ON/PUSH OFF | Black | E34PP5 | E34R5 |
| PULL OPEN/PUSH CLOSE | Black | E34PP8 | E34R8 |
| PULL UP/PUSH DOWN | Black | E34PP11 | E34R11 |



Notes

- ① 3/32 in (2.4 mm) high lettering.
- ② 1/8 in (3.2 mm) high lettering.

Enclosures

Die Cast, Polyester and Stainless Steel Enclosures

Enclosures (Case and Cover)—Surface Mounting ^①

| | Number of Elements | One Contact Block Depth Catalog Number | Two Contact Block Depth Catalog Number |
|--|--|--|--|
| Die Cast Enclosure  | Die Cast Enclosure—In-Line ^{②③} NEMA 4, 4X, 12, 13 | | |
| | 1 | E34N1 | E34N11 |
| | 2 | E34N2 | E34N12 |
| | 3 | E34N3 | E34N13 |
| | 4 | — | E34N14 |
| Polyester Enclosure  | Polyester—In-Line NEMA 3, 4X, 12 | | |
| | 1 | — | E34N51 |
| | 2 | — | E34N52 |
| | 3 | — | E34N53 |
| | 4 | — | E34N54 |
| Stainless Steel Enclosure  | Stainless Steel ^④—In-Line NEMA 4, 4X, 12 | | |
| | 1 | — | 10250TN33 |
| | 2 | — | 10250TN34 |
| | 3 | — | 10250TN35 |
| | 4 | — | 10250TN36 |

Dimensions, see Page V7-T1-322.

Mounting Instructions

These E34 Die Cast Enclosures feature a corrosion resistant coating identical to finish on the E34 operators except gray in color. Not for use in ultraviolet light applications.

One and Two Contact Block Depth Enclosures



One Contact Block Depth Enclosure

Two Contact Block Depth Enclosure

Enclosure Layouts

Top – For Vertical Mounting

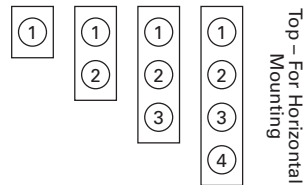

Notes

- ① For spacing increments, see **Page V7-T1-314**.
- ② All die cast enclosures can be converted to base mounting of contact blocks with spacers 10250TA22 or 10250TA23. See listing on **Page V7-T1-257**.
- ③ When used with E30 pushbuttons, only the one element enclosure can be used.
- ④ 14 gauge, type 304.

1 Die Cast and Stainless Steel—Flush Mount, Covers Only^①

Flush Mounting Covers



Covers Only—Flush Mounting

| Number of Elements | Catalog Number | Catalog Number |
|---|---------------------------|---------------------------|
| Flush Die Cast Covers | | |
| | In-Line Deep Cover | In-Line Flat Cover |
| 1 | E34F11 | E34F1 |
| 2 | E34F12 | E34F2 |
| 3 | E34F13 | E34F3 |
| 4 | E34F14 | E34F4 |
| In-Line Stainless Steel Flush Plates^② | | |
| | With Pullbox | Without Pullbox |
| 1 | 10250TS10 | 10250TS1 |
| 2 | 10250TS11 | 10250TS2 |
| 3 | 10250TS12 | 10250TS3 |
| 4 | 10250TS14 | 10250TS4 |
| Dimensions, see Page V7-T1-323. | | |

Spacing Increments

Approximate Dimensions in Inches (mm)

| Type | F | G | H |
|-----------------|-------------|------------------|-------------|
| Die cast | 2.44 (62.0) | 2.5 (63.5) | 1.88 (47.8) |
| Polyester | 1.88 (47.8) | Min. 2.13 (54.1) | 2.25 (57.2) |
| Stainless steel | 1.69 (42.9) | Min. 1.73 (43.9) | 2.25 (57.2) |

Spacing Increments for Enclosures

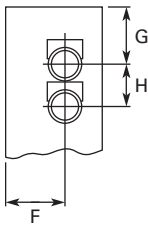

Enclosure Layouts

Top – For Vertical Mounting

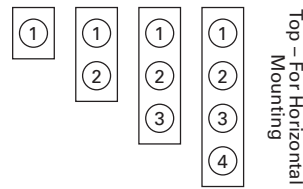

Notes

- ① These E34 die cast covers feature a corrosion resistant coating identical to the finish on the E34 operators except gray in color.
- ② Not oiltight. NEMA 1 applications only.

Contact Blocks

Standard Contact Blocks

- UL A600/P600 rated
- Color-coded plungers—red/green for NC/NO circuits
- Silver contact tips with “reliability nibs”
- Black (opaque) or amber (translucent) housings
- Pressure plate or spade terminals
- Fingerproof shrouds (for pressure terminals only)

Logic Level Contact Blocks

- UL A600/P600 rated
- Black plungers
- Inert palladium knife-blade contacts
- Black (opaque) housings
- Pressure plate or spade terminals
- Fingerproof shrouds not available

Special Function Contact Blocks

- UL A600/P600 rated
- Black plungers
- Silver contact tips with “reliability nibs”
- Black (opaque) housings
- Pressure plate terminals only
- Fingerproof shrouds not available

Special Purpose Contact Block

- Maximum 300V rated
- Black plungers
- Silver contact tips with “reliability nibs”
- Black (opaque) housings
- Pressure plate terminals only
- Fingerproof shrouds not available

Reliability Nibs

Reliability nibs are the hallmark of Eaton’s contact blocks. A pointed silver nib on the contact tip ensures reliable switching from logic level (5V) up to 600V applications. Therefore standard contact blocks can be used for most logic level applications where the contacts are not exposed to any harsh environmental conditions.

Palladium Contacts

Palladium, which is more inert than gold, is well suited for voltages and currents approaching zero and is recommended for applications where environmental conditions are a factor.

Maximum Contact Block Mounting per Operator Type

| Operator | Max. Stack |
|--|------------|
| Pushbuttons | 6 |
| Push-pull operators | 2 |
| Roto-push operators | 4 |
| Two- or three-position selector switches | 6 |
| Four-position selector switches | 4 |
| Joysticks | 4 |

10250T1



Contact Blocks

| Symbol | Circuit | Description ^① | Standard | Spade Terminal ^② | Logic Level | Spade Terminal ^② |
|---|--------------------------|--|-------------------------------------|-----------------------------|-------------------------------------|-----------------------------|
| | | | Pressure Terminal Catalog Number | Catalog Number | Pressure Terminal Catalog Number | Catalog Number |
| | Blank No Plunger 1NC | Stack up to six blocks (six circuits) unless otherwise noted. | 10250T51 | 10250T59 | 10250T51E | 10250T59E |
| | Blank No Plunger 1NO | Stack up to six blocks (six circuits) unless otherwise noted. | 10250T53 | 10250T60 | 10250T53E | 10250T60E |
| | NO-NC | Stack up to six blocks (12 circuits) unless otherwise noted. | 10250T1 | 10250T40 | 10250T1E | 10250T40E |
| | 2NC | Stack up to six blocks (12 circuits) unless otherwise noted. | 10250T3 | 10250T42 | 10250T3E | 10250T42E |
| | 2NO | Stack up to six blocks (12 circuits) unless otherwise noted. | 10250T2 | 10250T41 | 10250T2E | 10250T41E |
| Special Function Blocks ^③ | | | | | | |
| | Blank No Plunger LONC | Late opening NC. Stack up to six blocks (six circuits) unless otherwise noted. | 10250T71 ^③ | — | 10250T71E ^③ | — |
| | ECNO-NC | Early closing NO and standard NC. Stack up to six blocks unless otherwise noted. | 10250T47 ^{③④} | — | 10250T47E ^③ | — |
| | ECNO-NO | Early closing NO and standard NO. Stack up to four blocks unless otherwise noted. | 10250T57 ^{③④} | — | 10250T57E ^③ | — |
| | 2LONC | Two late opening NC contacts. Stack up to six blocks unless otherwise noted. | 10250T45 ^③ | — | 10250T45E ^③ | — |
| | LONC-ECNO | Overlapping contacts. Stack up to four blocks unless otherwise noted. | 10250T55 ^{③④} | — | 10250T55E ^③ | — |
| Special Purpose Blocks ^⑤ | | | | | | |
| | 2NO-2NC | Four circuits in single block depth. Rated 300V max. Stack up to four blocks unless otherwise noted. | 10250T44 ^⑤ | — | | |

Notes

- ^① All 10250T contact blocks shown are suitable for use on standard 10250T and E34 operators. These contact blocks are not suitable for Class I Division 2 type 10250T or E34 devices.
- ^② Contact blocks with spade terminals are limited to a maximum of one contact block per operator and minimum spacing between devices is 2.5 in (63.5 mm). Not suitable for use in 10250T or E34 enclosures. Also available in amber housing. Not available with fingerproof shrouds.
- ^③ Special function contact blocks are not suitable for use with roto-push operators, three-position push-pull operators, or four-position selector switches.
- ^④ ECNO contact blocks are not suitable for use with two-position joysticks or when operators are used with padlock attachments.
- ^⑤ Special purpose 10250T44 contact blocks are not suitable on selector switches or roto-push operators. Okay to use with three-position push-pull operators only on low voltage (30V or less) circuits.

10250T1CP



Contact Blocks with Fingerproof Shrouds

| Symbol | Circuit | Description ^① | Standard Pressure Terminal ^② Catalog Number | Logic Level Pressure Terminal ^② Catalog Number |
|---|-----------|---|--|---|
| Blank No Plunger | 1NC | Stack up to six blocks (six circuits) unless otherwise noted. | 10250T51P | 10250T51EP |
| Blank No Plunger | 1NO | Stack up to six blocks (six circuits) unless otherwise noted. | 10250T53P | 10250T53EP |
| Blank No Plunger | NO-NC | Stack up to six blocks (12 circuits) unless otherwise noted. | 10250T1P | 10250T1EP |
| Blank No Plunger | 2NC | Stack up to six blocks (12 circuits) unless otherwise noted. | 10250T3P | 10250T3EP |
| Blank No Plunger | 2NO | Stack up to six blocks (12 circuits) unless otherwise noted. | 10250T2P | 10250T2EP |
| Special Function Blocks ^③ | | | | |
| Blank No Plunger | LONC | Late opening NC. Stack up to six blocks (six circuits) unless otherwise noted. | 10250T71P ^④ | 10250T71EP ^④ |
| Blank No Plunger | ECNO-NC | Early closing NO and standard NC. Stack up to six blocks unless otherwise noted. | 10250T47P ^{③④} | 10250T47EP ^④ |
| Blank No Plunger | ECNO-NO | Early closing NO and standard NO. Stack up to four blocks unless otherwise noted. | 10250T57P ^{③④} | 10250T57EP ^④ |
| Blank No Plunger | 2LONC | Two late opening NC contacts. Stack up to six blocks unless otherwise noted. | 10250T45P ^④ | 10250T45EP ^④ |
| Blank No Plunger | LONC-ECNO | Overlapping contacts. Stack up to four blocks unless otherwise noted. | 10250T55P ^{③④} | 10250T55EP ^④ |

Replacement Parts

Replacement Lamps—For E34 Illuminated Operators

| Mfg. Lamp Type | Voltage | Base Style | Application | Part Number |
|----------------|---------|-----------------|---|---------------------|
| 120MB | 120V | T 3-1/4 bayonet | 10250T resistor indicating light | 28-3044 |
| #267 | 6.3V | T 3-1/4 bayonet | 10250T flasher | 10250ED986-4 |
| #755 | 6.3V | T 3-1/4 bayonet | 10250T transformer, PresTest and full voltage | 28-2202 |
| #756 | 12V | T 3-1/4 bayonet | 10250T full voltage | 28-5184 |
| #757 | 24V | T 3-1/4 bayonet | 10250T full voltage | 28-5185 |
| #1828 | 32V | T 3-1/4 bayonet | 10250T full voltage | 28-5186 |
| #1835 | 55V | T 3-1/4 bayonet | 10250T resistor | 28-5187 |
| NE48 | 120V | T 4-1/2 bayonet | 10250T neon | 28-494 |
| NE51H-R22 | 120V | T 3-1/4 bayonet | 10250T neon | 28-3754 |
| NE51H-R68 | 240V | T 3-1/4 bayonet | 10250T neon | 28-3755 |

Notes

- ① All 10250T contact blocks shown are suitable for use on standard 10250T and E34 operators. These contact blocks are not suitable for Class I Division 2 type 10250T or E34 devices.
- ② To order contact blocks with translucent amber housing, change suffix P to **CP** in catalog number, e.g., 10250T51**CP**.
- ③ ECNO contact blocks are not suitable for use with two-position joysticks or when operators are used with padlock attachments.
- ④ Special function contact blocks are not suitable for use with roto-push operators, three-position push-pull operators, or four-position selector switches.

1.10

Pushbuttons and Indicating Lights

30.5 mm Corrosion Resistant Watertight/Oiltight—E34

1



Flush Head Pushbutton Operator



Mushroom Head Pushbutton Operator



Jumbo Mushroom Head Operator

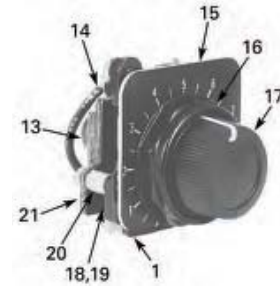

Potentiometers



Illuminated Pushbutton Operator



Transformer Type Indicating Light



Knob-Operated Selector Switch Operator

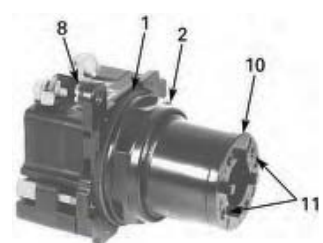

Full Voltage, Resistor and Transformer Type Illuminated Selector Switch

E34 Style Operator Replacement Parts

| Item No. | Description | No. Req. | Part Number |
|----------|---|----------|---------------|
| 1 | Gasket | 1 | 16-1548 |
| 2 | Mounting nut | 1 | 15-1530-4 |
| 3 | Set screw (#6-32 x 0.250 in long hollow hex) | 2 | 11-2014 |
| 4 | Mushroom head button (includes [2] item 5) | 1 | As Req. Below |
| | Black | — | 53-1317 |
| | Red | — | 53-1317-2 |
| | Yellow | — | 53-1317-3 |
| | Green | — | 53-1317-4 |
| | Blue | — | 53-1317-22 |
| 5 | Set screw (#10-32 x 0.250 in long hollow hex) | 2 | 11-544 |
| 6 | Jumbo mushroom head button (aluminum—includes [2] item 5) | 1 | As Req. Below |
| | Red | — | 53-1317-9 |
| | Black | — | 53-1317-10 |
| | Yellow | — | 53-1317-11 |
| | Green | — | 53-1317-12 |
| 7 | Jumbo mushroom head button (aluminum—red EMERG. STOP) does not include item 5 | 1 | 53-1349-18 |
| 8 | Mounting screw (#6-32 x 0.710 in long) | 2 | 10250TA79 |
| | Washer | 2 | 16-2038 |
| 9 | Terminal screw and lug (captive) | Req. | 80-5502 |
| 10 | Gasket (supplied with basic unit) | 1 | 32-803 |
| 11 | Round head screw (#4-40 x 0.344 in long) (supplied with basic unit) | 2 | 11-4553 |

| Item No. | Description | No. Req. | Part Number |
|----------|--|----------|----------------------|
| 12 | Mounting screw | 2 | 11-1632 |
| 13 | Simple potentiometer (does not include items 18, 28 or 29) | 1 | As Req. Below |
| | 1,000 ohms | — | 41-782-2 |
| | 2,500 ohms | — | 41-782-3 |
| | 5,000 ohms | — | 41-782-10 |
| | 10,000 ohms | — | 41-782-4 |
| | 25,000 ohms | — | 41-782-5 |
| | 50,000 ohms | — | 41-782-6 |
| 14 | Connector (includes screw and lug) | 2 | 25-1851 |
| 15 | Indicating plate | 1 | As Req. Above |
| | Standard size (without legend) | — | 30-4460 |
| | Large size (specify legend) | — | 10250TR30 |
| 16 | Retaining nut | 1 | 15-1547-3 |
| 17 | Knob | 1 | 53-1314 |
| | Socket set screw (#6-32 x 0.250 in long) | 1 | 11-2014 |
| 18 | Coupling | 1 | 11-2014 29-3749-2 |
| 19 | Set screw (#6-32 x 0.188 in long) | 1 | 11-1199 |
| 20 | Spacer | 2 | 56-1066-18 |
| 21 | Connector (includes screw and lug) | 1 | 25-1851-2 |
| 22 | Mounting nut | 1 | 15-1938-2 |

Technical Data and Specifications

Mechanical Ratings

| Description | Specification |
|---------------------------------|-----------------------------------|
| Frequency of Operation | |
| All pushbuttons | 6000 operations/hr. |
| Key and lever selector switches | 3000 operations/hr. |
| Auto-latch devices | 1200 operations/hr. |
| Life | |
| Pushbuttons | 10 x 10 ⁶ operations |
| Contact blocks | 10 x 10 ⁶ operations |
| PresTest units | 10 x 10 ⁶ operations |
| Lever and key selector switches | 0.25 x 10 ⁶ operations |
| Twist to release pushbuttons | 0.3 x 10 ⁶ operations |
| Shock Resistance | |
| Duration | 210 ms ≥5g |

General Specifications

| Description | Specification |
|--|---|
| Climate Conditions | |
| Operating temperature | 1° to 150°F (–17° to 66°C) |
| Storage temperature | –40° to 176°F (–40° to 80°C) |
| Altitude | 6,562 ft (2,000m) |
| Humidity | Max. 95% RH at 60°C |
| Terminals | |
| Marking | NC-NO on the contact block to meet the NEMA requirements. Dual marking system 1–2 for normally closed, 3–4 for normally open to meet BS5472 (Cenelec EN50 005). |
| Clamps | Terminals are saddle clamp type for 1 x 22 AWG (0.34 mm ²) to 2 x 14 AWG (2.5 mm ²) conductors |
| Torque | 7 lb-in (0.8 Nm) |
| Degree of protection against direct electrical contact | IP2X with fingerproof shroud |
| Light Units | |
| Transformers | Will withstand short-circuit for 1 hour per IEC 60947-5-1 |
| Bulbs—average life: | |
| Transformer type | 20,000 hrs. |
| Resistor/direct voltage type | 2500 hrs. minimum at rated V |
| LED | 60,000 to 100,000 hrs. |

Electrical Ratings

| Description | Specification |
|---|---|
| Insulation | $U_i = 660 \text{ Vac or Vdc}$ |
| Thermal | $I_{th} = 10\text{A}$ |
| Short Circuit Coordination to IEC/EN 60947-5-1 | |
| Rated conditional short circuit current | 1 kA |
| Fuse type | GE power controls TIA 10, red spot type gG, 10A, 660 Vac, 460 Vdc, BS88-2, IEC 60269-2-1 |
|  | |
| UL rating | A600, P600 |
| AC load life duty cycle 1200 operations/hour | |
| 10A | 110V pf 0.4— 1×10^6 operations |
| 5A | 250V pf 0.4— 1×10^6 operations |
| 2A | 600V pf 0.4— 1×10^6 operations |
| Switching capacity | |
| AC 15 rated make/break ($11 \times I_b$ at $1.1 \times U_b$) | |
| 6A | 120V pf 0.3 |
| 4A | 240V pf 0.3 |
| 2A | 660V pf 0.3 |
| DC13 rated make/break ($1.1 \times I_b$ at $1.1 \times U_b$) | |
| 1.0A | 125V L/R ≥ 0.95 at 300 ms |
| 0.55A | 250V L/R ≥ 0.95 at 300 ms |
| 0.1A | 660V L/R ≥ 0.95 at 300 ms |
| 10A | 110V pure resistive |
| Maximum ratings for logic level and hostile atmosphere application | |
| Maximum amperes | 0.5A |
| Maximum volts | 120 Vac/Vdc |
| Low voltage switching | Conical shaped points or “reliability nibs” improve performance in dry circuit, corrosive, fine dust and other contaminated atmospheres. Under normal environmental conditions, the minimum operational voltage is 5V and the minimum operational current is 1 mA, Vac/Vdc. |
| Contact operation | Slow make and break. All normally closed contacts have positive opening operation, i.e., normally closed contacts are forced open in the event of contact weld or spring breakage. |

Electrical Ratings—Contact Block

Meet or Exceed NEMA Rating Designations A600, A300 and B300 for AC and P600 for DC

| Description | 50 Vac or 60 H | | | | Vdc | | |
|---|----------------|------|------|------|-------|-----|------|
| | 120 | 240 | 480 | 600 | 24/28 | 125 | 250 |
| Meet or Exceed NEMA Rating Designations A600, A300 and B300 for AC and P600 for DC | | | | | | | |
| Make and emerg. interrupting capacity (amp) | 60 | 30 | 15 | 12 | 5.7 | 1.1 | 0.55 |
| Normal load break (amp) | 6 | 3 | 1.5 | 1.2 | 5.7 | 1.1 | 0.55 |
| Thermal current (amp) | 10 | 10 | 10 | 10 | 5.0 | 5.0 | 5.0 |
| Voltamperes: | | | | | | | |
| Make and emerg. interrupting capacity | 7200 | 7200 | 7200 | 7200 | 138 | 138 | 138 |
| Normal load break | 720 | 720 | 720 | 720 | 138 | 138 | 138 |

Mounting Options

Panel Thickness

- Minimum: 0.06 in (1.6 mm)
- Maximum: 0.25 in (8 mm) including legend plate
- Maximum can be increased to 0.375 in (15.9 mm) using optional retaining nut
 - Indicating light: 10250TA30
 - Pushbutton/selector switch: 10250TA31

Mounting Matrix

| Legend Plate | Dimensions in Inches (mm) | | | |
|--------------|---------------------------|-------------|-------------|-------------|
| | A | B | C | D |
| Small | 1.63 (41.3) | 2.25 (57.2) | 2.25 (57.2) | 1.63 (41.3) |
| Medium | 1.75 (44.5) | 2.25 (57.2) | 2.25 (57.2) | 1.75 (44.5) |
| Large | 2.25 (57.2) | 2.25 (57.2) | 2.25 (57.2) | 2.25 (57.2) |

Mounting Options in Inches (mm)

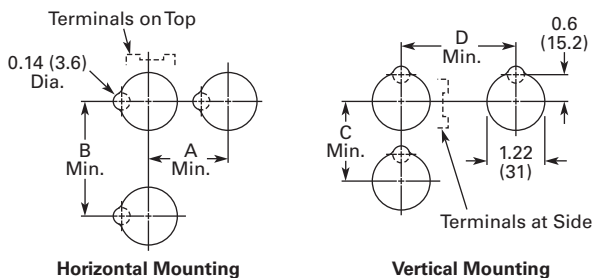

Horizontal mounting means terminals are located top and bottom of contact block. Vertical mounting means terminals are left and right of contact block. This allows close spacing of adjacent operators with easy access to terminals.

Locating nib hole or notch is 0.14 in (3.6 mm) #29 drill.

Drilling Dimensions in Inches (mm)

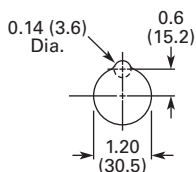

1.10

Pushbuttons and Indicating Lights

30.5 mm Corrosion Resistant Watertight/Oiltight—E34

1

Dimensions

Approximate Dimensions in Inches (mm)

Potentiometer

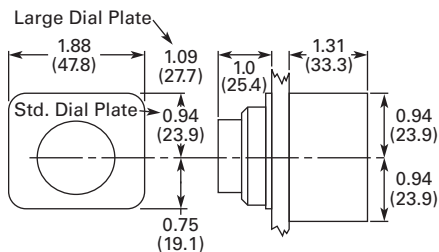

Legend Plates

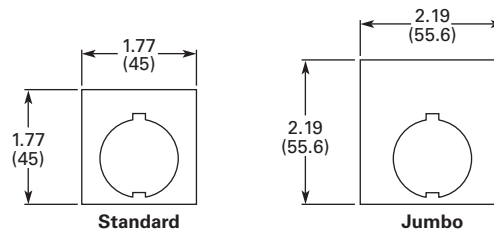

Surface Mounting

Die Cast, Polyester and Stainless Steel Enclosures

4 Mtg. Holes — 10-32 Screw Size for
1 – 4 Element Die Cast/
Stainless Steel Enclosure
7/32 Screw Size for
Polyester

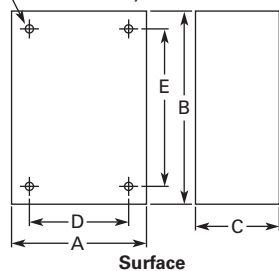

| Number of Elements | Element Arrangement | Wide A | High B | Deep C | Mounting D | E | Conduit Entrance |
|------------------------|---------------------|-------------|---------------|---------------|-------------|---------------|------------------|
| Die Cast | | | | | | | |
| 1 | In-line | 3.88 (98.6) | 4.00 (101.6) | 3.00 (76.3) ① | 2.69 (68.3) | 3.25 (82.6) | 3/4 |
| 2 | | 3.88 (98.6) | 5.88 (149.4) | 3.00 (76.3) ① | 2.69 (68.3) | 5.13 (130.3) | |
| 3 | | 3.88 (98.6) | 7.75 (196.9) | 3.00 (76.3) ① | 2.69 (68.3) | 7.00 (177.8) | 1 |
| 4 | | 3.88 (98.6) | 9.63 (244.6) | 3.00 (76.3) ① | 2.69 (68.3) | 8.88 (225.6) | |
| Polyester | | | | | | | |
| 1 | In-line | 3.81 (96.8) | 6.63 (168.4) | 3.38 (85.9) | 2.94 (74.7) | 4.88 (124.0) | ② |
| 2 | | 3.81 (96.8) | 6.63 (168.4) | 3.38 (85.9) | 2.94 (74.7) | 4.88 (124.0) | |
| 3 | | 3.81 (96.8) | 8.88 (225.6) | 3.38 (85.9) | 2.94 (74.7) | 7.13 (181.1) | |
| 4 | | 3.81 (96.8) | 11.13 (282.7) | 3.38 (85.9) | 2.94 (74.7) | 9.38 (238.3) | |
| Stainless Steel | | | | | | | |
| 1 | In-line | 3.00 (76.2) | 3.50 (88.9) | 3.00 (76.2) | 1.50 (38.1) | 4.25 (108.0) | ② |
| 2 | | 3.50 (88.9) | 6.75 (171.5) | 3.00 (76.2) | 1.50 (38.1) | 7.50 (190.5) | |
| 3 | | 3.50 (88.9) | 9.00 (228.6) | 3.00 (76.2) | 1.50 (38.1) | 9.00 (228.6) | |
| 4 | | 3.50 (88.9) | 11.25 (285.8) | 3.00 (76.2) | 1.50 (38.1) | 12.00 (304.8) | |

Notes

- ① Depth given is for two contact block deep stations. One contact block deep stations subtract 3/4 in (19.1 mm).
- ② No conduit entrance holes provided. Drill as required.

Approximate Dimensions in Inches (mm)

Flush Mounting

Die Cast and Stainless Steel Covers Only

4 Mtg. Holes - 10-32 Screw Size
for 1-11 Element Encl, 1/4-20
Screw Size for 12 Element
and Larger

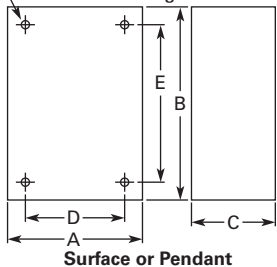

| Number of Elements | Wide A | High B | Deep C | Mounting D | E |
|------------------------|--------------|---------------|---------------|-------------|--------------|
| Die Cast | | | | | |
| 1 | 3.88 (98.6) | 4.00 (101.6) | 0.25 (6.4) ① | 3.50 (88.9) | 3.63 (92.2) |
| 2 | 3.88 (98.6) | 5.88 (149.4) | 0.25 (6.4) ① | 3.50 (88.9) | 5.50 (139.7) |
| 3 | 3.88 (98.6) | 7.75 (196.9) | 0.25 (6.4) ① | 3.50 (88.9) | 6.00 (152.4) |
| 4 | 3.88 (98.6) | 9.63 (244.6) | 0.25 (6.4) ① | 3.50 (88.9) | 9.25 (235.0) |
| Stainless Steel | | | | | |
| 1 | 5.00 (127.0) | 5.00 (127.0) | 2.50 (63.5) ② | 3.25 (82.6) | 1.88 (47.8) |
| 2 | 5.00 (127.0) | 6.88 (174.8) | 2.50 (63.5) ② | 3.25 (82.6) | 3.63 (92.2) |
| 3 | 5.00 (127.0) | 8.63 (219.2) | 2.50 (63.5) ② | 3.25 (82.6) | 5.50 (139.7) |
| 4 | 5.00 (127.0) | 10.50 (266.7) | 2.50 (63.5) ② | 3.25 (82.6) | 7.25 (184.2) |

Notes

- ① Depth given is for flat cover. Deep cover is 3/4 in (19.1 mm) deeper.
- ② Depth given includes pull box.

1.10

Pushbuttons and Indicating Lights

30.5 mm Corrosion Resistant Watertight/Oiltight—E34

1

Approximate Dimensions in Inches (mm)

Padlocking Attachment for Flush Pushbutton Operators

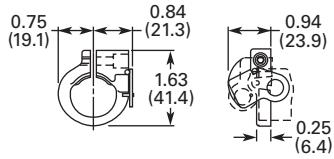

Flexible Weather Resistant Boot

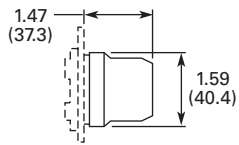

Transparent Boot

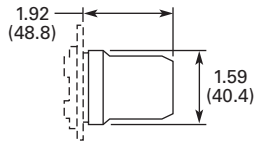

Shroud for Mushroom Head Operator

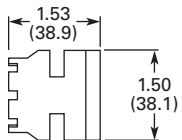

Extended Retaining Nut

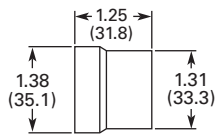

Guard for Illuminated Pushbutton

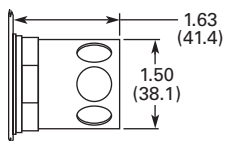

Contact Block Terminal Jumps

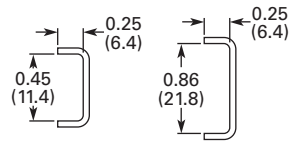

Master Test Module and Flasher Module

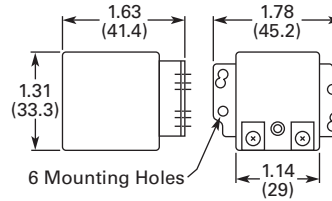

Flush Pushbutton

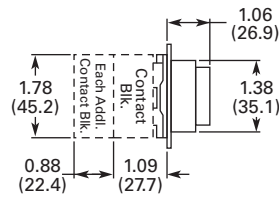

Extended Pushbutton

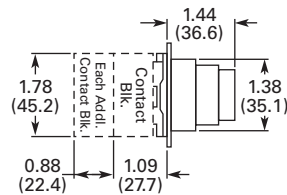

Half Shroud Pushbutton

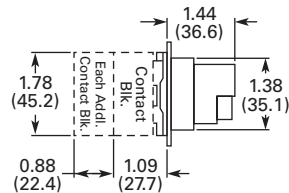

Approximate Dimensions in Inches (mm)

Mushroom Pushbutton

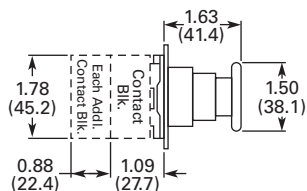

Illuminated Pushbutton

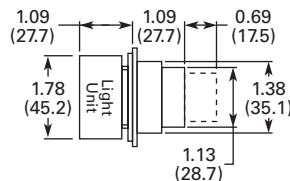

Jumbo Mushroom Pushbutton

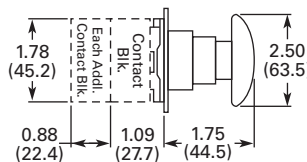

Selector Switch

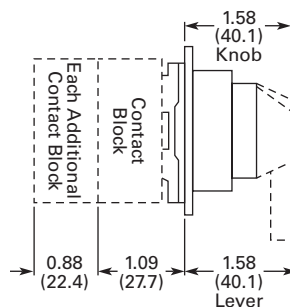

Push-Pull Switch

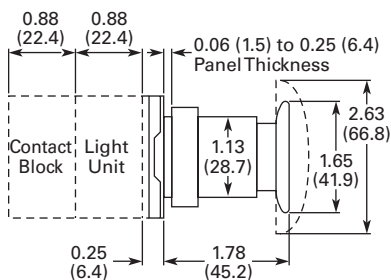

Key Selector Switch

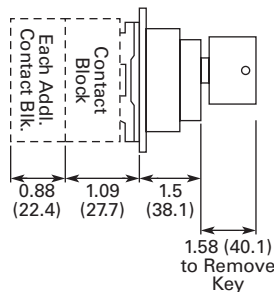

Indicating Light

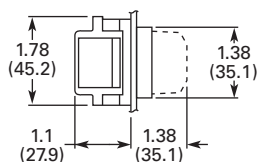

Illuminated Selector Switch

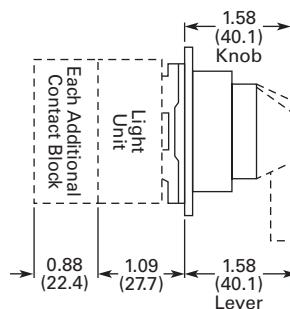

PresTest Indicating Light

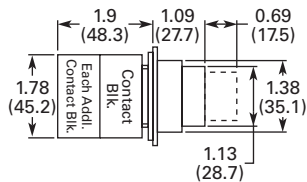



Product Description

The HT800 Series from Eaton's Electrical Sector is a family of 30.5 mm pushbutton devices which includes momentary, illuminated and mushroom head pushbuttons, selector switches, indicating lights and push-pull switches. The HT800 devices have a familiar appearance found in most industrial applications and are suitable for replacement of several other manufacturers' 30.5 mm pushbutton devices.

Features

- Anodized aluminum mounting rings
- Watertight double V-gasket seals
- Extended height bulbs
- Transparent housing contact blocks
- Color-coded contact blocks
- Gold-plated contacts (on low voltage contact block)
- Reliability ridge on movable contact
- Stackable screw-mounted contact blocks
- Contact blocks can be mounted in left/right or top/bottom positions
- Standard NC contact opens before NO contact closes (break before make operation)
- Bright and long lasting LED indicating lights in six colors
- Field convertible maintained selector switches—from two- to three-position and vice versa
- Field selectable knob/lever mounting positions—at any 22.5° increment

Contents

Description

| | <i>Page</i> |
|--|------------------|
| 30.5 mm Watertight/Oiltight—HT800 | |
| Catalog Number Selection | V7-T1-327 |
| Product Selection | |
| Momentary Pushbutton Units, Non-Illuminated | V7-T1-328 |
| Illuminated Pushbutton Units | V7-T1-330 |
| Guarded Illuminated Pushbutton Units | V7-T1-332 |
| Indicating Light Units | V7-T1-334 |
| Push-Pull Units | V7-T1-336 |
| Illuminated Push-Pull Units | V7-T1-337 |
| Selector Switch Units | V7-T1-338 |
| Selector Switch Contact Block Selection | V7-T1-340 |
| Accessories | V7-T1-341 |
| Options | V7-T1-342 |
| Replacement Parts | V7-T1-345 |
| Technical Data and Specifications | V7-T1-346 |
| Dimensions | V7-T1-347 |

Benefits

- Corrosion resistant NEMA 4X finish
- Watertight and oiltight NEMA 4, 13 ingress protection
- Increased side illumination of indicating lights and illuminated pushbuttons
- Easy visual inspection of contact conditions
- Easily identifiable NO (white) or NC (black) contact blocks
- Gold-plated contacts suitable for logic level circuits
- Reliability ridge penetrates contamination buildup on stationary contacts
- Left/right or top/bottom mounted contact blocks allow correct positioning in retrofit applications
- All-purpose selector switches are convertible and can rotate in 22.5° increments to suit panel layouts

Standards and Certifications

- UL508 per File No. E131568
- CSA C22.2 No. 14 per File No. LR68551



Ingress Protection

- UL (NEMA) Type 1, 2, 3, 3R, 4, 4X, 12 and 13 when mounted in similarly rated enclosures

Catalog Number Selection

Catalog Number Selection is for illustrative purposes only and not to be used to create new catalog numbers.

HT800 Pushbuttons, Push-Pulls and Indicating Lights

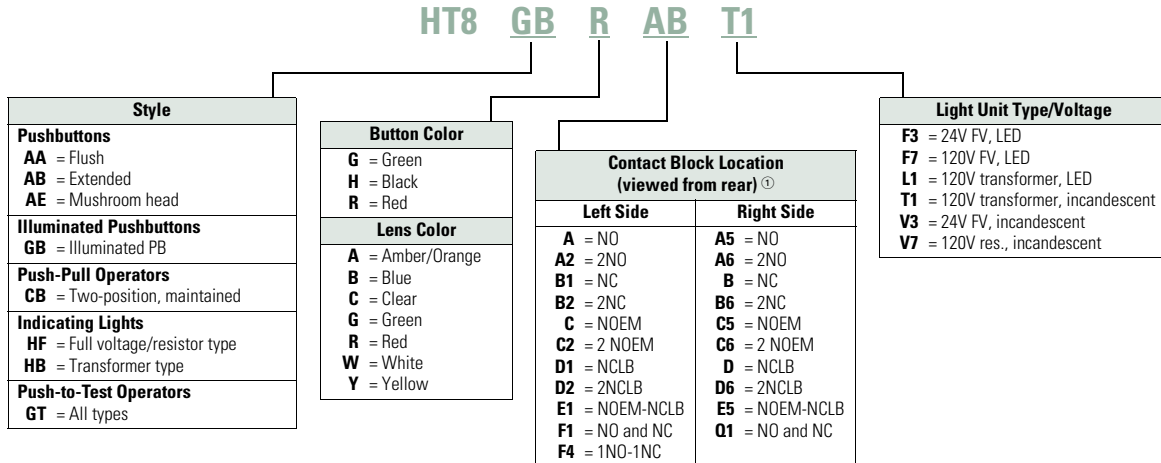

HT800 Selector Switch

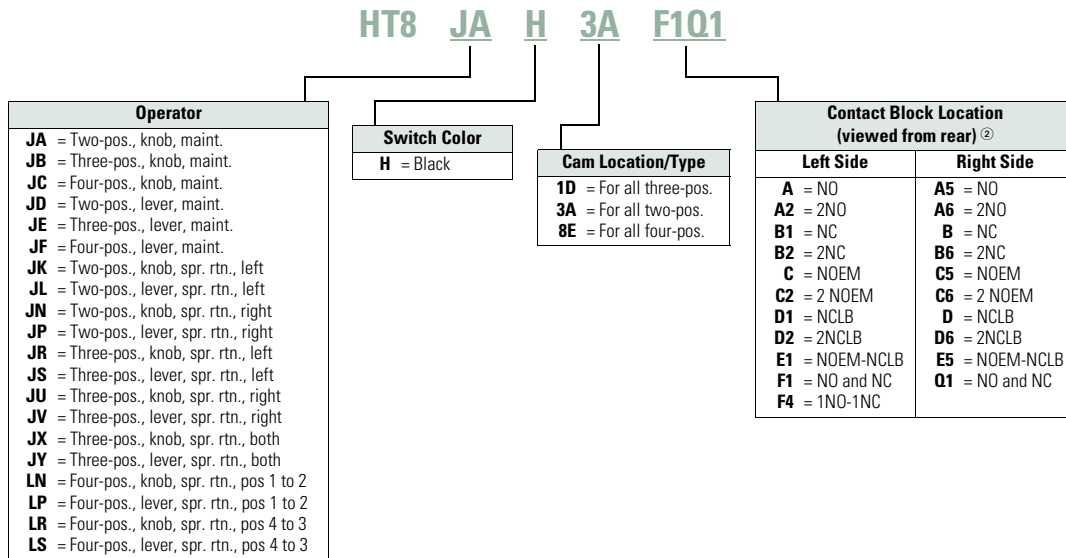

Notes

- ① Maximum of four contact blocks per side or a total of eight contact blocks recommended.
- ② Maximum of two contact blocks per side or a total of four contact blocks recommended.

Product Selection**Momentary Pushbutton Units, Non-Illuminated**

UL (NEMA) Type 3, 3R, 4, 4X, 12 and 13

- Flush, extended or 40 mm mushroom head operators

HT800 Pushbuttons**HT800 Pushbuttons—Point-of-Purchase Units**

| Description | Catalog Number |
|---|------------------------|
| Two-position maintained selector switch 1NO/1NC contact block, three square legend plates: OFF ON, MAN. AUTO, UP DOWN | HT8JAH3AAB-POP |
| Three-position maintained selector switch, black knob, 1NO/1NC contact block, three square legend plates: HAND OFF AUTO, FOR. OFF REV., OPEN OFF CLOSE | HT8JBH1DAB-POP |
| Three-position selector switch, spring return from left and right, black knob, 1NO/1NC contact block, three square legend plates: UP OFF DOWN, FOR OFF REV., OPEN OFF CLOSE | HT8JXH1DAB-POP |
| Red push-pull emergency stop, 1NO/1NC contact block, three square legend plates: STOP, EMERG. STOP, OFF | HT8CBRAB-POP |
| Illuminated push-pull maintained red pushbutton, 120V full voltage low profile LED, three square legend plates: STOP, EMERG. STOP, OFF | HT8FBRABFL7-POP |
| Illuminated push-pull maintained red pushbutton, 24V full voltage low profile LED, three square legend plates: STOP, EMERG. STOP, OFF | HT8FBRABFL3-POP |
| Green flush pushbutton, 1NO/1NC contact block, three square legend plates: START, ON, RUN | HT8AAGAB-POP |
| Black flush pushbutton, 1NO/1NC contact block, three square legend plates: RESET, JOG, OPEN | HT8AAHAB-POP |
| Red flush pushbutton, 1NO/1NC contact block, three square legend plates: STOP, CLOSE, OFF | HT8AARAB-POP |
| Red extended pushbutton, 1NO/1NC contact block, three square legend plates: STOP, CLOSE, OFF | HT8ABRAB-POP |
| Black extended pushbutton, 1NO/1NC contact block, three square legend plates: RESET, JOG, OPEN | HT8ABHAB-POP |
| Illuminated green pushbutton, 120V full voltage incandescent, 1NO/1NC contact block, three square legend plates: START, ON, RUN | HT8GBGABV7-POP |
| Illuminated green pushbutton, 24V full voltage incandescent, 1NO/1NC contact block, three square legend plates: START, ON, RUN | HT8GBGABV3-POP |

Flush Head Operator



Extended Head Operator



40 mm Mushroom Head Operator



Momentary Contact Pushbutton Units, Non-Illuminated

| Contact Type | Button Color | Flush Head Catalog Number | Extended Head Catalog Number | Mushroom Head (40 mm) Catalog Number |
|--------------|--------------|---------------------------|------------------------------|--------------------------------------|
| No contact | Black | HT8AAH | HT8ABH | HT8AEH |
| | Red | HT8AAR | HT8ABR | HT8AER |
| | Green | HT8AAG | HT8ABG | HT8AEG |
| 1NO | Black | HT8AAHA | HT8ABHA | HT8AEHA |
| | Red | HT8AARA | HT8ABRA | HT8AERA |
| | Green | HT8AAGA | HT8ABGA | HT8AEGA |
| 1NC | Black | HT8AAHB | HT8ABHB | HT8AEHB |
| | Red | HT8AARB | HT8ABRB | HT8AERB |
| | Green | HT8AAGB | HT8ABGB | HT8AEGB |
| 1NO-1NC | Black | HT8AAHAB | HT8ABHAB | HT8AEHAB |
| | Red | HT8AARAB | HT8ABRAB | HT8AERAB |
| | Green | HT8AAGAB | HT8ABGAB | HT8AEGAB |
| 2NO-2NC | Black | HT8AAHF1Q1 | HT8ABHF1Q1 | HT8AEHF1Q1 |
| | Red | HT8AARF1Q1 | HT8ABRF1Q1 | HT8AERF1Q1 |
| | Green | HT8AAGF1Q1 | HT8ABGF1Q1 | HT8AEGF1Q1 |

1

Illuminated Pushbutton Units

UL (NEMA) Type 3, 3R, 4, 4X, 12 and 13

- Incandescent or LED
- Full voltage or transformer type
- 24V and 120V

Illuminated Pushbutton Operator



Illuminated Pushbuttons

| Type | Volts | Lens Color | Operator Only Catalog Number | 1NO Catalog Number | 1NC Catalog Number | 1NO-1NC Catalog Number | 2NO-2NC Catalog Number |
|--------------------------|-----------------|------------------|------------------------------|--------------------|---------------------|------------------------|------------------------|
| Incandescent Lamp | | | | | | | |
| Full voltage | 120 Vac/Vdc | No lens ① | HT8GBFV | — | — | — | — |
| | | Red | HT8GBRV7 | HT8GBRAV7 | HT8GBRBV7 | HT8GBRABV7 | HT8GBRF1Q1V7 |
| | | Green | HT8GBGV7 | HT8GBGAV7 | HT8GBGBV7 | HT8GBGABV7 | HT8GBGF1Q1V7 |
| | | Amber | HT8GBAV7 | HT8GBAAV7 | HT8GBABV7 | HT8GBAABV7 | HT8GBAF1Q1V7 |
| | | Clear | HT8GBCV7 | HT8GBCAV7 | HT8GBCBV7 | HT8GBCABV7 | HT8GBCF1Q1V7 |
| | | White | HT8GBWV7 | HT8GBWAV7 | HT8GBWBV7 | HT8GBWABV7 | HT8GBWF1Q1V7 |
| | | Yellow | HT8GBYV7 | HT8GBYAV7 | HT8GBYBV7 | HT8GBYABV7 | HT8GBYF1Q1V7 |
| | Blue | HT8GBBV7 | HT8GBBAV7 | HT8GBBBV7 | HT8GBBABV7 | HT8GBBF1Q1V7 | |
| | 24 Vac/Vdc | No lens ① | HT8GBFV | — | — | — | — |
| | | Red | HT8GBRV3 | HT8GBRAV3 | HT8GBRBV3 | HT8GBRABV3 | HT8GBRF1Q1V3 |
| | | Green | HT8GBGV3 | HT8GBGAV3 | HT8GBGBV3 | HT8GBGABV3 | HT8GBGF1Q1V3 |
| | | Amber | HT8GBAV3 | HT8GBAAV3 | HT8GBABV3 | HT8GBAABV3 | HT8GBAF1Q1V3 |
| | | Clear | HT8GBCV3 | HT8GBCAV3 | HT8GBCBV3 | HT8GBCABV3 | HT8GBCF1Q1V3 |
| | | White | HT8GBWV3 | HT8GBWAV3 | HT8GBWBV3 | HT8GBWABV3 | HT8GBWF1Q1V3 |
| Yellow | | HT8GBYV3 | HT8GBYAV3 | HT8GBYBV3 | HT8GBYABV3 | HT8GBYF1Q1V3 | |
| Transformer | 120 Vac | No lens ① | HT8GBT1 | — | — | — | — |
| | | Red | HT8GBRT1 | HT8GBRAT1 | HT8GBRBT1 | HT8GBRABT1 | HT8GBRF1Q1T1 |
| | | Green | HT8GBGT1 | HT8GBGAT1 | HT8GBGBT1 | HT8GBGABT1 | HT8GBGF1Q1T1 |
| | | Amber | HT8GBAT1 | HT8GBAAT1 | HT8GBABT1 | HT8GBAABT1 | HT8GBAF1Q1T1 |
| | | Clear | HT8GBCT1 | HT8GBCAT1 | HT8GBCBT1 | HT8GBCABT1 | HT8GBCF1Q1T1 |
| | | White | HT8GBWT1 | HT8GBWAT1 | HT8GBWBT1 | HT8GBWABT1 | HT8GBWF1Q1T1 |
| | | Yellow | HT8GBYT1 | HT8GBYAT1 | HT8GBYBT1 | HT8GBYABT1 | HT8GBYF1Q1T1 |
| Blue | HT8GBBT1 | HT8GBBAT1 | HT8GBBBT1 | HT8GBBABT1 | HT8GBBF1Q1T1 | | |

Note

① Light unit base operator without lens or bulb.

UL (NEMA) Type 3, 3R, 4, 4X, 12 and 13

Illuminated Pushbutton Operator



Illuminated Pushbuttons, continued

| Type | Volts | Lens Color | Operator Only Catalog Number | 1NO Catalog Number | 1NC Catalog Number | 1NO-1NC Catalog Number | 2NO-2NC Catalog Number |
|--------------|-----------------|------------------|------------------------------|--------------------|---------------------|------------------------|------------------------|
| LED | | | | | | | |
| Full voltage | 120 Vac/Vdc | No lens ① | HT8GBFV | — | — | — | — |
| | | Red | HT8GBRF7 | HT8GBRAF7 | HT8GBRBF7 | HT8GBRABF7 | HT8GBRF1Q1F7 |
| | | Green | HT8GBGF7 | HT8GBGAF7 | HT8GBGBF7 | HT8GBGABF7 | HT8GBGF1Q1F7 |
| | | Amber | HT8GBAF7 | HT8GBAAF7 | HT8GBABF7 | HT8GBAABF7 | HT8GBAF1Q1F7 |
| | | Clear | HT8GBCF7 | HT8GBCAF7 | HT8GBCBF7 | HT8GBCABF7 | HT8GBCF1Q1F7 |
| | | White | HT8GBWF7 | HT8GBWAF7 | HT8GBWBF7 | HT8GBWABF7 | HT8GBWF1Q1F7 |
| | | Yellow | HT8GBYF7 | HT8GBYAF7 | HT8GBYBF7 | HT8GBYABF7 | HT8GBYF1Q1F7 |
| | Blue | HT8GBBF7 | HT8GBBAF7 | HT8GBBBF7 | HT8GBBABF7 | HT8GBBF1Q1F7 | |
| | 24 Vac/Vdc | No lens ① | HT8GBFV | — | — | — | — |
| | | Red | HT8GBRF3 | HT8GBRAF3 | HT8GBRBF3 | HT8GBRABF3 | HT8GBRF1Q1F3 |
| | | Green | HT8GBGF3 | HT8GBGAF3 | HT8GBGBF3 | HT8GBGABF3 | HT8GBGF1Q1F3 |
| | | Amber | HT8GBAF3 | HT8GBAAF3 | HT8GBABF3 | HT8GBAABF3 | HT8GBAF1Q1F3 |
| | | Clear | HT8GBCF3 | HT8GBCAF3 | HT8GBCBF3 | HT8GBCABF3 | HT8GBCF1Q1F3 |
| | | White | HT8GBWF3 | HT8GBWAF3 | HT8GBWBF3 | HT8GBWABF3 | HT8GBWF1Q1F3 |
| Yellow | | HT8GBYF3 | HT8GBYAF3 | HT8GBYBF3 | HT8GBYABF3 | HT8GBYF1Q1F3 | |
| Blue | HT8GBBF3 | HT8GBBAF3 | HT8GBBBF3 | HT8GBBABF3 | HT8GBBF1Q1F3 | | |
| Transformer | 120 Vac | No lens ① | HT8GBT1 | — | — | — | — |
| | | Red | HT8GBRL1 | HT8GBRAL1 | HT8GBRBL1 | HT8GBRABL1 | HT8GBRF1Q1L1 |
| | | Green | HT8GBGL1 | HT8GBGAL1 | HT8GBGBL1 | HT8GBGABL1 | HT8GBGF1Q1L1 |
| | | Amber | HT8GBAL1 | HT8GBAAL1 | HT8GBABL1 | HT8GBAABL1 | HT8GBAF1Q1L1 |
| | | Clear | HT8GBCL1 | HT8GBCAL1 | HT8GBCBL1 | HT8GBCABL1 | HT8GBCF1Q1L1 |
| | | White | HT8GBWL1 | HT8GBWAL1 | HT8GBWBL1 | HT8GBWABL1 | HT8GBWF1Q1L1 |
| | | Yellow | HT8GBYL1 | HT8GBYAL1 | HT8GBYBL1 | HT8GBYABL1 | HT8GBYF1Q1L1 |
| | | Blue | HT8GBBL1 | HT8GBBAL1 | HT8GBBBL1 | HT8GBBABL1 | HT8GBBF1Q1L1 |

Note

① Light unit base operator without lens or bulb.

1

Guarded Illuminated Pushbutton Units

UL (NEMA) Type 3, 3R, 4, 4X, 12 and 13

- Incandescent or LED
- Full voltage or transformer type
- 24V and 120V

Guarded Illuminated Pushbutton Operator



Guarded Illuminated Pushbuttons

| Type | Volts | Lens Color | Operator Only Catalog Number | 1NO Catalog Number | 1NC Catalog Number | 1NO-1NC Catalog Number | 2NO-2NC Catalog Number |
|--------------------------|----------------|------------------|------------------------------|--------------------|---------------------|------------------------|------------------------|
| Incandescent Lamp | | | | | | | |
| Full voltage | 120 Vac/Vdc | No lens ① | HT8GDFV | — | — | — | — |
| | | Red | HT8GDRV7 | HT8GDRAV7 | HT8GDRBV7 | HT8GDRABV7 | HT8GDRF1Q1V7 |
| | | Green | HT8GDGV7 | HT8GDGAV7 | HT8GDGBV7 | HT8GDGABV7 | HT8GDGF1Q1V7 |
| | | Amber | HT8GDAV7 | HT8GDAAV7 | HT8GDABV7 | HT8GDAABV7 | HT8GDAF1Q1V7 |
| | | Clear | HT8GDCV7 | HT8GDVAV7 | HT8GDCBV7 | HT8GDCABV7 | HT8GDCF1Q1V7 |
| | | White | HT8GDWV7 | HT8GDWAV7 | HT8GDWBV7 | HT8GDWABV7 | HT8GDWF1Q1V7 |
| | | Yellow | HT8GDYV7 | HT8GDYAV7 | HT8GDYBV7 | HT8GDYABV7 | HT8GDYF1Q1V7 |
| | Blue | HT8GDBV7 | HT8GDBAV7 | HT8GDBBV7 | HT8GDBABV7 | HT8GDBF1Q1V7 | |
| | 24 Vac/Vdc | No lens ① | HT8GDFV | — | — | — | — |
| | | Red | HT8GDRV3 | HT8GDRAV3 | HT8GDRBV3 | HT8GDRABV3 | HT8GDRF1Q1V3 |
| | | Green | HT8GDGV3 | HT8GDGAV3 | HT8GDGBV3 | HT8GDGABV3 | HT8GDGF1Q1V3 |
| | | Amber | HT8GDAV3 | HT8GDAAV3 | HT8GDABV3 | HT8GDAABV3 | HT8GDAF1Q1V3 |
| | | Clear | HT8GDCV3 | HT8GDVAV3 | HT8GDCBV3 | HT8GDCABV3 | HT8GDCF1Q1V3 |
| | | White | HT8GDWV3 | HT8GDWAV3 | HT8GDWBV3 | HT8GDWABV3 | HT8GDWF1Q1V3 |
| Yellow | | HT8GDYV3 | HT8GDYAV3 | HT8GDYBV3 | HT8GDYABV3 | HT8GDYF1Q1V3 | |
| Transformer | 120 Vac | No lens ① | HT8GDT1 | — | — | — | — |
| | | Red | HT8GDR1 | HT8GDRAT1 | HT8GDRBT1 | HT8GDRABT1 | HT8GDRF1Q1T1 |
| | | Green | HT8GDG1 | HT8GDGAT1 | HT8GDGBT1 | HT8GDGABT1 | HT8GDGF1Q1T1 |
| | | Amber | HT8GDAT1 | HT8GDAAT1 | HT8GDABT1 | HT8GDAABT1 | HT8GDAF1Q1T1 |
| | | Clear | HT8GDC1 | HT8GDCA1 | HT8GDGBT1 | HT8GDCABT1 | HT8GDCF1Q1T1 |
| | | White | HT8GDW1 | HT8GDWAT1 | HT8GDWBT1 | HT8GDWABT1 | HT8GDWF1Q1T1 |
| | | Yellow | HT8GDY1 | HT8GDYAT1 | HT8GDYBT1 | HT8GDYABT1 | HT8GDYF1Q1T1 |
| Blue | HT8GDB1 | HT8GDBAT1 | HT8GDBBT1 | HT8GDBABT1 | HT8GDBF1Q1T1 | | |

Note

① Light unit base operator without lens or bulb.

UL (NEMA) Type 3, 3R, 4, 4X, 12 and 13

Guarded Illuminated Pushbutton Operator



Guarded Illuminated Pushbuttons, continued

| Type | Volts | Lens Color | Operator Only Catalog Number | 1NO Catalog Number | 1NC Catalog Number | 1NO-1NC Catalog Number | 2NO-2NC Catalog Number |
|--------------|-----------------|------------------|------------------------------|--------------------|---------------------|------------------------|------------------------|
| LED | | | | | | | |
| Full voltage | 120 Vac/Vdc | No lens ① | HT8GDFV | — | — | — | — |
| | | Red | HT8GDRF7 | HT8GDRAF7 | HT8GDRBF7 | HT8GDRABF7 | HT8GDRF1Q1F7 |
| | | Green | HT8GDGF7 | HT8GDGAF7 | HT8GDGBF7 | HT8GDGABF7 | HT8GDGF1Q1F7 |
| | | Amber | HT8GDAF7 | HT8GDAAF7 | HT8GDABF7 | HT8GDAABF7 | HT8GDAF1Q1F7 |
| | | Clear | HT8GDCF7 | HT8GDCAF7 | HT8GDCBF7 | HT8GDCABF7 | HT8GDCF1Q1F7 |
| | | White | HT8GDWF7 | HT8GDWAF7 | HT8GDWBF7 | HT8GDWABF7 | HT8GDWF1Q1F7 |
| | | Yellow | HT8GDYF7 | HT8GDYAF7 | HT8GDYBF7 | HT8GDYABF7 | HT8GDYF1Q1F7 |
| | Blue | HT8GDBF7 | HT8GDBAF7 | HT8GDBBF7 | HT8GDBABF7 | HT8GDBF1Q1F7 | |
| | 24 Vac/Vdc | No lens ① | HT8GDFV | — | — | — | — |
| | | Red | HT8GDRF3 | HT8GDRAF3 | HT8GDRBF3 | HT8GDRABF3 | HT8GDRF1Q1F3 |
| | | Green | HT8GDGF3 | HT8GDGAF3 | HT8GDGBF3 | HT8GDGABF3 | HT8GDGF1Q1F3 |
| | | Amber | HT8GDAF3 | HT8GDAAF3 | HT8GDABF3 | HT8GDAABF3 | HT8GDAF1Q1F3 |
| | | Clear | HT8GDCF3 | HT8GDCAF3 | HT8GDCBF3 | HT8GDCABF3 | HT8GDCF1Q1F3 |
| | | White | HT8GDWF3 | HT8GDWAF3 | HT8GDWBF3 | HT8GDWABF3 | HT8GDWF1Q1F3 |
| Yellow | | HT8GDYF3 | HT8GDYAF3 | HT8GDYBF3 | HT8GDYABF3 | HT8GDYF1Q1F3 | |
| Blue | HT8GDBF3 | HT8GDBAF3 | HT8GDBBF3 | HT8GDBABF3 | HT8GDBF1Q1F3 | | |
| Transformer | 120 Vac | No lens ① | HT8GDT1 | — | — | — | — |
| | | Red | HT8GDRL1 | HT8GDRAL1 | HT8GDRBL1 | HT8GDRABL1 | HT8GDRF1Q1L1 |
| | | Green | HT8GDGL1 | HT8GDGAL1 | HT8GDGBL1 | HT8GDGABL1 | HT8GDGF1Q1L1 |
| | | Amber | HT8GDAL1 | HT8GDAAL1 | HT8GDABL1 | HT8GDAABL1 | HT8GDAF1Q1L1 |
| | | Clear | HT8GDCL1 | HT8GDCAL1 | HT8GDCBL1 | HT8GDCABL1 | HT8GDCF1Q1L1 |
| | | White | HT8GDWL1 | HT8GDWAL1 | HT8GDWBL1 | HT8GDWABL1 | HT8GDWF1Q1L1 |
| | | Yellow | HT8GDYL1 | HT8GDYAL1 | HT8GDYBL1 | HT8GDYABL1 | HT8GDYF1Q1L1 |
| | | Blue | HT8GDBL1 | HT8GDBAL1 | HT8GDBBL1 | HT8GDBABL1 | HT8GDBF1Q1L1 |

Note

① Light unit base operator without lens or bulb.

1

Indicating Light Units

UL (NEMA) Type 3, 3R, 4, 4X, 12 and 13

- Incandescent or LED
- Full voltage or transformer type
- Standard and PresTest types
- 24V and 120V

PresTest—This device incorporates a press-to-test feature whereby depressing the lens disconnects the light from the source

being monitored and connects the lamp to a continuously energized circuit for immediate detection of faulty lamps.

Indicating Light Unit



PresTest Light Unit



Indicating Light Units

| Type | Volts | Lens Color | Indicating Light Catalog Number | PresTest Catalog Number |
|---------------------|---------------------|------------|---------------------------------|-------------------------|
| Incandescent | | | | |
| Full voltage | 120 Vac/Vdc | No lens ① | HT8HFFV | HT8GTFV |
| | | Red | HT8HFRV7 | HT8GTRV7 |
| | | Green | HT8HFGV7 | HT8GTGV7 |
| | | Amber | HT8HFAV7 | HT8GTAV7 |
| | | Clear | HT8HFCV7 | HT8GTCV7 |
| | | White | HT8HFWV7 | HT8GTWV7 |
| | | Yellow | HT8HFVY7 | HT8GTYV7 |
| | | Blue | HT8HFBV7 | HT8GTBV7 |
| | 24 Vac/Vdc | No lens ① | HT8HFFV | HT8GTFV |
| | | Red | HT8HFRV3 | HT8GTRV3 |
| | | Green | HT8HFGV3 | HT8GTGV3 |
| | | Amber | HT8HFAV3 | HT8GTAV3 |
| | | Clear | HT8HFCV3 | HT8GTCV3 |
| | | White | HT8HFWV3 | HT8GTWV3 |
| | | Yellow | HT8HFVY3 | HT8GTYV3 |
| | | Blue | HT8HFBV3 | HT8GTBV3 |
| Transformer | 120 Vac 50/60 Hz | No lens ① | HT8HBT1 | HT8GTT1 |
| | | Red | HT8HBRT1 | HT8GTRT1 |
| | | Green | HT8HBGT1 | HT8GTGT1 |
| | | Amber | HT8HBAT1 | HT8GTAT1 |
| | | Clear | HT8HBCT1 | HT8GTCT1 |
| | | White | HT8HBWT1 | HT8GTWT1 |
| | | Yellow | HT8HBYT1 | HT8GTYT1 |
| | | Blue | HT8HBBT1 | HT8GTBT1 |

Note

① Light unit base operator without lens or bulb.

UL (NEMA) Type 3, 3R, 4, 4X, 12 and 13

Indicating Light Unit



Indicating Light Units, continued

PresTest Light Unit



| Type | Volts | Lens Color | Indicating Light Catalog Number | PresTest Catalog Number |
|--------------|---------------------|------------|---------------------------------|-------------------------|
| LED | | | | |
| Full voltage | 120 Vac/Vdc | No lens ① | HT8HFFV | HT8GTFV |
| | | Red | HT8HFRF7 | HT8GTRF7 |
| | | Green | HT8HFGF7 | HT8GTGF7 |
| | | Amber | HT8HFAF7 | HT8GTAF7 |
| | | Clear | HT8HFCF7 | HT8GTCF7 |
| | | White | HT8HFWF7 | HT8GTWF7 |
| | | Yellow | HT8HFVF7 | HT8GTVF7 |
| | | Blue | HT8HBF7 | HT8GTBF7 |
| | 24 Vac/Vdc | No lens ① | HT8HFFV | HT8GTFV |
| | | Red | HT8HFRF3 | HT8GTRF3 |
| | | Green | HT8HFGF3 | HT8GTGF3 |
| | | Amber | HT8HFAF3 | HT8GTAF3 |
| | | Clear | HT8HFCF3 | HT8GTCF3 |
| | | White | HT8HFWF3 | HT8GTWF3 |
| | | Yellow | HT8HFVF3 | HT8GTVF3 |
| | | Blue | HT8HBF3 | HT8GTBF3 |
| Transformer | 120 Vac 50/60 Hz | No lens ① | HT8HBT1 | HT8GTT1 |
| | | Red | HT8HBRL1 | HT8GTRL1 |
| | | Green | HT8HBGL1 | HT8GTGL1 |
| | | Amber | HT8HBAL1 | HT8GTAL1 |
| | | Clear | HT8HBCL1 | HT8GTCL1 |
| | | White | HT8HBWL1 | HT8GTWL1 |
| | | Yellow | HT8HBYL1 | HT8GTYL1 |
| | | Blue | HT8HBBL1 | HT8GTBL1 |

Note

① Light unit base operator without lens or bulb.

1

Push-Pull Units

UL (NEMA) Type 3, 3R, 4, 4X, 12 and 13

- 40 mm mushroom head
- Two-position maintained
- Non-illuminated

Round Head Two-Position Push-Pull Unit



Flat Head Two-Position Push-Pull Unit



Two-Position Push-Pull, Maintained, Non-Illuminated

| Contact Type | Operator Position—Maintained | | Button Color | Round Head Mushroom Head Button Catalog Number | Flat Head Mushroom Head Button Catalog Number |
|-------------------|------------------------------|----|--------------|--|---|
| | Out | In | | | |
| No contact | — | — | Black | HT8CBH | HT8DBH |
| | | | Red | HT8CBR | HT8DBR |
| | | | Green | HT8CBG | HT8DBG |
| NO | 0 | X | Black | HT8CBHA | HT8DBHA |
| | | | Red | HT8CBRA | HT8DBRA |
| | | | Green | HT8CBGA | HT8DBGA |
| NC | X | 0 | Black | HT8CBHB | HT8DBHB |
| | | | Red | HT8CBRB | HT8DBRB |
| | | | Green | HT8CBGB | HT8DBGB |
| NO-NC | 0 | X | Black | HT8CBHAB | HT8DBHAB |
| | X | 0 | Red | HT8CBRAB | HT8DBRAB |
| | | | Green | HT8CBGAB | HT8DBGAB |
| NCLB [Ⓢ] | X | 0 | Black | HT8CBHD1B | HT8DBHD1B |
| NC | X | 0 | Red | HT8CBRD1B | HT8DBRD1B |
| | | | Green | HT8CBGD1B | HT8DBGD1B |
| NCLB [Ⓢ] | X | 0 | Black | HT8CBHD1D | HT8DBHD1D |
| NCLB [Ⓢ] | X | 0 | Red | HT8CBRD1D | HT8DBRD1D |
| | | | Green | HT8CBGD1D | HT8DBGD1D |

Note

[Ⓢ] NCLB = normally closed late break.

Illuminated Push-Pull Units

UL (NEMA) Type 3, 3R, 4, 4X, 12 and 13

- Incandescent or LED
- Full voltage or transformer type
- 24V and 120V

Illuminated Push-Pull Unit



Illuminated Push-Pull Units

| Type | Volts | Lens Color | Operator Only Catalog Number | 1NO Catalog Number | 1NC Catalog Number | 1NO-1NC Catalog Number | 2NCLB Catalog Number |
|--------------------------|-------------|------------|------------------------------|--------------------|--------------------|------------------------|----------------------|
| Incandescent Lamp | | | | | | | |
| Full voltage | 120 Vac/Vdc | Red | HT8FBRV7 | HT8FBRAV7 | HT8FBRBV7 | HT8FBRAV7 | HT8FBRD1DV7 |
| | | Green | HT8FBGV7 | HT8FBGAV7 | HT8FBGBV7 | HT8FBGAV7 | HT8FBGD1DV7 |
| | 24 Vac/Vdc | Red | HT8FBRV3 | HT8FBRAV3 | HT8FBRBV3 | HT8FBRAV3 | HT8FBRD1DV3 |
| | | Green | HT8FBGV3 | HT8FBGAV3 | HT8FBGBV3 | HT8FBGAV3 | HT8FBGD1DV3 |
| Transformer | 120 Vac | Red | HT8FBR1 | HT8FBRA1 | HT8FBRB1 | HT8FBRA1 | HT8FBRD1D1 |
| | | Green | HT8FBG1 | HT8FBGA1 | HT8FBGB1 | HT8FBGA1 | HT8FBGD1D1 |
| LED Lamp | | | | | | | |
| Full voltage | 120 Vac/Vdc | Red | HT8FBRF7 | HT8FBRAF7 | HT8FBRBF7 | HT8FBRAF7 | HT8FBRD1DF7 |
| | | Green | HT8FBGF7 | HT8FBGAF7 | HT8FBGBF7 | HT8FBGAF7 | HT8FBGD1DF7 |
| | 24 Vac/Vdc | Red | HT8FBRF3 | HT8FBRAF3 | HT8FBRBF3 | HT8FBRAF3 | HT8FBRD1DF3 |
| | | Green | HT8FBGF3 | HT8FBGAF3 | HT8FBGBF3 | HT8FBGAF3 | HT8FBGD1DF3 |
| Transformer | 120 Vac | Red | HT8FBR1 | HT8FBRA1 | HT8FBRB1 | HT8FBRA1 | HT8FBRD1D1 |
| | | Green | HT8FBG1 | HT8FBGA1 | HT8FBGB1 | HT8FBGA1 | HT8FBGD1D1 |

Note: Complete illuminated push-pull switches will not fit in a standard 3 in deep enclosure.

Illuminated Push-Pull Units with Low Profile Light Units

| Type | Voltage | Color | Fingersafe | Operator Only Catalog Number | 1NO Catalog Number | 1NC Catalog Number | 1NO-1NC Catalog Number | 2NCLB Catalog Number | 1NO-1NCLB Catalog Number |
|---------------------|-------------|-------|------------|------------------------------|--------------------|--------------------|------------------------|----------------------|--------------------------|
| LED Lamp | | | | | | | | | |
| Full voltage | 120 Vac/Vdc | Red | Yes | HT8FBRFL7P | HT8FBRAF7P | HT8FBRBF7P | HT8FBRAF7P | HT8FBRD1DF7P | HT8FBRD1BFL7P |
| | | Red | No | HT8FBRFL7 | HT8FBRAF7 | HT8FBRBF7 | HT8FBRAF7 | HT8FBRD1DF7 | HT8FBRD1BFL7 |
| | 24 Vac/Vdc | Red | Yes | HT8FBRFL3P | HT8FBRAF3P | HT8FBRBF3P | HT8FBRAF3P | HT8FBRD1DF3P | HT8FBRD1BFL3P |
| | | Red | No | HT8FBRFL3 | HT8FBRAF3 | HT8FBRBF3 | HT8FBRAF3 | HT8FBRD1DF3 | HT8FBRD1BFL3 |
| Incandescent | | | | | | | | | |
| Full voltage | 120 Vac/Vdc | Red | Yes | HT8FBRVL7P | HT8FBRAVL7P | HT8FBRBVL7P | HT8FBRAVL7P | HT8FBRD1DV7P | HT8FBRD1BVL7P |
| | | Red | No | HT8FBRVL7 | HT8FBRAVL7 | HT8FBRBVL7 | HT8FBRAVL7 | HT8FBRD1DV7 | HT8FBRD1BVL7 |
| | 24 Vac/Vdc | Red | Yes | HT8FBRVL3P | HT8FBRAVL3P | HT8FBRBVL3P | HT8FBRAVL3P | HT8FBRD1DV3P | HT8FBRD1BVL3P |
| | | Red | No | HT8FBRVL3 | HT8FBRAVL3 | HT8FBRBVL3 | HT8FBRAVL3 | HT8FBRD1DV3 | HT8FBRD1BVL3 |

1

Selector Switch Units

UL (NEMA) Type 3, 3R, 4, 4X, 12 and 13

- Two-, three- and four-position
- Non-illuminated

Standard Knob Operator



Standard Lever Operator



Two-Position Selector Switch Units, Non-Illuminated

| Contact Type | Operator Position ^① | | Operating Mode ^② | | Standard Black Knob Catalog Number | Standard Black Lever Catalog Number |
|--------------|--------------------------------|------------------|-----------------------------|---|------------------------------------|-------------------------------------|
| | | | | | | |
| No contacts | — | — | M | M | HT8JAH3A | HT8JDH3A |
| | | | S | M | HT8JKH3A | HT8JLH3A |
| | | | M | S | HT8JNH3A | HT8JPH3A |
| 1NO | 0 | X | M | M | HT8JAH3AA5 | HT8JDH3AA5 |
| | | | S | M | HT8JKH3AA5 | HT8JLH3AA5 |
| | | | M | S | HT8JNH3AA5 | HT8JPH3AA5 |
| 2NO | X 0 | 0 X | M | M | HT8JAH3AAA5 | HT8JDH3AAA5 |
| | | | S | M | HT8JKH3AAA5 | HT8JLH3AAA5 |
| | | | M | S | HT8JNH3AAA5 | HT8JPH3AAA5 |
| 2NO-2NC | X 0 0 X | 0 X X 0 | M | M | HT8JAH3AF1Q1 | HT8JDH3AF1Q1 |
| | | | S | M | HT8JKH3AF1Q1 | HT8JLH3AF1Q1 |
| | | | M | S | HT8JNH3AF1Q1 | HT8JPH3AF1Q1 |

Standard Knob Operator



Standard Lever Operator



Three-Position Selector Switch Units, Non-Illuminated

| Contact Type | Operator Position ^① | | | Operating Mode ^② | | | Standard Black Knob Catalog Number | Standard Black Lever Catalog Number |
|----------------------|--------------------------------|------------------|------------------|-----------------------------|---|---|------------------------------------|-------------------------------------|
| | | | | | | | | |
| No contacts | — | — | — | M | M | M | HT8JBH1D | HT8JEH1D |
| | | | | S | M | M | HT8JRH1D | HT8JSH1D |
| | | | | M | M | S | HT8JUH1D | HT8JVH1D |
| | | | | S | M | S | HT8JXH1D | HT8JYH1D |
| 2NO | X 0 | 0 0 | 0 X | M | M | M | HT8JBH1DAA5 | HT8JEH1DAA5 |
| | | | | S | M | M | HT8JRH1DAA5 | HT8JSH1DAA5 |
| | | | | M | M | S | HT8JUH1DAA5 | HT8JVH1DAA5 |
| | | | | S | M | S | HT8JXH1DAA5 | HT8JYH1DAA5 |
| 2NO-2NC ^③ | X 0 0 | 0 X 0 | 0 0 X | M | M | M | HT8JBH1DF1Q1 | HT8JEH1DF1Q1 |
| | | | | S | M | M | HT8JRH1DF1Q1 | HT8JSH1DF1Q1 |
| | | | | M | M | S | HT8JUH1DF1Q1 | HT8JVH1DF1Q1 |
| | | | | S | M | S | HT8JXH1DF1Q1 | HT8JYH1DF1Q1 |
| 2NO-2NC | X 0 0 X | 0 X 0 X | X X X 0 | M | M | M | HT8JBH1DF1Q1 | HT8JEH1DF1Q1 |
| | | | | S | M | M | HT8JRH1DF1Q1 | HT8JSH1DF1Q1 |
| | | | | M | M | S | HT8JUH1DF1Q1 | HT8JVH1DF1Q1 |
| | | | | S | M | S | HT8JXH1DF1Q1 | HT8JYH1DF1Q1 |

Notes

^① X = closed circuit, 0 = open circuit.

^② M = Maintained, S = Momentary.

^③ For OX0, NC contacts must be wired in series—see Three-Position Selector Switch table on Page V7-T1-340.

UL (NEMA) Type 3, 3R, 4, 4X, 12 and 13

Standard Knob Operator



Four-Position Selector Switch Units, Non-Illuminated

Standard Lever Operator



| Contact Type | Operator Position ^① | | | | Operating Mode ^② | | | | Standard Black Knob Catalog Number | Standard Black Lever Catalog Number |
|--------------|--------------------------------|---|---|---|-----------------------------|---|---|---|------------------------------------|-------------------------------------|
| | | | | | | | | | | |
| No contacts | — | — | — | — | M | M | M | M | HT8JCH8E | HT8JFH8E |
| | | | | | S | M | M | M | HT8LNH8E | HT8LPH8E |
| | | | | | M | M | M | S | HT8LRH8E | HT8LSH8E |
| 2NO-2NC | X | 0 | 0 | 0 | M | M | M | M | HT8JCH8EF1Q1 | HT8JFH8EF1Q1 |
| | 0 | X | 0 | 0 | S | M | M | M | HT8LNH8EF1Q1 | HT8LPH8EF1Q1 |
| | 0 | 0 | X | 0 | S | M | M | M | HT8LNH8EF1Q1 | HT8LPH8EF1Q1 |
| | 0 | 0 | 0 | X | M | M | M | S | HT8LRH8EF1Q1 | HT8LSH8EF1Q1 |

Notes

- ① X = closed circuit, 0 = open circuit.
- ② M = Maintained, S = Momentary.







1

Selector Switch Contact Block Selection

For Two-, Three- and Four-Position Selector Switches









Two-Position Selector Switch (Cam Code 3A)

Operator Position

| |  |  | Left | or | Right |
|---|---|---|---|----|---|
| X | 0 | |  NO | |  NC |
| 0 | | X |  NC | |  NO |









Three-Position Selector Switch (Cam Code 1D)

Operator Position

| |  |  |  | Left | Right |
|---|---|---|---|--|---|
| X | 0 | 0 | |  NO | — |
| 0 | | X | 0 |  NC |  NC |
| 0 | 0 | 0 | X | — |  NO |
| 0 | | X | X |  NC | — |
| X | | X | 0 | — |  NC |









Four-Position Selector Switch (Cam Code 8E)

Operator Position

| |  |  |  |  | Left | Right |
|---|---|---|---|---|---|--|
| X | 0 | 0 | 0 | |  NO | — |
| 0 | | X | 0 | 0 |  NC | — |
| 0 | 0 | 0 | X | 0 | — |  NO |
| 0 | 0 | 0 | 0 | X | — |  NC |

Accessories

HT800 Accessories

| | Description | Catalog Number |
|--|--|----------------|
|  <p>HT8A15</p> | Illuminated Pushbutton Guard | HT8A15 |
|  <p>HT8WRENCH</p> | Wrench Tool | HT8WRENCH |
|  <p>HT8LAMPTOOL</p> | Lamp/Bulb Removal Tool | HT8LAMPTOOL |
|  <p>HT8X1</p> | Thrust Washer (Anti-rotation) (Included with every operator) | HT8X1 |
|  <p>HT8X2</p> | Trim Ring (Included with every operator) | HT8X2 |
|  <p>HT8X3</p> | Sealing/Spacer Washer (Five included with every operator) | HT8X3 |
|  <p>HT8GR1</p> | Grounding Kit for Pushbuttons and Selector Switches (Included with every operator) | HT8GR1 |
|  <p>HT8GR2</p> | Grounding Kit for Indicating Lights (Included with indicating lights) | HT8GR2 |

Light Units

| Light Unit | Type | Voltage | Catalog Number |
|---|--------------|-------------|----------------|
|  | Full voltage | 24 Vac/Vdc | HT8F3V3 |
| | | 120 Vac/Vdc | HT8F7V8 |
| | Transformer | 120 Vac | HT8L1T1 |

Options

Legend Plates ①

Standard



Jumbo



For Pushbutton Operators and Indicating Lights

| Legend | Color of Field | Standard Catalog Number | Jumbo Catalog Number | Legend | Color of Field | Standard Catalog Number | Jumbo Catalog Number |
|--|----------------|-------------------------|----------------------|----------|----------------|-------------------------|----------------------|
| Letters on Legend Plates Below are 3/16 in High | | | | | | | |
| CLAMP | Black | HT8SP90 | HT8LP90 | OFF | Red | HT8SP24 | HT8LP24 |
| CLOSE | | HT8SP73 | HT8LP73 | ON | Black | HT8SP25 | HT8LP25 |
| DOWN | | HT8SP74 | HT8LP74 | OPEN | | HT8SP26 | HT8LP26 |
| EMERG. STOP | | HT8SP13 | HT8LP13 | OUT | | HT8SP27 | HT8LP27 |
| FAST | | HT8SP75 | HT8LP75 | POWER ON | | HT8SP80 | HT8LP80 |
| FASTER | | HT8SP87 | HT8LP87 | RAISE | | HT8SP28 | HT8LP28 |
| FEEDER ON | | HT8SP94 | HT8LP94 | READY | | HT8SP86 | HT8LP86 |
| FEEDER OFF | | HT8SP95 | HT8LP95 | RESET | | HT8SP29 | HT8LP29 |
| FORWARD | | HT8SP15 | HT8LP15 | REVERSE | | HT8SP30 | HT8LP30 |
| HIGH | | HT8SP16 | HT8LP16 | RUN | | HT8SP31 | HT8LP31 |
| IN | | HT8SP17 | HT8LP17 | SAFE | | HT8SP85 | HT8LP85 |
| INCH | | HT8SP18 | HT8LP18 | SLOW | | HT8SP32 | HT8LP32 |
| JOG | | HT8SP19 | HT8LP19 | SLOWER | | HT8SP88 | HT8LP88 |
| JOG FOR. | | HT8SP20 | HT8LP20 | START | | HT8SP33 | HT8LP33 |
| JOG REV. | | HT8SP21 | HT8LP21 | STOP | Red | HT8SP34 | HT8LP34 |
| LOW | | HT8SP22 | HT8LP22 | TEST | Black | HT8SP83 | HT8LP83 |
| LOWER | | HT8SP23 | HT8LP23 | TRANSFER | | HT8SP93 | HT8LP93 |
| LUBE-FAIL | | HT8SP92 | HT8LP92 | TRIP | | HT8SP84 | HT8LP84 |
| MOTOR RUN | | HT8SP81 | HT8LP81 | UNCLAMP | | HT8SP91 | HT8LP91 |
| MOTOR STOP | | HT8SP82 | HT8LP82 | UP | | HT8SP35 | HT8LP35 |

Standard



Jumbo



For Selector Switch Operators

| Legend | Color of Field | Standard Catalog Number | Jumbo Catalog Number | Legend | Color of Field | Standard Catalog Number | Jumbo Catalog Number |
|--|----------------|-------------------------|----------------------|--|----------------|-------------------------|----------------------|
| Two-Position—3/16 in High Lettering | | | | Three-Position—3/16 in High Lettering | | | |
| FOR. REV. | Black | HT8SP38 | HT8LP38 | AUTO OFF HAND | Black | HT8SP49 | HT8LP49 |
| HAND AUTO | | HT8SP39 | HT8LP39 | FOR. OFF REV. | | HT8SP50 | HT8LP50 |
| HIGH LOW | | HT8SP40 | HT8LP40 | FOR. SAFE REV. | | HT8SP69 | HT8LP69 |
| JOG RUN | | HT8SP41 | HT8LP41 | HAND OFF AUTO | | HT8SP51 | HT8LP51 |
| MAN. AUTO | | HT8SP67 | HT8LP67 | MAN. OFF AUTO | | HT8SP68 | HT8LP68 |
| OFF ON | | HT8SP42 | HT8LP42 | OPEN OFF CLOSE | | HT8SP53 | HT8LP53 |
| OPEN CLOSE | | HT8SP43 | HT8LP43 | RUN SAFE JOG | | HT8SP70 | HT8LP70 |
| RUN JOG | | HT8SP44 | HT8LP44 | UP OFF DOWN | | HT8SP54 | HT8LP54 |
| SAFE RUN | | HT8SP45 | HT8LP45 | ON STOP SAFE | | HT8SP71 | HT8LP71 |
| START JOG | | HT8SP46 | HT8LP46 | | | | |
| START STOP | | HT8SP47 | HT8LP47 | | | | |
| UP DOWN | | HT8SP48 | HT8LP48 | | | | |

For Push-Pull Units

| Legend | Color of Field | Standard ② Catalog Number | Jumbo ③ Catalog Number |
|------------|----------------|---------------------------|------------------------|
| ON/OFF | Black | HT8PP5 | HT8R5 |
| OPEN/CLOSE | | HT8PP8 | HT8R8 |
| UP/DOWN | | HT8PP11 | HT8R11 |

Blank Plastic Legend Plates—Square

| Legend | Color of Field | Standard Catalog Number | Jumbo Catalog Number |
|--------|----------------|-------------------------|----------------------|
| Black | White/Silver | HT8SP76 | HT8LP76 |
| White | Red/Black | HT8SP77 | HT8LP77 |

Notes

① For dimensions, see Page V7-T1-350.

② 3/32 in high lettering.

③ 1/8 in high lettering.

Legend Plates with Non-Standard Markings

When Ordering Specify

- Catalog number of blank plate.
- Insert the following into Order Notes: legend, letter size and locations. See information below.

Ordering Example:

Catalog no.: **HT85P76STAMP**
 Letter size: 3/32 in (2.4 mm)
 Pos. A—POWER HOUSE
 Pos. B—START PUMP 1

Legend Characters Available

A B C D E F G H I J K L M N O
 P Q R S T U V W X Y Z / - . , 1
 2 3 4 5 6 7 8 9 0

Legend Positions

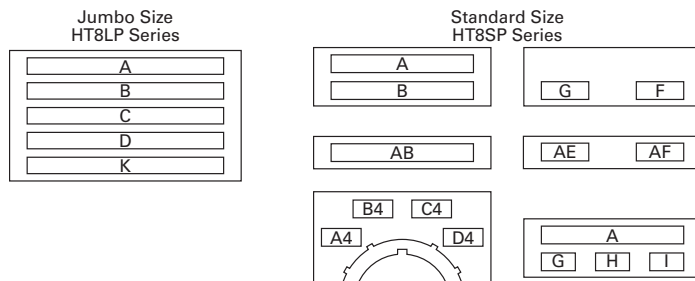

Blank Plastic Legend Plates for Non-Standard Markings—Plastic

| Legend | Color of Field | Standard Catalog Number | Jumbo Catalog Number |
|--------|----------------|-------------------------|----------------------|
| Black | White/Silver | HT8SP76STAMP | HT8LP76STAMP |
| White | Red/Black | HT8SP77STAMP | HT8LP77STAMP |

Maximum Characters per Legend Plate and Approximate Dimensions

| Top (Aluminum and Plastic) | Style | Character Size | | 1/8 in High | | 3/16 in High | |
|----------------------------|--------|----------------|----------------------|-----------------|----------------------|-----------------|----------------------|
| | | 3/32 in High | Number of Characters | Number of Lines | Number of Characters | Number of Lines | Number of Characters |
| Standard | Square | 2 | 18 | 2 | 13 | 1 | 9 |
| Jumbo ① | Square | 5 | 23 | 3 | 18 | 2 | 12 |

Note

① Can be used on top row only of any enclosure.

Contact Blocks

NO Contact Block



NC Contact Block



Contact Blocks ^{①②}

| Description/Function | Contact Type | Without Guard Catalog Number | Fingerproof Catalog Number |
|---|--------------|------------------------------|----------------------------|
| Standard normally open contact | NO | HT8A | HT8AP |
| Standard normally closed contact | NC | HT8B | HT8BP |
| Normally open early make contact will make circuit before standard NO contact. DC ratings do not apply. | NOEM | HT8C | HT8CP |
| Normally closed late break contact will open after standard NC contact. DC ratings do not apply. | NCLB | HT8D | HT8DP |
| Logic level, low voltage NO contact. Gold plated contacts. | NO | HT8E | HT8EP |

Contact Block Location (Viewed from Rear)

Suffix Codes ^{③④}



| Left Side | Right Side |
|-----------------------|-----------------------|
| A = NO | A5 = NO |
| A2 = 2NO | A6 = 2NO |
| B1 = NC | B = NC |
| B2 = 2NC | B6 = 2NC |
| C = NOEM | C5 = NOEM |
| C2 = 2 NOEM | C6 = 2 NOEM |
| D1 = NCLB | D = NCLB |
| D2 = 2 NCLB | D6 = 2 NCLB |
| E1 = NOEM-NCLB | E5 = NOEM-NCLB |
| F1 = NO and NC | Q1 = NO and NC |
| F4 = 1NO-1NC | |

Notes

- ① See **Page V7-T1-346** for contact block electrical ratings.
- ② Maximum of four contact blocks per side or a total of eight contact blocks recommended.
- ③ Maximum of two contact blocks per side or a total of four contact blocks recommended.
- ④ Standard contact blocks without fingerproof protection.

Replacement Parts

Replacement Bulbs and LEDs

| | Voltage | Color | Catalog Number |
|---|--|--------------|-----------------------|
| Incandescent Bulb  | Incandescent | | |
| | 6V | — | HT8BULBV1 |
| | 24V | — | HT8BULBV3 |
| | 120V | — | HT8BULBV7 |
| LED Bulb  | LED | | |
| | 6–12V (For use with transformers with 6V secondary winding) | Red | HT8LEDRF1 |
| | | Green | HT8LEDGF1 |
| | | Amber/orange | HT8LEDAF1 |
| | | White/clear | HT8LEDWF1 |
| | | Yellow | HT8LEDYF1 |
| | | Blue | HT8LEDBF1 |
| | 24V | Red | HT8LEDRF3 |
| | | Green | HT8LEDGF3 |
| | | Amber/orange | HT8LEDAF3 |
| | | White/clear | HT8LEDWF3 |
| | | Yellow | HT8LEDYF3 |
| | | Blue | HT8LEDBF3 |
| | 120V | Red | HT8LEDRF7 |
| | | Green | HT8LEDGF7 |
| | | Amber/orange | HT8LEDAF7 |
| | | White/clear | HT8LEDWF7 |
| | | Yellow | HT8LEDYF7 |
| | | Blue | HT8LEDBF7 |

Replacement Lenses

| Color | Indicating Lights Catalog Number | PresTest Lights Illuminated Pushbuttons Catalog Number |
|--------------|---|---|
| Amber | HT8LA | HT8BA |
| Blue | HT8LB | HT8BB |
| Clear | HT8LC | HT8BC |
| Green | HT8LG | HT8BG |
| Red | HT8LR | HT8BR |
| White | HT8LW | HT8BW |
| Yellow | HT8LY | HT8BY |

Technical Data and Specifications

HT800—Specifications

| Description | Specification |
|--|--|
| Mechanical Ratings | |
| Frequency of operation | |
| Pushbuttons | 6,000 operations per hour |
| Selector switches | 3,000 operations per hour |
| Push-pull operators | 3,000 operations per hour |
| Mechanical endurance/life | |
| Pushbuttons | 10 x 10 ⁶ operations 6K ops/hr with 6 NO on left and 6 NC on right |
| Selector switches | 250 x 10 ³ operations 3K ops/hr with 2 NO on left and 2 NC on right |
| Push-pull operators | 250 x 10 ³ operations 3K ops/hr with 6 NO on left and 6 NC on right |
| Climatic Conditions | |
| Operating temperature | 10° to 140°F (–12° to 60°C) |
| Storage temperature | –40° to 176°F (–40° to 80°C) |
| Altitude | 6,562 ft (2,000m) |
| Humidity | 95% RH at 60°C |
| Terminals | |
| Contact blocks | #6-32 posidrive saddle clamp type, 1 x 16 AWG to 2 x 14 AWG, 12 in-lbs max. |
| Light units | #6-32 posidrive saddle clamp type, 1 x 22 AWG to 2 x 14 AWG, 7 in-lbs max. |
| Electrical Ratings | |
| Standard contact blocks UL (NEMA) rating | See table below. |
| Logic level contact block power rating | 5V 1 mA (minimum) 28V 500 mA (maximum) |

Electrical Ratings—HT800 Standard Contact Blocks, UL Rating

| Description/Function | Contact Type | AC | DC | Catalog Number |
|---|--------------|---|--------|----------------|
| Standard normally open contact | NO | A600 ① | P600 ② | HT8A |
| Standard normally closed contact | NC | A600 ① | P600 ② | HT8B |
| Normally open early make contact will make circuit before standard NO contact. DC ratings do not apply. | NOEM | A600 ① | — | HT8C |
| Normally closed late break contact will open after standard NC contact. DC ratings do not apply. | NCLB | A600 ① | — | HT8D |
| Logic level, low voltage NO contact. Gold plated contacts. | NO | 5V 1 mA (minimum) 28V 500 mA (maximum) | | HT8E |

UL A600 and P600 Ratings

| Description | 50 Vac or 60 Hz | | | | Vdc ③ | | |
|---|-----------------|------|------|------|-------|-------|-------|
| | 120 | 240 | 480 | 600 | 125 | 250 | 600 |
| Make and emerg. interrupting capacity (amp) | 60 | 30 | 15 | 12 | 1.1 | 0.55 | 0.2 |
| Normal load break (amp) | 6 | 3 | 1.5 | 1.2 | 1.1 | 0.55 | 0.2 |
| Thermal current (amp) | 10 | 10 | 10 | 10 | 5 | 5 | 5 |
| Voltamperes: | | | | | | | |
| Make and emerg. interrupting capacity | 7200 | 7200 | 7200 | 7200 | 138 ④ | 138 ④ | 138 ④ |
| Normal load break | 720 | 720 | 720 | 720 | 138 | 138 | 138 |

Notes

- ① Heavy-duty.
- ② Standard-duty.
- ③ DC ratings do not apply to NOEM (Normally Open Early Make) and NCLB (Normal Closed Late Break) contact blocks HT8C and HT8D.
- ④ Maximum make or break volt-amperes at 300V or less.

Dimensions

Approximate Dimensions in Inches (mm)

Momentary Pushbuttons—Non-Illuminated

Back, side and bottom views of pushbutton operator with attached contact blocks.

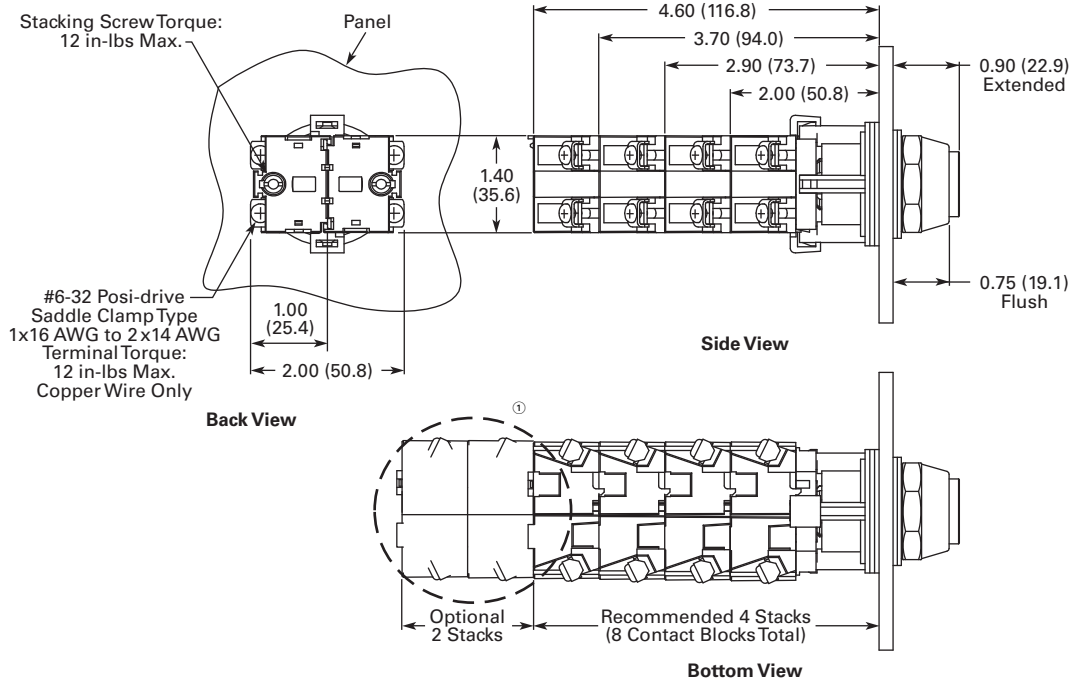

Illuminated Pushbuttons

Back, side and bottom views of pushbutton operator with attached contact blocks.

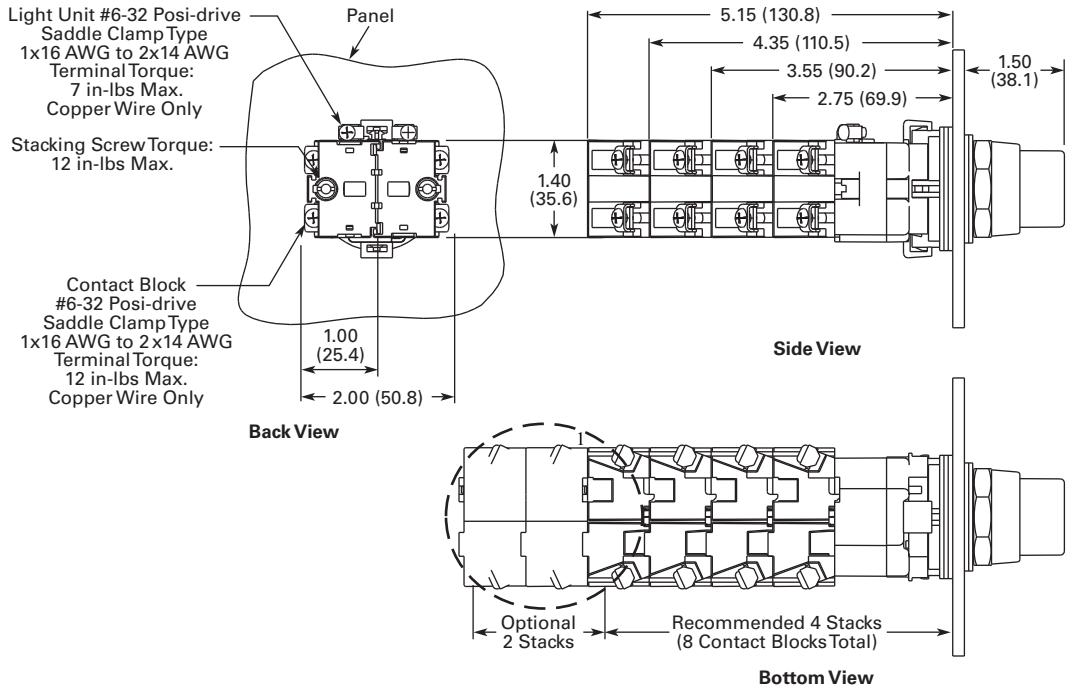

Note

① Recommended maximum of four tandem stacks of contact blocks behind operator. At users' discretion, two additional tandem stacks may be added.

1.11

Pushbuttons and Indicating Lights

30.5 mm Watertight/Oiltight—HT800

1

Approximate Dimensions in Inches (mm)

Mushroom Head Pushbuttons and Round Head MRH Push-Pull Operators

Back, side and bottom views of mushroom head operator with attached contact blocks.

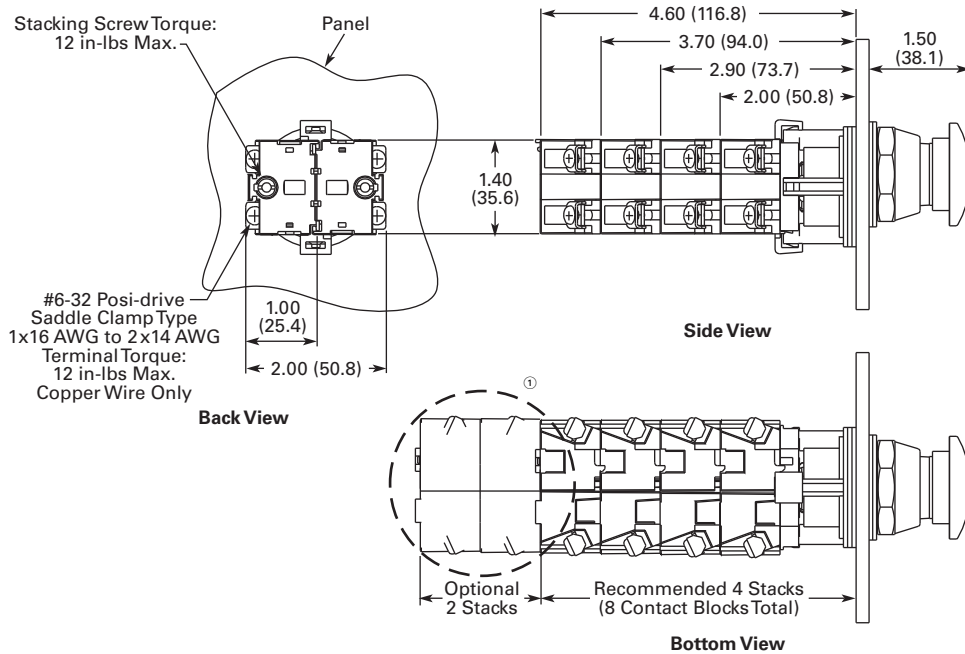

Illuminated and Non-Illuminated Flat Head MRH Push-Pull Operators

Back, side and bottom views of push-pull operator with attached contact blocks.

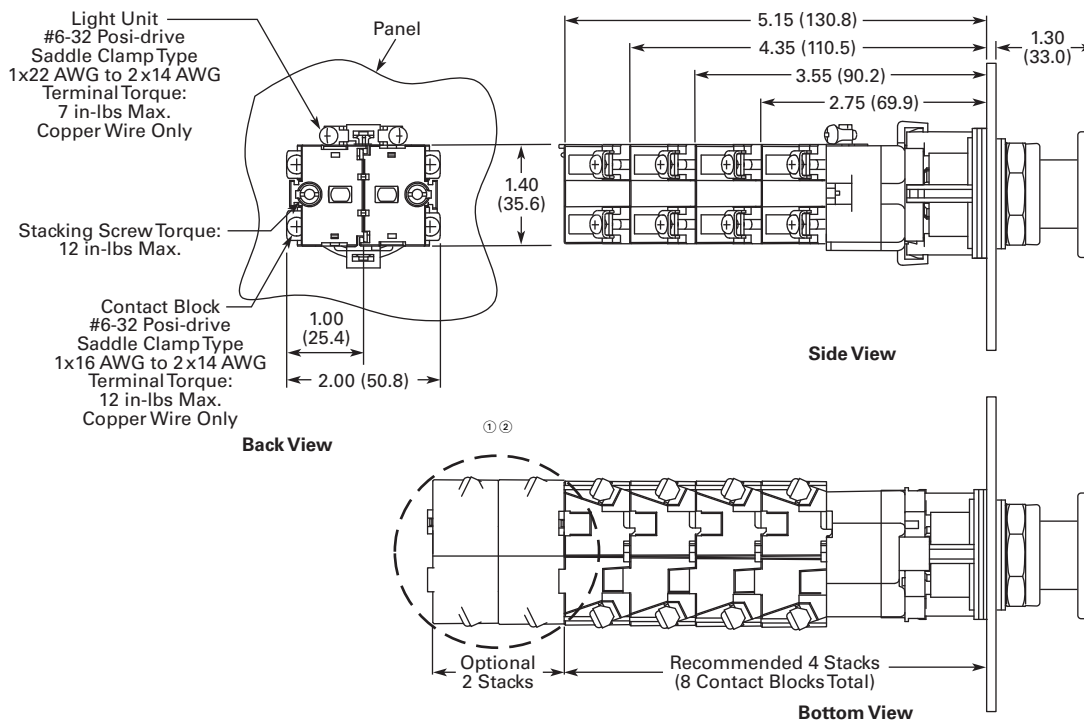

Notes

- ① Recommended maximum of four tandem stacks of contact blocks behind operator. At users' discretion, two additional tandem stacks may be added.
- ② Contact blocks mount directly to operator adaptor in non-illuminated version.

Approximate Dimensions in Inches (mm)

Indicating Lights

Back, side and bottom views of indicating light operator with attached contact blocks.

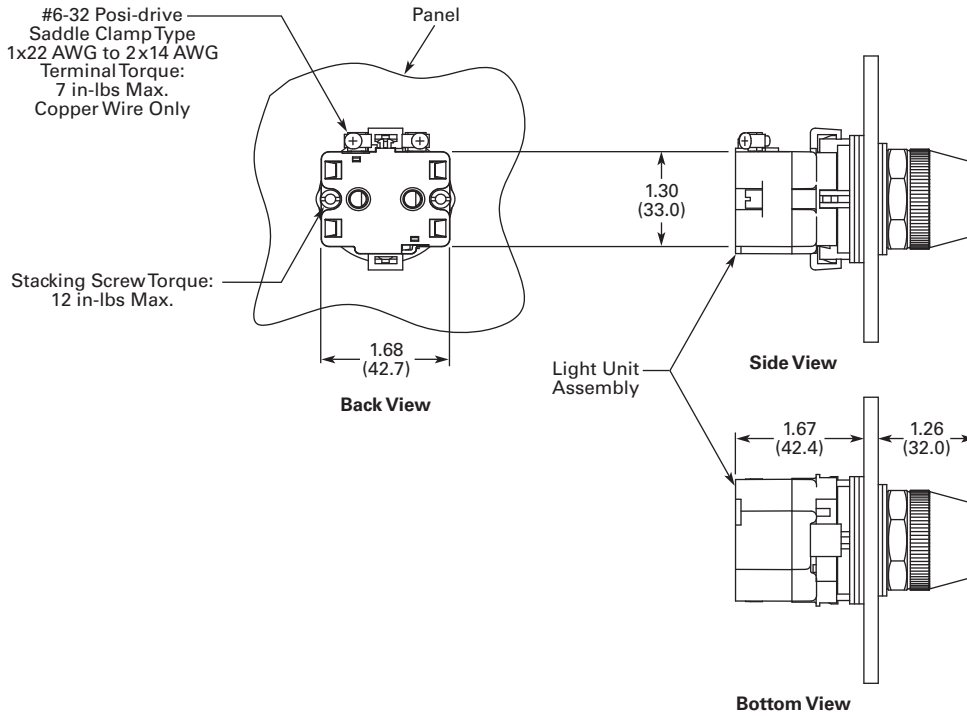

Selector Switches

Back, side and bottom views of selector switch operator with attached contact blocks.

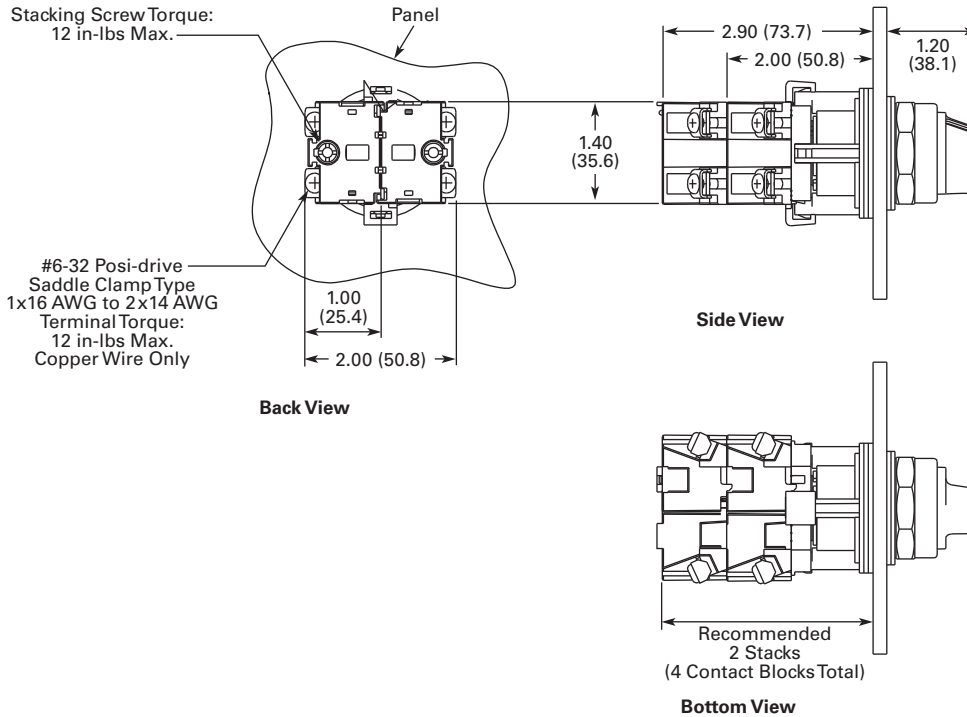

1.11

Pushbuttons and Indicating Lights

30.5 mm Watertight/Oiltight—HT800

1 Mounting Matrix and Minimum Panel Spacing Requirements

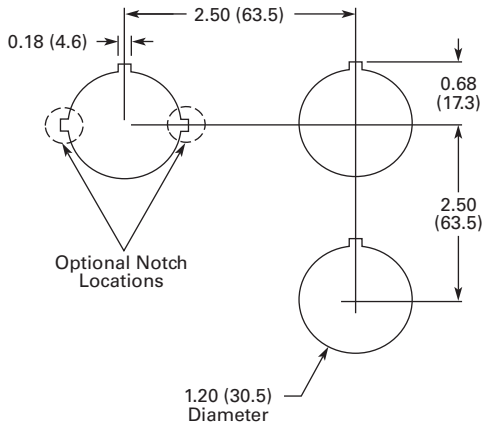

Legend Plates

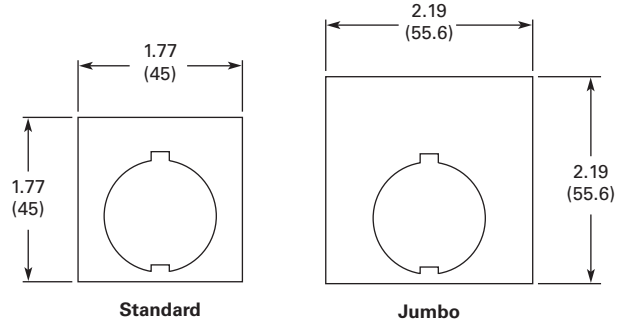

30.5 mm Class I Division 2 Hazardous Locations—10250T/E34



Contents

| <i>Description</i> | <i>Page</i> |
|---|------------------|
| 30.5 mm Class I Division 2 Hazardous Locations—10250T/E34 | |
| Product Overview | V7-T1-352 |
| Product Identification | V7-T1-353 |
| Catalog Number Selection | V7-T1-353 |
| Product Selection | |
| Momentary Pushbutton Units | V7-T1-354 |
| Non-Illuminated Pushbutton Units | V7-T1-358 |
| Illuminated Pushbutton Units | V7-T1-360 |
| Guarded Illuminated Pushbutton Units | V7-T1-361 |
| Indicating Light Units | V7-T1-362 |
| Illuminated Pushbuttons and Indicating Lights | V7-T1-363 |
| Push-Pull Units | V7-T1-365 |
| Illuminated Push-Pull Units | V7-T1-367 |
| Push-Pull Operators | V7-T1-370 |
| Selector Switch Units | V7-T1-374 |
| Selector Switch Selection | V7-T1-376 |
| Selector Switch Operators | V7-T1-379 |
| Illuminated Selector Switch Operators | V7-T1-382 |
| Options | V7-T1-384 |
| Technical Data and Specifications | V7-T1-387 |
| Dimensions | V7-T1-389 |
| Ratings | V7-T1-390 |

Product Description

All the Industry-Proven Quality of Eaton's 10250T and E34 Series of Logic Devices, plus Class I Division 2 Certification

The **10250T1H** consists of a normally open-normally closed factory sealed contact block that is UL Listed for use in Class I, Division 2, Groups B, C and D (NEC 500–503)—Class I, Zone 2, IIB + H2 (NEC 505) hazardous locations and is rated for both NEMA A600 and NEMA Q300. 10250T and E34 illuminated components have also been UL Listed for use in Class I, Division 2, Groups B, C and D (NEC 500–503)—Class I, Zone 2, IIB + H2 (NEC 505).

This, combined with the industry-proven Eaton 10250T 30.5 mm pushbutton line, offers a complete solution to Division 2 hazardous location requirements.

Single composite catalog numbers for complete assembled stations and operators for use in Division 2 hazardous locations are featured throughout this section.

Features

- Factory sealed contact blocks
- Heavy-duty zinc die cast construction
- NEMA rated 1, 2, 3, 3R, 4, 4X, 12, 13
- Front-of-panel drainage holes
- Grounding nibs on the operator casing
- Solid thermosetting cathodic epoxy coating on E34
- Corrosion resistance in E34

Benefits

- Pushbutton for hazardous locations
- Drainage holes prevent buildup of liquid inside the operator which can prevent operation in freezing environments
- Grounding nibs bite through paint and other coatings to provide secure ground
- Suitable for corrosive environments (E34 only)
- Earth terminal provides additional grounding point and allows for daisy chain grounding (E34 line)

Standards and Certifications

- UL 508—File No. E131568
- UL 1604—File No. E10323
- CSA Certified C22.2 No.14—File No. LR 68551
- CSA Certified C22.2 No. 213-M1987—File No. LR 20713



Ingress Protection

- Standard indicating lights
 - UL (NEMA) Type 3, 3R, 3S, 4, 4X, 12, 13
 - IEC IP65
- All other operators
 - UL (NEMA) Type 3, 3R, 4, 4X, 12, 13
 - IEC IP65

Product Overview

Operator

The 30.5 mm 10250T pushbutton line features a zinc die cast construction with chrome-plated housing and mounting nut.

Eaton's E34 Series 30.5 mm pushbutton line features the same rugged die cast construction of our 10250T line with an additional two-layer 100% solid thermosetting cathodic epoxy coating. This coating provides a flat black smooth, consistent, corrosion resistant surface that has passed a demanding 600 hour salt spray test. (The industry standard for this 4X test requires only 200 hours.)

Ultraviolet Light

E34 epoxy coating is not recommended for use in applications where exposure to ultraviolet light exists—use NEMA 4X 10250T operators.

Ratings

Our Class I Division 2 line of pushbuttons are UL Listed (NEMA type) 1, 2, 3, 3R, 4, 4X, 12 and 13. Our Class I Division 2 E34 line meets IEC 947-1 IP66 standards and the cathodic coating meets FDA 3A sanitary chemical resistance requirements. For a complete listing of all applicable ratings see **Pages V7-T1-387 to V7-T1-388.**

10250T Grounding Nibs

10250T line operators have "grounding nibs"—four metal points on the operator casting designed to bite through most paints and other coatings on metal panels to enhance the grounding connection when the operator is securely tightened.

10250T Grounding Nibs



E34 Grounding Nibs

E34 line of operators is equipped with a ground screw terminal as part of its die cast construction. This earthing terminal provides an easily accessible point for grounding operators when used in a painted or nonmetallic enclosure and eliminates the need for extra kits when daisy chain grounding is required.

E34 Grounding Nibs



Diaphragm Seal with Drainage Holes

Liquid Drainage

Eaton's pushbutton operators offer front of panel drainage via holes in the operator bushing. Hidden from view by the mounting nut, these holes prevent buildup of liquid inside the operator, which can prevent operation in freezing environments. The holes also provide a route for escaping liquid in high pressure washdowns, effectively relieving pressure from the internal diaphragm seal, ensuring reliable sealing in applications even beyond NEMA 4.

Diaphragm Seal

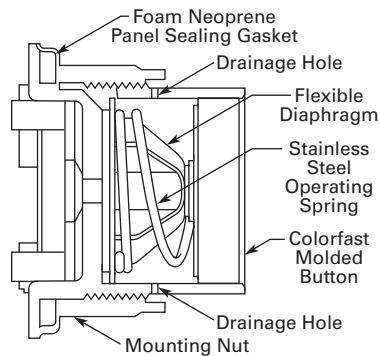

Product Identification

30.5 mm Class I Division 2 Hazardous Locations

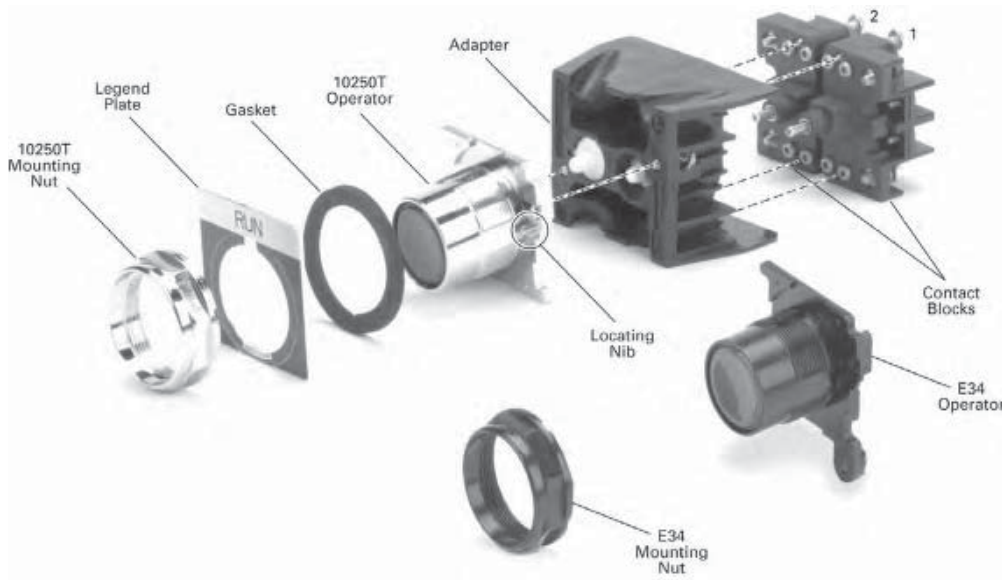

Catalog Number Selection

Catalog Number Selection is for illustrative purposes only and not to be used to create new catalog numbers.

Non-Illuminated Assembled Operators

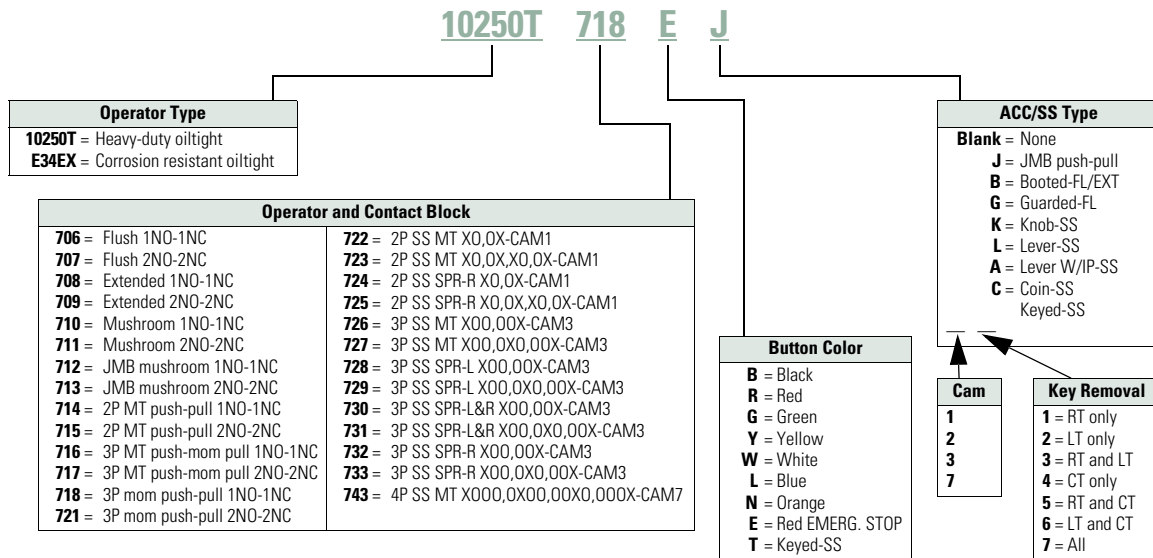

1

Product Selection

Momentary Pushbutton Units

UL (NEMA) Type 3, 3R, 4, 4X, 12, 13, NEC Class I Division 2, Groups B, C and D

10250T Flush Button



E34 Flush Button



10250T Extended Button



E34 Extended Button



Non-Illuminated Flush and Extended Pushbuttons

| Contact Type | Button Color ① | Flush Button | | Extended Button | |
|--------------|----------------|-----------------------|--------------------|-----------------------|--------------------|
| | | 10250T Catalog Number | E34 Catalog Number | 10250T Catalog Number | E34 Catalog Number |
| 1NO-1NC | Black | <u>10250T706B</u> | <u>E34EX706B</u> | <u>10250T708B</u> | <u>E34EX708B</u> |
| | Red | <u>10250T706R</u> | <u>E34EX706R</u> | <u>10250T708R</u> | <u>E34EX708R</u> |
| | Green | <u>10250T706G</u> | <u>E34EX706G</u> | <u>10250T708G</u> | <u>E34EX708G</u> |
| 2NO-2NC | Black | <u>10250T707B</u> | <u>E34EX707B</u> | <u>10250T709B</u> | <u>E34EX709B</u> |
| | Red | <u>10250T707R</u> | <u>E34EX707R</u> | <u>10250T709R</u> | <u>E34EX709R</u> |
| | Green | <u>10250T707G</u> | <u>E34EX707G</u> | <u>10250T709G</u> | <u>E34EX709G</u> |

Color Selection

| Color | Suffix Code | Color | Suffix Code |
|--------|-------------|---------------------|-------------|
| Black | B | White | W |
| Red | R | Blue | L ② |
| Green | G | Orange ③ | N |
| Yellow | Y | Red (EMERG. STOP) ④ | E |

Notes

Use NEMA 4X 10250T operators where exposed to ultraviolet light.

① To order different color guarded button, simply substitute the underlined character in catalog number with appropriate suffix code from Color Selection table above. Example: 10250T71Y.

② Blue not available on jumbo mushroom pushbutton.

③ Orange is only available on flush or extended pushbuttons.

④ Red with EMERG. STOP engraved on button head for jumbo mushroom pushbutton only.

UL (NEMA) Type 3, 3R, 4, 4X, 12, 13, NEC Class I Division 2, Groups B, C and D

10250T Mushroom Button



E34 Mushroom Button



10250T Jumbo Mushroom Button



E34 Jumbo Mushroom Button



Non-Illuminated Mushroom and Jumbo Mushroom Pushbuttons

| Contact Type | Button Color ^① | Mushroom Button | E34 | Jumbo Mushroom Button | E34 ^② |
|--------------|---------------------------|-----------------------|------------------|------------------------------------|------------------|
| | | 10250T Catalog Number | Catalog Number | 10250T ^② Catalog Number | Catalog Number |
| 1NO-1NC | Black | 10250T710B | E34EX710B | 10250T712B | E34EX712B |
| | Red | 10250T710R | E34EX710R | 10250T712R | E34EX712R |
| | Green | 10250T710G | E34EX710G | 10250T712G | E34EX712G |
| 2NO-2NC | Black | 10250T711B | E34EX711B | 10250T713B | E34EX713B |
| | Red | 10250T711R | E34EX711R | 10250T713R | E34EX713R |
| | Green | 10250T711G | E34EX711G | 10250T713G | E34EX713G |

Color Selection

| Color | Suffix Code | Color | Suffix Code |
|--------|-------------|--------------------------------|-----------------------|
| Black | B | White | W |
| Red | R | Blue | L ^③ |
| Green | G | Orange ^④ | N |
| Yellow | Y | Red (EMERG. STOP) ^⑤ | E |

Notes

- Use NEMA 4X 10250T operators where exposed to ultraviolet light.
- ^① To order different color guarded button, simply substitute the underlined character in catalog number with appropriate suffix code from Color Selection table above. Example: 10250T710Y.
- ^② Anodized aluminum head is not suitable for use in ultraviolet applications.
- ^③ Blue not available on jumbo mushroom pushbutton.
- ^④ Orange is only available on flush or extended pushbuttons.
- ^⑤ Red with EMERG. STOP engraved on button head for jumbo mushroom pushbutton only.

1.12

Pushbuttons and Indicating Lights

30.5 mm Class I Division 2 Hazardous Locations—10250T/E34

1

UL (NEMA) Type 3, 3R, 4, 4X, 12, 13, NEC Class I Division 2, Groups B, C and D

- Momentary contact
- Non-illuminated
- Booted or guarded

Booted Flush Button



Booted Extended Button



Guarded Extended Button



10250T Pushbuttons Booted and Guarded

| Contact Type | Button Color | Booted Flush Button Catalog Number | Booted Extended Button Catalog Number | Guarded Extended Button ^① Catalog Number |
|--------------|--------------|------------------------------------|---------------------------------------|---|
| 1NO-1NC | Black | 10250T706BB | 10250T708BB | 10250T706BG |
| | Red | 10250T706RB ^② | 10250T708RB | 10250T706RG |
| | Green | 10250T706GB | 10250T708GB | 10250T706GG |
| 2NO-2NC | Black | 10250T707BB | 10250T709BB | 10250T707BG |
| | Red | 10250T707RB ^② | 10250T709RB | 10250T707RG |
| | Green | 10250T707GB | 10250T709GB | 10250T707GG |

Color Selection

| Color | Suffix Code | Color | Suffix Code |
|--------|-------------|--------|-------------|
| Black | B | White | W |
| Red | R | Blue | L |
| Green | G | Orange | N |
| Yellow | Y | | |

Notes

Use NEMA 4X 10250T operators where exposed to ultraviolet light.

^① To order different color guarded button, simply substitute the underlined character in catalog number with appropriate suffix code from Color Selection table above. Example: 10250T706YG.

^② Red booted flush pushbutton is not recommended for STOP function.

UL (NEMA) Type 3, 3R, 4, 4X, 12, 13, NEC Class I Division 2, Groups B, C and D

- Momentary contact
- Non-illuminated
- Booted or guarded

Booted Flush Button



E34 Pushbuttons Booted and Guarded

| Contact Type | Button Color | Booted Flush Button Catalog Number | Booted Extended Button Catalog Number | Guarded Extended Button ^① Catalog Number |
|--------------|--------------|------------------------------------|---------------------------------------|---|
| 1NO-1NC | Black | E34EX706BB | E34EX708BB | E34EX706BG |
| | Red | E34EX706RB ^② | E34EX708RB | E34EX706RG |
| | Green | E34EX706GB | E34EX708GB | E34EX706GG |
| 2NO-2NC | Black | E34EX707BB | E34EX709BB | E34EX707BG |
| | Red | E34EX707RB ^② | E34EX709RB | E34EX707RG |
| | Green | E34EX707GB | E34EX709GB | E34EX707GG |

Booted Extended Button



Guarded Extended Button



Color Selection

| Color | Suffix Code | Color | Suffix Code |
|--------|-------------|--------|-------------|
| Black | B | White | W |
| Red | R | Blue | L |
| Green | G | Orange | N |
| Yellow | Y | | |

Notes

Use NEMA 4X 10250T operators where exposed to ultraviolet light.

^① To order different color guarded button, simply substitute the underlined character in catalog number with appropriate suffix code from Color Selection table above. Example: 10250T706YG.

^② Red booted flush pushbutton is not recommended for STOP function.

1

Non-Illuminated Pushbutton Units

UL (NEMA) Type 3, 3R, 4, 4X, 12, and 13

10250T Flush Button



E34 Flush Button



10250T Extended Button



E34 Extended Button



10250T Half Shrouded Button



E34 Half Shrouded Button



Non-Illuminated Pushbuttons, Momentary Contact

| Color | Flush Button | | Extended Button | | Half Shrouded Button | | E34 | |
|--------|--|--------------------------|-----------------------------|--------------------------|---|---------------------------------|-------------------------------|---------------------------------|
| | 10250T ^① Catalog Number | E34 Catalog Number | 10250T Catalog Number | E34 Catalog Number | 10250T Vertical Catalog Number | Horizontal Catalog Number | Vertical Catalog Number | Horizontal Catalog Number |
| Black | 10250T101 | E34PB1 | 10250T111 | E34EB1 | 10250T501 | 10250T511 | E34EVB1 | E34EHB1 |
| Red | 10250T102 | E34PB2 | 10250T112 | E34EB2 | 10250T502 | 10250T512 | E34EVB2 | E34EHB2 |
| Green | 10250T103 | E34PB3 | 10250T113 | E34EB3 | 10250T503 | 10250T513 | E34EVB3 | E34EHB3 |
| Yellow | 10250T104 | E34PB4 | 10250T120 | E34EB4 | 10250T504 | 10250T514 | E34EVB4 | E34EHB4 |
| Gray | 10250T105 | E34PB5 | — | E34EB5 | 10250T505 | 10250T515 | E34EVB5 | E34EHB5 |
| White | 10250T106 | E34PB6 | 10250T116 | E34EB6 | 10250T506 | 10250T516 | E34EVB6 | E34EHB6 |
| Blue | 10250T108 | E34PB7 | 10250T118 | E34EB7 | 10250T508 | 10250T518 | E34EVB7 | E34EHB7 |
| Orange | 10250T109 | E34PB8 | 10250T119 | E34EB8 | 10250T509 | 10250T519 | E34EVB8 | E34EHB8 |

Notes

Use NEMA 4X 10250T operators where exposed to ultraviolet light.

① To order operator with factory assembled extended retaining nut, 10250TA12, for thick panel applications, add suffix letter **E** to listed catalog number.

UL (NEMA) Type 3, 3R, 4, 4X, 12, and 13

10250T Mushroom Button



Mushroom Head Non-Illuminated Pushbuttons, Momentary Contact

| Color | Mushroom Button | | Anodized Aluminum Jumbo Mushroom Button | |
|-------------------|-----------------------|--------------------|---|---------------------------------|
| | 10250T Catalog Number | E34 Catalog Number | 10250T ^① Catalog Number | E34 ^② Catalog Number |
| Black | 10250T121 | E34LB1 | 10250T171 | E34JB1 |
| Red | 10250T122 | E34LB2 | 10250T172 | E34JB2 |
| Red (EMERG. STOP) | — | — | 10250T17213 | E34JB2N8 |
| Green | 10250T123 | E34LB3 | 10250T173 | E34JB3 |
| Yellow | 10250T124 | E34LB4 | 10250T174 | E34JB4 |
| Blue | 10250T129 | E34LB6 | — | — |

E34 Mushroom Button



10250T Jumbo Mushroom Button



E34 Jumbo Mushroom Button



Notes

- Use NEMA 4X 10250T operators where exposed to ultraviolet light.
- ① Anodized aluminum head is not suitable for use in ultraviolet light applications.
- ② Anodized aluminum head may not be suitable for some corrosive environments.

1.12

Pushbuttons and Indicating Lights

30.5 mm Class I Division 2 Hazardous Locations—10250T/E34

1

Illuminated Pushbutton Units

UL (NEMA) Type 3, 3R, 4, 4X, 12, 13, NEC Class I Division 2, Groups B, C and D

- Momentary contact
- Illuminated
- Plastic lenses

10250T₈



E34EX₈



Illuminated Pushbuttons

| Type | Voltage | Color | Contact | 10250T LED/Lamp Number | Catalog Number ① | E34 LED/Lamp Number | Catalog Number ① |
|--------------------------|-------------|-------|---------|------------------------|----------------------|-----------------------|---------------------|
| LED Lamp | | | | | | | |
| Full voltage | 24 Vac/Vdc | Red | 1NO-1NC | Bayonet base | <u>10250T828RD24</u> | Bayonet base | <u>E34EX828RD24</u> |
| | | Green | | | 10250T828GD24 | | E34EX828GD24 |
| | | Amber | | | 10250T828AD24 | | E34EX828AD24 |
| Transformer | 120 Vac | Red | 1NO-1NC | | <u>10250T828RD2A</u> | | <u>E34EX828RD2A</u> |
| | | Green | | | 10250T828GD2A | | E34EX828GD2A |
| | | Amber | | | 10250T828AD2A | | E34EX828AD2A |
| Transformer | 120 Vac | Red | 1NO-1NC | | <u>10250T802RD06</u> | Bayonet base 6 Vac | <u>E34EX802RD06</u> |
| | | Green | | | 10250T802GD06 | | E34EX802GD06 |
| | | Amber | | | 10250T802AD06 | | E34EX802AD06 |
| Incandescent Lamp | | | | | | | |
| Full voltage | 24 Vac/Vdc | Red | 1NO-1NC | #757 | <u>10250T818RD</u> | #757 | <u>E34EX818RD</u> |
| | | Green | | | 10250T818GD | | E34EX818GD |
| | | Amber | | | 10250T818AD | | E34EX818AD |
| Resistor | 120 Vac/Vdc | Red | 1NO-1NC | 120MB | <u>10250T824RD</u> | 120MB | <u>E34EX824RD</u> |
| | | Green | | | 10250T824GD | | E34EX824GD |
| | | Amber | | | 10250T824AD | | E34EX824AD |
| Transformer | 120 Vac | Red | 1NO-1NC | #755 | <u>10250T802RD</u> | #755 6 Vac | <u>E34EX802RD</u> |
| | | Green | | | 10250T802GD | | E34EX802GD |
| | | Amber | | | 10250T802AD | | E34EX802AD |

10250TC₂



E34V₂



Lens Selection

| Color | Suffix Code | Catalog Number | Color | Suffix Code | Catalog Number |
|---------------|-------------|------------------|------------|-------------|----------------|
| 10250T | | | E34 | | |
| Red | <u>R</u> | <u>10250TC21</u> | Red | <u>R</u> | <u>E34V2</u> |
| Green | <u>G</u> | <u>10250TC22</u> | Green | <u>G</u> | <u>E34V3</u> |
| Yellow | <u>Y</u> | <u>10250TC23</u> | Yellow | <u>Y</u> | <u>E34V4</u> |
| Amber | <u>A</u> | <u>10250TC43</u> | Amber | <u>A</u> | <u>E34V9</u> |
| Blue | <u>L</u> | <u>10250TC24</u> | Blue | <u>L</u> | <u>E34V6</u> |
| Clear | <u>C</u> | <u>10250TC25</u> | Clear | <u>C</u> | <u>E34V0</u> |
| White | <u>W</u> | <u>10250TC26</u> | White | <u>W</u> | <u>E34V5</u> |

Note

① To order different color lens, simply substitute the underlined character in the catalog number with appropriate suffix code from Lens Selection table above. Example: 10250T828YD24.

Guarded Illuminated Pushbutton Units

UL (NEMA) Type 3, 3R, 4, 4X, 12, 13, NEC Class I Division 2, Groups B, C and D

- Momentary contact
- Guarded illuminated
- Plastic lenses

Guarded Illuminated Pushbuttons

10250T8_



E34EX8_



| Type | Voltage | Color | Contact | 10250T LED/Lamp Number | Catalog Number ① | E34 LED/Lamp Number | Catalog Number ① |
|--------------------------|-------------|-------|---------|------------------------|----------------------|---------------------|---------------------|
| LED Lamp | | | | | | | |
| Full voltage | 24 Vac/Vdc | Red | 1NO-1NC | Bayonet base | <u>10250T828RG24</u> | Bayonet base | <u>E34EX828RG24</u> |
| | | Green | | | 10250T828GG24 | | E34EX828GG24 |
| | | Amber | | | 10250T828AG24 | | E34EX828AG24 |
| Transformer | 120 Vac | Red | 1NO-1NC | | <u>10250T828RG2A</u> | | <u>E34EX828RG2A</u> |
| | | Green | | | 10250T828GG2A | E34EX828GG2A | |
| | | Amber | | | 10250T828AG2A | E34EX828AG2A | |
| Transformer | 120 Vac | Red | 1NO-1NC | | <u>10250T802RG06</u> | | <u>E34EX802RG06</u> |
| | | Green | | | 10250T802GG06 | E34EX802GG06 | |
| | | Amber | | | 10250T802AG06 | E34EX802AG06 | |
| Incandescent Lamp | | | | | | | |
| Full voltage | 24 Vac/Vdc | Red | 1NO-1NC | #757 | <u>10250T818RG</u> | #757 | <u>E34EX818RG</u> |
| | | Green | | | 10250T818GG | | E34EX818GG |
| | | Amber | | | 10250T818AG | | E34EX818AG |
| Resistor | 120 Vac/Vdc | Red | 1NO-1NC | 120MB | <u>10250T824RG</u> | 120MB | <u>E34EX824RG</u> |
| | | Green | | | 10250T824GG | | E34EX824GG |
| | | Amber | | | 10250T824AG | | E34EX824AG |
| Transformer | 120 Vac | Red | 1NO-1NC | #755 | <u>10250T802RG</u> | #755 6 Vac | <u>E34EX802RG</u> |
| | | Green | | | 10250T802GG | | E34EX802GG |
| | | Amber | | | 10250T802AG | | E34EX802AG |

10250TC2_



E34V_



Lens Selection

| Color | Suffix Code | Catalog Number | Color | Suffix Code | Catalog Number |
|---------------|-------------|------------------|------------|-------------|----------------|
| 10250T | | | E34 | | |
| Red | <u>R</u> | <u>10250TC21</u> | Red | <u>R</u> | <u>E34V2</u> |
| Green | <u>G</u> | <u>10250TC22</u> | Green | <u>G</u> | <u>E34V3</u> |
| Yellow | <u>Y</u> | <u>10250TC23</u> | Yellow | <u>Y</u> | <u>E34V4</u> |
| Amber | <u>A</u> | <u>10250TC43</u> | Amber | <u>A</u> | <u>E34V9</u> |
| Blue | <u>L</u> | <u>10250TC24</u> | Blue | <u>L</u> | <u>E34V6</u> |
| Clear | <u>C</u> | <u>10250TC25</u> | Clear | <u>C</u> | <u>E34V0</u> |
| White | <u>W</u> | <u>10250TC26</u> | White | <u>W</u> | <u>E34V5</u> |

Note

① To order different color lens, simply substitute the underlined character in the catalog number with appropriate suffix code from Lens Selection table above. Example: 10250T828YD24.

1

Indicating Light Units

UL (NEMA) Type 3, 3R, 3S, 4, 4X, 12, 13, NEC Class I Division 2, Groups B, C and D

- Standard
- Plastic lenses

10250T_



Indicating Lights

| Type | Voltage | Color | LED/Lamp Number | 10250T Catalog Number ① | E34 Catalog Number ① | |
|-----------------|--------------------------|------------|------------------------|-------------------------|-----------------------|-------------------|
| LED Lamp | | | | | | |
| Full voltage | 24 Vac/Vdc | Red | Bayonet base | <u>10250T197HLRP24</u> | <u>E34FB197HLRP24</u> | |
| | | Green | | <u>10250T197HLGP24</u> | <u>E34FB197HLGP24</u> | |
| | | Amber | | <u>10250T197HLAP24</u> | <u>E34FB197HLAP24</u> | |
| | 120 Vac | Red | | <u>10250T197HLRP2A</u> | <u>E34FB197HLRP2A</u> | |
| | | Green | | <u>10250T197HLGP2A</u> | <u>E34FB197HLGP2A</u> | |
| | | Amber | | <u>10250T197HLAP2A</u> | <u>E34FB197HLAP2A</u> | |
| Transformer | 120 Vac | Red | <u>10250T181HLRP06</u> | <u>E34TB120HLRP06</u> | | |
| | | Green | <u>10250T181HLGP06</u> | <u>E34TB120HLGP06</u> | | |
| | | Amber | <u>10250T181HLAP06</u> | <u>E34TB120HLAP06</u> | | |
| | Incandescent Lamp | | | | | |
| | Full voltage | 24 Vac/Vdc | Red | #757 | <u>10250T206HRP</u> | <u>E34FB24HRP</u> |
| | | | Green | | <u>10250T206HGP</u> | <u>E34FB24HGP</u> |
| Amber | | | <u>10250T206HAP</u> | | <u>E34FB24HAP</u> | |
| Resistor | 120 Vac/Vdc | Red | 120MB | <u>10250T201HRP</u> | <u>E34RB120HRP</u> | |
| | | Green | | <u>10250T201HGP</u> | <u>E34RB120HGP</u> | |
| | | Amber | | <u>10250T201HAP</u> | <u>E34RB120HAP</u> | |
| Transformer | 120 Vac | Red | #755 | <u>10250T181HRP</u> | <u>E34TB120HRP</u> | |
| | | Green | | <u>10250T181HGP</u> | <u>E34TB120HGP</u> | |
| | | Amber | | <u>10250T181HAP</u> | <u>E34TB120HAP</u> | |

E34_



Plastic



Glass



Lens Selection

| Color | Plastic Suffix Code | Catalog Number | Color | Glass Suffix Code | Catalog Number | Color | Plastic Suffix Code | Catalog Number | Color | Glass Suffix Code | Catalog Number |
|---------------|---------------------|----------------|--------|-------------------|----------------|------------|---------------------|----------------|--------|-------------------|----------------|
| 10250T | | | | | | E34 | | | | | |
| Red | RP | 10250TC1N | Red | RG | 10250TC7N | Red | RP | E34H2 | Red | RG | E34G2 |
| Green | GP | 10250TC2N | Green | GG | 10250TC8N | Green | GP | E34H3 | Green | GG | E34G3 |
| Amber | AP | 10250TC19N | Amber | AG | 10250TC9N | Amber | AP | E34H9 | Amber | AG | E34G9 |
| Yellow | YP | 10250TC3N | Yellow | — | — | Yellow | YP | E34H4 | Yellow | YG | E34G4 |
| Blue | LP | 10250TC4N | Blue | LG | 10250TC10N | Blue | LP | E34H6 | Blue | LG | E34G6 |
| Clear | CP | 10250TC5N | Clear | CG | 10250TC11N | Clear | CP | E34H0 | Clear | CG | E34G0 |
| White | WP | 10250TC6N | White | WG | 10250TC12N | White | WP | E34H5 | White | WG | E34G5 |

Notes

Use NEMA 4X 10250T operators where exposed to ultraviolet light.

① To order different color lens, simply substitute the underlined characters in the catalog number with appropriate suffix code from the Lens Selection table above.
Example: 10250T201HYP.

Illuminated Pushbuttons and Indicating Lights

NEC Class I Division 2, Groups B, C and D

Operators without Lenses

10250T Illuminated Pushbutton



E34 Illuminated Pushbutton



10250T Indicating Light



E34 Indicating Light



| Type | Voltage | LED/Lamp Number | Illuminated Pushbutton | | Indicating Light | | |
|--|---------------------|-------------------|------------------------|--------------------|-----------------------|--------------------|------------------|
| | | | 10250T Catalog Number | E34 Catalog Number | 10250T Catalog Number | E34 Catalog Number | |
| LED Light Unit Type (LEDs not included) ① | | | | | | | |
| Full voltage | — | Bayonet base | 10250T397HL | E34CB497HL | 10250T197HL | E34FB197HL | |
| Transformer AC only | 24 | | 10250T416HL | E34XB024HL | — | — | |
| | 120 | | 10250T411HL | E34XB120HL | 10250T181HL | E34TB120HL | |
| | 240 | | 10250T412HL | E34XB240HL | 10250T182HL | E34TB240HL | |
| | 277 | | 10250T419HL | E34XB277HL | 10250T198HL | E34TB277HL | |
| | 380 | | 10250T413HL | E34XB380HL | 10250T183HL | E34TB380HL | |
| | 480 | | 10250T414HL | E34XB480HL | 10250T184HL | E34TB480HL | |
| | 600 | | 10250T415HL | E34XB600HL | 10250T185HL | E34TB600HL | |
| Incandescent Light Unit Type | | | | | | | |
| Full voltage AC/DC | 6 | #755 | 10250T473H | E34CB06H | 10250T203H | E34FB06H | |
| | 12 | #756 | 10250T474H | E34CB12H | 10250T204H | E34FB12H | |
| | 24 | #757 | 10250T476H | E34CB24H | 10250T206H | E34FB24H | |
| | 32 | #1828 | 10250T477H | E34CB32H | 10250T207H | E34FB32H | |
| | 48 | #1835 | 10250T478H | E34CB48H | 10250T208H | E34FB48H | |
| Resistor ② AC/DC | 120 | 120MB | 10250T471H | E34SB120H | 10250T201H | E34RB120H | |
| | 240 | 120MB | 10250T472H | E34SB240H | 10250T202H | E34RB240H | |
| | Transformer AC only | 24 | #755 | 10250T416H | E34XB024H | — | — |
| | | 120 | | 10250T411H | E34XB120H | 10250T181H | E34TB120H |
| | | 240 | | 10250T412H | E34XB240H | 10250T182H | E34TB240H |
| | | 277 | | 10250T419H | E34XB277H | 10250T198H | E34TB277H |
| | | 380 | | 10250T413H | E34XB380H | 10250T183H | E34TB380H |
| | | 480 | | 10250T414H | E34XB480H | 10250T184H | E34TB480H |
| 600 | | 10250T415H | E34XB600H | 10250T185H | E34TB600H | | |
| Neon AC/DC | 120 | NE51H-R-22 | — | — | 10250T226H | E34NB120H | |
| | 240 | NE51H-4-68 | — | — | 10250T227H | E34NB240H | |





Notes

Use NEMA 4X 10250T operators where exposed to ultraviolet light.



① These units do not include lamps. Order LED separately to match lens color from the LED Selection table on **Page V7-T1-373**.

② Resistor units are not available for use with LEDs, choose either transformer or full voltage LED style.

Indicating Light Lenses

| | Color | 10250T Catalog Number | E34 Catalog Number |
|---|--------|--------------------------|-----------------------|
| Plastic | | | |
|  10250TC_  E34H_ | Red | 10250TC1N | E34H2 |
| | Green | 10250TC2N | E34H3 |
| | Amber | 10250TC19N | E34H9 |
| | Yellow | 10250TC3N | E34H4 |
| | Blue | 10250TC4N | E34H6 |
| | Clear | 10250TC5N | E34H0 |
| | White | 10250TC6N | E34H5 |
| Glass | | | |
|  10250TC_  E34G_ | Red | 10250TC7N | E34G2 |
| | Green | 10250TC8N | E34G3 |
| | Amber | 10250TC9N | E34G9 |
| | Yellow | — | E34G4 |
| | Blue | 10250TC10N | E34G6 |
| | Clear | 10250TC11N | E34G0 |
| | White | 10250TC12N | E34G5 |

Illuminated Pushbutton Lenses

| | Color | 10250T Catalog Number | E34 Catalog Number |
|--|--------|--------------------------|-----------------------|
|  10250TC_  E34V_ | Red | 10250TC21 | E34V2 |
| | Green | 10250TC22 | E34V3 |
| | Yellow | 10250TC23 | E34V4 |
| | Amber | 10250TC43 | E34V9 |
| | Blue | 10250TC24 | E34V6 |
| | Clear | 10250TC25 | E34V0 |
| | White | 10250TC26 | E34V5 |

Push-Pull Units

UL (NEMA) Type 3, 3R, 4, 4X, 12, 13, NEC Class I Division 2, Groups B, C and D

- Two- and three-position
- Non-illuminated

| 10250T71_ | | Two-Position Maintained Push, Maintained Pull | | | | | |
|--------------------------------|-----------------|---|---------------------|---|--------------------------|--------------------|--|
| Operator Function (Position) ① | | Contact Type | Mounting Location ① | | Red Standard Push-Pull ② | | |
| Maintained—Pull | Maintained—Push | | 1 | 2 | 10250T Catalog Number | E34 Catalog Number | |
| 0 | X | 1NO | | | 10250T714R | E34EX714R | |
| X | 0 | 1NC | | | | | |
| 0 | X | 2NO | | | 10250T715R | E34EX715R | |
| X | 0 | 2NC | | | | | |
| 0 | X | | | | | | |
| X | 0 | | | | | | |

| 10250T71_ | | Three-Position Maintained Push, Momentary Pull | | | | | |
|--------------------------------|-------------------------|--|--------------|---------------------|---|--------------------------|--------------------|
| Operator Function (Position) ① | | | Contact Type | Mounting Location ① | | Red Standard Push-Pull ③ | |
| Momentary—Pull | Maintained—Intermediate | Maintained—Push | | 1 | 2 | 10250T Catalog Number | E34 Catalog Number |
| 0 | 0 | X | 1NO | | | 10250T716R | E34EX716R |
| X | 0 | 0 | 1NC | | | | |
| X | 0 | 0 | 1NC | | | 10250T717R | E34EX717R |
| X | X | 0 | 1NC | | | | |

Notes

- ① Bolded circuit corresponds to "X-0" circuit selection. X = closed circuit, 0 = open circuit.
- ② To order different type or color buttons, simply substitute underlined character with appropriate suffix code from the Button and Color Selection table on **Page V7-T1-366**. Example: 10250T714G.
- ③ To order different type or color buttons, simply substitute underlined character with appropriate suffix code from the Button and Color Selection table on **Page V7-T1-366**. Example: 10250T716G.

1.12

Pushbuttons and Indicating Lights

30.5 mm Class I Division 2 Hazardous Locations—10250T/E34

1

UL (NEMA) Type 3, 3R, 4, 4X, 12, 13, NEC Class I Division 2, Groups B, C and D

- Two- and three-position
- Non-illuminated

10250T7_



E34EX7_



Three-Position Momentary Push, Momentary Pull

Operator Function (Position) ①

Momentary—
Pull

Maintained—
Intermediate

Momentary—
Push

Contact
Type

Mounting Location ①



Red Standard Push-Pull ②

10250T
Catalog Number

E34
Catalog Number

0
X

0
0

X
0

1NO
1NC



10250T718R

E34EX718R

X

0

0

1NC



10250T721R

E34EX721R

X

X

0

1NC



Button and Color Selection

| Color | Suffix Code | 10250T Catalog Number | E34 Catalog Number |
|-------|-------------|-----------------------|--------------------|
|-------|-------------|-----------------------|--------------------|

Standard



Standard

| | | | |
|-------------------|----------|------------------|----------------|
| Red | R | 10250TB62 | E34C2 |
| Red (EMERG. STOP) | E | 10250TB63 | E34C2N8 |
| Green | G | 10250TB61 | E34C3 |
| Black | B | 10250TB60 | E34C1 |
| Blue | L | 10250TB64 | E34C6 |

Jumbo Mushroom Head



Jumbo Mushroom Head (Anodized) Aluminum

| | | | |
|-------------------|-----------|------------------|----------------|
| Red | RJ | 10250TJ62 | E34J2 |
| Red (EMERG. STOP) | EJ | 10250TJ63 | E34J2N8 |
| Green | GJ | 10250TJ61 | — |
| Black | BJ | 10250TJ60 | — |
| Yellow | YJ | 10250TJ64 | — |

Notes

① Bolded circuit corresponds to "X-0" circuit selection. X = closed circuit, 0 = open circuit.

② To order different type or color buttons, simply substitute underlined character with appropriate suffix code from the Button and Color Selection table above. Example: 10250T718G.

Illuminated Push-Pull Units

UL (NEMA) Type 3, 3R, 4, 4X, 12, 13, NEC Class I Division 2, Groups B, C and D

- Two-position maintained
- Illuminated

10250T8



E34EX8



Two-Position Illuminated Maintained Push, Maintained Pull

Operator Function (Position) ①

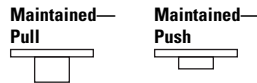

| Operator Function (Position) ① | | Type | Voltage | Contact Type | Mounting Location ① | Red Standard Push-Pull ② | |
|--------------------------------|-----------------|--------------|------------|--------------|---------------------|--------------------------|---------------------|
| Maintained Pull | Maintained Push | | | | | 10250T Catalog Number | E34 Catalog Number |
| LED Lamp | | | | | | | |
| 0 | X | Full voltage | 24 Vac/Vdc | 1NO | | 10250T853RD24 | E34EX853RD24 |
| X | 0 | | 120 Vac | 1NC | | 10250T853RD2A | E34EX853RD2A |
| | | Transformer | 24 Vac | | | 10250T843RD06 | E34EX843RD06 |
| | | | 120 Vac | | | 10250T844RD06 | E34EX844RD06 |
| Incandescent Lamp | | | | | | | |
| 0 | X | Full voltage | 24 Vac/Vdc | 1NO | | 10250T849RD | E34EX849RD |
| X | 0 | | Resistor | 120 Vac/Vdc | | 1NC | 10250T851RD |
| | | Transformer | 24 Vac | | | 10250T843RD | E34EX843RD |
| | | | 120 Vac | | | 10250T844RD | E34EX844RD |

Lens and Color Selection

| Color | 10250T | | E34 | |
|--|-------------|------------------|-------------|----------------|
| | Suffix Code | Catalog Number | Suffix Code | Catalog Number |
| Standard | | | | |
| Red | RD | 10250TC47 | RD | E34M2 |
| Red (EMERG. STOP) | ED | 10250TC53 | ED | E34M2N8 |
| Green | GD | 10250TC48 | GD | E34M3 |
| Blue | LD | 10250TC49 | LD | E34M6 |
| Amber | AD | 10250TC50 | AD | E34M9 |
| White | WD | 10250TC51 | WD | E34M5 |
| Clear | CD | 10250TC52 | CD | E34M0 |
| Side-Lighted (Anodized) Aluminum | | | | |
| Red | RS | 10250TC57 | — | — |
| Red (EMERG. STOP) | ES | 10250TC63 | — | — |
| Green | GS | 10250TC58 | — | — |
| Blue | LS | 10250TC59 | — | — |
| Amber | AS | 10250TC64 | — | — |
| Yellow | YS | 10250TC60 | — | — |
| White | WS | 10250TC61 | — | — |
| Clear | CS | 10250TC62 | — | — |
| HD Aluminum with Transparent Center | | | | |
| Red | RH | 10250TC65 | — | — |
| Green | GH | 10250TC66 | — | — |
| Amber | AH | 10250TC67 | — | — |

Notes

- ① Bolded circuit corresponds to "X-0" circuit selection. X = closed circuit, 0 = open circuit.
- ② To order different type or color lens, simply substitute the underlined characters with appropriate suffix code from the Lens and Color Selection table above. Example: 10250T851GS.

1.12

Pushbuttons and Indicating Lights

30.5 mm Class I Division 2 Hazardous Locations—10250T/E34

1

UL (NEMA) Type 3, 3R, 4, 4X, 12, 13, NEC Class I Division 2, Groups B, C and D

- Three-position—maintained push, momentary pull
- Illuminated

10250T₈



E34EX₈



Three-Position Illuminated Maintained Push, Momentary Pull

Operator Function (Position) ①

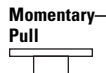

| Operator Function (Position) ① | | | Type | Voltage | Contact Type | Mounting Location ① | | Red Standard Push-Pull ② | | |
|--------------------------------|-------------------------|-----------------|--------------|-------------|--------------|---------------------|---|--------------------------|----------------------|---------------------|
| Momentary Pull | Maintained Intermediate | Maintained Push | | | | 1 | 2 | 10250T Catalog Number | E34 Catalog Number | |
| LED Lamp | | | | | | | | | | |
| 0 | 0 | X | Full voltage | 24 Vac/Vdc | 1NO | | | 10250T864RD24 | E34EX864RD24 | |
| X | 0 | 0 | | 120 Vac | 1NC | | | 10250T864RD2A | E34EX864RD2A | |
| | | | | Transformer | 24 Vac | | | | 10250T854RD06 | E34EX854RD06 |
| | | | | 120 Vac | | | | 10250T855RD06 | E34EX855RD06 | |
| X | 0 | 0 | Full voltage | 24 Vac/Vdc | 1NC | | | 10250T875RD24 | E34EX875RD24 | |
| X | X | 0 | | 120 Vac | 1NC | | | 10250T875RD2A | E34EX875RD2A | |
| | | | | Transformer | 24 Vac | | | | 10250T865RD06 | E34EX865RD06 |
| | | | | 120 Vac | | | | 10250T866RD06 | E34EX866RD06 | |
| Incandescent Lamp | | | | | | | | | | |
| 0 | 0 | X | Full voltage | 24 Vac/Vdc | 1NO | | | 10250T860RD | E34EX860RD | |
| X | 0 | 0 | | Resistor | 120 Vac | | | 1NC | 10250T862RD | E34EX862RD |
| | | | | Transformer | 24 Vac | | | | 10250T854RD | E34EX854RD |
| | | | | 120 Vac | | | | 10250T855RD | E34EX855RD | |
| X | 0 | 0 | Full voltage | 24 Vac/Vdc | 1NC | | | 10250T871RD | E34EX871RD | |
| X | X | 0 | | Resistor | 120 Vac | | | 1NC | 10250T873RD | E34EX873RD |
| | | | | Transformer | 24 Vac | | | | 10250T865RD | E34EX865RD |
| | | | | 120 Vac | | | | 10250T866RD | E34EX866RD | |

Notes

① Bolded circuit corresponds to "X-0" circuit selection. X = closed circuit, 0 = open circuit.

② To order different type or color lens, simply substitute the underlined characters with appropriate suffix code from the Lens and Color Selection table on the bottom of **Page V7-T1-367**. Example: 10250T862AS.

UL (NEMA) Type 3, 3R, 4, 4X, 12, 13, NEC Class I Division 2, Groups B, C and D

- Three-position—momentary
- Illuminated

10250T₈



E34EX₈



Three-Position Illuminated Momentary Push, Momentary Pull

Operator Function (Position) ①

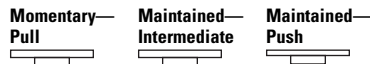

| Momentary Pull | Maintained Intermediate | Maintained Push | Type | Voltage | Contact Type | Mounting Location ① | | Red Standard Push-Pull ② | |
|--------------------------|-------------------------|-----------------|--------------|------------|--------------|---------------------|---|--------------------------|---------------------|
| | | | | | | 1 | 2 | 10250T Catalog Number | E34 Catalog Number |
| LED Lamp | | | | | | | | | |
| 0 | 0 | X | Full voltage | 24 Vac/Vdc | 1NO | | | 10250T886RD24 | E34EX886RD24 |
| X | 0 | 0 | | 120 Vac | 1NC | | | 10250T886RD2A | E34EX886RD2A |
| | | | Transformer | 24 Vac | | | | 10250T876RD06 | E34EX876RD06 |
| | | | | 120 Vac | | | | 10250T877RD06 | E34EX877RD06 |
| X | 0 | 0 | Full voltage | 24 Vac/Vdc | 1NC | | | 10250T897RD24 | E34EX897RD24 |
| X | X | 0 | | 120 Vac | 1NC | | | 10250T897RD2A | E34EX897RD2A |
| | | | Transformer | 24 Vac | | | | 10250T887RD06 | E34EX887RD06 |
| | | | | 120 Vac | | | | 10250T888RD06 | E34EX888RD06 |
| Incandescent Lamp | | | | | | | | | |
| 0 | 0 | X | Full voltage | 24 Vac/Vdc | 1NO | | | 10250T882RD | E34EX882RD |
| X | 0 | 0 | | Resistor | 120 Vac | | | 1NC | 10250T884RD |
| | | | Transformer | 24 Vac | | | | 10250T876RD | E34EX876RD |
| | | | | 120 Vac | | | | 10250T877RD | E34EX877RD |
| X | 0 | 0 | Full voltage | 24 Vac/Vdc | 1NC | | | 10250T893RD | E34EX893RD |
| X | X | 0 | | Resistor | 120 Vac | | | 1NC | 10250T895RD |
| | | | Transformer | 24 Vac | | | | 10250T887RD | E34EX887RD |
| | | | | 120 Vac | | | | 10250T888RD | E34EX888RD |

Notes

- ① Bolded circuit corresponds to "X-0" circuit selection. X = closed circuit, 0 = open circuit.
- ② To order different type or color lens, simply substitute the underlined characters with appropriate suffix code from the Lens and Color Selection table on the bottom of **Page V7-T1-367**. Example: 10250T862**AS**.

1.12

Pushbuttons and Indicating Lights

30.5 mm Class I Division 2 Hazardous Locations—10250T/E34

1

Push-Pull Operators

An illuminated push-pull pushbutton unit, arranged for one-hole mounting, can replace two pushbuttons and a pilot light or the non-illuminated form can replace two pushbuttons. These units are available in three basic types:

- **Maintained**—(Two-position). Maintains in the pulled or pushed position until manually actuated to the opposite mode.
- **Momentary**—(Three-position). Spring returns to an intermediate position when pulled or pushed and released.

- **Momentary Pull, Maintained Push**—(Three-position). Spring returns to intermediate position when pulled. Maintains in pushed position until manually returned to intermediate (ready to reset) position. Maintained stop holds circuit open and will prevent other series connected operators from starting the system.

The operators, buttons, contact blocks, etc., are offered as building block components that can be intermixed to satisfy many requirements. This minimizes the need for a varied and costly inventory.

Application Guide

To assist in the selection of contact blocks, the sketch below shows pictorially by symbols **1** and **2** locations of contact circuits after assembly of contact blocks and adapter to the operator. The table below shows the effect of the push and pull operations on either NO or NC contacts. (X = contact closed, O = contact open).

Locating Nibs

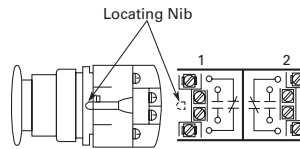

10250T_ Push-Pull Operator Components



E34G_



Operator Position and Circuit Arrangement



| Type of Operator | Contact Block | Contact Block Mounting Location | | | | 10250T Catalog Number | E34 Catalog Number | | | | | |
|---|---------------------|---------------------------------|---|--------------------------|---|-----------------------|--------------------|----------------|---------------|---|-----------------|---------------|
| | | 1 | | 2 | | | | | | | | |
| Two-Position Operator without Lens | | | | | | | | | | | | |
| Maintained push-pull | 1NO | O | O | No intermediate position | X | X | 10250T5 | E34GDB | | | | |
| | 1NC | X | X | | O | O | | | | | | |
| | 2NO | O | O | X | X | | | | | | | |
| | 2NC | X | X | O | O | | | | | | | |
| Three-Position Operator without Lens | | | | | | | | | | | | |
| Momentary push-pull | 1NO | O | O | O | O | X | X | 10250T4 | E34GEB | | | |
| | 1NC | X | X | O | X | O | O | | | | | |
| Maintained push-momentary pull | 2NO | O | O | O | O | X | O | 10250T9 | E34GFB | | | |
| | 2NC | X | X | O | X | O | O | | | | | |
| | Momentary push-pull | 1NO | O | O | O | O | X | | | X | 10250T10 | E34GHB |
| | | 1NC | X | X | O | O | O | | | O | | |
| | 2NO | O | O | O | O | X | X | | | | | |
| | 2NC | X | X | O | O | O | O | | | | | |

Note

Use NEMA 4X 10250T operators where exposed to ultraviolet light.

Push-Pull Light Units, Lenses and Buttons

NEC Class I Division 2 Groups B, C and D

Light Units for Illuminated Push-Pull Devices

| Light Unit Type | Type | Voltage | LED/Lamp Number | Catalog Number |
|------------------------------------|------------------------------------|--------------|------------------|--------------------------|
| LED (LEDs not included) ① | Full voltage | — | Bayonet base | 10250T97HL |
| | Transformer AC only 50/60 Hz | 24 | | 10250T89HL |
| | | 120 | | 10250T63HL |
| | | 208 | | 10250T64HL |
| | | 240 | | 10250T65HL |
| | | 277 | | 10250T82HL |
| | | 380 | | 10250T66HL |
| | | 480 | | 10250T67HL |
| | | 600 | | 10250T68HL |
| | | Incandescent | | Full voltage AC or DC |
| 12 | #756 | | 10250T70H | |
| 24/28 | #757 | | 10250T79H | |
| 32 | #1828 | | 10250T83H | |
| Resistor AC or DC | 120 | | 120MB | 10250T80H |
| | 240 | | | 10250T81H |
| Transformer AC only 50/60 Hz | 24 | | #755 | 10250T89H |
| | 120 | | | 10250T63H |
| | 208 | | | 10250T64H |
| | 240 | | | 10250T65H |
| | 277 | | | 10250T82H |
| | 380 | | | 10250T66H |
| | 480 | | | 10250T67H |
| 600 | | | 10250T68H | |

Note

① These units do not include lamps. Order LED separately to match lens color from table on **Page V7-T1-373**.

Alternate Lenses for Illuminated Push-Pull Devices

Standard



| Color | 10250T Catalog Number | E34 Catalog Number |
|-------------------|-----------------------|--------------------|
| Standard | | |
| Red | 10250TC47 | E34M2 |
| Red (EMERG. STOP) | 10250TC53 | E34M2N8 |
| Green | 10250TC48 | E34M3 |
| Blue | 10250TC49 | E34M6 |
| Amber | 10250TC50 | E34M9 |
| White | 10250TC51 | E34M5 |
| Clear | 10250TC52 | E34M0 |

Side-Lighted (Anodized) Aluminum



| Color | 10250T Catalog Number | E34 Catalog Number |
|--|-----------------------|--------------------|
| Side-Lighted Anodized Aluminum Ring | | |
| Red | 10250TC57 | — |
| Red (EMERG. STOP) | 10250TC63 | — |
| Green | 10250TC58 | — |
| Blue | 10250TC59 | — |
| Amber | 10250TC64 | — |
| Yellow | 10250TC60 | — |
| White | 10250TC61 | — |
| Clear | 10250TC62 | — |

HD Aluminum with Transparent Center



| Color | 10250T Catalog Number | E34 Catalog Number |
|--|-----------------------|--------------------|
| Heavy-Duty Aluminum with Transparent Center | | |
| Red | 10250TC65 | — |
| Green | 10250TC66 | — |
| Amber | 10250TC67 | — |

Buttons for Non-Illuminated Push-Pull Devices

Standard



| Color | 10250T Catalog Number | E34 Catalog Number |
|-------------------|-----------------------|--------------------|
| Standard | | |
| Red | 10250TB62 | E34C2 |
| Red (EMERG. STOP) | 10250TB63 | E34C2N8 |
| Green | 10250TB61 | E34C3 |
| Black | 10250TB60 | E34C1 |
| Blue | 10250TB64 | E34C6 |

Jumbo Mushroom Head



| Color | 10250T Catalog Number | E34 Catalog Number |
|---|-----------------------|--------------------|
| Jumbo Mushroom Head (Anodized) Aluminum [Ⓢ] | | |
| Red | 10250TJ62 | E34J2 |
| Red (EMERG. STOP) | 10250TJ63 | E34J2N8 |
| Green | 10250TJ61 | — |
| Black | 10250TJ60 | — |
| Yellow | 10250TJ64 | — |

Notes

Use NEMA 4X 10250T operators where exposed to ultraviolet light.

[Ⓢ] Anodized aluminum head is not suitable for use with ultraviolet light applications.

Standard LED Lamp



LED Selection

| Voltage | Color | Catalog Number |
|---|--------|----------------|
| 6 Vac/Vdc suitable for use with transformers | Red | E22LED006RN |
| | Orange | E22LED006ON |
| | Yellow | E22LED006YN |
| | Green | E22LED006GN |
| | Blue | E22LED006BN |
| | White | E22LED006WN |
| 12 Vac/Vdc | Red | E22LED012RN |
| | Orange | E22LED012ON |
| | Yellow | E22LED012YN |
| | Green | E22LED012GN |
| | Blue | E22LED012BN |
| | White | E22LED012WN |
| 24 Vac/Vdc | Red | E22LED024RN |
| | Orange | E22LED024ON |
| | Yellow | E22LED024YN |
| | Green | E22LED024GN |
| | Blue | E22LED024BN |
| | White | E22LED024WN |
| 48 Vac/Vdc | Red | E22LED048RN |
| | Orange | E22LED048ON |
| | Yellow | E22LED048YN |
| | Green | E22LED048GN |
| | Blue | E22LED048BN |
| | White | E22LED048WN |

| Voltage | Color | Catalog Number |
|------------|--------|----------------|
| 60 Vac/Vdc | Red | E22LED060RN |
| | Orange | E22LED060ON |
| | Yellow | E22LED060YN |
| | Green | E22LED060GN |
| | Blue | E22LED060BN |
| | White | E22LED060WN |
| 120 Vac | Red | E22LED120RA |
| | Orange | E22LED120OA |
| | Yellow | E22LED120YA |
| | Green | E22LED120GA |
| | Blue | E22LED120BA |
| | White | E22LED120WA |
| 120 Vdc | Red | E22LED120RD |
| | Orange | E22LED120OD |
| | Yellow | E22LED120YD |
| | Green | E22LED120GD |
| | Blue | E22LED120BD |
| | White | E22LED120WD |

Note

For a complete listing of all LEDs available, see **Page V7-T1-269**.

1.12

Pushbuttons and Indicating Lights

30.5 mm Class I Division 2 Hazardous Locations—10250T/E34

1

Selector Switch Units

UL (NEMA) Type 3, 3R, 4, 4X, 12, 13, NEC Class I Division 2, Groups B, C and D

- Two- and three-position
- Non-illuminated

10250T72_

Two-Position Selector Switch—Non-Illuminated



E34EX72_



| Operator Position ^① | | Operator Action ^② | Contact Type | Mounting Location ^① | | Cam Code | Black Knob—Selector Switch ^③ | |
|--------------------------------|---|------------------------------|--------------|--------------------------------|---|----------|---|--------------------|
| | | | | 1 | 2 | | 10250T Catalog Number | E34 Catalog Number |
| X | O | | 1NC | | | 1 | <u>10250T722BK</u> | <u>E34EX722BK</u> |
| O | X | | 1NO | | | | <u>10250T724BK</u> | <u>E34EX724BK</u> |
| X | O | | 1NC | | | 1 | <u>10250T723BK</u> | <u>E34EX723BK</u> |
| O | X | | 1NO | | | | <u>10250T725BK</u> | <u>E34EX725BK</u> |

10250T_

Three-Position Selector Switch—Non-Illuminated



| Operator Position ^① | | | Operator Action ^② | Contact Type | Mounting Location ^① | | Cam Code | Black Knob—Selector Switch ^④ | |
|--------------------------------|---|---|------------------------------|------------------|--------------------------------|---|----------|---|--------------------|
| | | | | | 1 | 2 | | 10250T Catalog Number | E34 Catalog Number |
| X | O | O | | 1NO | | | 3 | <u>10250T726BK</u> | <u>E34EX726BK</u> |
| O | O | X | | 1NO | | | | <u>10250T728BK</u> | <u>E34EX728BK</u> |
| | | | | | | | | <u>10250T730BK</u> | <u>E34EX730BK</u> |
| | | | | | | | | <u>10250T732BK</u> | <u>E34EX732BK</u> |
| X | O | O | | 1NO | | | 3 | <u>10250T727BK</u> | <u>E34EX727BK</u> |
| O | X | O | | 1NC-1NC (Series) | | | | <u>10250T729BK</u> | <u>E34EX729BK</u> |
| O | O | X | 1NO | | | | | <u>10250T731BK</u> | <u>E34EX731BK</u> |
| | | | | | | | | <u>10250T733BK</u> | <u>E34EX733BK</u> |

Notes

- ① Bolded circuit corresponds to "X-O" circuit selection. X = closed circuit, O = open circuit.
- ② M = Maintained. S = Spring return in direction of arrow (→).
- ③ To order different type or color selector switch, simply substitute the underlined characters with appropriate suffix code from the table on **Page V7-T1-375**.
Example: 10250T722LL. For keyed selector switch, substitute the underlined characters with **T_ (cam)+_ (key removal position)**. Example: 10250T722T13.
- ④ To order different type or color selector switch, simply substitute the underlined characters with appropriate suffix code from the Switch and Color Selection table on **Page V7-T1-375**.
Example: 10250T726LL. For keyed selector switch, substitute the underlined characters with **T_ (cam)+_ (key removal position)**. Example: 10250T726T13.

UL (NEMA) Type 3, 3R, 4, 4X, 12, 13, NEC Class I Division 2, Groups B, C and D

- Four-position maintained
- Non-illuminated

10250T743

Four-Position Selector Switch—Non-Illuminated



E34EX743



Operator Position ①



Operator Action ②



Contact Type

Mounting Location ①

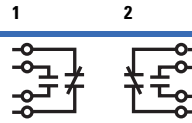

Cam Code

Black Knob—Selector Switch ③

10250T Catalog Number **E34 Catalog Number**

7 **10250T743BK** **E34EX743BK**

Knob



Lever



Coin Slot ⑤



Switch and Color Selection

| Color | Knob Suffix Code | Lever Suffix Code | Lever ④ Suffix Code | Coin Slot ⑤ Suffix Code |
|--------|------------------|-------------------|---------------------|-------------------------|
| Black | BK | BL | BA | BC |
| Red | RK | RL | RA | RC |
| Green | GK | GL | GA | GC |
| Yellow | YK | YL | YA | YC |
| White | WK | WL | WA | WC |
| Gray | AK | AL | AA | AC |
| Blue | LK | LL | LA | LC |
| Orange | NK | NL | NA | NC |

Key Operated Selection

| Number of Position | Operator Action ⑥ | Suffix and Removal Position |
|--------------------|-------------------|-----------------------------|
| 2 | M M | T1 + 1, 2, 3 |
| | M ← S | T1 + 2 |
| 3 | M M M | T3 + 1–7 |
| | S → M M | T3 + 1, 4, 5 |
| | S → M ← S | T3 + 4 |
| | M M ← S | T3 + 2, 4, 6 |
| 4 | MMMM | T7 + 7 |

Key Removal Positions ⑦

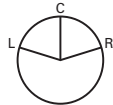

| Code Suffix | Key Removal Position |
|-------------|----------------------|
| 1 | Right only |
| 2 | Left only |
| 3 | Right and left |
| 4 | Center only |
| 6 | Left and center |
| 7 | All positions |

Notes

- ① Bolded circuit corresponds to “X-0” circuit selection. X = closed circuit, 0 = open circuit.
- ② M = Maintained.
- ③ To order different type or color selector switch, simply substitute the underlined characters with appropriate suffix code from the Switch and Color Selection table above. Example: 10250T743LL. For keyed selector switch, substitute the underlined characters with **T_ (cam) + _ (key removal position)**. Example: 10250T7431ZZ.
- ④ Designed for added ingress protection. For use in maintained operators only.
- ⑤ 10250T only.
- ⑥ M = Maintained. S = Spring return in direction of arrow (→).
- ⑦ Key removal in “spring return from” positions not recommended.

1

Selector Switch Selection



10250T



E34

Cam and Contact Block Selection

Selector switches in their varied forms (two-position, three-position, and four-position) are a big factor contributing to the great flexibility of control that a well rounded line of “pushbuttons” can achieve. Because of their flexibility, they tend to cause difficulty with product selection and application. The following systematic approach should simplify that task.

Cam and contact block selection is better understood if you:

- Work with each incoming and outgoing wire/circuit separately.
- Recognize the terms NO and NC only identify the type of contact by its mode before mounting to the operator. The “X-O” table (Page V7-T1-378) shows how that contact will act after assembly to the operator with the selected cam shape. X = closed circuit, O = open circuit.

- One NO-NC contact block may be mounted behind each plunger of the mounting adapter for a total of four circuits.
- Each cam has two separate lobes, each of which operates one of the two contact block plungers independently of each other. Those are identified as position 1 (locating nib side) and position 2 (opposite of locating nib). The position designations give direction in selecting and mounting of the contact blocks.

Contact Circuit Locations

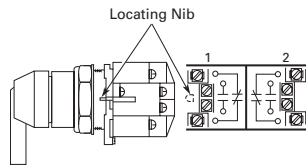

Systematic Approach

Application: **HAND-OFF-AUTO** selector switch. In this circuit, one incoming line is distributed to two other outgoing circuits by the switch. The two circuits can be looked at individually.

Step 1: Elementary Diagram.

Construct on paper, or in your mind, a simple elementary diagram of the switching scheme as follows:

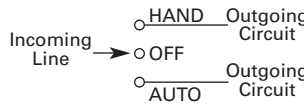

In this circuit, you want a contact closed on the left (HAND) but open in the center and right.

For the **AUTO** circuit, the “X-O” diagram would look like this:

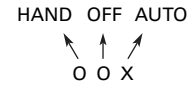

Putting them together, the complete “X-O” diagram is:



Step 2: “X-O” Pattern.

From the elementary diagram, you can construct an “X-O” diagram which describes when the contacts are to be closed (X) or open (O) in the various positions of the switch. The “X-O” for the **HAND** circuit looks like this:

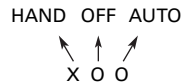

Once the “X-O” diagram has been generated, the next step is to select the cam and contact block, or blocks, needed to perform the desired “X-O” functions. The selection tables on the following pages list the various types (shapes) of cams by number to choose from and the type of contact and position to achieve the function outlined in your “X-O” diagram.

Step 3: Cam Selection.

The cam you select determines the operation of all contact blocks mounted to the operator. It is selected on the basis that it provides the simplest circuitry for the desired “X-O” diagram. The selection tables show all the “X-O” combinations. For the purpose of this example, the applicable portion of those tables is shown on this page.

Now to make the cam selection, make a simple worksheet such as below. (1) or (2) = mounting location from chart above:

| | Cam 2 | Cam 3 |
|-------|---------------|-------|
| X O O | (1)NO-(2)NC ① | (1)NO |
| O O X | (2)NO | (2)NO |

It becomes obvious that cam 3 is the better choice because the series connection can be avoided, making it simpler to wire.

Step 4: Contact Block Selection.

Having selected the cam, contact block selection is simply a matter of determining if you require one NO-NC contact block (Cat. No 10250T1H) or two. Given the limitations of the factory sealed contact block and the desired “X-O” application, you may have circuits that will not be needed—as seen here with the two additional NC circuits. (1) or (2) = mounting location from chart above.

| Qty | Catalog No. | Cam 3 |
|-----|-------------|----------------------------|
| 2 | 10250TIH | (1)NO (2)NC (1)NC (2)NO |

Step 5: Selector Switch Operator.

Lastly, you have to choose from the many types of operators—knob and lever in various colors or keyed. Also what combinations of maintained and spring return functions are required. Selection of these operators can be found on **Page V7-T1-379**. For the example in step 4, you may want a three-position maintained black knob, cam 3—Catalog Number 10250T1323 (or 34VHBK1).

The Complete Switch: 10250T1323 (or 34VHBK1) with two 10250T1H or for one composite catalog number—10250T726BK (or E34EX726BK) found on **Page V7-T1-374**.

Diagrams

Circuits shown illustrate connections to obtain a selector circuit combination and are shown with their appropriate line diagrams in **BOLD**. Field wiring of jumper connections required as shown.

X = Closed circuit
O = Open circuit

Example Selection Table

| No. | Desired Circuit and Operator Position | | | Cam Code #2 Contact Blocks and Mounting Location | | Cam Code #3 Contact Blocks and Mounting Location | |
|-----|---------------------------------------|---|---|--|---|--|---|
| | | | | 1 | 2 | 1 | 2 |
| 1 | X | O | O | | | | — |
| 4 | O | O | X | — | | — | |

Note
① Wired in series.

1.12

Pushbuttons and Indicating Lights

30.5 mm Class I Division 2 Hazardous Locations—10250T/E34

1

Two-Position Selector Switch

| Number | Desired Circuit and Operator Position | | Cam Code #1 Contact Blocks and Mounting Location | |
|--------|---------------------------------------|---|--|---|
| | | | 1 | 2 |
| 1 | X | 0 | | |
| 2 | 0 | X | | |

Three-Position Selector Switch

| No. | Desired Circuit and Operator Position | | | Cam Code #2 Contact Blocks and Mounting Location | | Cam Code #3 Contact Blocks and Mounting Location | |
|-----|---------------------------------------|---|---|--|---|--|---|
| | | | | 1 | 2 | 1 | 2 |
| 1 | X | 0 | 0 | | | — | — |
| 2 | X | X | 0 | — | | — | |
| 3 | X | 0 | X | | — | | — |
| 4 | 0 | 0 | X | — | | — | |
| 5 | 0 | X | X | | | — | — |
| 6 | 0 | X | 0 | | — | | — |

Four-Position Selector Switch

| Number | Desired Circuit and Operator Position | | | | Cam Code #7 Contact Blocks and Mounting Location | |
|--------|---------------------------------------|---|---|---|--|---|
| | | | | | 1 | 2 |
| 1 | X | 0 | 0 | 0 | | — |
| 2 | 0 | X | 0 | 0 | — | |
| 3 | 0 | 0 | X | 0 | | — |
| 4 | 0 | 0 | 0 | X | — | |
| 5 | X | 0 | 0 | X | | — |
| 6 | 0 | X | X | 0 | | — |
| 7 | 0 | 0 | X | X | | — |
| 8 | X | X | 0 | 0 | | — |
| 9 | 0 | X | 0 | X | — | |
| 10 | X | 0 | X | 0 | | — |

Selector Switch Operators

10250T Selector Switch Operators with Caps

UL (NEMA) Type 3, 3R, 4, 4X, 12, 13

Black Knob Selector Switch



10250T Selector Switch Operators with Caps

| Positions | Operator Action ^① | Black Knob Selector Switch— Vertical Mounting ^② | | Black Lever Selector Switch— Vertical Mounting ^② | |
|--------------------------|------------------------------|---|----------------|--|----------------|
| | | Cam Code ^③ | Catalog Number | Cam Code ^③ | Catalog Number |
| Two-position—60° throw | | 1 | 10250T1311 | 1 | 10250T3011 |
| | | 1 | 10250T1371 | 1 | 10250T3071 |
| Three-position—60° throw | | 2 | 10250T1322 | 2 | 10250T3022 |
| | | 3 | 10250T1323 | 3 | 10250T3023 |
| | | 2 | 10250T1332 | 2 | 10250T3032 |
| | | 3 | 10250T1333 | 3 | 10250T3033 |
| | | 2 | 10250T1342 | 2 | 10250T3042 |
| | | 3 | 10250T1343 | 3 | 10250T3043 |
| Four-position—40° throw | | 2 | 10250T1352 | 2 | 10250T3052 |
| | | 3 | 10250T1353 | 3 | 10250T3053 |
| | | 7 | 10250T1367 | 7 | 10250T3067 |

Black Lever Selector Switch



Horizontal Mounting



10250T Key Operators with Cam

| Positions | Operator Action ^① | Cam Code ^③ | Optional Key Removal Positions ^④ | Vertical Mounting Catalog Number ^④ | Horizontal Mounting Catalog Number ^④ |
|--------------------------|------------------------------|-----------------------|--|--|--|
| Two-position—60° throw | | 1 | 1, 2, 3 | 10250T1511_ | 10250T1611_ |
| | | 1 | 2 | 10250T1571_ | 10250T1581_ |
| Three-position—60° throw | | 2 | 1–7 | 10250T1522_ | 10250T1622_ |
| | | 3 | | 10250T1523_ | 10250T1623_ |
| | | 2 | 1, 4, 5 | 10250T1532_ | 10250T1632_ |
| | | 3 | | 10250T1533_ | 10250T1633_ |
| | | 2 | 4 | 10250T1542_ | 10250T1642_ |
| | | 3 | | 10250T1543_ | 10250T1643_ |
| Four-position—40° throw | | 2 | 2, 4, 6 | 10250T1652_ | 10250T1662_ |
| | | 3 | | 10250T1653_ | 10250T1663_ |
| Four-position—40° throw | | 7 | 7 | 10250T1677_ | 10250T1687_ |

Key Removal Positions

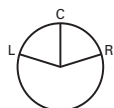

Key Removal Positions ^⑤

| Code Suffix | Key Removal Position | Code Suffix | Key Removal Position |
|----------------|-------------------------|----------------|-------------------------|
| 1 | Right only | 5 | Right and center |
| 2 | Left only | 6 | Left and center |
| 3 | Right and left | 7 | All positions |
| 4 | Center only | | |

Notes

- ① M = Maintained. S = Spring return in direction of arrow (→).
- ② Field convertible to horizontal mounting or order operator only and separate operator cap.
- ③ For selection of the proper cam and contact block to obtain the proper circuit sequence, see selection instructions and table on **Pages V7-T1-376 to V7-T1-378**.
- ④ Choose key removal position required for application from table above. Add key removal code no. to listed catalog number. Example: 10250T15112.
- ⑤ Key removal in “spring return from” positions not recommended.

Replacement Keys or Dissimilar Locks for Above Key Operators

Listed operators have identical locks and keys (Key Code H661) Catalog Number 10250ED824.

Replacement Keys

| Description | Catalog Number |
|------------------------------|----------------|
| Replacement keys (code H661) | 10250ED824 |

1.12

Pushbuttons and Indicating Lights

30.5 mm Class I Division 2 Hazardous Locations—10250T/E34

1

UL (NEMA) Type 3, 3R, 4, 4X, 12, 13

Black Knob Selector Switch



E34 Selector Switch Operators with Knob Assembled

| Positions | Operator Action ^① | Black Knob Selector Switch— Vertical Mounting ^② | |
|--------------------------|------------------------------|---|-----------------------------|
| | | Cam Code ^③ | Catalog Number ^④ |
| Two-position—60° throw | | 1 | E34VFBK1 |
| | | 1 | E34VEBK1 |
| Three-position—60° throw | | 2 | E34VGBK1 |
| | | 3 | E34VHBK1 |
| | | 2 | E34VJBK1 |
| | | 3 | E34VKBK1 |
| | | 2 | E34VLBK1 |
| | | 3 | E34VMBK1 |
| Four-position—40° throw | | 2 | E34VNBK1 |
| | | 3 | E34VPBK1 |
| Four-position—40° throw | | 7 | E34VTBK1 |

E34KFB_



E34 Key Operators with Cam and Cap

| Positions | Operator Action ^① | Cam Code ^③ | Key Removal Positions ^⑤ | Vertical Mounting | Horizontal Mounting |
|--------------------------|------------------------------|-----------------------|------------------------------------|-------------------|---------------------|
| | | | | Catalog Number | Catalog Number |
| Two-position—60° throw | | 1 | 1, 2, 3 | E34KFB_ | E34KFHB_ |
| | | 1 | 2 | E34KEB_ | E34KEHB_ |
| Three-position—60° throw | | 2 | 1–7 | E34KGB_ | E34KGHB_ |
| | | 3 | | E34KHB_ | E34KHGB_ |
| | | 2 | 1, 4, 5 | E34KJB_ | E34KJHB_ |
| | | 3 | | E34KKB_ | E34KKHB_ |
| | | 2 | 4 | E34KLB_ | E34KLHB_ |
| | | 3 | | E34KMB_ | E34KMHB_ |
| Four-position—40° throw | | 2 | 2, 4, 6 | E34KNB_ | E34KNHB_ |
| | | 3 | | E34KPB_ | E34KPHB_ |
| Four-position—40° throw | | 7 | 7 | E34KTB_ | E34KTHB_ |

Notes

Use NEMA 4X 10250T operators where exposed to ultraviolet light, see [Page V7-T1-379](#).

① M = Maintained. S = Spring return in direction of arrow (→).

② Field convertible to horizontal mounting.

③ For selection of the proper cam and contact block to obtain the proper circuit sequence, see selection instructions and table on [Pages V7-T1-376 to V7-T1-378](#).

④ For other colors of either knob or lever, replace the underlined characters of the catalog number with the appropriate suffix code from Alternate Knobs and Levers table on [Page V7-T1-381](#). Example: E34VFBL2.

⑤ Choose key removal position required for application from table on [Page V7-T1-381](#). Add key removal code no. to listed catalog number. Example: E34KFB2.

Key Removal Positions

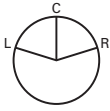

Key Removal Positions

| Code Suffix | Key Removal Position | Code Suffix | Key Removal Position |
|-------------|----------------------|-------------|----------------------|
| 1 | Right only | 5 | Right and center |
| 2 | Left only | 6 | Left and center |
| 3 | Right and left | 7 | All positions |
| 4 | Center only | | |

Knob



Lever



Lever for Added Ingress Protection



Alternate Knobs and Levers for Operators ^①

| Color | Knob | | Lever | | Lever Designed for Added Ingress Protection ^② | |
|--------|-------------|----------------|-------------|----------------|--|----------------|
| | Suffix Code | Catalog Number | Suffix Code | Catalog Number | Suffix Code | Catalog Number |
| Black | K1 | E34K1 | L1 | E34L1 | A1 | E34A1 |
| Red | K2 | E34K2 | L2 | E34L2 | A2 | E34A2 |
| Green | K3 | E34K3 | L3 | E34L3 | A3 | E34A3 |
| Yellow | K4 | E34K4 | L4 | E34L4 | A4 | E34A4 |
| White | K5 | E34K5 | L5 | E34L5 | A5 | E34A5 |
| Blue | K6 | E34K6 | L6 | E34L6 | A6 | E34A6 |
| Gray | K7 | E34K7 | L7 | E34L7 | A7 | E34A7 |
| Orange | K8 | E34K8 | L8 | E34L8 | A8 | E34A8 |

Notes

- ① Key removal in “spring return from” positions not recommended.
- ② For use on maintained operators only.

1

Illuminated Selector Switch Operators

Two-Position Maint. Selector Switch



10250T Illuminated Selector Switch Operator Only without Knob or Lever

| Position | Operator Action ① | Transformer Type—50/60 Hz 6V #755 Lamp | | | Full Voltage Type—AC or DC ④ | | | |
|--------------------------|-------------------------|---|---------|---------------------------|------------------------------|----------|---------------------------|-------------|
| | | Cam Code ③ | Voltage | Catalog and Code Number ② | Cam Code ③ | Voltage | Catalog and Code Number ② | |
| Two-position—60° throw | | 1 | 24 | 10250T5961H | 1 | 6 | 10250T6201H | |
| | | | 120 | 10250T5971H | | 12 | 10250T6211H | |
| | | | 208 | 10250T6511H | | 24 | 10250T6221H | |
| | | | 240 | 10250T5981H | | 48 | 10250T6231H | |
| | | | 380 | 10250T5991H | | 120 | 10250T6361H | |
| | | | 480 | 10250T6001H | | 240 ⑤ | 10250T6371H | |
| | | | 600 | 10250T6011H | | | | |
| Three-position—60° throw | | + 2 or 3 | 24 | 10250T602_H | + 2 or 3 | 6 | 10250T624_H | |
| | | | 120 | 10250T603_H | | 12 | 10250T625_H | |
| | | | 208 | 10250T652_H | | 24 | 10250T626_H | |
| | | | 240 | 10250T604_H | | 48 | 10250T627_H | |
| | | | 380 | 10250T605_H | | 120 | 10250T638_H | |
| | | | 480 | 10250T607_H | | 240 ⑤ | 10250T639_H | |
| | | | 600 | 10250T607_H | | | | |
| | | + 2 or 3 | 120 | 10250T620_H | + 2 or 3 | 120 | 10250T622_H | |
| | | | 240 | 10250T656_H | | | | |
| | | | | | | | | |
| | | + 2 or 3 | 120 | 10250T621_H | + 2 or 3 | 120 | 10250T623_H | |
| | | | 240 | 10250T662_H | | | | |
| | Four-position—40° throw | | 7 | 24 | 10250T614_H | + 2 or 3 | 6 | 10250T628_H |
| | | | | 120 | 10250T615_H | | 12 | 10250T629_H |
| 208 | | | | 10250T653_H | 24 | | 10250T630_H | |
| 240 | | | | 10250T616_H | 48 | | 10250T631_H | |
| 380 | | | | 10250T617_H | 120 | | 10250T640_H | |
| 480 | | | | 10250T618_H | 240 ⑤ | | 10250T641_H | |
| 600 | | | | 10250T619_H | | | | |
| | | | 24 | 10250T6087H | 7 | 6 | 10250T6327H | |
| | | | 120 | 10250T6097H | | 12 | 10250T6337H | |
| | | | 208 | 10250T6547H | | 24 | 10250T6347H | |
| | | | 240 | 10250T6107H | | 48 | 10250T6357H | |
| | | | 380 | 10250T6117H | | 120 | 10250T6427H | |
| | | | 480 | 10250T6127H | | 240 ⑤ | 10250T6437H | |
| | | | 600 | 10250T6137H | | | | |

Knob



Lever



Knobs and Levers

| Color ⑥ | Knob Catalog and Code Number | Lever Catalog and Code Number | Color ⑥ | Knob Catalog and Code Number | Lever Catalog and Code Number |
|---------|------------------------------|-------------------------------|---------|------------------------------|-------------------------------|
| Red | 10250TER | 10250TFR | Clear | 10250TEC | 10250TFC |
| Green | 10250TEG | 10250TFG | White | 10250TEW | 10250TFW |
| Yellow | 10250TEA | 10250TFA | Amber | 10250TEM | 10250TFM |
| Blue | 10250TEL | 10250TFL | | | |

Notes

- ① M = Maintained. S = Spring return in direction of arrow (→).
- ② For selection of the proper cam and contact block, to obtain the proper circuit sequence, see selection table on [Page V7-T1-378](#).
- ③ Operator includes lens gasket and lens attachment screws.
- ④ Full voltage light units can be used at other than listed voltages by changing lamp. Replacement lamps are listed on [Page V7-T1-269](#).
- ⑤ Resistor type. May generate excess heat if used in high density.
- ⑥ Amber, clear and white lenses have a black arrow (pointer), red, green and blue lenses have a white arrow (pointer).

120 Vac Transformer Selector Switch, Cam 1



Illuminated Selector Switch Operator Only without Knob or Lever

| Positions | Operator Action | Transformer Type—50/60 Hz 6V #755 Lamp Catalog Number ^{①②} | Full Voltage Type—AC or DC ^③ Lamps—#755, #757, #1835, 120MB ^④ Catalog Number ^② | | | |
|--------------------------|-----------------|---|---|--|--|--|
| Two-position—60° throw | | Cam Code 1 ^⑤ E34VFB_H | Cam Code 1 ^⑤ E34SFB_H | | | |
| Three-position—60° throw | | Cam Code 2 ^⑤ E34VGB_H | Cam Code 3 ^⑤ E34VHB_H | Cam Code 2 ^⑤ E34SGB_H | Cam Code 3 ^⑤ E34SHB_H | |
| | | E34VNB_H ^⑥ | E34VPB_H ^⑥ | E34SNB_H ^⑦ | E34SPB_H ^⑦ | |
| | | E34VJB_H ^⑥ | E34VKB_H ^⑥ | E34SJB_H ^⑦ | E34SKB_H ^⑦ | |
| | | E34VLB_H | E34VMB_H | E34SLB_H | E34SMB_H | |
| Four-position—40° throw | | E34VRB_H | — | E34SRB_H | — | |

Knob



Lever



Knobs and Levers

| Color ^④ | Knob Catalog Number and Code Number | Lever Catalog Number and Code Number |
|--------------------|-------------------------------------|--------------------------------------|
| Red | 10250TER | 10250TFR |
| Green | 10250TEG | 10250TFG |
| Yellow | 10250TEA | 10250TFA |
| Blue | 10250TEL | 10250TFL |
| Clear | 10250TEC | 10250TFC |
| White | 10250TEW | 10250TFW |
| Amber | 10250TEM | 10250TFM |

Light Unit Voltage Suffix

Add to operator catalog number listed in table above.

| Type of Light Unit | | Full Voltage Type AC or DC ^③ | |
|---------------------------|-------------|---|-------------|
| Transformer Type 50/60 Hz | Suffix Code | Voltage | Suffix Code |
| 24 | 024 | 6 | 06 |
| 120 | 120 | 12 | 12 |
| 208 | 208 | 24 | 24 |
| 240 | 240 | 48 | 48 |
| 380 | 380 | 120 | 120 |
| 480 | 480 | 240 ^⑥ | 240 |
| 600 | 600 | | |

Notes

Use NEMA 4X 10250T operators where exposed to ultraviolet light, see **Page V7-T1-382**.

- ① Operator includes lens gasket and lens attachment screws.
- ② Replace underscore with proper voltage suffix code from Light Unit Voltage Suffix table above. Example: three-position maintained with 120V transformer type light unit: E34VGB~~1~~20H.
- ③ Full voltage light units can be used at other than listed voltages by changing lamp. Replacement lamps are listed on **Page V7-T1-269**.
- ④ 120MB lamps are used on both 120V and 240V operators.
- ⑤ For selection of the proper cam and contact block required to obtain a specific circuit sequence, see selection table on **Page V7-T1-378**.
- ⑥ 120 and 240V transformer only.
- ⑦ 120 full voltage only.
- ⑧ Resistor type. May generate excess heat if used in high density.
- ⑨ Amber, clear and white lenses have a black arrow (pointer). Red, green and blue lenses have a white arrow (pointer).

Options

Contact Blocks and Mounting Adapters

NEC Class I Division 2, Groups B, C and D

Contact Block



Contact Block

| Description | Catalog Number |
|--|----------------|
| Class I Division 2 factory sealed contact block with 1NO-1NC | 10250T1H |

Dimensions, see Page V7-T1-389.

Mounting Adapter



Mounting Adapter

| Description | Catalog Number |
|--|----------------|
| Mounting adapter for pushbuttons | 10250TD2 |
| Mounting adapter for selector switches | 10250TD3 |

Dimensions, see Page V7-T1-389.

Mounting Adapters with Contact Block(s)—Overpacked

| Description | Catalog Number |
|--|----------------|
| Pushbutton adapter with 1NO-1NC | 10250TD21H |
| Pushbutton adapter with 2 (1NO-1NC) | 10250TD21H1H |
| Selector switch adapter with 1NO-1NC | 10250TD31H |
| Selector switch adapter with 2 (1NO-1NC) | 10250TD31H1H |

Mounting and Assembly

Panel Thickness

- Minimum: 0.06 in (1.6 mm)
- Maximum: 0.25 in (8 mm) including legend plate
- Maximum can be increased to 0.375 in (15.9 mm) using optional retaining nut
 - Indicating light: 10250TA30/E34TA30
 - Pushbutton/selector switch: 10250TA31/E34TA31

Mounting Matrix

| Legend Plate | Dimensions in Inches (mm) | | | |
|--------------|---------------------------|-------------|-------------|-------------|
| | A | B | C | D |
| Small | 2.87 (72.6) | 2.25 (57.2) | 2.25 (57.2) | 2.87 (72.6) |
| Jumbo | 2.87 (72.6) | 2.32 (58.6) | 2.32 (58.6) | 2.87 (72.6) |
| Extra large | 2.87 (72.6) | 2.56 (65.2) | 2.52 (64.1) | 2.87 (72.6) |

Panel Spacing and Drilling

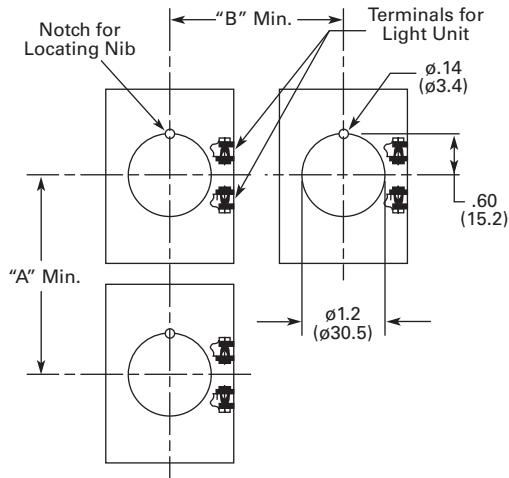

Drilling for One Hole Mounting and Dimensions for Minimum Spacing in Vertical Rows.

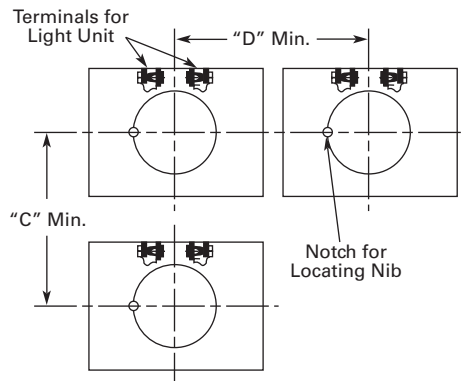

Drilling for One Hole Mounting and Dimensions for Minimum Spacing in Horizontal Rows.

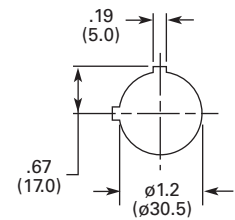

NOTE: Suitable for Use in This Alternate Mounting Hole.

Operator Assembly

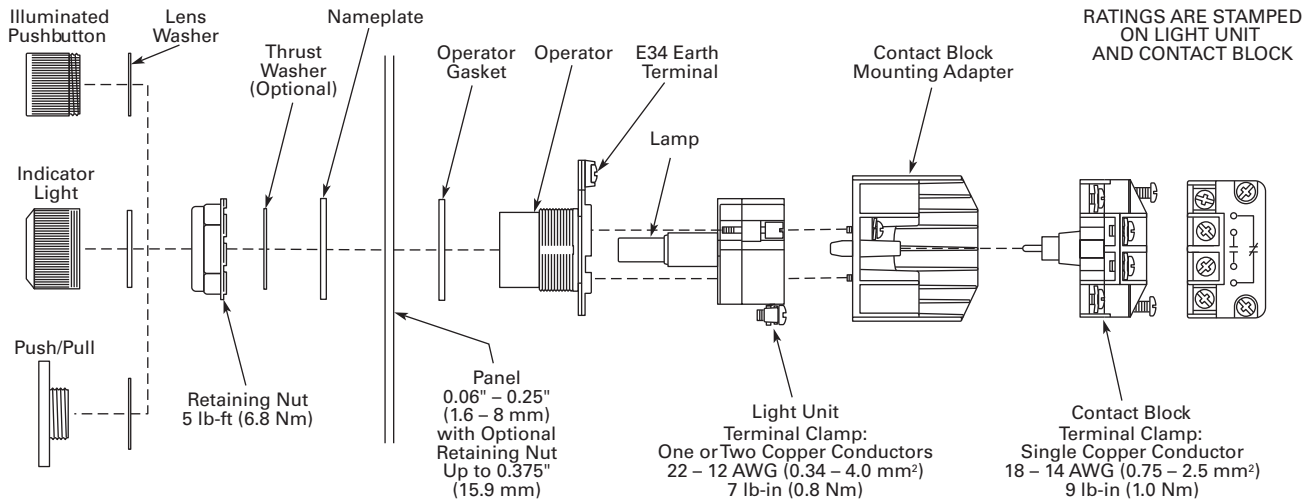



RATINGS ARE STAMPED ON LIGHT UNIT AND CONTACT BLOCK

1

Enclosures

Die Cast, Polyester and Stainless Steel Enclosures

Enclosures (Case and Cover)—Surface Mounting ^①

| | Number of Elements | 10250T Catalog Number | E34 Catalog Number |
|--|---|-----------------------|--------------------|
| Die Cast Enclosure  | Die Cast Enclosure—Deep Cover—In-Line NEMA 4, 4X, 12, 13 | | |
| | 1 | 10250TN11 | E34N11 |
| | 2 | 10250TN12 | E34N12 |
| | 3 | 10250TN13 | E34N13 |
| | 4 | 10250TN14 | E34N14 |
| Polyester Enclosure  | Polyester—In-Line NEMA 3, 4X, 12 | | |
| | 1 | — | E34N51 |
| | 2 | — | E34N52 |
| | 3 | — | E34N53 |
| | 4 | — | E34N54 |
| Stainless Steel Enclosure  | Stainless Steel ^②—In-Line NEMA 4, 4X, 12 | | |
| | 1 | — | 10250TN33 |
| | 2 | — | 10250TN34 |
| | 3 | — | 10250TN35 |
| | 4 | — | 10250TN36 |

Dimensions, see **Page V7-T1-389**.

Notes

- ^① For spacing increments, see **Page V7-T1-264**.
- ^② 14 gauge, type 304.

Application Notes:

1. Operators need to be mounted in their horizontal orientation for all enclosures. For die cast enclosures remove locating nib on operators and use thrust washer (Catalog Number 10250TK3).
2. Polyester enclosures must be used when mounting illuminated operators.

Enclosure Layouts

Top – For Vertical Mounting

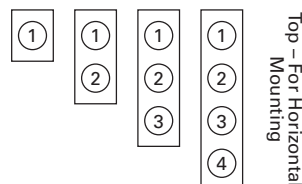

Top – For Horizontal Mounting

Technical Data and Specifications

Mechanical Ratings

| Description | Specification |
|---------------------------------|-----------------------------------|
| Frequency of Operation | |
| All pushbuttons | 6000 operations/hr. |
| Key and lever selector switches | 3000 operations/hr. |
| Life | |
| Pushbuttons | 10 x 10 ⁶ operations |
| Contact block | 10 x 10 ⁶ operations |
| Key and lever selector switches | 0.25 x 10 ⁶ operations |
| Shock Resistance | |
| Duration/force | 20 ms ≥5g |

Climatic Conditions

| Description | Specification |
|-----------------------|------------------------------|
| Operating temperature | 32° to 140°F (0° to 66°C) |
| Storage temperature | -40° to 176°F (-40° to 80°C) |
| Altitude | 6,562 ft (2,000m) |
| Humidity | Max. 95% RH at 60°C |

Terminals

| Description | Specification |
|--|--|
| Light Units | |
| Clamps | Terminals are saddle clamp type for 1 x 22 AWG (0.34 mm ²) to 2 x 14 AWG (4.0 mm ²) conductors |
| Torque | 7 lb-in (0.8 Nm) |
| Degree of protection against direct electrical contact | IP2X with fingerproof shroud |
| Contact Blocks | |
| Clamps | Terminals are stainless steel saddle clamp type for 1 x 18–14 AWG (0.75–2.5 mm ²) solid or stranded copper conductor |
| Torque | 9 lb-in (1.0 Nm) with size 2 Phillips screwdriver |
| Degree of protection against direct electrical contact | IP2X with fingerproof shroud |

Electrical Ratings

| Description | Specification |
|------------------------------|------------------------------------|
| Light Units | |
| Bulbs—average life: | |
| Transformer type | 20,000 hrs. |
| Resistor/direct voltage type | 2500 hrs. minimum at rated voltage |
| LED | 60,000 to 100,000 hrs. |

1.12

Pushbuttons and Indicating Lights

30.5 mm Class I Division 2 Hazardous Locations—10250T/E34

1

Electrical Ratings—Contact Block

Meet or Exceed NEMA Contact Rating Designations A600 and Q300

| Description | A600 (AC) | | | | Q300 (DC) | |
|--|-----------|------|------|------|-----------|------|
| | 120V | 240V | 480V | 600V | 125V | 250V |
| Make and emerg. interrupting capacity (amps) | 60 | 30 | 15 | 12 | 0.55 | 0.27 |
| Normal load break (amps) | 6 | 3 | 1.5 | 1.2 | 0.55 | 0.27 |
| Thermal current (amps) | 10 | 10 | 10 | 10 | 2.5 | 2.5 |
| Voltamperes: | | | | | | |
| Maximum make | 7200 | 7200 | 7200 | 7200 | 69 | 69 |
| Maximum break | 720 | 720 | 720 | 720 | 69 | 69 |

Temperature Codes

All illuminated devices have operating temperatures below 100°C except for the following catalog numbers with temperature codes per NEC table 500.5(d) and UL 1604:

| 10250T | E34 | Temp. Code |
|--|-----------|------------|
| 10250T201H | E34RB120H | T3C |
| 10250T202H | E34RB240H | T3A |
| 10250T471H | E34SB120H | TC3 |
| 10250T472H | E34SB240H | T3B |
| 10250T80H | — | T3C |
| 10250T81H | — | T3B |
| All selector switches w/120 MB lamp | | T3C |
| All illuminated devices with lamp 1835 | | T4A |

Note: For additional technical information, see Publication Number **TD.74.T.E.04**.

Dimensions

Approximate Dimensions in Inches (mm)

Surface Mounting

Die Cast, Polyester and Stainless Steel Enclosures

4 Mtg. Holes — 10-32 Screw Size for
1 – 4 Element Die Cast/
Stainless Steel Enclosure
7/32 Screw Size for
Polyester

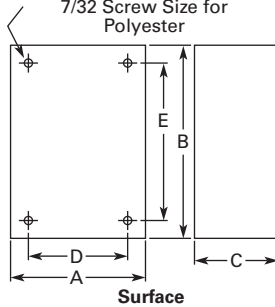

| Number of Elements | Element Arrangement | Wide A | High B | Deep C | Mounting D | E | Conduit Entrance |
|------------------------|---------------------|-------------|---------------|-------------|-------------|---------------|------------------|
| Die Cast | | | | | | | |
| 1 | In-line | 3.88 (98.6) | 4.00 (101.6) | 3.00 (76.3) | 2.69 (68.3) | 3.25 (82.6) | 3/4 |
| 2 | | 3.88 (98.6) | 5.88 (149.4) | 3.00 (76.3) | 2.69 (68.3) | 5.13 (130.3) | |
| 3 | | 3.88 (98.6) | 7.75 (196.9) | 3.00 (76.3) | 2.69 (68.3) | 7.00 (177.8) | 1 |
| 4 | | 3.88 (98.6) | 9.63 (244.6) | 3.00 (76.3) | 2.69 (68.3) | 8.88 (225.6) | |
| Polyester | | | | | | | |
| 1 | In-line | 3.81 (96.8) | 6.63 (168.4) | 3.38 (85.9) | 2.94 (74.7) | 4.88 (124.0) | ① |
| 2 | | 3.81 (96.8) | 6.63 (168.4) | 3.38 (85.9) | 2.94 (74.7) | 4.88 (124.0) | |
| 3 | | 3.81 (96.8) | 8.88 (225.6) | 3.38 (85.9) | 2.94 (74.7) | 7.13 (181.1) | |
| 4 | | 3.81 (96.8) | 11.13 (282.7) | 3.38 (85.9) | 2.94 (74.7) | 9.38 (238.3) | |
| Stainless Steel | | | | | | | |
| 1 | In-line | 3.00 (76.2) | 3.50 (88.9) | 3.00 (76.2) | 1.50 (38.1) | 4.25 (108.0) | ① |
| 2 | | 3.50 (88.9) | 6.75 (171.5) | 3.00 (76.2) | 1.50 (38.1) | 7.50 (190.5) | |
| 3 | | 3.50 (88.9) | 9.00 (228.6) | 3.00 (76.2) | 1.50 (38.1) | 9.00 (228.6) | |
| 4 | | 3.50 (88.9) | 11.25 (285.8) | 3.00 (76.2) | 1.50 (38.1) | 12.00 (304.8) | |

Contact Block

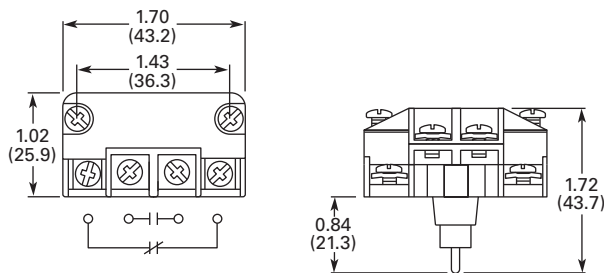

Mounting Adapter

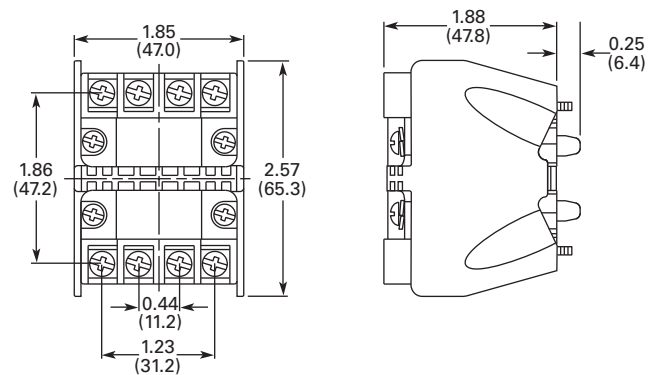

Note

① No conduit entrance holes provided. Drill as required.

Ratings

Summary of NEC Article 500

The NEC Article 500 explains in great detail the requirements for the installation of wiring and electrical equipment in hazardous locations. The purpose of this summary is for general reference only, the National Electrical Code along with other applicable authorities having jurisdiction over the site should be the installer's guidelines when wiring or installing electrical equipment in any hazardous or potentially hazardous location.

Class I, Division 2 Definition

Class I, Division 2 covers hazardous locations where flammable gases, vapors or volatile liquids are handled either in a closed system, or confined within suitable enclosures, or where hazardous concentrations are normally prevented by positive mechanical ventilation. Areas adjacent to Division 1 locations, into which gases might occasionally flow, would also belong to Division 2 (NEC (500.5(b))).

Hazardous Location

Any area where there is the possibility of explosion and fire resulting from the presence of flammable vapors, liquids or gas, or combustible dust or fibers.

Summary of NEC Article 505

The NEC also classifies hazardous locations for flammable gases and vapors into zones under NEC 505. This system is more in line with the European Standards, CENELEC and IEC, with the major difference being that NEC 505 only classifies gases and vapors while CENELEC and IEC also include dusts.

Summary of Classifications

NEC 500-503

| Class | Division | Group |
|-------------|---|---|
| I. Gas | 1. Hazard may exist—May exist in atmosphere under normal operating conditions | A. Acetylene |
| | | B. Hydrogen and manufactured gases containing 30% hydrogen by volume (e.g. butadiene, ethylene oxide, propylene oxide) |
| | 2. Potential hazard—May be present in atmosphere only under abnormal circumstances OR location adjacent to Class I, Division 1 location | C. Petrochemicals (e.g. carbon monoxide, ether, ethylene, hydrogen sulfide, morpholine, cyclopropane) |
| | | D. Petrochemicals (e.g. gasoline, benzene, butane, propane, acetone, ammonia, vinyl chloride) |
| II. Dust | 1. Hazard may exist—May exist in atmosphere under normal operating conditions | A. Acetylene |
| | | B. Hydrogen and manufactured gases containing 30% hydrogen by volume (e.g. butadiene, ethylene oxide, propylene oxide) |
| | | C. Petrochemicals (e.g. carbon monoxide, ether, ethylene, hydrogen sulfide, morpholine, cyclopropane) |
| | 2. Potential hazard—May be present in atmosphere only under abnormal circumstances | D. Petrochemicals (e.g. gasoline, benzene, butane, propane, acetone, ammonia, vinyl chloride) |
| | | E. Conductive and combustible dust (resistivity <math><10^9</math> ohm/cm) (metal dusts) |
| | | F. Carbonaceous dusts (resistivity >math>10^2</math> ohms/cm but $\leq 10^8$ ohms/cm) (e.g. carbon black, coke dust, coal) |
| III. Fibers | 1. Production areas | G. Non-conductive combustible dust (resistivity >math>\geq 10^9</math> ohms/cm) (e.g. grain dust, flour, starch, sugar, plastics) |
| | | F. Carbonaceous dusts (resistivity >math>10^2</math> ohms/cm but $\leq 10^8$ ohms/cm) (e.g. carbon black, coke dust, coal) |
| | 2. Handling and storage areas | G. Non-conductive combustible dust (resistivity >math>\geq 10^9</math> ohms/cm) (e.g. grain dust, flour, starch, sugar, plastics) |
| | | Easily ignitable fibers or flyings |

NEC 505

| Class | Zone | Group |
|--------|--|---|
| I. Gas | 0. Continuously present or present for long periods of time | IIC. Acetylene, hydrogen or equivalent hazard |
| | | IIB. Acetaldehyde, ethylene or equivalent hazard |
| | | IIA. Acetone, ammonia, ethyl alcohol, gasoline, methane, propane or equivalent hazard |
| | 1. Likely to exist under normal operating or maintenance conditions or adjacent to Zone 0 | IIC. Acetylene, hydrogen or equivalent hazard |
| | | IIB. Acetaldehyde, ethylene or equivalent hazard |
| | | IIA. Acetone, ammonia, ethyl alcohol, gasoline, methane, propane or equivalent hazard |
| | 2. Not likely to occur in normal operation and if they do occur will only exist for short period or adjacent to Zone 1 | IIC. Acetylene, hydrogen or equivalent hazard |
| | | IIB. Acetaldehyde, ethylene or equivalent hazard |
| | | IIA. Acetone, ammonia, ethyl alcohol, gasoline, methane, propane or equivalent hazard |

Note

For additional information on grouping of compounds, see NFPA 497M-1991 and NFPA 325-1994.

Summary of Basic Methods Available for Class I, Division 2 Locations

| Method | Features Configuration | Advantages | Disadvantages |
|--|--|---|---|
| Factory sealed contact block | Closed-ended labyrinth contact block with an incendive circuit incapable of external ignition | Higher continuous carrying amperages—up to 10A Direct drive contacts—contacts can be forced open Suitable for use in all enclosures Best suited for motor control applications | May not be suitable for logic level circuits |
| Hermetically sealed block | Reed switch sealed against an external atmosphere | Suitable for low energy level circuits Suitable for use in all enclosures | Lower continuous carrying amperages are not suitable for motor control applications (typically 3A to 5A rated) Contacts cannot be forced open Permanent magnet attracts metallic dust and filings that can reduce the electrical creepage distance between live terminals |
| Explosion proof enclosures (Class I, Division 1 and 2) | Enclosures capable of withstanding an internal explosion while preventing external ignition. Enclosures designed for Class I, Division 1 can safely be used in Class I, Division 2 | Higher level of protection than required for Class I Division 2 | Higher material and installation costs Conduit sealing is still required Time consuming maintenance |

Factory Sealed Contact Blocks

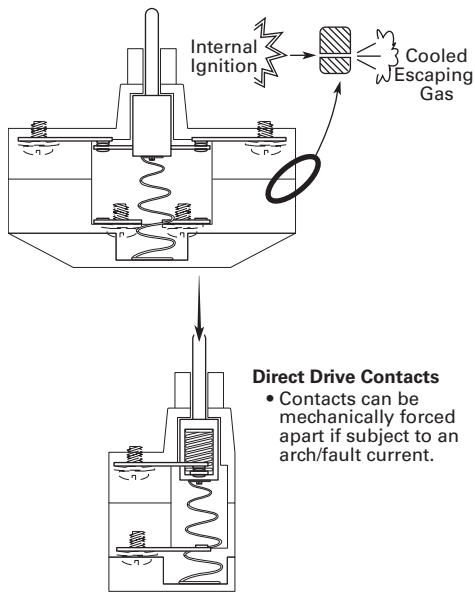

Hermetically Sealed Reed Contact Block

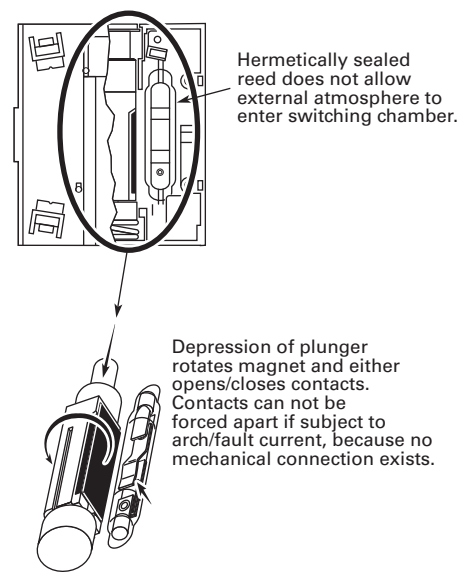

Explosion Proof Enclosure

