

FQ-M VISION SENSOR

Designed for motion tracking



» A new dimension in pick and place

» Fast & precise positioning

» Easy set-up and integration

Smart camera to guide your robot!

The new FQ-M series is a vision sensor designed specifically for Pick & Place applications. It comes with EtherCAT embedded and can be integrated easily into any environment. The FQ-M is compact, fast and includes an incremental encoder input for easy tracking calibration. Omron's Sysmac Studio software is the perfect tool for configuring the FQ-M and is complemented by the TouchFinder console for on-site monitoring.

Key features and benefits

- Made specifically for pick & place applications
- Encoder input for conveyor tracking and calibration
- Shape based object detection
- Smart calibration wizard
- Sysmac Studio software for vision system operation and setting



EtherCAT 

Easy set-up & integration

With intelligent wizards for calibration and communication integration into your machine is easier than ever.

The FQ-M communicates with all devices via EtherCAT, or standard Ethernet. The communication wizard lets you easily configure any robot protocol both as a server or as a client without complex programming.

Fast detection & high stability

The FQ-M can detect up to 32 pieces at once and more than 5000 pieces per minute. The new contour based search algorithm ensures the highest reliability.

„On-the-fly“ tracking

Synchronized control is even easier, because the FQ-M vision sensor has an in-built encoder input for accurate conveyor tracking and easy calibration. The FQ-M is able to output position coordinates and the correlative encoder values and is able to manage the object queue, so that no object's coordinates are duplicated.

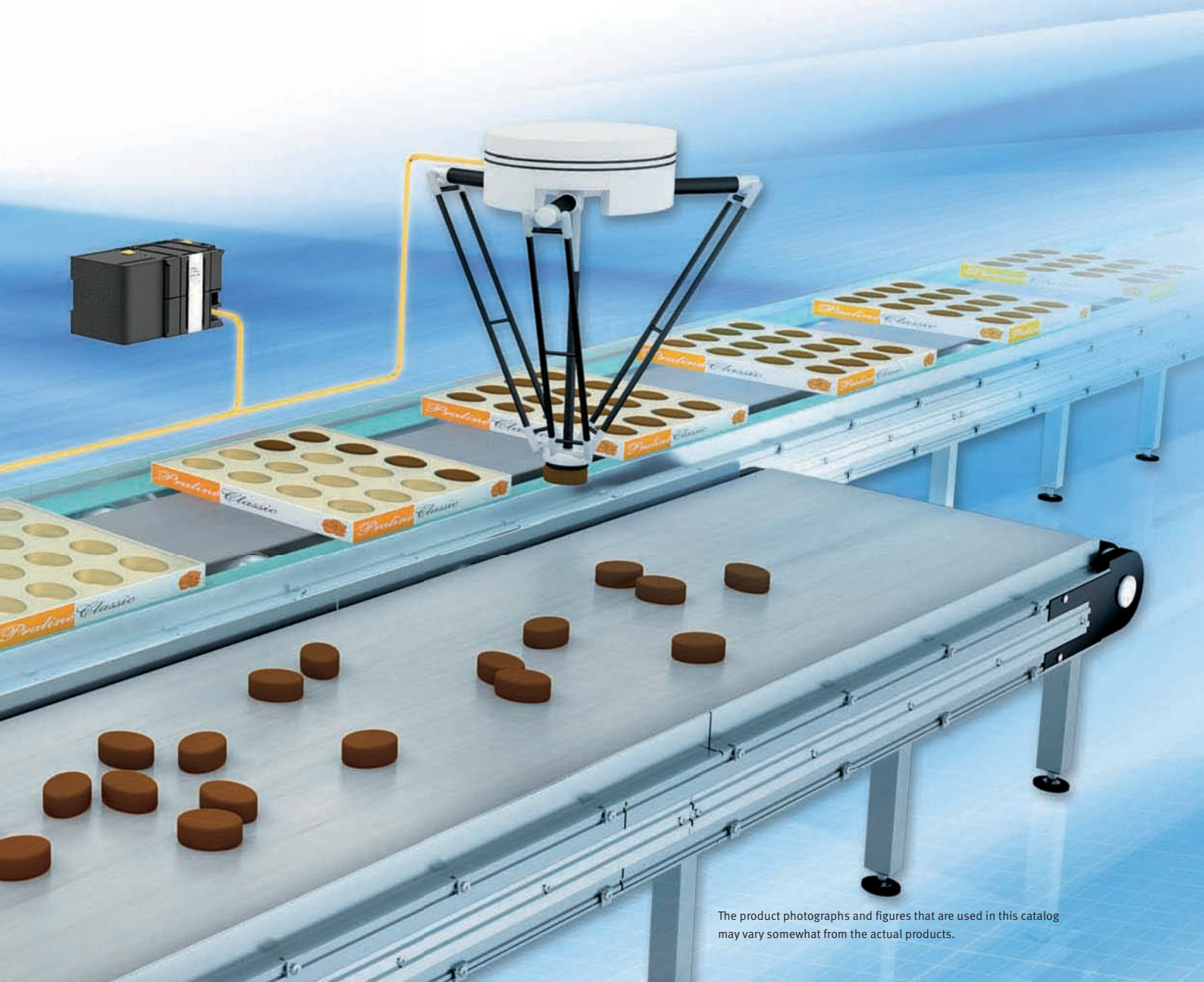

Easy set-up & integration with motion



EtherCAT®

Machine control



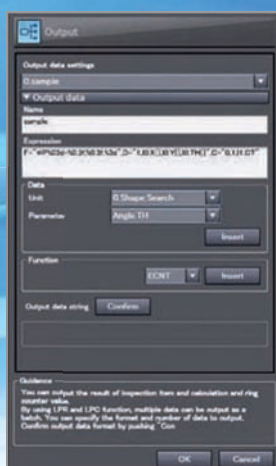

Programmable out put format for your pick & place robot

Configuration as a server or as a client without complex programming.



Ethernet

Sysmac Studio for fast configuration

The Vision Editor of the Sysmac Studio software will help you to program the optimum vision setting. Intuitive and icon driven set-up and configuration.



TouchFinder for monitoring on-site

With the intuitive TouchFinder console – which fits in the palm of your hand – you can access all functions and settings quickly and easily.

Fast detection and high stability

The new contour based search algorithm offers unique performance for pick & place applications. Changing lighting conditions, reflection, object inclination or partially hidden objects are no longer a problem. The FQ-M delivers a stable result even at high speed, no matter how many objects have to be detected at the same time.

Best in class performance

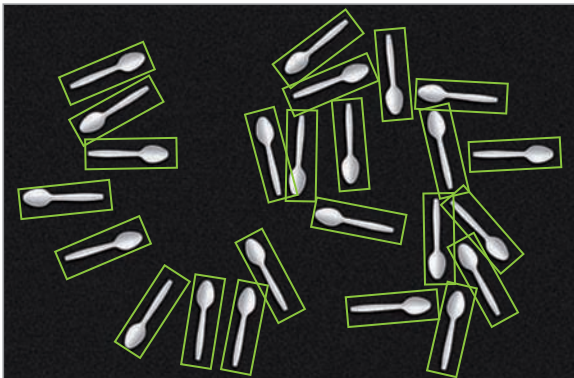

High-speed processing

5000 pcs/min with 360° detection.

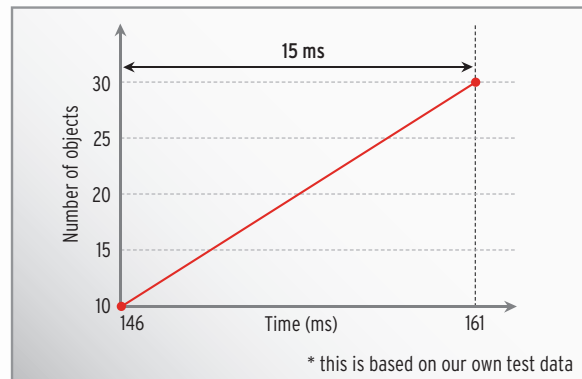

Only 15 ms time difference, detecting 10 objects or 30 objects at once.

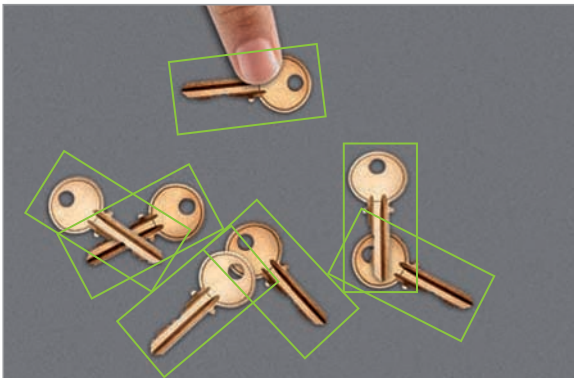

Stable and reliable detection, even if objects are overlapped or partially hidden.

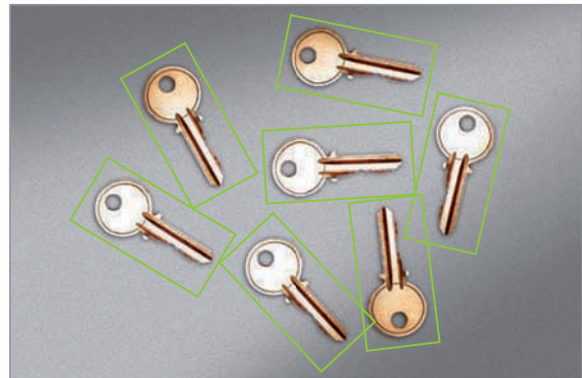

Changing light conditions have no influence on the position accuracy.

Encoder input for simplified calibration & tracking

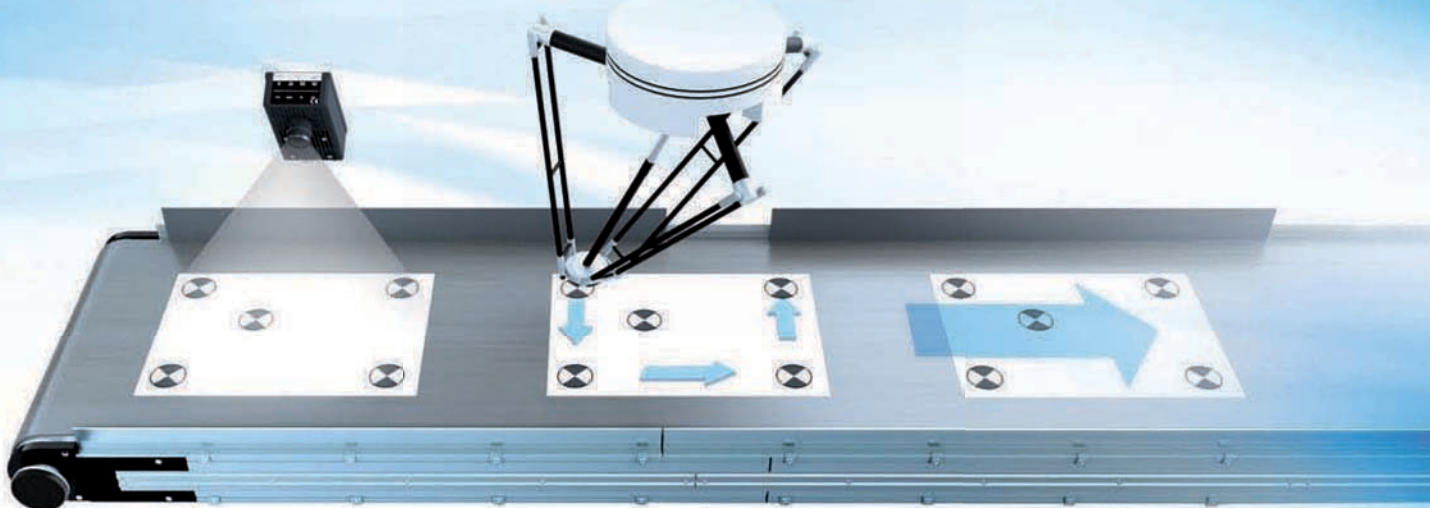

Step 1 - camera

Camera detects all calibration marks.

Step 2 - robot

Robot moves to the calibration marks. The offset to the camera is registered through the encoder value.

Step 3 - system

Camera, conveyor, robot and encoder are automatically aligned.

Panorama view - Parameter setting for ideal object detection

A panoramic view can be created from 3 different images, allowing easy parameter optimisation.

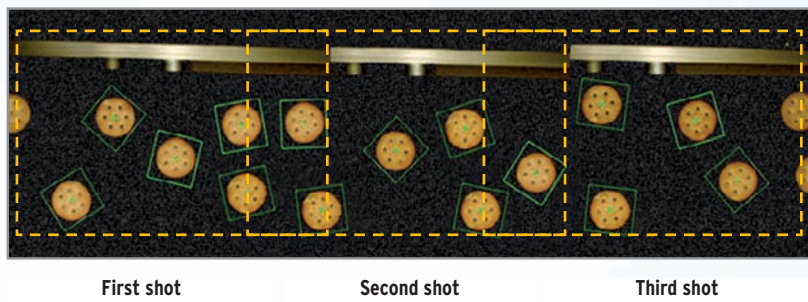

Objects that overlap within more than one field of view are segregated and only inserted in the picking queue once.

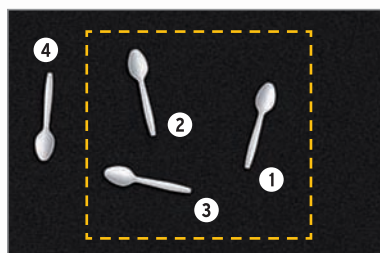

First shot

The position and orientation of objects 1, 2 and 3 is detected and added to the picking queue.

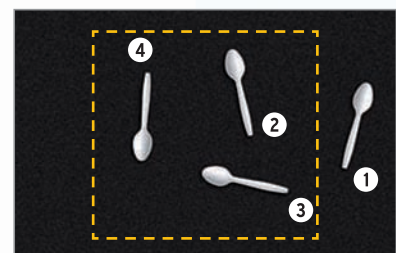

Next shot

Object 2, 3 and 4 are detected, but only the data of object 4 is evaluated. Position and orientation of objects 2 and 3 is ignored because they were already added to the queue with the shot before.

Vision Sensor FQ-M-Series

Designed for motion tracking

- Connectivity with EtherCAT/Ethernet
- Up to 5000 pieces per minute with 360 degree rotation*
- Vision sensor with encoder input for tracking function
- Calibration function of the complete system
- Flexible data output depending on the output devices

* The processing speed depends on setting conditions.



System configuration

EtherCAT connections

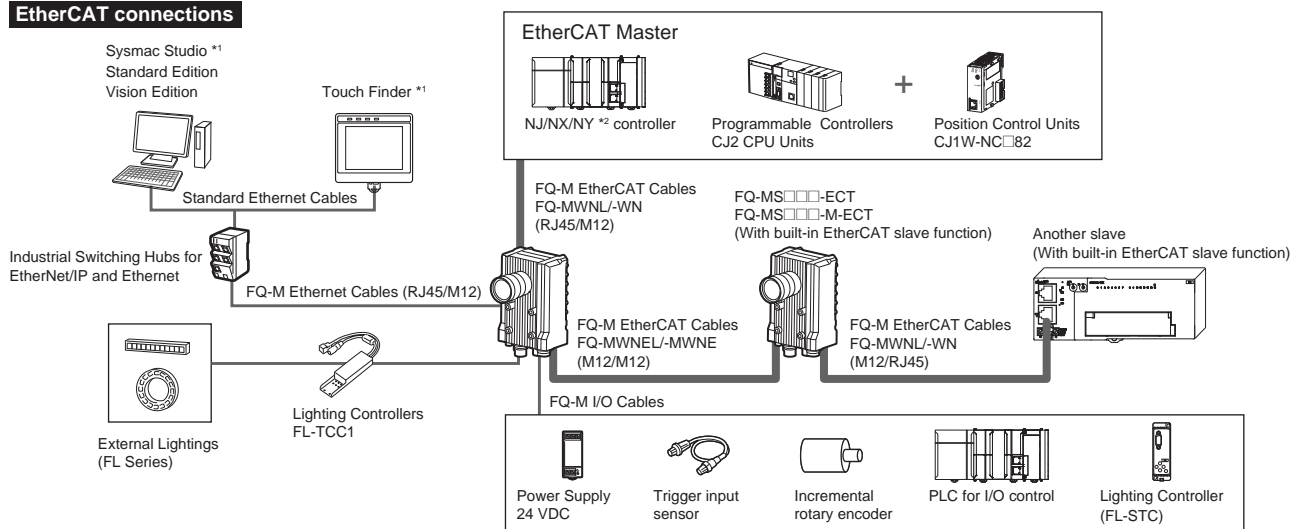

*1. Sysmac Studio and Touch Finder can not be used together. When both are connected, Sysmac Studio will have a priority.

When you make NJ/NX/NY controller settings with the Sysmac Studio Standard Edition, connect a computer and the controller via a USB connection or an Ethernet network.

*2. Industrial PC Platform NY-series IPC Machine Controller only.

No-protocol Ethernet and PLC Link Connections

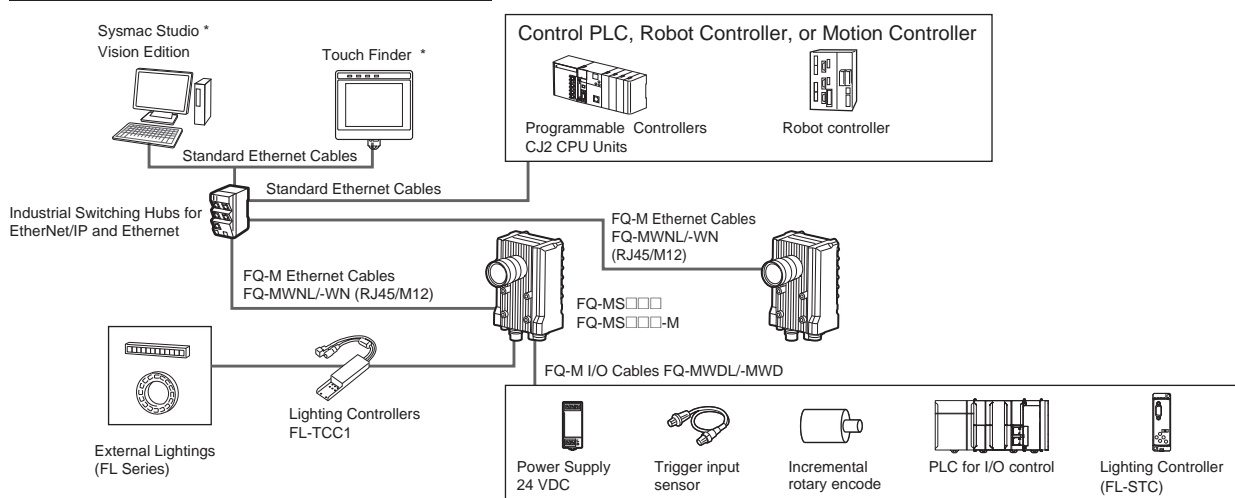

* Sysmac Studio and Touch Finder can not be used together.

When both are connected, Sysmac Studio will have a priority.

Note: 1. EtherCAT and Ethernet (PLC Link) can not be used simultaneously.

2. It is not possible to configure and adjust the FQ-M via an NJ/NX/NY controller, when they are connected via an EtherCAT network. For configuration and adjustment of FQ-M, connect the FQ-M and a computer or a Touch Finder via an Ethernet network.

Sysmac is a trademark or registered trademark of OMRON Corporation in Japan and other countries for OMRON factory automation products.

Windows is registered trademarks of Microsoft Corporation in the USA and other countries.

EtherCAT® is registered trademark and patented technology, licensed by Beckhoff Automation GmbH, Germany.

Other company names and product names in this document are the trademarks or registered trademarks of their respective companies.

FQ-M-Series

Ordering Information

Sensors

Appearance	Type		Model
	Color	NPN	FQ-MS120
		PNP	FQ-MS125
	Monochrome	NPN	FQ-MS120-M
		PNP	FQ-MS125-M
	Color	NPN	FQ-MS120-ECT
		PNP	FQ-MS125-ECT
	Monochrome	NPN	FQ-MS120-M-ECT
		PNP	FQ-MS125-M-ECT

Automation Software Sysmac Studio

Please purchase a DVD and required number of licenses the first time you purchase the Sysmac Studio. DVDs and licenses are available individually. Each model of licenses does not include any DVD.

Product name	Specifications	Number of licenses	Media	Model	Standards
		---	Sysmac Studio (32bit) DVD *3		
Sysmac Studio Standard Edition Ver.1.□□ *2	The Sysmac Studio is the software that provides an integrated environment for setting, programming, debugging and maintenance of machine automation controllers including the NJ/NX-series CPU Units, NY-series Industrial PC, EtherCAT Slave, and the HMI. Sysmac Studio runs on the following OS. Windows 7 (32-bit/64-bit version)/ Windows 8 (32-bit/64-bit version)/ Windows 8.1 (32-bit/64-bit version)/ Windows 10 (32-bit/64-bit version)/ Windows 11 (64-bit version) This software provides functions of the Vision Edition. Refer to OMRON website for details such as supported models and functions.	1 license *1	---	SYSMAC-SE201L	---
		1 license	---	SYSMAC-VE001L	---

*1 Multi licenses are available for the Sysmac Studio (3, 10, 30, or 50 licenses).





*2 The FQ-M series is supported by Sysmac Studio version 1.01 or higher.



*3 The same media is used for both the Standard Edition and the Vision Edition.

Touch Finder





Appearance	Type	Model
	DC power supply	FQ-MD30

Bend resistant Cables for FQ-M Series

Cable Type	Appearance	Type	Cable length	Model
EtherCAT and Ethernet cable (M12/RJ45)		Angle: M12/ Straight: RJ45	5 m	FQ-MWNL005
			10 m	FQ-MWNL010
		Straight type	5m	FQ-WN005
			10 m	FQ-WN010
			20 m	FQ-WN020
	EtherCAT cable (M12/M12)		Angle type	5 m
10 m				FQ-MWNE010
		Straight type	5m	FQ-MWNE005
			10 m	FQ-MWNE010

Cable Type	Appearance	Type	Cable length	Model
I/O Cables		Angle type	5 m	FQ-MWDL005
			10 m	FQ-MWDL010
		Straight type	5 m	FQ-MWD005
			10 m	FQ-MWD010

Accessories

Appearance	Type		Model
	For Touch Finder	Panel Mounting Adapter	FQ-XPM
		AC Adapter (for models for DC/AC/Battery)	FQ-AC□ *
		Touch Pen (enclosed with Touch Finder)	FQ-XT
		SD Card	2GB 4GB

* AC Adapters for Touch Finder with DC/AC/Battery Power Supply. Select the model for the country in which the Touch Finder will be used.



Plug type	Voltage	Certified standards	Model
A	125 V max.	PSE	FQ-AC1
		UL/CSA	FQ-AC2
	250 V max.	CCC mark	FQ-AC3
C	250 V max.	---	FQ-AC4

Industrial Switching Hubs for EtherNet/IP and Ethernet

Appearance	Number of ports	Current consumption	Model
	5	0.07 A	W4S1-05D

Note: Industrial switching hubs are cannot be used for EtherCAT.

EtherCAT junction slaves

Appearance	Number of ports	Power supply voltage	Current consumption	Model
	3	20.4 to 28.8 VDC (24 VDC -15 to 20%)	0.08 A	GX-JC03
	6		0.17 A	GX-JC06

Note: 1. Please do not connect EtherCAT junction slave with OMRON position control unit, Model CJ1W-NC□81/□82.
2. EtherCAT junction slaves cannot be used for EtherNet/IP and Ethernet.

Cameras peripheral devices

Type	Model	Remarks
CCTV Lenses	3Z4S-LE Series	Refer to Vision Accessory Catalog(Q198)
External Lightings	FLV Series	
	FL Series	

FQ-M-Series

Specifications

Sensors

Item		Type	EtherCAT communication function not provided		EtherCAT communication function provided	
			Color	Monochrome	Color	Monochrome
Model	NPN		FQ-MS120	FQ-MS120-M	FQ-MS120-ECT	FQ-MS120-M-ECT
	PNP		FQ-MS125	FQ-MS125-M	FQ-MS125-ECT	FQ-MS125-M-ECT
Field of vision, Installation distance			Selecting a lens according to the field of vision and installation distance. Refer to the "Optical Chart" page.			
Main functions	Inspection items	Shape search, Search, Labeling, Edge position				
	Number of simultaneous inspections	32				
	Number of registered scenes	32 *1				
Image input	Image processing method	Real color	Monochrome	Real color	Monochrome	
	Image elements	1/3-inch color CMOS	1/3-inch monochrome CMOS	1/3-inch color CMOS	1/3-inch monochrome CMOS	
	Image filter	High dynamic range (HDR) and white balance	High dynamic range (HDR)	High dynamic range (HDR) and white balance	High dynamic range (HDR)	
	Shutter	Electronic shutter; select shutter speeds from 1/10 to 1/30000 (sec)				
	Processing resolution	752 (H) × 480 (V)				
	Pixel size	6.0 (μm) × 6.0 (μm)				
	Frame rate (image read time)	60fps (16.7ms)				
External Lightings	Connecting method	Connection via a strobe light controller				
	Connectable lighting	FL series				
Data logging	Measurement data	In Sensor: Max. 32000 items *2				
	Images	In Sensor: 20 images *2				
Measurement trigger			I/O trigger, Encoder trigger, Communications trigger (Ethernet No-protocol, PLC Link, or EtherCAT)			
I/O specifications	Input signals	9 signals • Single measurement input (TRIG) • Error clear input (IN0) • Encoder counter reset input (IN1) • Encoder input (A±, B±, Z±) *4				
	Output signals	5 signals *3 • OUT0 Overall judgement output (OR) • OUT1 Control output (BUSY) • OUT2 Error output (ERROR) • OUT3 (Shutter output: SHTOUT) • OUT4 (Strobe trigger output: STGOUT)				
	Ethernet specifications	100BASE-TX/10BASE-TX				
	EtherCAT specifications	---		Dedicated protocol for EtherCAT 100BASE-TX		
	Connection method	Special connector cables • Power supply and I/O: 1 special connector I/O cable • Touch Finder, Computer and Ethernet: 1 Ethernet cable • EtherCAT: 2 EtherCAT cable				
LED display		• OR: Judgment result indicator • ERR: Error indicator • BUSY: BUSY indicator • ETN: Ethernet communications indicator				
	EtherCAT display	---		• L/A IN (Link/Activity IN) × 1 • L/A OUT (Link/Activity OUT) × 1 • RUN × 1 • ERR × 1		
Ratings	Power supply voltage	21.6 to 26.4 VDC (including ripple)				
	Insulation resistance	Between all lead wires and case: 0.5 MΩ (at 250 V)				
	Current consumption	450mA max. (When the FL-series Strobe controller and lighting are used.) 250mA max. (When external lighting is not used.)				
Environmental immunity	Ambient temperature range	Operating: 0 to 50 °C, Storage: -20 to 65 °C (with no icing or condensation)				
	Ambient humidity range	Operating and storage: 35% to 85% (with no condensation)				
	Ambient atmosphere	No corrosive gas				
	Vibration resistance (destruction)	10 to 150 Hz, single amplitude: 0.35 mm, X/Y/Z directions, 8 min each, 10 times				
	Shock resistance (destruction)	150 m/s ² 3 times each in 6 direction (up, down, right, left, forward, and backward)				
	Degree of protection	IEC60529 IP40				
Materials			Case: aluminium die casting, Rear cover: aluminium plate			
Weight			Approx. 390 g (Sensor only)		Approx. 480 g (Sensor only)	
Accessories			Instruction Manual			

*1 The maximum number of resisterable scenes depends on settings due to restrictions on memory.

*2 If a Touch Finder is used, results can be saved up to the capacity of an SD card.

*3 The five output signals can be allocated for the judgements of individual inspection items.

*4 Encoder input specifications
Pulse input Specifications (When an open collector type encoder is used.)

Item	Specification		
Input voltage	24 VDC ±10%	12 VDC ±10%	5 VDC ±5%
Input current	4.8 mA (at 24 VDC, typical value)	2.4 mA (at 12 VDC, typical value)	1.0 mA (at 5 VDC, typical value)
NPN	ON voltage *1	4.8 V max.	2.4 V max.
	OFF voltage *2	19.2 V min.	9.6 V min.
PNP	ON voltage *1	19.2 V min.	9.6 V min.
	OFF voltage *2	4.8 V max.	2.4 V max.
Maximum response frequency *3	50 kHz (I/O cable: when the FQ-MWD005 or FQ-MWDL005 cables is used.) 20 kHz (I/O cable: when the FQ-MWD010 or FQ-MWDL010 cables is used.)		
Input impedance	5.1 kΩ		

- *1 ON voltage: Voltage to change from OFF to ON state. The ON voltage is the difference of voltages between the GND terminal of the encoder power terminals and each input terminal.
- *2 OFF voltage: Voltage to change from ON to OFF state. The ON voltage is the difference of voltages between the GND terminal of the encoder power terminals and each input terminal.
- *3 Select maximum response frequency depending on length of the encoder cable and response frequency of the encoder.

Pulse input Specifications (When a line-driver output type encoder is used.)

Item	Specification
Input voltage	EIA standard RS-422-A line driver level
Input impedance *1	120 Ω ±5%
Differential input voltage	0.2 V min.
Hysteresis voltage	50 mV
Maximum response frequency *2	200 kHz (I/O cable: when the FQ-MWD005, FQ-MWDL005, FQ-MWD010, or FQ-MWDL010 cables is used.)

- *1 When terminating resistance function is used.
- *2 Select maximum response frequency depending on length of the encoder cable and response frequency of the encoder.

Touch Finder

Item	Type Model	Model with DC power supply	
		FQ-MD30	
Number of connectable Sensors		2 max.	
Main functions	Types of measurement displays		Last result display, Last NG display, trend monitor, histograms
	Types of display images		Through, frozen, zoom-in, and zoom-out images
	Data logging		Measurement results, measured images
	Menu language		English, Japanese
Indications	LCD	Display device	3.5-inch TFT color LCD
		Pixels	320 × 240
		Display colors	16,777,216
	Backlight	Life expectancy *1	50,000 hours at 25 °C
		Brightness adjustment	Provided
		Screen saver	Provided
	Indicators	Power indicator (color: green)	POWER
Error indicator (color: red)		ERROR	
SD card access indicator (color: yellow)		SD ACCESS	
Charge indicator (color: orange)		---	
Operation interface	Touch screen	Method	Resistance film
		Life expectancy *2	1,000,000 operations
External interface	Ethernet	100 BASE-TX/10 BASE-T	
	SD card	Omron SD card (Model: HMC-SD291/SD491) or a SDHC card of Class4 or higher rating is recommended.	
Ratings	Power supply voltage	DC power connection	20.4 to 26.4 VDC (including ripple)
		AC adapter connection	---
		Battery connection	---
	Continuous operation on Battery *3		---
	Current consumption		DC power connection: 0.2 A
Insulation resistance		Between all lead wires and case: 0.5 MΩ (at 250 V)	
Environmental immunity	Ambient temperature range		Operating: 0 to 50 °C Storage: -25 to 65 °C (with no icing or condensation)
	Ambient humidity range		Operating and storage: 35% to 85% (with no condensation)
Environmental immunity	Ambient atmosphere		No corrosive gas
	Vibration resistance (destruction)		10 to 150 Hz, single amplitude: 0.35 mm, X/Y/Z directions 8 min each, 10 times
	Shock resistance (destruction)		150 m/s ² 3 times each in 6 direction (up, down, right, left, forward, and backward)
	Degree of protection		IEC 60529 IP20

FQ-M-Series

Item	Type Model	Model with DC power supply
		FQ-MD30
Dimensions		95 × 85 × 33 mm
Materials		Case: ABS
Weight		Approx. 270 g (without Battery and hand strap)
Accessories		Touch Pen (FQ-XT), Instruction Manual

*1 This is a guideline for the time required for the brightness to diminish to half the initial brightness at room temperature and humidity. No guarantee is implied. The life of the backlight is greatly affected by the ambient temperature and humidity. It will be shorter at lower or higher temperatures.

*2 This value is only a guideline. No guarantee is implied. The value will be affected by operating conditions.

*3 This value is only a guideline. No guarantee is implied. The value will be affected by the operating environment and operating conditions.

Sysmac Studio

Item	Requirement
Operating system (OS) *1, *2 Japanese or English system	Windows 7 (32-bit/64-bit version)/ Windows 8.1 (32-bit/64-bit version)/ Windows 10 (32-bit/64-bit version)/ Windows 11 (64-bit version)
CPU	Windows computers with Celeron 540 (1.8 GHz) or faster CPU. Core i5 M520 (2.4 GHz) or equivalent or faster recommended
Main memory	2GB min.
Hard disk	At least 1.6 GB of available space *3
Display	XGA 1024 × 768, 1600 million colors. WXGA 1280 × 800 min. recommended
Disk drive	DVD-ROM drive
Communications ports	USB port corresponded to USB 2.0, or Ethernet port

*1 Sysmac Studio Operating System Precaution:

System requirements and hard disk space may vary with the system environment.

*2 The following restrictions apply when Sysmac Studio is used with Microsoft Windows 7 or Windows 8.

Some Help files cannot be accessed.

The Help files can be accessed if the Help program distributed by Microsoft for Windows (WinHlp32.exe) is installed. Refer to the Microsoft homepage listed below or contact Microsoft for details on installing the file. (The download page is automatically displayed if the Help files are opened while the user is connected to the Internet.)

<http://support.microsoft.com/kb/917607/en-us>

*3 To use the file logging function, additional memory area to save the logging data is necessary.

FQ-M Series EtherCAT Communications Specifications

Item	Specifications
Communications standard	IEC 61158 Type12
Physical layer	100BASE-TX (IEEE802.3)
Connector	M12 × 2 E-CAT IN : EtherCAT (IN) E-CAT OUT : EtherCAT (OUT)
Communications media	Use the cables for FQ-MWN□□, or FQ-WN□□ series.
Communications distance	Use the communication cable within the length of FQ-MWN□□ or FQ-WN□□ series cables.
Process data	Variable PDO Mapping
Mailbox (CoE)	Emergency messages, SDO requests, SDO responses, and SDO information
Distributed clock	Synchronization with DC mode 1
LED display	L/A IN (Link/Activity IN) × 1, L/A OUT (Link/Activity OUT) × 1, RUN × 1, ERR × 1

Version Information

FQ-M Series and Programming Devices

FQ-M Series	Required Programming Device	
	Sysmac Studio Standard Edition/Vision Edition	
	Ver.1.00	Ver.1.01 or higher
FQ-MS□□□(-M) FQ-MS□□□(-M)-ECT	Not supported	Supported

Components and Functions

Sensor

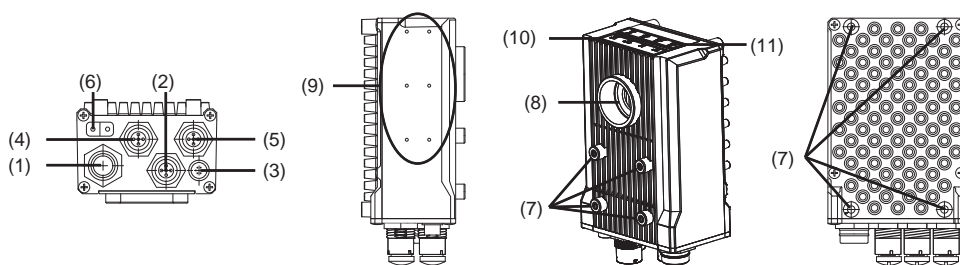

No.	Name	Description
(1)	I/O Cable connector	An I/O Cable is used to connect the Sensor to the power supply and external I/O.
(2)	Ethernet connector	An Ethernet cable is used to connect the Sensor to external devices such as PLCs, the Touch Finder, or computers.
(3)	Lighting connector	Connect an external lighting (strobe controller).
(4)	EtherCAT connector (IN)*	Connect an EtherCAT compatible device.
(5)	EtherCAT connector (OUT)*	Connect an EtherCAT compatible device.
(6)	Node address switch *	Set the node address for EtherCAT communications.
(7)	Installation holes	Holes to install and secure the camera.
(8)	C-mount lens connection part	Install the C-mount lens in this part. Determine the field of view depending on the measurement target and select a suitable CCTV lens (C-mounting lens).

No.	Name	Description	
(9)	Strobe controller connection holes	Install the strobe controller in this part. FL-TCC1 can be mounted.	
(10)	Measurement process Operation indicators	OR	Lit in orange while OR signal is ON.
		ETN	Lit in orange while in Ethernet communications.
		ERROR	Lit in red when an error occurs.
		BUSY	Lit in green while the sensor is processing.
(11)	EtherCAT Operation indicators	L/A IN	Lit in green when Link with EtherCAT device is established and flickers in green when communicating (data IN).
		L/A OUT	Lit in green when Link with EtherCAT device is established and flickers in green when communicating (data OUT).
		ECAT RUN	Lit in green when EtherCAT communication is available.
		ECAT ERROR	Lit in red when an EtherCAT communications error occurs.

* FQ-MS□□□-ECT and FQ-MS□□□-M-ECT only.

Touch Finder

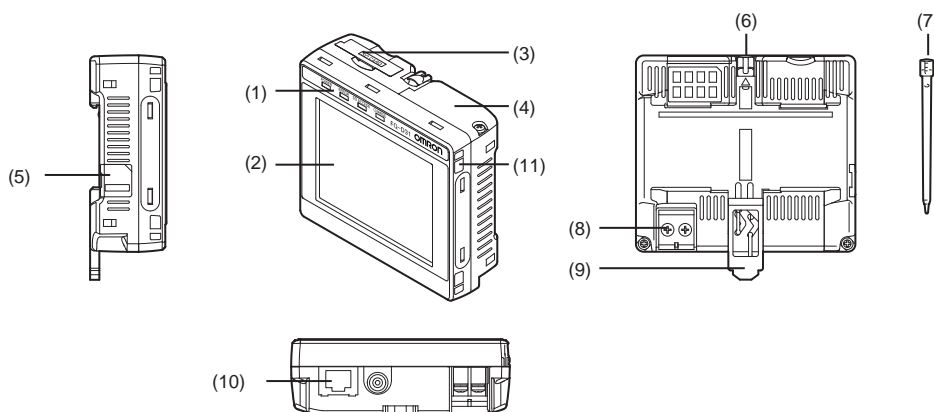

No.	Name	Description	
(1)	Operation indicators	POWER	Lights green when the Touch Finder is turned ON.
		ERROR	Lights red when an error occurs.
		SD ACCESS	Lights yellow when an SD card is inserted. Flashes yellow when the SD card is being accessed.
		CHARGE *	Lights orange when the Battery is charging.
(2)	LCD/touch panel	Displays the setting menu, measurement results, and images input by the camera.	
(3)	SD card slot	An SD card can be inserted.	
(4)	Battery cover *	The Battery is inserted behind this cover. Remove the cover when mounting or removing the Battery.	
(5)	Power supply switch	The Battery is inserted behind this cover. Remove the cover when mounting or removing the Battery.	

No.	Name	Description
(6)	Touch pen holder	The touch pen can be stored here when it is not being used.
(7)	Touch pen	Used to operate the touch panel.
(8)	DC power supply connector	Used to connect a DC power supply.
(9)	Slider	Used to mount the Touch Finder to a DIN Track.
(10)	Ethernet port	Used when connecting the Touch Finder to the Sensor with an Ethernet cable. Insert the connector until it locks in place.
(11)	Strap holder	This is a holder for attaching the strap.

FQ-M-Series

Dimensions

(Unit: mm)

Sensor

FQ-MS120/MS120-M
FQ-MS125/MS125-M

MOUNTING SCREW HOLES (1)

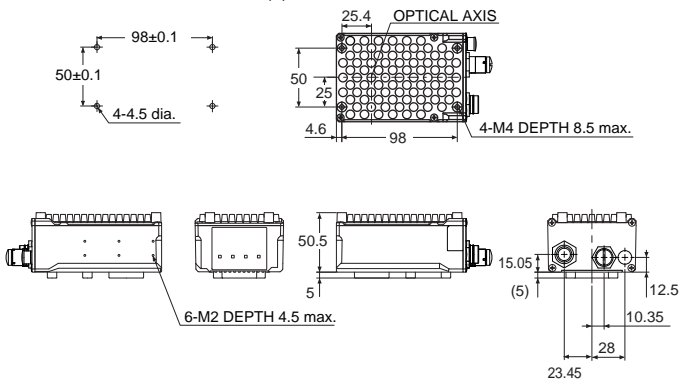

MOUNTING SCREW HOLES (2)

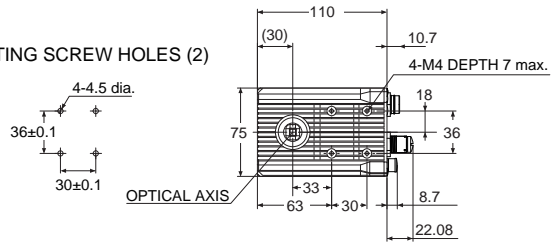

FQ-MS120-ECT/MS120-M-ECT
FQ-MS125-ECT/MS125-M-ECT

MOUNTING SCREW HOLES (1)

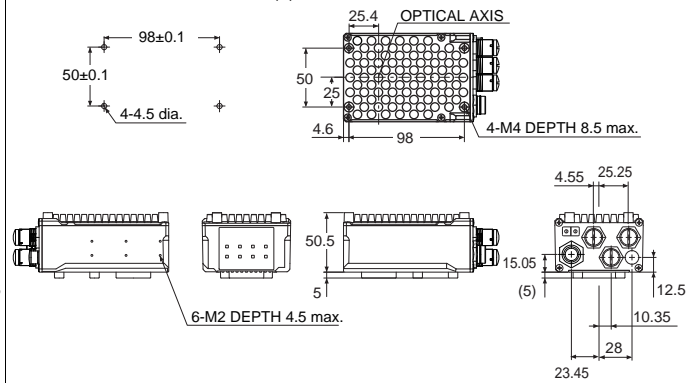

MOUNTING SCREW HOLES (2)

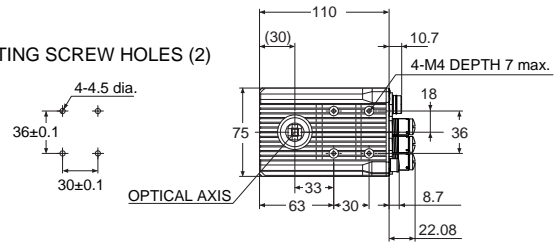

Touch Finder

FQ-MD30

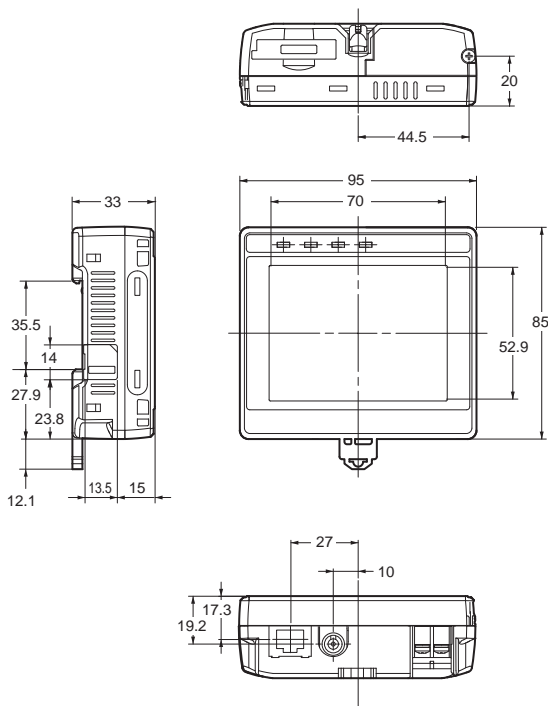

Panel Mounting Adapter *

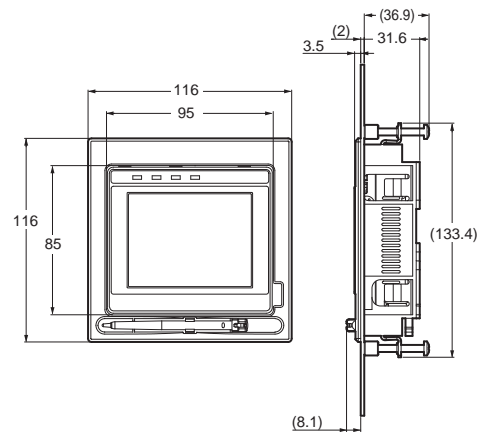

Panel Cutout Dimensions

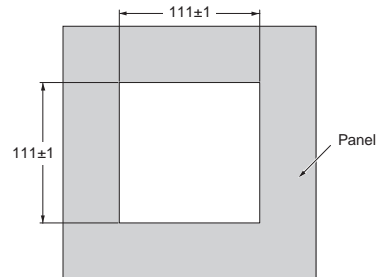

* The dimension of the panel mounting adapter does not include that of a FQ-MD□□.

Cables

- For EtherCAT and Ethernet cable
Angle: M12/ Straight: RJ45
FQ-MWNL005/010

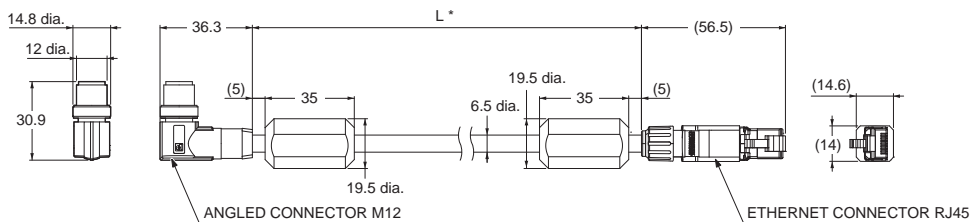

* Cable is available in 5 m/10 m.

- Straight type (M12/RJ45)
FQ-WN005/010

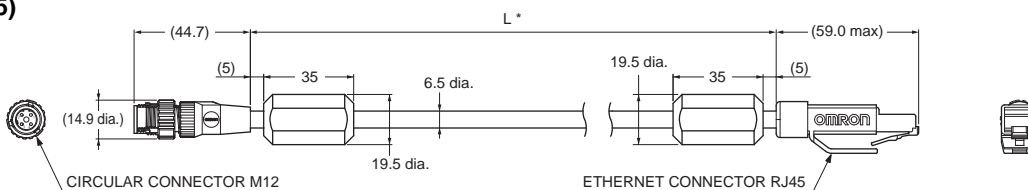

* Cable is available in 5 m/10 m.

- For EtherCAT cable
Angle type (M12/M12)
FQ-MWNE005/010

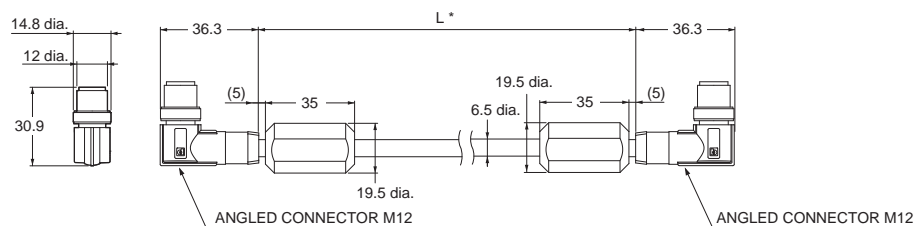

* Cable is available in 5 m/10 m.

- Straight type (M12/M12)
FQ-MWNE005/010

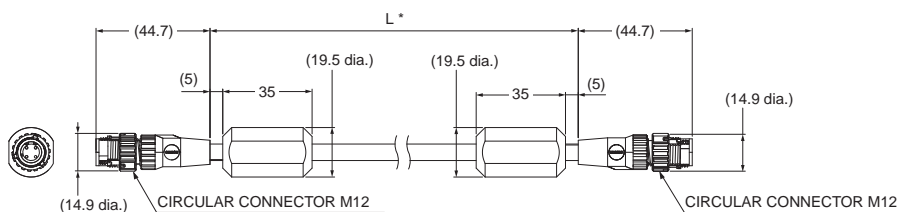

* Cable is available in 5 m/10 m.

- I/O Cables
Angle type
FQ-MWDL005/010

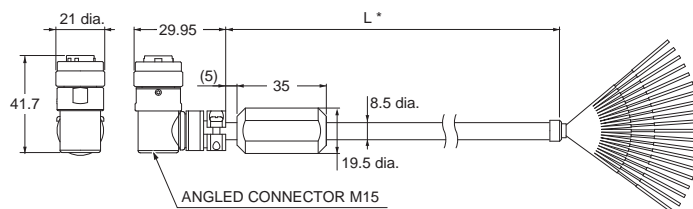

* Cable is available in 5 m/10 m.

- Straight type
FQ-MWD005/010

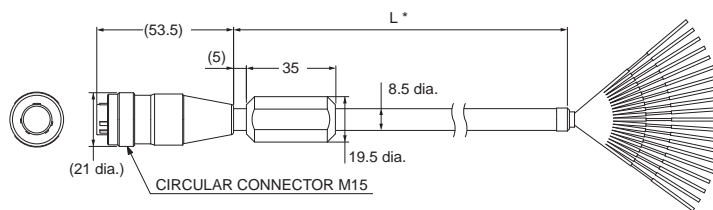

* Cable is available in 5 m/10 m.

FQ-M-Series

Optical Chart

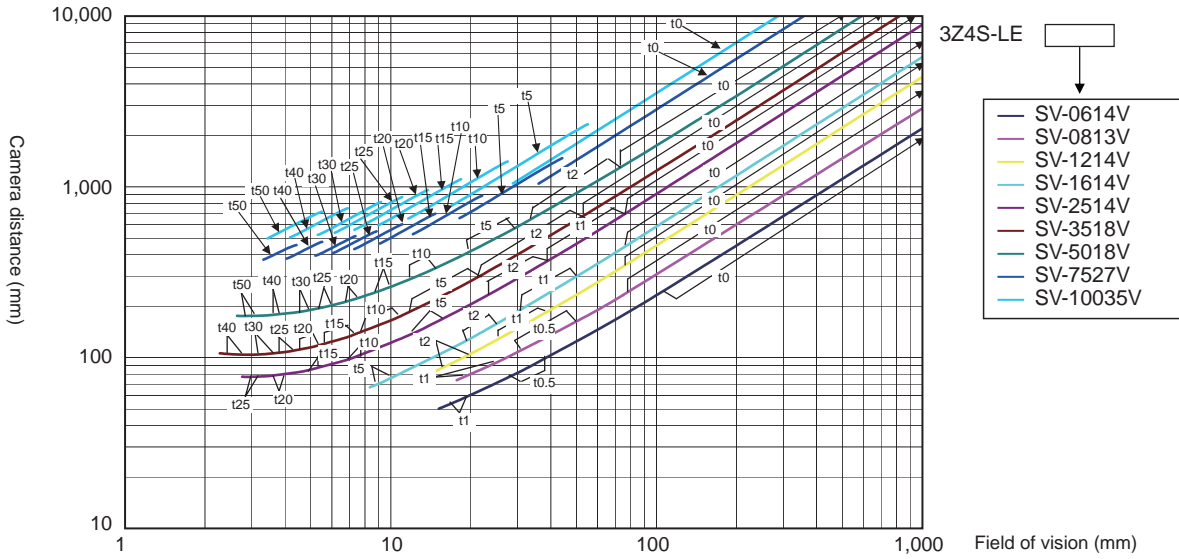

Meaning of Optical Chart

The X axis of the optical chart shows the field of vision (mm) *1,
and the Y axis of the optical chart shows the camera installation distance (mm).*2

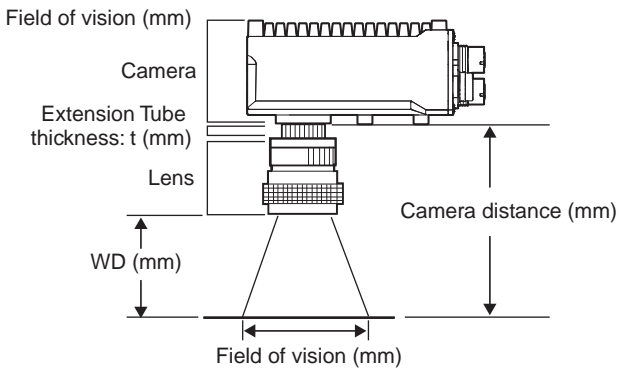

*1. The lengths of the fields of vision given in the optical charts are the lengths of the Y axis.
*2. The vertical axis represents WD for small cameras.

Related Manuals

Cat. No.	Model number	Manual
Z314	FQ-MS□□□(-M) FQ-MS□□□(-M)-ECT	Specialized Vision Sensor for Positioning FQ-M-Series User's Manual
W504	SYSMAC-□□□□□□	Sysmac Studio OPERATION MANUAL

READ AND UNDERSTAND THIS DOCUMENT

Please read and understand this document before using the products. Please consult your OMRON representative if you have any questions or comments.

WARRANTY

OMRON's exclusive warranty is that the products are free from defects in materials and workmanship for a period of one year (or other period if specified) from date of sale by OMRON.

OMRON MAKES NO WARRANTY OR REPRESENTATION, EXPRESS OR IMPLIED, REGARDING NON-INFRINGEMENT, MERCHANTABILITY, OR FITNESS FOR PARTICULAR PURPOSE OF THE PRODUCTS. ANY BUYER OR USER ACKNOWLEDGES THAT THE BUYER OR USER ALONE HAS DETERMINED THAT THE PRODUCTS WILL SUITABLY MEET THE REQUIREMENTS OF THEIR INTENDED USE. OMRON DISCLAIMS ALL OTHER WARRANTIES, EXPRESS OR IMPLIED.

LIMITATIONS OF LIABILITY

OMRON SHALL NOT BE RESPONSIBLE FOR SPECIAL, INDIRECT, OR CONSEQUENTIAL DAMAGES, LOSS OF PROFITS OR COMMERCIAL LOSS IN ANY WAY CONNECTED WITH THE PRODUCTS, WHETHER SUCH CLAIM IS BASED ON CONTRACT, WARRANTY, NEGLIGENCE, OR STRICT LIABILITY.

In no event shall responsibility of OMRON for any act exceed the individual price of the product on which liability is asserted.

IN NO EVENT SHALL OMRON BE RESPONSIBLE FOR WARRANTY, REPAIR, OR OTHER CLAIMS REGARDING THE PRODUCTS UNLESS OMRON'S ANALYSIS CONFIRMS THAT THE PRODUCTS WERE PROPERLY HANDLED, STORED, INSTALLED, AND MAINTAINED AND NOT SUBJECT TO CONTAMINATION, ABUSE, MISUSE, OR INAPPROPRIATE MODIFICATION OR REPAIR.

SUITABILITY FOR USE

THE PRODUCTS CONTAINED IN THIS DOCUMENT ARE NOT SAFETY RATED. THEY ARE NOT DESIGNED OR RATED FOR ENSURING SAFETY OF PERSONS, AND SHOULD NOT BE RELIED UPON AS A SAFETY COMPONENT OR PROTECTIVE DEVICE FOR SUCH PURPOSES. Please refer to separate catalogs for OMRON's safety rated products.

OMRON shall not be responsible for conformity with any standards, codes, or regulations that apply to the combination of products in the customer's application or use of the product.

At the customer's request, OMRON will provide applicable third party certification documents identifying ratings and limitations of use that apply to the products. This information by itself is not sufficient for a complete determination of the suitability of the products in combination with the end product, machine, system, or other application or use.

The following are some examples of applications for which particular attention must be given. This is not intended to be an exhaustive list of all possible uses of the products, nor is it intended to imply that the uses listed may be suitable for the products:

- Outdoor use, uses involving potential chemical contamination or electrical interference, or conditions or uses not described in this document.
- Nuclear energy control systems, combustion systems, railroad systems, aviation systems, medical equipment, amusement machines, vehicles, safety equipment, and installations subject to separate industry or government regulations.
- Systems, machines, and equipment that could present a risk to life or property.

Please know and observe all prohibitions of use applicable to the products.

NEVER USE THE PRODUCTS FOR AN APPLICATION INVOLVING SERIOUS RISK TO LIFE OR PROPERTY WITHOUT ENSURING THAT THE SYSTEM AS A WHOLE HAS BEEN DESIGNED TO ADDRESS THE RISKS, AND THAT THE OMRON PRODUCT IS PROPERLY RATED AND INSTALLED FOR THE INTENDED USE WITHIN THE OVERALL EQUIPMENT OR SYSTEM.

PERFORMANCE DATA

Performance data given in this document is provided as a guide for the user in determining suitability and does not constitute a warranty. It may represent the result of OMRON's test conditions, and the users must correlate it to actual application requirements. Actual performance is subject to the OMRON Warranty and Limitations of Liability.

CHANGE IN SPECIFICATIONS

Product specifications and accessories may be changed at any time based on improvements and other reasons.

It is our practice to change model numbers when published ratings or features are changed, or when significant construction changes are made. However, some specifications of the product may be changed without any notice. When in doubt, special model numbers may be assigned to fix or establish key specifications for your application on your request. Please consult with your OMRON representative at any time to confirm actual specifications of purchased products.

DIMENSIONS AND WEIGHTS

Dimensions and weights are nominal and are not to be used for manufacturing purposes, even when tolerances are shown.

ERRORS AND OMISSIONS

The information in this document has been carefully checked and is believed to be accurate; however, no responsibility is assumed for clerical, typographical, or proofreading errors, or omissions.

PROGRAMMABLE PRODUCTS

OMRON shall not be responsible for the user's programming of a programmable product, or any consequence thereof.

COPYRIGHT AND COPY PERMISSION

This document shall not be copied for sales or promotions without permission.

This document is protected by copyright and is intended solely for use in conjunction with the product. Please notify us before copying or reproducing this document in any manner, for any other purpose. If copying or transmitting this document to another, please copy or transmit it in its entirety.

Note: Do not use this document to operate the Unit.

OMRON Corporation Industrial Automation Company

Kyoto, JAPAN

Contact : www.ia.omron.com

Regional Headquarters

OMRON EUROPE B.V.

Wegalaan 67-69, 2132 JD Hoofddorp
The Netherlands
Tel: (31) 2356-81-300 Fax: (31) 2356-81-388

OMRON ELECTRONICS LLC

2895 Greenspoint Parkway, Suite 200
Hoffman Estates, IL 60169 U.S.A.
Tel: (1) 847-843-7900 Fax: (1) 847-843-7787

OMRON ASIA PACIFIC PTE. LTD.

438B Alexandra Road, #08-01/02 Alexandra
Technopark, Singapore 119968
Tel: (65) 6835-3011 Fax: (65) 6835-2711

OMRON (CHINA) CO., LTD.

Room 2211, Bank of China Tower,
200 Yin Cheng Zhong Road,
PuDong New Area, Shanghai, 200120, China
Tel: (86) 21-5037-2222 Fax: (86) 21-5037-2200

Authorized Distributor:

©OMRON Corporation 2011-2023 All Rights Reserved.
In the interest of product improvement,
specifications are subject to change without notice.

CSM_11_9

Cat. No. Q183-E1-07 0223 (0911)