

Electro-pneumatic Regulator Electronic Vacuum Regulator Series *ITV*

Electro-pneumatic Regulator

Electronic Vacuum Regulator

Series	Model	Regulating pressure range	Port size	Page
Series ITV0000 With a simplified high-density circuit board design, an extremely compact size has been achieved. 	ITV001□	0.001 to 0.1 MPa	Built-in One-touch fitting Metric size: ø4 Inch size: ø5/32	14-8-2
	ITV003□	0.001 to 0.5 MPa		
	ITV005□	0.001 to 0.9 MPa		
	ITV009□	-1 to -100 kPa		
Series ITV1000 Controls air pressure steplessly in proportion to an electric signal. 	ITV101□	0.005 to 0.1 MPa	1/8, 1/4	14-8-14
	ITV103□	0.005 to 0.5 MPa		
	ITV105□	0.005 to 0.9 MPa		
Series ITV2000 Controls air pressure steplessly in proportion to an electric signal. 	ITV201□	0.005 to 0.1 MPa	1/4, 3/8	14-8-14
	ITV203□	0.005 to 0.5 MPa		
	ITV205□	0.005 to 0.9 MPa		
Series ITV3000 Controls air pressure steplessly in proportion to an electric signal. 	ITV301□	0.005 to 0.1 MPa	1/4, 3/8, 1/2	14-8-14
	ITV303□	0.005 to 0.5 MPa		
	ITV305□	0.005 to 0.9 MPa		
Series ITV209□ Controls vacuum pressure steplessly in proportion to an electric signal. 	ITV209□	-1.3 to -80 kPa	1/4	14-8-30

- F.R.L.
- AV
- AU
- AF
- AR
- IR
- VEX
- AMR
- ITV**
- IC
- VBA
- VE□
- VY1
- G
- PPA
- AL

Compact Electro-pneumatic Regulator Series *ITV0000*

Compact **15 mm**

With a simplified high-density circuit board design, an extremely compact size has been achieved.

Lightweight **100 g**

Compact electro-pneumatic regulator
Series *ITV0000*

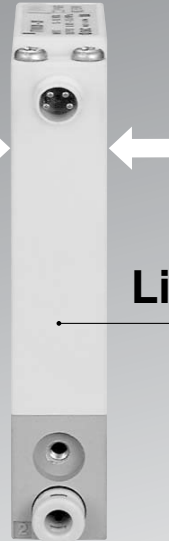

Realizes space-savings and reduction of weight for manifold use.

Stations can easily be increased or decreased due to DIN rail mount design.

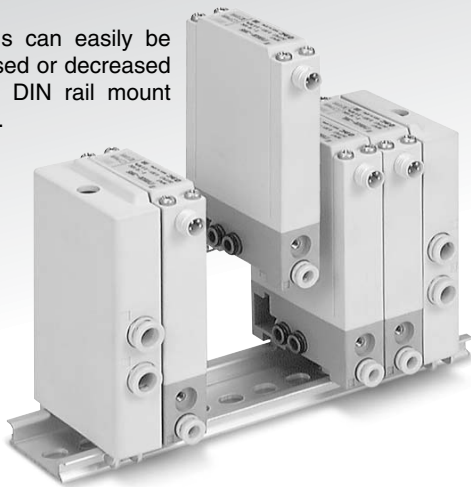

■ Cable connectors

Straight type and right angle type are available.

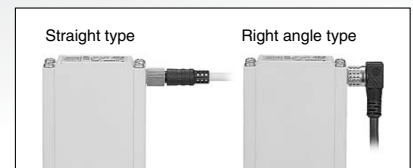

■ Built-in One-touch fitting

■ With error indication LED

■ Brackets

Flat and L-brackets are available.

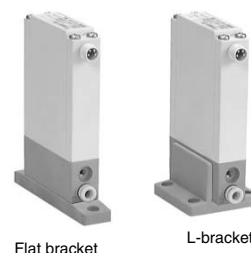

Model	Pressure range	Power supply voltage	Input signal	Output signal	Option
ITV001□	0.1 MPa	24 VDC	4 to 20 mA	Analog output	<ul style="list-style-type: none"> • Cable connectors Straight type Right angle type
ITV003□	0.5 MPa		0 to 20 mA		
ITV005□	0.9 MPa	12 VDC	0 to 5 VDC	1 to 5 V	<ul style="list-style-type: none"> • Brackets Flat bracket L-bracket
ITV009□	-100 kPa		0 to 10 VDC		

- Equivalent to IP65
- Linearity within $\pm 1\%$ (Full span)
- Hysteresis 0.5% (Full span)
- Repeatability $\pm 0.5\%$ (Full span)
- High-speed response time 0.1 sec (Without load)

● High stability

Stable pressure control is possible even when a metal cylinder is used.

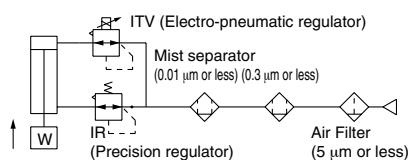

Compact Electro-pneumatic Regulator Series *ITV0000*

How to Order

For single unit and single unit for manifold

ITV00 **1** **0** - **3** [] [] [] **N**

Pressure range

1	0.1 MPa
3	0.5 MPa
5	0.9 MPa
9 *	-100 kPa

* Option

Power supply voltage

0	24 VDC ±10%
1 *	12 to 15 VDC

* Option

Input signal

0 *	Current type 4 to 20 mA DC
1 *	Current type 0 to 20 mA DC
2 *	Voltage type 0 to 5 VDC
3	Voltage type 0 to 10 VDC

* Option

Built-in One-touch fittings type

For single unit

Symbol	SUP (VAC) [1]	OUT [2]	EXH (ATM) [3]
Nil	Metric size (Light gray)	ø4	
U	Inch size (Orange)	ø5/32"	

For manifold

Symbol	SUP (VAC) [1]	OUT [2]	EXH (ATM) [3]	
Nil	Metric size (Light gray)	ø6	ø4	ø6
U	Inch size (Orange)	ø1/4"	ø5/32"	ø1/4"

Cable connector (Option)

N	Without cable connector
S	Straight type 3 m
L	Right angle type 2 m

Bracket/ Option for single unit only

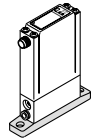
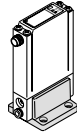
Nil	Without bracket
B	Flat Bracket 
C	L-bracket 

Base type

Nil	For single unit
M	For manifolds

Manifold

IITV00 - **02** - **n**

Stations

02	2 stations
03	3 stations
:	:
10	10 stations

Option

If a DIN rail longer than the specified stations is required, specify the applicable cable stations in two digits. (Maximum 10 stations)
Example) IITV00-05-07

Note) A DIN rail with the length specified by the number of stations is attached to the manifold. For dimensions of the DIN rail, refer to the external dimensions.

How to Order Manifold Assembly (Example)

Indicate the part numbers of electro-pneumatic regulators and options to be mounted below the manifold part number.

Example)

Due to the common supply/exhaust feature, note that different pressure range combinations are not available.

IITV00-03.....1 set (Manifold part no.)

*ITV0030-3MS.....2 sets (Electro-pneumatic regulator part no. (1, 2 stations))

*ITV0030-3ML.....1 set (Electro-pneumatic regulator part no. (3 stations))

Indicate part numbers in order starting from the first station on the D side.

Note) Combination with having different pressure ranges is not available due to common supply/exhaust features.

The asterisk (*) specifies mounting. Add an asterisk (*) at the beginning of electro-pneumatic regulator part numbers to be mounted.

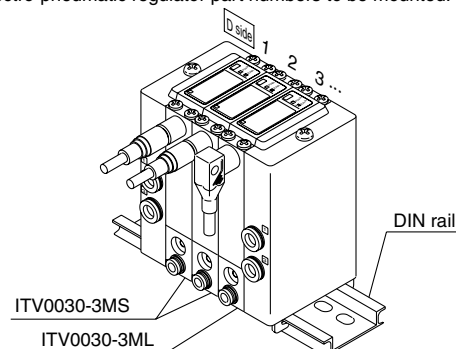

F.R.L.
AV
AU
AF
AR
IR
VEX
AMR
ITV
IC
VBA
VE □
VY1
G
PPA
AL

Series ITV0000

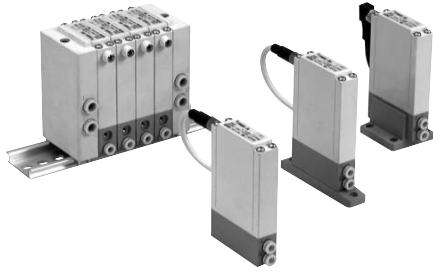

Specifications

Model		ITV001□	ITV003□	ITV005□	ITV009□
Min. supply pressure		Set pressure +0.1 MPa			Set pressure -1 kPa
Max. supply pressure		0.2 MPa	1.0 MPa		-101 kPa
Regulating pressure range		0.001 to 0.1 MPa	0.001 to 0.5 MPa	0.001 to 0.9 MPa	-1 to -100 kPa
Maximum flow rate		3.5 ℓ/min(ANR) (Supply pressure: 0.2 MPa)	6 ℓ/min(ANR) (Supply pressure: 0.6 MPa)	6 ℓ/min(ANR) (Supply pressure: 0.6 MPa)	2 ℓ/min(ANR) (Supply pressure: -101 kPa)
Power supply	Voltage	24 VDC ±10%, 12 to 15 VDC			
	Current consumption	Power supply voltage 24 VDC type: 0.12 A or less Power supply voltage 12 to 15 VDC type: 0.18 A or less			
Input signal	Voltage type	0 to 5 VDC, 0 to 10 VDC			
	Current type	4 to 20 mA DC, 0 to 20 mA DC			
Input impedance	Voltage type	Approximately 10 kΩ			
	Current type	Approximately 250 Ω			
Output signal	Analog output	1 to 5 VDC (Load impedance: 1 kΩ or more) Output accuracy: Within ±6% (Full span)			
Linearity		Within ±1% (Full span)			
Hysteresis		Within 0.5% (Full span)			
Repeatability		Within ±0.5% (Full span)			
Sensitivity		Within 0.2% (Full span)			
Temperature characteristics		Within ±0.12% (Full span)/°C			
Operating temperature range		0 to 50°C (With no condensation)			
Enclosure		IP65 equivalent *			
Connection type		Built-in One-touch fittings			
Connection size	For single unit	Metric size	①, ②, ③: ø4		
		Inch size	①, ②, ③: ø5/32"		
	Manifold	Metric size	①, ③: ø6, ②: ø4		
		Inch size	①, ③: ø1/4", ②: ø5/32"		
Weight ⁽¹⁾		100 g or less (without options)			

Note 1) Indicates the weight of a single unit.

For IITV00-n

Total weight (g) ≤ Stations (n) x 100 + 130 (Weight of end block A, B assembly) + Weight (g) of DIN rail

Note 2) Specifications other than the following are optional. Pressure range: 0.1 MPa, 0.5 MPa, 0.9 MPa, Power supply voltage: 24 VDC, Input signal: 0 to 10 VDC

Note 3) When there is a downstream flow consumption, pressure may become unstable depending on piping conditions.

* When using under the conditions equivalent to IP65, connect the fitting or tube to the breathing hole prior to use. (For details, refer to page 14-8-11 in Specific Product Precautions.)

Option

Bracket

Flat bracket assembly
P39800022



L-bracket assembly
P39800023



Tighting torque when assembling is 0.3 N·m.

Cable connector

Straight type
M8-4DSX3MG4



Right angle type
ELWIK-AKV4408 PVC025 2M



Working Principle

When the input signal rises, the air supply solenoid valve ① turns ON. Due to this, part of the supply pressure passes through the air supply solenoid valve ① and changes to output pressure. This product pressure feeds back to the control circuit ④ via the pressure sensor ③. Here, pressure corrections continue until output pressure becomes proportional to the input signal, enabling output pressure that is proportional to the input signal.

Diagram of working principle

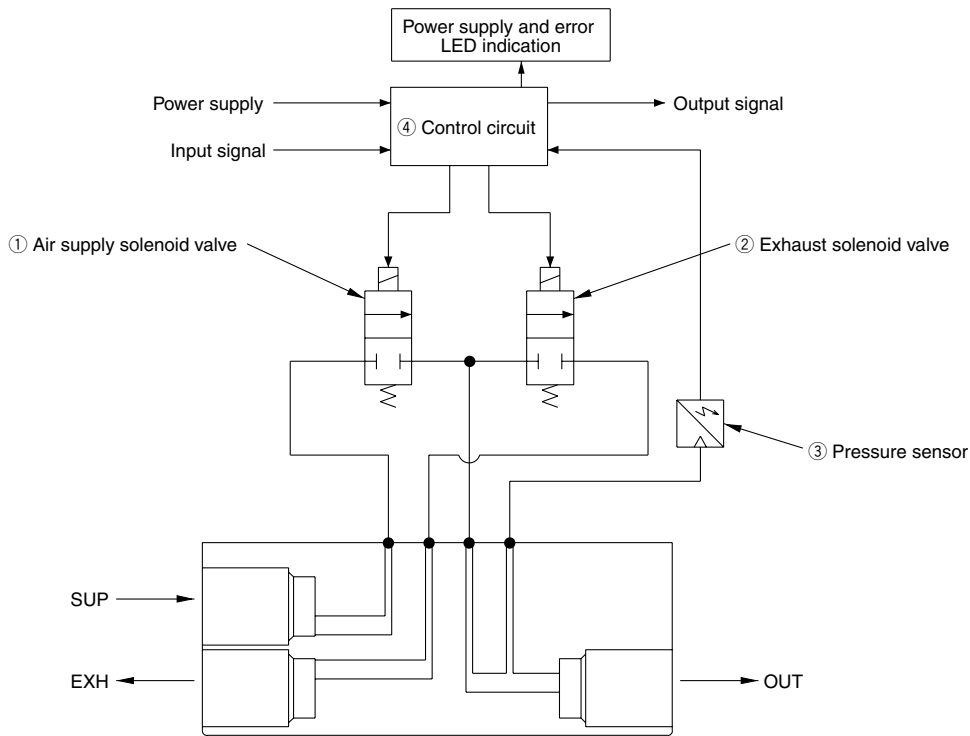

Block diagram

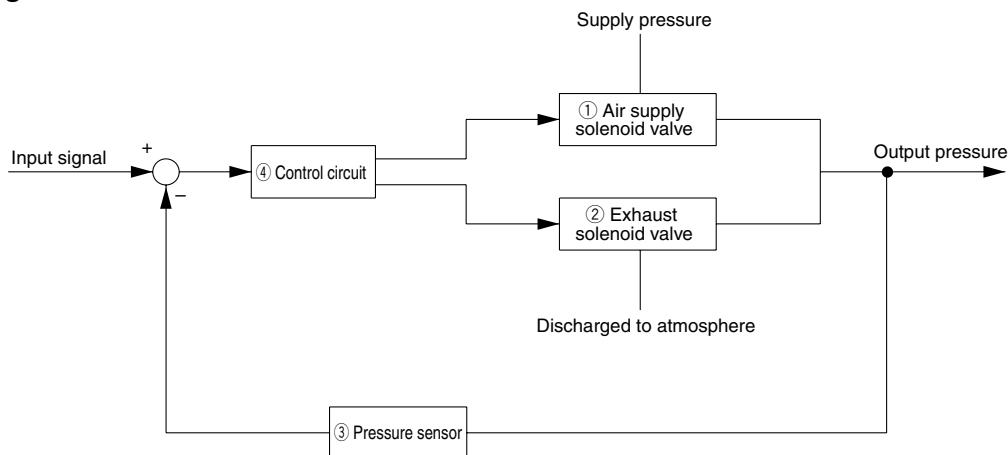

F.R.L.
AV
AU
AF
AR
IR
VEX
AMR
ITV
IC
VBA
VE□
VY1
G
PPA
AL

Series ITV0000

Series ITV001

Linearity, Hysteresis

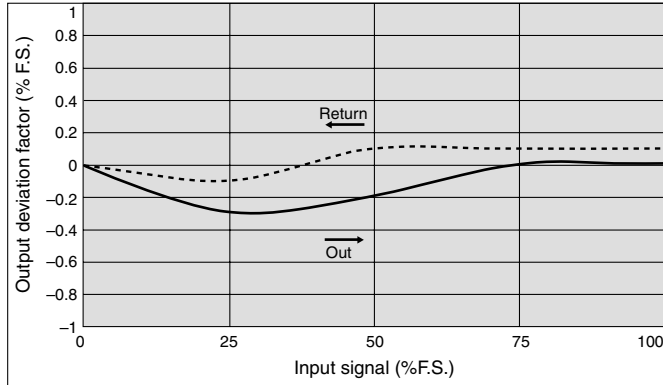

Repeatability

With 50% of signal input

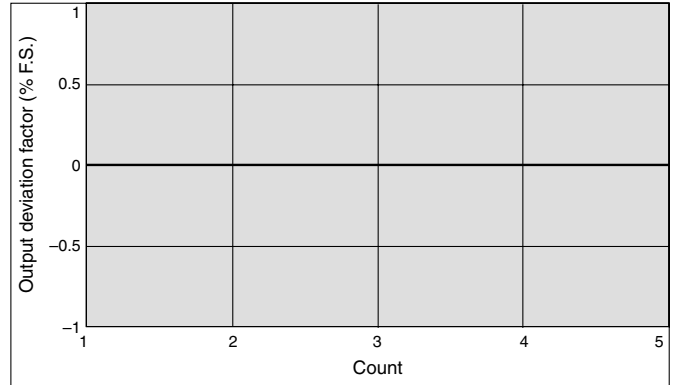

Pressure Characteristics

Set pressure: 0.05 MPa

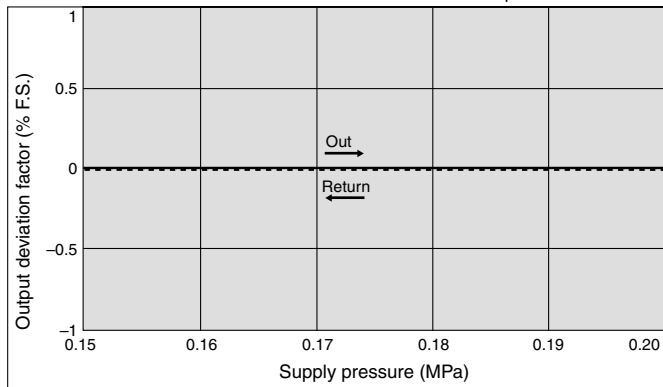

Flow Characteristics

Supply pressure: 0.2 MPa

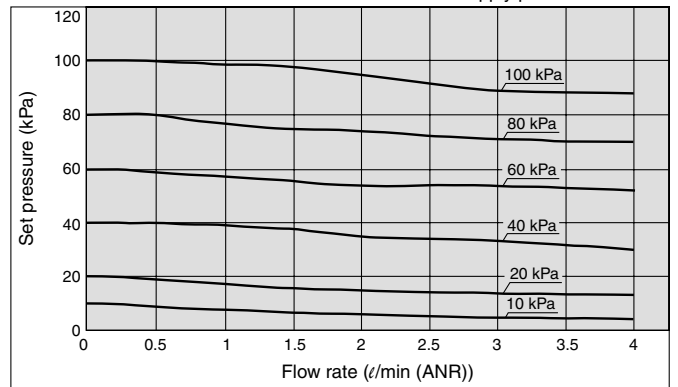

Series ITV003

Linearity, Hysteresis

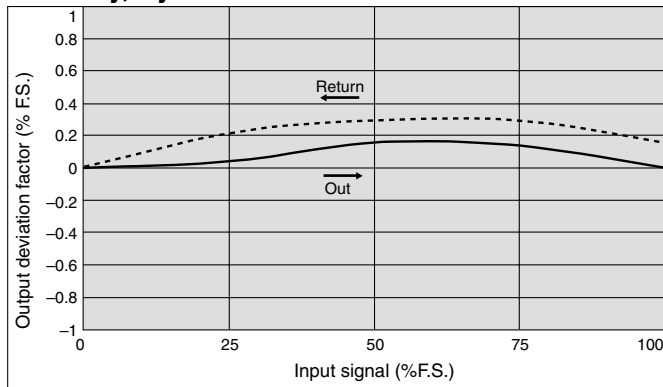

Repeatability

With 50% of signal input

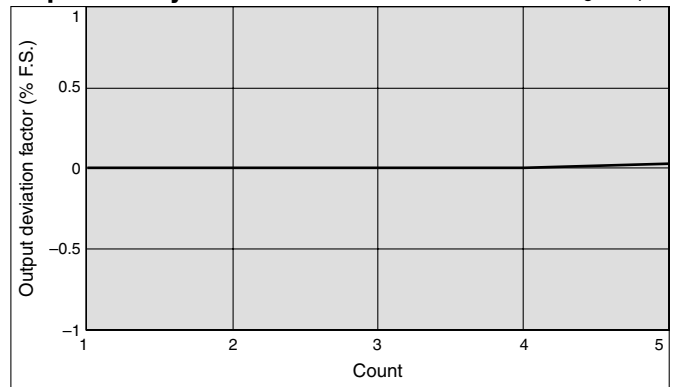

Pressure Characteristics

Set pressure: 0.25 MPa

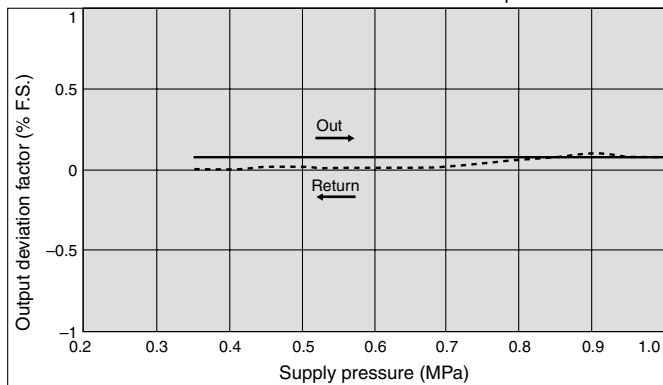

Flow Characteristics

Supply pressure: 0.6 MPa

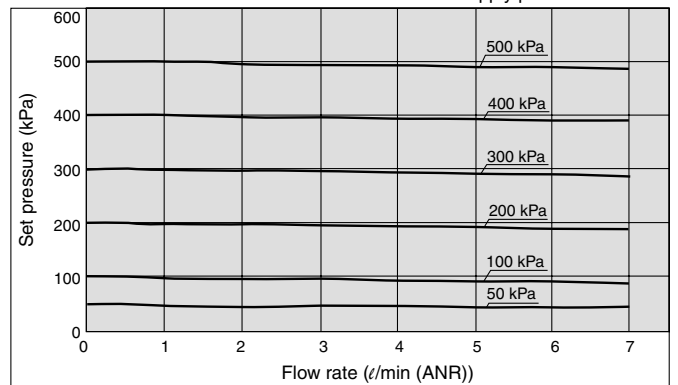

Series ITV005

Linearity, Hysteresis

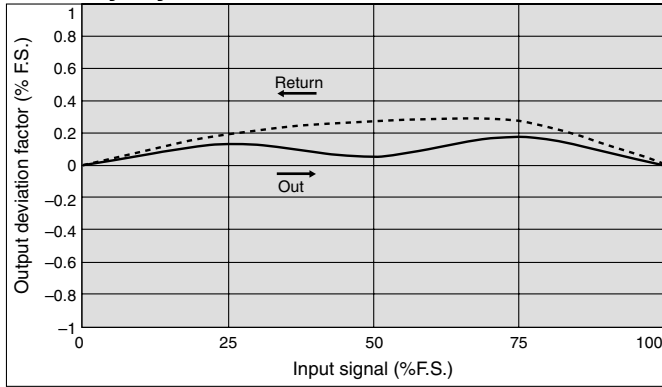

Repeatability

With 50% of signal input

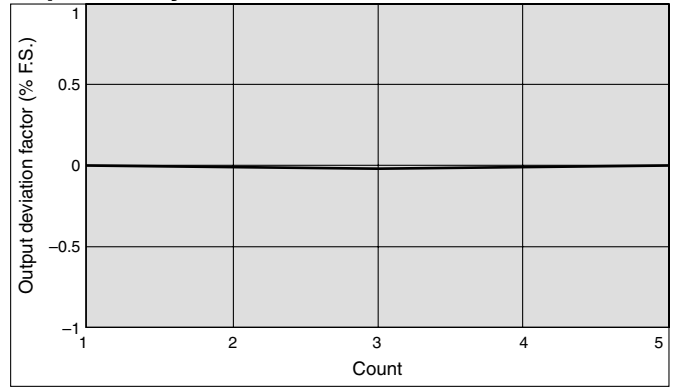

Pressure Characteristics

Set pressure: 0.45 MPa

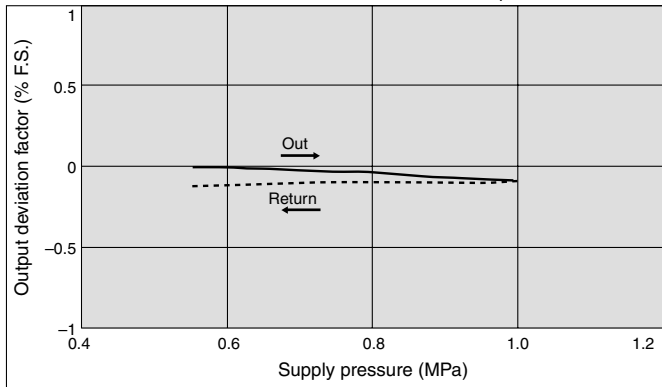

Flow Characteristics

Supply pressure: 1.0 MPa

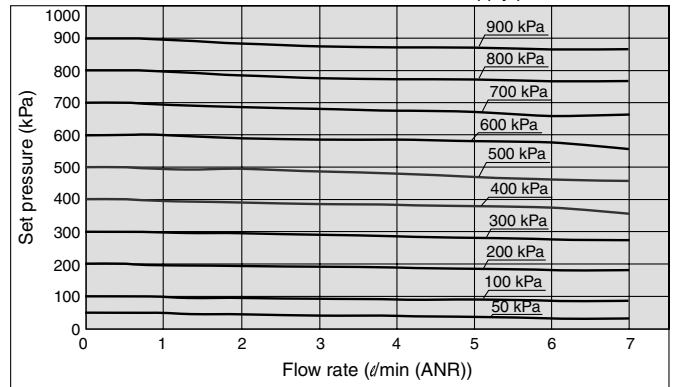

Series ITV009

Linearity, Hysteresis

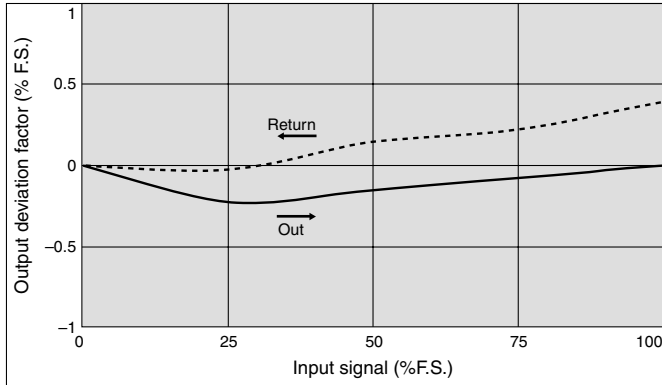

Repeatability

With 50% of signal input

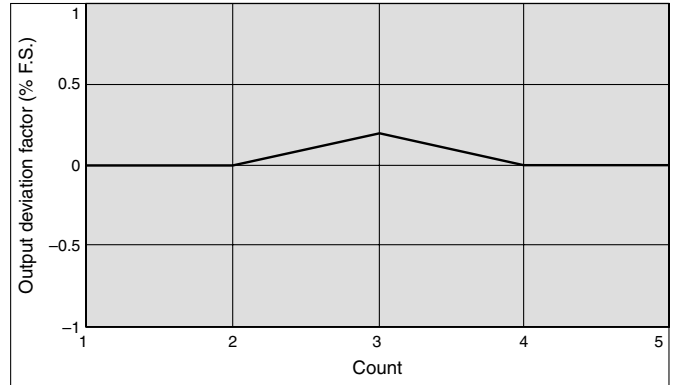

Pressure Characteristics

Set pressure: -10 kPa

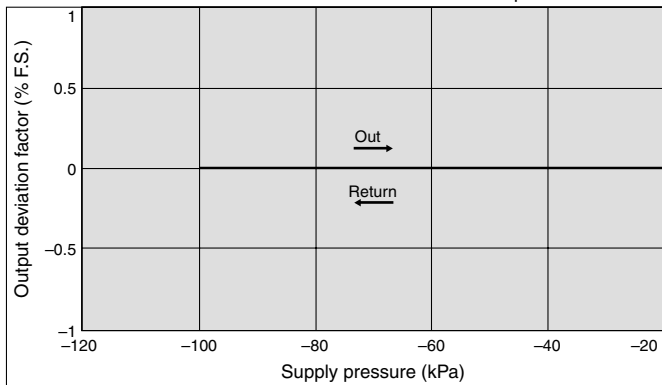

Flow Characteristics

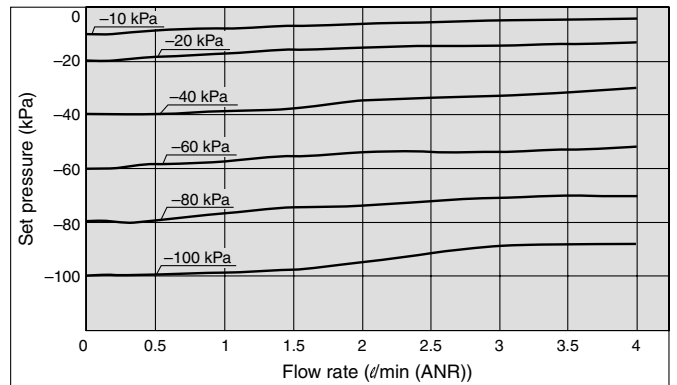

F.R.L.

AV

AU

AF

AR

IR

VEX

AMR

ITV

IC

VBA

VE

VY1

G

PPA

AL

Series ITV0000

Dimensions

For Single Unit

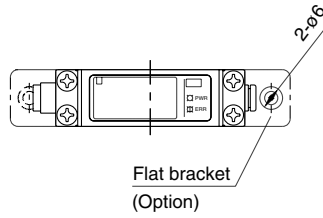
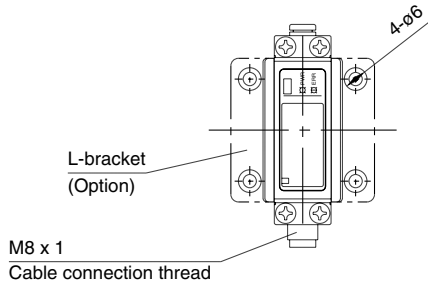

Port Location

No.	1	2	3
ITV003	SUP	OUT	EXH
ITV009	VAC		ATM

Note) When using under the conditions equivalent to IP65, connect the fitting or tube to the bleed hole prior to use. (For details, refer to page 14-8-11 in Specific Product Precautions.)

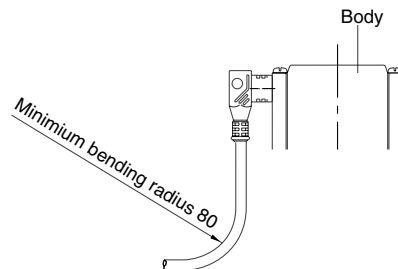
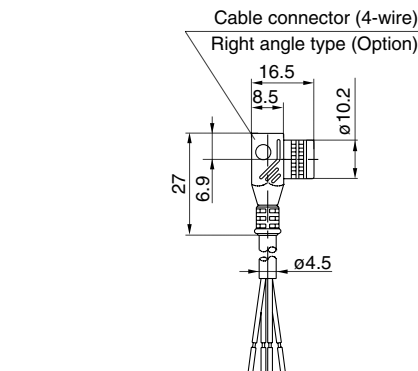
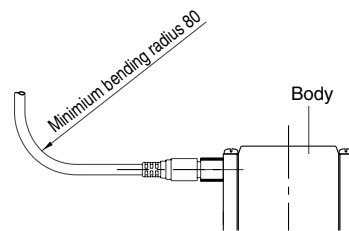
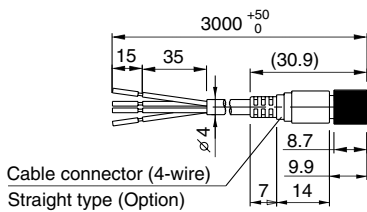
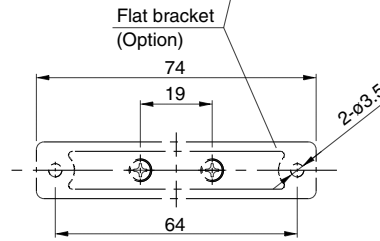
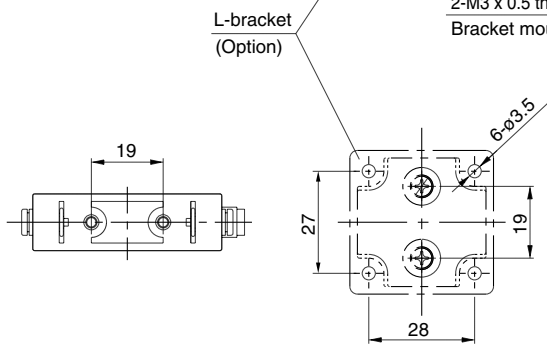
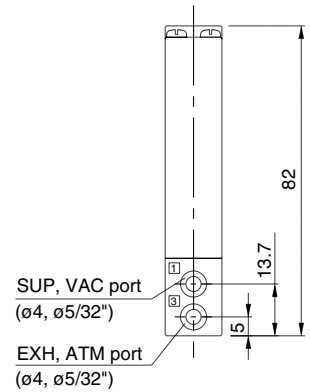
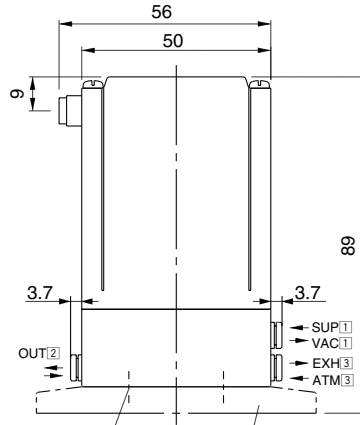
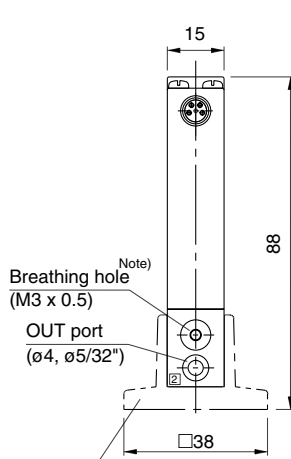

Compact Electro-pneumatic Regulator Series ITV0000

Dimensions

Single unit for manifold

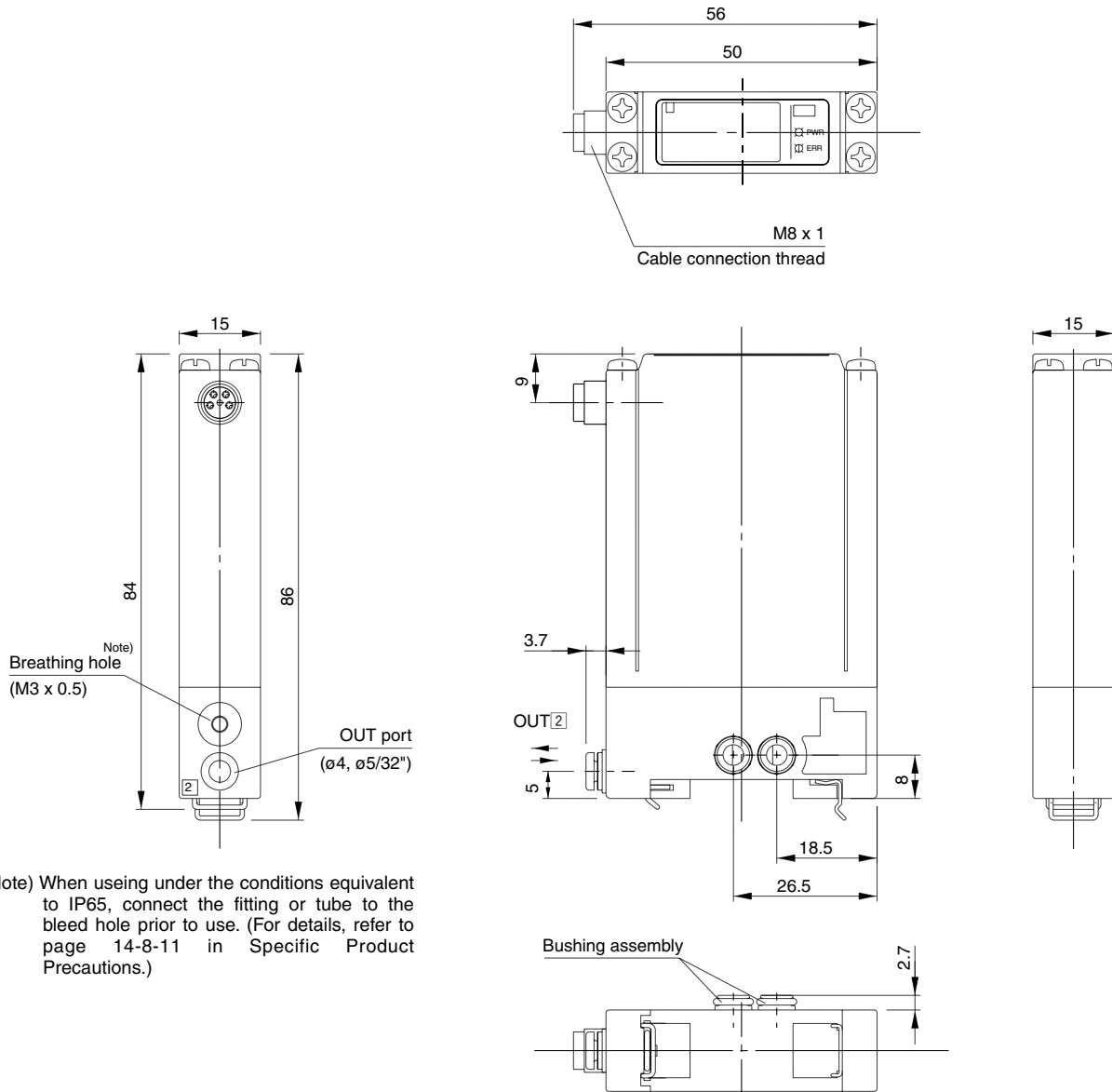

Note) When using under the conditions equivalent to IP65, connect the fitting or tube to the bleed hole prior to use. (For details, refer to page 14-8-11 in Specific Product Precautions.)

Note) For dimensions of the cable connector, refer to single unit on page 14-8-8.

F.R.L.

AV

AU

AF

AR

IR

VEX

AMR

ITV

IC

VBA

VE□

VY1

G

PPA

AL

Series ITV0000

Dimensions

Manifold

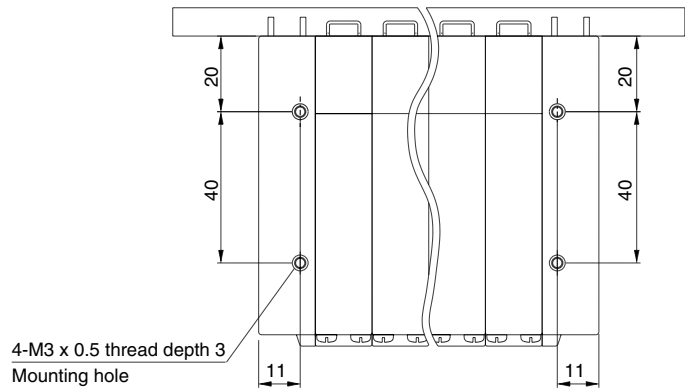

Port Location

No.	1	2	3
1 ITV003□	SUP	OUT	EXH
5 ITV009□	VAC		ATM

Note) Stations are counted starting from the D side.

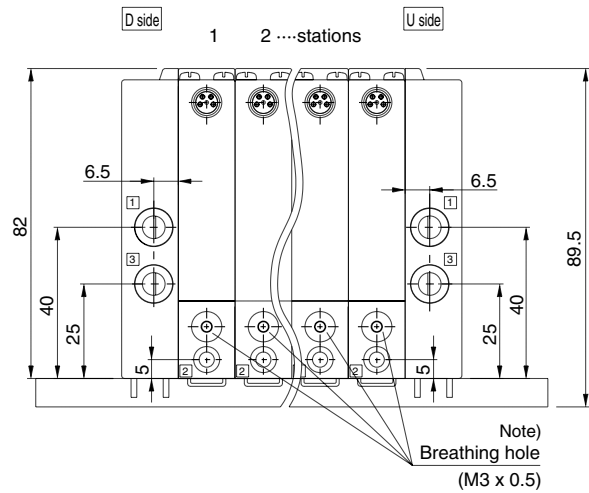
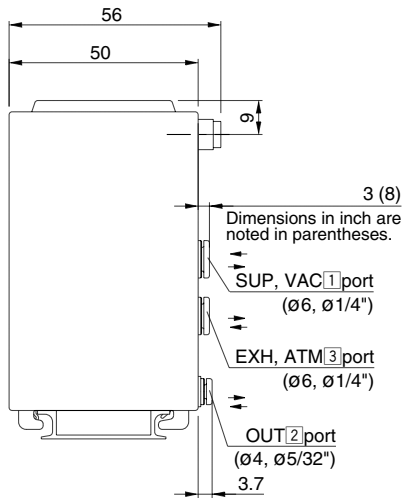
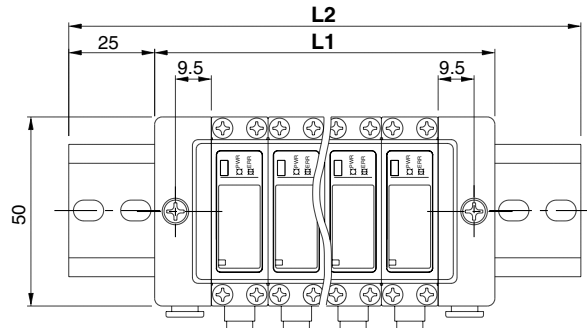

Note) For dimensions of the cable connector, refer to single unit on page 14-8-8.

Note) When using under the conditions equivalent to IP65, connect the fittings or tubing to the bleed hole prior to use. (For details, refer to "Specific Product Precautions" on page 14-8-11.)

Manifold stations n	2	3	4	5	6	7	8	9	10
L1	60	75	90	105	120	135	150	165	180
L2	110.5	123	148	160.5	173	185.5	198	223	235.5

⚠ Precautions

Be sure to read before handling. Refer to pages 14-21-3 to 14-21-4 for Safety Instructions and Common Precautions.

Air Supply

⚠ Caution

1. Install an air filter near this product on the supply side. Select a filtration degree of 5 μm or less.
2. Compressed air containing large amounts of drainage can cause malfunction of this product and other pneumatic equipment. As a countermeasure, install an aftercooler, air dryer or Drain Catch, etc.
3. If large amounts of carbon dust are generated by the compressor, it can accumulate inside this product and cause malfunction.

For details on the above compressed air quality, refer to 14-14-2.

Wiring

⚠ Caution

Connect the cable to the connector on the body with the wiring arranged as shown below. Proceed carefully, as incorrect wiring can cause damage. Further, use DC power with sufficient capacity and a low ripple.

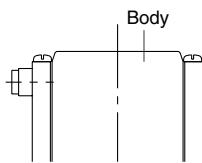
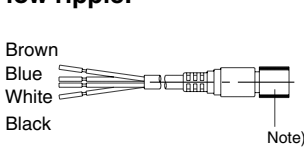

Terminal no.	1	2	3	4
Lead wire color	Brown	White	Blue	Black
Wiring	Power supply	Signal	COM	Monitor

Note) A right angle type is also available. The entry directions for the right angle type connector is downward (OUT port side). Never turn the connector as it is not designed to turn. If forced, it will damage the connector port.

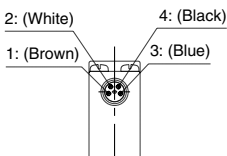

Wiring diagram

Current signal type

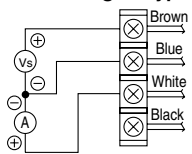

Vs : Power supply 24 VDC
12 to 15 VDC
A : Input signal 4 to 20 ADC
0 to 20 ADC

Voltage signal type

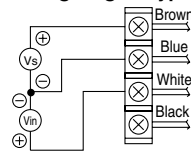

Vs : Power supply 24 VDC
12 to 15 VDC
Vin : Input signal 0 to 5 VDC
0 to 10 VDC

Monitor output wiring diagram

Analog output, voltage type

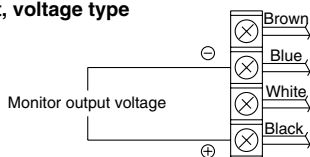

Handling

⚠ Caution

1. Do not use a lubricator on the supply side of this product, as this can cause a malfunction. When lubrication of terminal equipment is necessary, connect a lubricator on the output side of this regulator.
2. If electric power is shut off while pressure is being applied, output pressure will be maintained. However, this output pressure is held only temporarily and is not guaranteed. If exhausting of this pressure is desired, shut off the power after reducing the set pressure, and discharge the air using a residual pressure exhaust valve, etc.
3. If power supply to this regulator is cut off due to a power failure, etc., when it is in a regulated state, output pressure will be maintained temporarily. Handle carefully when operating with output pressure released to the atmosphere, as air will continue to flow out until reaching atmospheric pressure.
4. If supply pressure to this regulator is interrupted while the power is still on, the internal solenoid valve will continue to operate and a humming noise may be generated. Since the life of the solenoid valve may be shortened by this, be sure to shut off the power supply when supply pressure is shut off.
5. This product is adjusted for each specification at the time of shipment from the factory. Avoid unnecessary disassembly or removal of parts, as this can lead to a malfunction.
6. The optional cable connector is a 4-wire type. When the monitor output (analog output) is not being used, keep the monitor output wire (black) from touching the other wires as this can cause a malfunction.
7. Use caution that the right angle cable does not rotate and is limited to only one entry direction.
8. Take the following steps to avoid malfunction caused by noise.
 - 1) Remove power supply noise during operation by installing a line filter, etc. in the AC power line.
 - 2) Install this product and its wiring as far as possible from strong electric fields such as those of motors and power lines, etc.
 - 3) Make sure to take protective measures against load surge for an induction load (solenoid valves, relays, etc.).
9. Characteristics are limited only to the static state, and when air is consumed on the output side, pressure may fluctuate.
10. For details on the handling of this product, refer to the instruction manual included with the product.
11. In locations where the body is exposed to water, dust, etc., there is a possibility that they can enter into the body through the breathing hole. Use a fitting/tube (M-3AU-3 fitting and TIU01□-□□ tube are recommended), extend the piping to the location where there is no water, dust, etc.
12. When using in an enclosed environment, like an inspection box, etc., make sure to install a fan or other such device to prevent from overheating.

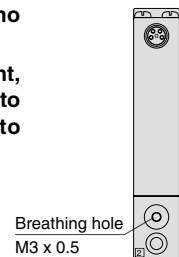

F.R.L.

AV

AU

AF

AR

IR

VEX

AMR

ITV

IC

VBA

VE□

VY1

G

PPA

AL

Electro-pneumatic Regulator

Series *ITV1000/2000/3000*

Stepless control of air pressure proportional to an electrical signal

ITV1000
200 ℓ/min (ANR)*

ITV2000
1500 ℓ/min (ANR)*

ITV3000
4000 ℓ/min (ANR)*

200 ℓ/min type is newly introduced to the series.
Oil-free specifications (wetted parts)



* Pressure range: 0.9 MPa, Supply pressure: 1.0 MPa

Sensitivity: **0.2** kPa (100 kPa specifications)

IP65

Linearity: Within **±1%** (F.S.)

Hysteresis: Within **±0.5%** (F.S.)

F.R.L.

AV

AU

AF

AR

IR

VEX

AMR

ITV

IC

VBA

VE□

VY1

G

PPA

AL

Electro-pneumatic Regulator

ITV1000/2000/3000

Standard Specifications



Straight type



Right angle type

JIS Symbol

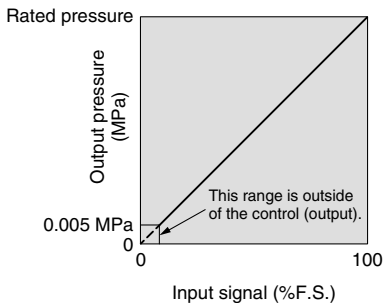
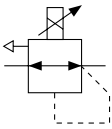

Graph (1) Input/output characteristics chart

Model		ITV101□	ITV103□	ITV105□
		ITV201□	ITV203□	ITV205□
		ITV301□	ITV303□	ITV305□
Minimum supply pressure		Set pressure +0.1 MPa		
Maximum supply pressure		0.2 MPa		1.0 MPa
Set pressure range ^{Note 1)}		0.005 to 0.1 MPa	0.005 to 0.5 MPa	0.005 to 0.9 MPa
Power supply	Voltage	24 VDC ± 10%, 12 to 15 VDC		
	Current consumption	Power supply voltage 24 VDC type: 0.12 A or less Power supply voltage 12 to 15 VDC type: 0.18 A or less		
Input signal	Current type ^{Note 2)}	4 to 20 mA, 0 to 20 mA (Sink type)		
	Voltage type	0 to 5 VDC, 0 to 10 VDC		
	Preset input	4 points		
Input impedance	Current type	250 Ω or less		
	Voltage type	Approx. 6.5 kΩ		
	Preset input	Approx. 2.7 kΩ		
Output signal ^{Note 3)} (monitor output)	Analog output	1 to 5 VDC (Load impedance: 1 kΩ or more) 4 to 20 mA (Sink type) (Load impedance: 250 Ω or less)		
	Switch output	NPN open collector output: Max. 30 V, 30 mA PNP open collector output: Max. 30 mA		
Linearity		Within ±1% (full span)		
Hysteresis		Within 0.5% (full span)		
Repeatability		Within ±0.5% (full span)		
Sensitivity		Within 0.2% (full span)		
Temperature characteristics		Within ±0.12% (full span)/°C		
Output pressure display	Accuracy	±3% (full span)		
	Minimum unit	MPa: 0.01, kgf/cm ² : 0.01, bar: 0.01, PSI: 0.1 ^{Note 4)} , kPa: 1		
Ambient and fluid temperature		0 to 50°C (with no condensation)		
Enclosure		IP65		
Weight	ITV10□□	Approx. 250 g (without options)		
	ITV20□□	Approx. 350 g (without options)		
	ITV30□□	Approx. 645 g (without options)		

- Note 1) Please refer to "Graph (1)", relation to the differences between the set pressure and input. Additionally, refer to page 14-8-29 for the set pressure range by units of standard measured pressure. Additionally, refer to page 14-8-29 as maximum set pressure differs on unit of standard measure.
- Note 2) 2-wire type 4 to 20 mA is not available. Power supply voltage (24 VDC or 12 to 15 VDC) is required.
- Note 3) Select either analog output or switch output. Further, when switch output is selected, select either NPN output or PNP output.
- Note 4) The minimum unit for ITV205□ is 1PSI.
- Note 5) The above characteristics are confined to the static state. When air is consumed on the output side, the pressure may fluctuate.

How to Order

ITV 3 0 1 0 - 0 1 2 S - Q

Model

1	1000
2	2000
3	3000

Pressure range

1	0.1 MPa
3	0.5 MPa
5	0.9 MPa

Power supply voltage

0	24 VDC
1	12 to 15 VDC

Input signal

0	Current 4 to 20 mA (Sink type)
1	Current 0 to 20 mA (Sink type)
2	Voltage 0 to 5 VDC
3	Voltage 0 to 10 VDC
4*	Preset input

* Option

Monitor output

0*	None (for preset input)
1	Analog output 1 to 5V DC
2*	Switch output/NPN output
3*	Switch output/PNP output
4*	Analog output 4 to 20 mA (Sink type)

* Option

Thread type

-	Rc
N*	NPT
T*	NPTF
F*	G

* Option

Port size

1	1/8 (1000 type)
2	1/4 (1000, 2000, 3000 type)
3	3/8 (2000, 3000 type)
4	1/2 (3000 type)

Pressure display unit ^{Note 1)}

-	MPa
2	kgf/cm ²
3	bar
4	PSI
5	kPa

* Option

Cable connector type

S	Straight type 3 m
L*	Right angle type 3 m
N*	Without cable connector

* Option

Bracket

-	Without bracket
B*	Flat bracket
C*	L-bracket

* Option

CE compliance

-	-
Q	CE compliant

* Please visit our SMC homepage: <http://www.smcworld.com> for the latest details on our CE compliant products.

Electro-pneumatic Regulator Series ITV1000/2000/3000

Combinations

Standard specifications
 Combination possible
 Combination not possible

* ITV10□□ models are not applicable.

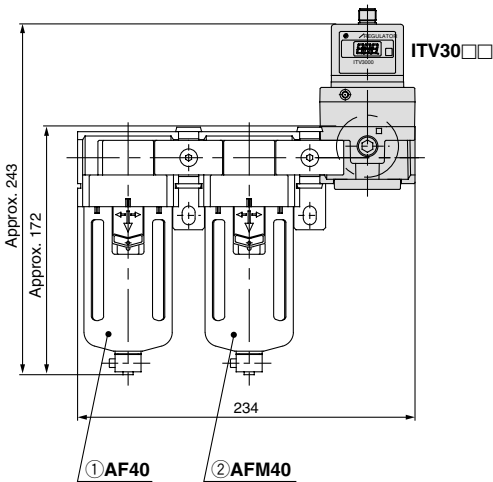
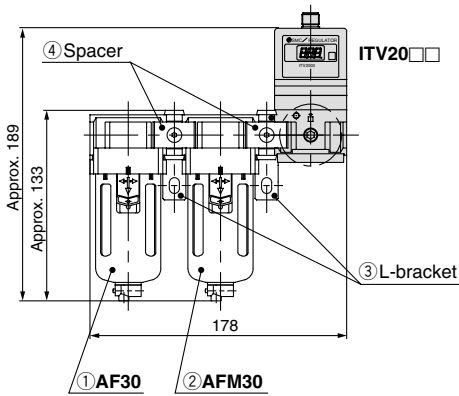

Specifications		Symbol	Applicable model	
			ITV20□□	ITV30□□
Standard specifications	Set pressure max. 0.1 MPa	1	<input type="radio"/>	<input type="radio"/>
	Set pressure max. 0.5 MPa	3	<input type="radio"/>	<input type="radio"/>
	Set pressure max. 0.9 MPa	5	<input type="radio"/>	<input type="radio"/>
	Connection Rc 1/4	02	<input type="radio"/>	<input type="radio"/>
	Connection Rc 3/8	03	<input type="radio"/>	<input type="radio"/>
	Connection Rc 1/2	04	<input type="checkbox"/>	<input type="radio"/>
Accessories	Bracket	B	<input type="radio"/>	<input type="radio"/>
	Bracket	C	<input type="radio"/>	<input type="radio"/>
Optional specifications	Connection NPT1/4	N02	<input type="radio"/>	<input type="radio"/>
	Connection NPT3/8	N03	<input type="radio"/>	<input type="radio"/>
	Connection NPT1/2	N04	<input type="checkbox"/>	<input type="radio"/>
	Connection G 1/4	F02	<input type="radio"/>	<input type="radio"/>
	Connection G 3/8	F03	<input type="radio"/>	<input type="radio"/>
	Connection G 1/2	F04	<input type="checkbox"/>	<input type="radio"/>

Modular Products and Accessory Combinations

* ITV10□□ models are not applicable.

Applicable products and accessories	Applicable model	
	ITV20□□	ITV30□□
① Air filter	AF30	AF40
② Mist separator	AFM30	AFM40
③ L-bracket	B310L	B410L
④ Spacer	Y30	Y40
⑤ Spacer with L-bracket (③ + ④)	Y30L	Y40L

Accessory (Option)/Part No.

Description	Part no.		
	ITV10□□	ITV20□□	ITV30□□
Flat bracket	P3020114 (Mounting thread is not included.)		
L-bracket	INI-398-0-6 (Mounting thread is not included.)		
Cable connector	Straight type 3 m	TM-4DSX3HG4	
	Right angle type 3 m	TM-4DLX3HG4	

Dimensions

Flat bracket

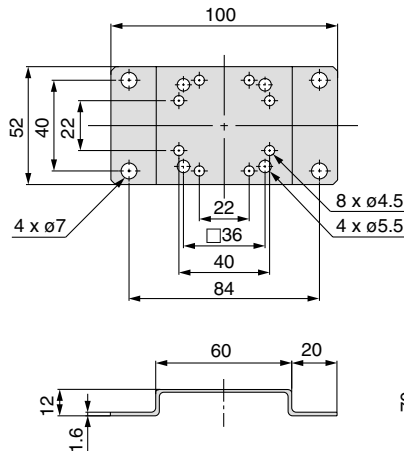

L-bracket

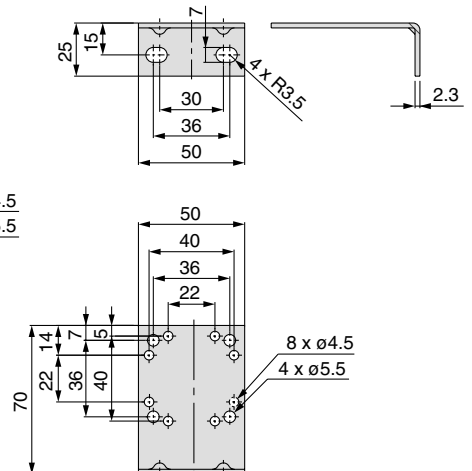

F.R.L.

AV

AU

AF

AR

IR

VEX

AMR

ITV

IC

VBA

VE□

VY1

G

PPA

AL

Series ITV1000/2000/3000

Working Principle

When the input signal rises, the air supply solenoid valve ① turns ON, and the exhaust solenoid valve ② turns OFF. Therefore, supply pressure passes through the air supply solenoid valve ① and is applied to the pilot chamber ③. The pressure in the pilot chamber ③ increases and operates on the upper surface of the diaphragm ④.

As a result, the air supply valve ⑤ linked to the diaphragm ④ opens, and a portion of the supply pressure becomes output pressure.

This output pressure feeds back to the control circuit ⑧ via the pressure sensor ⑦. Here, a correct operation functions until the output pressure is proportional to the input signal, making it possible to always obtain output pressure proportional to the input signal.

Working Principle Diagram

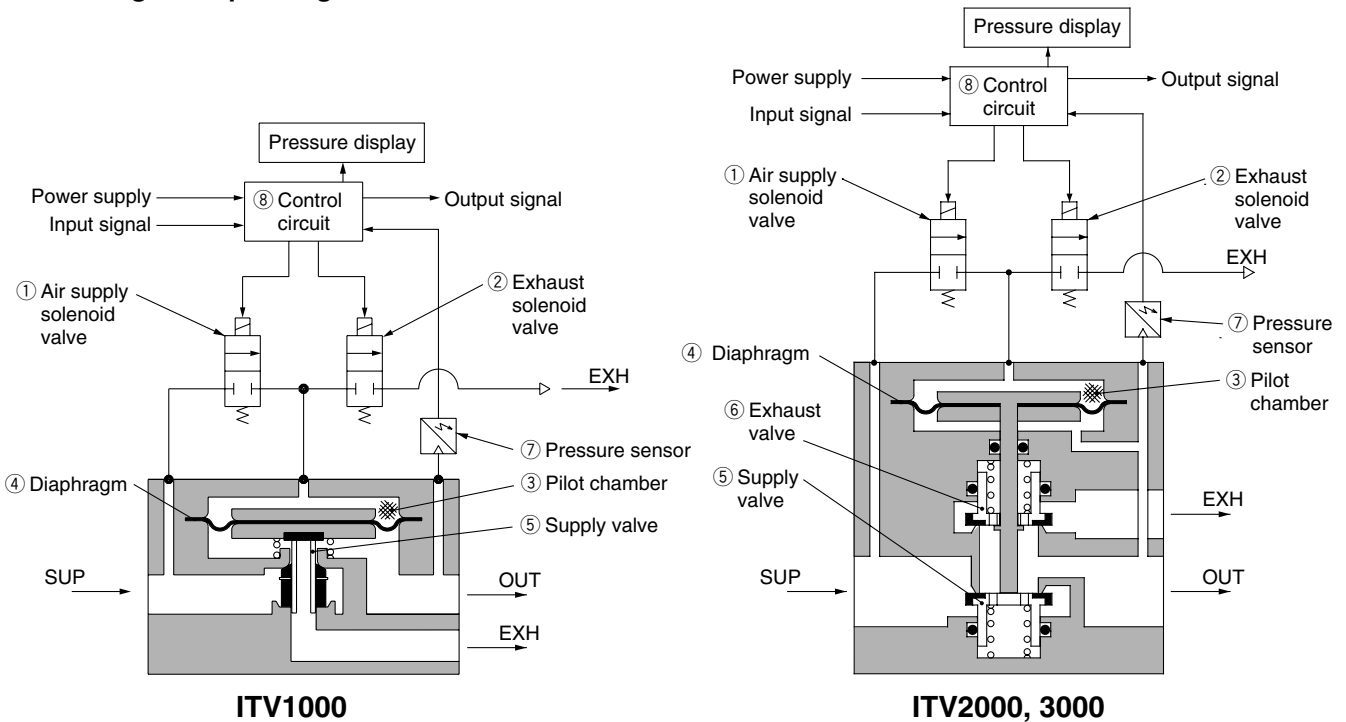

Block diagram

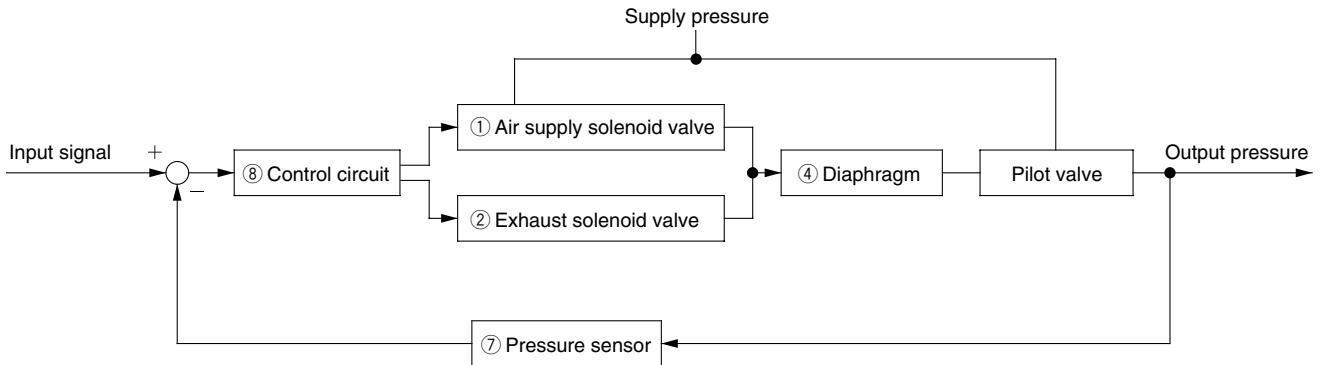

Electro-pneumatic Regulator Series ITV1000/2000/3000

Series ITV101

Linearity

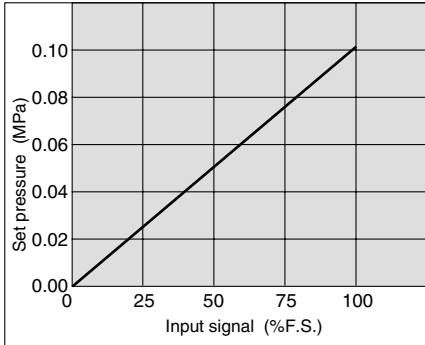

Hysteresis

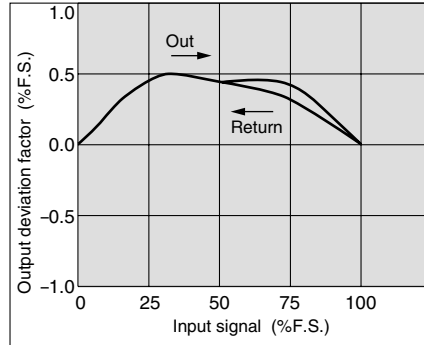

Repeatability

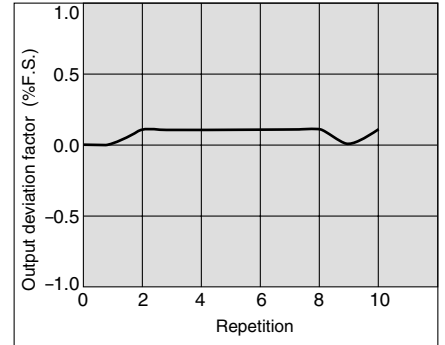

Pressure Characteristics

Set pressure: 0.05 MPa

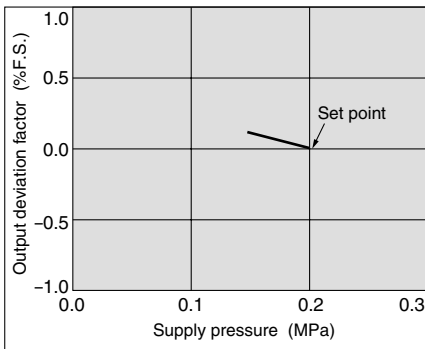

Flow Characteristics

Supply pressure: 0.2 MPa

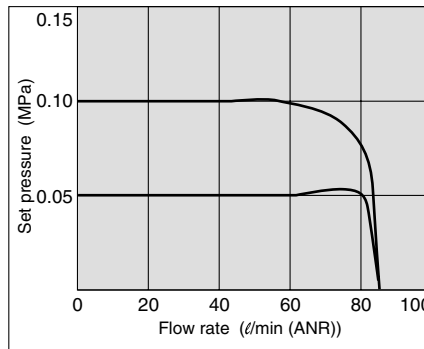

Relief Flow Characteristics

Supply pressure: 0.2 MPa

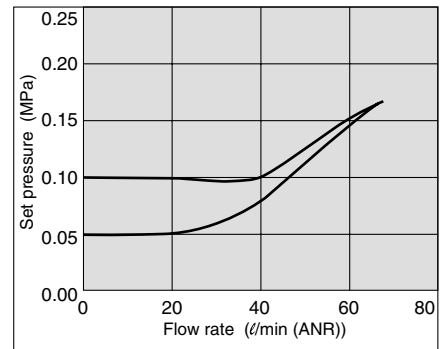

Series ITV201

Linearity

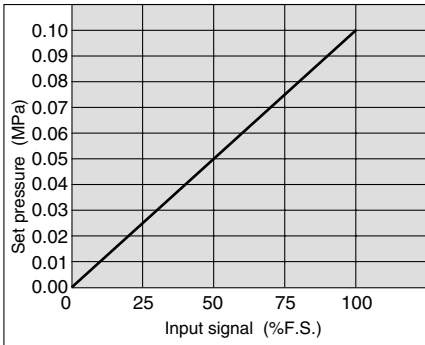

Hysteresis

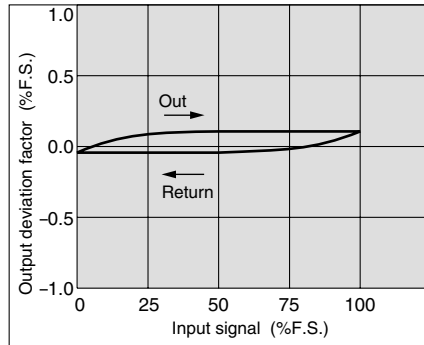

Repeatability

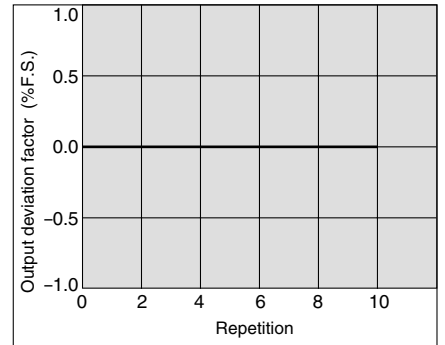

Pressure Characteristics

Set pressure: 0.05 MPa

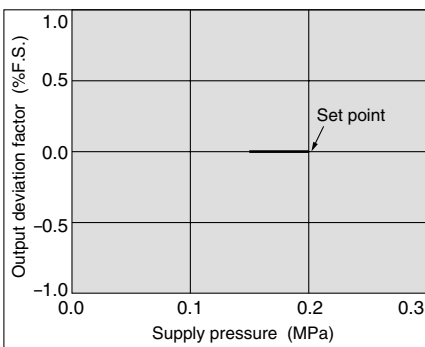

Flow Characteristics

Supply pressure: 0.2 MPa

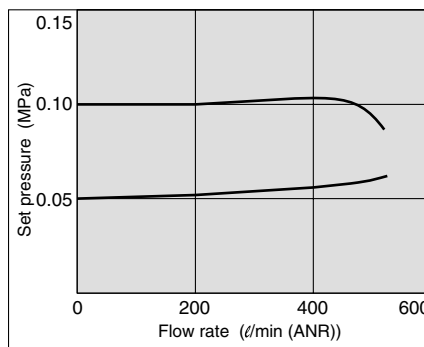

Relief Flow Characteristics

Supply pressure: 0.2 MPa

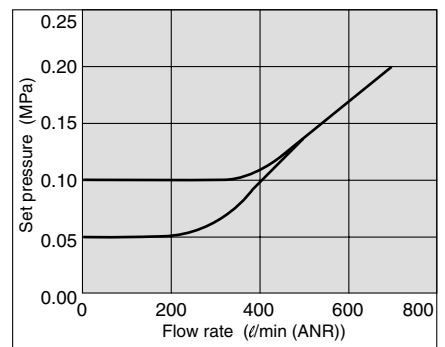

F.R.L.

AV

AU

AF

AR

IR

VEX

AMR

ITV

IC

VBA

VE

VY1

G

PPA

AL

Series ITV1000/2000/3000

Series ITV301

Linearity

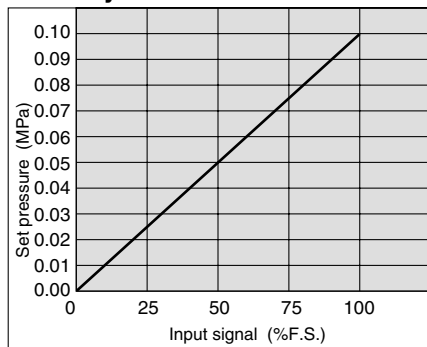

Hysteresis

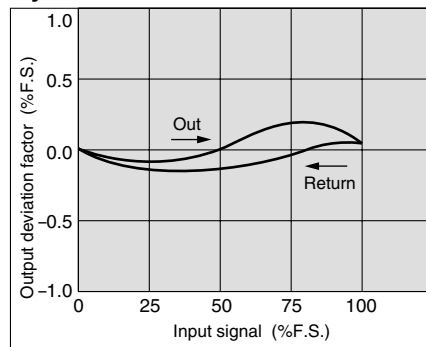

Repeatability

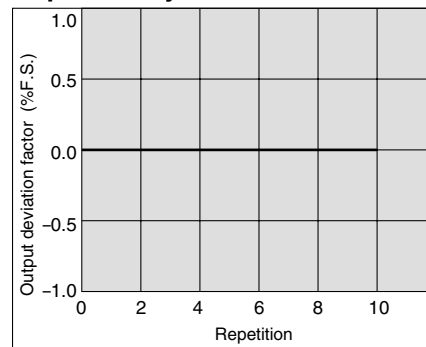

Pressure Characteristics

Set pressure:
0.05 MPa

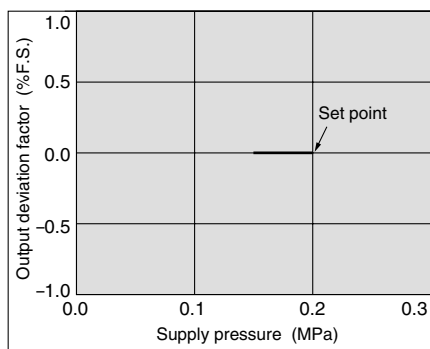

Flow Characteristics

Supply pressure:
0.2 MPa

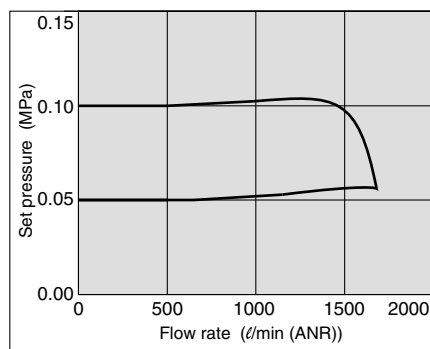

Relief Flow Characteristics

Supply pressure:
0.2 MPa

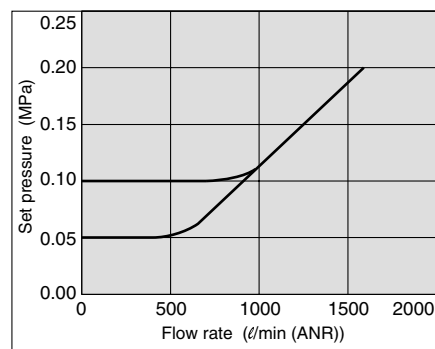

Electro-pneumatic Regulator Series ITV1000/2000/3000

Series ITV103

Linearity

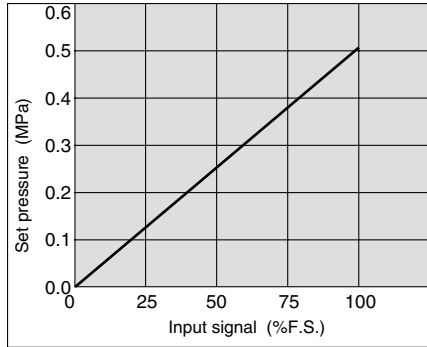

Hysteresis

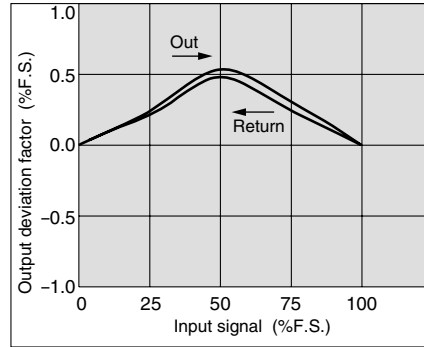

Repeatability

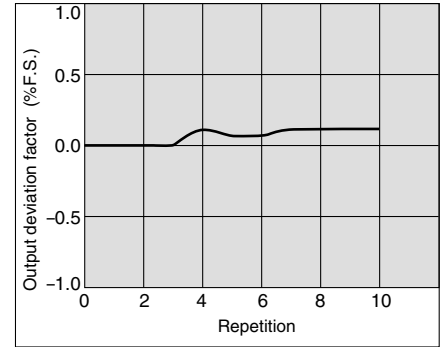

Pressure Characteristics

Set pressure: 0.2 MPa

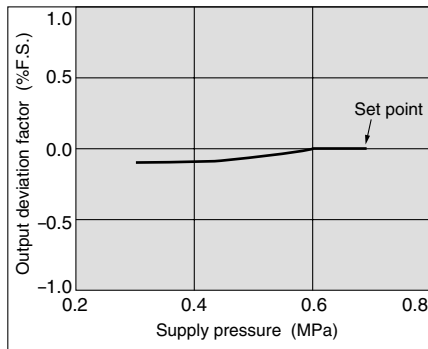

Flow Characteristics

Supply pressure: 0.7 MPa

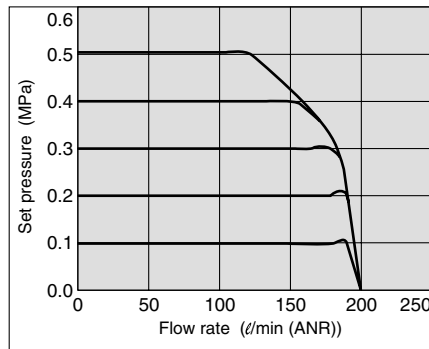

Relief Flow Characteristics

Supply pressure: 0.7 MPa

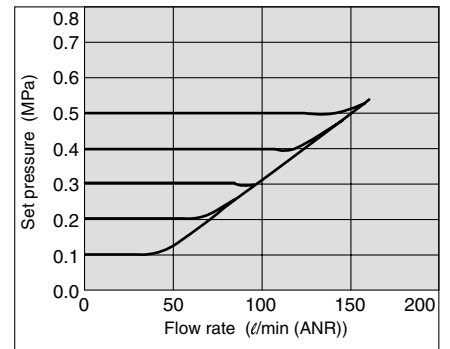

Series ITV203

Linearity

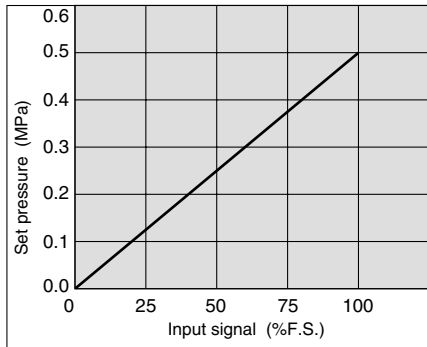

Hysteresis

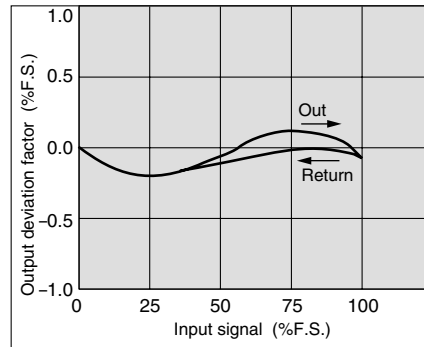

Repeatability

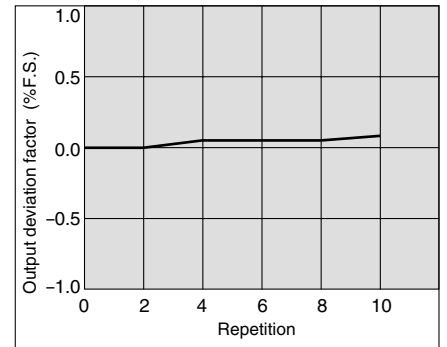

Pressure Characteristics

Set pressure: 0.2 MPa

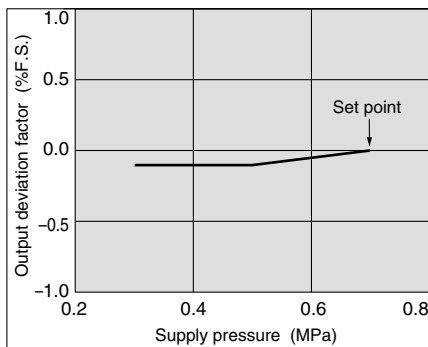

Flow Characteristics

Supply pressure: 0.7 MPa

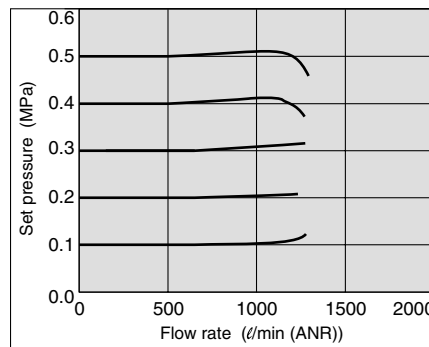

Relief Flow Characteristics

Supply pressure: 0.7 MPa

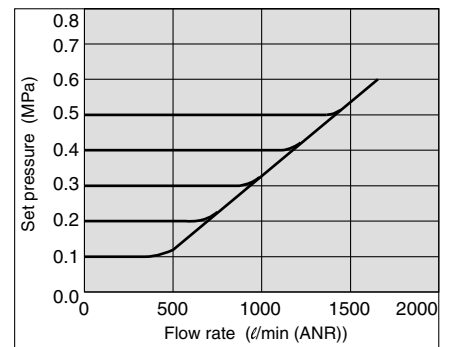

F.R.L.

AV

AU

AF

AR

IR

VEX

AMR

ITV

IC

VBA

VE

VY1

G

PPA

AL

Series ITV1000/2000/3000

Series ITV303

Linearity

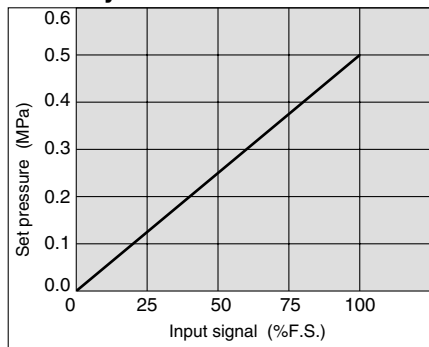

Hysteresis

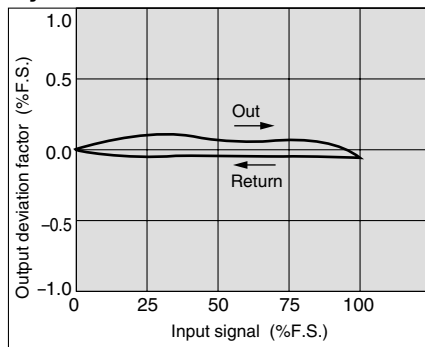

Repeatability

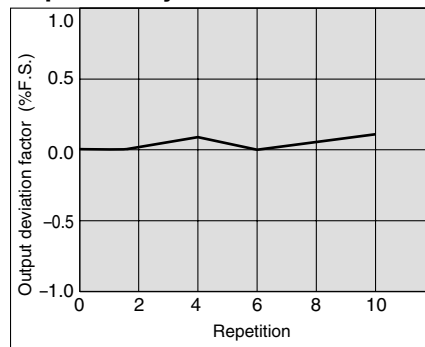

Pressure Characteristics

Set pressure:
0.2 MPa

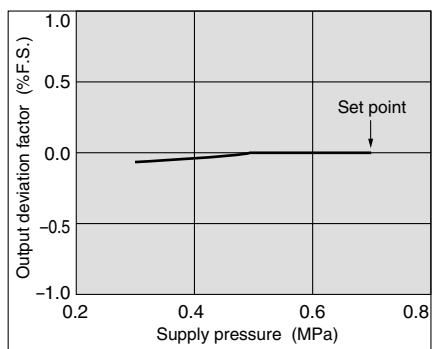

Flow Characteristics

Supply pressure:
0.7 MPa

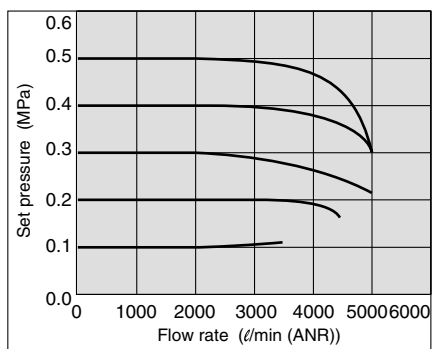

Relief Flow Characteristics

Supply pressure:
0.7 MPa

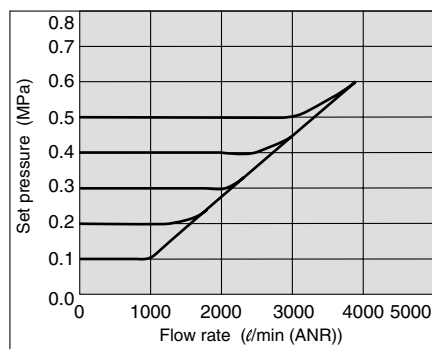

Electro-pneumatic Regulator Series ITV1000/2000/3000

Series ITV105

Linearity

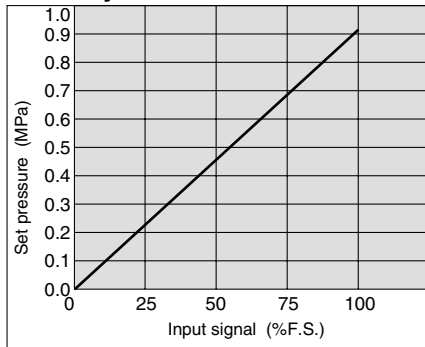

Hysteresis

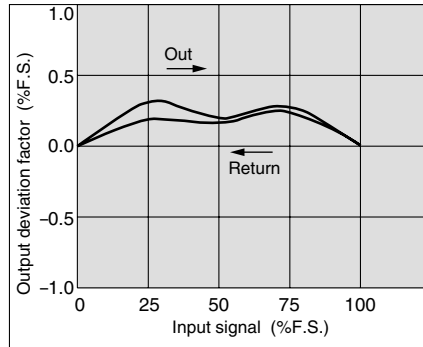

Repeatability

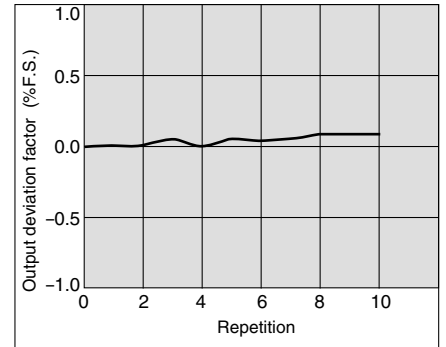

Pressure Characteristics

Set pressure: 0.4 MPa

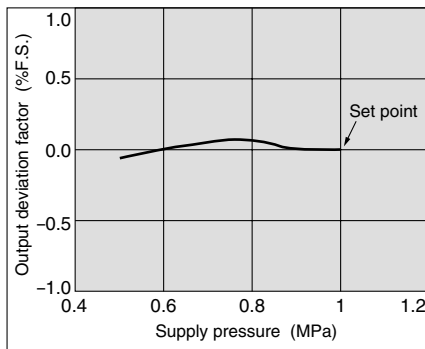

Flow Characteristics

Supply pressure: 1.0 MPa

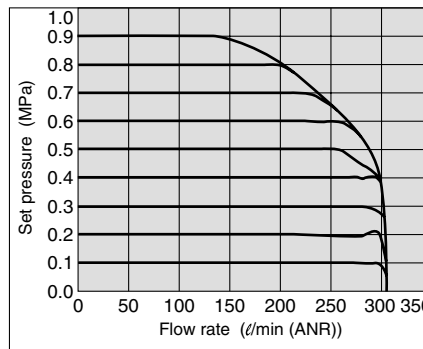

Relief Flow Characteristics

Supply pressure: 1.0 MPa

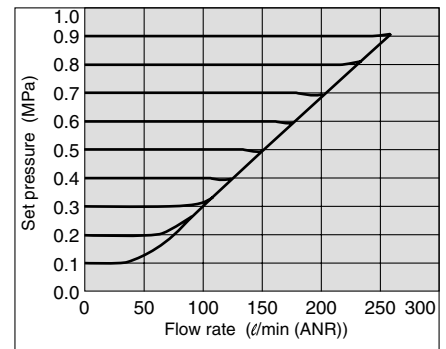

Series ITV205

Linearity

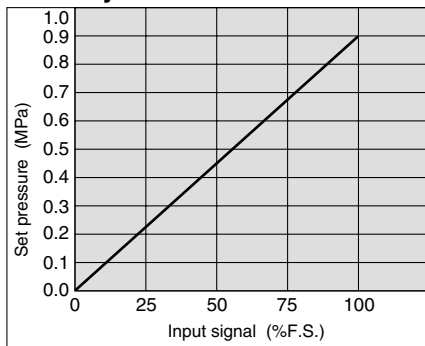

Hysteresis

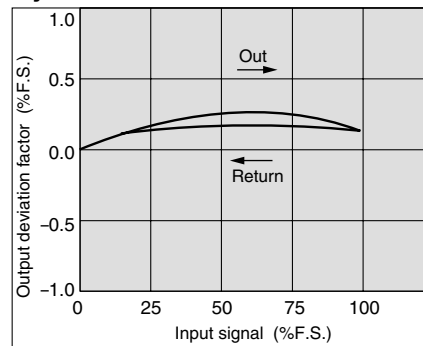

Repeatability

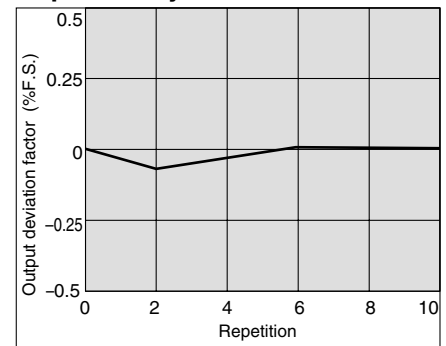

Pressure Characteristics

Set pressure: 0.4 MPa

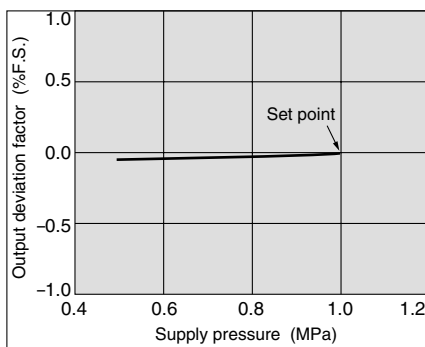

Flow Characteristics

Supply pressure: 1.0 MPa

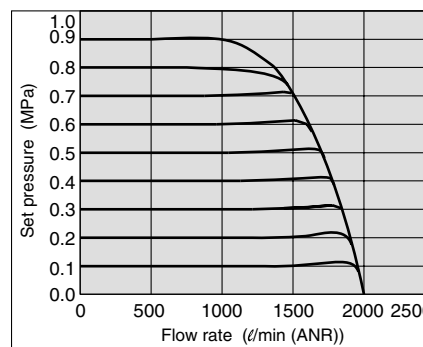

Relief Flow Characteristics

Supply pressure: 1.0 MPa

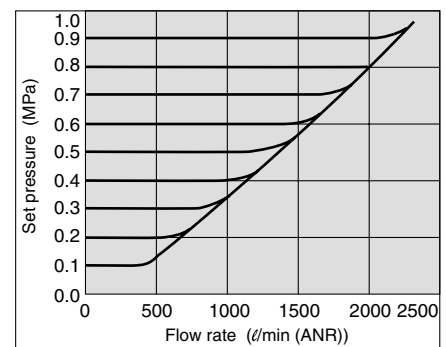

F.R.L.

AV

AU

AF

AR

IR

VEX

AMR

ITV

IC

VBA

VE

VY1

G

PPA

AL

Series ITV1000/2000/3000

Series ITV305

Linearity

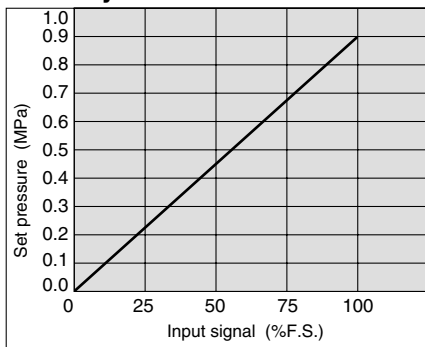

Hysteresis

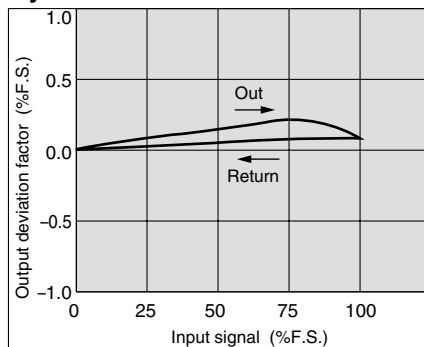

Repeatability

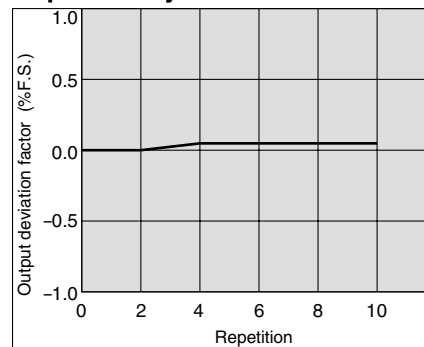

Pressure Characteristics

Set pressure:
0.4 MPa

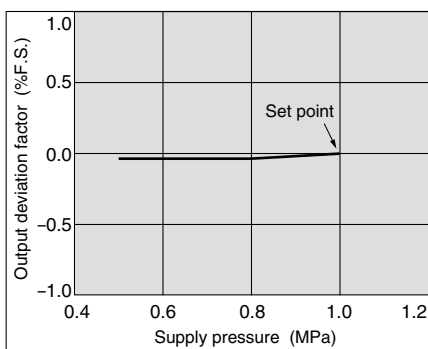

Flow Characteristics

Supply pressure:
1.0 MPa

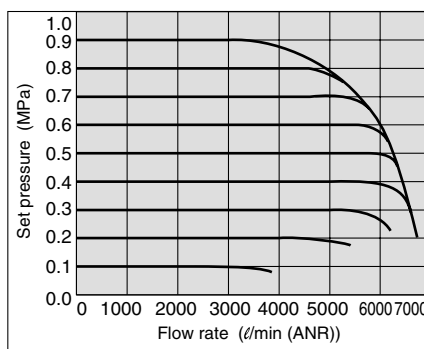

Relief Flow Characteristics

Supply pressure:
1.0 MPa

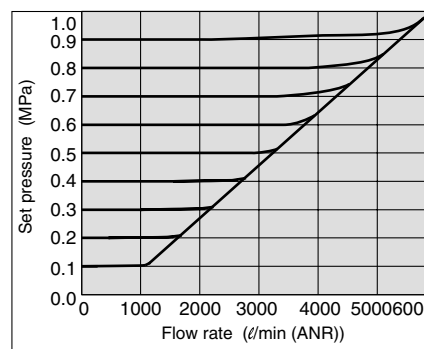

Electro-pneumatic Regulator Series *ITV1000/2000/3000*

Dimensions

ITV10□□ Flat bracket

Note) Do not attempt to rotate, as the cable connector does not turn.

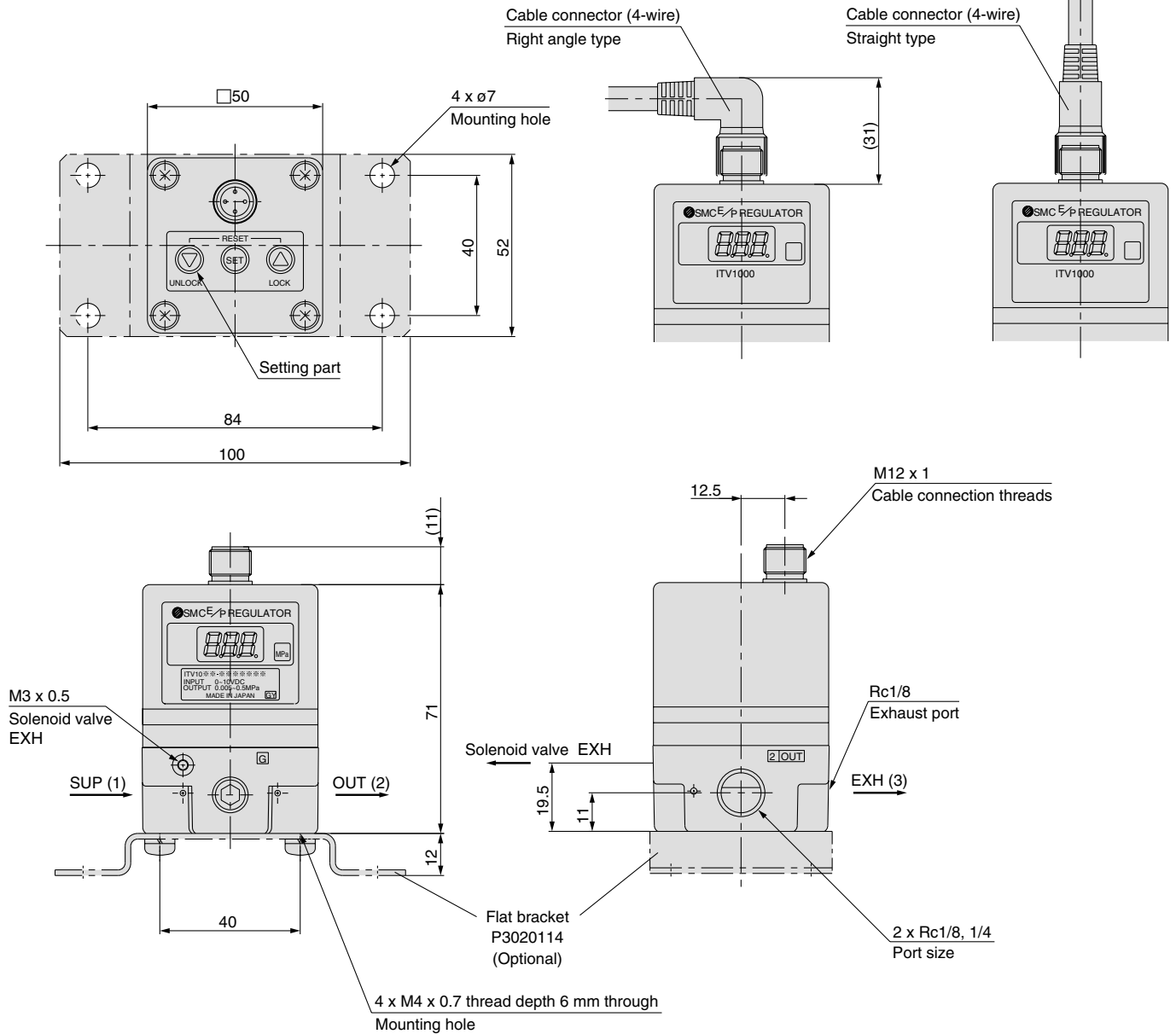

L-bracket

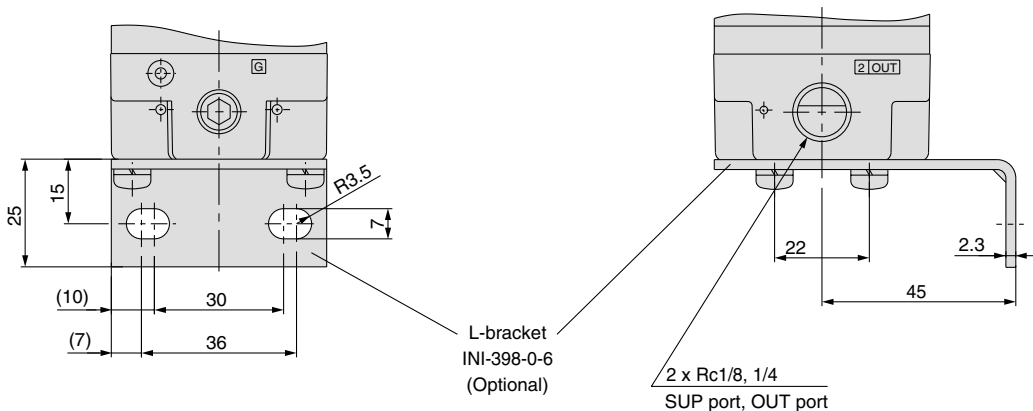

- F.R.L.
- AV
- AU
- AF
- AR
- IR
- VEX
- AMR
- ITV**
- IC
- VBA
- VE□
- VY1
- G
- PPA
- AL

Series ITV1000/2000/3000

Dimensions

ITV20□□ Flat bracket

Note) Do not attempt to rotate, as the cable connector does not turn.

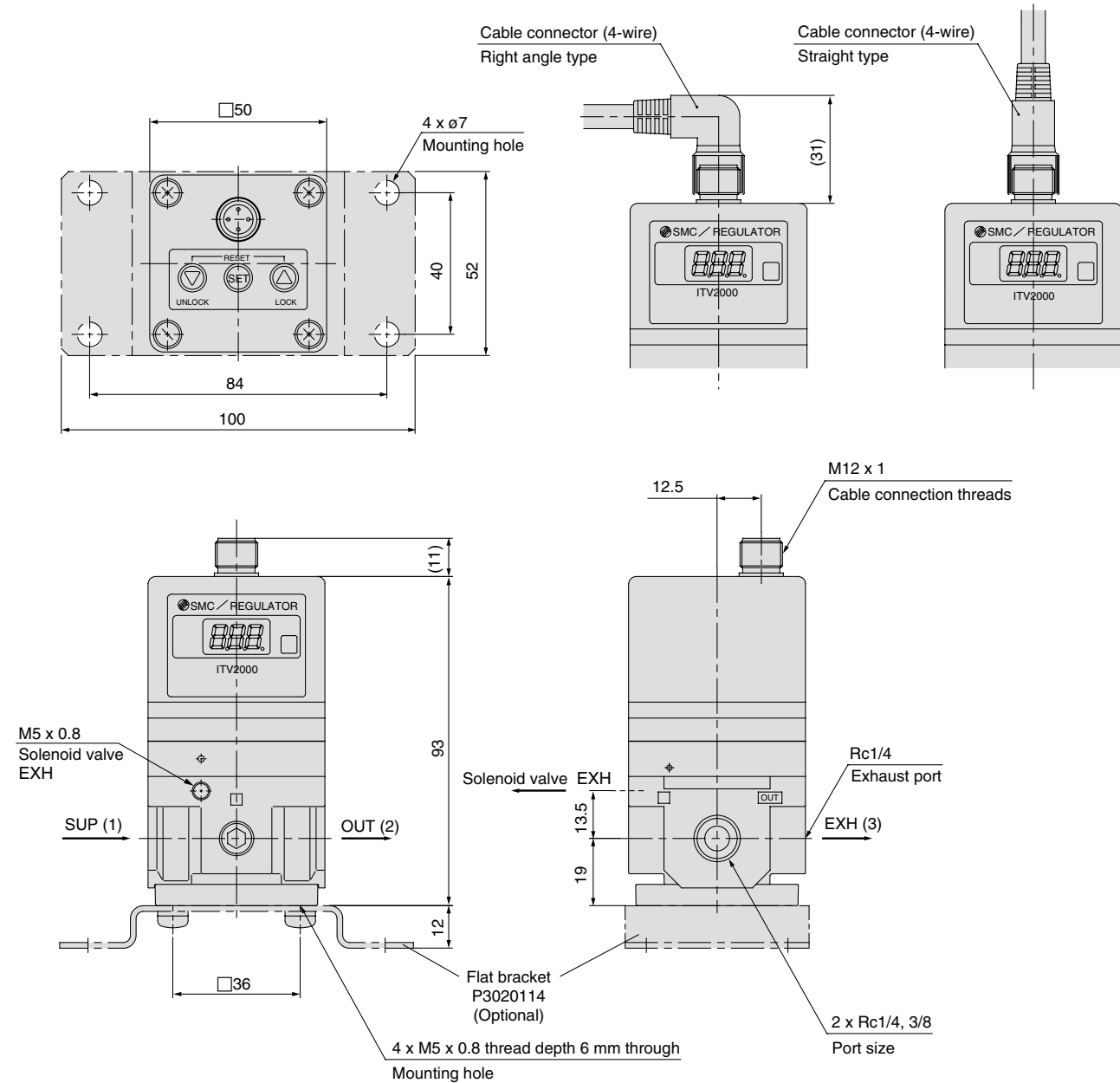

L-bracket

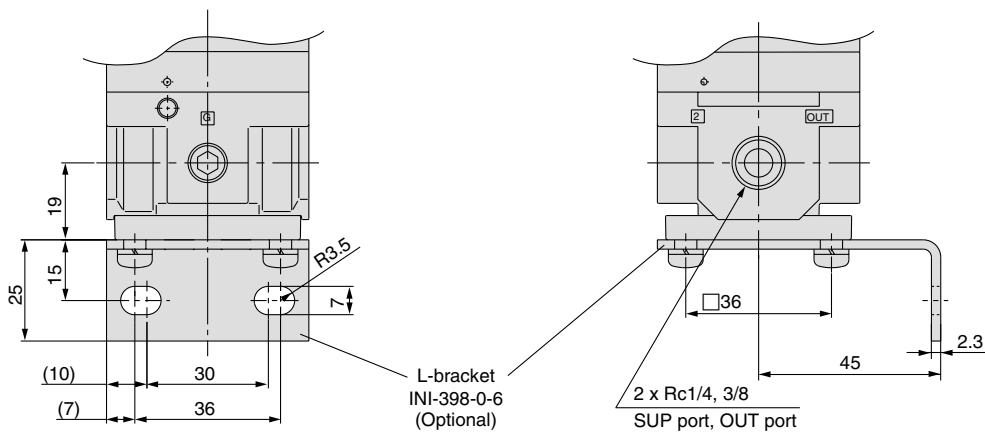

Electro-pneumatic Regulator Series ITV1000/2000/3000

Dimensions

ITV30□□ Flat bracket

Note) Do not attempt to rotate, as the cable connector does not turn.

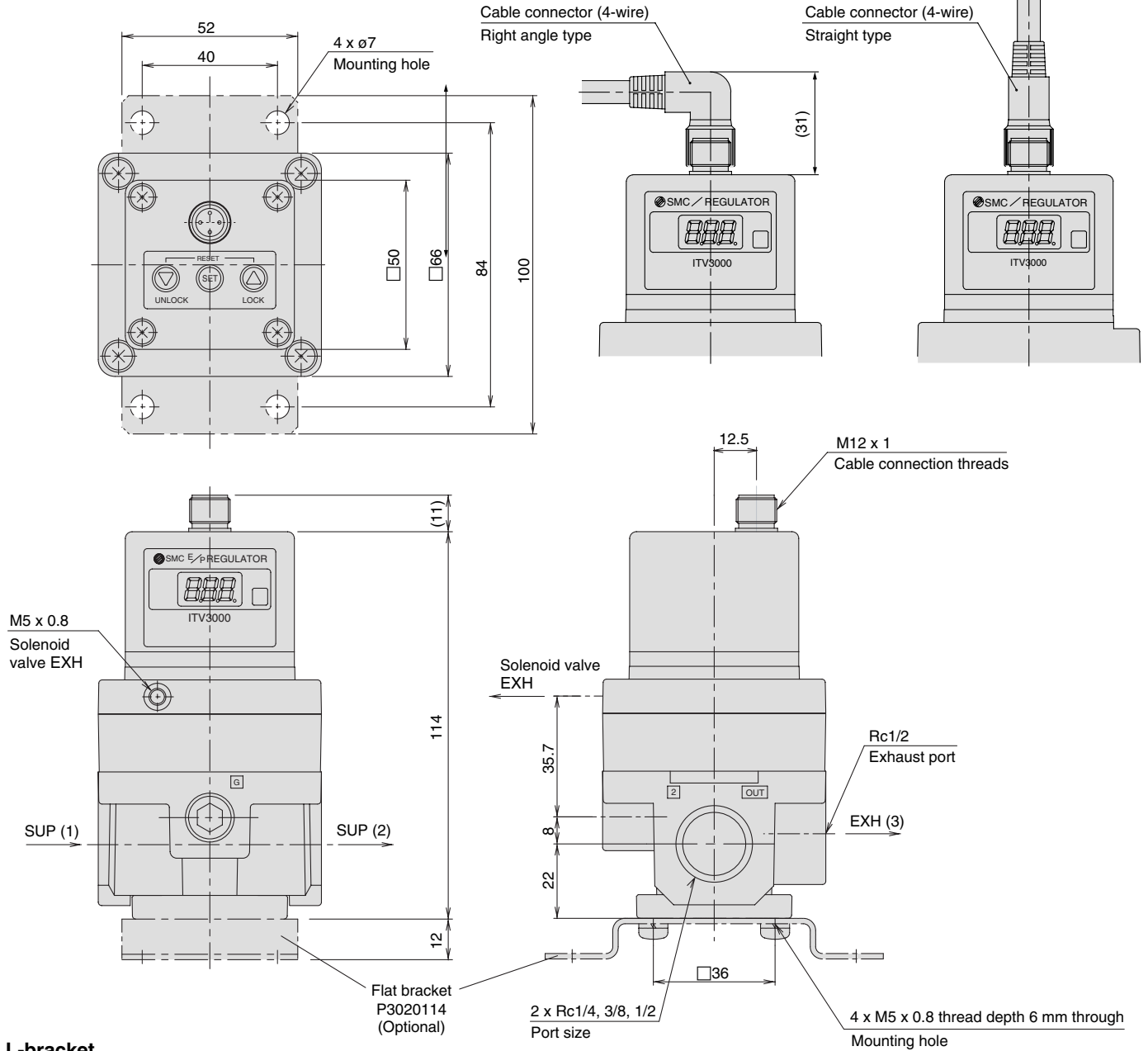

L-bracket

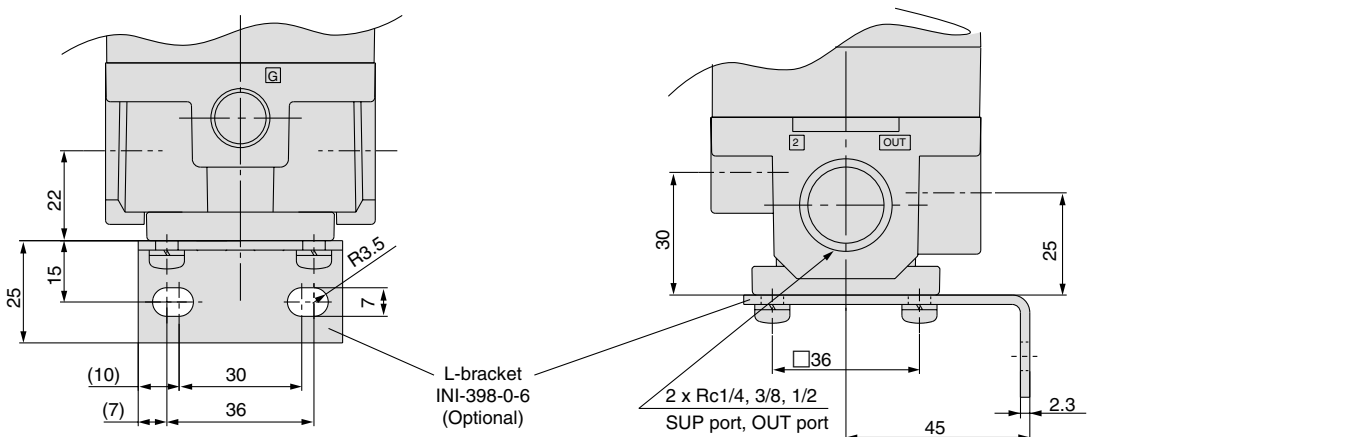

F.R.L.

AV

AU

AF

AR

IR

VEX

AMR

ITV

IC

VBA

VE□

VY1

G

PPA

AL



Specific Product Precautions 1

Be sure to read before handling.

Operating Environment

Warning

1. Employ suitable protective measures in locations where there is contact with water droplets, oil or welding spatter, etc.
2. Consult SMC when used in power plants, or if instrumentation related.

Air Supply

Caution

1. Install an air filter near this product on the supply side. Select a filtration degree of 5 μm or less.
2. Compressed air containing large amounts of drainage can cause malfunction of this product and other pneumatic equipment. As a countermeasure, install an aftercooler, air dryer or Drain Catch, etc.
3. If large amounts of carbon dust are generated by the compressor, it can accumulate inside this product and cause malfunction.

For details on the above compressed air quality, refer to Best Pneumatics Vol. 16.

Handling

Caution

1. Do not use a lubricator on the supply side of this product, as this can cause malfunction. When lubrication of terminal equipment is necessary, connect a lubricator on the output side of this equipment.
2. If electric power is shut off while pressure is being applied, pressure will be retained on the output side.
However, this output pressure is held only temporarily and is not guaranteed. If exhausting of this pressure is desired, shut off the power after reducing the set pressure, and discharge the air using a residual pressure exhaust valve, etc.
3. If power to this product is cut off due to a power failure, etc. when it is in a controlled state, output pressure will be retained temporarily. Handle carefully when operating with output pressure released to the atmosphere, as air will continue to flow out.

Handling

Caution

4. If supply pressure to this product is interrupted while the power is still on, the internal solenoid valve will continue to operate and a humming noise may be generated. Since the life of the product may be shortened, shut off the power supply also when supply pressure is shut off.
5. In this product, the output side pressure cannot be completely relieved within the range of 0.005 MPa or less. If it is desired to reduce the pressure completely to 0 MPa, install a 3 way valve or other device on the output side to exhaust the pressure.
6. This product is adjusted for each specification at the time of shipment from the factory. Avoid careless disassembly or removal of parts, as this can lead to malfunction.
7. The optional cable connector is a 4 wire type. When the monitor output (analog output or switch output) is not being used, keep it from touching the other wires as this can cause malfunction.
8. Please note that the right angle cable does not rotate and is limited to only one entry direction.
9. Take the following steps to avoid malfunction due to noise.
 - 1) Remove power supply noise during operation by installing a line filter, etc. in the AC power line.
 - 2) For avoiding the influence of noise install this product and its wiring as far as possible from strong electric fields such as those of motors and power lines, etc.
 - 3) Be sure to implement protective measures against load surge for induction loads (solenoid valves, relays, etc.).
 - 4) Install or remove the connector after shutting off the power supply to avoid the influence of chattering of the power supply.
10. Due to the large volume of the output side, a loud exhaust noise will be produced when being used for the purpose of a relief function. Therefore, install a silencer (SMC Series AN200 or AN400) on the exhaust port (EXH port). The port sizes are Rc1/8, Rc1/4 and Rc1/2.
11. Specifications on page 1 is in case of static environment. Pressure may fluctuate when air is consumed at the output side.
12. For details on the handling of this product, refer to the instruction manual which is included with the product.



Series ITV1000/2000/3000

Specific Product Precautions 2

Be sure to read before handling.

Wiring

⚠ Caution

Connect the cable to the connector on the body with the wiring arranged as shown below. Proceed carefully, as incorrect wiring can cause damage. Further, use DC power with sufficient capacity and a low ripple.

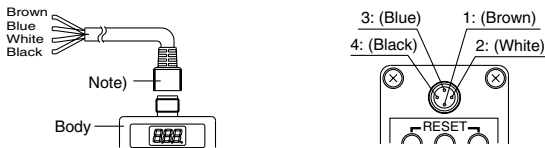

Current signal type

Voltage signal type

1	Brown	Power supply
2	White	Input signal
3	Blue	GND (COMMON)
4	Black	Monitor output

Preset input type

1	Brown	Power supply
2	White	Input signal
3	Blue	GND (COMMON)
4	Black	Monitor output

Note) A right angle type cable is also available. The entry direction for the right angle type connector is to the left (SUP port side). Never turn the connector as it is not designed to turn.

Wiring diagram

Current signal type

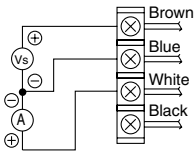

Vs: Power supply 24 VDC
12 to 15 VDC
A : Input signal 4 to 20 mADC
0 to 20 mADC

Voltage signal type

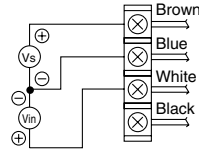

Vs : Power supply 24 VDC
12 to 15 VDC
Vin: Input signal 0 to 5 VDC
0 to 10 VDC

Preset input type

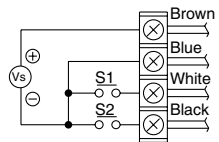

Vs: Power supply 24 VDC
12 to 15 VDC

One of the preset pressures P1 through P4 is selected by the ON/OFF combination of S1 and S2.

S1	OFF	ON	OFF	ON
S2	OFF	OFF	ON	ON
Preset pressure	P1	P2	P3	P4

* For safety reasons, it is recommended that one of the preset pressures be set to 0 MPa.

Monitor output wiring diagram

Analog output, voltage type

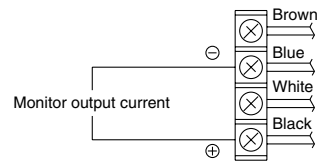

Switch output, NPN type

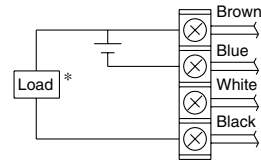

Switch output, PNP type

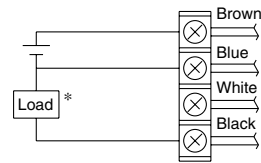

Analog output, current type (sink type)

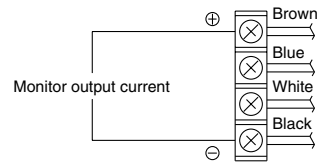

* When 30 mA DC or more is applied, detecting device for overcurrent starts activating and then emits an error signal. (Error number "5")

Set Pressure Range

The regulating pressure range, by unit of standard measured pressure, is shown in the table below.

Regulating pressure range, by unit of standard measured pressure

Unit	Regulating pressure range		
	ITV□01□	ITV□03□	ITV□05□
MPa	0.005 to 0.1	0.005 to 0.5	0.005 to 0.9
kgf/cm ²	0.05 to 1	0.05 to 5	0.05 to 9
bar	0.05 to 1	0.05 to 5	0.05 to 9
PSI	0.7 to 15	0.7 to 70	0.7 to 130
kPa	5 to 100	5 to 500	5 to 900

F.R.L.

AV

AU

AF

AR

IR

VEX

AMR

ITV

IC

VBA

VE□

VY1

G

PPA

AL

Electronic Vacuum Regulator

Series *ITV2090/2091*

■ Stepless control of vacuum pressure in proportion to an electric signal



Straight type

Right angle type

Piping/Wiring Diagram

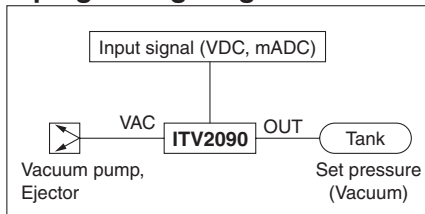

Standard Specifications

Model		ITV2090	ITV2091
Power supply	Voltage	24 VDC ±10%	12 to 15 VDC
	Current consumption	Power supply voltage 24 VDC type: 0.12 A or less Power supply voltage 12 to 15 VDC type: 0.18 A or less	
Minimum supply vacuum pressure ⁽¹⁾		Set pressure -13.3 kPa	
Maximum supply vacuum pressure		-101 kPa	
Regulating pressure range		-1.3 to -80 kPa	
Input signal	Current type ⁽²⁾	4 to 20 mA, 0 to 20 mA	
	Voltage type	0 to 5 VDC, 0 to 10 VDC	
	Preset input	4 points	
Input impedance	Current type	250 Ω or less	
	Voltage type	Approximately 6.5 kΩ	
	Preset input	Approximately 2.7 kΩ	
Output signal ⁽³⁾ (Monitor output)	Analog output	1 to 5 VDC (Load impedance: 1 kΩ or more) 4 to 20 mA (Sink type) (Load impedance: 250 Ω or less)	
	Switch output	NPN open collector output: Max. 30 V, 30 mA PNP open collector output: Max. 30 mA	
Linearity		Within ±1% (Full span)	
Hysteresis		Within 0.5% (Full span)	
Repeatability		Within ±0.5% (Full span)	
Sensitivity		Within 0.2% (Full span)	
Temperature characteristics		Within ±0.12% (Full span)/°C	
Output pressure display	Accuracy	±3% (Full span)	
	Units	kPa ⁽⁴⁾ Minimum display: 1	
Ambient and fluid temperature		0 to 50°C (With no condensation)	
Enclosure		IP65 equivalent	
Weight		350 g	

- Note 1) The minimum supply vacuum pressure should be 13.3 kPa less than the maximum vacuum pressure setting value.
- Note 2) 4 to 20 mA is not possible with the 2-wire type. Power supply voltage (24 VDC or 12 to 15 VDC) is required.
- Note 3) Either analog output or switch output must be selected. Furthermore, when switch output is selected, either NPN output or PNP output must also be selected. Use caution that the preset input type is not equipped with an output signal function.
- Note 4) Please contact SMC regarding indication with other units of pressure.

How to Order

ITV 209 0 0 1 2 S 5

- Pressure range**
 - 9: -1.3 to -80 kPa
- Power supply voltage**
 - 0: 24 VDC
 - 1: 12 to 15 VDC
- Input signal**
 - 0: Current type 4 to 20 mADC
 - 1: Current type 0 to 20 mADC
 - 2: Voltage type 0 to 5 VDC
 - 3: Voltage type 0 to 10 VDC
 - 4*: Preset input
- Monitor output**
 - 0*: None (For preset input)
 - 1: Analog output 1 to 5 VDC
 - 2*: Switch output/NPN output
 - 3*: Switch output/PNP output
 - 4*: Analog output 4 to 20 mADC
- Thread type**
 - Nil: Rc
 - N*: NPT
 - T*: NPTF
 - F*: G
- Port size**
 - 2: 1/4
- Pressure display unit**
 - 5: kPa
- Cable connector type**
 - S: Straight type 3 m
 - L*: Right angle type 3 m
 - N*: Without cable connector
- Option (Bracket)**
 - Nil: Without bracket
 - B*: Flat bracket
 - C*: L-bracket

* Option

Working Principle

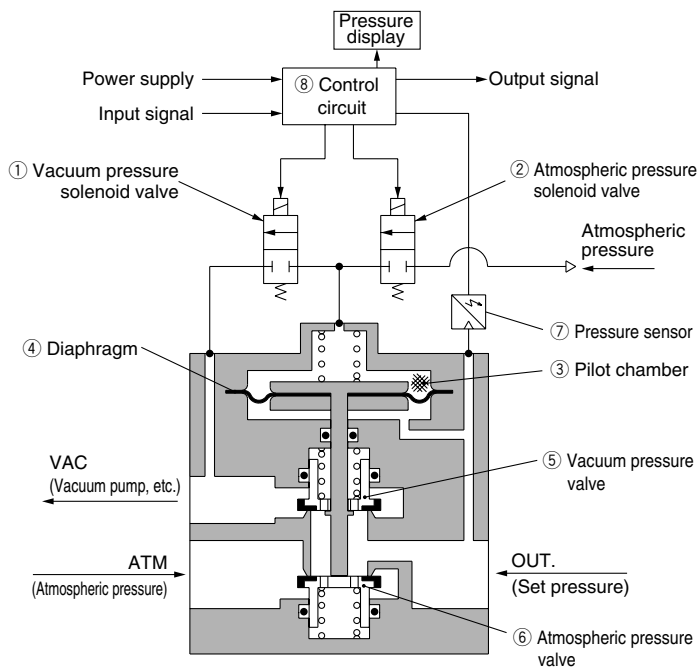

Working Principle

When the input signal increases, the vacuum pressure solenoid valve ① turns ON, and the atmospheric pressure solenoid valve ② turns OFF. Because of this, VAC and the pilot chamber ③ are connected, the pressure in the pilot chamber ③ becomes negative and acts on the top of the diaphragm.

As a result, the vacuum pressure valve ⑤ which is linked to the diaphragm ④ opens, VAC and OUT are connected, and the set pressure becomes negative.

This negative pressure feeds back to the control circuit ⑧ via the pressure sensor ⑦. Then, a correct operation works until a vacuum pressure proportional to the input signal is reached, and a vacuum pressure is obtained which is always proportional to the input signal.

Block Diagram

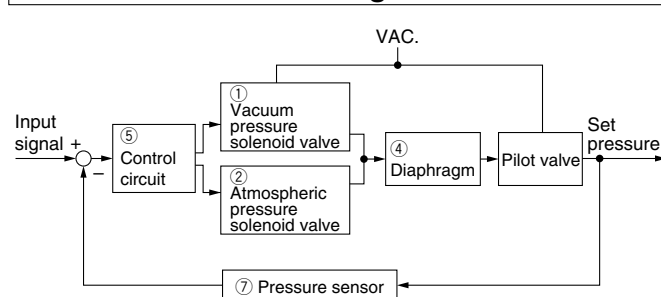

Series ITV209

Linearity

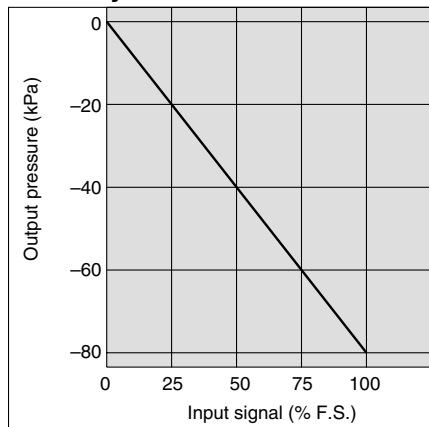

Hysteresis

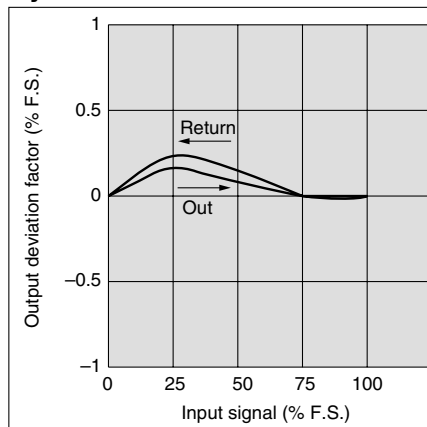

Repeatability

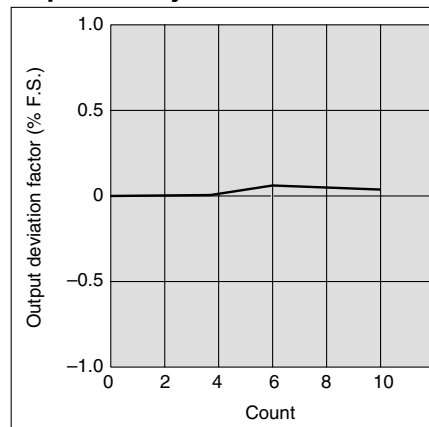

Pressure Characteristics

Set pressure: -20 kPa

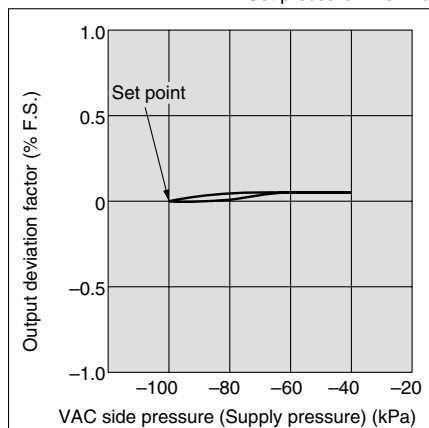

Flow Characteristics

Supply pressure: -100 kPa

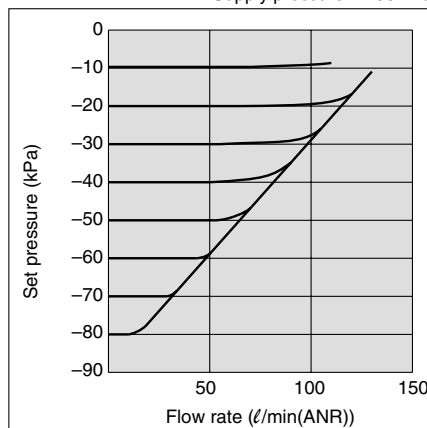

Flow characteristics measurement conditions

- Exhaust flow rate of the vacuum pump used for measurement: 500 l/min (ANR)
- Inlet vacuum pressure: -100 kPa (When outlet flow rate is 0 l/min (ANR))
- Maximum flow rate: 132 l/min (ANR) (With inlet vacuum pressure at -39 kPa)

F.R.L.

AV

AU

AF

AR

IR

VEX

AMR

ITV

IC

VBA

VE

VY1

G

PPA

AL

Dimensions

ITV2090



Note) Do not attempt to rotate the cable connector, as it does not turn.

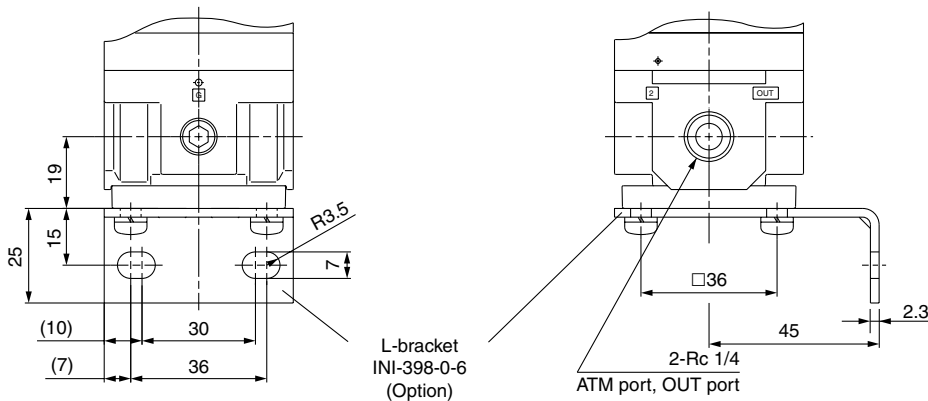
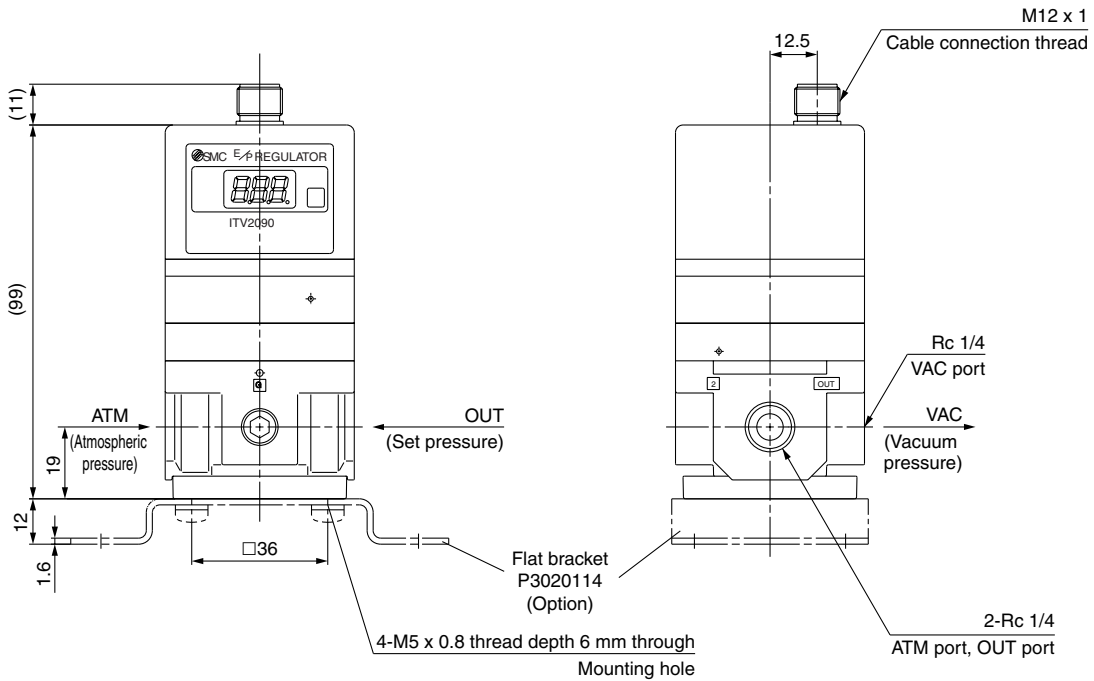
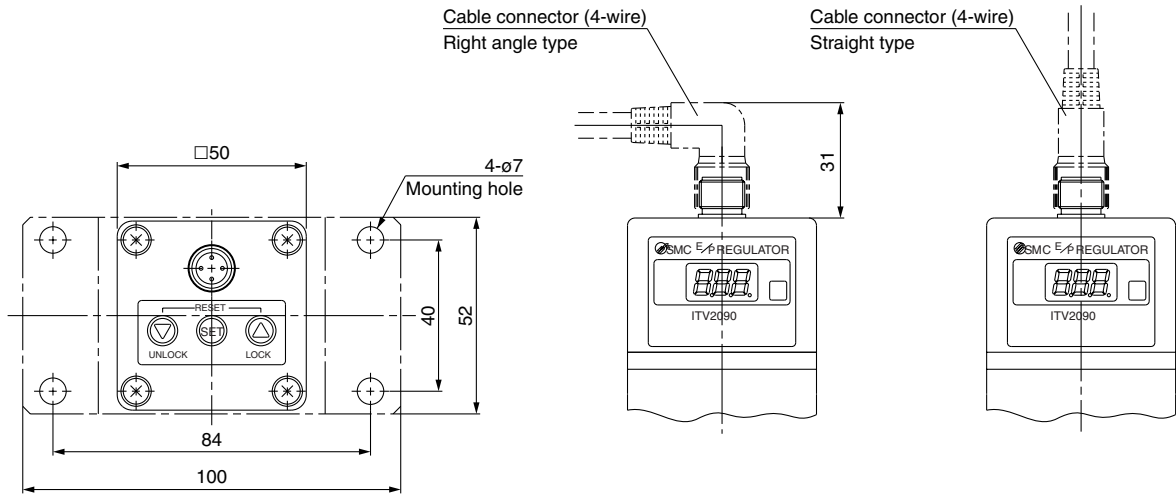

Accessory (Option)/Part No.

Description		Part no.
Flat bracket		P3020114
L-bracket		INI-398-0-6
Cable connector	Straight type	TM-4DSX3HG4
	Right angle type	TM-4DLX3HG4

Dimensions Flat bracket

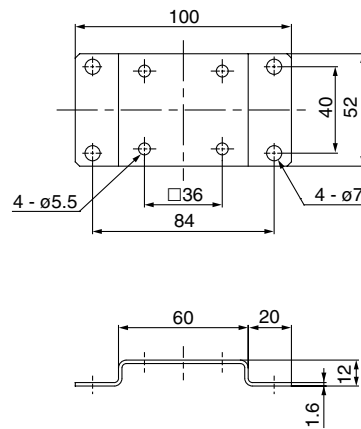

L-bracket

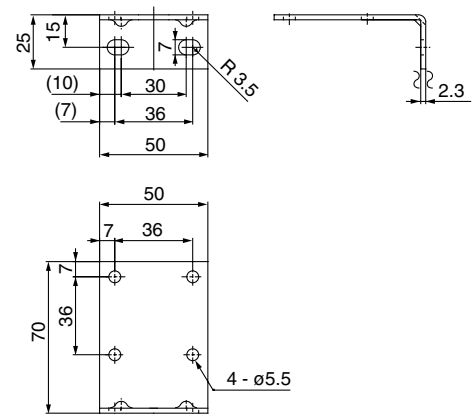

⚠ Precautions

Be sure to read before handling. Refer to pages 14-21-3 to 14-21-4 for Safety Instructions and Common Precautions.

Handling

⚠ Caution

- Connect the vacuum pump to the port, which is labeled "VAC".
- Pressure adjustment changes from "atmospheric pressure to vacuum pressure" when the input signal is increased, and from "vacuum pressure to atmospheric pressure" when the input signal is decreased.
- When adjusting the vacuum pressure, be careful not to block the atmospheric pressure inlet port labeled "ATM".
- Since this product is designed exclusively for use with negative pressure, be careful not to apply positive pressure in error.
- In cases where the vacuum pump being used has a relatively small capacity, or the piping has a small inside diameter, etc., large variations in the set pressure (the range of pressure variation when changing from no flow to flow state) may appear. In this situation, the vacuum pump or the piping, etc. should be changed. In cases where it is not practical to change the vacuum pump, install a capacity tank (volume depending on the operating conditions) on the VAC side.
- The vacuum pressure response time after a change in the input signal is influenced by the internal volume on the setting side (including piping). Since the capacity of the vacuum pump also influences the response time, give careful consideration to these points before operation.
- If the electric power is shut off when in a control state, the pressure on the setting side will go into a holding condition. However, this setting side pressure will be held only temporarily and is not guaranteed. In addition, when atmospheric pressure is desired, shut off the power after reducing the set pressure, and then introduce atmospheric pressure by using a vacuum release valve, etc.
- If the power for this product is cut off by a power failure, etc. when it is in a controlled state, the setting side pressure will be held temporarily. Further, if operated without sealing the setting side so that atmospheric air is sucked in, handle with care as air will continue to be sucked in.
- If the VAC side pressure to this product is interrupted while the power is still on, the internal solenoid valve will continue to operate and may cause a humming noise. Since this may shorten the life of the product, be sure to shut off the power when the VAC side pressure is shut off.
- The setting side pressure cannot be completely released from this product in the range below -1.3 kPa. In cases where the pressure needs to be reduced completely to 0 kPa, install a 3 port valve, etc. on the setting side to discharge the residual pressure.
- This product is adjusted for each specification at the factory before shipment. Avoid careless disassembly or removal of parts, as this can cause failure.
- The optional cable connector is a 4-wire type. When the monitor output (analog output, switch output) is not being used, keep it from touching the other wires, as this can cause malfunction.
- Use caution that the right angle cable does not rotate and is limited to only one entry direction.
- Take the following steps to avoid malfunction due to noise.
 - Eliminate power supply noise during operation by installing a line filter, etc. in the AC power line.
 - Install this product so that it will not be effected by noise, keeping the product and its wiring away from strong electric field sources such as motors and power lines.
 - Make sure to take protective measures against load surge for an induction load (solenoid valves, relays, etc.).
- Refer to the instruction manual included with the product for details on its handling.

⚠ Precautions

Be sure to read before handling. Refer to pages 14-21-3 to 14-21-4 for Safety Instructions and Common Precautions.

Wiring

⚠ Caution

Connect the cable to the connector on the body with the wiring arranged as shown below. Proceed carefully, as incorrect wiring can cause damage. Further, use DC power with sufficient capacity and a low ripple.



Current Signal Type Voltage Signal Type

1	Brown	Power supply
2	White	Input signal
3	Blue	GND (COMMON)
4	Black	Monitor output

Preset Input Type

1	Brown	Power supply
2	White	Input signal 1
3	Blue	GND (COMMON)
4	Black	Input signal 2

Note) A right angle type cable is also available. The entry direction for the right angle type connector is to the left (SUP port side). Never rotate it, since it's not designed to turn.

Wiring diagram

Current signal type

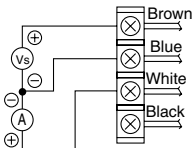

Vs : Power supply 24 VDC
12 to 15 VDC
A : Input signal 4 to 20 mADC
0 to 20 mADC

Voltage signal type

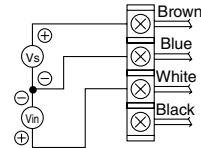

Vs : Power supply 24 VDC
12 to 15 VDC
Vin: Input signal 0 to 5 VDC
0 to 10 VDC

Preset input type

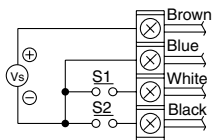

Vs : Power supply 24 VDC
12 to 15 VDC

One of the preset pressures P1 through P4 is selected by the ON/OFF combination of S1 and S2.

S1	OFF	ON	OFF	ON
S2	OFF	OFF	ON	ON
Preset pressure	P1	P2	P3	P4

* For safety reasons, it is recommended that one of the preset pressures be set to 0 MPa.

Monitor output wiring diagram

Analog output: Voltage type

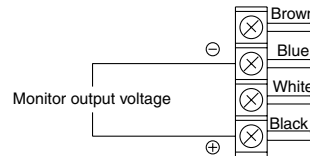

Switch output: NPN type

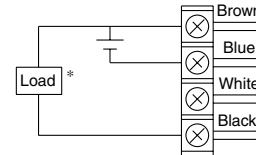

Switch output: PNP type

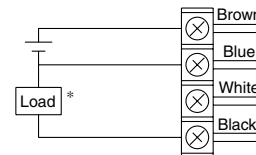

Analog output: Current type

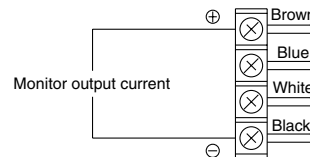



* When 30 mADC or more is applied, detecting device for overcurrent starts activating and then emits an error signal. (Error number "5")



Safety Instructions

These safety instructions are intended to prevent a hazardous situation and/or equipment damage. These instructions indicate the level of potential hazard by labels of "Caution", "Warning" or "Danger". To ensure safety, be sure to observe ISO 4414 ^{Note 1)}, JIS B 8370 ^{Note 2)} and other safety practices.

 **Caution** : Operator error could result in injury or equipment damage.

 **Warning** : Operator error could result in serious injury or loss of life.

 **Danger** : In extreme conditions, there is a possible result of serious injury or loss of life.

Note 1) ISO 4414: Pneumatic fluid power--General rules relating to systems.

Note 2) JIS B 8370: General Rules for Pneumatic Equipment

Warning

1. The compatibility of pneumatic equipment is the responsibility of the person who designs the pneumatic system or decides its specifications.

Since the products specified here are used in various operating conditions, their compatibility for the specific pneumatic system must be based on specifications or after analysis and/or tests to meet your specific requirements. The expected performance and safety assurance will be the responsibility of the person who has determined the compatibility of the system. This person should continuously review the suitability of all items specified, referring to the latest catalog information with a view to giving due consideration to any possibility of equipment failure when configuring a system.

2. Only trained personnel should operate pneumatically operated machinery and equipment.

Compressed air can be dangerous if an operator is unfamiliar with it. Assembly, handling or repair of pneumatic systems should be performed by trained and experienced operators.

3. Do not service machinery/equipment or attempt to remove components until safety is confirmed.

1. Inspection and maintenance of machinery/equipment should only be performed once measures to prevent falling or runaway of the driver objects have been confirmed.
2. When equipment is to be removed, confirm the safety process as mentioned above. Cut the supply pressure for this equipment and exhaust all residual compressed air in the system.
3. Before machinery/equipment is restarted, take measures to prevent shooting-out of cylinder piston rod, etc.

4. Contact SMC if the product is to be used in any of the following conditions:

1. Conditions and environments beyond the given specifications, or if product is used outdoors.
2. Installation on equipment in conjunction with atomic energy, railway, air navigation, vehicles, medical equipment, food and beverages, recreation equipment, emergency stop circuits, clutch and brake circuits in press applications, or safety equipment.
3. An application which has the possibility of having negative effects on people, property, or animals, requiring special safety analysis.



Common Precautions

Be sure to read before handling.

For detailed precautions on every series, refer to main text.

Selection

Warning

1. Confirm the specifications.

Products represented in this catalog are designed for use in compressed air applications only (including vacuum), unless otherwise indicated.

Do not use the product outside their design parameters.

Please contact SMC when using the products in applications other than compressed air (including vacuum).

Mounting

Warning

1. Instruction manual

Install the products and operate them only after reading the instruction manual carefully and understanding its contents. Also keep the manual where it can be referred to as necessary.

2. Securing the space for maintenance

When installing the products, please allow access for maintenance.

3. Tightening torque

When installing the products, please follow the listed torque specifications.

Piping

Caution

1. Before piping

Make sure that all debris, cutting oil, dust, etc., are removed from the piping.

2. Wrapping of pipe tape

When screwing piping or fittings into ports, ensure that chips from the pipe threads or sealing material do not get inside the piping. Also, when the pipe tape is used, leave 1.5 to 2 thread ridges exposed at the end of the threads.

Air Supply

Warning

1. Operating fluid

Please consult with SMC when using the product in applications other than compressed air (including vacuum).

Regarding products for general fluid, please ask SMC about applicable fluids.

2. Install an air dryer, aftercooler, etc.

Excessive condensate in a compressed air system may cause valves and other pneumatic equipment to malfunction.

Installation of an air dryer, after cooler etc. is recommended.

3. Drain flushing

If condensate in the drain bowl is not emptied on a regular basis, the bowl will over flow and allow the condensate to enter the compressed air lines.

If the drain bowl is difficult to check and remove, it is recommended that a drain bowl with the auto-drain option be installed.

For compressed air quality, refer to "Air Preparation Equipment" catalog.

4. Use clean air

If the compressed air supply is contaminated with chemicals, synthetic materials, corrosive gas, etc., it may lead to break down or malfunction.

Operating Environment

Warning

1. Do not use in environments where the product is directly exposed to corrosive gases, chemicals, salt water, water or steam.

2. Do not expose the product to direct sunlight for an extended period of time.

3. Do not use in a place subject to heavy vibrations and/or shocks.

4. Do not mount the product in locations where it is exposed to radiant heat.

Maintenance

Warning

1. Maintenance procedures are outlined in the operation manual.

Not following proper procedures could cause the product to malfunction and could lead to damage to the equipment or machine.

2. Maintenance work

If handled improperly, compressed air can be dangerous.

Assembly, handling and repair of pneumatic systems should be performed by qualified personnel only.

3. Drain flushing

Remove drainage from air filters regularly. (Refer to the specifications.)

4. Shut-down before maintenance

Before attempting any kind of maintenance make sure the supply pressure is shut of and all residual air pressure is released from the system to be worked on.

5. Start-up after maintenance and inspection

Apply operating pressure and power to the equipment and check for proper operation and possible air leaks. If operation is abnormal, please verify product set-up parameters.

6. Do not make any modifications to be product.

Do not take the product apart.

Quality Assurance Information (ISO 9001, ISO 14001)

Reliable quality of products in the global market

To enable our customers throughout the world to use our products with even greater confidence, SMC has obtained certification for international standards “ISO 9001” and “ISO 14001”, and created a complete structure for quality assurance and environmental controls. SMC products pursue to meet its customers’ expectations while also considering company’s contribution in society.

Quality management system ISO 9001

This is an international standard for quality control and quality assurance. SMC has obtained a large number of certifications in Japan and overseas, providing assurance to our customers throughout the world.



Environmental management system ISO 14001

This is an international standard related to environmental management systems and environmental inspections. While promoting environmentally friendly automation technology, SMC is also making diligent efforts to preserve the environment.



SMC’s quality control system



Quality policies

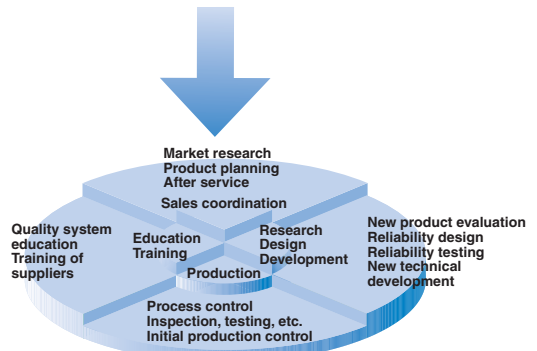

Quality control activities

SMC Product Conforming to Inter

SMC products complying with EN/ISO, CSA/UL standards are supporting



The CE mark indicates that machines and components meet essential requirements of all the EC Directives applied.

It has been obligatory to apply CE marks indicating conformity with EC Directives when machines and components are exported to the member Nations of the EU.

Once “A manufacturer himself” declares a product to be safe by means of CE marking (declaration of conformity by manufacturer), free distribution inside the member Nations of the EU is permissible.

■ CE Mark

SMC provides CE marking to products to which EMC and Low Voltage Directives have been applied, in accordance with CETOP (European hydraulics and pneumatics committee) guide lines.

■ As of February 1998, the following 18 countries will be obliged to conform to CE mark legislation

Iceland, Ireland, United Kingdom, Italy, Austria, Netherlands, Greece, Liechtenstein, Sweden, Spain, Denmark, Germany, Norway, Finland, France, Belgium, Portugal, Luxembourg

■ EC Directives and Pneumatic Components

• Machinery Directive

The Machinery Directive contains essential health and safety requirements for machinery, as applied to industrial machines e.g. machine tools, injection molding machines and automatic machines. Pneumatic equipment is not specified in Machinery Directive. However, the use of SMC products that are certified as conforming to EN Standards, allows customers to simplify preparation work of the Technical Construction File required for a Declaration of Conformity.

• Electromagnetic Compatibility (EMC) Directive

The EMC Directive specifies electromagnetic compatibility. Equipment which may generate electromagnetic interference or whose function may be compromised by electromagnetic interference is required to be immune to electromagnetic affects (EMS/immunity) without emitting excessive electromagnetic affects (EMI/emission).

• Low Voltage Directive

This directive is applied to products, which operate above 50 VAC to 1000 VAC and 75 VDC to 1500 VDC operating voltage, and require electrical safety measures to be introduced.

• Simple Pressure Vessels Directive

This directive is applied to welded vessels whose maximum operating pressure (PS) and volume of vessel (V) exceed 50 bar/L. Such vessels require EC type examination and then CE marking.

national Standards

you to comply with EC directives and CSA/UL standards.



■ CSA Standards & UL Standards

UL and CSA standards have been applied in North America (U.S.A. and Canada) symbolizing safety of electric products, and are defined to mainly prevent danger from electric shock or fire, resulting from trouble with electric products. Both UL and CSA standards are acknowledged in North America as the first class certifying body. They have a long experience and ability for issuing product safety certificate. Products approved by CSA or UL standards are accepted in most states and governments beyond question.

Since CSA is a test certifying body as the National Recognized Testing Laboratory (NRTL) within the jurisdiction of Occupational Safety and Health Administration (OSHA), SMC was tested for compliance with CSA Standards and UL Standards at the same time and was approved for compliance with the two Standards. The above CSA NRTL/C logo is described on a product label in order to indicate that the product is approved by CSA and UL Standards.

■ TSSA (MCCR) Registration Products

TSSA is the regulation in Ontario State, Canada. The products that the operating pressure is more than 5 psi (0.03 MPa) and the piping size is bigger than 1 inch. fall into the scope of TSSA regulation.

Products conforming to CE Standard



With CE symbol for simple visual recognition

In this catalog each accredited product series is indicated with a CE mark symbol. However, in some cases, every available models may not meet CE compliance. Please visit our web site for the latest selection of available models with CE mark.

<http://www.smcworld.com>

SMC's Global Service Network

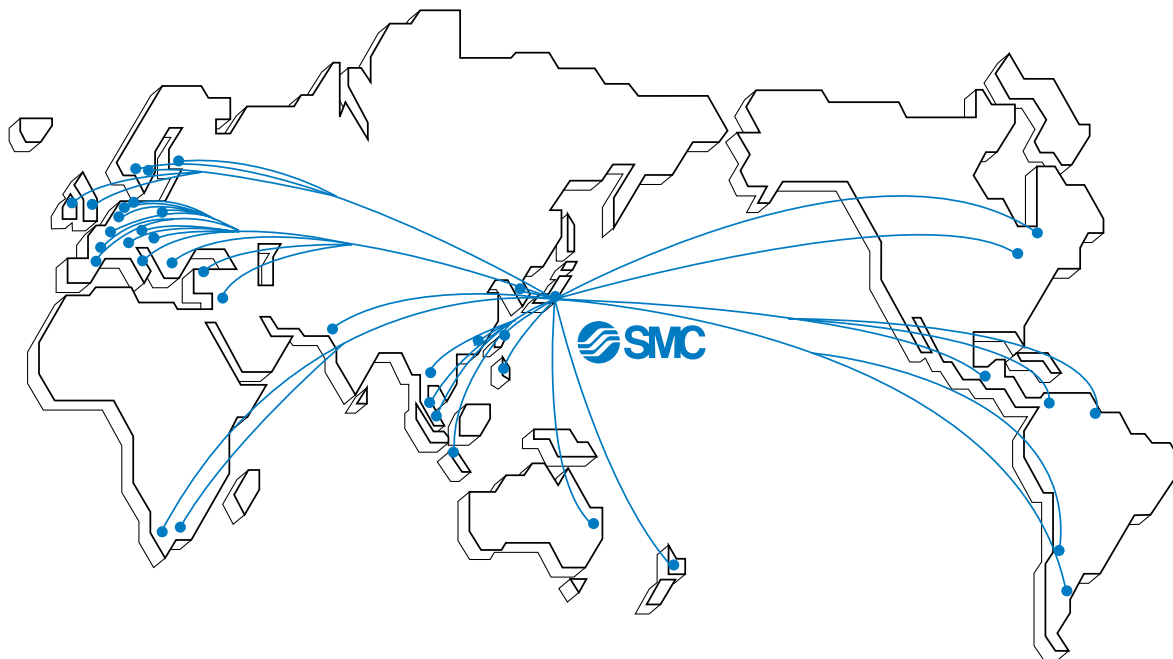

America

U.S.A. **SMC Corporation of America**

3011 North Franklin Road Indianapolis, IN 46226, U.S.A.
TEL: 317-899-4440 FAX: 317-899-3102

CANADA **SMC Pneumatics (Canada) Ltd.**

6768 Financial Drive Mississauga, Ontario, L5N 7J6 Canada
TEL: 905-812-0400 FAX: 905-812-8686

MEXICO **SMC Corporation (Mexico), S.A. DE C.V.**

Carr. Silao-Trejo K.M. 2.5 S/N, Predio San Jose del Duranzo
C.P. 36100, Silao, Gto., Mexico
TEL: 472-72-2-55-00 FAX: 472-72-2-59-44/2-59-46

CHILE **SMC Pneumatics (Chile) S.A.**

Av. La Montaña 1,115 km. 16.5 P. Norte Parque
Industrial Valle Grande, Lampa Santiago, Chile
TEL: 02-270-8600 FAX: 02-270-8601

ARGENTINA **SMC Argentina S.A.**

Teodoro Garcia 3860 (1427) Buenos Aires, Argentina
TEL: 011-4555-5762 FAX: 011-4555-5762

BOLIVIA **SMC Pneumatics Bolivia S.R.L.**

Avenida Beni Numero 4665
Santa Cruz de la Sierra-Casilla de Correo 2281, Bolivia
TEL: 591-3-3428383 FAX: 591-3-3449900

VENEZUELA **SMC Neumatica Venezuela S.A.**

Apartado 40152, Avenida Nueva Granada, Edificio Wanlac,
Local 5, Caracas 1040-A, Venezuela
TEL: 2-632-1310 FAX: 2-632-3871

PERU (Distributor) **IMPECO Automatizacion Industrial S.A.**

AV. Canevaro 752, Lince, Lima, Peru
TEL: 1-471-6002 FAX: 1-471-0935

URUGUAY (Distributor) **BAKO S.A.**

Galicia 1650 esq. Gaboto C.P. 11200, Montevideo, Uruguay
TEL: 2-401-6603 FAX: 2-409-4306

BRAZIL **SMC Pneumaticos Do Brasil Ltda.**

Rua. Dra. Maria Fidelis, nr. 130, Jardim Piraporinha-Diadema-S.P.
CEP: 09950-350, Brasil
TEL: 11-4051-1177 FAX: 11-4071-6636

COLOMBIA (Distributor) **Airmatic Ltda.**

Calle 18 69-05 Apart. Aereo 081045 Santa Fe de Bogotá, Colombia
TEL: 1-424-9240 FAX: 1-424-9260

Europe

U.K. **SMC Pneumatics (U.K.) Ltd.**

Vincent Avenue, Crownhill, Milton Keynes, MK8 0AN, Buckinghamshire, U.K.
TEL: 01908-563888 FAX: 01908-561185

GERMANY **SMC Pneumatik GmbH**

Boschring 13-15 D-63329 Egelsbach, Germany
TEL: 06103-4020 FAX: 06103-402139

ITALY **SMC Italia S.p.A.**

Via Garibaldi 62 I-20061 Carugate Milano, Italy
TEL: 02-9271365 FAX: 02-9271365

FRANCE **SMC Pneumatique S.A.**

1 Boulevard de Strasbourg, Parc Gustave Eiffel, Bussy Saint Georges, F-77600
Marne La Vallee Cedex 3 France
TEL: 01-64-76-10-00 FAX: 01-64-76-10-10

SWEDEN **SMC Pneumatics Sweden AB**

Ekhagsvägen 29-31, S-141 05 Huddinge, Sweden
TEL: 08-603-07-00 FAX: 08-603-07-10

SWITZERLAND **SMC Pneumatik AG**

Dorfstrasse 7, Postfach 117, CH-8484 Weisslingen, Switzerland
TEL: 052-396-3131 FAX: 052-396-3191

AUSTRIA **SMC Pneumatik GmbH (Austria)**

Girakstrasse 8, A-2100 Korneuburg, Austria
TEL: 0-2262-6228-0 FAX: 0-2262-62285

SPAIN **SMC España, S.A.**

Zuazobidea 14 Pol. Ind. Júndiz 01015 Vitoria, Spain
TEL: 945-184-100 FAX: 945-184-510

IRELAND **SMC Pneumatics (Ireland) Ltd.**

2002 Citywest Business Campus, Naas Road, Saggart, Co. Dublin, Ireland
TEL: 01-403-9000 FAX: 01-466-0385

NETHERLANDS (Associated company) **SMC Pneumatics BV**

De Ruyterkade 120, NL-1011 AB Amsterdam, Netherlands
TEL: 020-5318888 FAX: 020-5318880

GREECE (Distributor) **S.Parianopoulos S.A.**

7, Konstantinoupoleos Street 11855 Athens, Greece
TEL: 01-3426076 FAX: 01-3455578

DENMARK **SMC Pneumatik A/S**

Knudsminde 4 B DK-8300
Odder, Denmark
TEL: 70252900 FAX: 70252901

Europe

FINLAND SMC Pneumatics Finland OY

PL72, Tiistiniityntie 4, SF-02231 ESP00, Finland
TEL: 09-8595-80 FAX: 09-8595-8595

NORWAY SMC Pneumatics Norway A/S

Vollsvæien 13C, Granfoss Næringspark N-1366 LYSAKER, Norway
TEL: 67-12-90-20 FAX: 67-12-90-21

BELGIUM (Distributor) SMC Pneumatics N.V./S.A.

Nijverheidsstraat 20 B-2160 Wommelgem Belgium
TEL: 03-355-1464 FAX: 03-355-1466

POLAND SMC Industrial Automation Polska Sp.z.o.o.

ul. Konstruktorska 11A, PL-02-673 Warszawa, Poland
TEL: 022-548-5085 FAX: 022-548-5087

TURKEY (Distributor) Entek Pnömatik San.ve Tic. Ltd. Sti

Perpa Tic. Merkezi Kat:11 No.1625 80270 Okmeydani Istanbul, Türkiye
TEL: 0212-221-1512 FAX: 0212-221-1519

RUSSIA SMC Pneumatik LLC.

36/40 Sredny prospect V.O. St. Petersburg 199004, Russia
TEL: 812-118-5445 FAX: 812-118-5449

CZECH SMC Industrial Automation CZ s.r.o.

Hudcova 78a, CZ-61200 Brno, Czech Republic
TEL: 05-4121-8034 FAX: 05-4121-8034

HUNGARY SMC Hungary Ipari Automatizálási kft.

Budafoki ut 107-113 1117 Budapest
TEL: 01-371-1343 FAX: 01-371-1344

ROMANIA SMC Romania S.r.l.

Str. Frunzei, Nr. 29, Sector 2, Bucharest, Romania
TEL: 01-3205111 FAX: 01-3261489

SLOVAKIA SMC Priemyselná automatizácia, s.r.o.

Nova 3, SK-83103 Bratislava
TEL: 02-4445-6725 FAX: 02-4445-6028

SLOVENIA SMC Industrijska Avtomatila d.o.o.

Grajski trg 15, SLO- 8360 Zuzemberk, Slovenia
TEL: 07388-5240 FAX: 07388-5249

LATVIA SMC Pneumatics Latvia SIA

Šmerļa ielā 1-705, Rīga LV-1006
TEL: 777 94 74 FAX: 777 94 75

SOUTH AFRICA (Distributor) Hyflo Southern Africa (Pty.) Ltd.

P.O.Box 240 Paardeneiland 7420 South Africa
TEL: 021-511-7021 FAX: 021-511-4456

EGYPT (Distributor) Saadani Trading & Ind. Services

15 Sebaai Street, Miami 21411 Alexandria, Egypt
TEL: 3-548-50-34 FAX: 3-548-50-34

Oceania/Asia

AUSTRALIA SMC Pneumatics (Australia) Pty.Ltd.

14-18 Hudson Avenue Castle Hill NSW 2154, Australia
TEL: 02-9354-8222 FAX: 02-9894-5719

NEW ZEALAND SMC Pneumatics (New Zealand) Ltd.

8C Sylvia Park Road Mt.Wellington Auckland, New Zealand
TEL: 09-573-7007 FAX: 09-573-7002

TAIWAN SMC Pneumatics (Taiwan) Co.,Ltd.

17, Lane 205, Nansan Rd., Sec.2, Luzhu-Hsiang, Taoyuan-Hsien, TAIWAN
TEL: 03-322-3443 FAX: 03-322-3387

HONG KONG SMC Pneumatics (Hong Kong) Ltd.

29/F, Clifford Centre, 778-784 Cheung, Sha Wan Road, Lai Chi Kok, Kowloon, Hong Kong
TEL: 2744-0121 FAX: 2785-1314

SINGAPORE SMC Pneumatics (S.E.A.) Pte. Ltd.

89 Tuas Avenue 1, Jurong Singapore 639520
TEL: 6861-0888 FAX: 6861-1889

PHILIPPINES SHOKETSU SMC Corporation

Unit 201 Common Goal Tower, Madrigal Business Park, Ayala Alabang Muntinlupa, Philippines
TEL: 02-8090565 FAX: 02-8090586

MALAYSIA SMC Pneumatics (S.E.A.) Sdn. Bhd.

Lot 36 Jalan Delima1/1, Subang Hi-Tech Industrial Park, Batu 3 40000 Shah Alam Selangor, Malaysia
TEL: 03-56350590 FAX: 03-56350602

SOUTH KOREA SMC Pneumatics Korea Co., Ltd.

Woolim e-BIZ Center (Room 1008), 170-5, Guro-Dong, Guro-Gu, Seoul, 152-050, South Korea
TEL: 02-3219-0700 FAX: 02-3219-0702

CHINA SMC (China) Co., Ltd.

7 Wan Yuan St. Beijing Economic & Technological Development Zone 100176, China
TEL: 010-67882111 FAX: 010-67881837

THAILAND SMC Thailand Ltd.

134/6 Moo 5, Tiwanon Road, Bangkok, Amphur Muang, Patumthani 12000, Thailand
TEL: 02-963-7099 FAX: 02-501-2937

INDIA SMC Pneumatics (India) Pvt. Ltd.

D-107 to 112, Phase-2, Extension, Noida, Dist. Gautaim Budh Nagar, U.P. 201 305, India
TEL: (0120)-4568730 FAX: 0120-4568933

INDONESIA (Distributor) P.T. Riyadi Putera Makmur

Jalan Hayam Wuruk Komplek Glodok Jaya No. 27-28 Jakarta 11180 Indonesia
TEL: 021-625 5548 FAX: 021-625 5888

PAKISTAN (Distributor) Jubilee Corporation

First Floor Mercantile Centre, Newton Road Near Boulton Market P.O. Box 6165 Karachi 74000 Pakistan
TEL: 021-243-9070/8449 FAX: 021-241-4589

ISRAEL (Distributor) Baccara Automation Control

Kvutza Geva 18915 Israel
TEL: 04-653-5960 FAX: 04-653-1445

SAUDI ARABIA (Distributor) Assaggaff Trading Est.

P.O. Box 3385 Al-Amir Majed Street, Jeddah-21471, Saudi Arabia
TEL: 02-6761574 FAX: 02-6708173