

Programmable Terminal

NV Series

Compact and Simple, Extremely High Cost Performance



» The Best PT for Package PLCs

» A Lineup of 14 Models That Redefine "Compact"

The Best PT for Package PLCs — 「NV」

The NV Series of compact Programmable Terminals meet the basic needs for enhanced visibility, simplicity, and cost, and they go even further to provide superior PLC compatibility, easy operation, and cost performance.



Visibility

Beautiful, Easy-to-understand Displays

Instantly know the system status

It is obvious in three color LED backlight

The monochrome models provide three backlight colors to perform status displays. For example, use green for normal operation, orange for user controls, and red for errors so that the operating status can be seen at a glance.

■ NV3W-MG-V1/NV4W-MG

Normal Operation	User Controls	Error Displays
Green	Orange	Red

The red backlight makes error displays bright and easy to see.

■ NV3W-MR-V1/NV4W-MR

Normal Operation	User Controls	Error Displays
White	Pink	Red

Easy Visual Recognition

True Type Fonts for Flexible Screen Designs

You can use True Type fonts in a wide range of sizes from 10 to 240 dots to flexibly design beautiful screens.

* The maximum font size depends on the model.

■ True Type Fonts

You can select the best Windows® fonts to create the desired screen images or emphasize screen appearance.

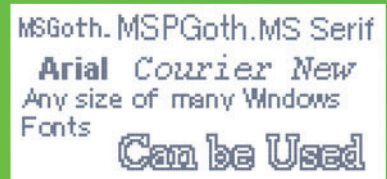

Variation

A Lineup of 14 Models That Form a New Standard for Small

NEW

3.8inch

Compact Horizontal Models

NV3W-V1

Monochrome TFT

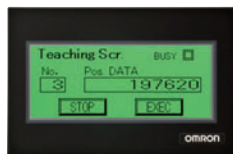

- Display colors : Monochrome, 2 grayscale levels
- 240 × 96 dots
- Backlight : LEDs, 3 colors (green, orange, and red)



- Display colors : Monochrome, 2 grayscale levels
- 240 × 96 dots
- Backlight : LEDs, 3 colors (white, pink, and red)

USB Slave	RS-232C	RS-422A/485	SD memory card
Vertical installation	5 VDC	24 VDC	

4.6inch

Compact Horizontal Models

NV4W

Monochrome TFT



- Display colors : Monochrome, 2 grayscale levels or 8 grayscale levels
- 320 × 120 dots
- Backlight : LEDs, 3 colors (green, orange, and red)

USB Slave	RS-232C
Vertical installation	5 VDC

A 5-V model is available that can be powered from an OMRON PLC



“V” stands for the three benefits

- Value** Easy design work and superior PLC compatibility
- Visibility** Beautiful, easy-to-understand displays
- Variation** A lineup of ten 3-inch models for easy selection

Value Easy Designing

The slim design of NV-series PTs requires very little installation space.

Vertical Installation

The PT can be installed vertically to enable more applications. This enables more flexible designs.

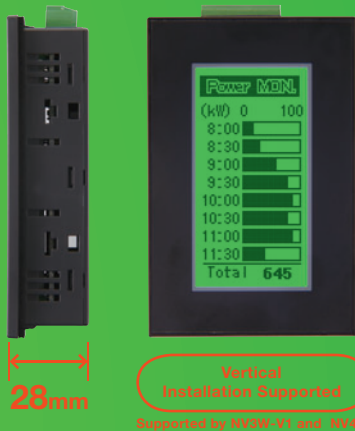

28mm

Vertical Installation Supported
Supported by NV3W-V1 and NV3W

Global Application

Multi-language Support and Safety Standard Compliance

You can switch parts labels and languages. Record up to sixteen character strings in different languages and change all labels at the same time. Switching the language during operation is also very easy. International safety standards have also been met so that you can easily export equipment or transport equipment overseas.



* Including European languages.

■ Safety Standards



* Only the NV3W-V1 has the KC mark.

Handle Devices from Various Manufacturers Global Multivendor Support

You can connect the PT to OMRON or Mitsubishi Electric PLCs or to PLCs from many other global manufacturers. This lets you connect the NV-series PTs without changing the PLC. You can easily use a different PLC manufacturer for each project.



OMRON, Mitsubishi Electric, Keyence, Hitachi, Allen-Bradley, Siemens, etc.

PTs

The lineup includes compact and horizontal models from 3.8-inch to 4.6-inch and QVGA models. Select the size and price that are best for each system.



- Display colors : Monochrome , 2 grayscale levels or 8 grayscale levels
- 320 × 120 dots
- Backlight : LEDs, 3 colors (white, pink, and red)

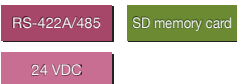

3.6inch

QVGA Models

NV3Q

Monochrome TFT
Color TFT



- Display colors : Monochrome , 2 grayscale levels
- 320 × 240 dots
- Backlight : LEDs, 3 colors (white, pink, and red)

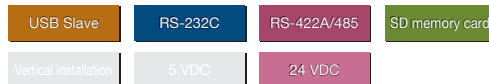

- Display colors : 4096 colors
- 320 × 240 dots
- Backlight : White LED

Easy Connection to External Devices

NV3W-V1

NEW

3.8 inch Compact Horizontal Models

NV3W-MG□0(L)-V1
Monochrome TFT



NV3W-MR□0(L)-V1
Monochrome TFT



Battery-free Operation

Internal Storage of Required Data in the PT

An NV-series PT can be operated without a battery. No maintenance battery is required.

Data Backed Up without a Battery

- NV Configuration
- Base Screens
- Keyboard Screens
- Recipes
- Write Address Data
- Flow Display Data

Data required for operation is backed up

Screen Conversion

The NV-Designer version 2.0 or higher provides the function to convert NV3W screens into NV3W-V1 screens.

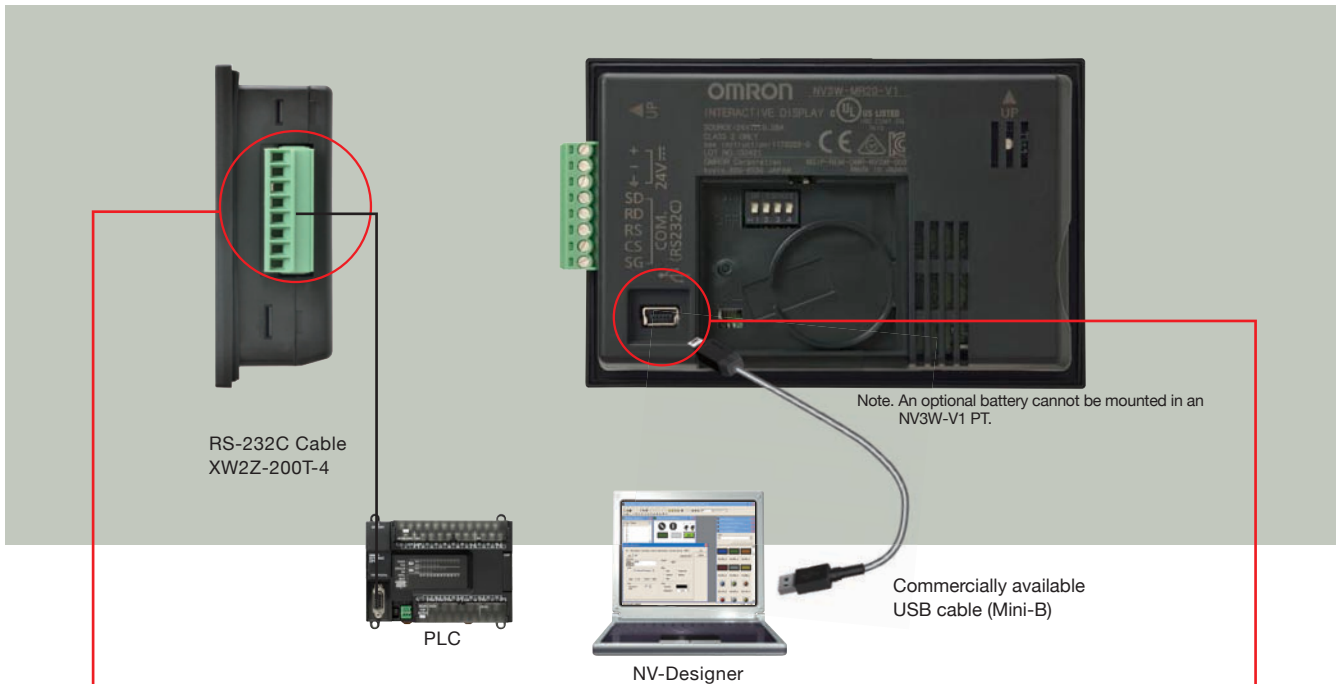

Serial Communications/Power Supply Connector

Supply Power from the PLC NV3W-V1 Only Compatibility

With 5-V NV3W-V1 models, 5-V can be supplied from the PLC via the PLC Connecting Cable. This reduces wiring work and eliminates the need for a special power supply for the PT.

Supplying 5-V from the PLC

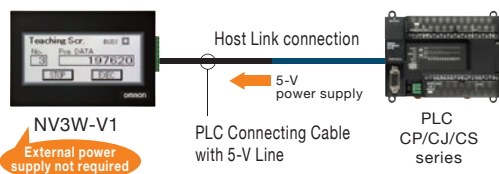

*An XW2Z-200T-4 PLC Connecting Cable is required to supply power from the PLC.
*With 24-V PTs, power must be supplied from an external power supply.

Tool Port / USB1.1

Transfer Ladder Programs and PT Screens without Changing the Cable Compatibility

Ladder programs can be transferred, debugged, or monitored for an OMRON PLC from the CX-Programmer running on a computer connected to the NV-series PT while communicating through the NV-series PT.

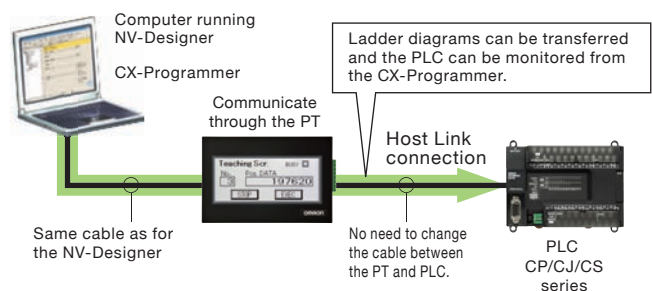

*Refer to Support Software on page 7 for applicable versions of the CX-One.

for Easy Maintenance

NV4W

4.6 inch Compact Horizontal Models

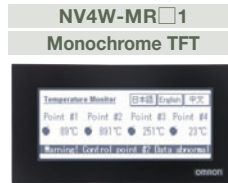
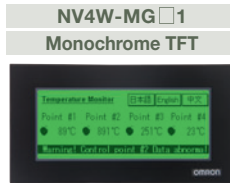

Battery-free Operation

Internal Storage of Required Data in the PT

An NV-series PT can be operated without a battery. No maintenance battery is required.

Data Backed Up without a Battery

- NV Configuration
- Base Screens
- Keyboard Screens
- Recipes
- Write Address Data
- Flow Display Data

Data required for operation is backed up

Optional Battery

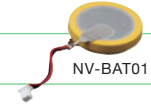

Back up PLC memory in the PT with an optional battery.

An optional battery can be mounted in an NV4Q PT to back up specified addresses from PLC memory. This allows you, for example, to back up memory areas that are not held in the PLC when using a CP1E PLC without a battery.

Data That Can Be Backed Up with a Battery

- Up to 24 words of PLC memory
- Clock data
- Internal PT memory
- Alarm history
- Password



Back up words from PLC memory

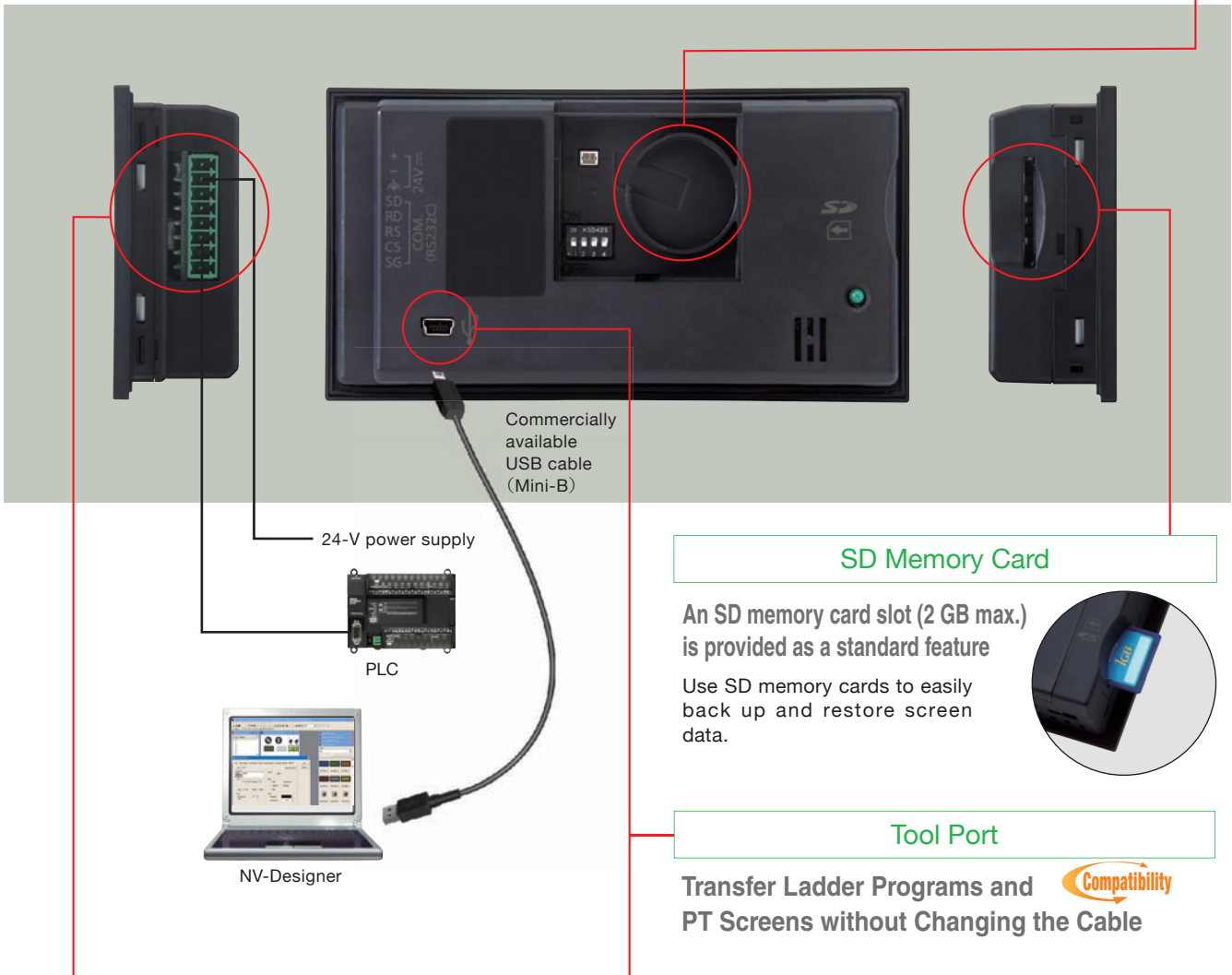

Serial Communications/Power Supply Connector

This connector supplies 24 VDC.

SD Memory Card

An SD memory card slot (2 GB max.) is provided as a standard feature

Use SD memory cards to easily back up and restore screen data.



Tool Port

Transfer Ladder Programs and PT Screens without Changing the Cable



USB1.1

High-speed Screen Transfers with Commercially Available USB Cable

A USB interface is provided to effectively use computer software environments. Screens that are created on the computer can be quickly transferred to the PT using a commercially available USB cable (Mini-B).

NV3Q

3.6 inch

QVGA Models

NV3Q-MR□1
Monochrome TFT



NV3Q-SW□1
Color TFT



Battery-free Operation

Internal Storage of Required Data in the PT

An NV-series PT can be operated without a battery. No maintenance battery is required.

■ Data Backed Up without a Battery

- NV Configuration
- Base Screens
- Keyboard Screens
- Recipes
- Write Address Data
- Flow Display Data

Data required for operation is backed up

Optional Battery

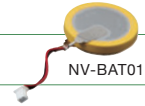

Back up PLC memory in the PT with an optional battery.

An optional battery can be mounted in an NV3Q PT to back up specified addresses from PLC memory. This allows you, for example, to back up memory areas that are not held in the PLC when using a CP1E PLC without a battery.

■ Data That Can Be Backed Up with a Battery

- Up to 24 words of PLC memory
- Clock data
- Internal PT memory
- Alarm history
- Password

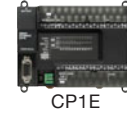

Back up words from PLC memory

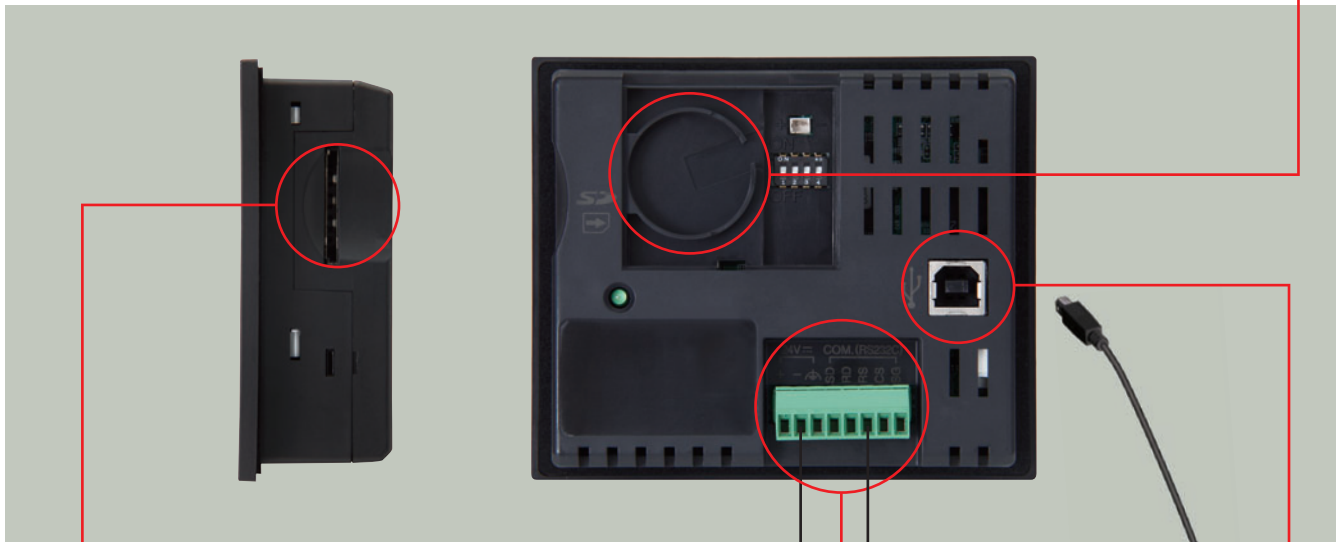

Serial Communications/Power Supply Connector

This connector supplies 24 VDC.

SD Memory Card

An SD memory card slot (2 GB max.)* is provided as a standard feature

Use SD memory cards to easily back up and restore screen data.

*The capacity of the SD memory card is 32 MB to 1 GB for PT system program version 1.0□.



Tool Port

Transfer Ladder Programs and PT Screens without Changing the Cable



USB1.1

High-speed Screen Transfers with Commercially Available USB Cable

A USB interface is provided to effectively use computer software environments. Screens that are created on the computer can be quickly transferred to the PT using a commercially available USB cable (TYPE-B).

Programmable Terminals NV-series

Compact and Simple, Extremely High Cost Performance

- The lineup includes compact and horizontal models from 3.8-inch to 4.6-inch and QVGA models.
- True Type Fonts for Flexible Screen Designs.
- Space-saving Installation.
- Multi-language Support and Safety Standard Compliance.



System Configuration

NV3W-V1

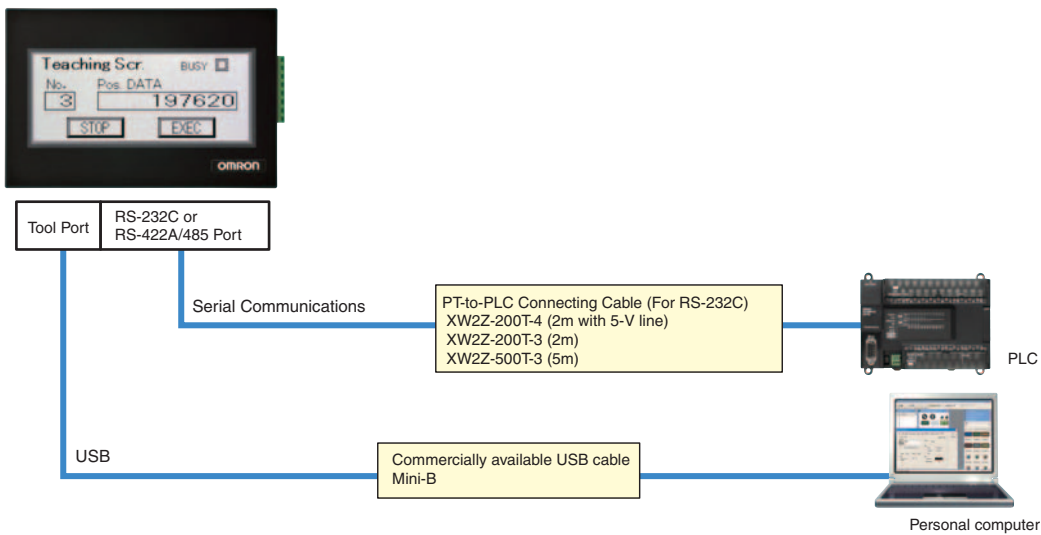

NV4W/NV3Q

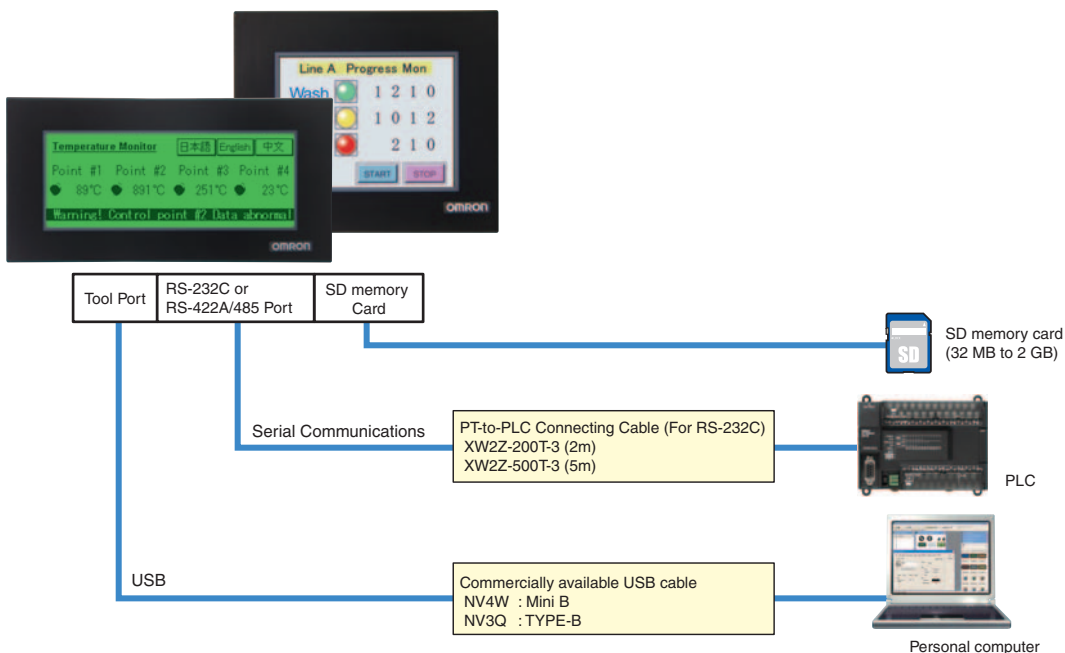

Windows is either registered trademarks or trademarks of Microsoft Corporation in the United States and/or other countries. Other company names and product names in this document are the trademarks or registered trademarks of their respective companies. The product photographs and figures that are used in this catalog may vary somewhat from the actual products. Microsoft product screen shot(s) reprinted with permission from Microsoft Corporation.

NV-series

Ordering Information

Programmable Terminals

Product name	Specifications					Model
	Screen size	Number of dot	Communications	Power supply voltage	Backlight	
NV3W-V1	3.8-in, TFT monochrome	240 × 96 dots	RS-232C	5 VDC	LEDs, 3 colors (green, orange, and red)	NV3W-MG20L-V1
			RS-232C	24 VDC		NV3W-MG20-V1
			RS-422A/485	24 VDC		NV3W-MG40-V1
	3.8-in, TFT monochrome	240 × 96 dots	RS-232C	5 VDC	LEDs, 3 colors (white, pink, and red)	NV3W-MR20L-V1
			RS-232C	24 VDC		NV3W-MR20-V1
			RS-422A/485	24 VDC		NV3W-MR40-V1
NV4W	4.6-in, TFT monochrome	320 × 120 dots	RS-232C	24 VDC	LEDs, 3 colors (green, orange, and red)	NV4W-MG21
			RS-422A/485	24 VDC		NV4W-MG41
	4.6-in, TFT monochrome	320 × 120 dots	RS-232C	24 VDC	LEDs, 3 colors (white, pink, and red)	NV4W-MR21
			RS-422A/485	24 VDC		NV4W-MR41
NV3Q	3.6-in, TFT monochrome	320 × 240 dots (QVGA)	RS-232C	24 VDC	LEDs, 3 colors (white, pink, and red)	NV3Q-MR21
			RS-422A/485	24 VDC		NV3Q-MR41
	3.6-in, TFT color	320 × 240 dots (QVGA)	RS-232C	24 VDC	White LED	NV3Q-SW21
			RS-422A/485	24 VDC		NV3Q-SW41

Programming Devices

Product name	Specifications	Specifications		Model
		Number of licenses	Media	
FA Integrated Tool Package CX-One Lite Ver.4.□	CX-One Lite is a subset of the complete CX-One package that provides only the Support Software required for micro PLC applications. *1 CX-One Lite runs on the following OS. Windows 7 (32-bit/64-bit version) / Windows 8 (32-bit/64-bit version) / Windows 8.1 (32-bit/64-bit version) / Windows 10 (32-bit/64-bit version) CX-One Lite Ver. 4.□ includes NV-Designer Ver.1.□.	1 license	DVD	CXONE-LT01D-V4
FA Integrated Tool Package CX-One Ver. 4.□	CX-One is a comprehensive software package that integrates the Support Software for OMRON PLCs and components. *2 CX-One runs on the following OS. Windows 7 (32-bit/64-bit version) / Windows 8 (32-bit/64-bit version) / Windows 8.1 (32-bit/64-bit version) / Windows 10 (32-bit/64-bit version) CX-One Ver. 4.□ includes NV-Designer Ver.1.□.	1 license *3	DVD	CXONE-AL01D-V4

Note: 1. NV-Designer version 2.0 or higher is required to use the NV3W-V1.

NV-Designer version 1.0 or higher is required to use the NV3Q.

NV-Designer version 1.1 or higher is required to use the NV4W.

2. The CX-One and CX-One Lite cannot be simultaneously installed on the same computer.

***1.** CX-One Lite Ver.4.□ provides the following Support Software : Micro PLC Edition CX-Programmer Ver.9.□, CX-Integrator Ver.2.□, Switch Box Utility Ver.1.□, CX-Simulator Ver.1.□, CX-Drive Ver.2.□, CX-Designer Ver.3.□, NV-Designer Ver.1.□ or higher, CX-Thermo Ver.4.□, CX-ConfiguratorFDT Ver.1.□, Network Configurator Ver.3.□, and CX-Server Ver.4.□.

***2.** For details, refer to the CX-One Catalog (Cat. No : R134).

***3.** Multi licenses (3, 10, 30, or 50 licenses) and DVD media without licenses are also available for the CX-One.

Options (Sold separately)

Product name		Specifications	Model
PT-to-PLC Connecting Cable		For the NV3W with 5-V power (NV3W-MG20L-V1/MR20L-V1 only)	Length: 2m XW2Z-200T-4 *1
		For the NV3W-V1, NV4W, and NV3Q	Length: 2m XW2Z-200T-3
		For the NV3W-V1, NV4W, and NV3Q	Length: 5m XW2Z-500T-3
Programming Device Connecting Cable	USB-Serial Conversion Cable	For the NV3W	Length: 3m NV-TOL-3M
		For the NV3W Use this Cable together with the NV-TOL-3M to connect to a USB connector on the computer. Note : The enclosed USB driver must be installed.	Length: 0.5m CS1W-CIF31
Battery *2		For the NV4W and NV3Q	NV-BAT01
Display Protective Sheets		For the NV3W-V1, contains 10 sheets	NV3W-KBA04-V1
		For the NV4W, contains 10 sheets	NV4W-KBA04
		For the NV3Q, contains 10 sheets	NV3Q-KBA04
Attachment		NP3 Series to NV3Q Series	NV3Q-ATT02

Note: For NV3W-V1 and NV4W, use commercially available USB cable (Mini B).

For NV3Q, use commercially available USB cable (TYPE-B).

*1. If the XW2Z-200T-4 Cable is used with the NV3W-V1, 5 V can be supplied from the CS/CJ/CP-series PLCs instead of from an external power supply. Refer to the NV-series PT Setup Manual (Cat.No V103) for details.

*2. Cannot be used for the NV3W-V1.

NV-series

Specifications

General Specifications

Item	Specifications				
Model	NV3W-M□20-V1/M□40-V1	NV3W-M□20-L-V1	NV4W-M□21/M□41	NV3Q-MR□1	NV3Q-SW□1
Rated power supply	24 VDC	5 VDC	24 VDC		
Operating voltage range	21.6 to 26.4 VDC	4.5 to 5.5 VDC	21.6 to 26.4 VDC		
Current consumption	1.9 W max. (80 mA max.)	1 W max. (200 mA max.)	1.7 W max. (70 mA max.)	2.4 W max. (100 mA max.)	3.6 W max. (150 mA max.)
Ambient operating temperature	0 to 50 °C				
Ambient operating humidity	20% to 85% (with no condensation)				
Ambient storage temperature	-20 to 60 °C				
Ambient storage humidity	10% to 85% (with no condensation)				
Dielectric strength	Between the power supply terminals and the case 500 VAC for 1 min with a cutoff current of 10 mA (at initial state)				
Insulation resistance	Between the power supply terminals and the case 100 MΩ (at 500 VDC) (at initial state)				
Vibration resistance	5 to 8.4 Hz, 3.5-mm single amplitude, 8.4 to 150 Hz, 9.8 m/s ² , 10 times each in X, Y, and Z directions (1 octave/min)		5 to 9 Hz, 3.5-mm single amplitude, 9 to 150 Hz, 9.8 m/s ² , 10 times each in X, Y, and Z directions (1 octave/min)		10 to 55 Hz with 0.75-amplitude for 10 min each in X, Y, and Z directions, 1 sweep per min
Shock resistance	147m/s ² 3 times each in X, Y, and Z directions			98m/s ² 4 times each in X, Y, and Z directions	
Noise immunity	1,000 Vp-p with pulse widths of 50 ns and 1 μs between power supply terminals (via simulator)				
Resistance to environment	For NV3Q IP65 (at initial state), For NV3W-V1, NV4W IP67 (at initial state) Dust proof and drip proof only from the front of the panel (using Waterproof Packing at the contact surface with the panel) Replace the Waterproof Packing each time you reinstall the PT.				
Battery life expectancy	-		Battery life expectancy: 5 yr (at 25 °C) *		Battery life expectancy: 3 yr (at 25 °C) *
Safety standards	UL 508, EC Directives and KC		UL 508 and EC Directives		
Weight	170 g max.		240 g max.		210 g max.

* The SRAM (internal RAM) is backed up by the battery. If backing up the data is required, purchase the NV-BAT01 Battery separately.

Performance Specifications

Item	Specifications			
Model	NV3W-MG□□(L)-V1/MR□□(L)-V1	NV4W-M□21/M□41	NV3Q-MR□1/ SW□1	
Display device	TFT monochrome LCD *8	TFT monochrome LCD *9	NV3Q-MR: TFT monochrome LCD *6 NV3Q-SW: TFT color LCD *7	
Number of dots	240 × 96 dots (H × V)	320 × 120 dots (H × V)	320 × 240 dots (H × V)	
Effective display size	88.5 × 35.4 mm (H × V)	109 × 41 mm (H × V)	70.6 × 52.9 mm (H × V)	
Service Life	50,000 hours min. *1			
Backlights	NV3W-MG-V1 : LED backlights, 3 colors (green, orange, and red) NV3W-MR-V1 : LED backlights, 3 colors (white, pink, and red)	NV4W-MG : LED backlights, 3 colors (green, orange, and red) NV4W-MR : LED backlights, 3 colors (white, pink, and red)	NV3Q-MR: LED backlights, 3 colors (white, pink, and red) NV3Q-SW: LED backlight, 1 color (white)	
Touch switches	Method	Analog resistive membrane type		
	Operating force	0.8 N max.		
	Life expectancy	100 million operations min. (at 25 °C)		
	Switches	50 max. per screen *2	100 max. per screen *2	
	Size	8 dots × 8 dots min. *3		
External memory	-	SD memory card (32 MB to 2 GB) *4 Manufacturers for which operation has been confirmed: Panasonic SD standard *5		
Host communications	COM Port	NV3W-M□20(L)-V1 : RS-232C (not isolated), Transmission distance: 15 m, Connector : 8-pin NV3W-M□40-V1 : RS-422A/485 (not isolated), Transmission distance: 500 m, Connector : 8-pin	NV4W-M□21 : RS-232C (not isolated), Transmission distance: 15 m, Connector:8-pin NV4W-M□41 : RS-422A/485 (not isolated), Transmission distance: 500m, Connector: 8-pin	NV3Q-□□21 : RS-232C (not isolated), Transmission distance: 15 m, Connector: 8-pin NV3Q-□□41 : RS-422A/485 (not isolated), Transmission distance: 500 m, Connector: 8-pin
Support Software communications	USB port	USB 1.1 Mini-B, T transmission distance: 5 m max.		USB 1.1 TYPE-B, Transmission distance: 5 m max.
Applicable Support Software	NV-Designer version 2.0 or higher (NV-Designer can be upgraded to version 2.0 by using the CX-One Auto-update.)		NV-Designer version 1.1 or higher (Included with CX-One version 4.03 or in CX-One Lite version 4.03.)	NV-Designer version 1.0 or higher (Included with CX-One version 3.2 or in CX-One Lite version 4.0.)

*1. This is the estimated time before brightness is reduced by half at room temperature and humidity. It is not a guaranteed value.

*2. The estimate applies to operation when only custom switches are placed on the screen.

*3. This value does not include 1-dot box of frame line.

*4. The capacity of the SD memory card is 32 MB to 1 GB for PT system program version 1.0□.

*5. SD memory cards are shipped pre-formatted from the factory, so there is normally no need to format them. If an SD memory card is formatted with the standard formatting utility provided with a personal computer, its file system will not conform to the SD memory card standard. Always use the formatting software provided by SD memory card makers.

*6. The display device of NV3Q-MR□1 of the Lot No. 160430 or earlier is STN, and the Lot No. 160501 or later is TFT.

*7. The display device of NV3Q-SW□1 of the Lot No. 110999 or earlier is STN, and the Lot No. 111000 or later is TFT.

*8. The display device of NV3W-MG□□(L)-V1/MR□□(L)-V1 of the Lot No. 161231 or earlier is STN, and the Lot No. 170101 or later is TFT.

*9. The display device of NV4W-M□21/M□41 of the Lot No. 170221 or earlier is STN, and the Lot No. 170222 or later is TFT.

Applicable PLCs

Company	Series
OMRON	CP Series
OMRON	CJ Series
OMRON	CS Series
OMRON	C Series
OMRON	CVM1/CV Series
OMRON	Temperature Controllers EJ1 Series
Yokogawa Electric	FA-M3 Series
Hitachi	EH-150EHV Series
Hitachi	EH150 Series
Hitachi	MICRO-EH Series
Hitachi	Web Controller

Company	Series
Mitsubishi Electric	FX Series
Mitsubishi Electric	Q Series
Mitsubishi Electric	A Series
Panasonic Electric Works	FP Series
Toshiba Machine	TC mini Series
Keyence	KV Series, KV Nano Series
Allen-Bradley Models that support DF protocol	MicroLogix
Allen-Bradley Models that support DF protocol	SLC-500 Series
Siemens	S7-200 Series
LG	MASTER-K Series
Modbus	Models that support RTU protocol

Note: Refer to "NV Series Programmable Terminals Host Connection Manual (Cat.No V105)" which is included in NV-Designer for information on combination use with each PLC Series.

Dimensions

(Unit: mm)

NV3W-V1

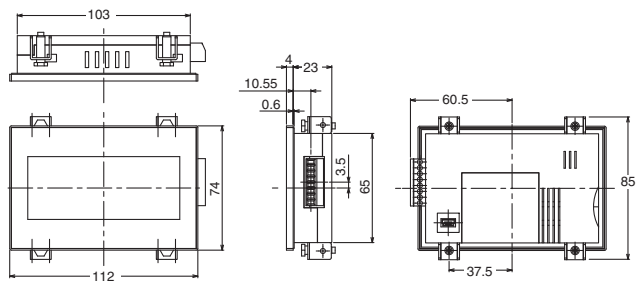

Panel Cutout Dimensions

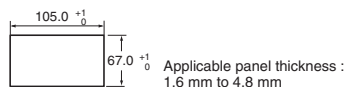

NV4W

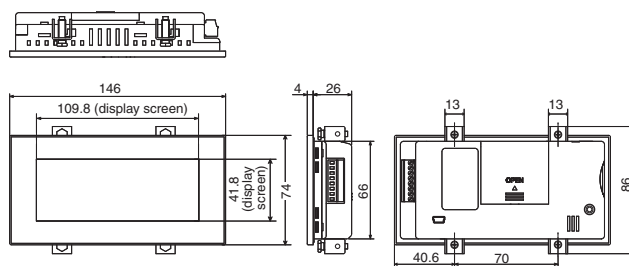

Panel Cutout Dimensions

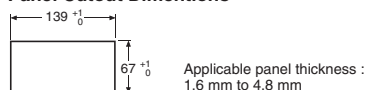

NV3Q

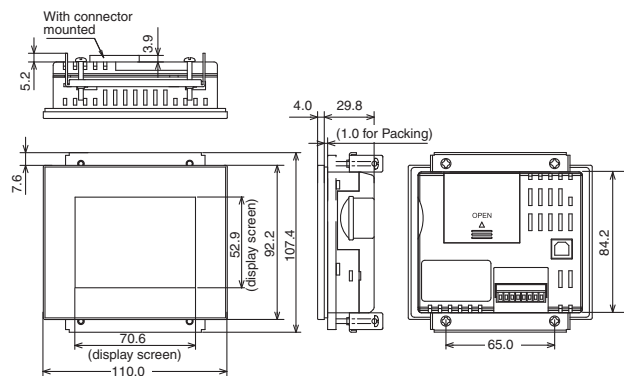

Panel Cutout Dimensions

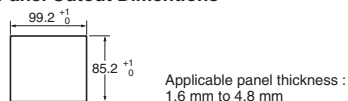

Related Manuals

Cat. No	Model	Name
V103	NV3W-V1, NV4W, NV3Q	NV Series Programmable Terminals Setup Manual
V104	NV3W-V1, NV4W, NV3Q, NV-Designer	NV Series Programmable Terminals Programmig Manual
V105	NV3W-V1, NV4W, NV3Q	NV Series Programmable Terminals Host Connection Manual

Read and Understand this Catalog

Please read and understand this catalog before purchasing the products. Please consult your OMRON representative if you have any questions or comments.

Warranty and Limitations of Liability

WARRANTY

(a) Exclusive Warranty. Omron's exclusive warranty is that the Products will be free from defects in materials and workmanship for a period of twelve months from the date of sale by Omron (or such other period expressed in writing by Omron). Omron disclaims all other warranties, express or implied.

(b) Limitations. OMRON MAKES NO WARRANTY OR REPRESENTATION, EXPRESS OR IMPLIED, ABOUT NON-INFRINGEMENT, MERCHANTABILITY OR FITNESS FOR A PARTICULAR PURPOSE OF THE PRODUCTS. BUYER ACKNOWLEDGES THAT IT ALONE HAS DETERMINED THAT THE PRODUCTS WILL SUITABLY MEET THE REQUIREMENTS OF THEIR INTENDED USE.

Omron further disclaims all warranties and responsibility of any type for claims or expenses based on infringement by the Products or otherwise of any intellectual property right. (c) Buyer Remedy. Omron's sole obligation hereunder shall be, at Omron's election, to (i) replace (in the form originally shipped with Buyer responsible for labor charges for removal or replacement thereof) the non-complying Product, (ii) repair the non-complying Product, or (iii) repay or credit Buyer an amount equal to the purchase price of the non-complying Product; provided that in no event shall Omron be responsible for warranty, repair, indemnity or any other claims or expenses regarding the Products unless Omron's analysis confirms that the Products were properly handled, stored, installed and maintained and not subject to contamination, abuse, misuse or inappropriate modification. Return of any Products by Buyer must be approved in writing by Omron before shipment. Omron Companies shall not be liable for the suitability or unsuitability or the results from the use of Products in combination with any electrical or electronic components, circuits, system assemblies or any other materials or substances or environments. Any advice, recommendations or information given orally or in writing, are not to be construed as an amendment or addition to the above warranty.

See <http://www.omron.com/global/> or contact your Omron representative for published information.

LIMITATIONS OF LIABILITY

OMRON COMPANIES SHALL NOT BE LIABLE FOR SPECIAL, INDIRECT, INCIDENTAL, OR CONSEQUENTIAL DAMAGES, LOSS OF PROFITS OR PRODUCTION OR COMMERCIAL LOSS IN ANY WAY CONNECTED WITH THE PRODUCTS, WHETHER SUCH CLAIM IS BASED IN CONTRACT, WARRANTY, NEGLIGENCE OR STRICT LIABILITY.

Further, in no event shall liability of Omron Companies exceed the individual price of the Product on which liability is asserted.

Application Considerations

SUITABILITY FOR USE

Omron Companies shall not be responsible for conformity with any standards, codes or regulations which apply to the combination of the Product in the Buyer's application or use of the Product. At Buyer's request, Omron will provide applicable third party certification documents identifying ratings and limitations of use which apply to the Product. This information by itself is not sufficient for a complete determination of the suitability of the Product in combination with the end product, machine, system, or other application or use. Buyer shall be solely responsible for determining appropriateness of the particular Product with respect to Buyer's application, product or system. Buyer shall take application responsibility in all cases.

NEVER USE THE PRODUCT FOR AN APPLICATION INVOLVING SERIOUS RISK TO LIFE OR PROPERTY OR IN LARGE QUANTITIES WITHOUT ENSURING THAT THE SYSTEM AS A WHOLE HAS BEEN DESIGNED TO ADDRESS THE RISKS, AND THAT THE OMRON PRODUCT(S) IS PROPERLY RATED AND INSTALLED FOR THE INTENDED USE WITHIN THE OVERALL EQUIPMENT OR SYSTEM.

PROGRAMMABLE PRODUCTS

Omron Companies shall not be responsible for the user's programming of a programmable Product, or any consequence thereof.

Disclaimers

PERFORMANCE DATA

Data presented in Omron Company websites, catalogs and other materials is provided as a guide for the user in determining suitability and does not constitute a warranty. It may represent the result of Omron's test conditions, and the user must correlate it to actual application requirements. Actual performance is subject to the Omron's Warranty and Limitations of Liability.

CHANGE IN SPECIFICATIONS

Product specifications and accessories may be changed at any time based on improvements and other reasons. It is our practice to change part numbers when published ratings or features are changed, or when significant construction changes are made. However, some specifications of the Product may be changed without any notice. When in doubt, special part numbers may be assigned to fix or establish key specifications for your application. Please consult with your Omron's representative at any time to confirm actual specifications of purchased Product.

ERRORS AND OMISSIONS

Information presented by Omron Companies has been checked and is believed to be accurate; however, no responsibility is assumed for clerical, typographical or proofreading errors or omissions.

Note: Do not use this document to operate the Unit.

OMRON Corporation Industrial Automation Company
Tokyo, JAPAN

Contact: www.ia.omron.com

Regional Headquarters

OMRON EUROPE B.V.

Wegalaan 67-69, 2132 JD Hoofddorp
The Netherlands
Tel: (31)2356-81-300/Fax: (31)2356-81-388

OMRON ASIA PACIFIC PTE. LTD.

No. 438A Alexandra Road # 05-05/08 (Lobby 2),
Alexandra Technopark,
Singapore 119967
Tel: (65) 6835-3011/Fax: (65) 6835-2711

OMRON ELECTRONICS LLC

2895 Greenspoint Parkway, Suite 200
Hoffman Estates, IL 60169 U.S.A
Tel: (1) 847-843-7900/Fax: (1) 847-843-7787

OMRON (CHINA) CO., LTD.

Room 2211, Bank of China Tower,
200 Yin Cheng Zhong Road,
PuDong New Area, Shanghai, 200120, China
Tel: (86) 21-5037-2222/Fax: (86) 21-5037-2200

Authorized Distributor:

© OMRON Corporation 2009-2020 All Rights Reserved.
In the interest of product improvement,
specifications are subject to change without notice.

CSM_7_10

Cat. No. V410-E1-05

0820(0609)

Mouser Electronics

Authorized Distributor

Click to View Pricing, Inventory, Delivery & Lifecycle Information:

Omron:

[NV3Q-MR41](#) [NV3Q-KBA04](#) [NV3Q-SW21](#) [NV4W-MR21](#)