

## SPF Series

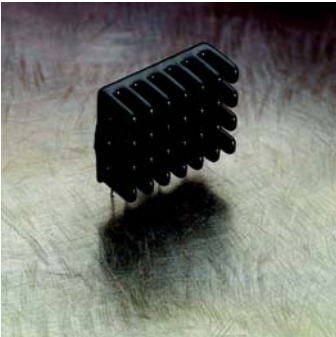

- SIP SSR
- Ratings to 25A (forced air) @ 480 VAC
- SCR output for heavy industrial loads
- AC or DC control
- Zero-crossing (resistive loads) or random-fire (inductive loads) output

### PRODUCT SELECTION

Control Voltage	25A	25A	25A
	SPF240D25		
4-15 VDC		SPF380D25	SPFE480D25
15-32 VDC	SPFE240D25	SPFE380D25	SPF480D25
18-36 VAC	SPFE240A25		
90-140 VAC	SPF240A25		

### AVAILABLE OPTIONS

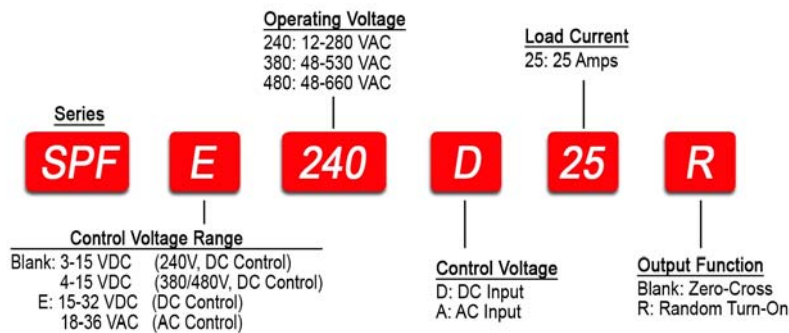

### OUTPUT SPECIFICATIONS (1)

#### Description

Operating Voltage (47-63Hz) [Vrms]	12-280	48-530	48-660
Transient Overvoltage [Vpk]	600	1200	1200
Maximum Off-State Leakage Current @ Rated Voltage [mArms]	0.1	0.1	0.1
Minimum Off-State dv/dt @ Maximum Rated Voltage [V/μsec] (2)	500	500	500
Maximum Load Current [Arms](3)	Forced Air 25 Convection Air 10	Forced Air 25 Convection Air 10	Forced Air 25 Convection Air 10
Minimum Load Current [Arms]	0.06	0.06	0.06
Maximum Surge Current (16.6ms) [Apk]	250	250	250
Maximum On-State Voltage Drop @ Rated Current [Vpk]	1.6	1.6	1.6
Maximum I <sup>2</sup> t for fusing (8.3 msec) [A <sup>2</sup> sec]	260	260	260
Minimum Power Factor (with Maximum Load)	0.5	0.5	0.5

**INPUT SPECIFICATIONS (1)**

Description	SPF240D25	SPF380D/480D	SPFExxxD25	SPF240A25	SPFE240A25
Control Voltage Range	3-15 VDC	4-15 VDC	15-32 VDC	90-140 VAC	18-36 VAC
Maximum Turn On Voltage	3.0 VDC	4.0 VDC	15.0 VDC	90.0 Vrms	18.0 Vrms
Minimum Turn-Off Voltage	1.0 VDC	1.0 VDC	1.0 VDC	10.0 Vrms	2.0 Vrms
Typical Input Current @ Nominal Voltage	15 mAdc	15 mAdc	15 mAdc	10 mAdc	10 mAdc
Nominal Input Impedance	300 Ohm	240 Ohm	1500 Ohm	14.1 k Ohm	2.1 k Ohm
Maximum Turn-On Time [msec] (4)	1/2 Cycle	1/2 Cycle	1/2 Cycle	10	10
Maximum Turn-Off Time [msec]	1/2 Cycle	1/2 Cycle	1/2 Cycle	40	40

**GENERAL SPECIFICATIONS**

Description	Parameters
Dielectric Strength, Input/Output/Base (50/60Hz)	4000 Vrms
Minimum Insulation Resistance (@ 500 VDC)	10 <sup>9</sup> Ohm
Maximum Capacitance, Input/Output	8 pF
Ambient Operating Temperature Range	-30 to 80°C
Ambient Storage Temperature Range	-30 to 125°C
Weight (typical)	0.85 oz. (25g)
Encapsulation	Thermally Conductive Epoxy

**GENERAL NOTES**

- 1) All parameters at 25°C unless otherwise specified.
- 2) Off-State dv/dt test method per EIA/NARM standard RS-443, 13.11.1
- 3) Heatsink temperature 85 °C Maximum.
- 4) Turn-On Time for Random Turn-On versions 0.1 msec (DC Control Models)

**MECHANICAL SPECIFICATIONS**

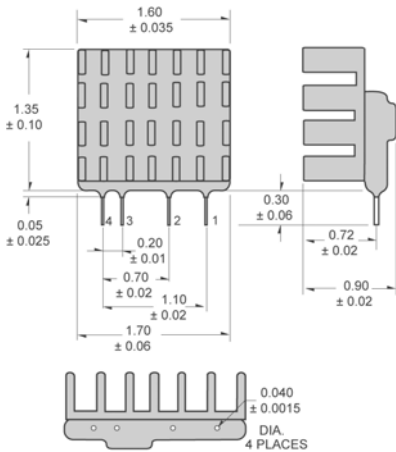

AC CONTROL  
PIN 1: AC LOAD  
PIN 2: AC LOAD  
PIN 3: AC CONTROL  
PIN 4: AC CONTROL

DC CONTROL  
PIN 1: AC LOAD  
PIN 2: AC LOAD  
PIN 3: +DC CONTROL  
PIN 4: -DC CONTROL

UL E1 16950  
CE

Rev. 061608

All dimensions are in inches (millimeters)

**THERMAL DERATE INFORMATION**

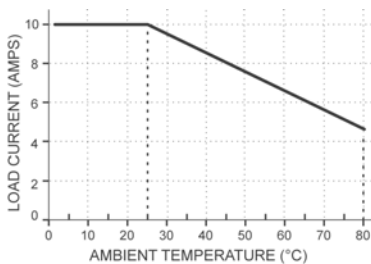

Fig.1 Convection Cooling

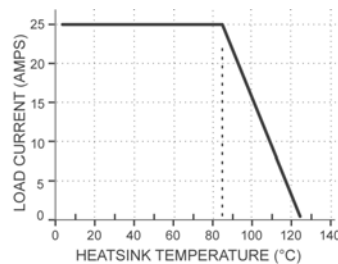



Fig.2 Forced Air Cooling

 <b>DANGER / PELIGRO / DANGER /GEFAHR / PERICOLO / PERIGO</b>					
<p><b>HAZARD OF ELECTRIC SHOCK, EXPLOSION, OR ARC FLASH.</b></p> <ul style="list-style-type: none"> <li>• Disconnect all power before installing or working with this equipment.</li> <li>• Verify all connections and replace all covers before turning on power.</li> </ul> <p><b>Failure to follow these instructions will result in death or serious injury.</b></p>	<p><b>RIESGO DE DESCARGA ELECTRICA O EXPLOSION.</b></p> <ul style="list-style-type: none"> <li>• Desconectar todos los suministros de energia a este equipo antes de trabajar con este equipo.</li> <li>• Verificar todas las conexiones y colocar todas las tapas antes de energizar el equipo.</li> </ul> <p><b>EI incumplimiento de estas instrucciones puede provocar la muerte o lesiones serias.</b></p>	<p><b>RISQUE DE DESCARGE ELECTRIQUE OU EXPLOSION</b></p> <ul style="list-style-type: none"> <li>• Eteindre toutes les sources d'énergie de cet appareil avant de travailler dessus de cet appareil</li> <li>• Vérifier tous connections, et remettre tous couverts en olace avant de mettre sous</li> </ul> <p><b>De non-suivi de ces instructions provoquera la mort ou des lésions sérieuses sérieuses.</b></p>	<p><b>GEFAHR EINES ELEKTRISCHE N SCHLAGES ODER EINER EXPLOSION.</b></p> <ul style="list-style-type: none"> <li>• Stellen Sie jeglichen Strom ab, der dieses Gerät versorgt, bevor Sie an dem Gerät Arbeiten durchführen</li> <li>• Vor dem Drehen auf Energie alle Anschlüsse überprüfen und alle Abdeckungen ersetzen.</li> </ul> <p><b>Unterlassung dieser Anweisungen können zum Tode oder zu schweren Verletzungen führen.</b></p>	<p><b>RISCHIO DI SCOSSA ELETTRICA O DELL'ESPLOSIONE.</b></p> <ul style="list-style-type: none"> <li>• Spenga tutta l'alimentazione e che fornisce questa apparecchiatura prima del lavorare a questa apparecchiatura</li> <li>• Verificare tutti i collegamenti e sostituire tutte le coperture prima della rotazione sull'alimentazione</li> </ul> <p><b>L'omissione di seguire queste istruzioni provocherà la morte o di lesioni serie</b></p>	<p><b>RISCO DE DESCARGA ELÉTRICA OU EXPLOÇÃO</b></p> <ul style="list-style-type: none"> <li>• Desconectar o equipamento de toda a energia antes de instalar ou trabalhar com este equipamento</li> <li>• Verificar todas as conexões e recolocar todas as tampas antes de religar o equipamento</li> </ul> <p><b>O não cumprimento destas instruções pode levar à morte ou lesões sérias.</b></p>

 <b>WARNING / AVERTISSEMENT / WARNUNG /ADVERTENCIA / AVVERTENZA / AVISO</b>		
<p><b>RISK OF MATERIAL DAMAGE AND HOT ENCLOSURE</b></p> <ul style="list-style-type: none"> <li>• The product's side panels may be hot, allow time for product to cool before touching.</li> <li>• Follow proper mounting instructions including torque values.</li> <li>• Do not allow liquids or foreign objects to enter this product.</li> </ul> <p><b>Failure to follow this instruction can result in serious injury, or equipment damage.</b></p>	<p><b>RISQUE DE DOMMAGE MATERIEL ET DE SURCHAUFFE DU BOITIER</b></p> <ul style="list-style-type: none"> <li>• Les panneaux latéraux du produit peuvent être chauds. Laisser le produit refroidir avant de le toucher.</li> <li>• Respecter les consignes de montage, et notamment les couples de serrage.</li> <li>• Ne pas laisser pénétrer de liquide ni de corps étrangers à l'intérieur du produit.</li> </ul> <p><b>Le non-respect de cette directive peut entraîner, des lésions corporelles graves ou des dommages matériels.</b></p>	<p><b>GEFAHR VON MATERIALSCHÄDEN UND GEHÄUSEERHITZUNG</b></p> <ul style="list-style-type: none"> <li>• Die Seitenwände können heiß sein. Lassen Sie das Produkt abkühlen, bevor Sie es berühren.</li> <li>• Beachten Sie die Montageanweisungen,</li> <li>• Führen Sie keine Flüssigkeiten oder Fremdkörper in das Produkt ein.</li> </ul> <p><b>Die Nichtbeachtung dieser Anweisung kann Körperverletzung oder Materialschäden zur Folge haben.</b></p>
<p><b>RIESGO DE DAÑOS MATERIALES Y DE SOBRECALENTAMIENTO DE LA UNIDAD</b></p> <ul style="list-style-type: none"> <li>• Los paneles laterales del producto pueden estar calientes. Esperar que el producto se enfríe antes de tocarlo.</li> <li>• Respetar las instrucciones de montaje, y en particular los pares de apretado.</li> <li>• No dejar que penetren líquidos o cuerpos extraños en el producto.</li> </ul> <p><b>Si no se respetan estas precauciones pueden producirse graves lesiones, daños materiales.</b></p>	<p><b>RISCHIO DI DANNI MATERIALI E D'INVOLUCRO CALDO</b></p> <ul style="list-style-type: none"> <li>• I pannelli laterali dell'apparecchio possono scottare; lasciar quindi raffreddare il prodotto prima di toccarlo.</li> <li>• Seguire le istruzioni di montaggio corrette.</li> <li>• Non far entrare liquidi o oggetti estranei in questo apparecchio.</li> </ul> <p><b>La mancata osservanza di questa precauzione può causare gravi rischi per l'incolumità personale o danni alle apparecchiature.</b></p>	<p><b>RISCO DE DANO MATERIAL E DE AQUECIMENTO</b></p> <ul style="list-style-type: none"> <li>• Os painéis laterais do produto podem estar quentes; dê tempo ao produto para arrefecer antes de lhe tocar.</li> <li>• Siga devidamente as instruções de montagem.</li> <li>• Não permita a entrada de líquidos e de objectos estranhos no produto.</li> </ul> <p><b>A não observância destas precauções pode provocar a morte, ferimentos graves ou danos materiais.</b></p>

**ANNEX - ENVIROMENTAL INFORMATION**

The environmental information disclosed in this annex including the EIP Pollution logo are in compliance with People's Republic of China Electronic Industry Standard SJ/T11364 – 2006, Marking for Control of Pollution Caused by Electronic Information Products.

Part Name	Toxic or hazardous Substance and Elements					
	Lead (Pb)	Mercury (Hg)	Cadmium (Cd)	Hexavalent Chromium (Cr (VI))	Polybrominated biphenyls (PBB)	Polybrominated diphenyl ethers (PBDE)
Semiconductor die	X	0	0	0	0	0
Solder	X	0	0	0	0	0

此附件所标示的包括电子信息产品污染图标的环保信息符合中华人民共和国电子行业标准 **SJ/T11364 - 2006**, 电子信息产品污染控制标识要求



部件名称	有毒有害物质或元素					
	铅 (Pb)	汞 (Hg)	镉 (Cd)	六价铬 (Cr (VI))	多溴联苯 (PBB)	多溴二苯醚 (PBDE)
半导体芯片	X	0	0	0	0	0
焊接点	X	0	0	0	0	0