

Cree® XLamp® XR-E LED

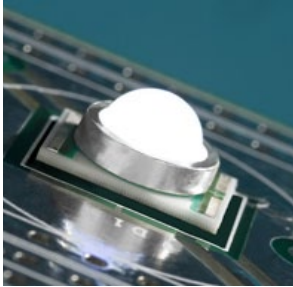

PRODUCT DESCRIPTION

The XLamp XR-E LED is leading the LED lighting revolution with its unprecedented lighting-class brightness, efficacy, lifetime and quality of light. These lighting-class features enable the XLamp XR-E LED to replace many traditional light sources and save money with energy-efficient light and long lifetimes.

Cree XLamp LEDs bring high performance and quality of light to a wide range of lighting applications, including color-changing lighting, portable and personal lighting, outdoor lighting, indoor directional lighting, commercial lighting and emergency-vehicle lighting.

FEATURES

- Guaranteed minimum flux order codes up to 114 lm in white, 30.6 lm in blue and 67.2 lm in green at 350 mA
- Available in white (2,600 K to 10,000 K CCT), blue, royal blue and green
- Maximum drive current: up to 1000 mA
- Industry’s lowest thermal resistance: 8 °C/W
- Max junction temperature: 150 °C
- Industry-leading JEDEC standard pre-qualification testing
- Reflow solderable – JEDEC J-STD-020C compatible
- Electrically neutral thermal path
- RoHS-compliant
- Lumen maintenance of greater than 70% after 50,000 hours

TABLE OF CONTENTS

Flux Characteristics ($T_j = 25\text{ °C}$) - White	2
Flux Characteristics ($T_j = 25\text{ °C}$) - Color.....	3
Characteristics.....	4
Relative Spectral Power Distribution .	5
Relative Flux vs. Junction Temperature ($I_F = 350\text{ mA}$).....	6
Electrical Characteristics ($T_j = 25\text{ °C}$)	7
Thermal Design.....	7
Relative Flux vs. Current ($T_j = 25\text{ °C}$)	8
Typical Spatial Distribution	8
Reflow Soldering Characteristics.....	9
Notes	10
Mechanical Dimensions ($T_A = 25\text{ °C}$)	11
Tape and Reel.....	12
Dry Packaging and Packaging.....	13

FLUX CHARACTERISTICS (T_j = 25 °C) - WHITE

The following tables describe the available colors and flux for XR-E LEDs by listing the correlated color temperature or dominant wavelength range for the entire family and by providing several base order codes. It is important to note that the base order codes listed here are a subset of the total available order codes for the product family. For more order codes, as well as a complete description of the order-code nomenclature, please consult the XR-E & XR-C Binning and Labeling document.

Color	CCT Range		Base Order Codes Min. Luminous Flux (lm)		Order Code
	Min.	Max.	Group	Flux (lm)	
Cool White	5,000 K	10,000 K	P4	80.6	XREWHT-L1-0000-00901
			Q2	87.4	XREWHT-L1-0000-00A01
			Q3	93.9	XREWHT-L1-0000-00B01
			Q4	100	XREWHT-L1-0000-00C01
			Q5	107	XREWHT-L1-0000-00D01
			R2	114	XREWHT-L1-0000-00E01
Neutral White	3,700 K	5,000 K	P3	73.9	XREWHT-L1-0000-008E4
			P4	80.6	XREWHT-L1-0000-009E4
			Q2	87.4	XREWHT-L1-0000-00AE4
			Q3	93.9	XREWHT-L1-0000-00BE4
			Q4	100	XREWHT-L1-0000-00CE4
Warm White	2,600 K	3,700 K	N3	56.8	XREWHT-L1-0000-005E7
			N4	62.0	XREWHT-L1-0000-006E7
			P2	67.2	XREWHT-L1-0000-007E7
			P3	73.9	XREWHT-L1-0000-008E7
			P4	80.6	XREWHT-L1-0000-009E7

Notes:

- Cree maintains a tolerance of +/- 7% on flux and power measurements.
- Typical CRI for Cool White & Neutral White (3,700 K – 10,000 K CCT) is 75.
- Typical CRI for Warm White (2,600 K – 3,700 K CCT) is 80.

FLUX CHARACTERISTICS (T_j = 25 °C) - COLOR

The following tables describe the available colors and flux for XR-E LEDs by listing the correlated color temperature or dominant wavelength range for the entire family and by providing several base order codes. It is important to note that the base order codes listed here are a subset of the total available order codes for the product family. For more order codes, as well as a complete description of the order-code nomenclature, please consult the XR-E & XR-C Binning and Labeling document.

Color	Dominant Wavelength Range				Base Order Codes Min Radiant Flux (mW)		Order Code
	Min.		Max.		Group	Flux (mW)	
	Group	DWL (nm)	Group	DWL (nm)			
Royal Blue	D3	450	D5	465	13	300	XREROY-L1-0000-00801
					14	350	XREROY-L1-0000-00901
					15	425	XREROY-L1-0000-00A01

Color	Dominant Wavelength Range				Base Order Codes Min Luminous Flux (lm)		Order Code
	Min.		Max.		Group	Flux (lm)	
	Group	DWL (nm)	Group	DWL (nm)			
Blue	B3	465	B6	485	J	23.5	XREBLU-L1-0000-00J01
					K	30.6	XREBLU-L1-0000-00K01

Color	Dominant Wavelength Range				Base Order Codes Min. Luminous Flux (lm)		Order Code
	Min.		Max.		Group	Flux (lm)	
	Group	DWL (nm)	Group	DWL (nm)			
Green	G2	520	G4	535	P	67.2	XREGRN-L1-0000-00P01

Note: Cree maintains a tolerance of +/- 7% on flux and power measurements.

CHARACTERISTICS

Characteristics	Unit	Minimum	Typical	Maximum
Thermal Resistance, junction to solder point	°C/W		8	
Viewing Angle (FWHM) - white	degrees		90	
Viewing Angle (FWHM) - royal blue, blue, green	degrees		100	
Temperature coefficient of voltage - white, royal blue, blue, green	mV/°C		-4.0	
ESD Classification (HBM per Mil-Std-883D)			Class 2	
DC Forward Current - white ≥ 5000 K, royal blue, blue	mA			1000
DC Forward Current - white < 5000 K, green	mA			700
DC Pulse Current (@ 1 kHz, 10% duty cycle)	A			1.8
Reverse Voltage	V			5
Forward Voltage (@ 350 mA)	V		3.3	3.9
Forward Voltage (@ 700 mA)	V		3.5	
Forward Voltage (@ 1000 mA) - white ≥ 5000 K, royal blue, blue	V		3.7	
LED Junction Temperature*	°C			150

* Note: For lumen maintenance data, see the Cree XLamp LED Reliability document.

RELATIVE SPECTRAL POWER DISTRIBUTION

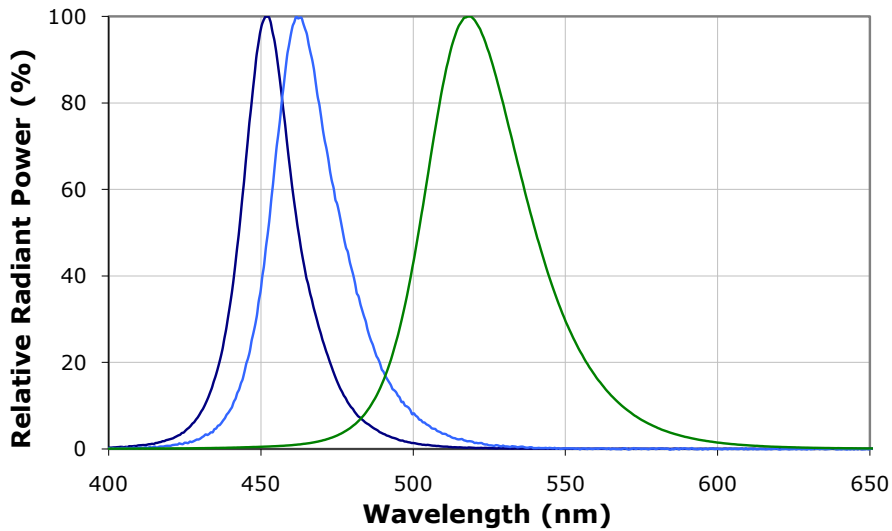
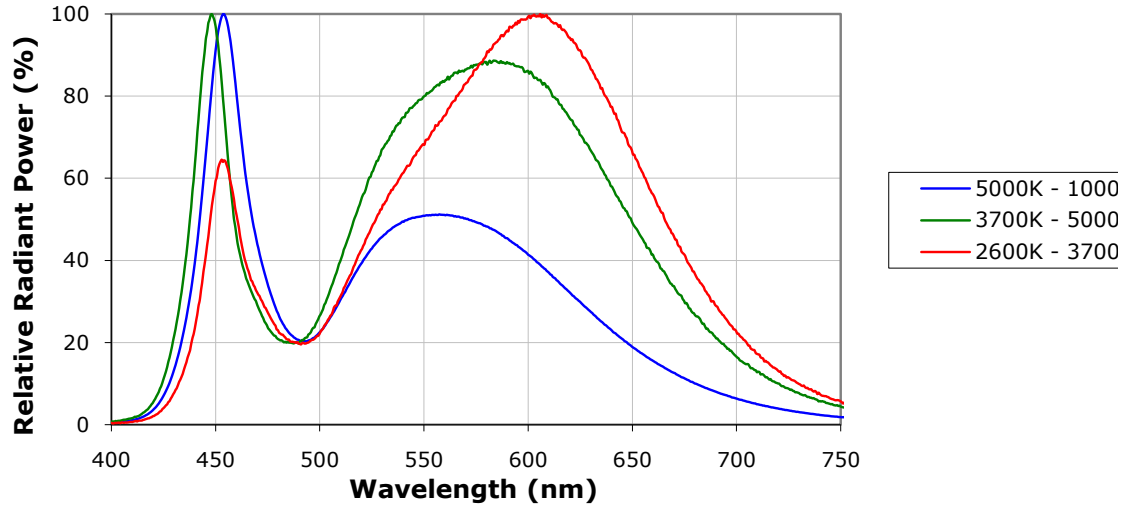

RELATIVE FLUX VS. JUNCTION TEMPERATURE (IF = 350 MA)

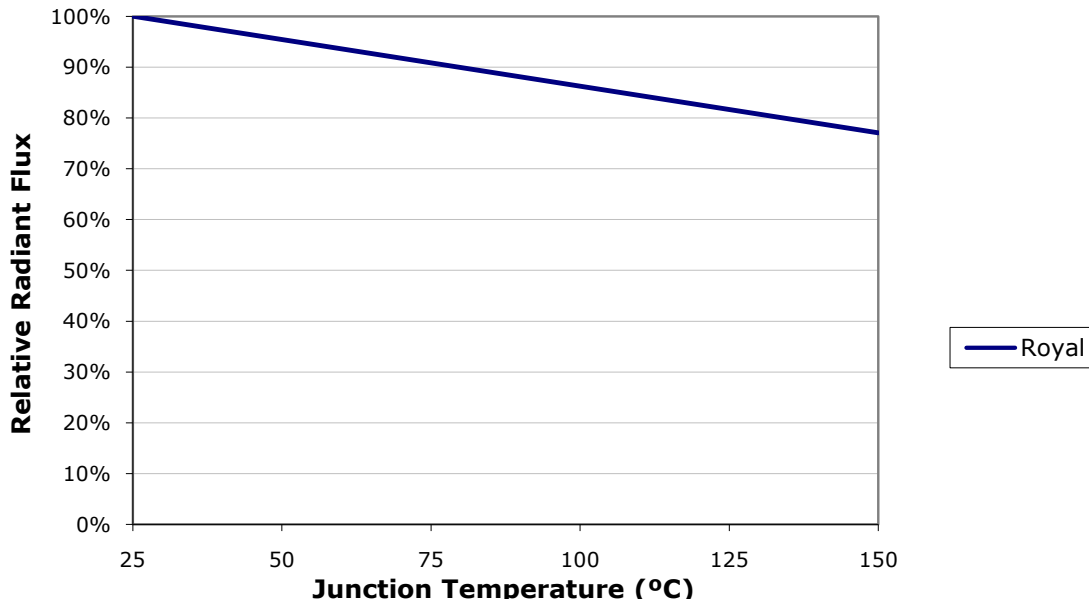
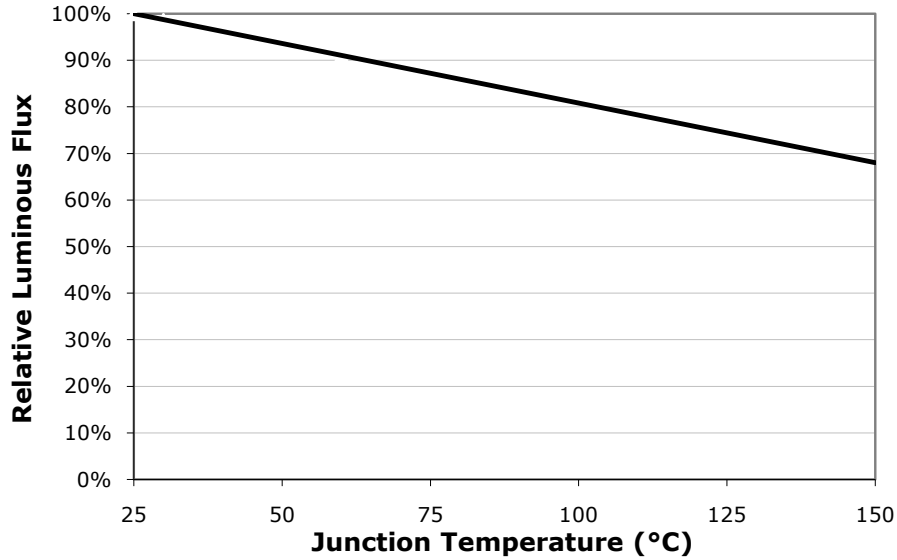

ELECTRICAL CHARACTERISTICS ($T_j = 25\text{ }^\circ\text{C}$)



THERMAL DESIGN



White \geq 5,000 K, Royal Blue, Blue

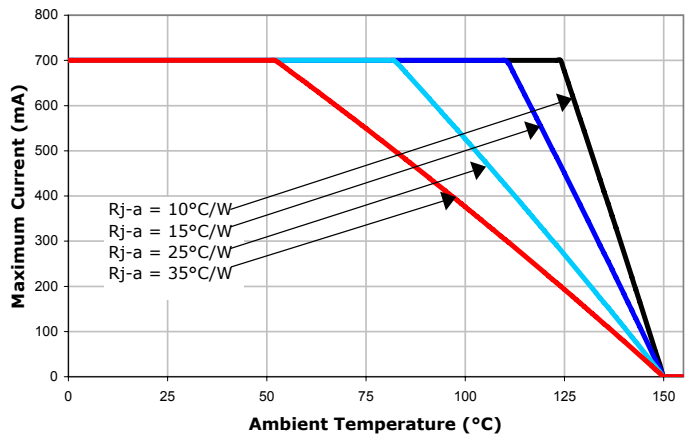

White < 5,000 K, Green

RELATIVE FLUX VS. CURRENT ($T_j = 25\text{ }^\circ\text{C}$)

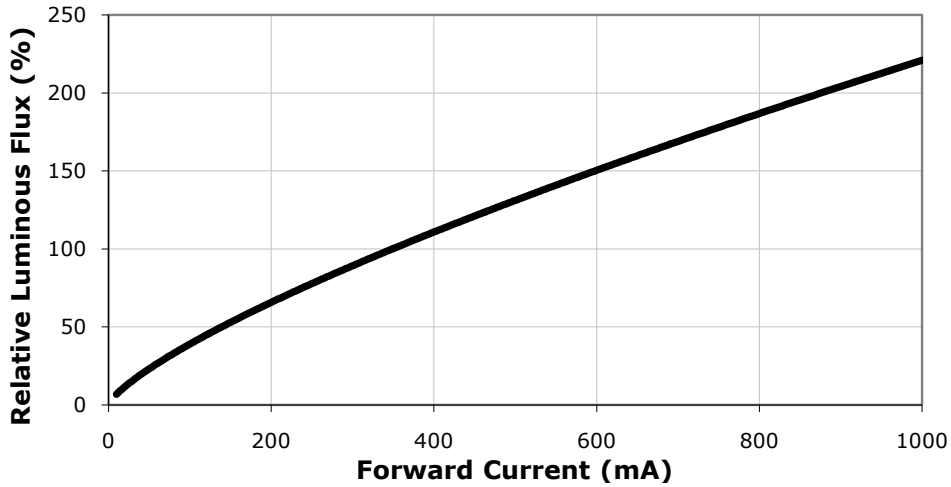

TYPICAL SPATIAL DISTRIBUTION

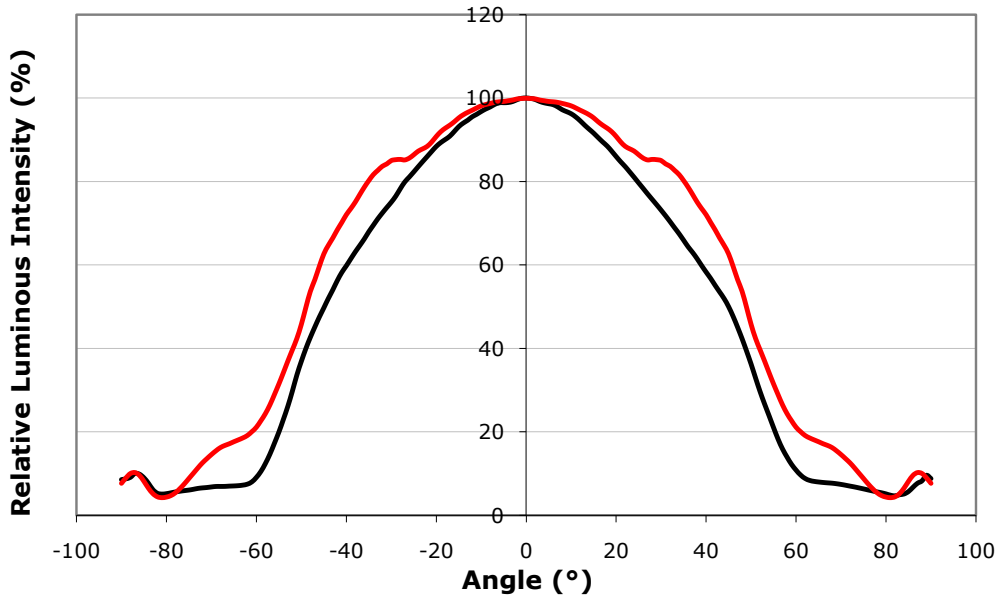

REFLOW SOLDERING CHARACTERISTICS

In testing, Cree has found XLamp XR-E LEDs to be compatible with JEDEC J-STD-020C, using the parameters listed below. As a general guideline, Cree recommends that users follow the recommended soldering profile provided by the manufacturer of solder paste used.

Note that this general guideline may not apply to all PCB designs and configurations of reflow soldering equipment.

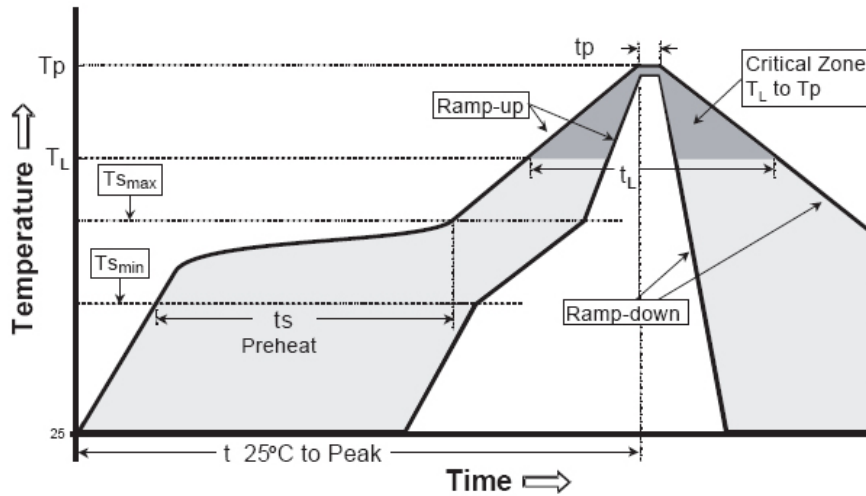

Profile Feature	Lead-Based Solder	Lead-Free Solder
Average Ramp-Up Rate (T_{Smax} to T_p)	3 °C/second max.	3 °C/second max.
Preheat: Temperature Min (T_{Smin})	100 °C	150 °C
Preheat: Temperature Max (T_{Smax})	150 °C	200 °C
Preheat: Time (t_{Smin} to t_{Smax})	60-120 seconds	60-180 seconds
Time Maintained Above: Temperature (T_L)	183 °C	217 °C
Time Maintained Above: Time (t_L)	60-150 seconds	60-150 seconds
Peak/Classification Temperature (T_p)	215 °C	260 °C
Time Within 5 °C of Actual Peak Temperature (t_p)	10-30 seconds	20-40 seconds
Ramp-Down Rate	6 °C/second max.	6 °C/second max.
Time 25 °C to Peak Temperature	6 minutes max.	8 minutes max.

Note: All temperatures refer to topside of the package, measured on the package body surface.

NOTES

Lumen Maintenance Projections

Based on internal long-term reliability testing, Cree projects that white XLamp XR-E LEDs will deliver median 70% lumen maintenance after 50,000 hours of operation at a forward current of 700 mA. This projection is based on constant current operation with junction temperature maintained at or below 135 °C and ambient air temperature maintained at or below 25 °C.

Cree projects royal blue, blue, green and white XLamp XR-E LEDs to maintain a mean 70% lumen maintenance after 50,000 hours, provided the LED junction temperature is maintained at or below 90 °C and ambient air temperature is maintained at or below 85 °C.

Please read the XLamp Long-Term Lumen Maintenance application note for more details on Cree’s lumen maintenance testing and forecasting. Please read the XLamp Thermal Management application note for details on how thermal design, ambient temperature, and drive current affect the LED junction temperature.

Moisture Sensitivity

XLamp LEDs are shipped in sealed, moisture-barrier bags (MBB) designed for long shelf life. If XLamp LEDs are exposed to moist environments after opening the MBB packaging but before soldering, damage to the LED may occur during the soldering operation. The following derating table defines the maximum exposure time (in days) for an XLamp LED in the listed humidity and temperature conditions. LEDs with exposure time longer than the time specified below must be baked according to the baking conditions listed below.

Temp.	Maximum Percent Relative Humidity						
	30%	40%	50%	60%	70%	80%	90%
30 °C	9	5	4	3	1	1	1
25 °C	12	7	5	4	2	1	1
20 °C	17	9	7	6	2	2	1

Cree recommends keeping XLamp LEDs in their sealed moisture-barrier packaging until immediately prior to use. Cree also recommends returning any unused LEDs to the resealable moisture-barrier bag and closing the bag immediately after use.

Baking Conditions

It is not necessary to bake all XLamp LEDs. Only the LEDs that meet all of the following criteria must be baked:

1. LEDs that have been removed from the original MBB packaging.
2. LEDs that have been exposed to a humid environment longer than listed in the Moisture Sensitivity section above.
3. LEDs that have not been soldered.

LEDs should be baked at 80 °C for 24 hours. LEDs may be baked on the original reels. Remove LEDs from MBB packaging before baking. Do not bake parts at temperatures higher than 80 °C. This baking operation resets the exposure time as defined in the Moisture Sensitivity section above.

Storage Conditions

XLamp LEDs that have been removed from original MBB packaging but not soldered yet should be stored in a room or cabinet that will maintain an atmosphere of 25 ± 5 °C and no greater than 10% RH (relative humidity). For LEDs stored in these conditions, storage time does not add to exposure time as defined in the Moisture Sensitivity section above.

RoHS Compliance

The levels of environmentally sensitive, persistent biologically toxic (PBT), persistent organic pollutants (POP), or otherwise restricted materials in this product are below the maximum concentration values (also referred to as the threshold limits) permitted for such substances, or are used in an exempted application, in accordance with EU Directive 2002/95/EC on the restriction of the use of certain hazardous substances in electrical and electronic equipment (RoHS), as amended through April 21, 2006.

Vision Advisory Claim

WARNING: Do not look at exposed lamp in operation. Eye injury can result. See LED Eye Safety at www.cree.com/products/pdf/XLamp_EyeSafety.pdf.

Intellectual Property

For remote phosphor applications, a separate license to certain Cree patents is required.

MECHANICAL DIMENSIONS ($T_A = 25\text{ }^\circ\text{C}$)

All measurements are $\pm .1\text{mm}$ unless otherwise indicated.

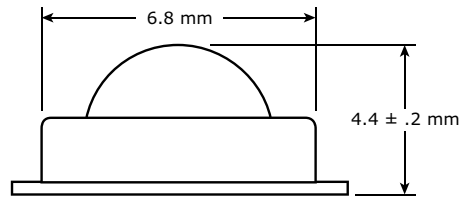
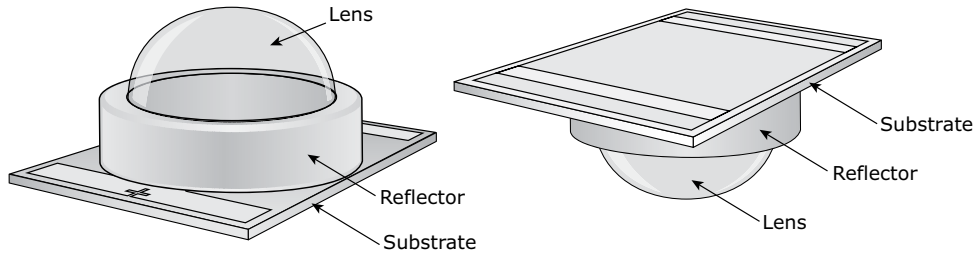

Side View

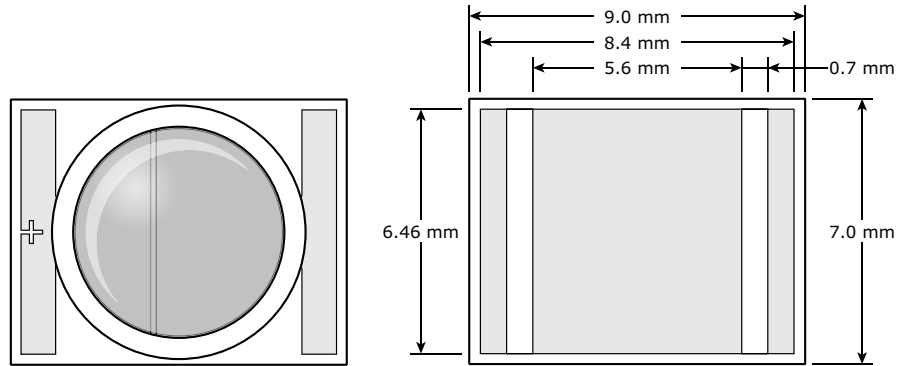

Top View

Bottom View

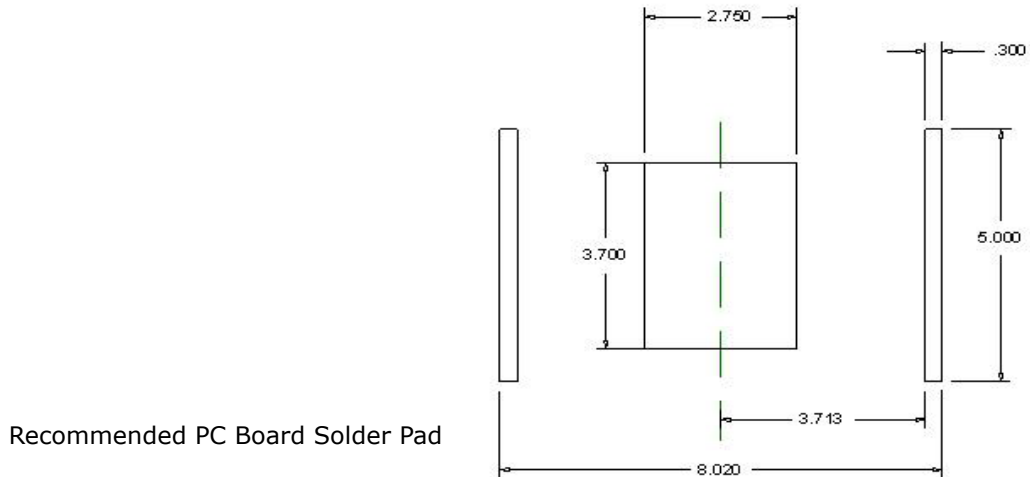

Recommended PC Board Solder Pad

TAPE AND REEL

All Cree carrier tapes conform to EIA-481D, Automated Component Handling Systems Standard.

All dimensions in mm.

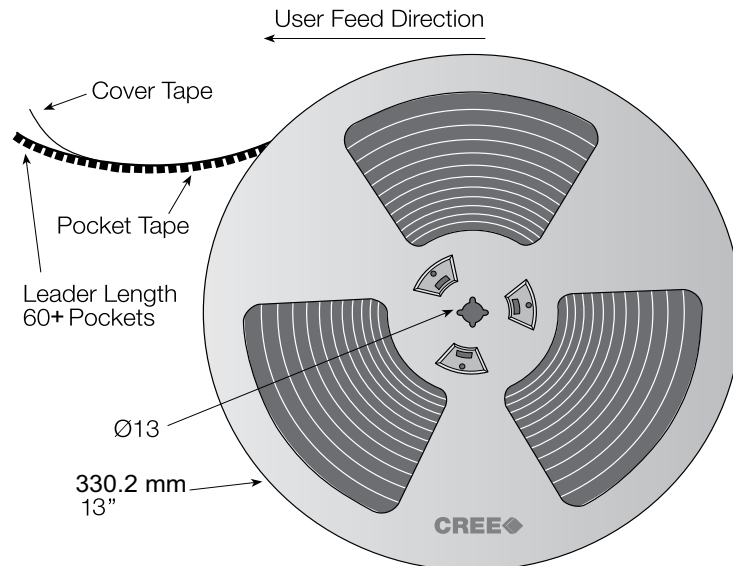
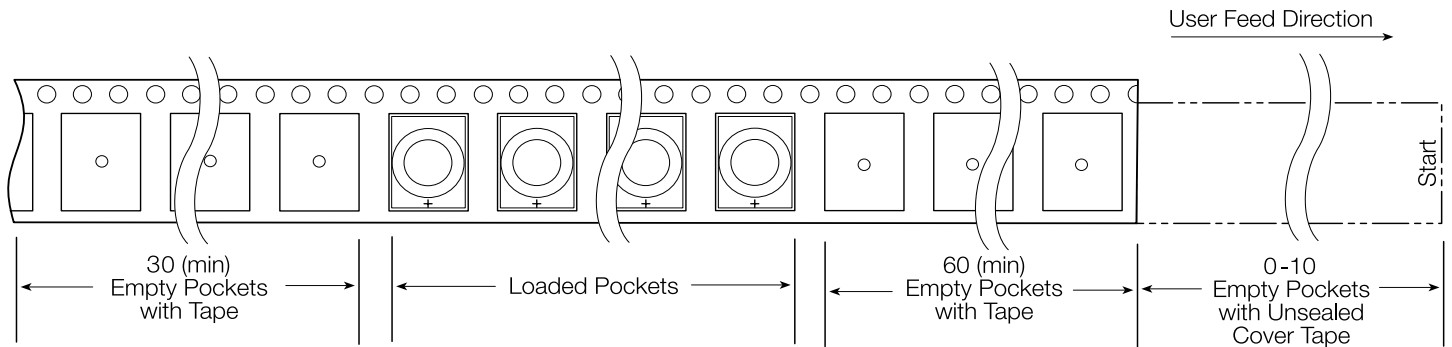
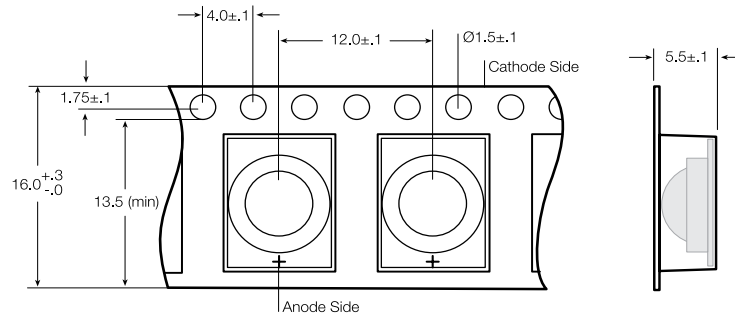

DRY PACKAGING AND PACKAGING

