

**E47 Precision Switch**



**Compact Prewired Switch**



**LS-Titan Miniature DIN Switch**



**E49 Compact Metal Switch**



**Heavy-Duty Factory Sealed 6P+ Switch**



<b>2.0 Introduction</b>	
Technical Reference .....	<b>V8-T2-2</b>
Product Selection Guide .....	<b>V8-T2-3</b>
<b>2.1 E47 Precision Switches</b>	
Product Description .....	<b>V8-T2-6</b>
Product Selection .....	<b>V8-T2-7</b>
<b>2.2 Compact Prewired Switches</b>	
Product Description .....	<b>V8-T2-16</b>
Product Selection .....	<b>V8-T2-17</b>
<b>2.3 LS-Titan Miniature DIN Switches</b>	
Product Description .....	<b>V8-T2-21</b>
Product Selection .....	<b>V8-T2-23</b>
<b>2.4 E49 Mini Metal Switches</b>	
Product Description .....	<b>V8-T2-43</b>
Product Selection .....	<b>V8-T2-44</b>
<b>2.5 E49 Compact Metal Switches</b>	
Product Description .....	<b>V8-T2-49</b>
Product Selection .....	<b>V8-T2-50</b>
<b>2.6 E50 Heavy-Duty Plug-In Switches</b>	
Product Description .....	<b>V8-T2-53</b>
Product Selection .....	<b>V8-T2-54</b>
<b>2.7 E50 Heavy-Duty Factory Sealed 6P+ Switches</b>	
Product Description .....	<b>V8-T2-67</b>
Product Selection .....	<b>V8-T2-68</b>
<b>2.8 Operators</b>	
Product Description .....	<b>V8-T2-79</b>
Product Selection .....	<b>V8-T2-80</b>
<b>2.9 Non Plug-In Switches</b>	
Product Description .....	<b>V8-T2-87</b>
Product Selection .....	<b>V8-T2-88</b>
<b>2.10 Hazardous Location Limit Switches</b>	
Product Description .....	<b>V8-T2-90</b>
Product Selection .....	<b>V8-T2-91</b>
<b>2.11 Special Purpose Limit Switches</b>	
Product Description .....	<b>V8-T2-94</b>
Product Selection .....	<b>V8-T2-95</b>



**Unless otherwise noted, the products contained in this section should not be used for functional safety applications. These products were not designed or tested to IEC 60947-5-3 or recommended for functional safety.**



For Customer Service in the U.S. call 1-877-ETN CARE (386-2273),  
in Canada call 1-800-268-3578.  
For Application Assistance in the U.S. and Canada  
call 1-800-426-9184.

# Revision notes

## Volume 8—Sensing Solutions, CA08100010E

### Tab 2—Limit Switches

Revision date	Section	Change page(s)	Description
12/05/2018	2.3	V8-T2-21, V8-T2-22	Content edit.
12/05/2018	2.3	V8-T2-26–V8-T2-29	Remove LSE-AU product.
12/05/2018	2.3	V8-T2-32–V8-T2-36	Remove LSE-AU product.



*Powering Business Worldwide*

#### Technical Reference

#### Limit Switches

2



Mechanical Limit Switches are contact sensors widely used for detecting the presence or position of objects in industrial applications.

Limit Switches offer high precision in terms of accuracy and repeatability. This is primarily due to the fact that they make direct contact with the target. When an object contacts the limit switch lever (or plunger) the lever moves a pre-travel distance to the operating point where the contacts are tripped. Movement of the lever beyond this point is called the over-travel.

Limit switches contain the following major components. These may be modular or part of a single-piece switch.

#### Limit Switch Components

#### Lever Type Actuator

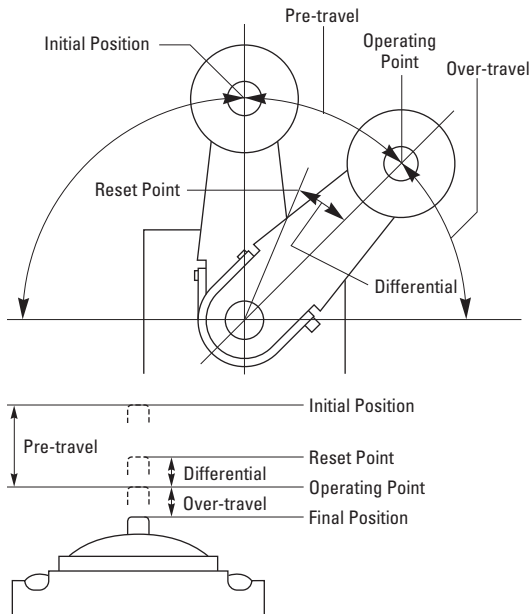

Refer to Sensor Learning Course, **Page V8-T12-4**, for a complete description of limit switch terminology.

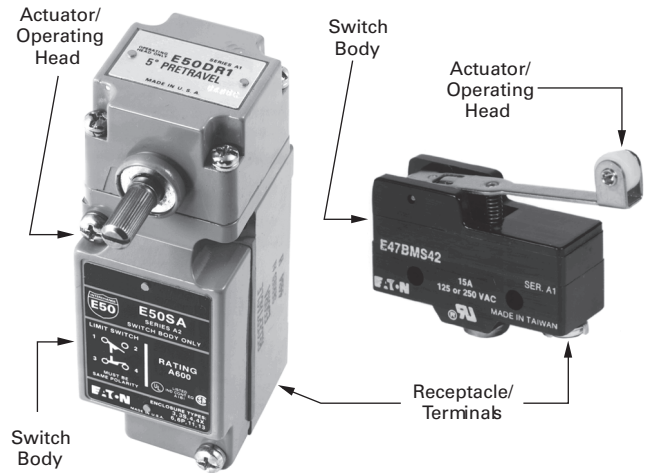

#### Actuator

This is the part of the switch that contacts the target. Typical actuators are levers and plungers. Several styles are available, see Sensor Learning Course, **Page V8-T12-4**, for more information.

#### Switch Body

This part contains the electrical contact mechanism. For complete information on electrical outputs, see Sensor Learning Course, **Page V8-T12-4**.

#### Terminals

The terminals are the point of connection for the wiring. These terminals may be on the body itself, or housed in a removable receptacle. The limit switch may also come equipped with a factory installed cable or pin-connector.

## Product Selection Guide

### E47 Precision Switches



#### Page V8-T2-6

##### Overview

Specified when accurate repeatability, choice of operating forces and travel characteristics and tightly controlled action of cam or target in space restricted areas are of prime importance. Cost effective and compact.

##### Applications

Overhead, folding and elevator doors, sliding gates, automated guided vehicles and commercial instrumentation

##### Product Features

Self-contained switches or with an enclosed cast housing for increased durability and conduit connection (1/2 in NPT)

High current capacity for power load switching and motor handling capability

Screw and solder terminations

Booted enclosed version shields actuators from debris

Mounting centers—1.0 in (25.4 mm), #8 screw size

##### Technical Data and Specifications

Mechanical life: 3,000,000 operations min.

Electrical life: 500,000 operations min.

Contact ratings—  
NEMA A600, R300, AC-15, DC-13  
15A/20A, 125 or 250 Vac

Enclosure ratings—  
Enclosed: NEMA 1

Construction—  
Basic: Phenolic  
Enclosed: Aluminum die cast

##### Approvals

UL® Recognized, E117028  
UL tested to Canadian safety standards  
RoHS Compliant



### Compact Prewired Switches



#### Page V8-T2-16

##### Overview

Designed to be a versatile, slim device for hard to fit applications where sealing integrity is required.

##### Applications

Machine tool, food processing and packaging

##### Product Features

Rugged aluminum alloy die cast housing  
Sealed construction with enclosure ratings of NEMA 4, 6 and 13, IEC IP69K

Prewired with 3m of 18 AWG, AWM 2517, 300V cable

Stackable ridge for ganged operation

##### Technical Data and Specifications

Mechanical life: 10,000,000 operations min.

Electrical life: 200,000 operations  
30 operations min.

Contact ratings—  
NEMA B300

Enclosure ratings—  
NEMA 4, 6 and 13; IP67, IP69

Construction—  
Aluminum alloy die cast

##### Approvals

UL Listed, E170645 (cable versions only)  
UL tested to Canadian safety standards  
CE  
RoHS Compliant



### LS-Titan Miniature DIN Switches



#### Page V8-T2-21

##### Overview

Safety position switches with insulated plastic or rugged metal enclosures. Approved for worldwide safety application.

##### Applications

Automatic vending machines, electronic assembly machines, elevators and lifts, injection molding, packaging and safety applications

##### Product Features

Modular plug-in head and body components

Positive opening NC contacts for safety applications

Operating heads can be rotated 90 degrees to suit specific direction of operation

##### Technical Data and Specifications

Mechanical life: 8,000,000 operations

Contact ratings—  
AC-15, 6A at 24V, 6A at 230/240V,  
4A at 400/415V;  
DC-13, 3A at 24V, 800 mA at 110V,  
300 mA at 220V

Enclosure ratings—  
IP66, IP67 (by model)

Construction—  
Plastic or metal (by model)

##### Approvals

Safety function, IEC/EN 60947-5-1  
TÜV-Rheinland certified (LSE models)  
UL Listed, E29184  
CSA Certified, 12528  
CE  
CCC  
RoHS Compliant



### E49 Mini Metal Switches



#### Page V8-T2-42

##### Overview

Suitable for OEMs who require a small, cost-effective solution but cannot sacrifice durability and mechanical life as they would if they chose a plastic IEC style switch.

##### Applications

Automatic vending machines, electronic assembly machines, elevators and lifts, injection molding, packaging

##### Product Features

Pre-wired units with custom cable lengths available for high volume customers

"Fingerproof" terminals protect against accidental shock

Double-spring mechanism for contact reliability

Grounding terminal included

Captive screws on enclosure cover make wiring hassle-free

SPDT double break

##### Technical Data and Specifications

Contact ratings—  
5A at 250 Vac  
5A at 30 Vdc

Enclosure ratings—  
IP65

Construction—  
Zinc alloy

##### Approvals

UL Recognized, E117028  
(Model E49G31C1P3 is not  
UL Recognized)  
CE  
RoHS Compliant



### E49 Compact Metal Switches



Page V8-T2-48

#### Overview

Designed with high mechanical strength for harsh environments. The rugged Aluminum die cast construction provides reliable, oil-tight, waterproof and dustproof sealing for a variety of applications. Snap action 1NO-1NC contacts provide flexibility in design.

#### Applications

Packaging, material handling conveyors, end-of-travel and guarding operations, baler/compactor, industrial door lifts

#### Product Features

Rigid die cast switch housing  
Set position indicator plate for easy maintenance  
High mechanical strength  
Oiltight, waterproof and dustproof construction

#### Technical Data and Specifications

Mechanical life: 15,000,000 operations min.  
Electrical life: 500,000 operations min. at full load  
Contact ratings—  
NEMA A600, R300; AC-15, DC-13  
Enclosure ratings—  
NEMA 4, 4X, 6, 6P, 12, 13; IP65, IP67  
Construction—  
Aluminum die cast

#### Approvals

UL Listed, E170645  
UL tested to Canadian safety standards  
RoHS Compliant



### E50 Heavy-Duty Plug-In Switches



Page V8-T2-52

#### Overview

Versatile in design. High reliability. Low maintenance costs with installation ease. BEST CHOICE for Heavy-Duty Limit Switch applications. Withstands physical and chemical abuse of harsh industrial environments.

#### Applications

Punch presses, waste water treatment, machine tool, automotive, retrieval systems, industrial truck, car wash lines

#### Product Features

Modular operating heads, switch bodies and receptacles are interchangeable without field adjustment  
Order as complete assemblies or components for stocking and manufacturing flexibility  
90 degree total travel, 5 degree pre-travel characteristics are standard features  
Viton® gasket, boot, and seal material offers exceptional chemical resistance  
Rotary head operating mode from CW, CCW or CW and CCW is easily changed without tools

#### Technical Data and Specifications

Mechanical life: 13,000,000 operations min.  
Electrical life: 1,000,000 operations min. at full load (single-pole)  
Contact ratings—  
NEMA A600, R300  
Lighted versions A150, R150  
6A, 120 Vac; 10A continuous  
Enclosure ratings—  
NEMA 1, 3, 3S, 4, 4X, 6, 6P, 13; IP67  
Construction—Zinc die cast

#### Approvals

UL Listed, E170645  
CSA Certified, 50513  
CE (some models)  
RoHS Compliant



### E50 Heavy-Duty Factory Sealed 6P+ Switches



Page V8-T2-66

#### Overview

Designed specifically to withstand the penetrating properties of new cutting fluids (coolants), acid or caustic washes, salt spray, severe vibration, shock and temperature fluctuations, grit and debris.

#### Applications

Automotive, pulp and paper, food processing, waste management, primary metals, machine tool (cutting, forming, bending)

#### Product Features

Tamperproof, one-piece switch body assembly, epoxy filled  
Factory sealed. 6P submersible. Pre-wired with cable, pigtail or pin connector options. All with ground connection  
Utilizes E50 modular operating heads  
Special V-seal on switch body/head connection provides hermetic barrier against fluid ingress  
LED indicating light, 24V–120 Vac/dc neon version too

#### Technical Data and Specifications

Mechanical life: 35,000,000 operations min.  
Electrical life: 1,000,000 operations min. at full load  
Contact ratings—  
NEMA A600, R300  
Lighted versions A150, R150  
6A, 120 Vac; 10A continuous  
Enclosure ratings—  
NEMA 1, 2, 3, 3S, 4, 4X, 6, 6P, 13; IP67, IP69  
Construction—Zinc die cast

#### Approvals

UL Listed, E170645  
CSA Certified, 50513  
CE (some models)  
RoHS Compliant



### Operators



Page V8-T2-78

#### Overview

Wide variety of operator types for rotary and wobble style limit switches.

#### Applications

Used with E50, E50 6P+ and 10316 limit switches

#### Product Features

Rollers and rods available in metal and nonmetal contact surfaces

#### Technical Data and Specifications

Varies by model

#### Approvals

Varies by model

## Non Plug-In Switches



### Page V8-T2-86

#### Overview

The Industrial standard for Non Plug-In Heavy-Duty Limit Switches. Sold as complete assembled units only.

#### Applications

Serving MRO and USER replacement requirements with broad d market coverage

#### Product Features

Side and top rotary, side and top push or wobble operation  
 CW, CCW or CW and CCW operating modes are field convertible  
 Double break-make snap action contacts, same polarity each pole  
 Captive saddle clamp terminals accept up to #12 wire  
 Head can be mounted in any of four discrete positions, intervals of 90 degrees

#### Technical Data and Specifications

Mechanical life: 10,000,000 operations min.  
 Electrical life: 500,000 operations at full load  
 Contact ratings—NEMA A600, R300 6A, 120 Vac; 10A continuous  
 Enclosure ratings—NEMA 1, 4, 13  
 Construction—  
 Zinc die cast

#### Approvals

UL Listed, E170645  
 CSA Certified, 50513



## Hazardous Location Switches



### Page V8-T2-89

#### Overview

Designed for severe environmental service in locations where there exists a danger of an internal or external explosion of flammable gases, vapors, metal alloy or grain dust.

#### Applications

Mining, metal cutting, grain storage, forest products, petrochemical, waste and sewage management, pharmaceutical

#### Product Features

Sealed and unsealed versions available  
 One-way gasket on sealed version keeps liquids out, yet allows a harmless release of gases in the event of an internal explosion  
 Silicon bronze housing provides excellent corrosion resistant properties in extreme NEMA 4X applications  
 Temperature build-up on limit switch surface is dissipated by housing design and materials used  
 Utilizes the operating heads and internal switch mechanisms of the 10316 Non Plug-In line

#### Technical Data and Specifications

NEMA 7, Div. 1, Class I, BCD  
 NEMA 9, Div. 1, Class II, EFG  
 Contact ratings—NEMA B600 3A, 120 Vac; 5A continuous  
 Enclosure ratings—LX: NEMA 7, 9  
 CX: NEMA 1, 4, 7, 9  
 CB: NEMA 1, 4, 4X, 13  
 CBX: NEMA 1, 4, 4X, 7, 9, 13  
 Construction—LX, CX: Aluminum die cast  
 CB, CBX: Silicon bronze

#### Approvals

UL Listed, E170645, E183975  
 UL tested to Canadian safety standards



## Special Purpose Switches



### Page V8-T2-93

#### Overview

Variety of special function limit switch products.

#### Applications

Serving MRO and USER replacement requirements with broad market coverage

#### Product Features

Special function switch lines include:  
 Cabinet door interlocks — when plunger is pulled out, red band indicator visually shows that interlock is defeated  
 Precision switches—1NO-1NC, 2NO-2NC, or operator only. Variety of mounting brackets available  
 Pneumatic time delay—ON delay and OFF delay. Timing range—0.05 to 60 seconds  
 Rotating cam shaft switches

#### Technical Data and Specifications

See **Page V8-T2-96** for more information  
 Enclosure ratings—  
 NEMA 1 or NEMA 4 versions  
 Construction—  
 Zinc die cast  
 PS: Phenolic

#### Approvals

UL Listed, E170645  
 CSA Certified, 50513 (PS and J only)



# 2.1

## Limit Switches

### E47 Precision Switches

#### E47 Precision Switches

2



### E47 Precision Switches

#### Product Description

E47 Precision Switches from Eaton's electrical sector provide high accuracy switching at an affordable price. A variety of standard features, such as current capacity, operating force, travel characteristics and actuators, lets you custom fit the switch to your application.

The switches are available in their compact basic form, or enclosed in a rugged, metal housing.

#### Features

- Compact housings are ideal for use where space is restricted
- Precision, snap-action operators provide accurate repeatability of electrical and mechanical operating characteristics
- High current capacity (up to 20A) allows power load switching and motor handling capability
- Enclosed booted versions shield actuators from debris

### Contents

#### Description

	<i>Page</i>
E47 Precision Switches	
Product Selection	
Basic Switches . . . . .	<b>V8-T2-7</b>
Enclosed Switches . . . . .	<b>V8-T2-8</b>
Accessories . . . . .	<b>V8-T2-9</b>
Technical Data and Specifications . . . . .	<b>V8-T2-9</b>
Dimensions . . . . .	<b>V8-T2-13</b>

Drawings  
Online

### Operating Characteristics

#### Definitions

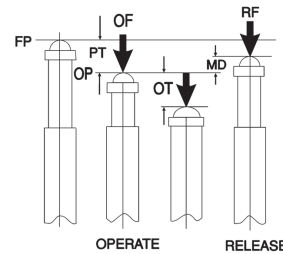

- OF—Operating Force
- RF—Return Force
- PT—Pre-Travel
- OT—Over-Travel
- MD—Movement Differential
- FP—Free Position
- OP—Operating Position

### Standards and Certifications

- UL Recognized, E117028
- UL tested to Canadian safety standards
- RoHS Compliant



#### DANGER

**THIS SENSOR IS NOT A SAFETY DEVICE AND IS NOT INTENDED TO BE USED AS A SAFETY DEVICE. This sensor is designed only to detect and read certain data in an electronic manner and perform no use apart from that, specifically no safety-related use. This sensor product does not include self-checking redundant circuitry, and the failure of this sensor product could cause either an energized or de-energized output condition, which could result in death, serious bodily injury, or property damage.**

For the most current information on this product, visit our Web site: [www.eaton.com](http://www.eaton.com)







For Customer Service in the U.S. call 1-877-ETN CARE (386-2273), in Canada call 1-800-268-3578. For Application Assistance in the U.S. and Canada call 1-800-426-9184.

**Product Selection**

**Basic Switches**

**E47 Precision Switches—Basic**

	Type	15A Catalog Number	20A Catalog Number
<b>Pin Plunger</b> 	Pin Plunger		
	Screw terminal	<b>E47BMS01</b>	<b>E47CMS01</b>
	Solder terminal	<b>E47BML01</b>	<b>E47CML01</b> ①
<b>Extended Plunger</b> 	Extended Plunger		
	Screw terminal	<b>E47BMS03</b>	—
	Solder terminal	<b>E47BML03</b>	—
<b>Straight Plunger</b> 	Straight Plunger		
	Screw terminal	<b>E47BMS02</b>	<b>E47CMS02</b>
	Solder terminal	<b>E47BML02</b>	<b>E47CML02</b>
<b>Reversed Lever</b> 	Reversed Lever		
	Screw terminal	<b>E47BMS21</b>	—
	Solder terminal	<b>E47BML21</b>	—
	Spade terminal	<b>E47BMT21</b>	—
<b>Straight Lever</b> 	Straight Lever		
	Screw terminal	<b>E47BMS22</b>	<b>E47CMS22</b>
	Solder terminal	<b>E47BML22</b>	—
<b>Standard Lever</b> 	Standard Lever		
	Screw terminal	<b>E47BMS20</b>	—
	Solder terminal	<b>E47BML20</b>	—
<b>Extended Straight Plunger</b> 	Extended Straight Plunger		
	Screw terminal	<b>E47BMS04</b>	<b>E47CMS04</b>
	Screw terminal (with space lugs)	<b>E47BMT04</b>	—
	Solder terminal	<b>E47BML04</b>	<b>E47CML04</b>

	Type	15A Catalog Number	20A Catalog Number
<b>Roller Plunger</b> 	Roller Plunger		
	Screw terminal	<b>E47BMS10</b>	<b>E47CMS10</b>
	Solder terminal	<b>E47BML10</b>	—
<b>Cross Roller Plunger</b> 	Cross Roller Plunger		
	Screw terminal	<b>E47BMS11</b>	<b>E47CMS11</b>
	Solder terminal	<b>E47BML11</b>	—
<b>Reversed Roller Lever</b> 	Reversed Roller Lever		
	Screw terminal	<b>E47BMS41</b>	—
	Solder terminal	<b>E47BML41</b>	—
<b>Extended Roller Lever</b> 	Extended Roller Lever		
	Screw terminal	<b>E47BMS42</b>	<b>E47CMS42</b>
	Solder terminal	<b>E47BML42</b>	—
<b>Roller Lever</b> 	Roller Lever		
	Screw terminal	<b>E47BMS30</b>	<b>E47CMS30</b>
	Solder terminal	<b>E47BML30</b>	—
	Spade terminal	<b>E47BMT30</b>	<b>E47CMT30</b>
<b>One-Way Roller</b> 	One-Way Roller		
	Screw terminal	<b>E47BMS31</b>	—
	Solder terminal	<b>E47BML31</b>	—
<b>Integral Leaf</b> 	Integral Leaf		
	Screw terminal	<b>E47BMS23</b>	<b>E47CMS23</b>
	Solder terminal	<b>E47BML23</b>	—

**Note**

① Contact Eaton’s Sensor Applications Department at 1-800-426-9184 for approval status.





# 2.1

## Limit Switches

### E47 Precision Switches



2

#### E47 Precision Switches—Basic, continued







Type	15A Catalog Number	20A Catalog Number
<b>Adjustable Roller</b>	<b>Adjustable Roller</b>	
Screw terminal	<b>E47BMS40</b>	—
Solder terminal	<b>E47BML40</b>	—
		
<b>Extended Adjustable Roller</b>	<b>Extended Adjustable Roller</b>	
Screw terminal	<b>E47BMS43</b>	—
Solder terminal	<b>E47BML43</b>	—
		

#### Enclosed Switches

#### E47 Precision Switches—Enclosed

	Catalog Number
<b>Plunger Actuator</b>	<b>Plunger Actuator</b>
	<b>E47BLS05</b>
	<b>E47CLS05</b> ①②
<b>Booted Plunger</b>	<b>Booted Plunger</b>
	<b>E47BLS06</b>
	<b>E47CLS06</b> ①②
<b>Roller Lever</b>	<b>Roller Lever</b>
	<b>E47BLS32</b>
	<b>E47CLS32</b> ①②

#### E47 Precision Switches—Enclosed, continued



	Catalog Number
<b>Booted Roller Lever</b>	<b>Booted Roller Lever</b>
	<b>E47BLS33</b>
<b>Roller Plunger</b>	<b>Roller Plunger</b>
	<b>E47BLS07</b>
	<b>E47BLS11</b> ③
<b>Booted Roller Plunger</b>	<b>Booted Roller Plunger</b>
	<b>E47BLS08</b>
	<b>E47BLS12</b> ③
<b>One-Way Roller</b>	<b>One-Way Roller</b>
	<b>E47BLS34</b>
<b>Booted One-Way Roller</b>	<b>Booted One-Way Roller</b>
	<b>E47BLS35</b>
<b>Booted Wobble</b>	<b>Booted Wobble</b>
	<b>E47BLS14</b>

#### Notes

- ① Contact Eaton's Sensor Applications Department at 1-800-426-9184 for approval status.
- ② 20 ampere version.
- ③ Cross roller unit.

## Accessories

### Terminal Wire Covers for Basic Switches

	Description	Catalog Number
45° 	Terminal wire cover with 45° conduit interface	E47PA1
90° 	Terminal wire cover with 90° conduit interface	E47PA2

## Technical Data and Specifications

### E47 Precision Switches

Description	Specification
Operating speed	0.01m/second to 1m/second
<b>Operating Frequency</b>	
Mechanical	120 operations/minute
Electrical	20 operations/minute
Mechanical life	3,000,000 operations minimum
Electrical life	500,000 operations minimum
Contact resistance	15M ohms maximum, initial
Insulation resistance	100M ohms minimum at 500 Vdc
<b>Dielectric Strength</b>	
Between non-current carrying parts	1000 Vac, 50/60 Hz for 1 minute
Between current carrying parts and ground	2000 Vac, 50/60 Hz for 1 minute
<b>Ambient Operating Temperature</b>	
Basic	-13° to 176°F (-25° to 80°C)
Enclosed	5° to 176°F (-15° to 80°C)
Environmental rating enclosed, booted	NEMA 1
Mounting centers	1.0 in (25.4 mm), #8 screw size
Terminal screws	Bottom facing M4 x 0.7 Screws with cup washers will accept 22–12 AWG (2.5 sq. mm maximum) Maximum torque: 10 in-lbs.
Threaded bushing	15/32 in
Material of construction	Mineral filled phenolic
Enclosure rating	Aluminum die casting (ADC-3/A380); Seal boot: nitrile, butyl rubber (NBR)
Conduit fitting on enclosed type	1/2 in NPT

#### Maximum Ampere Ratings <sup>①②</sup>

Model	Rated Voltage	Non-Inductive Load (A)			Inductive Load (A)			Inrush Current (A)	
		Resistive Load NC and NO	Lamp Load NC	NO	Inductive Load NC and NO	Motor Load NC	NO	NC	NO
15A	125 Vac	15	3	1.5	15	5	2.5	30 max.	15 max.
	250 Vac	15	2.5	1.25	15	3	1.5		
	500 Vac	3	1.5	0.75	2.5	1.5	0.75		
	8 Vdc	15	3	1.5	15	5	2.5		
	14 Vdc	15	3	1.5	10	5	2.5		
	30 Vdc	6 (2)	3	1.5	5	5	2.5		
	125 Vdc	0.4	0.4	0.4	0.05	0.05	0.05		
	250 Vdc	0.2	0.2	0.2	0.03	0.03	0.03		
20A	125 Vac	20	7.5	7.5	20	12.5	12.5	60 max.	30 max.
	250 Vac	20	7.5	7.5	20	8.3	8.3		
	500 Vac	6	4	4	5	2	2		
	8 Vdc	20	3	1.5	20	12.5	12.5		
	14 Vdc	20	3	1.5	15	12.5	12.5		
	30 Vdc	6	3	1.5	5	5	5		
	125 Vdc	0.5	0.5	0.5	0.05	0.05	0.05		
	250 Vdc	0.25	0.25	0.25	0.03	0.03	0.03		

#### Terminal Configurations

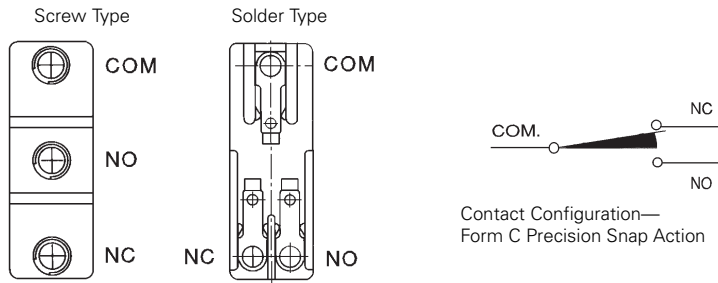

(Spade type not shown, available on some models)

#### Notes

- ① Inductive load has a power factor of 0.04 minimum (AC) and a time constant of 7 m/second (DC).
- ② Lamp load has an inrush current of six times steady-state current.

## E47 Precision Switch Specifications—15 A

Catalog Number	E47B...01-V	E47B...02-V	E47B...03-V	E47B...04-V	E47B...05-V	E47B...06-V	E47B...07-V
Operating force (max.)	12.35 oz (350 g)	12.35 oz (350 g)	12.35 oz (350 g)	12.35 oz (350 g)	8.82–12.3 oz (250–350 g)	28.22 oz (800 g)	8.82–12.3 oz (250–350 g)
Return force (min.)	—	—	—	—	4.02 oz (114 g)	8.47 oz (240 g)	4.02 oz (114 g)
Return force (max.)	4.02 oz (114 g)	4.02 oz (114 g)	4.02 oz (114 g)	4.02 oz (114 g)	—	—	—
Pre-travel (max.)	0.016 in (0.4 mm)	0.016 in (0.4 mm)	0.016 in (0.4 mm)	0.016 in (0.4 mm)	0.016 in (0.4 mm)	0.079 in (2 mm)	0.02 in (0.5 mm)
Overtravel (max.)	0.005 in (0.13 mm)	0.063 in (1.6 mm)	0.063 in (1.6 mm)	0.217 in (5.5 mm)	0.217 in (5.5 mm)	0.197 in (5 mm)	0.142 in (3.6 mm)
Movement differential (max.)	0.002 in (0.05 mm)	0.002 in (0.05 mm)	0.002 in (0.05 mm)	0.002 in (0.05 mm)	0.002 in (0.05 mm)	0.004 in (0.1 mm)	0.002 in (0.05 mm)
Free position (max.)	—	—	—	—	—	—	—
Operating position (max.)	0.626 in (15.9 mm)	0.846 in (21.5 mm)	1.11 in (28.2 mm)	0.858 in (21.8 mm)	1.504 in (38.2 mm)	1.803 in (45.8 mm)	1.957 in (49.7 mm)

Catalog Number	E47B...08-V	E47B...10-V	E47B...11-V	E47B...11-V Cross Roller Unit	E47B...12-V Cross Roller Unit	E47B...14-V	E47B...20-V
Operating force (max.)	17.64 oz (500 g)	12.35 oz (350 g)	12.35 oz (350 g)	8.82–12.3 oz (250–350 g)	17.64 oz (500 g)	2.12 oz (60 g)	3.53 oz (100 g)
Return force (min.)	3.53 oz (100 g)	—	—	4.02 oz (114 g)	3.53 oz (100 g)	0.88 oz (25 g)	0.99 oz (28 g)
Return force (max.)	—	4.02 oz (114 g)	4.02 oz (114 g)	—	—	—	—
Pre-travel (max.)	0.039 in (1 mm)	0.016 in (0.4 mm)	0.016 in (0.4 mm)	0.02 in (0.5 mm)	0.039 in (1 mm)	0.52 in (13.2 mm)	0.197 in (5 mm)
Overtravel (max.)	0.138 in (3.5 mm)	0.141 in (3.58 mm)	0.141 in (3.58 mm)	0.142 in (3.6 mm)	0.138 in (3.5 mm)	0.315 in (8 mm)	0.079 in (2 mm)
Movement differential (max.)	0.005 in (0.12 mm)	0.002 in (0.05 mm)	0.002 in (0.05 mm)	0.002 in (0.05 mm)	0.005 in (0.12 mm)	0.039 in (1 mm)	0.039 in (1 mm)
Free position (max.)	—	—	—	—	—	—	0.976 in (24.8 mm)
Operating position (max.)	1.957 in (49.7 mm)	1.315 in (33.4 mm)	1.315 in (33.4 mm)	1.957 in (49.7 mm)	1.957 in (49.7 mm)	—	0.748 in (19 mm)

Catalog Number	E47B...21-V	E47B...22-V	E47B...23-V	E47B...30-V	E47B...31-V	E47B...32-V	E47B...33-V
Operating force (max.)	5.29 oz (150 g)	2.47 oz (70 g)	0.35 oz (10 g)	5.64 oz (160 g)	5.64 oz (160 g)	20.11 oz (570 g)	22.58 oz (640 g)
Return force (min.)	—	0.49 oz (14 g)	0.11 oz (3 g)	1.48 oz (42 g)	1.48 oz (42 g)	6 oz (170 g)	8.11 oz (230 g)
Return force (max.)	0.49 oz (14 g)	—	—	—	—	—	—
Pre-travel (max.)	0.157 in (4 mm)	0.394 in (10 mm)	0.787 in (20 mm)	0.106 in (2.7 mm)	0.106 in (2.7 mm)	0.157 in (4 mm)	0.197 in (5 mm)
Overtravel (max.)	0.063 in (1.6 mm)	0.22 in (5.6 mm)	0.22 in (5.6 mm)	0.094 in (2.4 mm)	0.094 in (2.4 mm)	0.236 in (6 mm)	0.236 in (6 mm)
Movement differential (max.)	0.051 in (1.3 mm)	0.051 in (1.3 mm)	0.118 in (3 mm)	0.02 in (0.5 mm)	0.02 in (0.5 mm)	0.016 in (0.4 mm)	0.016 in (0.4 mm)
Free position (max.)	0.811 in (20.6 mm)	1.11 in (28.2 mm)	—	1.28 in (32.5 mm)	1.717 in (43.6 mm)	—	—
Operating position (max.)	0.685 in (17.4 mm)	0.748 in (19 mm)	0.748 in (19 mm)	1.189 in (30.2 mm)	1.697 in (43.1 mm)	—	—

Catalog Number	E47B...34-V	E47B...35-V	E47B...40-V	E47B...41-V	E47B...42-V	E47B...43-V
Operating force (max.)	20.11 oz (570 g)	22.58 oz (640 g)	17.64 oz (500 g)	5.29 oz (150 g)	5.64 oz (160 g)	21.16 oz (600 g)
Return force (min.)	6 oz (170 g)	8.11 oz (230 g)	6 oz (170 g)	—	0.78 oz (22 g)	10.58 oz (300 g)
Return force (max.)	—	—	—	0.49 oz (14 g)	—	—
Pre-travel (max.)	0.157 in (4 mm)	0.197 in (5 mm)	0.197 in (5 mm)	0.157 in (4 mm)	0.28 in (7.1 mm)	0.118 in (3 mm)
Overtravel (max.)	0.236 in (6 mm)	0.236 in (6 mm)	0.5 in (12.7 mm)	0.063 in (1.6 mm)	0.157 in (4 mm)	0.236 in (6 mm)
Movement differential (max.)	0.016 in (0.4 mm)	0.016 in (0.4 mm)	0.087 in (2.2 mm)	0.051 in (1.3 mm)	0.04 in (1.02 mm)	0.079 in (2 mm)
Free position (max.)	—	—	1.752 in (44.5 mm)	1.252 in (31.8 mm)	1.437 in (36.5 mm)	1.614 in (41 mm)
Operating position (max.)	—	—	1.591 in (40.4 mm)	1.126 in (28.6 mm)	1.189 in (30.2 mm)	1.591 in (40.4 mm)

# 2.1

## Limit Switches

### E47 Precision Switches

2

#### E47 Precision Switch Specifications—20 A

Catalog Number	E47C...01-V	E47C...02-V	E47C...03-V	E47C...04-V	E47C...05-V	E47C...06-V	E47C...07-V
Operating force (max.)	22.93 oz (650 g)	22.93 oz (650 g)	22.93 oz (650 g)	22.93 oz (650 g)	8.82–12.3 oz (250–350 g)	28.22 oz (800 g)	8.82–12.3 oz (250–350 g)
Return force (min.)	7.05 oz (200 g)	7.05 oz (200 g)	7.05 oz (200 g)	7.05 oz (200 g)	4.02 oz (114 g)	8.47 oz (240 g)	4.02 oz (114 g)
Return force (max.)	—	—	—	—	—	—	—
Pre-travel (max.)	0.028 in (0.7 mm)	0.028 in (0.7 mm)	0.028 in (0.7 mm)	0.028 in (0.7 mm)	0.016 in (0.4 mm)	0.079 in (2 mm)	0.02 in (0.5 mm)
Overtravel (max.)	0.005 in (0.13 mm)	0.063 in (1.6 mm)	0.063 in (1.6 mm)	0.217 in (5.5 mm)	0.217 in (5.5 mm)	0.197 in (5 mm)	0.142 in (3.6 mm)
Movement differential (max.)	0.008 in (0.2 mm)	0.008 in (0.2 mm)	0.002 in (0.05 mm)	0.008 in (0.2 mm)	0.002 in (0.05 mm)	0.004 in (0.1 mm)	0.002 in (0.05 mm)
Free position (max.)	—	—	—	—	—	—	—
Operating position (max.)	0.642 in (16.3 mm)	0.866 in (22 mm)	1.13 in (28.7 mm)	0.89 in (22.6 mm)	1.504 in (38.2 mm)	1.803 in (45.8 mm)	1.957 in (49.7 mm)

Catalog Number	E47C...08-V	E47C...10-V	E47C...11-V	E47C...11-V Cross Roller Unit	E47C...12-V Cross Roller Unit	E47C...14-V	E47C...20-V
Operating force (max.)	17.64 oz (500 g)	22.93 oz (650 g)	22.93 oz (650 g)	8.82–12.3 oz (250–350 g)	17.64 oz (500 g)	2.12 oz (60 g)	5.64 oz (160 g)
Return force (min.)	3.53 oz (100 g)	7.05 oz (200 g)	7.05 oz (200 g)	4.02 oz (114 g)	3.53 oz (100 g)	0.88 oz (25 g)	1.48 oz (42 g)
Return force (max.)	—	—	—	—	—	—	—
Pre-travel (max.)	0.039 in (1 mm)	0.028 in (0.7 mm)	0.028 in (0.7 mm)	0.02 in (0.5 mm)	0.039 in (1 mm)	0.52 in (13.2 mm)	0.256 in (6.5 mm)
Overtravel (max.)	0.138 in (3.5 mm)	0.141 in (3.58 mm)	0.141 in (3.58 mm)	0.142 in (3.6 mm)	0.138 in (3.5 mm)	0.315 in (8 mm)	0.047 in (1.2 mm)
Movement differential (max.)	0.005 in (0.12 mm)	0.008 in (0.2 mm)	0.008 in (0.2 mm)	0.002 in (0.05 mm)	0.005 in (0.12 mm)	0.039 in (1 mm)	0.047 in (1.2 mm)
Free position (max.)	—	—	—	—	—	—	—
Operating position (max.)	1.957 in (49.7 mm)	1.362 in (34.6 mm)	1.362 in (34.6 mm)	1.957 in (49.7 mm)	1.957 in (49.7 mm)	—	0.78 in (19.8 mm)

Catalog Number	E47C...21-V	E47C...22-V	E47C...23-V	E47C...30-V	E47C...31-V	E47C...32-V	E47C...33-V
Operating force (max.)	12.35 oz (350 g)	2.82 oz (80 g)	0.35 oz (10 g)	6.35 oz (180 g)	5.64 oz (160 g)	20.11 oz (570 g)	22.58 oz (640 g)
Return force (min.)	1.76 oz (50 g)	0.49 oz (14 g)	0.11 oz (3 g)	1.48 oz (42 g)	1.48 oz (42 g)	6 oz (170 g)	8.11 oz (230 g)
Return force (max.)	—	—	—	—	—	—	—
Pre-travel (max.)	0.157 in (4 mm)	0.394 in (10 mm)	0.787 in (20 mm)	0.106 in (2.7 mm)	0.106 in (2.7 mm)	0.157 in (4 mm)	0.197 in (5 mm)
Overtravel (max.)	0.063 in (1.6 mm)	0.22 in (5.6 mm)	0.22 in (5.6 mm)	0.094 in (2.4 mm)	0.094 in (2.4 mm)	0.236 in (6 mm)	0.236 in (6 mm)
Movement differential (max.)	0.051 in (1.3 mm)	0.05 in (1.27 mm)	0.118 in (3 mm)	0.02 in (0.5 mm)	0.02 in (0.5 mm)	0.016 in (0.4 mm)	0.016 in (0.4 mm)
Free position (max.)	0.811 in (20.6 mm)	1.11 in (28.2 mm)	—	1.28 in (32.5 mm)	1.717 in (43.6 mm)	—	—
Operating position (max.)	0.717 in (18.2 mm)	0.78 in (19.8 mm)	0.748 in (19 mm)	1.205 in (30.6 mm)	1.697 in (43.1 mm)	—	—

Catalog Number	E47C...34-V	E47C...35-V	E47C...40-V	E47C...41-V	E47C...42-V	E47C...43-V
Operating force (max.)	20.11 oz (570 g)	22.58 oz (640 g)	17.64 oz (500 g)	12.35 oz (350 g)	4.23 oz (120 g)	21.16 oz (600 g)
Return force (min.)	6 oz (170 g)	8.11 oz (230 g)	6 oz (170 g)	1.76 oz (50 g)	0.78 oz (22 g)	10.58 oz (300 g)
Return force (max.)	—	—	—	—	—	—
Pre-travel (max.)	0.157 in (4 mm)	0.197 in (5 mm)	0.197 in (5 mm)	0.157 in (4 mm)	0.28 in (7.1 mm)	0.118 in (3 mm)
Overtravel (max.)	0.236 in (6 mm)	0.236 in (6 mm)	0.5 in (12.7 mm)	0.063 in (1.6 mm)	0.157 in (4 mm)	0.236 in (6 mm)
Movement differential (max.)	0.016 in (0.4 mm)	0.016 in (0.4 mm)	0.087 in (2.2 mm)	0.051 in (1.3 mm)	0.04 in (1.02 mm)	0.079 in (2 mm)
Free position (max.)	—	—	1.752 in (44.5 mm)	1.252 in (31.8 mm)	1.437 in (36.5 mm)	1.614 in (41 mm)
Operating position (max.)	—	—	1.591 in (40.4 mm)	1.157 in (29.4 mm)	1.575 in (40 mm)	1.591 in (40.4 mm)

**Dimensions**

Approximate Dimensions in Inches [mm]

**Basic Switches**

**Pin Plunger**

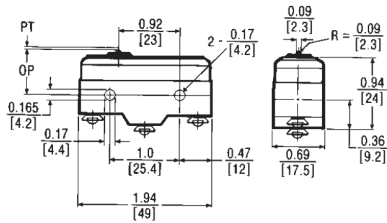

**Standard Lever**

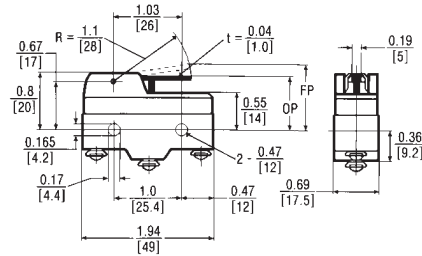

**Extended Plunger**

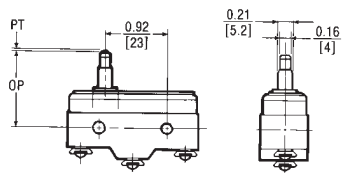

**Extended Straight Plunger**

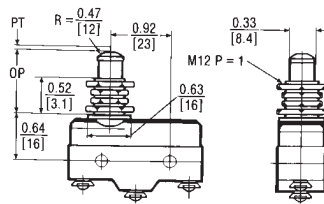

**Straight Plunger**

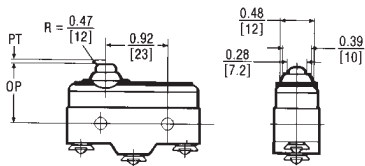

**Roller Plunger**

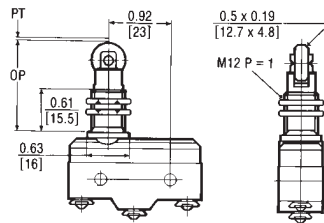

**Reversed Lever**

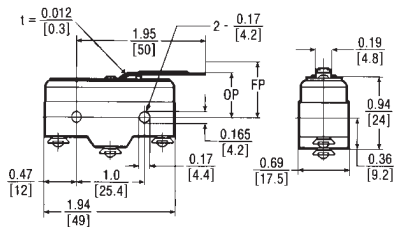

**Cross Roller Plunger**

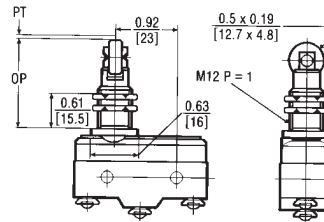

**Straight Lever**

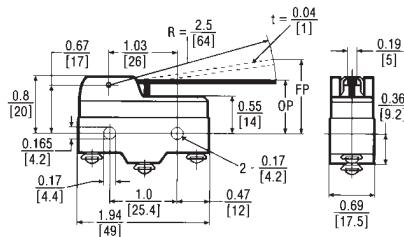

**Reversed Roller Lever**

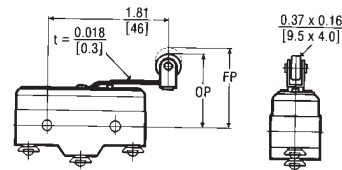

# 2.1

## Limit Switches

### E47 Precision Switches

Approximate Dimensions in Inches [mm]

2

#### Extended Roller Lever

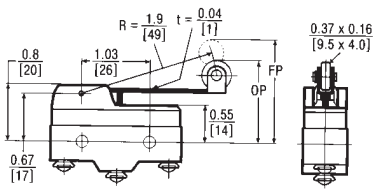

#### Integral Leaf

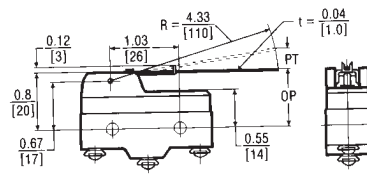

#### Roller Lever

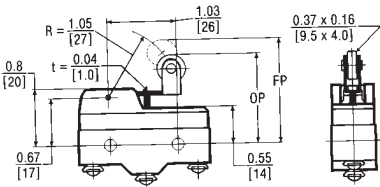

#### Adjustable Roller

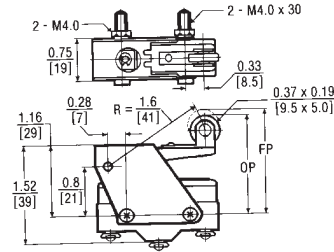

#### One-Way Roller

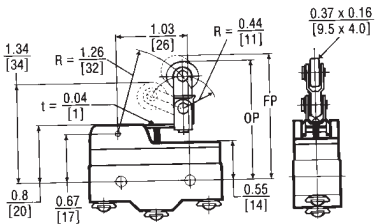

#### Extended Adjustable Roller

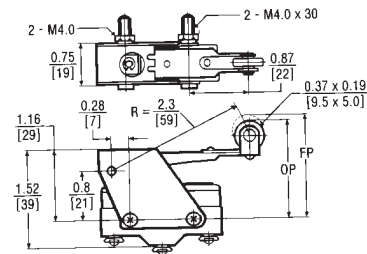

#### Enclosed Switches

##### Plunger Actuator

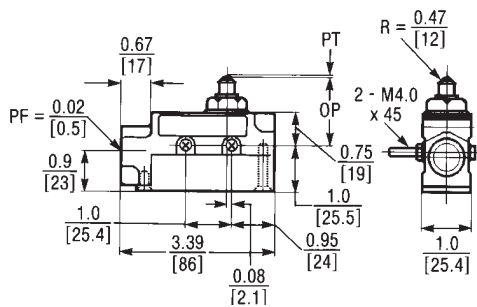

##### Roller Lever

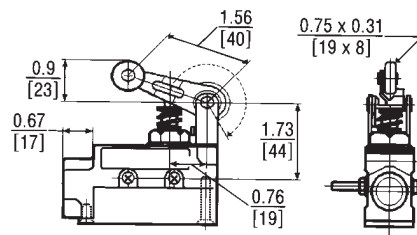

##### Booted Plunger

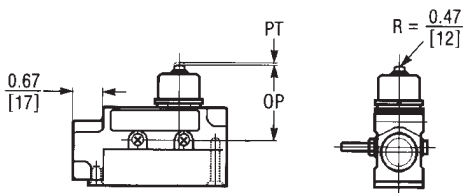

##### Booted Roller Lever

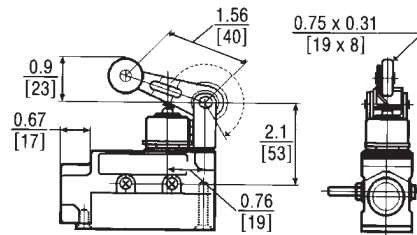

Approximate Dimensions in Inches [mm]

**Roller Plunger**

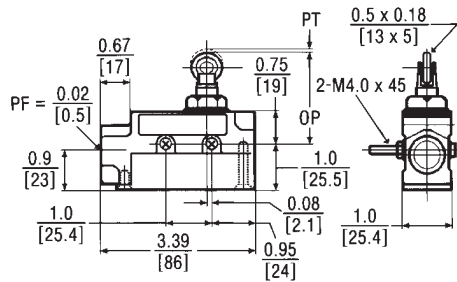

**Booted One-Way Roller**

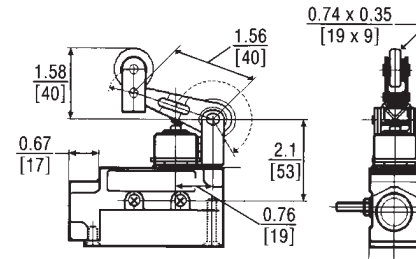

**Booted Roller Plunger**

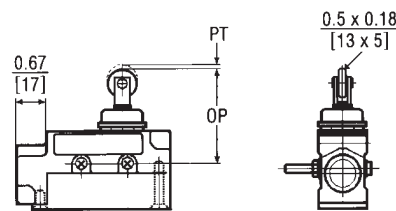

**Booted Wobble**

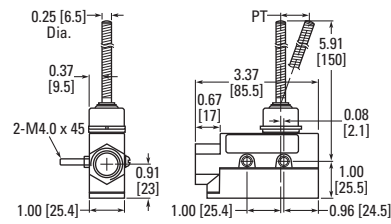

**One-Way Roller**

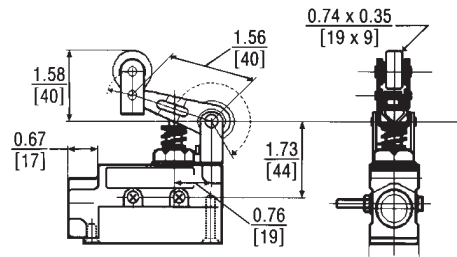

**Accessories**

Approximate Dimensions in mm

**Terminal Wire Cover with 45° Conduit Interface**

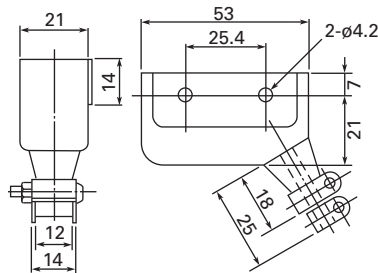

**Terminal Wire Cover with 90° Conduit Interface**

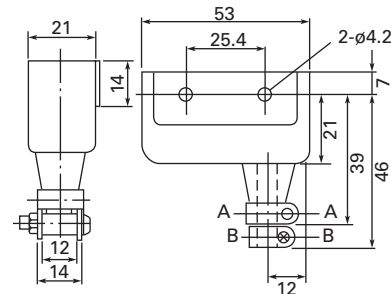



#### Compact Prewired Switches

2



#### Contents

##### Description

	<i>Page</i>
Compact Prewired Switches	
Product Selection .....	<b>V8-T2-17</b>
Technical Data and Specifications .....	<b>V8-T2-18</b>
Wiring Diagram .....	<b>V8-T2-19</b>
Dimensions .....	<b>V8-T2-19</b>

 Drawings  
Online

### Compact Prewired Switches

#### Product Description

The E47 Compact Prewired Limit Switch by Eaton's electrical sector is designed to be a versatile, slim device for hard to fit applications where sealing integrity is required. The rugged die cast aluminum alloy housing, cable connection and switch mechanism are encapsulated for protection against contaminants, moisture, shock and vibration. This factory wired (3m) device has NEMA® enclosure ratings of 4, 6 and 13, making it suitable for applications such as machine tool, food processing and packaging.

#### Features

- Rugged aluminum alloy die cast housing
- Sealed construction with enclosure ratings of NEMA 4, 6 and 13
- Prewired with 3m of 18 AWG, AWM 2517, 300V cable, or micro-connector version also available
- Stackable ridge for ganged operation

#### Standards and Certifications

- UL Listed, E170645 (cable versions only)
- UL tested to Canadian safety standards
- CE
- RoHS Compliant



#### DANGER

**THIS SENSOR IS NOT A SAFETY DEVICE AND IS NOT INTENDED TO BE USED AS A SAFETY DEVICE. This sensor is designed only to detect and read certain data in an electronic manner and perform no use apart from that, specifically no safety-related use. This sensor product does not include self-checking redundant circuitry, and the failure of this sensor product could cause either an energized or de-energized output condition, which could result in death, serious bodily injury, or property damage.**

For the most current information on this product, visit our Web site: [www.eaton.com](http://www.eaton.com)





For Customer Service in the U.S. call 1-877-ETN CARE (386-2273), in Canada call 1-800-268-3578.  
For Application Assistance in the U.S. and Canada call 1-800-426-9184.

Product Selection

Compact Prewired Switches

Actuator Type	Operating Force (Maximum)	Reset Force (Minimum)	Over-Travel (Maximum)	Pre-Travel	Movement Differential (Maximum)	Operating Position	Standard Version Catalog Number	Connector Version Catalog Number
<b>Pin Plunger</b> 	<b>Pin Plunger</b>							
	42.3 oz (1.2 kg)	15.9 oz (450g)	0.118 in (3 mm)	0.07 in (1.8 mm)	0.008 in (0.2 mm)	0.62 ± 0.04 in (15.7 ± 1 mm)	<b>E47BCC05</b>	<b>E47BCC05P4</b>
<b>Sealed Plunger</b> 	<b>Sealed Plunger</b>							
	63.5 oz (1.8 kg)	15.9 oz (450g)	0.118 in (3 mm)	0.07 in (1.8 mm)	0.008 in (0.2 mm)	0.99 ± 0.04 in (24.9 ± 1 mm)	<b>E47BCC06</b>	<b>E47BCC06P4</b>
<b>Roller Plunger</b> 	<b>Roller Plunger</b>							
	42.3 oz (1.2 kg)	15.9 oz (450g)	0.118 in (3 mm)	0.07 in (1.8 mm)	0.008 in (0.2 mm)	1.12 ± 0.04 in (28.5 ± 1 mm)	<b>E47BCC07</b>	<b>E47BCC07P4</b>
<b>Sealed Roller Plunger</b> 	<b>Sealed Roller Plunger</b>							
	63.5 oz (1.8 kg)	15.9 oz (450g)	0.118 in (3 mm)	0.07 in (1.8 mm)	0.008 in (0.2 mm)	1.35 ± 0.04 in (34.3 ± 1 mm)	<b>E47BCC08</b>	<b>E47BCC08P4</b>
<b>Cross Roller Plunger</b> 	<b>Cross Roller Plunger</b>							
	42.3 oz (1.2 kg)	15.9 oz (450g)	0.118 in (3 mm)	0.07 in (1.8 mm)	0.008 in (0.2 mm)	1.12 ± 0.04 in (28.5 ± 1 mm)	<b>E47BCC11</b>	<b>E47BCC11P4</b>
<b>Sealed Cross Roller Plunger</b> 	<b>Sealed Cross Roller Plunger</b>							
	63.5 oz (1.8 kg)	15.9 oz (450g)	0.118 in (3 mm)	0.07 in (1.8 mm)	0.008 in (0.2 mm)	1.35 ± 0.04 in (34.3 ± 1 mm)	<b>E47BCC12</b>	<b>E47BCC12P4</b>
<b>Bevel Plunger</b> 	<b>Bevel Plunger</b>							
	42.3 oz (1.2 kg)	15.9 oz (450g)	0.118 in (3 mm)	0.07 in (1.8 mm)	0.008 in (0.2 mm)	1.12 ± 0.04 in (28.5 ± 1 mm)	<b>E47BCC13</b>	<b>E47BCC13P4</b>

## Compact Prewired Switches, continued

Actuator Type	Operating Force (Maximum)	Reset Force (Minimum)	Over-Travel (Maximum)	Pre-Travel	Movement Differential (Maximum)	Operating Position	Standard Version Catalog Number	Connector Version Catalog Number
<b>Roller Lever</b> 	<b>Roller Lever</b>							
	20.5 oz (580g)	5.3 oz (150g)	40°	25° max.	3°	—	<b>E47BCC15</b>	<b>E47BCC15P4</b>
<b>Wobble Stick</b> 	<b>Wobble Stick</b>							
	5.3 oz (150g)	—	—	15° max.	—	—	<b>E47BCC20</b>	<b>E47BCC20P4</b>
<b>Rod Lever</b> 	<b>Rod Lever</b>							
	20.5 oz (580g)	5.3 oz (150g)	40°	25° max.	3°	—	—	<b>E47BCC21P4</b>
<b>Adjustable Level Arm</b> 	<b>Adjustable Level Arm</b>							
	20.5 oz (580g)	5.3 oz (150g)	40°	25° max.	3°	—	<b>E47BCC22</b>	<b>E47BCC22P4</b>

## Technical Data and Specifications

## Compact Prewired Switches

Description	Specification
Contacts	1-SPDT (Form C)
Mechanical life	10,000,000 operations
Electrical life	200,000 operations, 30 operation/min. at rated load
Operating speed	30 operations per minute maximum
Operating temperature range	−10° to 70°C (14° to 158°F)
Storage temperature range	−10° to 70°C (14° to 158°F)
Humidity	95% maximum non-condensing
Vibration	Malfunction durability, 10 to 55 Hz 1.5 mm double amplitude
Shock	Malfunction durability, approximately 50G
Enclosure ratings	NEMA 4, 6 and 13; IEC IP69K

Maximum Ampere Ratings ①

Rated Voltage	Non-Inductive Load (A)		Inductive Load (A)		Motor Load		Inrush Current (A)	
	NC	NO	NC	NO	NC	NO	NC	NO
125 Vac	5	5	3	3	2.5	1.3	20 max.	10 max.
250 Vac	5	5	2	2	1.5	0.8		
8 Vdc	5	5	5	4	1.5	1.5		
14 Vdc	5	5	4	4	1.5	1.5		
30 Vdc	4	4	3	3	1.5	1.5		
125 Vdc	0.4	0.4	0.4	0.4	0.05	0.05		
250 Vdc	0.2	0.2	0.2	0.2	0.03	0.03		

Wiring Diagram

Compact Prewired Switches

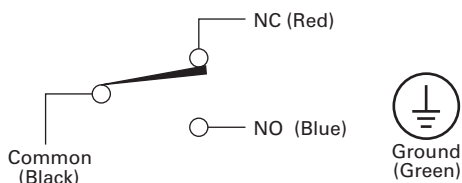

Micro-Connector Switches

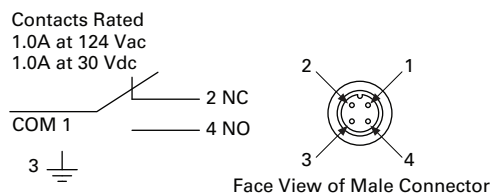

Note

① Inductive load ratings are tested at a power factor 0.4 min. for AC power and a time constant of 7 ms max. for DC power. Inrush current for motor load is six times the steady state current.

Dimensions

Approximate Dimensions in mm [in]

E47BCC05

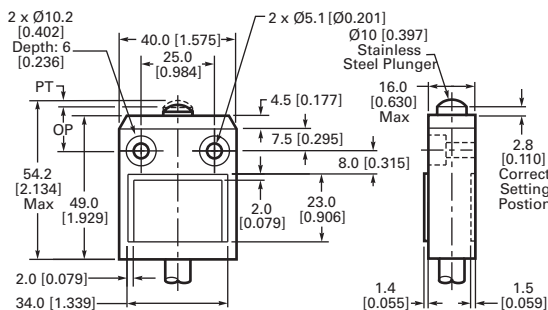

E47BCC07

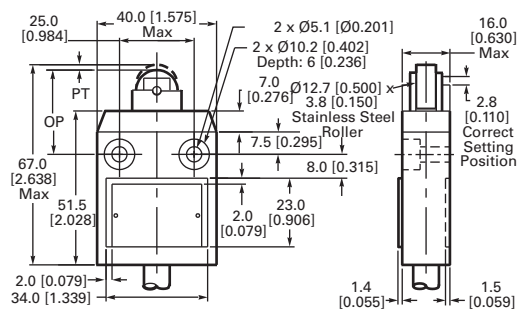

E47BCC06

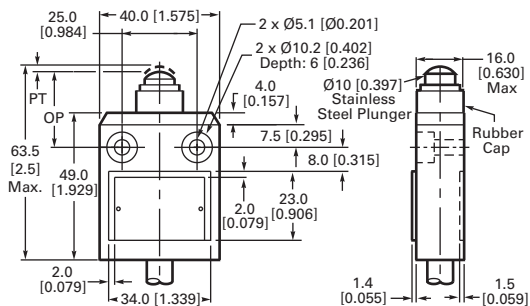

E47BCC08

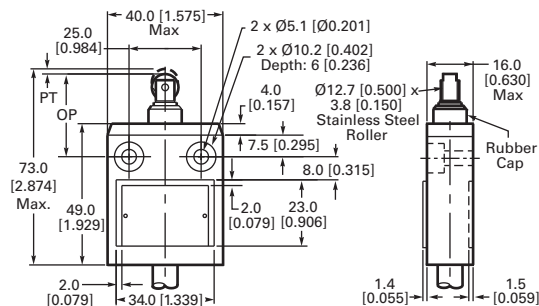

# 2.2

## Limit Switches

### Compact Prewired Switches

2

**E47BCC11**

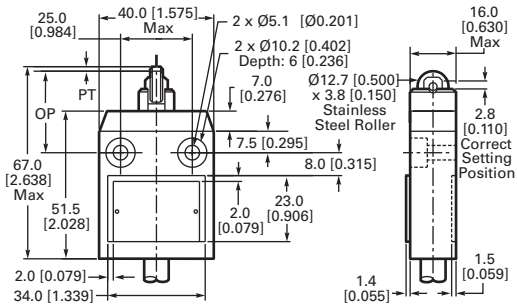

**E47BCC20**

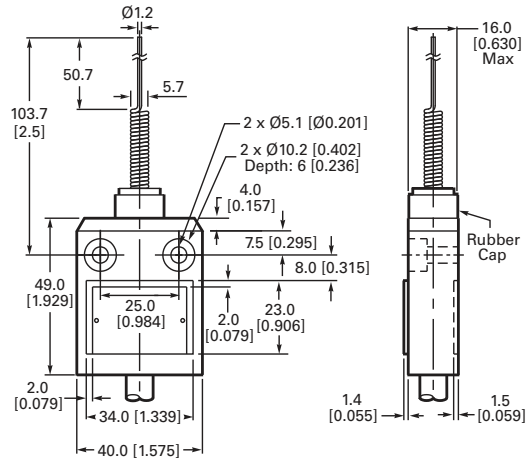

**E47BCC12**

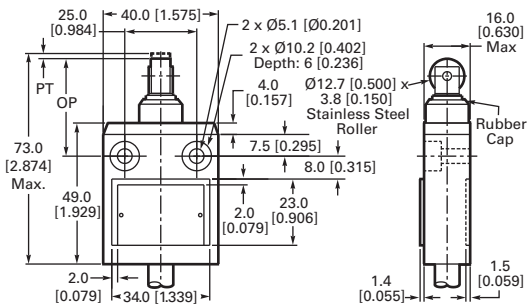

**E47BCC21**

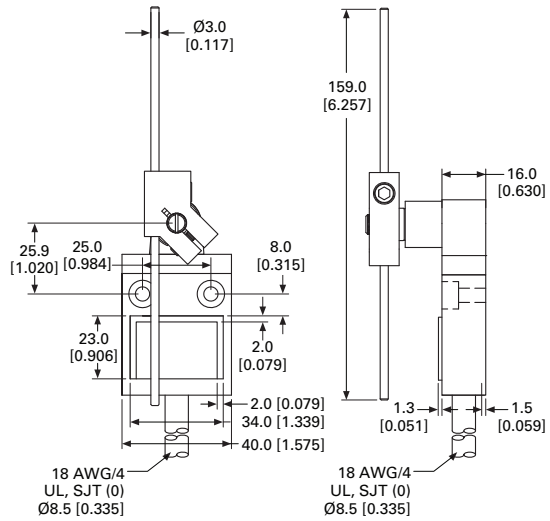

**E47BCC13**

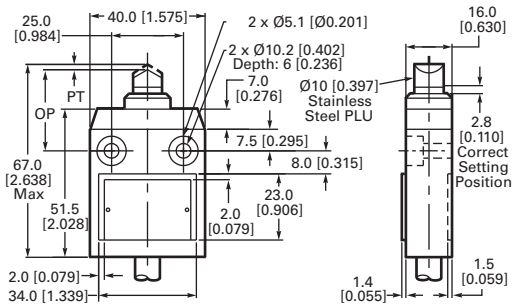

**E47BCC15**

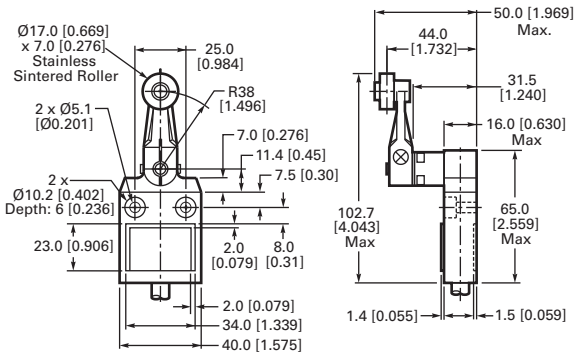

**E47BCC22**

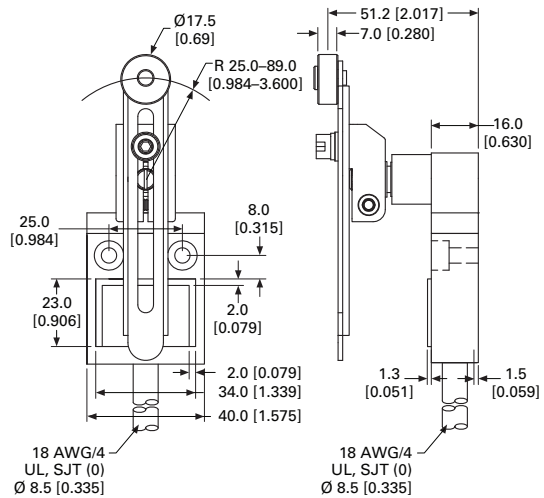

LS-Titan Miniature DIN Switches



Contents

<i>Description</i>	<i>Page</i>
LS-Titan Miniature DIN Switches	
Product Identification . . . . .	<b>V8-T2-22</b>
Product Selection . . . . .	<b>V8-T2-23</b>
LS-Titan Plastic Safety Switches . . . . .	<b>V8-T2-23</b>
LS-Titan Plastic Electronic Safety Position Switches . . . . .	<b>V8-T2-26</b>
LS-Titan Metal Safety Switches . . . . .	<b>V8-T2-30</b>
Understanding LS-Titan Electronic Safety Position Switches . . . . .	<b>V8-T2-32</b>
Operating Point Adjustment . . . . .	<b>V8-T2-32</b>
Accessories . . . . .	<b>V8-T2-33</b>
Technical Data and Specifications . . . . .	<b>V8-T2-34</b>
Contact Travel Diagrams . . . . .	<b>V8-T2-36</b>
Dimensions . . . . .	<b>V8-T2-39</b>

LS-Titan Miniature DIN Switches

Product Description

Eaton’s LS-Titan™ limit switch line is a complete offering of safety position switches designed for worldwide application. Economical insulated plastic or rugged metal enclosures and modular, plug-in operating heads and bodies make LS-Titan a flexible switching solution.

A highlight of the LS-Titan switch line is the world’s first electronic position switch (LSE models). These switches feature freely programmable operating points that can be set individually at any time.

LS-Titan switches are suitable for use in safety applications designed to protect persons or processes.

Features

- Modular, plug-in system (head and body components)
- Positive opening NC contacts for safety applications
- Wide variety of economical plastic and rugged metal versions available
- Operating heads can be rotated 90 degrees to suit specific direction of operation
- Unique electronic safety position switches (LSE models) allow for easy configuration of a custom trip point
- Can be ordered as separate components (head and body) or as completely assembled switches
- Screw and Cage Clamp® (standard on LSE models and optionally available on mechanical models) connections provide larger wiring areas for easier installation
- Approved for worldwide application

Standards and Certifications

- Safety function by positive opening contacts per IEC/EN 60947-5-1
- TÜV-Rheinland Certified for Functional-Safety (LSE models)
- UL Listed, E29184
- CSA Certified, 12528
- RoHS Compliant
- CE
- CCC



**Note:** Cage Clamp is a registered trademark of Wago Kontakttechnik, 32423 Minden, Germany.

For the most current information on this product, visit our Web site: [www.eaton.com](http://www.eaton.com)

For Customer Service in the U.S. call 1-877-ETN CARE (386-2273), in Canada call 1-800-268-3578. For Application Assistance in the U.S. and Canada call 1-800-426-9184.

## Product Identification

2

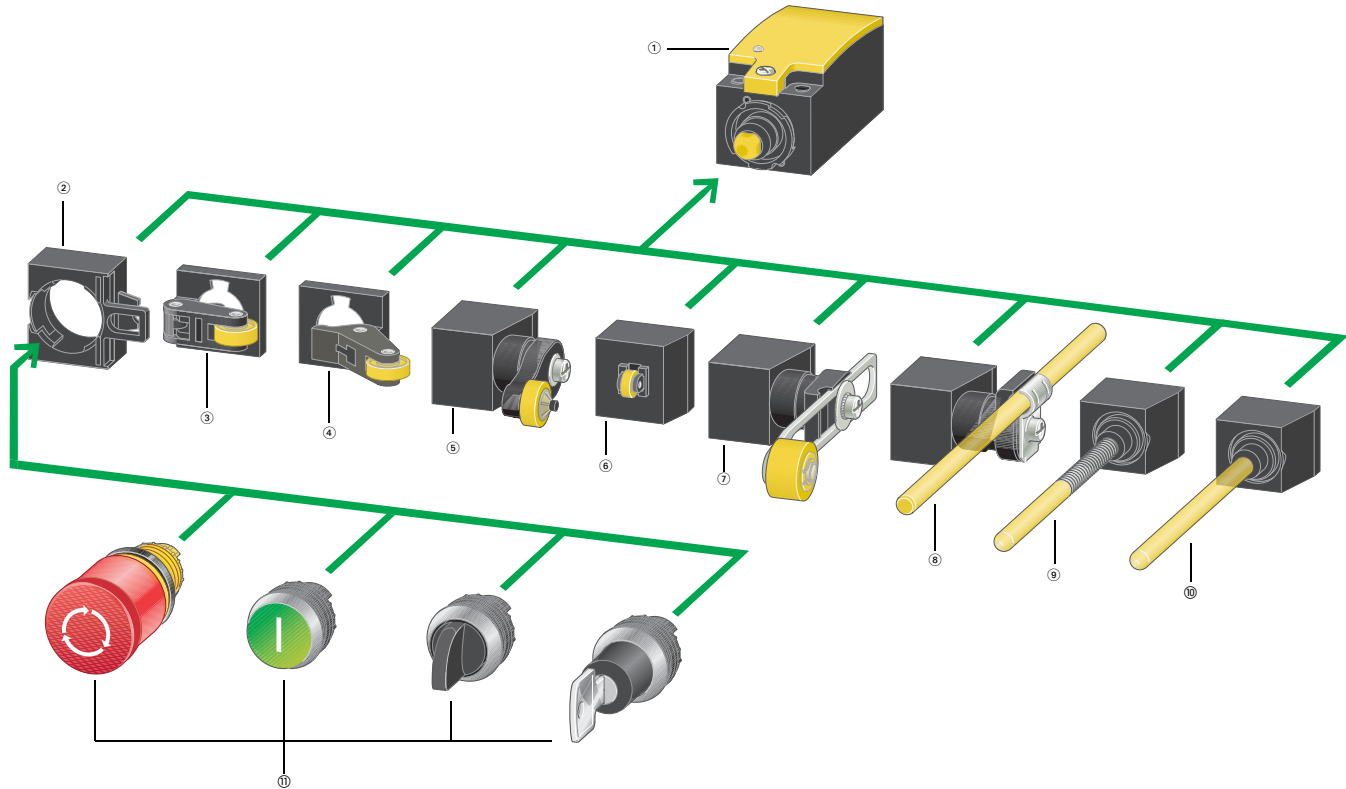

## Notes

- ① **Basic device** (see Pages V8-T2-23 to V8-T2-31)  
According to EN 50047  
With screw-on cover  
Contacts: 1NO-1NC, 2NO, 2NC  
Cage Clamp, screw terminal  
As snap-action or standard-action switch  
As electronic snap-action switch (individually adjustable)
- ② **Fixing adapter** (see Page V8-T2-33)  
Allows mounting of M22 pushbuttons
- ③ **Roller lever** (see Pages V8-T2-23 and V8-T2-26)  
For one-sided operation with higher operating speed
- ④ **Angled roller lever** (see Pages V8-T2-23, V8-T2-26 and V8-T2-30)  
For actuation along the unit axis
- ⑤ **Rotary lever** (see Pages V8-T2-23, V8-T2-27 and V8-T2-30)  
For actuation from the side, for pendulum movements
- ⑥ **Roller plunger** (see Pages V8-T2-23, V8-T2-26 and V8-T2-30)  
For actuation from the side with low actuating force
- ⑦ **Adjustable roller lever** (see Pages V8-T2-24, V8-T2-27, V8-T2-28 and V8-T2-30)  
For length adjustment as required
- ⑧ **Actuating rod** (see Pages V8-T2-25, V8-T2-29 and V8-T2-31)  
On conveyor belts for lightweight goods
- ⑨ **Spring-rod** (see Pages V8-T2-25, V8-T2-29 and V8-T2-31)  
For flexible actuation from all sides
- ⑩ **Actuating rod** (see Pages V8-T2-25, V8-T2-29 and V8-T2-31)  
Withdrawable mechanism from front
- ⑪ Pushbuttons from the M22 family; see M22 catalog (CA04716001E) or [www.eaton.com/m22](http://www.eaton.com/m22)

**Operating heads can be rotated by 90 degrees.**

**Product Selection**

**LS-Titan Plastic Safety Switches**

**Plastic Safety Switches**



**Switch Body Catalog Number**

**Output Function**

**Terminal Connection**

**Contact Sequence**

**Contact Travel**

- = contact closed
- = contact open

**Operating Head Type ②**

**Head Only Catalog Number**

**LS-S02**

2NC with positive opening contacts

Screw terminal ①

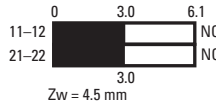

**LS-S20A**

2NO with slow make/break

Screw terminal ①

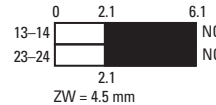

**LS-S11S**

1NO and 1NC with positive opening contact

Screw terminal ①

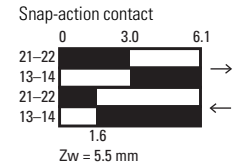

**Assembled Switch Catalog Number**

	LS-XP	LS-S02-P	LS-S20A-P	LS-S11S-P
<b>Top Push Roller Plunger</b>				
<b>Long Roller Lever</b>	LS-XL	LS-S02-L	LS-S20A-L	LS-S11S-L
<b>Short Roller Lever</b>	LS-XLS	LS-S02-LS	LS-S20A-LS	LS-S11S-LS
<b>Large Roller Lever</b>	LS-XLB	LS-S02-LB	LS-S20A-LB	LS-S11S-LB
<b>Angled Roller</b>	LS-XLA	LS-S02-LA	LS-S20A-LA	LS-S11S-LA
<b>Rotary Lever</b>	LS-XRL	LS-S02-RL	LS-S20A-RL	LS-S11S-RL

**Notes**

- ① Cage Clamp versions available. Contact Application Engineering.
- ② For operating head dimensions, see **Page V8-T2-39**.



# 2.3

## Limit Switches

### LS-Titan Miniature DIN Switches

2

**Plastic Safety Switch Body**



**Assembled Switch**



**Plastic Safety Switches, continued**

**Switch Body Catalog Number**  
**Output Function**

**Terminal Connection**  
**Contact Sequence**

**Contact Travel**  
  
 ■ = contact closed  
 □ = contact open

**Operating Head Type** ②  
**Head Only Catalog Number**

**LS-S02**  
2NC with positive opening contacts  
Screw terminal ①

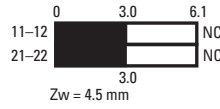

**LS-S20A**  
2NO with slow make/break  
Screw terminal ①

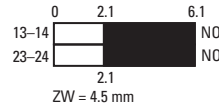

**LS-S11S**  
1NO and 1NC with positive opening contact  
Screw terminal ①

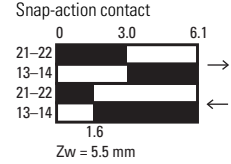

**Assembled Switch Catalog Number**

**Adjustable Roller Lever (with 18 mm Roller)**



**LS-XRLA**

**LS-S02-RLA**

**LS-S20A-RLA**

**LS-S11S-RLA**

**Adjustable Roller Lever (with 30 mm Roller)**



**LS-XRLA30**

**LS-S02-RLA30**

**LS-S20A-RLA30**

**LS-S11S-RLA30**

**Adjustable Roller Lever (with 40 mm Roller)**



**LS-XRLA40**

**LS-S02-RLA40**

**LS-S20A-RLA40**

**LS-S11S-RLA40**

**Adjustable Roller Lever (with 40 mm Rubber Roller)**



**LS-XRLA40R**

**LS-S02-RLA40R**

**LS-S20A-RLA40R**

**LS-S11S-RLA40R**

**Notes**

- ① Cage Clamp versions available. Contact Application Engineering.
- ② For operating head dimensions, see **Page V8-T2-39**.

Plastic Safety Switches, continued

Plastic Safety Switch Body



Assembled Switch



Switch Body Catalog Number

Output Function

Terminal Connection

Contact Sequence

Contact Travel

■ = contact closed  
□ = contact open

Operating Head Type ②

Head Only Catalog Number

LS-S02

2NC with positive opening contacts

Screw terminal ①

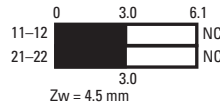

LS-S20A

2NO with slow make/break

Screw terminal ①

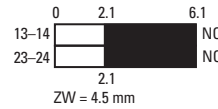

LS-S11S

1NO and 1NC with positive opening contact

Screw terminal ①

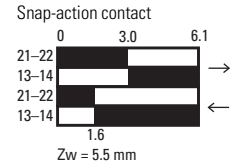

Assembled Switch Catalog Number

Plastic Rod Lever



LS-XRR

LS-S02-RR

LS-S20A-RR

LS-S11S-RR

Metal Rod



LS-XRRM

LS-S02-RRM

LS-S20A-RRM

LS-S11S-RRM

Spring Rod (Wobble) ③



LS-XS

LS-S02-S

LS-S20A-S

LS-S11S-S

Actuating Rod



LS-XOR

LS-S02-OR

LS-S20A-OR

LS-S11S-OR

Notes

- ① Cage Clamp versions available. Contact Application Engineering.
- ② For operating head dimensions, see Page V8-T2-39
- ③ Not to be used as a safety position switch. Use only in conjunction with snap-action contact.

# 2.3

## Limit Switches

### LS-Titan Miniature DIN Switches

#### LS-Titan Plastic Electronic Safety Position Switches

2

##### Plastic Electronic Safety Position Switch Body



##### Assembled Switch



#### Plastic Electronic Safety Position Switches

**Switch Body Catalog Number**  
**Output Function**  
**Terminal Connections**  
**Safety Functions and Approvals**

**LSE-11**

1NO and 1 NC

Cage Clamp ①

**LSE-02**

2NC

Cage Clamp ①

These models may be used in safety-oriented circuits. Visual status LED indication is comparable to positive opening contacts. Certified by TÜV as a "Functional-Safety" device. Suitable for protection of people or processes.



##### Contact Sequence

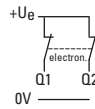
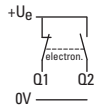

**Contact Travel**  
 = contact closed  
 = contact open

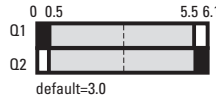
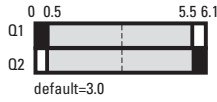

##### Operating Head Type ②

**Head Only Catalog Number**

**Assembled Switch Catalog Number**

##### Top Push Roller Plunger



**LS-XP**

**LSE-11-P**

**LSE-02-P**

##### Long Roller Lever



**LS-XL**

**LSE-11-L**

**LSE-02-L**

##### Short Roller Lever



**LS-XLS**

**LSE-11-LS**

**LSE-02-LS**

##### Large Roller Lever



**LS-XLB**

**LSE-11-LB**

**LSE-02-LB**

##### Angled Roller



**LS-XLA**

**LSE-11-LA**

**LSE-02-LA**

##### Notes

- ① A compatible Cage Clamp tool is available as an accessory on [Page V8-T2-33](#).
- ② For operating head dimensions, see [Page V8-T2-39](#).

Plastic Electronic Safety Position Switches, continued

Plastic Electronic Safety Position Switch Body



**Switch Body**  
**Catalog Number**

**LSE-11**

**LSE-02**

**Output Function**

1NO and 1NC

2NC

**Terminal Connections**

Cage Clamp ①

Cage Clamp ①

**Safety Functions and Approvals**

These models may be used in safety-oriented circuits. Visual status LED indication is comparable to positive opening contacts. Certified by TÜV as a "Functional-Safety" device. Suitable for protection of people or processes.



Assembled Switch



**Contact Sequence**

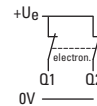
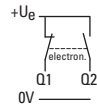

**Contact Travel**

■ = contact closed

□ = contact open

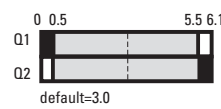
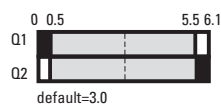

**Operating Head Type ②**

**Head Only**  
**Catalog Number**

**Assembled Switch**  
**Catalog Number**

Rotary Lever



**LS-XRL**

**LSE-11-RL**

**LSE-02-RL**

Adjustable Roller Lever (with 18 mm Roller)



**LS-XRLA**

**LSE-11-RLA**

**LSE-02-RLA**

Adjustable Roller Lever (With 30 mm Roller)



**LS-XRLA30**

**LSE-11-RLA30**

**LSE-02-RLA30**

**Notes**

① A compatible Cage Clamp tool is available as an accessory on **Page V8-T2-33**.

② For operating head dimensions, see **Page V8-T2-39**.

# 2.3

## Limit Switches

### LS-Titan Miniature DIN Switches

2

#### Plastic Electronic Safety Position Switch Body



#### Assembled Switch



### Plastic Electronic Safety Position Switches, continued

#### Switch Body Catalog Number

**LSE-11**

**LSE-02**

#### Output Function

1NO and 1NC

2NC

#### Terminal Connections

Cage Clamp ①

Cage Clamp ①

#### Safety Functions and Approvals

These models may be used in safety-oriented circuits. Visual status LED indication is comparable to positive opening contacts. Certified by TÜV as a "Functional-Safety" device. Suitable for protection of people or processes.



#### Contact Sequence

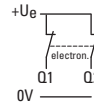
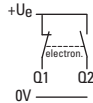

#### Contact Travel

■ = contact closed

□ = contact open

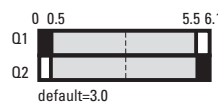
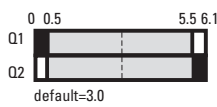

#### Operating Head Type ②

#### Head Only Catalog Number

#### Assembled Switch Catalog Number

#### Adjustable Roller Lever (With 40 mm Roller)



**LS-XRLA40**

**LSE-11-RLA40**

**LSE-02-RLA40**

#### Adjustable Roller Lever (With 40 mm Roller)



**LS-XRLA40R**

**LSE-11-RLA40R**

**LSE-02-RLA40R**

#### Plastic Rod Lever



**LS-XRR**

**LSE-11-RR**

**LSE-02-RR**

#### Notes

① A compatible Cage Clamp tool is available as an accessory on **Page V8-T2-33**.

② For operating head dimensions, see **Page V8-T2-39**.

**Plastic Electronic Safety Position Switches, continued**

**Plastic Electronic Safety Position Switch Body**



**Switch Body**  
**Catalog Number**  
**Output Function**  
**Terminal Connections**

**LSE-11**  
 1NO and 1NC  
 Cage Clamp ①

**LSE-02**  
 2NC  
 Cage Clamp ①

**Safety Functions and Approvals**

These models may be used in safety-oriented circuits. Visual status LED indication is comparable to positive opening contacts. Certified by TÜV as a "Functional-Safety" device. Suitable for protection of people or processes.



**Assembled Switch**



**Contact Sequence**

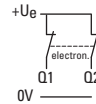
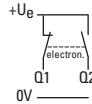

**Contact Travel**  
 ■ = contact closed  
 □ = contact open

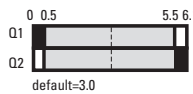

**Operating Head Type ②**

**Head Only**  
**Catalog Number**

**Assembled Switch**  
**Catalog Number**

**Metal Rod**



**LS-XRRM**

**LSE-11-RRM**

**LSE-02-RRM**

**Spring Rod (Wobble) ③**



**LS-XS**

**LSE-11-S**

**LSE-02-S**

**Actuating Rod**



**LS-XOR**

**LSE-11-OR**

**LSE-02-OR**

**Notes**

- ① A compatible Cage Clamp tool is available as an accessory on **Page V8-T2-33**.
- ② For operating head dimensions, see **Page V8-T2-39**.
- ③ Not to be used as a safety position switch. Use only in conjunction with snap-action contact.

# 2.3

## Limit Switches

### LS-Titan Miniature DIN Switches

#### LS-Titan Metal Safety Switches

2

#### Metal Safety Switch Body



Assembled Switch



#### Metal Safety Switches

Switch Body Catalog Number

Output Function

Terminal Connection

Contact Sequence

Contact Travel

■ = contact closed

□ = contact open

Operating Head Type ①

Head Only Catalog Number

**LSM-02**

2NC with positive opening contacts

Cage Clamp

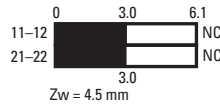

**LSM-20A**

2NO with slow make/break

Cage Clamp

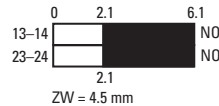

**LSM-11S**

1NO and 1NC with positive opening contact

Cage Clamp

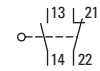

Snap-action contact

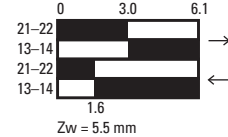

#### Top Push Roller Plunger



**LSM-XP**

**LSM-02-P**

**LSM-20A-P**

**LSM-11S-P**

#### Long Roller Lever



**LSM-XL**

**LSM-02-L**

**LSM-20A-L**

**LSM-11S-L**

#### Angled Roller



**LSM-XLA**

**LSM-02-LA**

**LSM-20A-LA**

**LSM-11S-LA**

#### Rotary Lever



**LSM-XRL**

**LSM-02-RL**

**LSM-20A-RL**

**LSM-11S-RL**

#### Adjustable Roller Lever



**LSM-XRLA**

**LSM-02-RLA**

**LSM-20A-RLA**

**LSM-11S-RLA**

#### Note

① For operating head dimensions, see **Page V8-T2-39**.

**Metal Safety Switches, continued**

**Metal Safety Switch Body**



**Assembled Switch**



**Switch Body Catalog Number**

**Output Function**

**Terminal Connection**

**Contact Sequence**

**Contact Travel**

- = contact closed
- = contact open

**Operating Head Type ①**

**Head Only Catalog Number**

**LSM-02**

2NC with positive opening contacts

Cage Clamp

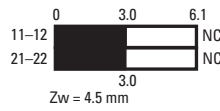

**LSM-20A**

2NO with slow make/break

Cage Clamp

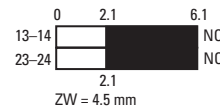

**LSM-11S**

1NO and 1NC with positive opening contact

Cage Clamp

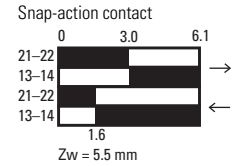

**Plastic Rod Lever**



**LSM-XRR**

**LSM-02-RR**

**LSM-20A-RR**

**LSM-11S-RR**

**Metal Rod Lever**



**LSM-XRRM**

**LSM-02-RRM**

**LSM-20A-RRM**

**LSM-11S-RRM**

**Spring Rod (Wobble)**



**LSM-XS**

**LSM-02-S**

**LSM-20A-S**

**LSM-11S-S**

**Note**

① For operating head dimensions, see **Page V8-T2-39**.



# 2.3

## Limit Switches

### LS-Titan Miniature DIN Switches

2

#### Understanding LS-Titan Electronic Safety Position Switches

Both LS-Titan LSE switch bodies are safety-rated products. The LSE-11 and LSE-02 switch bodies both have a freely programmable operating point and can be individually adjusted to suit the application, and can be changed as often as required. These devices feature an LED on the body, providing simple indication during programming and operation.

Like the electromechanical position switches, LS-Titan electronic position switches meet Category 3 or 4 of the EN 954-1 standard for machine safety when configured as a redundant system. All devices are thus suitable for safety applications that are used for the protection of persons or processes.

#### Operating Point Adjustment

##### LSE-11

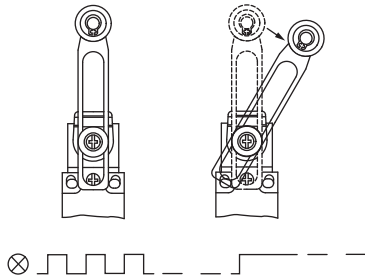

##### LSE-02

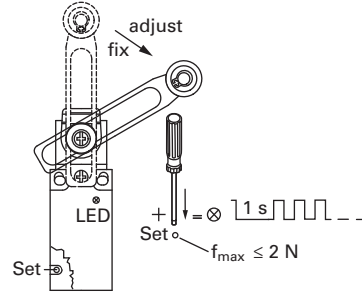

#### Example of LS-Titan LSE Models in a Safety-Oriented Circuit

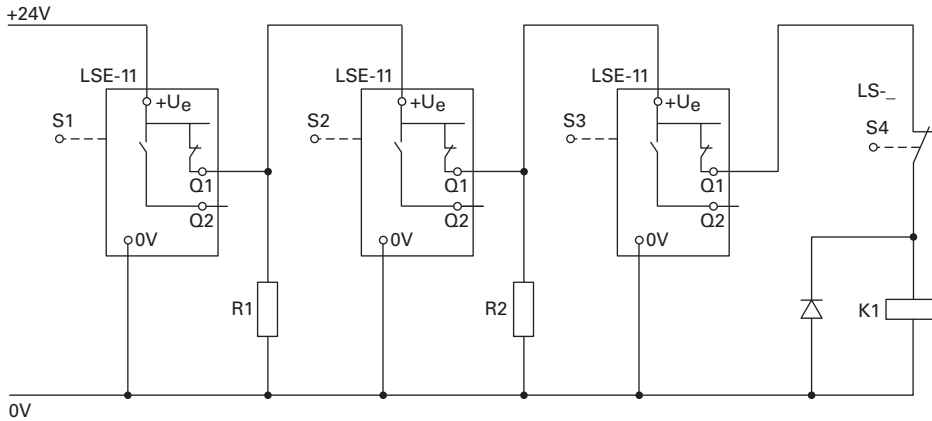

#### Notes

LSE-11 and LSE-02—individual operating point adjustment.

LSE-11 and LSE-02 can be used in safety circuits.

S1 is connected to 24 Vdc



S2, S3 each switch with a delay of 0.7s

R1, R2, for example, series element M22-XLED60 (2820 ohms/0.5W)

**Accessories**

LS-Titan Miniature DIN Switches are designed for use with Eaton wiring and fitting accessories listed in this section. Use of similar accessories supplied by other manufacturers may cause switches to function incorrectly and is not recommended.

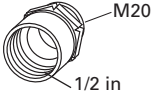
**LS-Titan Safety Switches**

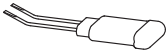
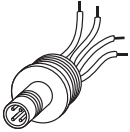
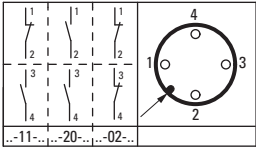
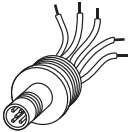
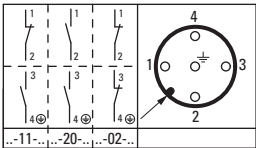
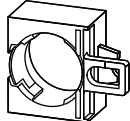
	<b>For Use With</b>	<b>Description</b>	<b>Notes</b>	<b>Catalog Number</b>
<b>V1-2-M20</b> 	Any	M20 screw terminal in 1/2 in. For use with American pipe thread, metal.	The screw connection must be earthed. Not total insulation.	<b>V1-2-M20-NA</b>
	Any	M20 screw terminal in 1/2 in. For use with American pipe thread, molded material.	—	<b>V1-2-M20</b>
<b>EMS20</b> 	Any	M20 diaphragm bolt. With internal push-through membrane. Will fit cable with an external diameter of up to 13 mm. Rated IP65 with cable inserted.	—	<b>EMS20</b>
<b>LS-XTW</b> 	Any	Cage Clamp tool.	—	<b>LS-XTW</b>
<b>M12A</b> 	LS-Titan plastic bodies (LS-_)	Plug connector, 12 mm, 4-pin male connector M12x1 (M12x1). Rated IP65. Molded material. Color coded to IEC/EN 60947-5-2.		<b>M12A</b>
<b>M12A5</b> 	LS-Titan metal bodies (LSM-_)	Plug connector, 12 mm, 5-pin male connector (M12x1). Rated IP65. Molded material. Color coded to IEC/EN 60947-5-2.		<b>M12A5</b>
<b>M22-LS</b> 	Any	Allows mounting of M22 pushbuttons. (See the M22 catalog, CA04716001E, for a full selection of pushbuttons.)	—	<b>M22-LS</b>

## Technical Data and Specifications

## LS-Titan Miniature DIN Switches—IP66, IP67 Complete Units

2

	Units		LS, LSM	LSE-11/LSE-02
<b>General</b>				
Standards			IEC/EN 60947	IEC/EN 60947 EN 61000-4
Climatic proofing			Damp heat, constant, to IEC 60068-2-78; damp heat, cyclical, to IEC 60068-2-30	Damp heat, constant, to IEC 60068-2-78; damp heat, cyclical, to IEC 60068-2-30
Ambient temperature	°F (°C)		−13° to 158°F (−25° to 70°C)	−13° to 158°F (−25° to 70°C)
Mounting position			As required	As required
Protection type			IP66, IP67	IP66, IP67
Terminal capacity of screw terminal and Cage Clamp				
Solid	mm <sup>2</sup>		1 x (0.5–2.5)	1 x (0.5–2.5)
Flexible with ferrules to DIN 46228	mm <sup>2</sup>		1 x (0.5–1.5)	1 x (0.5–1.5)
<b>Power Supply</b>				
Rated voltage	U <sub>e</sub>	Vdc	N/A	12–30
Burden current				
12V	I <sub>e</sub>	mA	N/A	15
24V	I <sub>e</sub>	mA	N/A	18
30V	I	mA	N/A	19
<b>Contacts/Switching Capacity</b>				
Rated impulse withstand voltage	U <sub>imp</sub>	Vac	4000	N/A
Rated insulation voltage	U <sub>i</sub>	V	400	N/A
Overvoltage category/ pollution degree			III/3	III/3
<b>Rated Operational Current</b>				
AC-15				
24V	I <sub>e</sub>	A	6	N/A
230V/240V	I <sub>e</sub>	A	6	N/A
400V/415V	I <sub>e</sub>	A	4	N/A
DC-13				
24V	I <sub>e</sub>	A	3	0.2
110V	I <sub>e</sub>	A	0.8	N/A
220V	I <sub>e</sub>	A	0.3	N/A
<b>Burden Current</b>				
Analog output Q1				
Output voltage (max. 10 mA)			Vdc	N/A
Output current			mA	N/A
Fault scenario			V	N/A
Resolution			Steps	N/A
Step tolerance			Steps	N/A
Shunt resistor, resistive load			ohms	N/A
Digital diagnostics output Q2 (switching to + pole PNP)				
Response threshold			V	N/A
			mA	N/A
Control circuit reliability				
At 24 Vdc/5 mA	H <sub>F</sub>	Fault probability	<10 <sup>−7</sup> , <1 fault in 10 <sup>7</sup> operations	N/A
At 5 Vdc/1 mA	H <sub>F</sub>	Fault probability	<10 <sup>−6</sup> , <1 failure at 5 x 10 <sup>6</sup> operations	N/A
Supply frequency			Hz	Max. 400
Short-circuit rating to IEC/EN 60947-5-1				
Maximum fuse			A gG/gL	6
Repetition accuracy			mm	±0.02

## LS-Titan Miniature DIN Switches—IP66, IP67 Complete Units, continued

	Units		LS, LSM	LSE-11/LSE-02
<b>Mechanical Variables</b>				
Lifespan				
Standard-action contact	Operations	X 10 <sup>6</sup>	8	N/A
Snap-action contact	Operations	X 10 <sup>6</sup>	8	3 (electronic)
Contact temperature of roller head		°C	≤100	≤100
Mechanical shock resistance (half-sinusoidal shock, 20 ms)				
Standard-action contact		g	25	N/A
Snap-action contact		g	N/A	N/A
Basic unit		g	N/A	30
Operating frequency	Operations/h		≤6000	≤3000
Switching point			N/A	0.5–5.5 mm freely adjustable
Hysteresis		mm	N/A	0.4
Contact sequence (contact closed open Zw = positive opening clearance)		mm	N/A	0.04
<b>Actuation</b>				
Mechanical				
Actuating force at beginning/ end of stroke				
Basic units		N	1.0/8.0	3.5/8.0
LS(M)-XP		N	1.0/8.0	1.0/8.0
LS(M)-XL		N	1.0/8.0	1.0/8.0
LS(M)-XLA		N	1.0/8.0	1.0/8.0
Actuating torque of rotary drives		Nm	0.2	0.2
Maximum operating speed with DIN cam				
Basic units for angle of actuation	$\alpha = 0^\circ/30^\circ$	m/s	1/0.5	1/0.5
LS(M)-XRL for angle of actuation	$\alpha = 0^\circ$	m/s	1.5	1.5
LS(M)-XRLA for angle of actuation	$\alpha = 30^\circ, L = 125 \text{ mm}$	m/s	1.5	1.5
LS(M)-XRR for angle of actuation	$L = 130 \text{ mm}$	m/s	1.5	1.5
LS(M)-XL for angle of actuation	$\alpha = 30^\circ/45^\circ$	m/s	1	1
LS(M)-XLA for angle of actuation	$\alpha = 30^\circ/45^\circ$	m/s	1	1
LS(M)-XP for angle of actuation	$\alpha = 0^\circ/30^\circ$	m/s	1/1	1/1
<b>Electromagnetic Compatibility (EMC)</b>				
Electrostatic discharge (IEC/EN 61000-4-2, Level 3 ESD)				
Air discharge		kV		8
Contact discharge		kV		4
Electromagnetic fields (IEC/EN 61000-403, RFI)		V/m		10
Burst pulses (IEC/EN 61000-4-4, Level 3)				
Supply cables		kV		2
Signal lines		kV		2
High-energy pulses (surge) (IEC/EN 61000-4-5)		kV		0.5
Immunity to line-conducted interference to (IEC/EN 61000-4-6)		V		10

#### Contact Travel Diagrams

#### LSE

2

	Contact Travel	LSE-11	LSE-02
<b>Description</b>	■ = contact closed □ = contact open		
<b>Basic Units</b>			
<b>Operating Heads</b>			
Roller plunger			
LS-XP LSM-XP			
Roller lever			
LS-XL LSM-XL LS-XL LS-XLB			
Angled roller lever			
LS-XLA LSM-XLA			
Rotary lever			
LS-XRL LSM-XRL			
Adjustable roller lever			
LS-XRLA LSM-XRLA LS-XRLA30 LS-XRLA40 LS-XRLA40R			
Actuating rod			
LS-XRR LSM-XRR LS-XRRM LSM-XRRM			
Spring rod			
LS-XS LSM-XS			

### LS and LSM

#### Contact Travel

= contact closed  
 = contact open

#### Description

#### Basic Units

#### LS-02, LS-S02, LSM-02

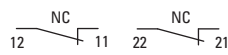

#### LS-11S, LS-S11S, LSM-11S

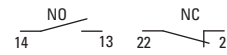

#### LS-20A, LS-S20A, LSM-20A

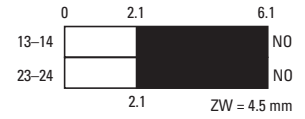
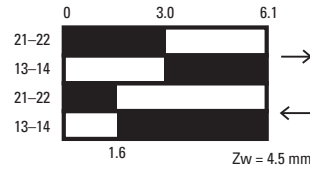
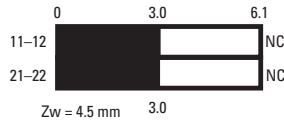
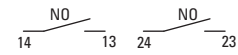

#### Operating Heads

##### Roller plunger

LS-XP, LSM-XP

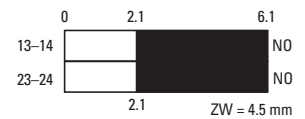
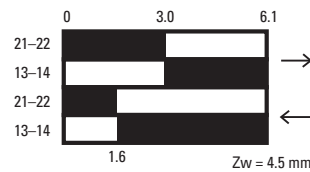
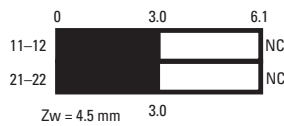

##### Roller lever

LS-XL, LSM-XL

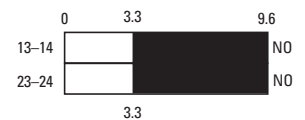
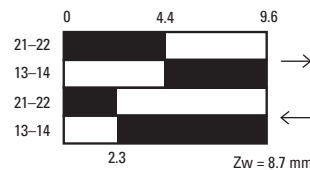
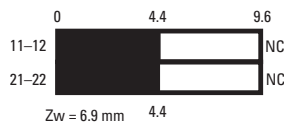

##### Roller lever, short

LS-XLS

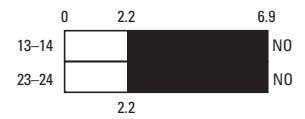
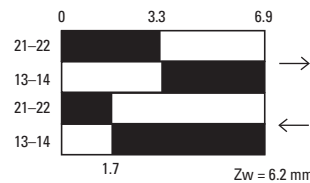
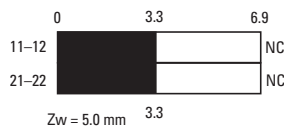

##### Roller lever, large

LS-XLB

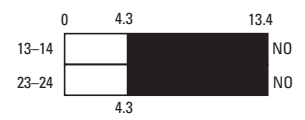
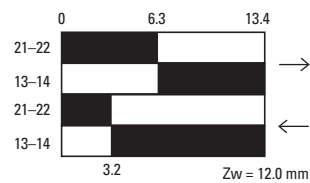
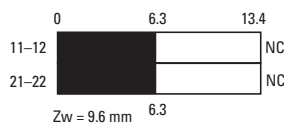

# 2.3

## Limit Switches

### LS-Titan Miniature DIN Switches

2

#### LS and LSM, continued

##### Contact Travel

■ = contact closed  
□ = contact open

##### LS-02, LS-S02, LSM-02

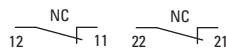

##### LS-11S, LS-S11S, LSM-11S

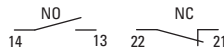

##### LS-20A, LS-S20A, LSM-20A

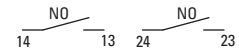

#### Operating Heads

Angled roller lever

LS-XLA, LSM-XLA

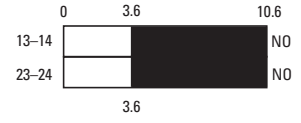
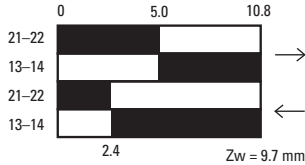
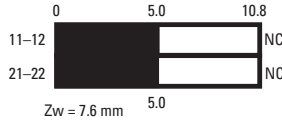

Rotary lever

LS-XRL, LSM-XRL

Adjustable roller lever

LS-XRLA, LSM-XRLA  
LS-XRLA30, LS-XRLA40  
LS-XRLA40R

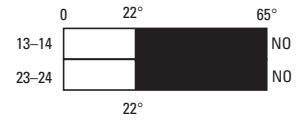
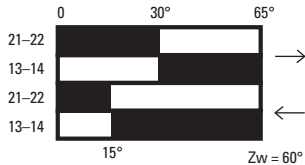
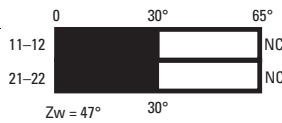

Actuating rod

LS-XRR, LSM-XRR  
LS-XRRM, LSM-XRRM

Spring rod

LS-XS, LSM-XS

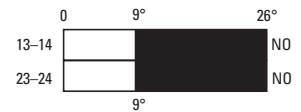
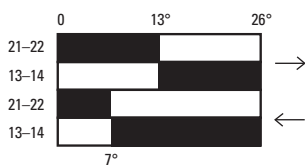
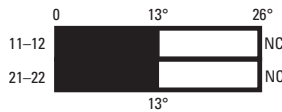

**Dimensions**

Approximate Dimensions in Inches (mm)

**Position Switches**

**LS-, LSM-, LSE-**

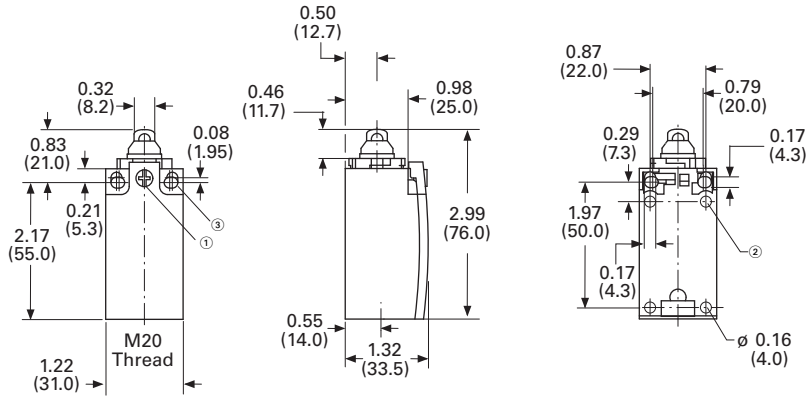

**LS-, LSM-, LSE-**

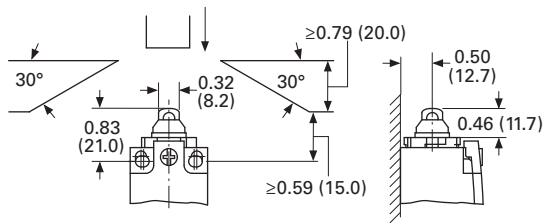

**LS(M)-/S**

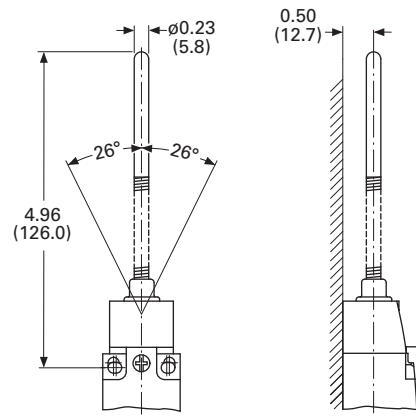

**LS(M)-/P**

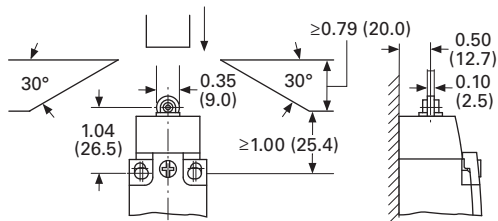

**Notes**

- ① Tightening torque of cover screws: 0.8 Nm  $\pm$  0.2 Nm.
- ② Only with LS (insulated version).
- ③ Fixing screws 2 x M4  $\geq$  30  
M<sub>A</sub> = 1.5 Nm



# 2.3

## Limit Switches

### LS-Titan Miniature DIN Switches

Approximate Dimensions in Inches (mm)

2

#### Rotary Lever

LS(M)-\_/RL

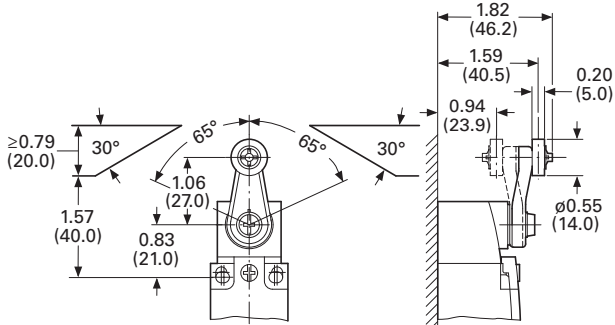

#### Roller Lever, Short

LS(M)-\_/LS

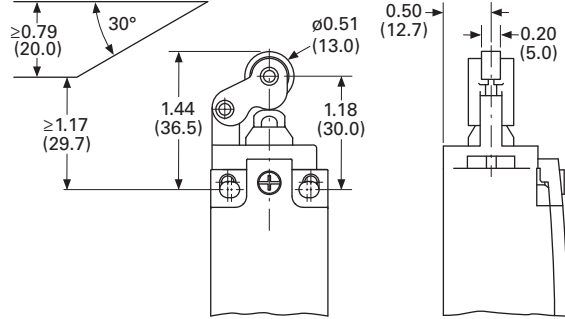

#### Roller Lever

LS(M)-\_/L

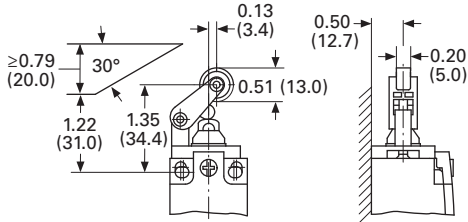

#### Adjustable Roller Lever

LS(M)-\_/RLA

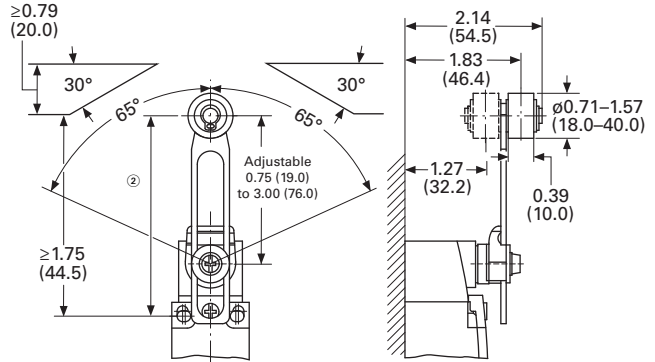

#### Roller Lever, Large

LS(M)-\_/LB ①

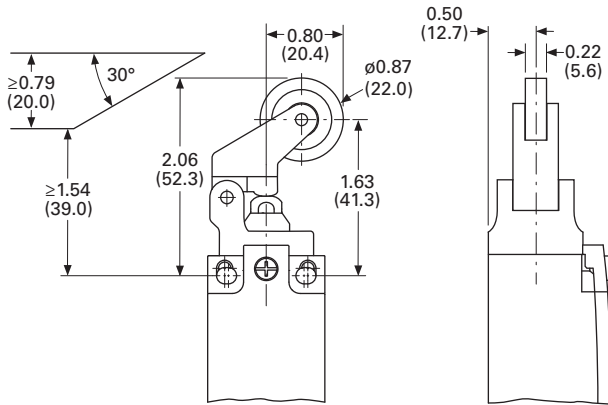

#### Angled Roller Lever

LS(M)-\_/XLA

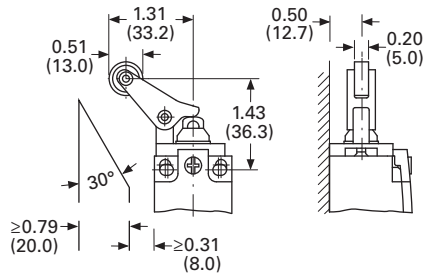

#### Notes

- ① Tightening torque of cover screws: 0.8 Nm  $\pm$  0.2 Nm.
- ② Setting range of 54.5 to 97.

Approximate Dimensions in Inches (mm)

**Actuating Rod**

**LS(M)-\_/RR**

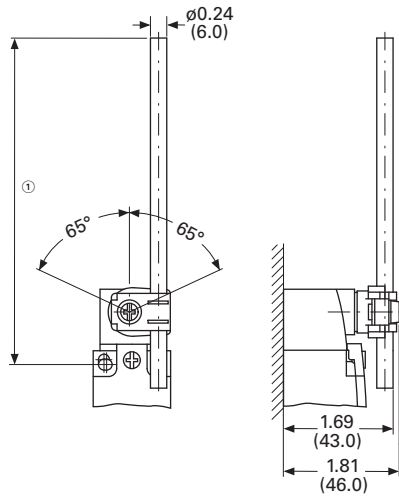

**LS(M)-\_/OR**

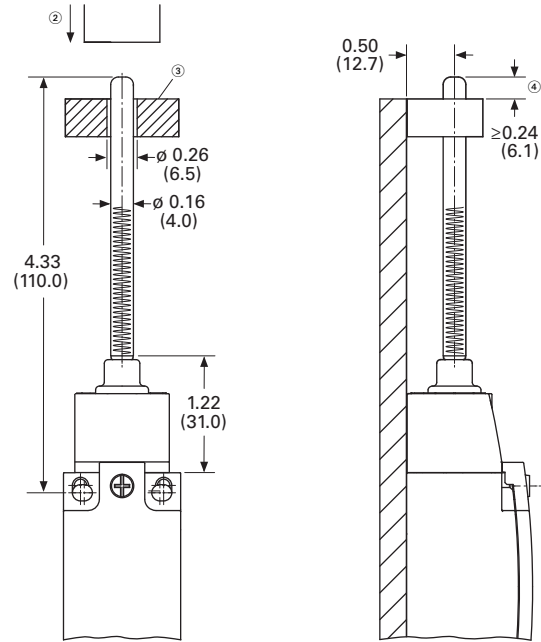

**Notes**

- ① LS\_/RR ≤150  
LS\_/RRM ≤210
- ② Approach direction, vertical.
- ③ Guide is done by customer, not included.
- ④ Maximum push-through.

# 2.4

## Limit Switches

### E49 Mini Metal Switches

#### E49 Mini Metal Switches

2



### E49 Mini Metal Switches

#### Product Description

E49 Mini Metal Limit Switches from Eaton’s electrical sector are designed small and tough, with machinery OEMs in mind. The small size, metal body and mechanical life make this product perfect for switching applications in packaging, material handling, elevators and lifts, electronic assembly equipment, injection molding machinery, and auto-vending machines. The E49 Mini Metal is the ideal switch for those who need a cost-effective, compact solution, but don’t want to sacrifice durability in the process.

#### Features

- Long life—rated for 10 million operations
- Pre-wired units with custom cable lengths available for high volume customers
- “Fingerproof” terminals protect against accidental shock
- Double-spring mechanism for contact reliability
- Grounding terminal included
- Captive screws on enclosure cover make wiring hassle-free
- SPDT double break

### Contents

#### Description

	<i>Page</i>
E49 Mini Metal Switches	
Product Selection .....	<b>V8-T2-43</b>
Technical Data and Specifications .....	<b>V8-T2-45</b>
Dimensions .....	<b>V8-T2-46</b>

 Drawings Online

#### Standards and Certifications

- UL Recognized, E117028 (Model E49G31C1P3 is not UL Recognized)
- CE
- RoHS Compliant



#### DANGER

**THIS SENSOR IS NOT A SAFETY DEVICE AND IS NOT INTENDED TO BE USED AS A SAFETY DEVICE. This sensor is designed only to detect and read certain data in an electronic manner and perform no use apart from that, specifically no safety-related use. This sensor product does not include self-checking redundant circuitry, and the failure of this sensor product could cause either an energized or de-energized output condition, which could result in death, serious bodily injury, or property damage.**

For the most current information on this product, visit our Web site: [www.eaton.com](http://www.eaton.com)

For Customer Service in the U.S. call 1-877-ETN CARE (386-2273), in Canada call 1-800-268-3578. For Application Assistance in the U.S. and Canada call 1-800-426-9184.

**Product Selection**

**E49 Mini Metal Switches**

<i>Operating Head Type</i>	<b>Travel to Operate Contacts</b>	<b>Travel to Reset Contacts</b>	<b>Total Travel</b>	<b>Force to Operate Contacts</b>	<b>Minimum Return Force</b>	<b>Assembled Unit (Switch Body and Head) 1NO-1NC Contacts Catalog Number</b>
<b>Side Rotary Lever</b> 	<b>Side Rotary Lever</b>					
	20°	12°	70°	750g	100g	<b>E49G31AP3</b>
<b>Adjustable Side Rotary Lever</b> 	<b>Adjustable Side Rotary Lever</b>					
	20°	12°	70°	750g	100g	<b>E49G31UP3</b>
<b>Top Pushbutton</b> 	<b>Top Pushbutton</b>					
	0.06 in (1.5 mm)	0.04 in (1 mm)	0.22 in (5.5 mm)	900g	150g	<b>E49G31BP3</b>
<b>Top Push Roller</b> 	<b>Top Push Roller</b>					
	0.06 in (1.5 mm)	0.04 in (1 mm)	0.22 in (5.5 mm)	900g	150g	<b>E49G31CP3</b>
<b>Top Push Roller (90° Roller)</b> 	<b>Top Push Roller (90° Roller)</b>					
	0.06 in (1.5 mm)	0.04 in (1 mm)	0.22 in (5.5 mm)	900g	150g	<b>E49G31CP3</b>
<b>Adjustable Rod Lever</b> 	<b>Adjustable Rod Lever</b>					
	20°	12°	70°	750g	100g	<b>E49G31DP3</b>

# 2.4

## Limit Switches

### E49 Mini Metal Switches

#### E49 Mini Metal Switches, continued

2

<i>Operating Head Type</i>	<b>Travel to Operate Contacts</b>	<b>Travel to Reset Contacts</b>	<b>Total Travel</b>	<b>Force to Operate Contacts</b>	<b>Assembled Unit (Switch Body and Head) 1NO-1NC Contacts Catalog Number</b>
<b>Wobble Stick (Nylon Coil)</b>	<b>Wobble Stick (Nylon Coil)</b>				
	1.18 in (30 mm)	—	—	150g	<b>E49G31NP3</b>
<b>Wobble Stick (Metal Coil)</b>	<b>Wobble Stick (Metal Coil)</b>				
	1.18 in (30 mm)	—	—	150g	<b>E49G31VP3</b>
<b>Wobble Stick (Metal Rod)</b>	<b>Wobble Stick (Metal Rod)</b>				
	1.18 in (30 mm)	—	—	150g	<b>E49G31MP3</b>
<b>Wobble Stick (Whisker)</b>	<b>Wobble Stick (Whisker)</b>				
	1.18 in (30 mm)	—	—	150g	<b>E49G31XM3</b>

**Technical Data and Specifications**

**E49 Mini Metal Switches**

Description	Specification
Operating speed	0.19 in (5 mm) to 19.7 in/s (50 cm/s)
Operating frequency	120 operations/min
Contact resistance	25M ohms (initial)
Insulation resistance	100M ohms min (at 500 Vdc)
Dielectric strength	1000 Vac, 50/60 Hz for one minute between non-continuous terminals
	1500 Vac, 50/60 Hz for one minute between current-carrying and non-current-carrying parts and between each terminal and ground
Vibration	10 to 55 Hz, 1.5 mm double amplitude
Shock	Approx. 300 m/s <sup>2</sup> (approx. 30Gs)
Ambient operating temperature	23° to 149°F (-5° to 65°C)
Humidity	95% RH max.
Service life	Mechanical: 10,000,000 operations min.
	Electrical: 500,000 operations min.
Weight	Approx. 130 to 190g
Degree of protection	IEC: IP65
Material of construction	Shaft: stainless SUS303 Arm: stainless SUS304 Head and body: zinc alloy Terminal cover: PC/ABS plastic Rubber grommet: NBR rubber

**Maximum Ampere Ratings**

Rated Voltage	Non-Inductive Load (A)		Lamp Load ②		Inductive Load (A) ①		Motor Load	
	Resistive Load		NC	NO	Inductive Load		NC	NO
	NC	NO			NC	NO		
125 Vac	5	5	1.5	0.7	3	3	2	1
250 Vac	5	5	1	0.5	3	3	1.5	0.8
8 Vdc	5	5	3	3	5	4	3	3
14 Vdc	5	5	3	3	4	4	3	3
30 Vdc	5	5	3	3	4	4	3	3
125 Vdc	0.4	0.4	—	—	—	—	—	—
250 Vdc	0.2	0.2	—	—	—	—	—	—

**Terminal Configuration**

NO (4) —○ ○— NO (3)

NC (1) —● ●— NC (2)

**Notes**

- ① Inductive load has a power factor of 0.4 min. (AC) and a time constant of 7 msec. max. (DC).
- ② Lamp load has an inrush current of ten times the steady-state current, while motor load has an inrush current of six times the steady-state current.

# 2.4

## Limit Switches

### E49 Mini Metal Switches

#### Dimensions

Approximate Dimensions in Inches (mm)

2

#### E49G31AP3

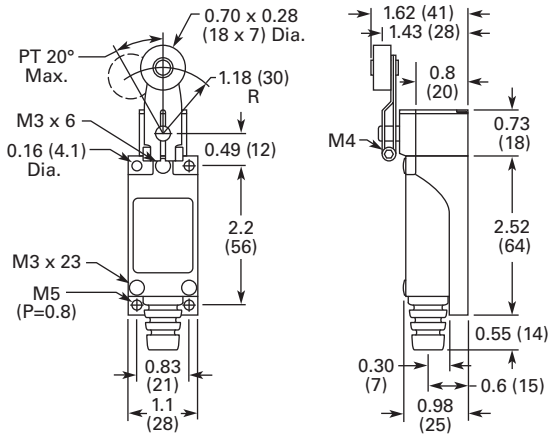

#### E49G31CP3

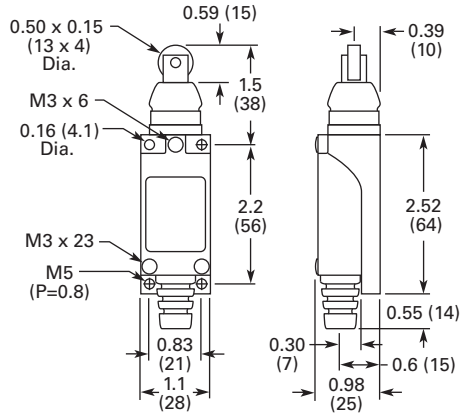

#### E49G31BP3

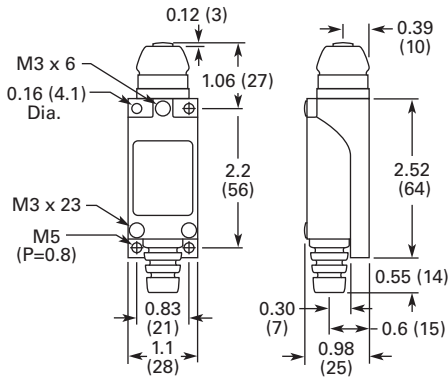

#### E49G31DP3

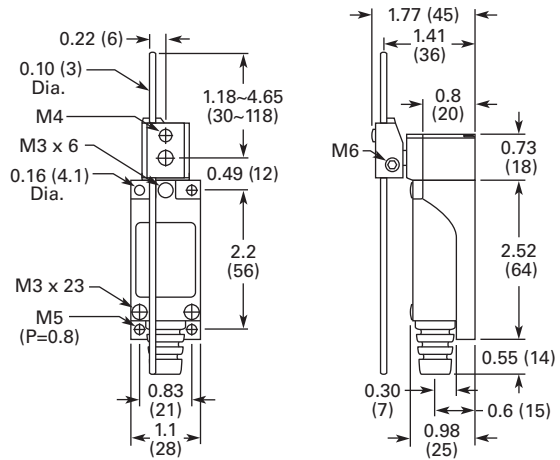

#### E49G31C1P3

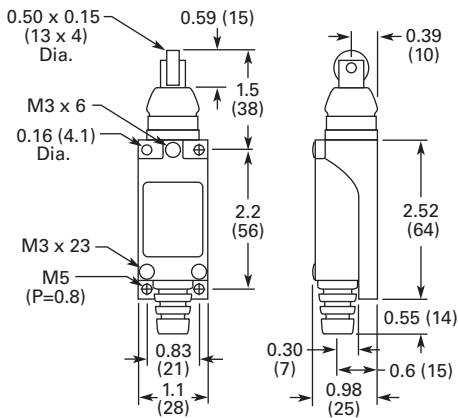

#### E49G31MP3

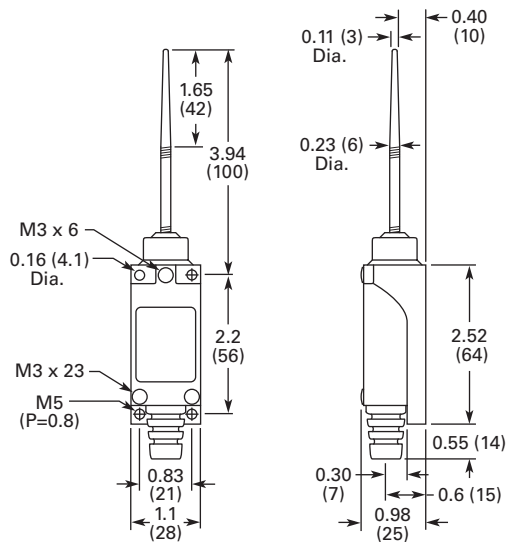

Approximate Dimensions in Inches (mm)

### E49G31NP3

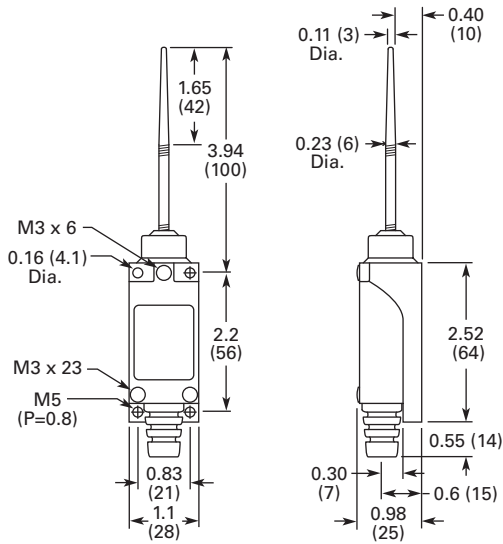

### E49G31VP3

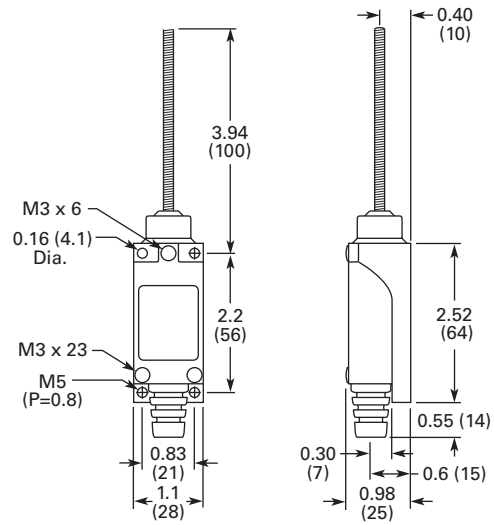

### E49G31UP3

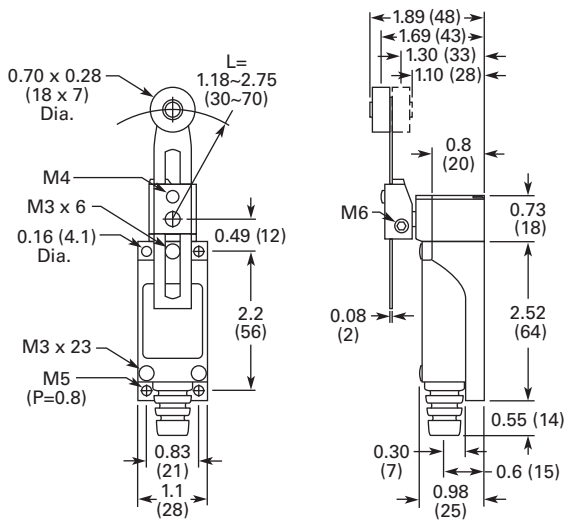

### E49G31XM3

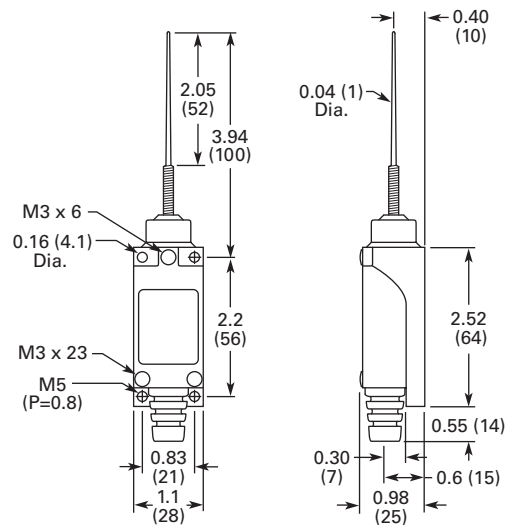



#### E49 Compact Metal Switches

2



### E49 Compact Metal Switches

#### Product Description

E49 Compact Metal Switches by Eaton's electrical sector are designed with high mechanical strength for harsh environments. The rugged aluminum die cast construction provides reliable, oil-tight, waterproof and dustproof sealing for a variety of applications. Snap action 1NO-1NC contacts provide flexibility in design.

#### Features

- Rigid die cast switch housing
- High mechanical strength
- Oil-tight, waterproof and dustproof construction

### Contents

#### Description

	<i>Page</i>
E49 Compact Metal Switches	
Product Selection .....	<b>V8-T2-49</b>
Technical Data and Specifications .....	<b>V8-T2-50</b>
Dimensions .....	<b>V8-T2-51</b>

 Drawings Online

### E49 Compact Metal Switches

#### Product Description

E49 Compact Metal Switches by Eaton's electrical sector are designed with high mechanical strength for harsh environments. The rugged aluminum die cast construction provides reliable, oil-tight, waterproof and dustproof sealing for a variety of applications. Snap action 1NO-1NC contacts provide flexibility in design.

#### Features

- Rigid die cast switch housing
- High mechanical strength
- Oil-tight, waterproof and dustproof construction

#### Standards and Certifications

- UL Listed, E170645
- UL tested to Canadian safety standards
- RoHS Compliant



#### DANGER

**THIS SENSOR IS NOT A SAFETY DEVICE AND IS NOT INTENDED TO BE USED AS A SAFETY DEVICE. This sensor is designed only to detect and read certain data in an electronic manner and perform no use apart from that, specifically no safety-related use. This sensor product does not include self-checking redundant circuitry, and the failure of this sensor product could cause either an energized or de-energized output condition, which could result in death, serious bodily injury, or property damage.**

For the most current information on this product, visit our Web site: [www.eaton.com](http://www.eaton.com)



For Customer Service in the U.S. call 1-877-ETN CARE (386-2273), in Canada call 1-800-268-3578. For Application Assistance in the U.S. and Canada call 1-800-426-9184.

Product Selection

E49 Compact Metal Switches

Operating Head Type	Travel to Operate Contacts	Travel to Reset Contacts	Total Travel	Force to Operate Contacts (Maximum)	Minimum Return Force	Assembled Unit (Switch Body and Head) 1NO-1NC Contacts Catalog Number
<b>Roller Lever</b> 	20°	12°	50°	2.99 lbs	0.50 lb	<b>E49M11AP1</b>
<b>Top Push</b> 	0.067 in (1.7 mm)	0.04 in (1.0 mm)	—	6.02 lbs	2.01 lbs	<b>E49M11BP1</b>
<b>Top Push Roller</b> 	0.067 in (1.7 mm)	0.04 in (1.0 mm)	0.25 in (6.5 mm)	6.02 lbs	2.01 lbs	<b>E49M11CP1</b> (as pictured)  <b>E49M11CP2</b> 90° Cross Roller
<b>Rod Lever</b> 	20°	12°	50°	0.31 lb	0.06 lb	<b>E49M11DP1</b>
<b>Adjustable Roller Lever</b> 	20°	12°	50°	2.99 lbs	0.50 lb	<b>E49M11UP1</b>

#### E49 Compact Metal Switches, continued

Operating Head Type	Travel to Operate Contacts	Travel to Reset Contacts	Total Travel	Force to Operate Contacts (Maximum)	Minimum Return Force	Assembled Unit (Switch Body and Head) 1NO-1NC Contacts Catalog Number
<b>Wobble</b>	<b>Wobble</b>					
	1.10 in (28 mm)	N/A	N/A	0.33 lb	N/A	<b>E49M11VP1</b>
<b>Cat Whisker</b>	<b>Cat Whisker</b>					
	1.10 in (28 mm)	N/A	N/A	0.064 lb	N/A	<b>E49M11XM1</b>

### Technical Data and Specifications

#### E49 Compact Metal Switches

Description	Specification
Operating speed	1 mm to 2m/sec
Operating frequency	Mechanically: 120 operations/min.; Electronically: 30 operations/min.
Contact resistance	15M ohms max. (initial)
Insulation resistance	100M ohms min. (at 500 Vdc)
Dielectric strength	1000 Vac, 50/60 Hz for 1 minute between non-continuous terminals; 2200 Vac, 50/60 Hz for 1 minute between each terminal and non-current carrying metal part and between each terminal and ground
Vibration	Malfunction durability: approx. 1000 m/sec <sup>2</sup> (approx. 100 Gs); Malfunction durability: approx. 300/sec <sup>2</sup> (30 Gs)
Ambient operating temperature	14° to 176°F (-10° to 80°C)
Humidity	95% RH max.
Service life	Mechanically: 15,000,000 operations/minute; Electronically: 500,000 operations/minute

#### Maximum Ampere Ratings—Isolated Contacts, No Polarity Restriction

NEMA A600 (AC-15) 50 or 60 Hz						NEMA R300 (DC-13)	
Rated Voltage	Current			Voltamperes		Rated Voltage	Current
	Continuous	Make	Break	Make	Break		
24 Vac	10A	60A	6.0A	7200 VA	720 VA	24 Vdc	1.5A
120 Vac	10A	60A	6.0A	7200 VA	720 VA	120 Vdc	0.22A
250 Vac	10A	30A	3.0A	7200 VA	720 VA	250 Vdc	0.11A
480 Vac	10A	15A	1.5A	7200 VA	720 VA		
600 Vac	10A	12A	1.2A	7200 VA	720 VA		

Dimensions

Approximate Dimensions in Inches (mm)

Switch Body with E49M11BP1

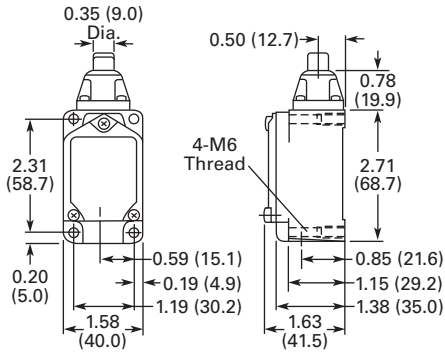

E49M11UP1

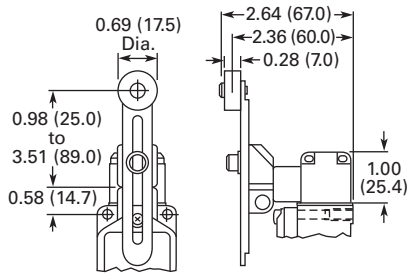

E49M11CP1/E49M11CP2

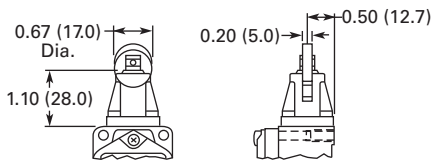

E49M11VP1

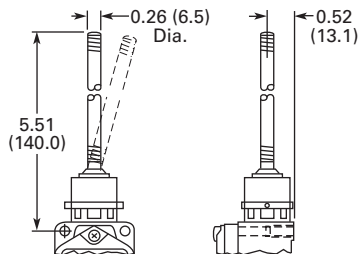

E49M11DP1

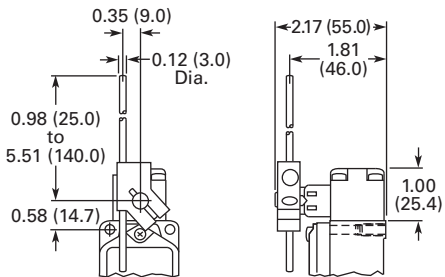

E49M11XM1

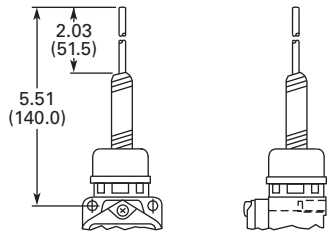

E49M11AP1

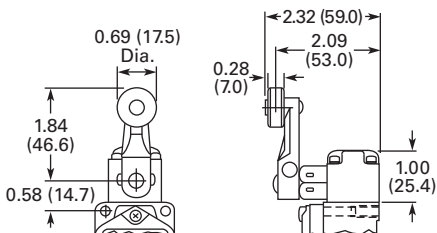

# 2.6

## Limit Switches

### E50 Heavy-Duty Plug-In Switches

#### E50 Heavy-Duty Plug-In Switches

2



#### Contents

<i>Description</i>	<i>Page</i>
E50 Heavy-Duty Plug-In Switches	
Product Selection	
Assembled Switches—Standard . . . . .	<b>V8-T2-53</b>
Assembled Switches—Special Purpose . . . . .	<b>V8-T2-56</b>
Operating Heads . . . . .	<b>V8-T2-57</b>
Switch Bodies . . . . .	<b>V8-T2-58</b>
Receptacles . . . . .	<b>V8-T2-59</b>
Compatible Connector Cables . . . . .	<b>V8-T2-60</b>
Accessories . . . . .	<b>V8-T2-60</b>
Technical Data and Specifications . . . . .	<b>V8-T2-61</b>
Circuit Diagrams . . . . .	<b>V8-T2-63</b>
Wiring Diagrams . . . . .	<b>V8-T2-63</b>
Dimensions . . . . .	<b>V8-T2-64</b>

 Drawings Online

### E50 Heavy-Duty Plug-In Switches

#### Product Description

E50 Modular Plug-In Limit Switch Components from Eaton’s electrical sector are the industry standard with versatility of design and high reliability for low maintenance, installation and inventory costs. Standard Viton gaskets, seals and boots and a zinc die cast enclosure provide exceptional chemical resistance to the common coolants, cleansing agents, and hydraulic fluids found in machine tool, automotive, waste water treatment and other heavy-duty industrial applications. Mounting dimensions accommodate both U.S. and DIN standards for easy retrofit installations. Super bright 24–120 Vac/dc LED indicating light versions simplify setup and troubleshooting operations.

#### Features

- Modular, plug-in components (head, body and receptacle) provide application flexibility, reduced inventory and less downtime
- Manufactured to take the physical and environmental abuse (including cutting fluids and chemicals) of harsh industrial environments
- Chemical resistant Viton gaskets, seals and boots are standard, and so are captive, posi-drive screws
- The switches have terminal identification on the nameplate for a visual wiring checkout without guesswork. Heads and switch bodies can be replaced without rewiring
- E50 devices can be ordered in separate components or as complete assembled switches
- 600V rating, ridge-topped contacts and wiping action assure continuity even to logic level circuits
- Keyed, four direction head positioning
- Standard 5° pre-travel and 90° total travel
- 24–120 Vac/dc LED and 120 Vac neon indicating lights available
- Rotary heads are field convertible CW, CCW, or both, without special tools
- Epoxy filled, pin connector or pigtail pin connector receptacles available

#### Standards and Certifications

- UL Listed, E170645
- CSA Certified, 50513
- CE (where shown)
- RoHS Compliant



**⚠ DANGER**  
**THIS SENSOR IS NOT A SAFETY DEVICE AND IS NOT INTENDED TO BE USED AS A SAFETY DEVICE. This sensor is designed only to detect and read certain data in an electronic manner and perform no use apart from that, specifically no safety-related use. This sensor product does not include self-checking redundant circuitry, and the failure of this sensor product could cause either an energized or de-energized output condition, which could result in death, serious bodily injury, or property damage.**

For the most current information on this product, visit our Web site: [www.eaton.com](http://www.eaton.com)

For Customer Service in the U.S. call 1-877-ETN CARE (386-2273), in Canada call 1-800-268-3578. For Application Assistance in the U.S. and Canada call 1-800-426-9184.

**Product Selection**

**Assembled Switches—Standard**

**Assembled Switch E50 Heavy-Duty Plug-In Switches, Assembled—Standard**

Assembled Switch

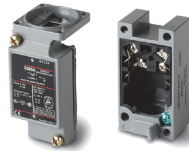

Single-Pole (5 Terminal Receptacle)

Two-Pole (9 Terminal Receptacle)

Indicating Light:	None	LED (24–120 Vac/dc)	Neon (120 Vac)	None	LED (24–120 Vac/dc)	Neon (120 Vac)	LED (24–120 Vac/dc)	Neon (120 Vac)
Switch Body:	E50SA 1NO-1NC	E50SAL 1NO-1NC	E50SAN 1NO-1NC	E50SB 2NO-2NC	E50SBL 2NO-2NC	E50SBN 2NO-2NC	E50SCL 1NO-2NC	—
Receptacle: ①	E50RA	E50RA	E50RA	E50RB	E50RB	E50RB	E50RB	E50RB
Description	Assembled Switch (Head + Receptacle + Body) Catalog Number			Assembled Switch (Head + Receptacle + Body) Catalog Number				

Operating Head Type ②

Side Rotary



Description	E50AR1	E50ALR1	E50ANR1	E50BR1	E50BLR1	E50BNR1	—	—
Standard spring return—E50DR1 ③	CE							
Low force spring return—E50DL1 ③	CE							
Maintained two-position—E50DM1	CE							

Spring Return



Description	E50AS1	E50ALS1	E50ANS1	E50BS1	E50BLS1	E50BNS1	E50CLS1	—
Spring return—E50DS1	CE							

Adjustable Spring Return



Description	E50AS2	E50ALS2	E50ANS2	E50BS2	E50BLS2	E50BNS2	E50BLS2	E50CNS2
Adjustable spring return—E50DS2	CE							

Circuit Diagrams, see Page V8-T2-63.

**Notes**

① Connection options (add the code suffix from the table below to the end of the catalog number):

Option		Mating Cordset Catalog Number	Code Suffix	
Mini-connector ④ (with epoxy filled receptacle)	Single-pole (5-pin mini-connector)	CSMS5D5CY1602	P5 ⑤	
	Two-pole (9-pin mini-connector)	CSMS9D9CY1602	P9 ⑤	
Micro-connector ④ (with epoxy filled receptacle)	Single-pole (5-pin micro-connector)	CSDS5A5CY2202	A5 ⑤	
	Cable connection (with epoxy filled receptacle)	8 ft cable length	—	S
		12 ft cable length	—	S12
20 ft cable length		—	S20	
Manifold mount (rear wiring entrance)	—	—	M	
20 mm conduit entrance	—	—	20	

② For operating head specifications, see Page V8-T2-57.

③ CW (clockwise) and CCW (counterclockwise) operation, easily convertible to CW only or CCW only operation.

④ For a full selection of cable connectors, see Tab 10, section 10.1.

⑤ Refer to Page V8-T2-63 for wiring diagrams.

# 2.6

## Limit Switches

### E50 Heavy-Duty Plug-In Switches

2

#### Assembled Switch



#### E50 Heavy-Duty Plug-In Switches, Assembled—Standard, continued



#### Single-Pole (5 Terminal Receptacle)

#### Two-Pole (9 Terminal Receptacle)

Indicating Light:	None	LED (24–120 Vac/dc)	Neon (120 Vac)	None	LED (24–120 Vac/dc)	Neon (120 Vac)	LED (24–120 Vac/dc)	Neon (120 Vac)
Switch Body:	E50SA	E50SAL	E50SAN	E50SB	E50SBL	E50SBN	E50SCL	—
Receptacle: ①	1NO-1NC	1NO-1NC	1NO-1NC	2NO-2NC	2NO-2NC	2NO-2NC	1NO-2NC	—
	E50RA	E50RA	E50RA	E50RB	E50RB	E50RB	E50RB	E50RB
<b>Operating Head Type</b> ②	Assembled Switch (Head + Receptacle + Body) Catalog Number			Assembled Switch (Head + Receptacle + Body) Catalog Number				

#### Operating Head Type ②

#### Side Push Roller



#### Side Push Roller

Description	E50AS3	E50ALS3	E50ANS3	E50BS3	E50BLS3	E50BNS3	E50BLS3	—
Spring return— E50DS3 ③	CE							

#### Side Pushbutton



#### Side Pushbutton

Description	E50AH1	E50ALH1	E50ANH1	E50BH1	E50BLH1	E50BNH1	E50BLH1	—
Maintained— E50DH1	CE							

#### Top Pushbutton

#### Spring Return



Description	E50AT1	E50ALT1	E50ANT1	E50BT1	E50BLT1	E50BNT1	E50CLT1	E50BNT1
Spring return— E50DT1	CE							

#### Adjustable Spring Return



Description	E50AT2	E50ALT2	E50ANT2	E50BT2	E50BLT2	E50BNT2	—	—
Adjustable spring return—E50DT2	CE							

**Circuit Diagrams**, see [Page V8-T2-63](#).

#### Notes

① Connection options (add the code suffix from the table below to the end of the catalog number):

Option		Mating Cordset Catalog Number	Code Suffix
Mini-connector ④ (with epoxy filled receptacle)	Single-pole (5-pin mini-connector)	<b>CSMS5D5CY1602</b>	<b>P5</b> ⑤
	Two-pole (9-pin mini-connector)	<b>CSMS9D9CY1602</b>	<b>P9</b> ⑤
Micro-connector ④ (with epoxy filled receptacle)	Single-pole (5-pin micro-connector)	<b>CSDS5A5CY2202</b>	<b>A5</b> ⑤
Cable connection (with epoxy filled receptacle)	8 ft cable length	—	<b>S</b>
	12 ft cable length	—	<b>S12</b>
	20 ft cable length	—	<b>S20</b>
Manifold mount (rear wiring entrance)		—	<b>M</b>
20 mm conduit entrance		—	<b>20</b>

② For operating head specifications, see [Page V8-T2-57](#).

③ Roller can be converted in the field between horizontal and vertical.

④ For a full selection of cable connectors, see [Tab 10, section 10.1](#).

⑤ Refer to [Page V8-T2-63](#) for wiring diagrams.

E50 Heavy-Duty Plug-In Switches, Assembled—Standard, continued

Assembled Switch



Single-Pole (5 Terminal Receptacle)

Two-Pole (9 Terminal Receptacle)

Indicating Light:	None	LED (24–120 Vac/dc)	Neon (120 Vac)	None	LED (24–120 Vac/dc)	Neon (120 Vac)	LED (24–120 Vac/dc)	Neon (120 Vac)
Switch Body:	E50SA 1NO-1NC	E50SAL 1NO-1NC	E50SAN 1NO-1NC	E50SB 2NO-2NC	E50SBL 2NO-2NC	E50SBN 2NO-2NC	E50SCL 1NO-2NC	—
Receptacle: ①	E50RA	E50RA	E50RA	E50RB	E50RB	E50RB	E50RB	E50RB
Description	Assembled Switch (Head + Receptacle + Body) Catalog Number			Assembled Switch (Head + Receptacle + Body) Catalog Number				

Operating Head Type ②

Top Push Roller



Description	Top Push Roller			Top Push Roller				
Spring return E50DT3 ③	E50AT3 CE	E50ALT3	E50ANT3	E50BT3	E50BLT3	E50BNT3	—	—

Wobble Head, Spring Return



Description	Wobble Head, Spring Return (requires a wobble operator, see Page V8-T2-78)			Wobble Head, Spring Return (requires a wobble operator, see Page V8-T2-78)				
Standard duty— E50DW1	E50AW1 CE	E50ALW1	E50ANW1	E50BW1	E50BLW1	E50BNW1	E50BLW1	—
Heavy-duty high strength steel— E50DW2	E50AW2 CE	E50ALW2	E50ANW2	E50BW2	E50BLW2	E50BNW2	E50CLW2	E50BNW2

Circuit Diagrams, see Page V8-T2-63.

Notes

① Connection options (add the code suffix from the table below to the end of the catalog number):

Option		Mating Cordset Catalog Number	Code Suffix	
Mini-connector ④ (with epoxy filled receptacle)	Single-pole (5-pin mini-connector)	CSMS5D5CY1602	P5 ⑤	
	Two-pole (9-pin mini-connector)	CSMS9D9CY1602	P9 ⑤	
Micro-connector ④ (with epoxy filled receptacle)	Single-pole (5-pin micro-connector)	CSDS5A5CY2202	A5 ⑤	
	Cable connection (with epoxy filled receptacle)	8 ft cable length	—	S
		12 ft cable length	—	S12
20 ft cable length		—	S20	
Manifold mount (rear wiring entrance)	—	—	M	
20 mm Conduit Entrance	—	—	Z0	

② For operating head specifications, see Page V8-T2-57.

③ Roller can be converted in the field between horizontal and vertical.

④ For a full selection of cable connectors, see Tab 10, section 10.1.

⑤ Refer to Page V8-T2-63 for wiring diagrams.



# 2.6



## Limit Switches

### E50 Heavy-Duty Plug-In Switches

#### Assembled Switches—Special Purpose

2

#### E50 Heavy-Duty Plug-In Switches, Assembled—Special Purpose

	Operating Data— Nominal Switches	Assembled Switch Catalog Number	Switch Body Only Catalog Number	Receptacle Only Catalog Number	Operating Head Only Catalog Number
<b>Neutral Position</b>	<b>Neutral Position</b> (requires an operating lever, see <a href="#">Page V8-T2-78</a> )				
	5° Travel	<b>E50NN1</b> ①	<b>E50SN</b>	<b>E50RB</b>	<b>E50DN1</b> ①
	5° Travel; stainless steel shaft	<b>E50NN1SPL</b> ②	—	—	—
	15° Travel	<b>E50NN2</b>	<b>E50SN</b>	<b>E50RB</b>	<b>E50DN2</b> ①
	Travel to operate contacts:	—	—	—	5° or 15° ③
	Travel to reset contacts:	—	—	—	2°
	Total travel:	—	—	—	90°
	Force to operate contacts:	—	—	—	1.8 in-lbs
	Minimum return force:	—	—	—	2.5 in-oz
	Operating temperature:	—	—	—	14° to 200°F (–10° to 94°C)
<b>Two-Step</b>	<b>Two-Step CW, CCW, or both, Convertible</b> (requires an operating lever, see <a href="#">Page V8-T2-78</a> )				
	—	<b>E50TD1</b>	<b>E50ST</b>	<b>E50RB</b>	<b>E50DD1</b>
	Travel to operate contacts:	—	—	—	1st step 10°; 2nd step 20°
	Travel to reset contacts:	—	—	—	4° each
	Total travel:	—	—	—	90°
	Force to operate contacts:	—	—	—	3 in-lbs
	Minimum return force:	—	—	—	4.5 in-oz
	Operating temperature:	—	—	—	CW or CCW: 14° to 250°F (–10° to 121°C) CW and CCW: 14° to 200°F (–10° to 94°C)
<b>Gravity Return</b>	<b>Gravity Return</b> (requires E50KL220, E50KL226 or equivalent operating lever, see <a href="#">Page V8-T2-78</a> )				
	Without indicating light	<b>E50GG1</b>	<b>E50SG</b>	<b>E50RA</b>	<b>E50DG1</b>
	With LED indicating light (24–120 Vac/dc)	<b>E50GLG1</b>	<b>E50SGL</b>	<b>E50RA</b>	<b>E50DG1</b>
	With neon indicating light (120 Vac)	<b>E50NGG1</b>	<b>E50SGN</b>	<b>E50RA</b>	<b>E50DG1</b>
	Travel to operate contacts:	—	—	—	10° to 170°
	Travel to reset contacts:	—	—	—	8°
	Total travel:	—	—	—	360°
	Force to operate contacts:	—	—	—	3.0 in-oz
	Minimum return force:	—	—	—	Gravity
	Operating temperature:	—	—	—	14° to 200°F (–10° to 94°C)







**Circuit Diagrams**, see [Page V8-T2-63](#).

#### Notes

- ① Add **9** suffix to the model number for low temperature –40° to 174°F (–40 to 79°C) versions.
- ② Low temperature rating –40° to 174°F (–40° to 79°C)
- ③ Depending upon model selected.

## Operating Heads

## E50 Heavy-Duty Plug-In Switches, Operating Heads

Description	Travel to Operate Contacts	Travel to Reset Contacts	Total Travel	Force to Operate Contacts	Minimum Return Force	Operating Temperature <sup>①</sup>		Catalog Number	
						Without Cable	With Pre-Wired Cable		
<b>Side Rotary</b>									
<b>Side Rotary</b> (requires an operating lever, see <a href="#">Page V8-T2-78</a> )									
 Standard spring return <sup>②</sup>	5°	2°	90°	3 in-lbs	4.5 in-oz	10° to 200°F (-12° to 94°C) <sup>③</sup>	10° to 200°F (-12° to 94°C) <sup>③</sup>	<b>E50DR1</b>	
Low temperature spring return <sup>②</sup>	5°	2°	90°	3 in-lbs	4.5 in-oz	-40° to 175°F (-40° to 79°C)	-31° to 175°F (-34° to 79°C)	<b>E50DR19</b>	
Low force spring return <sup>②</sup>	15°	6°	90°	1.5 in-lbs	2.5 in-oz	10° to 200°F (-12° to 94°C) <sup>③</sup>	10° to 200°F (-12° to 94°C) <sup>③</sup>	<b>E50DL1</b>	
Maintained two-position	50°	50°	90°	3 in-lbs	—	14° to 200°F (-10° to 94°C)	14° to 200°F (-10° to 94°C)	<b>E50DM1</b>	
<b>Side Pushbutton</b>									
 Spring return	0.065 in	0.030 in	0.250 in	4 lbs	8 oz	14° to 200°F (-10° to 94°C)	14° to 200°F (-10° to 94°C)	<b>E50DS1</b>	
<b>Adjustable Spring Return</b>	Adjustable spring return	0.065 in	0.030 in	0.250 in	4 lbs	8 oz	14° to 200°F (-10° to 94°C)	14° to 200°F (-10° to 94°C)	<b>E50DS2</b>
									
<b>Side Push Roller</b>									
 Spring return <sup>④</sup>	0.065 in	0.030 in	0.250 in	4 lbs	8 oz	14° to 200°F (-10° to 94°C)	14° to 200°F (-10° to 94°C)	<b>E50DS3</b> <sup>⑤</sup>	
	0.065 in	0.030 in	0.250 in	4 lbs	8 oz	14° to 200°F (-10° to 94°C)	14° to 200°F (-10° to 94°C)	<b>E50DS4</b> <sup>⑤</sup>	
<b>Side Pushbutton</b>									
 Maintained	0.200 in	0.130 in	0.320 in	5 lbs	5 lbs	14° to 200°F (-10° to 94°C)	14° to 200°F (-10° to 94°C)	<b>E50DH1</b>	
<b>Top Pushbutton</b>									
 Spring return	0.040 in	0.020 in	0.280 in	4 lbs	8 oz	14° to 250°F (-10° to 121°C)	14° to 221°F (-10° to 105°C)	<b>E50DT1</b>	
<b>Adjustable Spring Return</b>	Adjustable spring return	0.040 in	0.020 in	0.280 in	4 lbs	8 oz	14° to 250°F (-10° to 121°C)	14° to 221°F (-10° to 105°C)	<b>E50DT2</b>
									

**Notes**

- ① Temperature ranges below 32°F (0°C) are based on absence of freezing moisture or water.
- ② CW (clockwise) and CCW (counterclockwise) operation, easily convertible to CW only or CCW only operation.
- ③ For CW and CCW operation. For CW only or CCW only operation, high temperature limit increases to 250°F (121°C) without cable, and 221°F (105°C) with pre-wired cable.
- ④ Roller can be converted in the field between horizontal and vertical.
- ⑤ Roller shaft is 0.38 in (9.5 mm) longer on E50DS4, see Dimensions on [Page V8-T2-64](#).

#### E50 Heavy-Duty Plug-In Switches, Operating Heads, continued

Description	Travel to Operate Contacts	Travel to Reset Contacts	Total Travel	Force to Operate Contacts	Minimum Return Force	Operating Temperature <sup>①</sup>		Catalog Number
						Without Cable	With Pre-wired Cable	
<b>Top Push Roller</b>								
<b>Top Push Roller</b>								
Spring return	0.040 in	0.020 in	0.280 in	4 lbs	8 oz	14° to 250°F (-10° to 121°C)	14° to 221°F (-10° to 105°C)	<b>E50DT3</b>
<b>Wobble Head, Spring Return</b> (requires a wobble operator, see <b>Page V8-T2-78</b> )								
Standard duty	10°	6°	15°	2 in-lbs	2.4 in-oz	14° to 250°F (-10° to 121°C)	14° to 221°F (-10° to 105°C)	<b>E50DW1</b>
Heavy-duty high strength steel	10°	6°	15°	2 in-lbs	2.4 in-oz	14° to 250°F (-10° to 121°C)	14° to 221°F (-10° to 105°C)	<b>E50DW2</b>



#### Switch Bodies

#### E50 Heavy-Duty Plug-In Switches, Switch Bodies



**Single-Pole 1NO-1NC**  
Catalog Number



**Two-Pole 2NO-2NC**  
Parallel Wired Indicator Light  
Catalog Number



**Two-Pole 2NC-1NO**  
Series Wired Indicator Light  
Catalog Number

Switch Body Construction <sup>①</sup>	Single-Pole 1NO-1NC Catalog Number	Two-Pole 2NO-2NC Parallel Wired Indicator Light Catalog Number	Two-Pole 2NC-1NO Series Wired Indicator Light Catalog Number
Without indicating light	<b>E50SA</b> CE	<b>E50SB</b>	—
With LED indicating light 24–120 Vac/dc	<b>E50SAL</b>	<b>E50SBL</b>	<b>E50SCL</b>
With neon indicating light 120 Vac	<b>E50SAN</b>	<b>E50SBN</b>	—









**Circuit Diagrams**, see **Page V8-T2-63**.

**Note**

<sup>①</sup> Indicating lights are supplied from the factory wired as shown in Circuit Diagrams on **Page V8-T2-63**. However, they can be easily re-connected to terminals 1 and 2 if necessary (SPDT).

## Receptacles

## E50 Heavy-Duty Plug-In Switches, Receptacles

	Description	Poles	Conduit Entrance	Cable Length	Catalog Number
<b>Surface Mount</b> 	<b>Surface Mount</b> Conduit entrance, front or rear mounting	Single-pole (5 terminal)	1/2 NPT	—	<b>E50RA</b>
			20 mm	—	<b>E50RA20</b>
		Two-pole (9 terminal)	1/2 NPT	—	<b>E50RB</b>
			3/4 NPT	—	<b>E50RB34</b>
			20 mm	—	<b>E50RB20</b>
<b>Manifold Mount</b> 	<b>Manifold Mount</b> Rear wiring entrance instead of conduit hole, gasket on back for oil tightness	Single-pole (5 terminal)	—	—	<b>E50RAM</b>
		Two-pole (9 terminal)	—	—	<b>E50RBM</b>
<b>Mini-Connector</b> 	<b>Mini-Connector</b> Epoxy filled receptacle with pre-wired mini-connector. (The -W version is a wiring scheme typically used in automotive applications.)	Single-pole (5 terminal)	5-pin mini-connector	—	<b>E50RAP5</b> 
				—	<b>E50RAP5-W</b> 
		Two-pole (9 terminal)	9-pin mini-connector	—	<b>E50RBP9</b> 
<b>Micro-Connector</b> 	<b>Micro-Connector</b> Epoxy filled receptacle with M12 DC micro-connector	Single-pole (5 terminal)	—	—	<b>E50RAA5</b> <sup>①</sup>
<b>Pre-Wired Cable</b> 	<b>Pre-Wired Cable</b> Epoxy filled receptacle with pre-wired 16 gauge, yellow jacketed, type S00W-A cable. Cable enters through hole threaded for conduit.	Single-pole (5 terminal)	1/2 NPT	8 ft	<b>E50RAS</b>
				12 ft	<b>E50RAS12</b>
				20 ft	<b>E50RAS20</b>
			20 mm	8 ft	<b>E50RA20S</b>
				12 ft	<b>E50RA20S12</b>
				20 ft	<b>E50RA20S20</b>
		Two-pole (9 terminal)	1/2 NPT	8 ft	<b>E50RBS</b>
				12 ft	<b>E50RBS12</b>
			20 mm	20 ft	<b>E50RBS20</b>
				8 ft	<b>E50RB20S</b>
		12 ft	<b>E50RB20S12</b>		
		20 ft	<b>E50RB20S20</b>		

**Wiring Diagrams**, see **Page V8-T2-63**.

**Notes**

  See listing of compatible connector cables on **Page V8-T2-60**.

<sup>①</sup> Model E50RAA5 is not UL listed or CSA certified.

# 2.6





## Limit Switches

### E50 Heavy-Duty Plug-In Switches

2



#### Compatible Connector Cables

##### Standard Cables <sup>①</sup>

	Current Rating at 600V	Voltage Style	Number of Pins	Gauge	Length	Pin Configuration/Wire Colors (Face View Female Shown)	Catalog Number
<b>Mini-style Straight Female</b> 	<b>Mini-Style, Straight Female</b>						
	8A	—	5-pin	16 AWG	6 ft (2m)	 1-White 2-Red 3-Green 4-Orange 5-Black	<b>CSMS5D5CY1602</b>
	7A	—	9-pin	16 AWG	12 ft (4m)	 1-Orange 2-Blue 3-Red/Black 4-Green/Black 5-White 6-Red 7-Green 8-White/Black 9-Black	<b>CSMS9D9CY1602</b>
<b>Micro-Style</b> 	<b>Micro-Style</b>						
	4A	—	5-pin, 5-wire	22 AWG	6.0 ft (2m)	 1-Brown 2-White 3-Blue 4-Black 5-Green/Yellow	<b>CSDS5A5CY2202</b>

#### Accessories

##### E50 Heavy-Duty Plug-In Switch Accessories



	Description	Catalog Number
<b>E50KH7</b> 	<b>Adapter Plate</b>	
	Allows E50 to replace Square D Type AW Surface Mounting Non Plug-In Standard Box Limit Switch	<b>E50KH7</b>
<b>E50KH4</b> 	Allows E50 to replace National Acme, Type D-1200M, Style 2 Mounting. Denison LoxSwitch, Model L-100W, Style 2 Mounting. Square D 9007 Type T, Style B Mounting. (Adapter plate is 1/8 in thick, with 1/4 in mounting holes.) Namco® long mount.	<b>E50KH4</b> <sup>①</sup>
<b>E50KH5</b> 	Allows E50 to replace National Acme, Type D-1200M, Style 1 Mounting. Denison LoxSwitch, Model L-100W, Style 1 Mounting. Square D 9007 Type T, Style C mounting. (Adapter plate is 1/8 in thick, with 1/4 in mounting holes.)	<b>E50KH5</b> <sup>①</sup>

Dimensions, see **Page V8-T2-65**.

#### Note

<sup>①</sup> For a full selection of connector cables, see **Tab 10, section 10.1**.

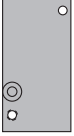
## E50 Heavy-Duty Plug-In Switch Accessories, continued

Description	Catalog Number
<b>Adapter Plate, continued</b>	
<b>E50KH2</b>  Allows E50 to replace Eaton's 10316 Type LT Non Plug-In Two-Pole Limit Switch	<b>E50KH2</b>
<b>E50KH10</b>  Allows E50 to replace Allen-Bradley 802M Sealed Limit Switch	<b>E50KH10</b>
<b>Adjustable Mounting Plate</b>	
<b>E50KH3</b>  This is a mounting plate only 5/16 in thick and includes the proper mounting bolts and nuts. The slots in the plate allow a maximum horizontal adjustment of 1 in and vertical adjustment of 1-1/4 in	<b>E50KH3</b> ①
<b>E50KH6</b>  1/2 in oiltight	<b>E50KH6</b>
<b>Dimensions, see Page V8-T2-65.</b>	

**Note**

① Limit switch not included.

## Technical Data and Specifications

## E50 Heavy-Duty Plug-In Switches

Description	Specification
Environmental ratings	NEMA 1, 3, 3S, 4, 4X, 6, 6P, 13, IP67
Material of construction	Zinc die cast
Switch gasket material	Viton
Universal U.S./DIN mounting dimensions	1.16 in (30 mm) x 2.34 in (60 mm)
Conduit entrance	1/2 in NPT or 20 mm threading
Contact ratings	See below
Contact operation	Snap action over center mechanism
Contact material	Fine silver
Maximum frequency of operation	8000 operations per hour
Mechanical life	
Side rotary	13,000,000 operations minimum
Side or top push	10,000,000 operations minimum
Electrical life	
Single-pole	1,000,000 operations typical at full load
Two-pole	100,000 operations typical at full load

## E50 Heavy-Duty Plug-In Switches, continued

Description	Specification
Ambient temperature range—standard	
Standard without cable	14° to 250°F (–10° to 121°C)
Standard with cable	14° to 221°F (–10° to 105°C)
Low temperature without cable	–40° to 250°F (–40° to 121°C)
Low temperature with cable	–40° to 221°F (–40° to 105°C)
Repeat accuracy—standard	
Side operated	Within 0.0012 in
Top operated	Within 0.0003 in
Side rotary	Within 0.0014 in
Torque requirements:	
Switch body screws	25–30 lb-in
Operating head screws	14–18 lb-in
Wire size	Will accept AWG #22–#12, single or stranded wire

## Electrical Data—Maximum Contact Ratings (Same polarity each pole)

AC Volts	Current, Amperes			Voltamperes		DC Volts	Current, Amperes	
	Make	Break	Cont. ①	Make	Break		Max. Make or Break	Cont. ①
<b>All Switches Except Gravity Return and Indicating Light Versions</b>								
NEMA A600 Rating						NEMA R300		
120	60	6	10	7200	720	125	0.22	1.0
240	30	3	10	7200	720	250	0.11	1.0
480	15	1.5	10	7200	720	250	0.11	1.0
600	12	1.2	10	7200	720	250	0.11	1.0
<b>Switches with Indicating Lights (LED or Neon)</b>								
NEMA A150 Rating						NEMA R150		
120	60	6	10	7200	720	125	0.22	1.0
<b>Gravity Return Switches—Maximum Contact Ratings</b>								
NEMA 6600 Rating—Contacts on same polarity								
120	30	3	5	3600	360	—	—	—
240	15	1.5	5	3600	360	—	—	—
480	7.5	0.75	5	3600	360	—	—	—
600	6	0.60	5	3600	360	—	—	—

**Note**

① Thermal rating. Valid only if switch does not have to make or break.

**Circuit Diagrams**

**Standard Assembled Switches and Switch Bodies**

**Single-Pole 1NO-1NC**

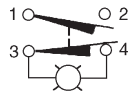

*Must be same polarity.*

**Two-Pole 2NO-2NC**

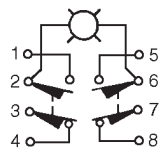

*Parallel wired indicator light. Same polarity each pole.*

**Two-Pole 1NO-2NC**

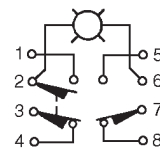

*Series wired indicator light. Same polarity each pole.*

**Special Purpose Assembled Switches**

**Neutral Position**

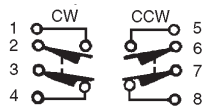

*Same polarity, each pole.*

**Two-Step (CW, CCW, or Both)**

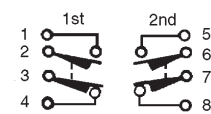

*Same polarity, each pole.*

**Gravity Return**



*Must be same polarity.*

**Wiring Diagrams**

**Receptacles ①**

**E50RAP5**

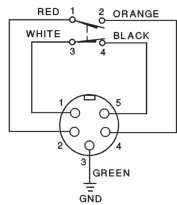

**E50RAP5-W**

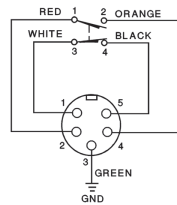

**E50RBP9**

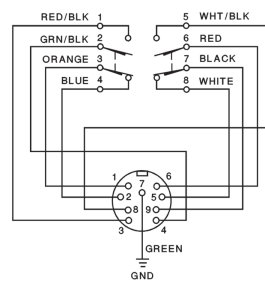

**E50RAA5**

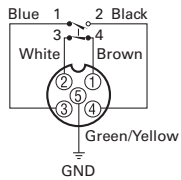

**E50RAS\_**

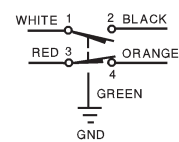

**E50RBS\_**

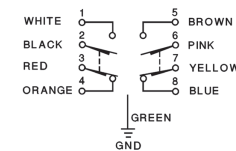

**Note**

① The wire colors referenced on these diagrams are those internal to the switch itself.



# 2.6

## Limit Switches

### E50 Heavy-Duty Plug-In Switches

#### Dimensions

Approximate Dimensions in Inches (mm)

2

#### Standard

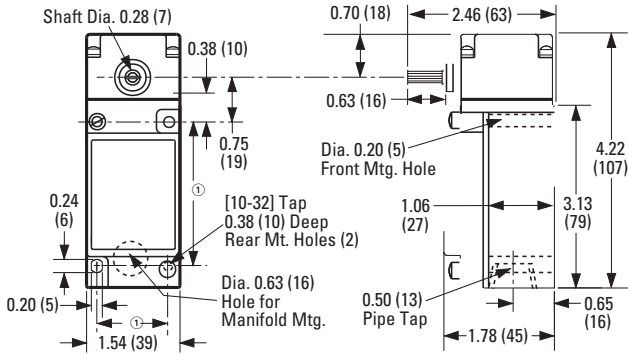

#### E50SB34

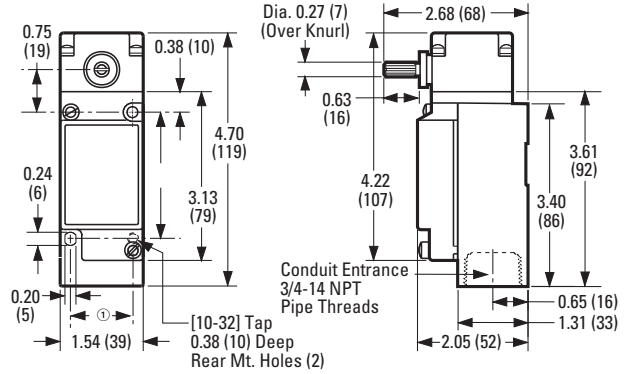

#### Side Push Operators

Approximate Dimensions in mm [in]

##### Pushbutton

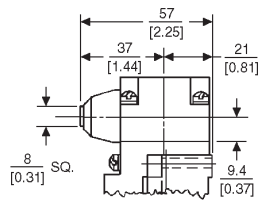

##### Adjustable Pushbutton

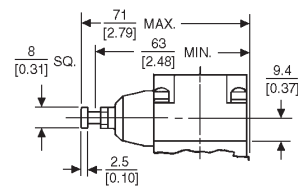

##### Roller

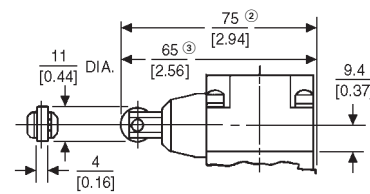

#### Maintained Pushbutton

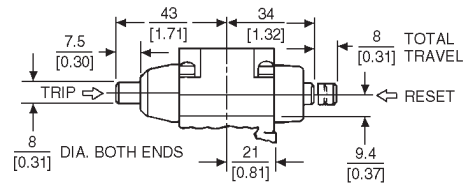

#### Top Push Operators

##### Pushbutton

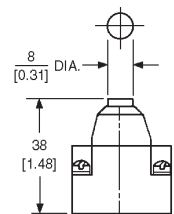

##### Adjustable Pushbutton

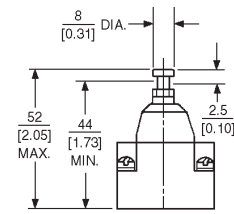

##### Roller

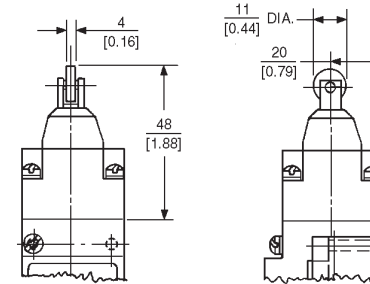

#### Wobble Operators

See Operators on [Page V8-T2-78](#).

#### Notes

- ① Can accommodate both U.S., 1.16 (29.4) x 2.34 (59.5) and DIN, 1.18 (30) x 2.36 (60), mounting dimensions.
- ② For E50DS4.
- ③ For E50DS3.

**Accessories**

Approximate Dimensions in mm [in]

**Adapter Plates**

**E50KH1M**

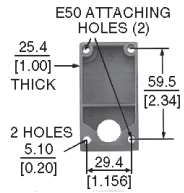

**E50KH7**

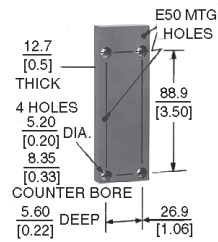

**E50KH4**

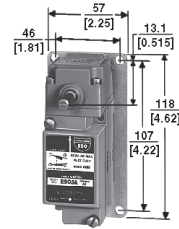

**E50KH5**

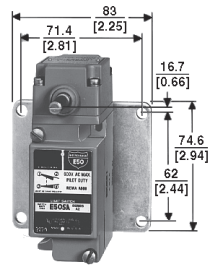

**E50KH2**

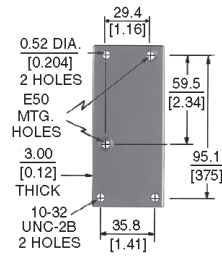

**E50KH10**

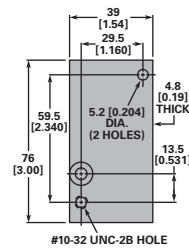

**Adjustable Mounting Plate**

**E50KH3**

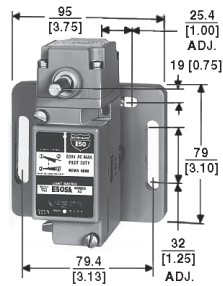

#### E50 Heavy-Duty Factory Sealed 6P+ Switches

2



#### Contents

##### Description

Page

E50 Heavy-Duty Factory Sealed 6P+ Switches	
Product Selection	
Assembled Switches—Standard	V8-T2-67
Operating Heads	V8-T2-70
Switch Bodies	V8-T2-71
Compatible Connector Cables	V8-T2-72
Accessories	V8-T2-72
Technical Data and Specifications	V8-T2-74
Circuit Diagrams	V8-T2-75
Wiring Diagrams	V8-T2-75
Dimensions	V8-T2-76

Drawings  
Online

### E50 Heavy-Duty Factory Sealed 6P+ Switches

#### Product Description

E50 6P+ Limit Switches by Eaton's electrical sector were specifically designed to withstand the penetrating properties of cutting fluids and coolants, such as those used in the automotive industry, as well as extreme shock, vibration and temperature fluctuations. The one-piece, epoxy filled switch body is prewired at the factory to ensure leak-proof, submersible performance. This unique construction positively stops fluid from finding its way to any and all critical connections.

Our 6P+ switches can be ordered in separate components or as complete assembled devices. They are available with prewired 16 AWG cables or mini-connectors. Standard and custom cable lengths are available. As part of the E50 line, the 6P+ switches use the same operating heads as the standard E50 plug-in models to reduce the components you need to inventory.

#### Features

- Manufactured to take the physical and environmental abuse (including cutting fluids and chemicals) of harsh industrial environments
- Modular, plug-in components (head and switch body) provide application flexibility, reduced inventory and less downtime
- Chemical resistant Viton gaskets, seals and boots are standard, and so are captive, posi-drive screws
- A special internal seal on the switch body prevents fluid from entering even when the operating head is not attached
- 600V rating, ridge-topped contacts and wiping action assure continuity even to logic level circuits
- Factory wired cable features a 350 pound pullout capacity
- Keyed, four direction head positioning. Standard 5° pre-travel and 90° total travel
- 24–120 Vac/dc LED and 120 Vac neon indicating lights available
- Rotary heads are field convertible CW, CCW, or both, without special tools

#### Standards and Certifications

- UL Listed, E170645
- CSA Certified, 50513
- CE (where shown)
- RoHS Compliant



#### **⚠ DANGER**

**THIS SENSOR IS NOT A SAFETY DEVICE AND IS NOT INTENDED TO BE USED AS A SAFETY DEVICE. This sensor is designed only to detect and read certain data in an electronic manner and perform no use apart from that, specifically no safety-related use. This sensor product does not include self-checking redundant circuitry, and the failure of this sensor product could cause either an energized or de-energized output condition, which could result in death, serious bodily injury, or property damage.**

For the most current information on this product, visit our Web site: [www.eaton.com](http://www.eaton.com)

For Customer Service in the U.S. call 1-877-ETN CARE (386-2273), in Canada call 1-800-268-3578. For Application Assistance in the U.S. and Canada call 1-800-426-9184.

**Product Selection**

**Assembled Switches—Standard**

Connection is by 8 ft cable ①.

**Assembled Switch E50 Heavy-Duty Factory Sealed 6P+ Switches, Assembled—Standard**



Single-Pole



Two-Pole

<b>Indicating Light:</b>	None	LED (24–120 Vac/dc)	Neon (120 Vac)	None	LED (24–120 Vac/dc)	Neon (120 Vac)
<b>Switch Body:</b>	E50SA6P 1NO-1NC	E50SAL6P 1NO-1NC	E50SAN6P 1NO-1NC	E50SB6P 2NO-2NC	E50SBL6P 2NO-2NC	E50SBN6P 2NO-2NC

**Operating Head Type ②**

**Side Rotary**



Description	Assembled Switch Catalog Number			Assembled Switch Catalog Number		
<b>Side Rotary</b> (requires an operating lever, see Page V8-T2-78)						
Standard spring return—E50DR1 ③	E50AR16P C C	E50ALR16P	E50ANR16P	E50BR16P	E50BLR16P	E50BNR16P
Low force spring return—E50DL1 ③	E50AL16P C C	E50ALL16P	E50ANL16P	E50BL16P	E50BLL16P	E50BNL16P
Maintained two-position—E50DM1	E50AM16P C C	E50ALM16P	E50ANM16P	E50BM16P	E50BLM16P	E50BNM16P

**Spring Return**



Spring return—E50DS1	E50AS16P C C	E50ALS16P	E50ANS16P	E50BS16P	E50BLS16P	E50BNS16P
----------------------	-----------------	-----------	-----------	----------	-----------	-----------

**Adjustable Spring Return**



Adjustable spring return—E50DS2	E50AS26P C C	E50ALS26P	E50ANS26P	E50BS26P	E50BLS26P	E50BNS26P
---------------------------------	-----------------	-----------	-----------	----------	-----------	-----------

**Circuit Diagrams**, see Page V8-T2-75.

**Notes**

① Connection options (add the code suffix from the table below to the end of the catalog number):

Option		Catalog Number	Code Suffix
Mini-connector ④	Single-pole (5-pin mini-connector)	CSMS5D5CY1602	C
	Two-pole (9-pin mini-connector)	CSMS9D9CY1602	C
Cable connection	12 ft cable length (standard)	—	12
	20 ft cable length (standard)	—	20
	Other lengths (special order)	—	Length in ft

② For operating head specifications, see Page V8-T2-70.

③ CW (clockwise) and CCW (counterclockwise) operation, easily convertible to CW only or CCW only operation.

④ For a full selection of connector cables, see Tab 10, section 10.1.

# 2.7

## Limit Switches

### E50 Heavy-Duty Factory Sealed 6P+ Switches

Connection is by 8 ft cable ①.

2

#### Assembled Switch

#### E50 Heavy-Duty Factory Sealed 6P+ Switches, Assembled—Standard, continued



Lever sold separately



Single-Pole

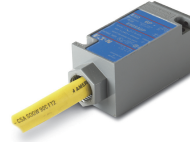

Two-Pole

Indicating Light:	Single-Pole			Two-Pole		
	None	LED (24–120 Vac/dc)	Neon (120 Vac)	None	LED (24–120 Vac/dc)	Neon (120 Vac)
Switch Body:	E50SA6P 1NO-1NC	E50SAL6P 1NO-1NC	E50SAN6P 1NO-1NC	E50SB6P 2NO-2NC	E50SBL6P 2NO-2NC	E50SBN6P 2NO-2NC
<b>Operating Head Type</b> ②	<b>Description</b>			<b>Assembled Switch Catalog Number</b>		

#### Side Push Roller



Description	Assembled Switch Catalog Number			Assembled Switch Catalog Number		
	Side Push Roller					
Spring return— E50DS3 ③	E50AS36P CE	E50ALS36P	E50ANS36P	E50BS36P	E50BLS36P	E50BNS36P

#### Side Pushbutton



Description	Assembled Switch Catalog Number			Assembled Switch Catalog Number		
	Side Pushbutton					
Maintained— E50DH1	E50AH16P CE	E50ALH16P	E50ANH16P	E50BH16P	E50BLH16P	E50BNH16P

#### Top Pushbutton

#### Spring Return



Description	Assembled Switch Catalog Number			Assembled Switch Catalog Number		
	Spring return— E50DT1	E50AT16P CE	E50ALT16P	E50ANT16P	E50BT16P	E50BLT16P

#### Adjustable Spring Return



Description	Assembled Switch Catalog Number			Assembled Switch Catalog Number		
	Adjustable spring return—E50DT2	E50AT26P CE	E50ALT26P	E50ANT26P	E50BT26P	E50BLT26P

**Circuit Diagrams**, see **Page V8-T2-75**.

#### Notes

① Connection options (add the code suffix from the table below to the end of the catalog number):

Option		Catalog Number	Code Suffix
Mini-connector ④	Single-pole (5-pin mini-connector)	CSMS5D5CY1602	C
	Two-pole (9-pin mini-connector)	CSMS9D9CY1602	C
Cable connection	12 ft cable length (standard)	—	12
	20 ft cable length (standard)	—	20
	Other lengths (special order)	—	Length in ft

② For operating head specifications, see **Page V8-T2-70**.

③ Roller can be converted in the field between horizontal and vertical.

④ For a full selection of connector cables, see **Tab 10, section 10.1**.

Connection is by 8 ft cable ①.

**Assembled Switch** E50 Heavy-Duty Factory Sealed 6P+ Switches, Assembled—Standard, continued

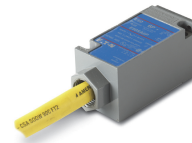

	Single-Pole			Two-Pole		
<b>Indicating Light:</b>	None	LED (24–120 Vac/dc)	Neon (120 Vac)	None	LED (24–120 Vac/dc)	Neon (120 Vac)
<b>Switch Body:</b>	E50SA6P 1NO-1NC	E50SAL6P 1NO-1NC	E50SAN6P 1NO-1NC	E50SB6P 2NO-2NC	E50SBL6P 2NO-2NC	E50SBN6P 2NO-2NC

**Operating Head Type** ②

**Top Push Roller**



Description	Assembled Switch Catalog Number			Assembled Switch Catalog Number		
<b>Top Push Roller</b>						
Spring return—E50DT3	E50AT36P CE	E50ALT36P	E50ANT36P	E50BT36P	E50BLT36P	E50BNT36P

**Wobble Head, Spring Return**



<b>Wobble Head, Spring Return</b> (requires a wobble operator, see Page V8-T2-78)						
Standard duty—E50DW1	E50AW16P CE	E50ALW16P	E50ANW16P	E50BW16P	E50BLW16P	E50BNW16P
Heavy-duty high strength steel—E50DW2	E50AW26P CE	E50ALW26P	E50ANW26P	E50BW26P	E50BLW26P	E50BNW26P

**Circuit Diagrams**, see Page V8-T2-75.

**Notes**

① Connection options (add the code suffix from the table below to the end of the catalog number):

Option		Catalog Number	Code Suffix
Mini-connector ③	Single-pole (5-pin mini-connector)	CSMS5D5CY1602	C
	Double-pole (9-pin mini-connector)	CSMS9D9CY1602	C
Cable connection	12 ft cable length (standard)	—	12
	20 ft cable length (standard)	—	20
	Other lengths (special order)	—	Length in ft







② For operating head specifications, see Page V8-T2-70.

③ For a full selection of connector cables, see Tab 10, section 10.1.

## Operating Heads

2

## E50 Heavy-Duty Factory Sealed 6P+ Switches, Operating Heads

Description	Travel to Operate Contacts	Travel to Reset Contacts	Total Travel	Force to Operate Contacts	Minimum Return Force	Operating Temperature <sup>①</sup>		Catalog Number	
						Without Cable	With Pre-wired Cable		
<b>Side Rotary</b> (requires an operating lever, see <a href="#">Page V8-T2-78</a> )									
 Standard spring return <sup>②</sup>	5°	2°	90°	3 in-lbs	4.5 in-oz	10° to 200°F (-12° to 94°C) <sup>③</sup>	10° to 200°F (-12° to 94°C) <sup>③</sup>	<b>E50DR1</b>	
Low temperature spring return <sup>②</sup>	5°	2°	90°	3 in-lbs	4.5 in-oz	-40° to 175°F (-40° to 79°C) <sup>③</sup>	-31° to 175°F (-34° to 79°C) <sup>③</sup>	<b>E50DR19</b>	
Low force spring return <sup>②</sup>	15°	6°	90°	1.5 in-lbs	2.5 in-oz	10° to 200°F (-12° to 94°C) <sup>③</sup>	10° to 200°F (-12° to 94°C) <sup>③</sup>	<b>E50DL1</b>	
Maintained two-position	50°	50°	90°	3 in-lbs	—	14° to 200°F (-10° to 94°C)	14° to 200°F (-10° to 94°C)	<b>E50DM1</b>	
<b>Side Pushbutton</b>									
 Spring return	0.065 in	0.030 in	0.250 in	4 lbs	8 oz	14° to 200°F (-10° to 94°C)	14° to 200°F (-10° to 94°C)	<b>E50DS1</b>	
<b>Adjustable Spring Return</b>	Adjustable spring return	0.065 in	0.030 in	0.250 in	4 lbs	8 oz	14° to 200°F (-10° to 94°C)	14° to 200°F (-10° to 94°C)	<b>E50DS2</b>
									
<b>Side Push Roller</b>									
 Spring return <sup>④</sup>	0.065 in	0.030 in	0.250 in	4 lbs	8 oz	14° to 200°F (-10° to 94°C)	14° to 200°F (-10° to 94°C)	<b>E50DS3</b> <sup>⑤</sup>	
	0.065 in	0.030 in	0.250 in	4 lbs	8 oz	14° to 200°F (-10° to 94°C)	14° to 200°F (-10° to 94°C)	<b>E50DS4</b> <sup>⑤</sup>	
<b>Side Pushbutton</b>									
 Maintained	0.200 in	0.130 in	0.320 in	5 lbs	5 lbs	14° to 200°F (-10° to 94°C)	14° to 200°F (-10° to 94°C)	<b>E50DH1</b>	
<b>Top Pushbutton</b>									
 Spring return	0.040 in	0.020 in	0.280 in	4 lbs	8 oz	14° to 250°F (-10° to 121°C)	14° to 221°F (-10° to 105°C)	<b>E50DT1</b>	
<b>Adjustable Spring Return</b>	Adjustable spring return	0.040 in	0.020 in	0.280 in	4 lbs	8 oz	14° to 250°F (-10° to 121°C)	14° to 221°F (-10° to 105°C)	<b>E50DT2</b>
									

**Notes**

- ① Temperature ranges below 32°F (0°C) are based on absence of freezing moisture or water.
- ② CW (clockwise) and CCW (counterclockwise) operation, easily convertible to CW only or CCW only operation.
- ③ For CW and CCW operation. For CW only or CCW only operation, high temperature limit increases to 250°F (121°C) without cable, and 221°F (105°C) with pre-wired cable.
- ④ Roller can be converted in the field between horizontal and vertical.
- ⑤ Roller shaft is 0.38 in (9.5 mm) longer on E50DS4, see Dimensions on [Page V8-T2-76](#).

## E50 Heavy-Duty Factory Sealed 6P+ Switches

## E50 Heavy-Duty Factory Sealed 6P+ Switches, Operating Heads, continued

Description	Travel to Operate Contacts	Travel to Reset Contacts	Total Travel	Force to Operate Contacts	Minimum Return Force	Operating Temperature <sup>①</sup>		Catalog Number
						Without Cable	With Pre-Wired Cable	
<b>Top Push Roller</b>	<b>Top Push Roller</b>							
Spring return	0.040 in	0.020 in	0.280 in	4 lbs	8 oz	14° to 250°F (-10° to 121°C)	14° to 221°F (-10° to 105°C)	<b>E50DT3</b>
<b>Wobble Head, Spring Return</b>	<b>Wobble Head, Spring Return</b> (requires a wobble operator, see <a href="#">Page V8-T2-78</a> )							
Standard duty	10°	6°	15°	2 in-lbs	2.4 in-oz	14° to 250°F (-10° to 121°C)	14° to 221°F (-10° to 105°C)	<b>E50DW1</b>
Heavy-duty high strength steel	10°	6°	15°	2 in-lbs	2.4 in-oz	14° to 250°F (-10° to 121°C)	14° to 221°F (-10° to 105°C)	<b>E50DW2</b>

Circuit Diagrams, see [Page V8-T2-75](#).

## Switch Bodies

## E50 Heavy-Duty Factory Sealed 6P+, Switch Bodies

Circuit	Switch Body Construction	Cable Length	Catalog Number
<b>Pre-Wired Cable</b>			
Single-pole 1NO-1NC	Without indicating light	8 ft	<b>E50SA6P</b>
		12 ft	<b>E50SA6P12</b>
		20 ft	<b>E50SA6P20</b>
	With LED indicating light 24–120 Vac/dc	8 ft	<b>E50SAL6P</b>
		12 ft	<b>E50SAL6P12</b>
		20 ft	<b>E50SAL6P20</b>
	With neon indicating light 120 Vac	8 ft	<b>E50SAN6P</b>
		12 ft	<b>E50SAN6P12</b>
		20 ft	<b>E50SAN6P20</b>
Two-pole 2NO-2NC	Without indicating light	8 ft	<b>E50SB6P</b>
		12 ft	<b>E50SB6P12</b>
		20 ft	<b>E50SB6P20</b>
	With LED indicating light 24–120 Vac/dc	8 ft	<b>E50SBL6P</b>
		12 ft	<b>E50SBL6P12</b>
		20 ft	<b>E50SBL6P20</b>
	With neon indicating light 120 Vac	8 ft	<b>E50SBN6P</b>
		12 ft	<b>E50SBN6P12</b>
		20 ft	<b>E50SBN6P20</b>
<b>Mini-Connector</b>			
Single-pole 1NO-1NC	Without indicating light normal wiring	—	<b>E50SA6PC</b> ☼
	Without indicating light alternate wiring	—	<b>E50SA6PC-W</b> ☼
	With LED indicating light 24–120 Vac/dc	—	<b>E50SAL6PC</b> ☼
	With neon indicating light 120 Vac	—	<b>E50SAN6PC</b> ☼
Two-pole 2NO-2NC	Without indicating light	—	<b>E50SB6PC</b> ☼
	With LED indicating light 24–120 Vac/dc	—	<b>E50SBL6PC</b> ☼
	With neon indicating light 120 Vac	—	<b>E50SBN6PC</b> ☼

## Notes

☼ See listing of compatible connector cables on [Page V8-T2-72](#).

① Temperature ranges below 32°F (0°C) are based on absence of freezing moisture or water.



#### Compatible Connector Cables

2

#### Mini-Style, Straight Female







#### Standard Cables <sup>①</sup>

Current Rating at 600V	Voltage Style	Number of Pins	Gauge	Length	Pin Configuration/Wire Colors (Face View Female Shown)	Catalog Number
<b>Mini-Style, Straight Female</b>						
8A	—	5-pin	16 AWG	6 ft (2m)		<b>CSMS5D5CY1602</b>
7A	—	9-pin	16 AWG	12 ft (4m)		<b>CSMS9D9CY1602</b>

#### Accessories

#### E50 Heavy-Duty Factory Sealed 6P+ Switch Accessories

		Catalog Number
<b>E50KH1M</b>	<b>Adapter Plate</b>	
	Allows E50 to replace Eaton's 10316 Type LP Manifold Mounting Plug-In Limit Switch	<b>E50KH1M</b>
<b>E50KH7</b>	Allows E50 to replace Square D Type AW Surface Mounting Non Plug-In Standard Box Limit Switch	<b>E50KH7</b>
		
<b>E50KH4</b>	Allows E50 to replace National Acme, Type D-1200M, Style 2 Mounting, Denison LoxSwitch, Model L-100W, Style 2 Mounting, Square D 9007 Type T, Style B Mounting. (Adapter plate is 1/8 in thick, with 1/4 in mounting holes.) Namco® long mount.	<b>E50KH4</b> <sup>①</sup>
		
<b>E50KH5</b>	Allows E50 to replace National Acme, Type D-1200M, Style 1 Mounting, Denison LoxSwitch, Model L-100W, Style 1 Mounting, Square D 9007 Type T, Style C mounting. (Adapter plate is 1/8 in thick, with 1/4 in mounting holes.)	<b>E50KH5</b> <sup>①</sup>
		

Dimensions, see **Page V8-T2-76**.

#### Note

<sup>①</sup> For a full selection of connector cables, see **Tab 10, section 10.1**.

E50 Heavy-Duty Factory Sealed 6P+ Switch Accessories, continued

Catalog Number

Adapter Plate, continued

E50KH2

Allows E50 to replace Eaton's 10316 Type LT Non Plug-In Two-Pole Limit Switch

E50KH2



E50KH10

Allows E50 to replace Allen-Bradley 802M Sealed Limit Switch

E50KH10

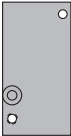

Adjustable Mounting Plate

E50KH3

This is a mounting plate only 5/16 in thick and includes the proper mounting bolts and nuts. The slots in the plate allow a maximum horizontal adjustment of 1 in and vertical adjustment of 1-1/4 in

E50KH3 ①

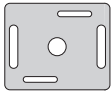

Conduit Sealing Nut

E50KH6

1/2 in oiltight

E50KH6



Dimensions, see Page V8-T2-76.

Note

① Limit switch not included.

## Technical Data and Specifications

2

### E50 Heavy-Duty Factory Sealed 6P+ Switches

Description	Specification
Environmental ratings	NEMA 1, 3, 3S, 4, 4X, 6, 6P, 13, IP67, IP69
Material of construction	Zinc die cast
Switch gasket material	Viton
Universal U.S./DIN mounting dimensions	1.16 in (30 mm) x 2.34 in (60 mm)
Conduit entrance	1/2 in NPT or 20 mm threading
Contact ratings	See below
Contact operation	Snap action over center mechanism
Contact material	Fine silver
Maximum frequency of operation	8000 operations per hour
Mechanical life	
Side rotary	13,000,000 operations minimum
Side or top push	10,000,000 operations minimum
Electrical life	
Single-pole	1,000,000 operations typical at full load
Double-pole	100,000 operations typical at full load
Ambient temperature range—standard	
Standard without cable	14° to 250°F (–10° to 121°C)
Standard with cable	14° to 221°F (–10° to 105°C)
Low temperature without cable	–40° to 250°F (–40° to 121°C)
Low temperature with cable	–40° to 221°F (–40° to 105°C)
Repeat accuracy—standard	
Side operated	Within 0.0012 in
Top operated	Within 0.0003 in
Side rotary	Within 0.0014 in
Torque requirements	
Operating head screws	14–18 lb-in

### Electrical Data—Maximum Contact Ratings (Same polarity each pole)

AC Volts	Current, Amperes			Voltamperes		DC Volts	Current, Amperes		
	Make	Break	Cont. ①	Make	Break		Max. Make or Break	Cont. ①	
<b>All Switches Except Gravity Return and Indicating Light Versions</b>									
NEMA A600 Rating						NEMA R300			
120	60	6	10	7200	720	125	0.22	1.0	
240	30	3	10	7200	720	250	0.11	1.0	
480	15	1.5	10	7200	720	250	0.11	1.0	
600	12	1.2	10	7200	720	250	0.11	1.0	
<b>Switches with Indicating Lights (LED or Neon)</b>									
NEMA A150 Rating						NEMA R150			
120	60	6	10	7200	720	125	0.22	1.0	

#### Note

① Thermal rating. Valid only if switch does not have to make or break.

**Circuit Diagrams** ①

**Standard Assembled Switches**

**Single-Pole 1NO-1NC**

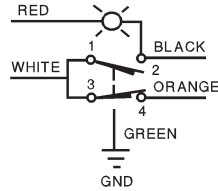
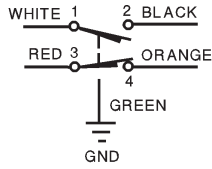

Must be same polarity.

**Switch Bodies**

**Pre-Wired Cable—  
Single-Pole 1NO-1NC**

**E50SA6P\_**

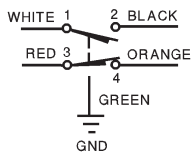

**E50SAL6P\_**

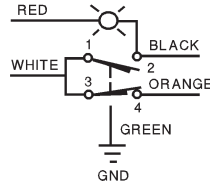

**Two-Pole 2NO-2NC**

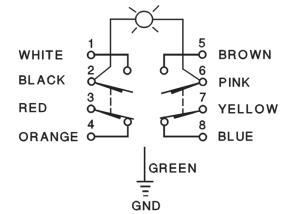
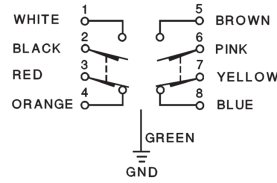

Same polarity, each pole.

**Pre-Wired Cable—  
Two-Pole 2NO-2NC**

**E50SB6P\_**

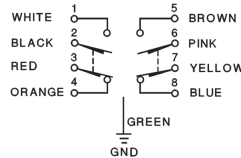

**E50SBL6P\_**

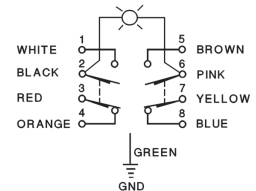

**Wiring Diagrams** ①

**Mini-Connector—Single-Pole 1NO-1NC**

**E50SA6PC**

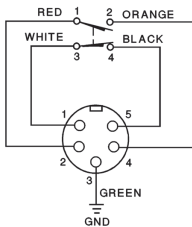

**E50SA6PC-W**

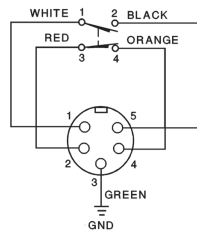

**E50SAL6PC/E50SAN6PC**

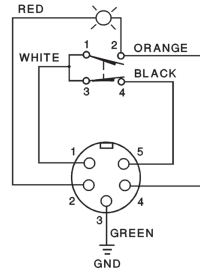

**Mini-Connector—Two-Pole 2NO-2NC**

**E50SB6PC**

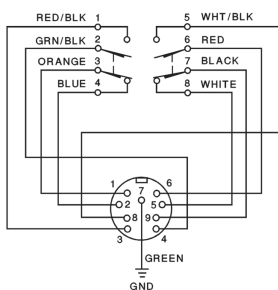

**E50SBL6PC/E50SBN6PC**

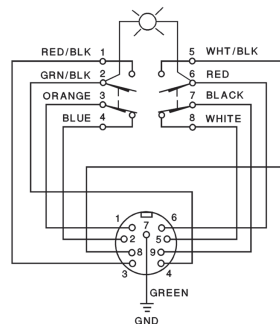

**Note**

① The wire colors referenced on these diagrams are those internal to the switch itself.

# 2.7

## Limit Switches

### E50 Heavy-Duty Factory Sealed 6P+ Switches

#### Dimensions

Approximate Dimensions in Inches (mm)

2

#### Standard

#### 6P+ Limit Switch with Rotary Operating Head

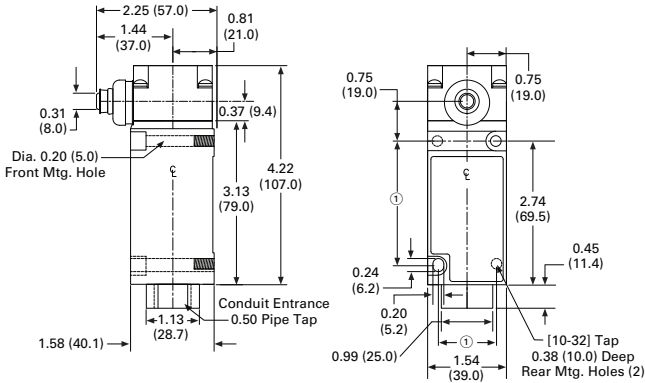

#### Side Push Operators

Approximate Dimensions in mm [in]

#### Pushbutton

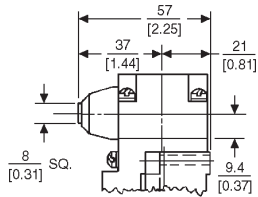

#### Adjustable Pushbutton

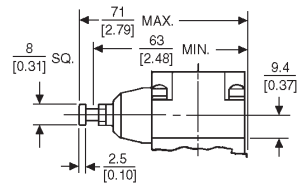

#### Roller

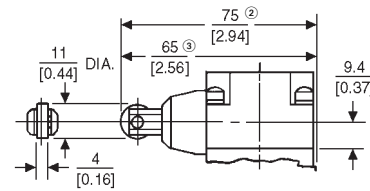

#### Maintained Pushbutton

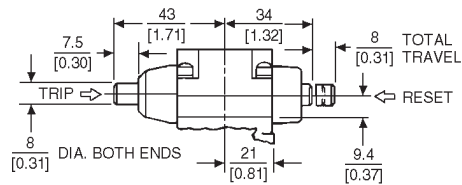

#### Top Push Operators

#### Pushbutton

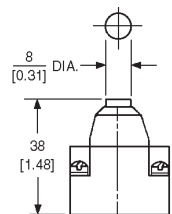

#### Adjustable Pushbutton

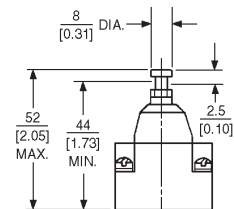

#### Roller

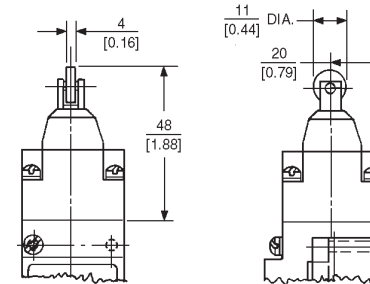

#### Wobble Operators

See Operators on Page V8-T2-78.

#### Notes

- Can accommodate both U.S., 1.16 (29.4) x 2.34 (59.5) and DIN, 1.18 (30.0) x 3.26 (60.0), mounting dimensions.
- For E50DS4.
- For E50DS3.

**Accessories**

Approximate Dimensions in mm [in]

**Adapter Plates**

**E50KH1M**

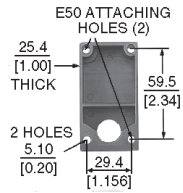

**E50KH7**

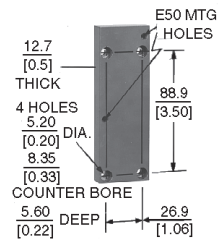

**E50KH4**

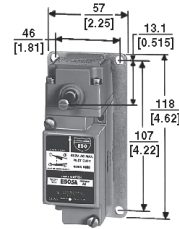

**E50KH5**

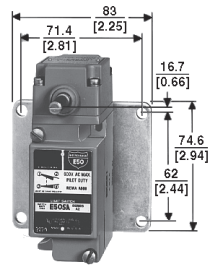

**E50KH2**

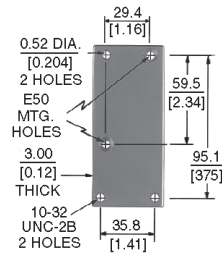

**E50KH10**

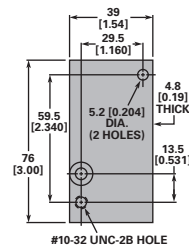

**Adjustable Mounting Plate**

**E50KH3**

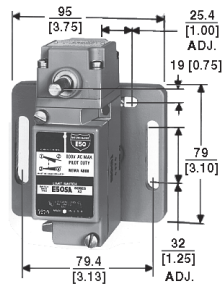

#### Operators

2



#### Contents

##### Description

##### Page

##### Operators

##### Product Selection

Roller Type Operators ..... **V8-T2-79**

Rod Type Operators ..... **V8-T2-81**

Wobble Type Operators ..... **V8-T2-82**

Dimensions ..... **V8-T2-82**

 Drawings  
Online

### Operators

#### Product Description

The Operators presented here are used with Eaton's E50 Plug-In and 6P+ limit switches, as well as our 10316 rotary type limit switches. A wide variety of styles and sizes are available to provide optimum performance for nearly any application.

#### Features

- Wide variety of operator types for rotary and wobble style limit switches
- Rollers and rods available in metal and nonmetal contact surfaces

#### DANGER

**THIS SENSOR IS NOT A SAFETY DEVICE AND IS NOT INTENDED TO BE USED AS A SAFETY DEVICE. This sensor is designed only to detect and read certain data in an electronic manner and perform no use apart from that, specifically no safety-related use. This sensor product does not include self-checking redundant circuitry, and the failure of this sensor product could cause either an energized or de-energized output condition, which could result in death, serious bodily injury, or property damage.**

For the most current information on this product, visit our Web site: [www.eaton.com](http://www.eaton.com)

For Customer Service in the U.S. call 1-877-ETN CARE (386-2273),  
in Canada call 1-800-268-3578.  
For Application Assistance in the U.S. and Canada  
call 1-800-426-9184.

## Product Selection

### Roller Type Operators

For rotary head switches: E50 Plug-In, E50 6P+, and 10316.

**Note:** Only operators with Nylatron rods or rollers should be used with explosion-proof limit switches.





### Operators—Roller Type

Roller Type	Minimum Required Return Torque <sup>①</sup>	Approximate Dimensions in Inches (mm)						Catalog Number	
		A Lever Length <sup>②</sup>	B Roller Diameter	C Roller Width	D	E	F		
<b>E50KL200</b>	<b>Standard Roller (Stainless Steel)</b>								
	Metal	0.95 in-oz	1.38 (34.9)	0.75 (19.0)	0.32 (8.1)	0.34 (8.6)	0.13 (3.3)	0.17 (4.3)	<b>E50KL40</b>
	Ball bearing	0.77 in-oz	1.50 (38.1)	0.69 (17.5)	0.25 (6.4)	0.34 (8.6)	0.05 (1.3)	0.11 (2.8)	<b>E50KL531</b>
	Nylatron	0.53 in-oz	1.50 (38.1)	0.75 (19.0)	0.32 (8.1)	0.34 (8.6)	0.13 (3.3)	0.17 (4.3)	<b>E50KL200</b>
	Metal	1.10 in-oz	1.50 (38.1)	0.75 (19.0)	0.32 (8.1)	0.34 (8.6)	0.13 (3.3)	0.17 (4.3)	<b>E50KL355</b>
<b>E50KL355</b>	Nylatron	0.96 in-oz	1.50 (38.1)	0.75 (19.0)	1.00 (25.4)	0.34 (8.6)	0.83 (21.1)	0.83 (21.1)	<b>E50KL377</b>
	Without roller	0.32 in-oz	1.50 (38.1)	—	—	0.34 (8.6)	—	—	<b>E50KL32</b>
	Ball bearing	1.10 in-oz	2.00 (50.8)	0.69 (17.5)	0.25 (6.4)	0.34 (8.6)	0.05 (1.3)	0.11 (2.8)	<b>E50KL552</b>
	Nylatron	0.71 in-oz	2.00 (50.8)	0.75 (19.0)	0.32 (8.1)	0.34 (8.6)	0.13 (3.3)	0.17 (4.3)	<b>E50KL546</b>
<b>E50KL377</b>	Metal	1.50 in-oz	2.00 (50.8)	0.75 (19.0)	0.32 (8.1)	0.34 (8.6)	0.13 (3.3)	0.17 (4.3)	<b>E50KL549</b>
	Nylatron	1.45 in-oz	2.00 (50.8)	0.75 (19.0)	1.00 (25.4)	0.34 (8.6)	0.83 (21.1)	0.83 (21.1)	<b>E50KL572</b>
	Ball bearing	1.50 in-oz	2.50 (63.5)	0.69 (17.5)	0.25 (6.4)	0.34 (8.6)	0.05 (1.3)	0.11 (2.8)	<b>E50KL553</b>
	Nylatron	1.00 in-oz	2.50 (63.5)	0.75 (19.0)	0.32 (8.1)	0.34 (8.6)	0.13 (3.3)	0.17 (4.3)	<b>E50KL547</b>
	Metal	2.00 in-oz	2.50 (63.5)	0.75 (19.0)	0.32 (8.1)	0.34 (8.6)	0.13 (3.3)	0.17 (4.3)	<b>E50KL550</b>
	Nylatron	1.80 in-oz	2.50 (63.5)	0.75 (19.0)	1.00 (25.4)	0.34 (8.6)	0.83 (21.1)	0.83 (21.1)	<b>E50KL573</b>
<b>E50KL554</b>	Nylatron	1.40 in-oz	2.50 (63.5)	1.50 (38.1)	0.28 (7.1)	0.34 (8.6)	0.11 (2.8)	0.17 (4.3)	<b>E50KL575</b>
	Ball bearing	1.80 in-oz	3.00 (76.2)	0.69 (17.5)	0.25 (6.4)	0.34 (8.6)	0.05 (1.3)	0.11 (2.8)	<b>E50KL554</b>
	Nylatron	1.30 in-oz	3.00 (76.2)	0.75 (19.0)	0.32 (8.1)	0.34 (8.6)	0.13 (3.3)	0.17 (4.3)	<b>E50KL548</b>
	Metal	2.50 in-oz	3.00 (76.2)	0.75 (19.0)	0.32 (8.1)	0.34 (8.6)	0.13 (3.3)	0.17 (4.3)	<b>E50KL551</b>
	Nylatron	2.30 in-oz	3.00 (76.2)	0.75 (19.0)	1.00 (25.4)	0.34 (8.6)	0.83 (21.1)	0.83 (21.1)	<b>E50KL574</b>
	Nylatron	1.80 in-oz	3.00 (76.2)	1.50 (38.1)	0.28 (7.1)	0.34 (8.6)	0.11 (2.8)	0.17 (4.3)	<b>E50KL576</b>
<b>Dimensions, see Page V8-T2-82.</b>									
<b>E50KL580</b>	<b>Roller On Reverse Side (Stainless Steel)</b>								
	Ball bearing	0.77 in-oz	1.50 (38.1)	0.69 (17.5)	0.25 (6.4)	0.34 (8.6)	0.18 (4.6)	0.24 (6.1)	<b>E50KL580</b>
	Nylatron	0.53 in-oz	1.50 (38.1)	0.75 (19.0)	0.32 (8.1)	0.34 (8.6)	0.27 (6.9)	0.31 (7.9)	<b>E50KL310</b>
	Metal	1.10 in-oz	1.50 (38.1)	0.75 (19.0)	0.32 (8.1)	0.34 (8.6)	0.27 (6.9)	0.31 (7.9)	<b>E50KL579</b>
	Nylatron	0.96 in-oz	1.50 (38.1)	1.50 (38.1)	0.28 (7.1)	0.34 (8.6)	0.23 (5.8)	0.31 (7.9)	<b>E50KL536</b>
<b>E50KL24</b>	<b>Offset Inboard Roller (Stainless Steel)</b>								
	Nylatron	0.65 in-oz	1.50 (38.1)	0.75 (19.0)	0.32 (8.1)	0.03 (0.8)	—	—	<b>E50KL24</b>
	Metal	1.20 in-oz	1.50 (38.1)	0.75 (19.0)	0.32 (8.1)	0.03 (0.8)	—	—	<b>E50KL25</b>
	Ball bearing	0.90 in-oz	1.50 (38.1)	0.69 (17.5)	0.25 (6.4)	0.04 (1.0)	—	—	<b>E50KL26</b>
<b>E50KL27</b>	<b>Offset Outboard Roller (Stainless Steel)</b>								
	Nylatron	0.65 in-oz	1.50 (38.1)	0.75 (19.0)	0.32 (8.1)	0.03 (0.8)	—	—	<b>E50KL27</b>
	Metal	1.20 in-oz	1.50 (38.1)	0.75 (19.0)	0.32 (8.1)	0.03 (0.8)	—	—	<b>E50KL28</b>
	Ball bearing	0.90 in-oz	1.50 (38.1)	0.69 (17.5)	0.25 (6.4)	0.04 (1.0)	—	—	<b>E50KL29</b>
	Nylatron	1.10 in-oz	1.50 (38.1)	0.75 (19.0)	1.00 (25.4)	—	—	—	<b>E50KL30</b>
<b>Dimensions, see Page V8-T2-83.</b>									
<b>Notes</b>									
<sup>①</sup> <b>Caution:</b> When selecting lever, the minimum required return torque of lever should not exceed minimum return force available in operating head as given in operating head specifications.									
<sup>②</sup> Length from the operating shaft axis to the roller axis (or to the tip for non-roller operators).									





**Note:** Only operators with Nylatron rods or rollers should be used with explosion-proof limit switches.

#### Operators—Roller Type, continued

Roller Type	Minimum Required Return Torque <sup>①</sup>	Approximate Dimensions in Inches (mm)						Catalog Number
		A Lever Length <sup>②</sup>	B Roller Diameter	C Roller Width	D	E	F	
<b>E50KL532</b>								
<b>Bantam Lever</b>								
Metal	0.45 in-oz	0.69 (17.5)	0.85 (22.0)	0.18 (4.6)	—	—	—	E50KL532
								
<b>E50KL340</b>								
<b>Precision Adjustment</b>								
Nylatron	0.65 in-oz	0.69 (17.5)	0.75 (19.0)	0.32 (8.1)	0.48 (12.2)	0.24 (6.1)	0.28 (7.1)	E50KL340
Metal	1.20 in-oz	Roller length: 1.50 (38.1) <sup>③</sup>	0.75 (19.0)	0.32 (8.1)	0.48 (12.2)	0.24 (6.1)	0.28 (7.1)	E50KL465
Ball bearing	0.90 in-oz		0.69 (17.5)	0.25 (6.4)	0.48 (12.2)	0.16 (4.1)	0.22 (5.6)	E50KL535
								
<b>E50KL201</b>								
<b>Dimensions, see Page V8-T2-83.</b>								
<b>Adjustable Roller (Stainless Steel)</b>								
Ball bearing	2.50 in-oz <sup>④</sup>	1.0 (25.4) to 3.75 (95.2) <sup>⑤</sup>	0.69 (17.5)	0.25 (6.4)	0.23 (5.8)	0.30 (7.6)	—	E50KL539
Nylatron	1.90 in-oz <sup>④</sup>		0.75 (19.0)	0.32 (8.1)	0.29 (7.4)	0.33 (8.4)	—	E50KL201
			0.75 (19.0)	0.32 (8.1)	0.29 (7.4)	0.33 (8.4)	—	E50KL201SPL <sup>⑥</sup>
								
<b>E50KL537</b>								
Metal	3.40 in-oz <sup>④</sup>		0.75 (19.0)	0.32 (8.1)	0.29 (7.4)	0.33 (8.4)	—	E50KL538
Nylatron	1.90 in-oz <sup>④</sup>		0.75 (19.0)	0.50 (12.7)	0.46 (11.6)	0.48 (12.2)	—	E50KL599
Nylatron	3.10 in-oz <sup>④</sup>		0.75 (19.0)	1.00 (25.4)	0.90 (22.9)	0.95 (24.1)	—	E50KL537
Large Nylatron	4.50 in-oz <sup>④</sup>	0.5 (12.7) to 3.25 (82.6)	4.00 (102.0)	0.11 (2.8)	0.11 (2.8)	0.19 (4.8)	—	E50KL598
Without roller	1.20 in-oz <sup>④</sup>	0.5 (12.7) to 3.75 (95.2)	—	—	—	—	—	E50KL31
Nylatron	2.50 in-oz <sup>④</sup>	1.63 (41.3) to 3.75 (95.2) <sup>⑥</sup>	1.50 (38.1)	0.29 (7.4)	0.26 (6.6)	0.32 (8.1)	—	E50KL443
								

**Dimensions, see Page V8-T2-84.**

#### Operators—Fork Lever

Roller Type	Minimum Required Return Torque <sup>①</sup>	Approximate Dimensions in Inches (mm)						Catalog Number	
		A Lever Length <sup>②</sup>	B Roller Diameter	C Roller Width	D	E	F		G
<b>E50KL545</b>									
<b>Fork Lever—Both Rollers on One Side</b>									
Ball bearing	—	1.50 (38.1)	0.69 (17.5)	0.25 (6.4)	0.08 (2.0)	0.14 (3.6)	—	E50KL545	
Nylatron	—		0.75 (19.0)	0.32 (8.1)	0.16 (4.1)	0.20 (5.1)	—	E50KL204	
Metal	—		0.75 (19.0)	0.32 (8.1)	0.16 (4.1)	0.20 (5.1)	—	E50KL544	
Nylatron	—		0.75 (19.0)	1.00 (25.4)	0.84 (21.3)	0.88 (22.4)	—	E50KL543	
									
<b>E50KL542</b>									
<b>Fork Lever—One Roller Outside, One Inside</b>									
Ball bearing	—	1.50 (38.1)	0.69 (17.5)	0.25 (6.4)	0.08 (2.0)	0.14 (3.6)	0.64 (16.3)	0.70 (17.8)	E50KL542
Nylatron	—		0.75 (19.0)	0.32 (8.1)	0.16 (4.1)	0.20 (5.1)	0.73 (18.5)	0.77 (19.6)	E50KL203
Metal	—		0.75 (19.0)	0.32 (8.1)	0.16 (4.1)	0.20 (5.1)	0.73 (18.5)	0.77 (19.6)	E50KL541
									

**Dimensions, see Page V8-T2-84.**

#### Notes



- ① **Caution:** When selecting lever, the minimum required return torque of lever should not exceed minimum return force available in operating head as given in operating head specifications.
- ② Length from the operating shaft axis to the roller axis (or to the tip for non-roller operators).
- ③ Maximum length dimension between operating shaft axis to roller axis for comparison. Precision adjustable to lesser dimensions.
- ④ Applies when lever is extended to the maximum dimension.
- ⑤ By reassembling lever, minimum length can be reduced another 0.5 in (12.7 mm).
- ⑥ High-grade stainless steel.

**Rod Type Operators**





For rotary head switches: E50 Plug-In, E50 6P+, and 10316.

**Note:** Only operators with Nylatron rods or rollers should be used with explosion-proof limit switches.

**Operators—Rod Type**

Rod Type	Minimum Required Return Torque <sup>①</sup>	Approximate Dimensions in Inches (mm)			Catalog Number
		A Rod Length (Maximum) <sup>②</sup>	B Rod Diameter		
<b>Adjustable Rod</b>					
Nylon/Metal 	Nylon	0.40 in-oz <sup>③</sup>	5.50 (140.0)	0.19 (4.8)	E50KL399
	Metal	0.92 in-oz <sup>③</sup>		0.12 (3.2)	E50KL202
	Metal	2.20 in-oz <sup>③</sup>	8.75 (222.0)	Rod size (square): 0.12 (3.2) x 0.12 (3.2)	E50KL581
Metal/Steel 	Stainless steel	7.00 in-oz <sup>③</sup>	9.00 (229.0)	0.19 (4.8)	E50KL220
	Bendable steel	5.00 in-oz <sup>③</sup>	12.00 (305.0)	0.12 (3.2)	E50KL226
<b>Clamps for Adjustable Rods (Rod not included)</b>					
Clamp for ...					
0.19 (4.8) diameter rods					E50KL35
0.12 (3.2) diameter rods					E50KL36
0.25 (6.4) diameter rods					E50KL41
<b>Dimensions, see Page V8-T2-85.</b>					

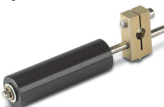
**Operators—Rod Type, continued**

Rod Type	Minimum Required Return Torque <sup>①</sup>	Approximate Dimensions in Inches (mm)				Catalog Number	
		A Rod Length <sup>②</sup>	B Rod Diameter	C	D		
<b>Spring Rod</b>							
Nylon/Steel 	Nylon	3.50 in-oz	—	—	—	E50KL556	
	Stainless steel	2.80 in-oz	—	—	—	E50KL421	
<b>Adjustable Wire</b>							
Nylon Covered Wire 	Nylon covered wire	1.50 in-oz <sup>③</sup>	—	—	—	E50KL533	
<b>Adjustable Wide Roller Lever</b>							
Nylatron 	Nylatron	4.50 in-oz <sup>③</sup>	—	—	—	E50KL37	
<b>Nylatron Loop</b>							
Nylatron 	Nylatron	0.40 in-oz	6.00 (152.0)	∅: 0.158 (4.0)	—	E50KL142	
<b>Eye Bolt</b>							
Zinc-Plated Steel 	Zinc-plated steel	0.53 in-oz	150.00 (38.1)	∅: 0.1875 (4.8) Loop ID: 0.375 (9.5)	0.52 (13.1)	0.24 (8.6)	E50KL33

**Dimensions, see Page V8-T2-85.**

**Notes**

- <sup>①</sup> **Caution:** When selecting lever, the minimum required return torque of lever should not exceed minimum return force available in operating head as given in operating head specifications.
- <sup>②</sup> Length from the operating shaft axis to tip.
- <sup>③</sup> Applies when lever is extended to the maximum dimension.



**Wobble Type Operators**

For E50DW1 and E50DWZ Operator Heads on E50 Plug-In and E50 6P+ Switches.

2

**Note:** Only operators with Nylatron rods or rollers should be used with explosion-proof limit switches.

**Operators—Wobble Type**

Wobble Type	Catalog Number
E50KW2 	Nylon Rod E50KW2
E50KW3 	Stainless Steel Rod E50KW3
E50KW4 	Coil Spring E50KW4
<b>Dimensions, see Page V8-T2-85.</b>	

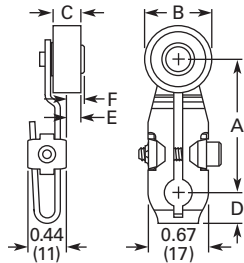
**Dimensions****Roller Type Operators****Standard Roller**

Approximate Dimensions in Inches (mm)

Catalog Number	A Lever Length <sup>①</sup>	B Roller Diameter	C Roller Width	D	E	F
E50KL39	0.88 (22.2)	0.75 (19.0)	0.32 (8.1)	0.31 (7.9)	0.20 (5.1)	0.24 (6.1)
E50KL40	1.38 (34.9)	0.75 (19.0)	0.32 (8.1)	0.34 (8.6)	0.13 (3.3)	0.17 (4.3)
E50KL531	1.50 (38.1)	0.69 (17.5)	0.25 (6.4)	0.34 (8.6)	0.05 (1.3)	0.11 (2.8)
E50KL200	1.50 (38.1)	0.75 (19.0)	0.32 (8.1)	0.34 (8.6)	0.13 (3.3)	0.17 (4.3)
E50KL355	1.50 (38.1)	0.75 (19.0)	0.32 (8.1)	0.34 (8.6)	0.13 (3.3)	0.17 (4.3)
E50KL377	1.50 (38.1)	0.75 (19.0)	1.00 (25.4)	0.34 (8.6)	0.83 (21.1)	0.83 (21.1)
E50KL32	1.50 (38.1)	—	—	0.34 (8.6)	—	—
E50KL552	2.00 (50.8)	0.69 (17.5)	0.25 (6.4)	0.34 (8.6)	0.05 (1.3)	0.11 (2.8)
E50KL546	2.00 (50.8)	0.75 (19.0)	0.32 (8.1)	0.34 (8.6)	0.13 (3.3)	0.17 (4.3)
E50KL549	2.00 (50.8)	0.75 (19.0)	0.32 (8.1)	0.34 (8.6)	0.13 (3.3)	0.17 (4.3)
E50KL572	2.00 (50.8)	0.75 (19.0)	1.00 (25.4)	0.34 (8.6)	0.83 (21.1)	0.83 (21.1)
E50KL553	2.50 (63.5)	0.69 (17.5)	0.25 (6.4)	0.34 (8.6)	0.05 (1.3)	0.11 (2.8)
E50KL547	2.50 (63.5)	0.75 (19.0)	0.32 (8.1)	0.34 (8.6)	0.13 (3.3)	0.17 (4.3)
E50KL550	2.50 (63.5)	0.75 (19.0)	0.32 (8.1)	0.34 (8.6)	0.13 (3.3)	0.17 (4.3)
E50KL573	2.50 (63.5)	0.75 (19.0)	1.00 (25.4)	0.34 (8.6)	0.83 (21.1)	0.83 (21.1)
E50KL575	2.50 (63.5)	1.50 (38.1)	0.28 (7.1)	0.34 (8.6)	0.11 (2.8)	0.17 (4.3)
E50KL554	3.00 (76.2)	0.69 (17.5)	0.25 (6.4)	0.34 (8.6)	0.05 (1.3)	0.11 (2.8)
E50KL548	3.00 (76.2)	0.75 (19.0)	0.32 (8.1)	0.34 (8.6)	0.13 (3.3)	0.17 (4.3)
E50KL551	3.00 (76.2)	0.75 (19.0)	0.32 (8.1)	0.34 (8.6)	0.13 (3.3)	0.17 (4.3)
E50KL574	3.00 (76.2)	0.75 (19.0)	1.00 (25.4)	0.34 (8.6)	0.83 (21.1)	0.83 (21.1)
E50KL576	3.00 (76.2)	1.50 (38.1)	0.28 (7.1)	0.34 (8.6)	0.11 (2.8)	0.17 (4.3)

**Note**

<sup>①</sup> Length from the operating shaft axis to the roller axis (or to the tip for non-roller operators).

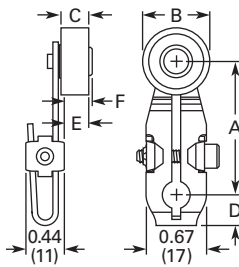

**Roller on Reverse Side**

Approximate Dimensions in Inches (mm)

Catalog Number	A Lever Length <sup>①</sup>	B Roller Diameter	C Roller Width	D	E	F
<b>E50KL580</b>	1.50 (38.1)	0.69 (17.5)	0.25 (6.4)	0.34 (8.6)	0.18 (4.6)	0.24 (6.1)
<b>E50KL310</b>	1.50 (38.1)	0.75 (19.0)	0.32 (8.1)	0.34 (8.6)	0.27 (6.9)	0.31 (7.9)
<b>E50KL579</b>	1.50 (38.1)	0.75 (19.0)	0.32 (8.1)	0.34 (8.6)	0.27 (6.9)	0.31 (7.9)
<b>E50KL536</b>	1.50 (38.1)	1.50 (38.1)	0.28 (7.1)	0.34 (8.6)	0.23 (5.8)	0.31 (7.9)

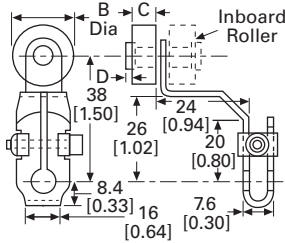

**Offset Roller**

Approximate Dimensions in mm [in]

Catalog Number	A Lever Length <sup>①</sup>	B Roller Diameter	C Roller Width	D
<b>Inboard</b>				
<b>E50KL24</b>	38.1 [1.50]	19.0 [0.75]	8.1 [0.32]	0.8 [0.03]
<b>E50KL25</b>	38.1 [1.50]	19.0 [0.75]	8.1 [0.32]	0.8 [0.03]
<b>E50KL26</b>	38.1 [1.50]	17.5 [0.69]	6.4 [0.25]	1.0 [0.04]
<b>Outboard</b>				
<b>E50KL27</b>	38.1 [1.50]	19.0 [0.75]	8.1 [0.32]	0.8 [0.03]
<b>E50KL28</b>	38.1 [1.50]	19.0 [0.75]	8.1 [0.32]	0.8 [0.03]
<b>E50KL29</b>	38.1 [1.50]	17.5 [0.69]	6.4 [0.25]	1.0 [0.04]
<b>E50KL30</b>	38.1 [1.50]	19.0 [0.75]	25.4 [1.00]	—

**Bantam Lever**

Approximate Dimensions in mm [in]

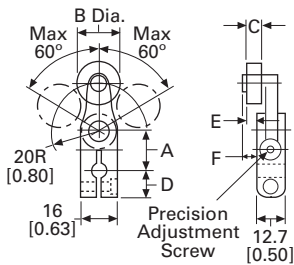
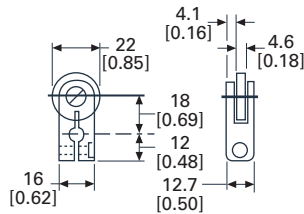

**Precision Adjustment**

Approximate Dimensions in mm [in]

Catalog Number	A Lever Length <sup>①</sup>	B Roller Diameter	C Roller Width	D	E	F
<b>E50KL340</b>	17.5 [0.69]	19.0 [0.75]	8.1 [0.32]	12.2 [0.48]	6.1 [0.24]	7.1 [0.28]
<b>E50KL465</b>	Roller length: 38.1 [1.50] <sup>②</sup>	19.0 [0.75]	8.1 [0.32]	12.2 [0.48]	6.1 [0.24]	7.1 [0.28]
<b>E50KL535</b>		17.5 [0.69]	6.4 [0.25]	12.2 [0.48]	4.1 [0.16]	5.6 [0.22]

**Notes**

- ① Length from the operating shaft axis to the roller axis (or to the tip for non-roller operators).
- ② Maximum length dimension between operating shaft axis to the roller axis for comparison. Precision adjustable to lesser dimensions.

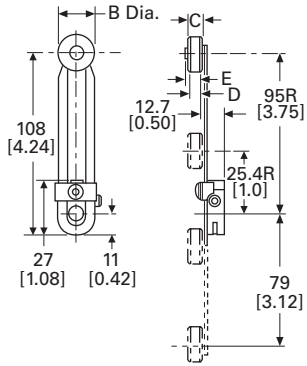

#### Adjustable Roller

Approximate Dimensions in mm [in]

Catalog Number	A Lever Length ①	B Roller Diameter	C Roller Width	D	E
E50KL539	25.4 [1.0] to 95.2 [3.75] ②	17.5 [0.69]	6.4 [0.25]	5.8 [0.23]	7.6 [0.30]
E50KL201		19.0 [0.75]	8.1 [0.32]	7.4 [0.29]	8.4 [0.33]
E50KL201SPL ③		19.0 [0.75]	8.1 [0.32]	7.4 [0.29]	8.4 [0.33]
E50KL538		19.0 [0.75]	8.1 [0.32]	7.4 [0.29]	8.4 [0.33]
E50KL599		19.0 [0.75]	12.7 [0.50]	11.6 [0.46]	12.2 [0.48]
E50KL537		19.0 [0.75]	25.4 [1.00]	22.9 [0.90]	24.1 [0.95]
E50KL598	12.7 [0.50] to 82.6 [3.25]	102.0 [4.00]	2.8 [0.11]	4.8 [0.19]	24.1 [0.95]
E50KL31	12.7 [0.50] to 95.2 [3.75]	—	—	—	—
E50KL443	41.3 [1.63] to 95.2 [3.75] ②	38.1 [1.50]	7.4 [0.29]	6.6 [0.26]	8.1 [0.32]

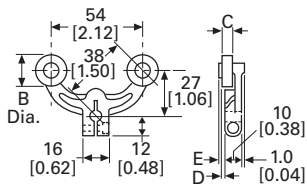

#### Fork Lever—Both Rollers on One Side

Approximate Dimensions in mm [in]

Catalog Number	A Lever Length ①	B Roller Diameter	C Roller Width	D	E
E50KL545	38.1 [1.50]	17.5 [0.69]	6.4 [0.25]	2.0 [0.08]	3.6 [0.14]
E50KL204	38.1 [1.50]	19.0 [0.75]	8.1 [0.32]	4.1 [0.16]	5.1 [0.20]
E50KL544	38.1 [1.50]	19.0 [0.75]	8.1 [0.32]	4.1 [0.16]	5.1 [0.20]
E50KL543	38.1 [1.50]	19.0 [0.75]	25.4 [1.00]	21.3 [0.84]	22.4 [0.88]

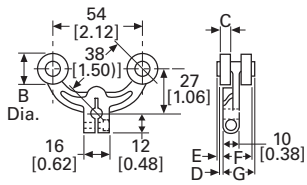

#### Fork Lever—One Roller Outside, One Inside

Approximate Dimensions in mm [in]

Catalog Number	A Lever Length ①	B Roller Diameter	C Roller Width	D	E	F	G
E50KL542	38.1 [1.50]	17.5 [0.69]	6.4 [0.25]	2.0 [0.08]	3.6 [0.14]	16.3 [0.64]	17.8 [0.70]
E50KL203	38.1 [1.50]	19.0 [0.75]	8.1 [0.32]	4.1 [0.16]	5.1 [0.20]	18.5 [0.73]	19.6 [0.77]
E50KL541	38.1 [1.50]	19.0 [0.75]	8.1 [0.32]	4.1 [0.16]	5.1 [0.20]	18.5 [0.73]	19.6 [0.77]

#### Rod Type Operators

Approximate Dimensions in Inches or mm [in]

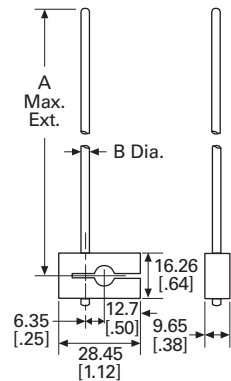

#### Adjustable Rod

Catalog Number	A Rod Length ①	B Rod Diameter
E50KL399	140.0 [5.50]	4.8 [0.19]
E50KL202		3.2 [0.12]
E50KL581	222.0 [8.75]	Rod size (square): 3.2 [0.12] x 3.2 [0.12]
E50KL220	229.0 [9.00]	4.8 [0.19]
E50KL226	305.0 [12.00]	3.2 [0.12]

#### Notes

- ① Length from the operating shaft axis to the roller axis (or to the tip for non-roller operators).
- ② By reassembling lever, minimum length can be reduced another 12.7 mm [0.5 in].
- ③ High-grade stainless steel.

**Rod Type Operators, continued**

Approximate Dimensions in Inches or mm [in]

**Spring Rod—E50KL556**

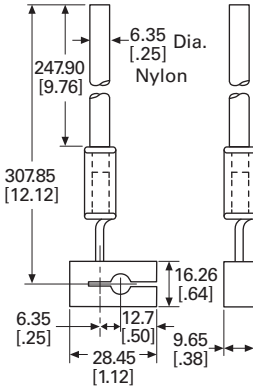

**Adjustable Wire**

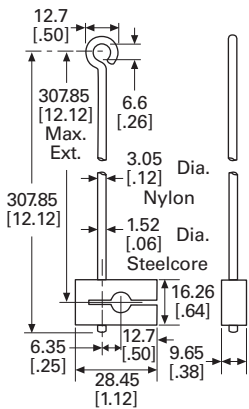

**Eye Bolt**

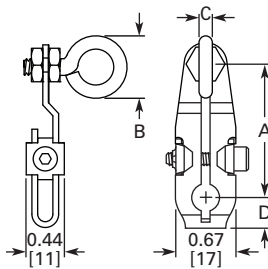

Catalog Number	A Rod Length ②	B Rod Diameter	C Rod Width	D
E50KL33	38.1 [1.50]	4.8 [0.1875] Loop ID: 9.5 [0.375]	13.1 [0.52]	8.6 [0.34]

**Spring Rod—E50KL421**

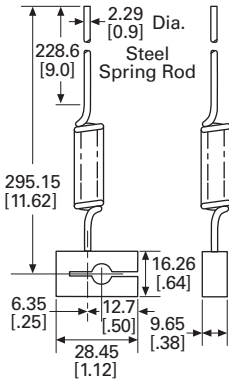

**Adjustable Wide Roller Lever**

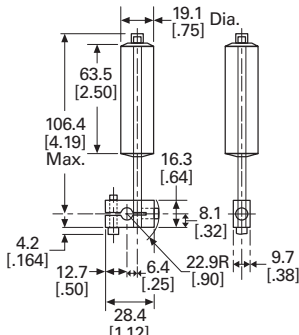

**Wobble Type Operators**

**Nylon Rod**

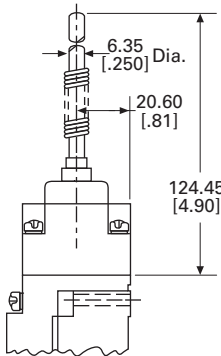

**Coil Spring**

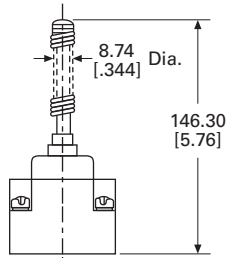

**Nylatron Loop—E50KL142**

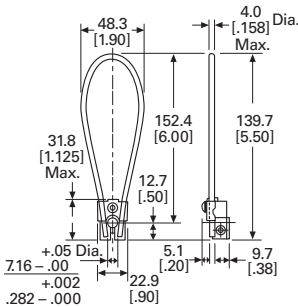

**Nylatron Loop—E50KL142**

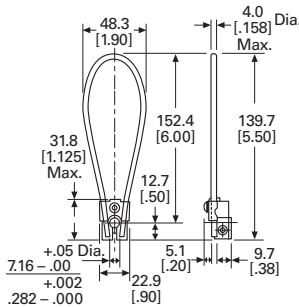

**Stainless Steel Rod**

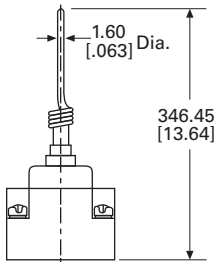

**Notes**

- ① Applies when lever is extended to the maximum dimension.
- ② Length from the operating shaft axis to tip.

#### Non Plug-In Switches

2



### Non Plug-In Switches

#### Product Description

10316 Type L non plug-in limit switches by Eaton's electrical sector are sold as completely assembled devices only, with a wide array of operating head configurations. All switches are single-pole 1NO-1NC.

#### Features

- Side and top rotary, side and top push or wobble operation
- CW, CCW or CW and CCW operating modes are field convertible
- Double break-make snap action contacts, same polarity each pole
- Captive saddle clamp terminals accept up to #12 wire
- Head can be mounted in any of four discrete positions, intervals of 90°

### Contents

#### Description

	<i>Page</i>
Non Plug-In Switches	
Product Selection .....	<b>V8-T2-87</b>
Technical Data and Specifications .....	<b>V8-T2-88</b>
Dimensions .....	<b>V8-T2-88</b>

#### Standards and Certifications

- UL Listed, E170645
- CSA Certified, 50513



#### **⚠ DANGER**



**THIS SENSOR IS NOT A SAFETY DEVICE AND IS NOT INTENDED TO BE USED AS A SAFETY DEVICE. This sensor is designed only to detect and read certain data in an electronic manner and perform no use apart from that, specifically no safety-related use. This sensor product does not include self-checking redundant circuitry, and the failure of this sensor product could cause either an energized or de-energized output condition, which could result in death, serious bodily injury, or property damage.**

For the most current information on this product, visit our Web site: [www.eaton.com](http://www.eaton.com)

For Customer Service in the U.S. call 1-877-ETN CARE (386-2273), in Canada call 1-800-268-3578. For Application Assistance in the U.S. and Canada call 1-800-426-9184.

## Product Selection

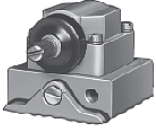
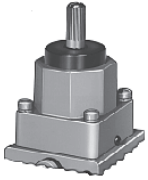
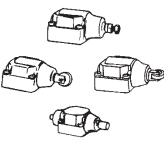
## Complete Assembled Switches Single-Pole 1NO-1NC

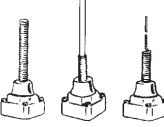
Operating Characteristics	Operating Data—Nominal			Force to Operate Contacts	Minimum Return Force	Catalog Number	
	Travel to Operate Contacts	Travel to Reset Contacts	Total Travel				
<b>Side Rotary Operated</b>	<b>Side Rotary Operated</b> ①						
	Standard	10°	4°	50°	3 in-lbs	4.5 in-oz	<b>10316H187</b>
<b>Top Rotary Operated</b>	<b>Top Rotary Operated</b> ①						
	Clockwise	20°	12°	140°	1.1 in-lbs	3 in-oz	<b>10316H700</b>
	Counterclockwise	20°	12°	140°	1.1 in-lbs	3 in-oz	<b>10316H701</b>
<b>Side Push Operated</b>	<b>Side Push Operated</b>						
	Adjustable pushbutton	0.07 in (1.8 mm)	0.03 in (0.8 mm)	0.29 in (7.4 mm)	4 lbs	8 oz	<b>10316H621</b>
	Vertical roller— 0.44 in (11.2 mm) dia.	0.07 in (1.8 mm)	0.03 in (0.8 mm)	0.29 in (7.4 mm)	4 lbs	8 oz	<b>10316H284</b>
	Horizontal roller— 0.44 in (11.2 mm) dia.	0.07 in (1.8 mm)	0.03 in (0.8 mm)	0.29 in (7.4 mm)	4 lbs	8 oz	<b>10316H285</b>
<b>Top Push Operated</b>	<b>Top Push Operated</b>						
	Pushbutton	0.04 in (1.0 mm)	0.02 in (0.5 mm)	0.28 in (7.1 mm)	4 lbs	8 oz	<b>10316H281</b>
	Roller—0.44 in (11.2 mm) dia.	0.04 in (1.0 mm)	0.02 in (0.5 mm)	0.28 in (7.1 mm)	4 lbs	8 oz	<b>10316H283</b>
	Roller—0.75 in (19.1 mm) dia.	0.04 in (1.0 mm)	0.02 in (0.5 mm)	0.28 in (7.1 mm)	4 lbs	8 oz	<b>10316H577</b>
<b>Wobble Operated</b>	<b>Wobble Operated</b> ②						
	Spring	10°	6°	15°	1 in-lb	2.4 in-oz	<b>10316H299</b>
	Nylon rod	10°	6°	15°	2 in-lbs	2.4 in-oz	<b>10316H296</b>
	Wire	10°	6°	15°	2 in-lbs	2.4 in-oz	<b>10316H484</b>
	Cat whisker	15°	5°	30°	0.63 in-lb	1.7 in-oz	<b>10316H341</b>

**Notes**① For operating levers, see **Page V8-T2-78**.② For wobble operators, see **Page V8-T2-78**.



#### Technical Data and Specifications

#### Non Plug-In Switches

Description	Specification
Contact rating	NEMA A600, R300 double break-make snap action contacts
Electrical life	500,000 operations minimum
Mechanical life	5,000,000 operations minimum at full load
Conduit entrance	0.5 in (12.7 mm) NPT
Material of construction	Zinc die cast
Enclosure rating	NEMA 1, 4, 13
Ambient operating temperature	-20° to 200°F (-29° to 93°C) ①
Approximate shipping weight	2 lbs

#### Electrical Data—Maximum Contact Ratings per Pole ②

AC Volts	Current, Amperes		Cont. Thermal Ratings	Volts, Amperes		DC Volts	DC Current, Ampere
	Make	Break		Make	Break		
NEMA A600, R300 Rating							
120	60	6	10	7200	720	125	0.22
240	30	3	10	7200	720	250	0.11
480	15	1.5	10	7200	720	250	0.11
600	12	1.2	10	7200	720	250	0.11

#### Dimensions

Approximate Dimensions in Inches or Inches (mm)

#### Side Rotary Operated Head with Switch

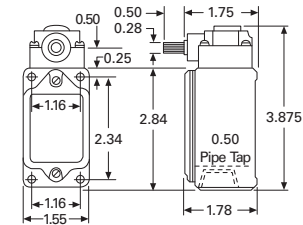

(2) 0.203 Dia. Holes for Front Mtg.  
(2) 10-32 Tapped Holes 0.375 Deep for Rear Mtg.

#### Side Pushbutton, Adjustable

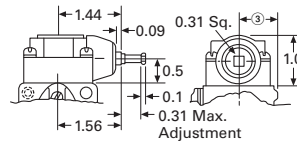

#### Top Pushbutton

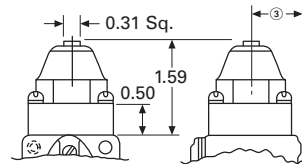

#### Side Push, Vertical Roller

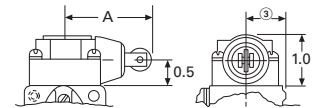

#### Dimension "A"

With 0.44 (11.2) dia. roller	1.78 (45.2)
With 0.75 (19.1) dia. roller	2.09 (53.1)

#### Side Push Maintained Contact

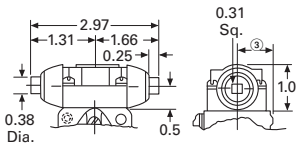

#### Top Push Roller

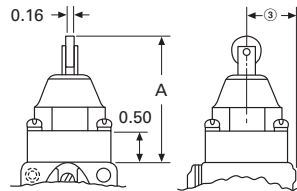

#### Dimension "A"

With 0.44 (11.2) dia. roller	2.03 (51.6)
With 0.75 (19.1) dia. roller	2.34 (59.4)

#### Wobble Operators

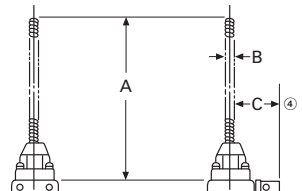

A	B	C
<b>Wobble Spring</b>		
5.44 (138.2)	0.31 (7.9)	0.81 (20.6)
<b>Wire Wobble Stick</b>		
12.5 (317.5)	0.08 (2.0)	0.81 (20.6)
<b>Nylon Wobble Stick</b>		
4.5 (114.3)	0.25 (6.4)	0.81 (20.6)

#### Notes

- ① Ranges below 32°F (0°C) are based on absence of freezing moisture or water.
- ② Contacts must be same polarity when both circuits are used.
- ③ Dimension from centerline of head to mounting surface is 0.78 in (20 mm).
- ④ Center to mounting surface.

Hazardous Location Limit Switches



Contents

<i>Description</i>	<i>Page</i>
Hazardous Location Limit Switches	
Product Selection . . . . .	<b>V8-T2-90</b>
Technical Data and Specifications . . . . .	<b>V8-T2-91</b>
Dimensions . . . . .	<b>V8-T2-88</b>

Hazardous Location Limit Switches

Product Description

Type LX, CX and CBX limit switches by Eaton’s electrical sector are designed for extreme environmental service in NEMA 7–9 locations where the danger of an internal or external explosion of flammable gases, vapors, metal alloy or grain dust exists. Type CB provides excellent corrosion resistant properties in NEMA 4X applications. Markets served include mining, grain storage, forest products, petrochemical, pharmaceutical and waste and sewage management.

Features

- Sealed and unsealed versions available
- One-way gasket on sealed version keeps liquids out, yet allows a harmless release of gases in the event of an internal explosion
- Silicon bronze housing provides excellent corrosion resistant properties in extreme NEMA 4X applications
- Temperature buildup on limit switch surface is dissipated by housing design and materials used
- Utilizes the operating heads and internal switch mechanisms of the 10316 L non plug-in line

Standards and Certifications

- UL Listed, E170645, E183975
- UL tested to Canadian safety standards



**⚠ DANGER**

**THIS SENSOR IS NOT A SAFETY DEVICE AND IS NOT INTENDED TO BE USED AS A SAFETY DEVICE. This sensor is designed only to detect and read certain data in an electronic manner and perform no use apart from that, specifically no safety-related use. This sensor product does not include self-checking redundant circuitry, and the failure of this sensor product could cause either an energized or de-energized output condition, which could result in death, serious bodily injury, or property damage.**

NEMA Ratings Comparison

Switch Type	LX	CX	CBX	CB ①
<b>NEMA 1, 4, 13</b>	—	✓	✓	✓
<b>NEMA 4X</b>	—	—	✓	✓
<b>NEMA 7 Division I, Class I, BCD</b>	✓	✓	✓	—
<b>NEMA 9 Division I, Class II, EFG</b>	✓	✓	✓	—

Note

① Not rated for explosive locations.

For the most current information on this product, visit our Web site: [www.eaton.com](http://www.eaton.com)

For Customer Service in the U.S. call 1-877-ETN CARE (386-2273), in Canada call 1-800-268-3578. For Application Assistance in the U.S. and Canada call 1-800-426-9184.

## Product Selection

2

Complete Assembled Switches with Spring Return Heads <sup>①</sup>

## Operating Data—Nominal

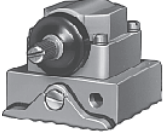
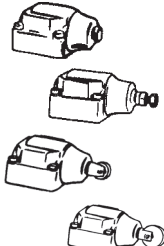
Head Type	Travel to Operate Contacts	Travel to Reset Contacts	Total Travel	Force to Operate Contacts	Minimum Return Force	Body Type	Contacts	Catalog Number	
<b>Side Rotary Operated</b> <sup>②</sup> 	<b>Standard, 10° Pre-Travel</b> <sup>③</sup>								
	10°	4°	50°	3.0 in-lbs	4.5 in-oz	Type LX	1NO-1NC <sup>④</sup>	<b>10316H1002</b>	
							2NO	<b>10316H1039</b>	
							1NO and 1NC <sup>④</sup>	<b>10316H1049</b>	
							2NC	<b>10316H1059</b>	
						Type CX	1NO-1NC <sup>④</sup>	<b>10316H2200</b>	
							1NO and 1NC <sup>④</sup>	<b>10316H2176</b>	
							2NC	<b>10316H2178</b>	
						Type CB	1NO-1NC <sup>④</sup>	<b>10316H2149</b>	
							2NC	<b>10316H2140</b>	
						Type CBX	1NO-1NC <sup>④</sup>	<b>10316H2168</b>	
							2NC	<b>10316H2159</b>	
		<b>Narrow Differential 5° Pre-Travel</b> <sup>③</sup>							
	5°	2°	50°	6.0 in-lbs	4.5 in-oz	Type LX	1NO-1NC <sup>④</sup>	<b>10316H1146</b>	
						Type CX	1NO-1NC <sup>④</sup>	<b>10316H2197</b>	
	<b>Neutral Position, 18° Pre-Travel</b> <sup>⑤</sup>								
18°	6°	50°	1.8 in-lbs	2.5 in-oz	Type LX	2NO	<b>10316H1071</b>		
						2NC	<b>10316H1072</b>		
					Type CX	2NO	<b>10316H2179</b>		
					Type CBX	2NC	<b>10316H2160</b>		
<b>Side Push Operated</b> 	<b>Pushbutton</b>								
	0.07 in (1.8 mm)	0.03 in (0.76 mm)	0.29 in (7.4 mm)	4 lbs	8 oz	Type LX	1NO and 1NC <sup>④</sup>	<b>10316H1213</b>	
	<b>Adjustable Pushbutton</b>								
	0.07 in (1.8 mm)	0.03 in (0.76 mm)	0.29 in (7.4 mm)	4 lbs	8 oz	Type LX	1NO-1NC <sup>④</sup>	<b>10316H1192</b>	
	<b>Vertical Roller, 0.44 in (11.2 mm) Diameter</b>								
	0.07 in (1.8 mm)	0.03 in (0.76 mm)	0.29 in (7.4 mm)	4 lbs	8 oz	Type LX	1NO-1NC <sup>④</sup>	<b>10316H1007</b>	
	<b>Vertical Roller, 0.75 in (19.1 mm) Diameter</b>								
0.07 in (1.8 mm)	0.03 in (0.76 mm)	0.29 in (7.4 mm)	4 lbs	8 oz	Type LX	1NO-1NC <sup>④</sup>	<b>10316H1194</b>		

**Notes**

- ① Contact Eaton's Sensor Applications Engineering at 1-800-426-9184 for replacement contact blocks.
- ② For operating levers, see **Page V8-T2-78**. Only levers with Nylatron rods or rollers should be used with explosion-proof limit switches.
- ③ Field convertible to clockwise only or counterclockwise only operation.
- ④ 1NO-1NC contacts must be same polarity when both circuits are used—1NO and 1NC contacts have isolated poles and may be used on opposite polarity.
- ⑤ Neutral position switches operate one circuit in each direction.

Complete Assembled Switches with Spring Return Heads, continued <sup>①</sup>

## Operating Data—Nominal

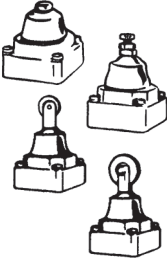
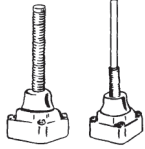
Head Type	Travel to Operate Contacts	Travel to Reset Contacts	Total Travel	Force to Operate Contacts	Minimum Return Force	Body Type	Contacts	Catalog Number
<b>Top Push Operated</b> 	<b>Pushbutton</b>							
	0.04 in (1 mm)	0.02 in (0.5 mm)	0.28 in (7.1 mm)	4 lbs	8 oz	Type LX	1NO-1NC <sup>②</sup>	<b>10316H1004</b>
						Type CX	1NO and 1NC <sup>②</sup>	<b>10316H2188</b>
	<b>Adjustable Pushbutton</b>							
	0.04 in (1 mm)	0.02 in (0.5 mm)	0.28 in (7.1 mm)	4 lbs	8 oz	Type LX	1NO-1NC <sup>②</sup>	<b>10316H1191</b>
							1NO and 1NC <sup>②</sup>	<b>10316H1212</b>
	<b>Roller, 0.44 in (11.2 mm) Diameter</b>							
	0.04 in (1 mm)	0.02 in (0.5 mm)	0.28 in (7.1 mm)	4 lbs	8 oz	Type LX	1NO-1NC <sup>②</sup>	<b>10316H1006</b>
						Type CBX	1NO-1NC <sup>②</sup>	<b>10316H2170</b>
	<b>Roller, 0.75 in (19.1 mm) Diameter</b>							
0.04 in (1 mm)	0.02 in (0.5 mm)	0.28 in (7.1 mm)	4 lbs	8 oz	Type LX	1NO-1NC <sup>②</sup>	<b>10316H1193</b>	
<b>Wobble Operated</b> 	<b>Spring</b>							
	10° <sup>③</sup>	6°	15°	1 in-lb	2.4 in-oz	Type LX	1NO-1NC <sup>②</sup>	<b>10316H1237</b>
	<b>Nylon Rod</b>							
	10° <sup>③</sup>	6°	15°	2 in-lbs	5.6 in-oz	Type LX	1NO-1NC <sup>②</sup>	<b>10316H1009</b>

## Technical Data and Specifications

## Hazardous Location Limit Switches

Description	Specification
Material of construction	
LX, CX	Cast aluminum die cast
CB, CBX	Silicon bronze
Conduit entrance	
LX	1/2 in pipe tap
CB, CBX, CX	3/4 in pipe tap
Mounting	Surface mount
Enclosure rating	
LX, CX, CBX	NEMA 7 Div. 1, Class I BCD; NEMA 9 Div. 1, Class II, EFG <sup>④</sup>
CB, CBX	NEMA 1, 4, 4X, 13 <sup>④</sup>
CX	NEMA 1, 4, 13 <sup>④</sup>
Ambient operating temperature	-20° to 200°F (-29° to 93°C) <sup>⑤</sup>
Approximate shipping weight	
LX	2 lbs
CX	2.5 lbs
CB, CBX	6 lbs

## Notes

- ① Contact Eaton's Sensor Applications Engineering at 1-800-426-9184 for replacement contact blocks.  
 ② 1NO-1NC contacts must be same polarity when both circuits are used—1NO and 1NC contacts have isolated poles and may be used on opposite polarity.  
 ③ Travel with force applied at one-in (25.4 mm) radius. Applied at end of operator, travel is approximately 14.  
 ④ A conduit seal-off kit is required for these switches  
 ⑤ Ranges below 32°F (0°C) are based on absence of freezing moisture or water.

# 2.10

## Limit Switches

### Hazardous Location Limit Switches

2

#### Electrical Data—Maximum Contact Ratings, per Pole

AC Volts	Current, Amperes		Cont. ①	Volt Amperes		DC Volts	DC Current, Ampere
	Make	Break		Make	Break		
<b>1NO-1NC Switches</b>							
NEMA A600, R300 rating							
120	60	6	10	7200	720	125	0.2
240	30	3	10	7200	720	250	0.1
480	15	1.5	10	7200	720	250	0.1
600	12	1.2	10	7200	720	250	0.1
<b>All Other Switches, B600</b>							
120	30	3	5	3600	360	120	0.1
240	15	1.5	5	3600	360	240	0.05
480	7.5	0.75	5	3600	360	240	0.05
600	6	0.60	5	3600	360	240	0.05

#### Dimensions

Approximate Dimensions in Inches or Inches (mm)

#### Type LX Switch with Side Rotary Head

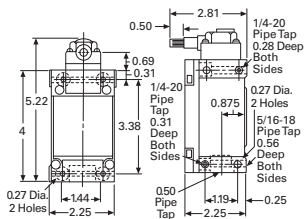

#### Side Pushbutton Head

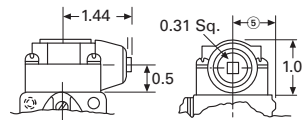

#### Top Pushbutton Head

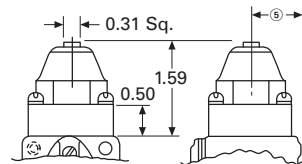

#### Side Push, Vertical Roller Head

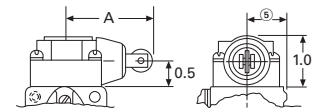

#### Dimension "A"

With 0.44 (11.2) dia. roller	1.78 (45.2)
With 0.75 (19.1) dia. roller	2.09 (53.1)

#### Type CX, CB and CBX Switches with Side Rotary Head

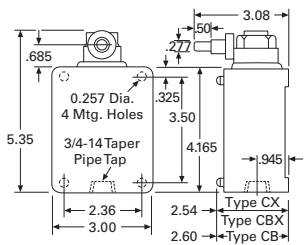

#### Adjustable Top Pushbutton Head

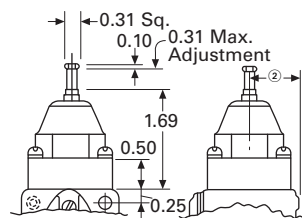

#### Wobble Operators

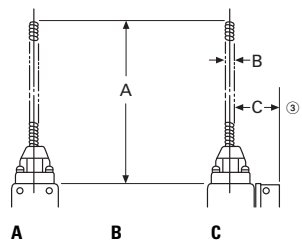

#### Wobble Spring

5.44 (138.2)	0.31 (7.9)	0.94 (23.9)
--------------	------------	-------------

#### Nylon Red

4.5 (114.3)	0.25 (6.4)	0.94 (23.9)
-------------	------------	-------------

#### Notes

- 1NO-1NC contacts must be same polarity when both circuits are used—1NO and 1NC contacts have isolated poles and may be used on opposite polarities.
- Dimension from centerline of head to mounting surface is 0.78 in (20 mm).
- Center to mounting surface.

#### Adjustable Side Pushbutton Head

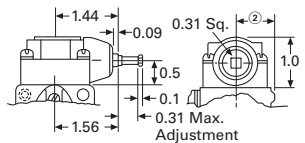

#### Top Push Roller Head

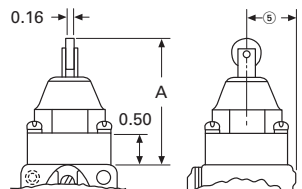

#### Dimension "A"

With 0.44 (11.2) dia. roller	2.03 (51.6)
With 0.75 (19.1) dia. roller	2.34 (59.4)

Special Purpose Limit Switches

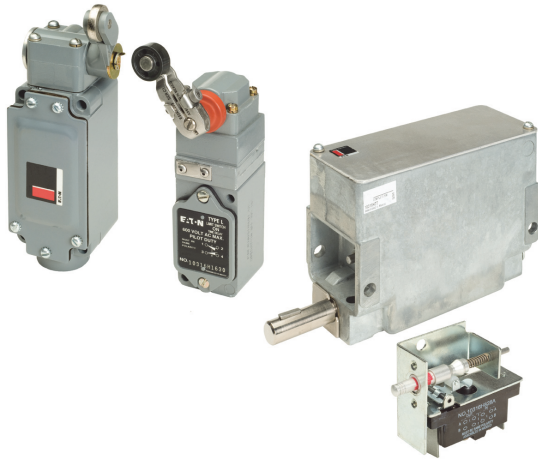

Contents

<i>Description</i>	<i>Page</i>
Special Purpose Limit Switches	
Product Selection	
Roller Lever Switches . . . . .	<b>V8-T2-94</b>
Rotating Shaft Switches . . . . .	<b>V8-T2-94</b>
Pneumatic Time Delay Switches . . . . .	<b>V8-T2-95</b>
Precision Switches . . . . .	<b>V8-T2-95</b>
Technical Data and Specifications . . . . .	<b>V8-T2-96</b>
Dimensions . . . . .	<b>V8-T2-97</b>

Special Purpose Limit Switches

Product Description

Special Purpose (Type F), Rotating Shaft (Type J), Pneumatic Time Delay (Type LP) and Precision and Cabinet Door Interlock (Type PS) Limit Switches from Eaton's electrical sector serve a variety of special purpose industrial applications for MRO and User Replacement requirements.

Features

- UL Listed
- CSA Certified (PS and J only)

Standards and Certifications

Type J

- UL Listed, E170645
- CSA Certified, 50513



Type LP

- UL Listed, E170645



Type PS

- UL Listed, E170645
- CSA Certified, 50513



**⚠ DANGER**

**THIS SENSOR IS NOT A SAFETY DEVICE AND IS NOT INTENDED TO BE USED AS A SAFETY DEVICE. This sensor is designed only to detect and read certain data in an electronic manner and perform no use apart from that, specifically no safety-related use. This sensor product does not include self-checking redundant circuitry, and the failure of this sensor product could cause either an energized or de-energized output condition, which could result in death, serious bodily injury, or property damage.**

For the most current information on this product, visit our Web site: [www.eaton.com](http://www.eaton.com)

For Customer Service in the U.S. call 1-877-ETN CARE (386-2273), in Canada call 1-800-268-3578. For Application Assistance in the U.S. and Canada call 1-800-426-9184.

#### Product Selection

#### Roller Lever Switches

2

##### Roller Lever



#### Type F Switches <sup>①</sup>

Operator	Circuit	Travel to Operate Contacts	Travel to Reset Contacts	Total Travel	Over-Travel	Catalog Number
Roller lever (CW and CCW operation, spring return)	1NO-1NC	40°	35°	65°	25°	<b>10316H18</b>
	2NO-2NC	17°	6°	60°	43°	<b>10316H320</b>

#### Rotating Shaft Switches

##### Type J

Rotating Shaft Limit Switches allow the shaft to be rotated a preset number of revolutions (adjustable from 1/2 to 100 with an accuracy of 1/20 of a turn) before the contacts will switch. A second set of

contacts will trip when reaching a preset limit in the opposite direction. These switches are typically used in crane and hoist applications to provide end of travel stops for the hook assembly.

##### Rotating Shaft

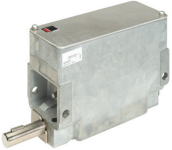

#### Type J Switches

Shaft to Cam Ratio	Max. Turns to Trip Contacts	Min. Turns to Trip Contacts	Over-Travel Before Resetting Contacts	Reversal After Tripping to Reset Contacts	Circuit <sup>②</sup>	Enclosure Rating	Catalog Number
103:1	100 input shaft turns	1/2 input shaft turns	103 input shaft turns max.	1/8 input shaft turns min.	2NC	NEMA 1	<b>10316H50</b>
					2NO-2NC <sup>③</sup>	NEMA 4	<b>10316H54 <sup>③</sup></b>

#### Notes

- ① Replacement operator head is available with part number **86-862-22**.  
Replacement roller lever is available with part number **24-1712**.  
Replacement key pin and washer for roller is available with part number **16-906**.
- ② For replacement NO contacts, order **17-1403**; NC contacts, order **17-702**.
- ③ 10316H54 has factory set circuits, but is easily convertible to any of three circuits (2NO-2NC, 4NO or 4NC). Full instructions enclosed with every switch.

**Pneumatic Time Delay Switches****Pneumatic Time Delay****Type LP Switches**

Operator	Total Travel	Pre-Travel	Circuit	Timed Contacts	Direction of Rotation <sup>②</sup>	Catalog Number
Side rotary (Spring return to center) <sup>①</sup>	50°	10°	1NO-1NC	ON delay	CW	10316H1580
					CW and CCW	10316H1600
				OFF delay	CW	10316H1610
					CW and CCW	10316H1630

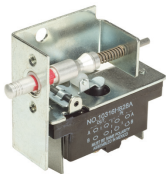
**Precision Switches****Cabinet Door Interlock****Type PS Switches**

Operator	Circuits— SPDT 1NO-1NC Catalog Number	Circuits— DPDT 2NO-2NC Catalog Number	Operator Only Catalog Number
<b>Precision Switch Devices</b>			
Precision switch only	10316H89	10316H2000	—
Pushbutton with oiltight plunger	—	10316H2006	—
Roller with oiltight plunger perpendicular to mounting holes	—	10316H2012	—
Roller with oiltight plunger in line with mounting holes	10316H110	—	—
6 in lever with top and right-hand mounting bracket	10316H113	—	10316H143
6 in lever with top and left-hand mounting bracket	—	—	10316H144
Roller lever with top and right-hand mounting bracket	10316H119	—	10316H145
Roller lever with top and left-hand mounting bracket	10316H122	—	10316H146
One way roller lever with top and right-hand mounting bracket	—	—	10316H147
One way roller lever with top and left-hand mounting bracket	—	—	10316H148
<b>Cabinet Door Interlocks</b>			
Precision switch only	10316H828	10316H829A	—
Cabinet door interlock operator with one precision switch and with red (defeated <sup>③</sup> ) indicator	10316H1028	10316H2042	10316H150
Cabinet door interlock operator with two each of listed precision switches and with red (defeated <sup>③</sup> ) indicator	10316H1029	—	—

**Notes**

- ① Requires an operating lever, see **Page V8-T2-78**.  
 ② Field convertible.  
 ③ The plunger exposes a red band when pulled out to indicate that interlock is defeated.



## Technical Data and Specifications

2

### Special Purpose Limit Switches

Description	Specification
<b>Roller Lever Switches – Type F</b>	
Enclosure rating	NEMA 4
Operating temperature	0° to 180°F (–18° to 82°C)
Conduit entrance	0.5 in NPT
Shipping weight	4.0 lbs
<b>Rotating Shaft Switches – Type J</b>	
Shipping weight	
NEMA 1 models	5.5 lbs
NEMA 4 models	13 lbs
<b>Pneumatic Time Delay Switches – Type LP</b>	
Timing range	0.05 to 60 seconds
ON delay function	Timing begins when lever is actuated and held
OFF delay function	Timing begins when lever is released
Repeat accuracy <sup>①</sup>	With 15 second or higher interval between timing periods: ±10% of setting maximum With less than 15 second interval between timing periods: ±25% of setting maximum
Operating frequency	250 operations per minute maximum
Enclosure rating	NEMA 4, 13
Ambient operating temperature	32° to 150°F (0° to 65°C)
Conduit entrance	0.5 in NPT
Shipping weight	2 lbs

#### Type F—Maximum Ampere Ratings

Circuit	State	AC Volts				DC Volts		
		120	240	480	600	120	240	600
1NO-1NC	Make	60	30	20	15	—	—	—
	Break	6	3	1.5	1.2	2.2	1.1	0.40
2NO-2NC	Make	40	20	10	8	—	—	—
	Break	15	10	6	5	0.5	0.2	0.02

#### Type J—Maximum Ampere Ratings

State	AC Volts				DC Volts		
	120	240	480	600	120	240	600
Make	60	30	15	12	2.2	1.1	—
Break	6	3	1.5	1.2	2.2	1.1	—
Continuous <sup>①</sup>	10	10	10	10	10	10	—

#### Note

<sup>①</sup> To maintain operating accuracy during the timing cycle, the switch lever must be faster than the timed setting.

**Type LP— Electrical Data, Maximum Contact Ratings/Pole**

AC Volts	Current, Amperes			Volt Amperes		DC Volts	DC Current Amperes
	Make	Break	Cont. ①	Make	Break		
<b>All Switches 1NO-1NC</b>							
NEMA A600, R300 Rating							
120	60	6	10	7200	720	120	0.2
240	30	3	10	7200	720	240	0.1
480	15	1.5	10	7200	720	240	0.1
600	12	1.2	10	7200	720	240	0.1

**Type PS— Maximum Ampere Ratings**

Type	State	AC Volts				DC Volts Double Throw		
		120	240	480	600	120	240	600
<b>Heavy-Duty 1/2 hp, 250 Vac Maximum</b>								
Single-pole	Make	40	20	10	8	2.0	0.5	0.1
	Break	15	10	6	5	0.5	0.2	0.02
Double-pole	Make	30	15	8	6	0.5	0.2	0.2
	Break	3	1.5	1	0.8	0.2	0.1	—

**Dimensions**

Approximate Dimensions in Inches (mm)

**Roller Lever Switches**

**Type F**

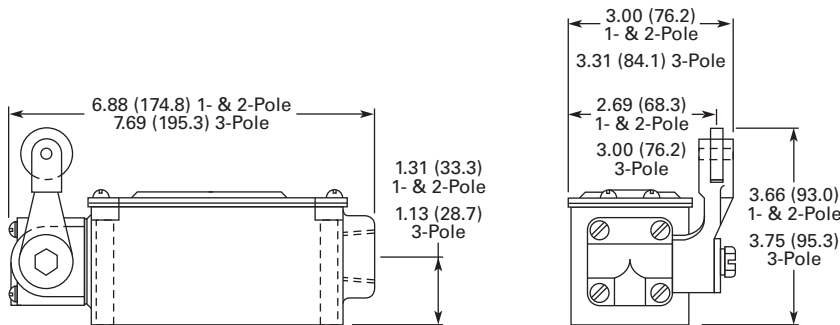

**Note**

① Thermal rating. Valid only if switch does not have to make or break.

# 2.11

## Limit Switches

### Special Purpose Limit Switches

Approximate Dimensions in Inches only

#### Rotating Shaft Switches

2

##### Type J—NEMA 1 Models

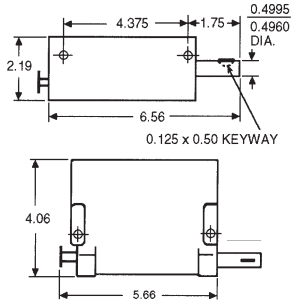

##### Type J—NEMA 4 Models

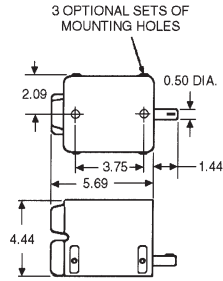

#### Pneumatic Time Delay Switches

##### Type LP

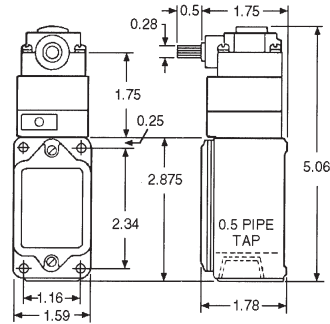

#### Precision Switches

##### Type PS

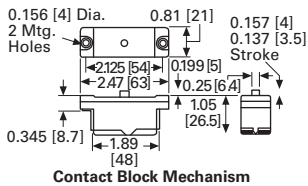

Contact Block Mechanism

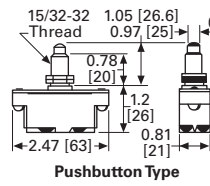

Pushbutton Type

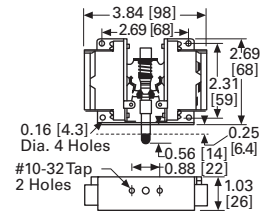

Cabinet Door Type  
Two Contact Blocks

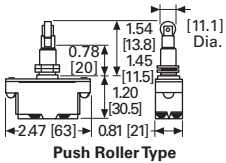

Push Roller Type

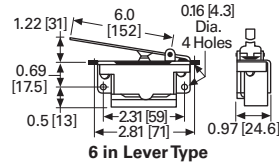

6 in Lever Type

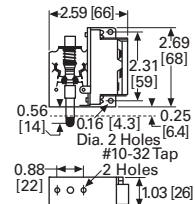

Cabinet Door Type  
One Contact Block

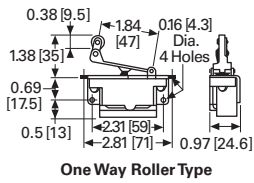

One Way Roller Type

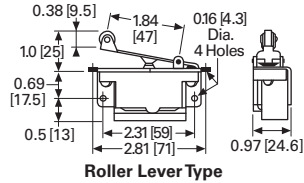

Roller Lever Type